



S R

HARVARD UNIVERSITY.



LIBRARY

OF THE

MUSEUM OF COMPARATIVE ZOOLOGY

55,773

BEQUEST OF

WILLIAM BREWSTER

December 4, 1920.









# RECREATION

A MONTHLY MAGAZINE DEVOTED TO EVERYTHING  
THE NAME IMPLIES



VOLUME VII.  
JULY, 1897, TO DECEMBER, 1897



G. O. SHIELDS (Coquina), Editor and Manager



NEW YORK  
19 WEST TWENTY-FOURTH STREET  
1897

Y B A R R E L L  
Y F O U R T H S T R E E T  
C O L L E G I A T E

COPYRIGHT, 1897, BY G. O. SHIELDS

TROW DIRECTORY  
PRINTING AND BOOKBINDING COMPANY  
NEW YORK

9633  
17



## INDEX TO VOLUME VII.



	PAGE
“With One Long, Silent Stroke She Glided into Mid-Stream.” Frontispiece.....	HARRY WATSON
Pocahontas in England. Illustrated.....	J. C. 3
How the Big Ram Was Killed. Illustrated.....	F. W. S. 10
My Twenty-two Point Buck. Illustrated.....	F. D. HULBURT 12
The First Day of the Chicken Season.....	A. B. COWIE 15
Goose Shooting in Colorado. Illustrated.....	W. E. KING 19
A Good Indian. Illustrated.....	NELSON YARNALL 20
“A Fishing Story.” (Poem.) Illustrated.....	CAPT. H. P. BECKWITH 22
The Rented Bicycle Suit. Illustrated.....	WALTER I. SHAY 23
My Last Hunt in Kansas. Illustrated.....	GEN. F. W. BENTEEN 27
The Cowboy’s Version of the Prodigal Son.....	PONY BILL 31
“Spring.” (Poem).....	W. T. JONES 32
Only a Dog.....	A. W. DIMOCK 33
Hoover’s Ranch.....	JAS. HANKS 34
Trouting on the Thunder.....	A. D. CURTIS 35
Mark East!.....	S. T. EARNS 37
“Piscatory Evolution.” (Poem.) Illustrated.....	FRANK E. PAGE 38
A Hard Ride in the Mountains.....	J. G. T. 39
Rabbit Shooting in Kansas.....	A. W. BITTING 40
Some Old Guns. Illustrated.....	CAPT. PHILIP READE, U.S.A. 41
“He had White’s Right Arm in his Capacious Mouth.” Frontispiece.....	BERT CASSIDY
A Bad Grizzly.....	GEORGE W. KELLOGG 87
The Confessions of Lynx Canadensis. Illustrated.....	W. E. CARLIN 89
“Oh Mother, Take the Wheel Away”.....	OLD SONG 93
Our Alaskan Exploring Expedition. Up the Stickeen. Illustrated.....	A. J. STONE 94
“Pete.” Illustrated.....	H. A. HORTON 105
Record Buffalo Heads. Illustrated.....	W. T. H. 107
My Wife’s Moose. Illustrated.....	W. E. BEMIS 109
In the Gaulies. Illustrated.....	D. C. BRADEN 116
A Reminiscence of Buffalo Days. Illustrated.....	CAPT. H. ROMEYN, U.S.A. 117
A Salt Water Breeze. Illustrated.....	GEORGE G. CANTWELL 119
Old Fort Smith.....	MAJ. E. R. P. SHURLY, U.S.A. 121
In the Land of the Shag.....	F. J. CHURCH 122
Fishing in the Mountains of Maryland.....	L. L. LITMAN 124
Camped in the Canyon. (Poem).....	JAMES HANKS 126
A Montana Dream. (Poem).....	JOHN V. COLE 158
“Therefore I Jumped it.”—Frontispiece.....	BERT CASSIDY
How They Didn’t Hit Him in the Eye.....	J. B. JENNETT 171
“When Diana Gets Her Gun.” (Poem) Illustrated.....	STERN RAKOFF 174
Work of the Swine. Illustrated.....	J. D. P. 175
An Autumn Horseback Trip. Illustrated.....	J. F. GORDON 176
The Opening of the Season.....	R. B. BUCKHAM 179
A Cycle Race, with a Sequel.....	Miss C. H. THAYER 182
The Music of the Woods. (Poem).....	J. D. CRAWFORD, JR. 183
Echoes in the Moonlight. (Poem).....	MARGUERITE TRACY 185
A Yale-Princeton Football Game.....	COURTLAND NIXON 186
Ruffed Grouse and Woodcock.....	U. B. 189
Our Alaskan Exploring Expedition. Canoeing on the Stickeen. Illustrated.....	A. J. STONE 190
Catching a Tartar.....	CAPT. J. G. LEEFE, U.S.A. 192
A Canoe Trip to Rainy Lake.....	HARRY SILVER 195
The King of the Gaulies.....	MARK T. LEONARD 197
Elkland. Illustrated.....	ERNEST SETON THOMPSON 199
The Bear, the Belle, and the Blackberries.....	FRANCES WEBSTER 202
A Boating Song (Poem).....	E. W. MASON 204
How We Photographed the Wild Cat.....	COVOTE BILL 205
The Wolf Question.....	R. M. ALLEN, R. ASHWORTH, and Dr. FRANK DUNHAM 207
The Broadway Cable Sings. (Poem).....	MARGUERITE TRACY 210
My Recreation. (Poem).....	HON. S. B. McMANUS 232

	PAGE
The New Sport. Bait-Casting for Fox-Terriers.....	Frontispiece
The Willet. Illustrated.....	WILMOT TOWNSEND 255
The Mongolian Pheasant. Illustrated.....	G. M. MILLER 258
The Salmon's Rival.....	C. F. HOLDER 260
A Day in the Adirondacks.....	J. RODEMEYER, JR. 263
An Ideal Camp. (Poem).....	C. P. 265
A League of American Sportsmen.....	RALPH D. LYDECKER 266
Biking for Bass.....	W. W. BLACKWELL 269
A Bear Hunt in the Trinity Mountains.....	H. C. CROCKER 271
Unknown to the Jury.....	WILL SCRIBBLER 273
A Winter Day's Sport.....	WM. GERARD CHAPMAN, JR. 277
A Dry Camp.....	DR. E. B. DAVIS 278
A Comanche Liar.....	CAPT. C. J. CRANE 279
On Croatan.....	E. J. MYERS 281
Recreation (Poem).....	BETH DAY 285
Elkland. (Illustrated).....	ERNEST SETON THOMPSON 286
The Little Breakwaters.....	MARGUERITE TRACY 290
The Copper River Country.....	L. L. BALES 291
The Wolf Question.. EDW. L. MUNSON, L. A. HUFFMAN, VIC SMITH, GEO. B. MCCLELLAN, M. P. DUNHAM	293
"When the Wind Began to Blow Again I Would Sit Down and Slide in the Snow".....	Frontispiece
Hunting Mountain Sheep in a Snow-storm. Illustrated.....	CAPT. S. A. LAWSON 339
Speed Skating.....	A. M. ANDERSON 341
Deer in the Coast Range.....	DANIEL ARROWSMITH 343
Memories of a Quail Hunt.....	G. E. B. 345
In the Shin-Oaks of Texas.....	JOHN C. CASPARIS 347
Shooting in Albania.....	D. G. CARY-ELWES, F. S. A. 349
The Chiricahu Hounds.....	LT. A. F. CAPRON, U. S. A. 351
The Indian and the Deer.....	OLD SILVER TIP 353
Grouse in New Hampshire.....	OLD BILL 355
In the Bitter Root Mountains. Illustrated.....	H. S. GARFIELD, M. D. 357
In Early Days.....	GEO. HAYDEN 359
A Raid by the Kiowas.....	T. C. AUSTIN 361
A Grizzly and a Muzzle-loader.....	A. PLUMMER 363
Notes on Making Bird Skins.....	F. E. FLEMING 365
Foxes in the Big Swamp.....	C. P. FRANKLIN 367
Grandfather's Wish. (Poem).....	J. C. BRIGGS 368
Elkland, III. Illustrated.....	ERNEST SETON THOMPSON 369
Adrift on an Ice Floe.....	PETER AWICK 372
"In Autumn Time." (Poem).....	"OLANCHA" 374
The Wolf Question.....	Hon. B. B. BROOKS, Hon. HORACE BEACH, OTTO FRANZ, and others 375
While Sitting in the Blind. (Poem).....	FRANK C. RIEHL 379
On the Chilkat Pass.....	HARRY L. SUYDAM 412
"Lumbering Away Across the Bench Land.".....	Frontispiece
A Ram and Some Grizzlies. Illustrated.....	Hon. L. A. HUFFMAN 423
A Rangeley Vacation. Illustrated.....	C. J. HALPEN 425
Among Iowa Quails. Illustrated.....	E. A. JOHNSON 427
"At Sea." (Poem) Illustrated.....	ETHEL BROWNING 430
Watching. Illustrated.....	E. W. ROBINS 431
Chico. Illustrated.....	B. C. BROOME 436
Hunting with a Camera. Illustrated.....	W. E. CARLIN 441
The Timmer-Doodle. Illustrated.....	ERNEST SETON THOMPSON 445
Where are the Wild Pigeons?.....	STANLEY WATERLOO 451
"Hog Killin'." (Poem).....	W. H. NELSON 454
A Cart Load of Geese. Illustrated.....	J. F. 455
Elkland, IV. Illustrated.....	ERNEST SETON THOMPSON 456
Cayuga Lake Coons.....	LOU SMITH 457
Pierre's Stratagem.....	H. D. LEADBETTER 458
The Wolf Question.....	W. A. CAMERON and R. HOWES 460
A Remarkable Shot.....	Hon. W. A. RICHARDS 464
For a League of American Sportsmen.....	465
Arrest of a Navajo Indian Murderer.....	LT. E. H. PLUMMER 469
My First Buffalo.....	CONRAD HANEY 472
Woodcock and Snipe in Nova Scotia.....	H. AUSTEN 474
Our Alaskan Exploring Expedition.....	A. J. STONE 476
Canvasbacks and Terrapin.....	COL. FRED MATHER 478
The Successful Rearing of English Pheasants.....	PERCY SELOUS 480
Canoe Sketches, II.....	E. L. COLE 481
On White River.....	J. M. CAMPBELL 483
Up Mount Katahdin.....	F. S. CRABTREE 484
From the Game Fields.....43, 127, 211, 298, 380, 485	485
Fish and Fishing.....54, 140, 224, 308, 393, 493	493
Guns and Ammunition.....60, 145, 229, 313, 397, 497	497
Natural History.....67, 151, 233, 317, 403, 502	502
Editor's Corner.....72, 156, 238, 323, 406, 506	506
Publisher's Department.....82, 166, 250, 332, 415, 507	507
Bicycling.....73, 157, 241, 325, 407, 508	508
Canoeing.....329, 410, 510	510
Book Notices.....76, 160, XXI, 413, 515	515
Amateur Photography.....79, 162, 247, 335, 419, 511	511

# RECREATION

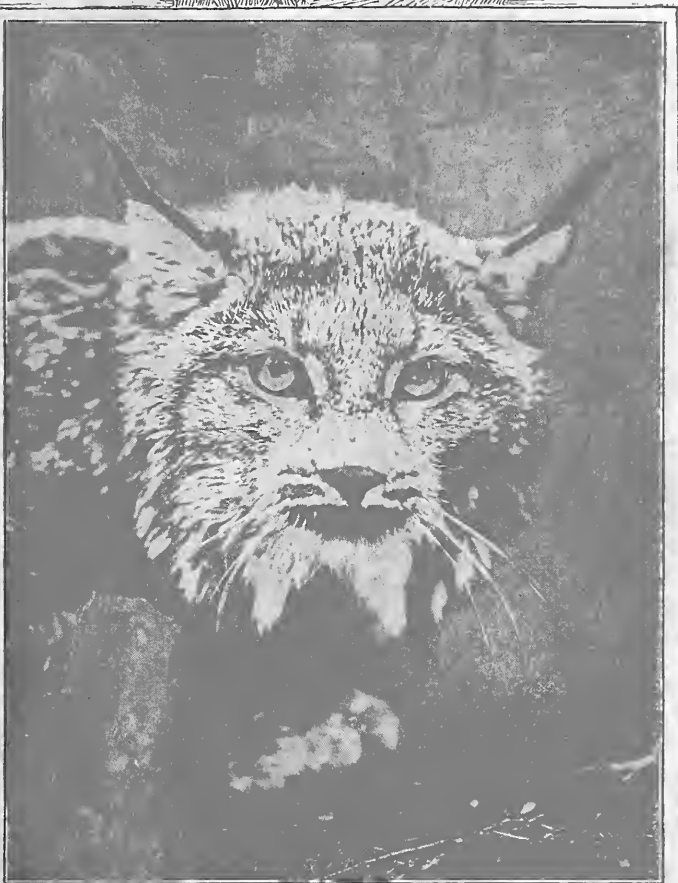

Copyright, 1897, by WRIGHT & CARLIN  
CANADA LYNX



PUBLISHED BY G. O. SHIELDS (COQUINA)  
19 WEST 24TH ST. NEW YORK



FOR...  
Long  
Range  
Targets



Big  
Game  
Hunting

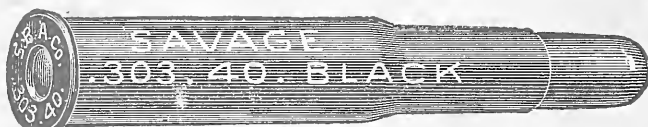

Black  
Powder  
Ranges



Schuetzen  
Target  
Ranges



Small  
Game  
Hunting



Short  
Range  
Use

# One Savage Rifle

TAKES ALL THESE  
DIFFERENT  
CARTRIDGES

*Write for our new Catalogue*

**.303**

Savage Repeating  
Arms Co.

UTICA, N. Y.  
U. S. A.

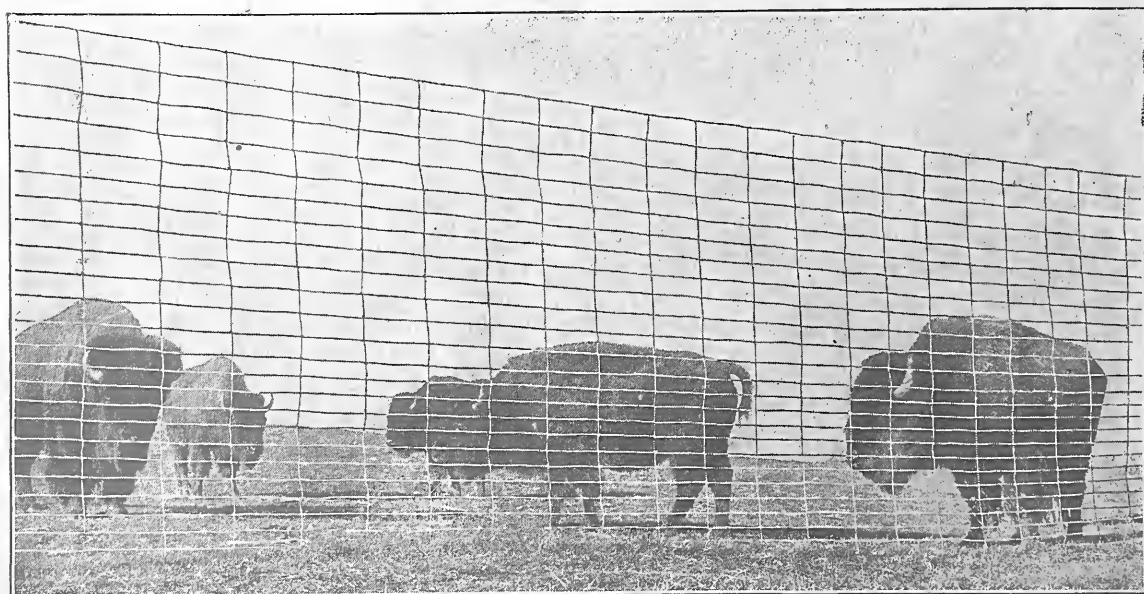

**STOP THE GAME!!! KILL THE UMPIRE?**

**NO!**

Simply build a PAGE FENCE around the premises and you've got 'em. No obstruction to the view. Holds Buffalo, Deer, Elk, anything.

Write for Particulars....

**PAGE WOVEN WIRE FENCE CO.**

ADRIAN, MICH.



**Familiar Faces These!** As the "SOZODONT GIRL," one became widely known years ago, the other recently through the public prints. Both are types of dainty women with whom SOZODONT is the favorite dentifrice. Can you give us the correct name of either lady? If so, you may add the names of ten friends, to each of whom we will send a trial bottle of SOZODONT free of charge. In any event, we will send you one.

Address P. O. Box 247, New York City. HALL & RUCKEL, Proprietors, NEW YORK, LONDON.



# MONARCH

THE LADIES' FAVORITE

"RIDE A MONARCH AND KEEP IN FRONT."

MONARCH CYCLE MFG CO.

CHICAGO · NEW YORK · LONDON

# RECREATION

Copyright, December, 1896, by G. O. Shields

A Monthly Magazine Devoted to Everything the Name Implies

\$1.00 A YEAR.  
10 CENTS A COPY.

G. O. SHIELDS (COQUINA),  
Editor and Manager.

19 WEST 24TH STREET,  
NEW YORK.

## CONTENTS OF THIS NUMBER

	PAGE
"With One Long, Silent Stroke She Glided into Mid-Stream." Frontispiece.....	HARRY WATSON
Pocahontas in England. Illustrated.....	J. C. 3
How the Big Ram Was Killed. Illustrated.....	F. W. S. 16
My Twenty-two Point Buck. Illustrated.....	F. D. HULBERT 12
The First Day of the Chicken Season.....	A. B. COWIE 15
Goose Shooting in Colorado. Illustrated.....	W. E. KING 19
A Good Indian. Illustrated.....	NELSON YARNALL 20
"A Fishing Story." (Poem.) Illustrated.....	CAPT. H. P. BECKWITH 22
The Rented Bicycle Suit. Illustrated.....	WALTER I. SHAY 23
My Last Hunt in Kansas. Illustrated.....	GEN. F. W. BENTEN 27
The Cowboy's Version of the Prodigal Son.....	PONY BILL 31
"Spring." (Poem.).....	W. T. JONES 32
Only a Dog.....	A. W. DIMOCK 33
Hoover's Ranch.....	JAS. HANKS 34
Trouting on the Thunder.....	A. D. CURTIS 35
Mark East!.....	S. T. EARNS 37
"Piscatory Evolution." (Poem.) Illustrated.....	FRANK E. PAGE 38
A Hard Ride in the Mountains.....	J. G. T. 39
Rabbit Shooting in Kansas.....	A. W. BITTING 40
Some Old Guns. Illustrated.....	CAPT. PHILIP READE U.S.A. 41
From the Game Fields.....	43
Fish and Fishing.....	54
Guns and Ammunition.....	60
Natural History.....	67
Editor's Corner.....	72
Bicycling.....	73
Puzzle Page.....	75
Book Notices.....	76
Amateur Photography.....	79
Publisher's Department.....	82

Entered as Second-Class Matter at New York Post-Office, Oct. 17, 1894.

# Hon. Thomas Marshall

## 25

STRAIGHT



Mayor of Keithsburg, Ill.

WINNER OF

## Grand American Handicap

March 24, 1897



Used DU PONT  
SMOKELESS POWDER

E. I. Du Pont De Nemours & Co., WILMINGTON, DEL.

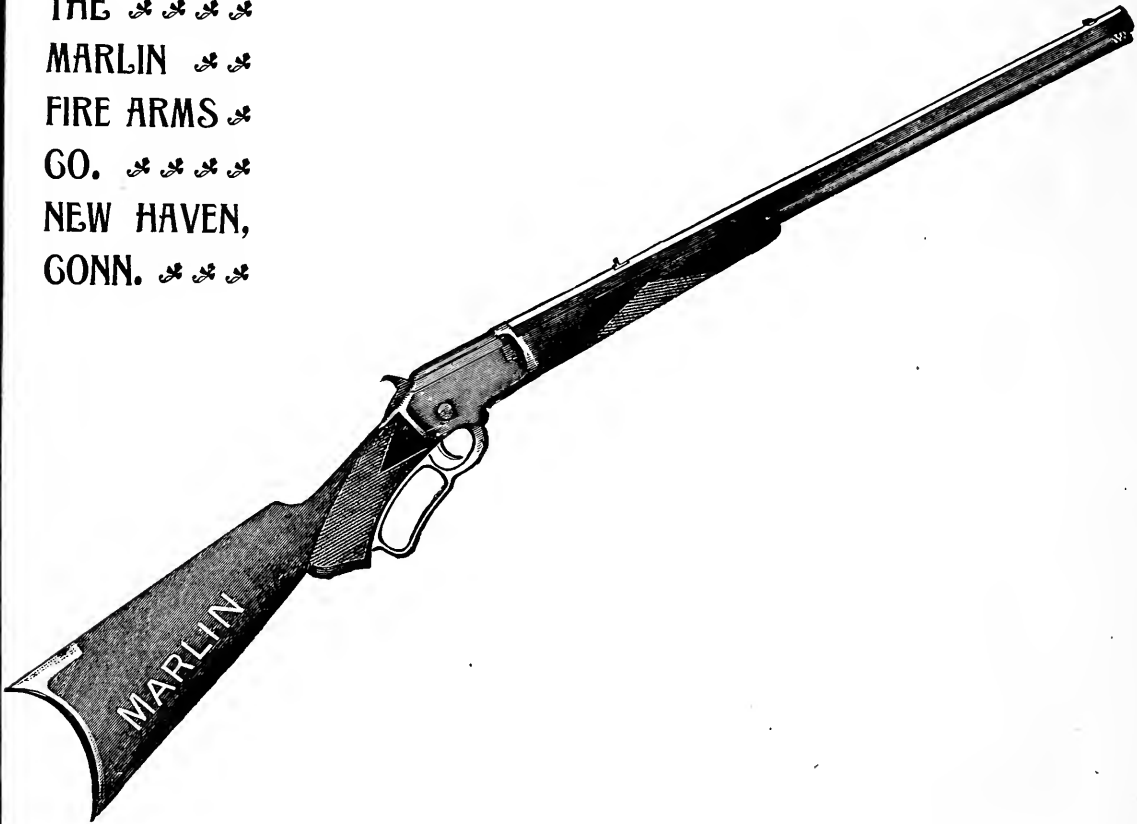
THE ❀ ❀ ❀ ❀  
 MARLIN ❀ ❀  
 FIRE ARMS ❀  
 GO. ❀ ❀ ❀ ❀  
 NEW HAVEN,  
 CONN. ❀ ❀ ❀



## A Good Repeating Rifle

For everyday use is the Marlin Model, 1892, 32 calibre. For ordinary hunting, where a 22 calibre is a little too light, this rifle will be found thoroughly satisfactory. For shooting at a mark and for general practice it is just the thing. The ammunition costs but little and so you can shoot all day long either the  or the 



without finding the sport expensive.



If you wish to reload your ammunition you can use these two 

All four in one  
 and the same arm.



No alteration necessary, except to change the firing pin from rim fire to centre fire, and vice versa. This can be done without using a single tool. THIS IS THE ONLY REPEATING RIFLE made to take rim-fire cartridges larger than 22 calibre. This rifle can be taken apart without using a single tool.



THE MARLIN FIRE ARMS CO.  
 NEW HAVEN, CONN.



IT STICKS TO METAL

# We Guarantee Marlin Rust-Repeller

to be an absolute Rust Preventive and  
a perfect lubricant.



(Exact size of 1 1/2 ounce tube)

It is clean and we know of no preparation of which such a  
small quantity will do so much work.

It is the best lubricant for

**Bicycle Chains** { Never gums  
**and Bearings** { Never drips  
as it is easy and clean to apply { Never grows rancid

Put up in { 1 1/2 ounce collapsible tubes 15c.  
                  { 3 ounce collapsible tubes 25c.  
                  { 1 pound cans . . . . 75c.

Put up only by THE MARLIN FIRE ARMS CO.  
NEW HAVEN, CONN.

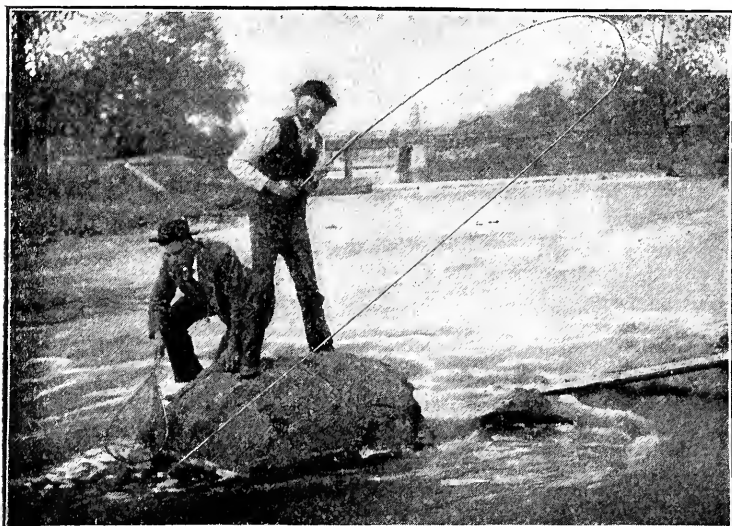

A Critical Moment



There is.....

**GOOD  
FISHING**

ALONG THE

# PICTURESQUE ERIE

Let Us  
Suggest.....



## The Delaware River

For Salmon, Bass and  
Wall-Eyed Pike

## Greenwood Lake

For Bass, Pike and  
Pickerel

and the hundreds of trout  
streams and lakes men-  
tioned in our little book  
on fishing, which will be  
mailed on application



## D. I. ROBERTS

Gen'l Passenger Agt.  
21 Cortlandt St., New York



Fishing on the Picturesque Erie



# ROOT'S

## Camel Hair Underwear

Soft and velvety to the most sensitive skin  
The best safeguard to health in our climate  
For Men, Women and Children  
The perfected result of years of experience

*Write for illustrated booklet.*  
ROOT MFG. CO., 1 Greene St., NEW YORK

---

# ROOT'S

## Natural Wool Underwear

ROOT'S TIVOLI STANDARD UNDERWEAR  
TRADE MARK.



# HEUBLEIN'S CLUB PUNCH

A SCIENTIFICALLY COMPOUNDED ARTICLE, MADE ONLY OF THE VERY CHOICEST MATERIALS, AND READY TO SERVE IN A MINUTES NOTICE; JUST THE THING FOR AN AFTERNOON-TEA, EVENING-PARTY, YACHT OR PICNIC. IT MAKES ENTERTAINING EASY.

FOR SALE BY ALL DEALERS

PREPARED AND GUARANTEED BY  
*G. F. Heublein & Bro.*  
HARTFORD, NEW YORK, LONDON.

## As Delightful to Drink as it's easy to make.

Fill bowl with ice, pour contents of bottle over same—it's ready for use. For a delicious Claret Cup, add one pint of good Claret to one quart of Club Punch. Fruits in season may be added.

# WHAT USE

is a road map, or the most explicit directions, without a



# Veeder

## CYCLOMETER

to show exactly how far you have ridden.

IT IS DUST PROOF, WATER PROOF, POSITIVELY ACCURATE.

The Veeder has banished all other forms of cyclometer, and its success has aroused imitations that resemble it only in appearance. Be sure your purchase bears the name that assures perfection—VEEDER.

At all Dealers.  
Booklet Free.



Actual Size.  
PRICE, \$1.50.  
WEIGHT, 1 OZ.

VEEDER MFG. CO., Hartford, Conn.

## UNEQUALED ATTRACTIONS

ON THE LINE OF THE

# Union Pacific

FOR TOURISTS

It traverses the Grandest Scenery of the Rocky Mountains, and reaches all the Health and Pleasure Resorts of the Mid-Continent.

**Sportsmen** will find in scores of localities along this line game worthy of their skill, such as Bear, Mountain Lion, Coyotes, Elk, Deer, Antelope, Mountain Sheep, Feathered Game of all kinds. And everywhere are Beautiful Streams well stocked with Trout.

For Gun Club Rules, Game Laws, and any information relative to localities for Hunting, or for information in regard to the UNION PACIFIC SYSTEM, call on or address any General or Traveling Agent of this Company.

R. TENBROECK, Gen'l Eastern Agent,  
287 Broadway, New York City

E. DICKINSON, Gen'l Manager,      E. L. LOMAX, Gen'l Pass. & Tkt. Agt.,  
Omaha, Neb.

# The Carlsbad of America

THE RENOWNED

At SOUTH POLAND, MAINE ... Poland Spring Spa

Is the foremost of American Spas, rivalling the older mineral springs of Europe. **POLAND WATER** is known and valued everywhere. It is prescribed by leading physicians all over the United States and Canada.



POLAND SPRING HOUSE

Every great liner that crosses the ocean carries *POLAND WATER* as part freight. It is shipped to South America, to Mexico, to the continent of Europe, Egypt, India, to every country in the civilized world. Agencies are maintained in the leading American cities, the principal one being that in New York, where alone the annual sales amount to a million of gallons.

The **POLAND SPRING HOTEL** is one of the finest in the world. A beautiful pamphlet, giving full information, will be sent on application to

**HIRAM RICKER & SONS (Inc.)**

175 DEVONSHIRE STREET, BOSTON  
3 PARK PLACE, NEW YORK

Poland Spring, South Poland, Maine

# GAS ENGINE & POWER CO.

and CHARLES L. SEABURY & CO., Builders of

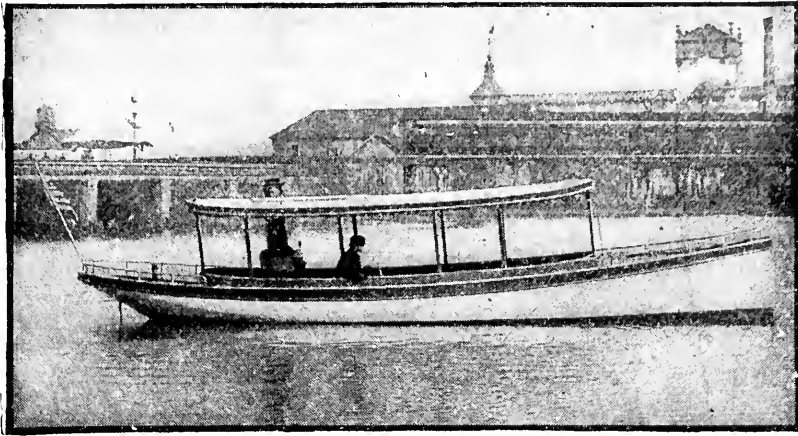

# The Only Naphtha ..Launch..

High-class Steam Yachts, Sail Yachts, Electric Launches, Dinghys, Gigs and Yacht Tenders, Seabury's Water Tube Boilers, Marine Engines

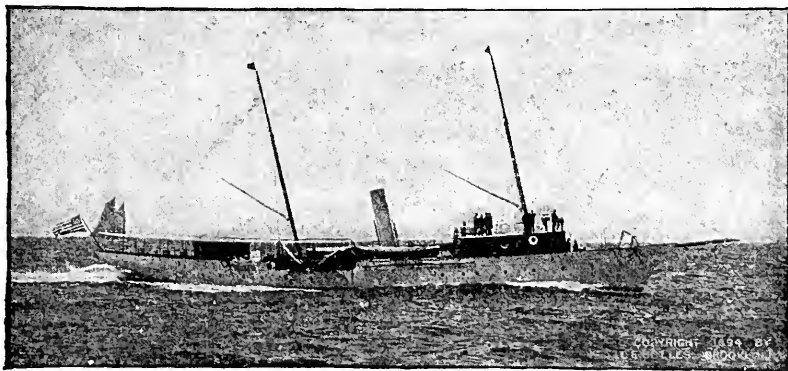

Storage Basin and Ship's ways. Overhauling of all kinds promptly done. Charters and Insurance. Boats bought and sold on commission . . . . .

CORRESPONDENCE SOLICITED . . . . .

Send ten cents in stamps for catalogues, to downtown office, 50 BROADWAY, or to factory at

MORRIS HEIGHTS, New York City

**Burlington  
Route**

**BEST LINE  
TO  
DENVER**

# ST PAUL AND MINNEAPOLIS LIMITED EXPRESS

THE FINEST TRAIN IN THE WORLD  
LEAVES CHICAGO DAILY AT 6.30 P.M.

**Burlington  
Route**

**BEST LINE  
TO  
ST. PAUL  
AND  
MINNEAPOLIS**

**Burlington  
Route**

**BEST LINE  
TO  
OMAHA**

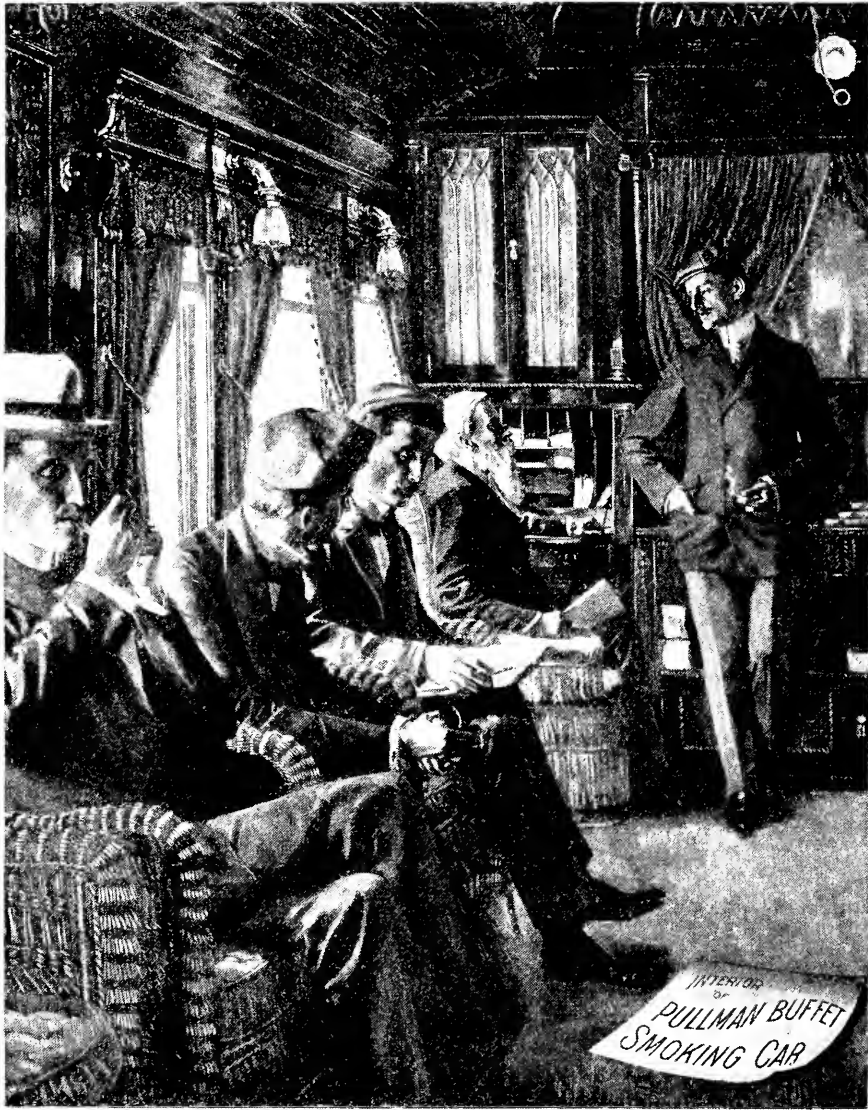

**Burlington  
Route**

**BEST LINE  
TO  
KANSAS CITY**

**Burlington  
Route**

**BEST LINE  
TO  
COUNCIL  
BLUFFS**

**Burlington  
Route**

**BEST LINE  
TO  
BLACK HILLS**

**Burlington  
Route**

**BEST LINE  
TO  
PUGET  
SOUND**

**Burlington  
Route**

**BEST LINE  
TO  
CALIFORNIA**

**Burlington  
Route**

**BEST LINE  
TO  
MONTANA**

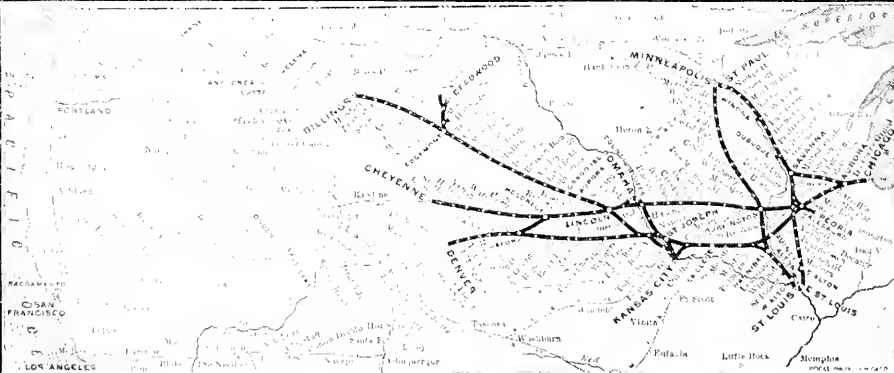

**Burlington  
Route**

**BEST LINE  
TO  
TEXAS**

## AN OUT-DOOR ARTICLE

A GENTLEMAN came into our office yesterday to buy a Gramophone. Casually we asked him how he happened to get interested in our talking machines. He replied as follows: "Several days ago I was in Washington, D. C., walking down Pennsylvania Avenue at about 14th Street, when I noticed a crowd of people standing on the sidewalk, apparently interested or listening to something.

singing 'Ben Bolt' in a mar-  
manner. A little knot of  
the broad expanse of Penn-  
at that point is over one  
ond story window,  
the small horn of  
found to be the  
listened for a few  
heard this wonder-  
the Banjo, the  
baritone solo from  
several of the pop-  
day. I could dis-  
understand all  
took pains to in-  
found that this  
by clock work,  
liable to get out of  
and that I could pur-  
from time to time as I  
or \$6.00 per dozen. I made  
there, that I would purchase  
returned to New York, and I am

It is the above statement  
readers of "Recreation" the fact  
mer outdoor entertainer. You can hear the strains of the full brass band on a still summer evening, hundreds of feet from the veranda. Everyone going away for the summer should provide themselves with one of these tain and amuse their friends. The of our most captivating artists;

We will send you  
receipt of price, \$25.00,  
two records. We guar-  
if the machine does  
represented, you  
to us within twenty-  
paying the express

Express charges  
East of the Rocky  
accompanies the  
ments are sent  
cash accompanies

NATIONAL  
GRAMOPHONE  
COMPANY



MAUD FOSTER



BILLY GOLDEN

As I approached, I heard a voice  
velously distinct and pleasing  
people were looking across  
sylvania Avenue (which  
hundred feet) at a sec-  
from which protruded  
which I afterward  
Gramophone. I  
moments, and I  
ful machine play  
Piano, sing a  
an opera, and  
ular songs of the  
tinctly hear and  
the words. I then  
vestigate it, and  
small machine run  
simple and not  
order, cost but \$25.00,  
chase as many records  
pleased, at 60 cents each  
up my mind then and  
one of those machines when I  
here to do so." ❀❀❀❀❀❀❀❀

that causes us to lay before the  
that the Gramophone is a sum-  
mer outdoor entertainer. You can hear the strains of the full brass band on a still summer evening, hundreds of feet from the veranda. Everyone going away for the summer should provide themselves with one of these marvelous instruments, to enter-illustrations herewith show two they are full of fun and frolic.

express prepaid, upon  
a complete outfit with  
antee satisfaction, and  
not do all that is  
may return same  
four hours, simply  
charges. ❀❀❀❀❀  
paid to any point  
Mountains, if Cash  
order. All ship-  
C O. D. unless  
order. Send for  
catalogues.

874  
BROADWAY,  
NEW YORK

# Genuine Siberian Moose Hunting, Golf or Walking Shoes

ABSOLUTELY WATER-PROOF TO THE TOP.

NOTHING SO GOOD EVER PRODUCED BEFORE AT ANY PRICE.

This is a **special** line of Boots and Shoes in every way. Special water-proof leather, special anhydrous soles, special lasts of new design, special stitching, special lining, in fact, every point of shoe worth has been studied to give each special value.

The result is a shoe as strong as steel, yet, pliable and soft as kid, graceful to the eye and easy on the foot, and will outwear any two ordinary shoes.

**The leather** is the famous Siberian Moose. Costs more than any other, and guaranteed water-proof.

**The soles** are of the best anhydrous oak stock, made water-proof by patented process.

**The stitching** will not rip. The bottoms are hand-sewed with Barbour's extra heavy water-proof flax. The uppers are stitched and then double-stitched with pure silk.

**Bellows tongues** of the best Moose stock are used, making the shoes water-proof to the top.

**The linings** are of finest russet calf-skin, adding warmth and strength.

**English Backstays, extra heavy eye-lets, "Bull Dog" toes, Pratt Fasteners, etc., etc.** Every approved shoe point will be found in them. **Price to all alike, \$7.50 net.**

We also make a short boot, 12 inches high, at \$8.50; a knee boot, "Hunters Style," lacing up the front, at \$10.00, and a "Cavalry Style" boot, at \$12.00, all with the same good points as the shoes.

We expect a large out-of-town trade, and to quickly introduce this line we will, on the first 100 pairs, prepay expressage to any part of the United States or Canada, as the orders are received.

**HENRY C.  
SQUIRES & SON**

20 Cortlandt  
Street  
New York

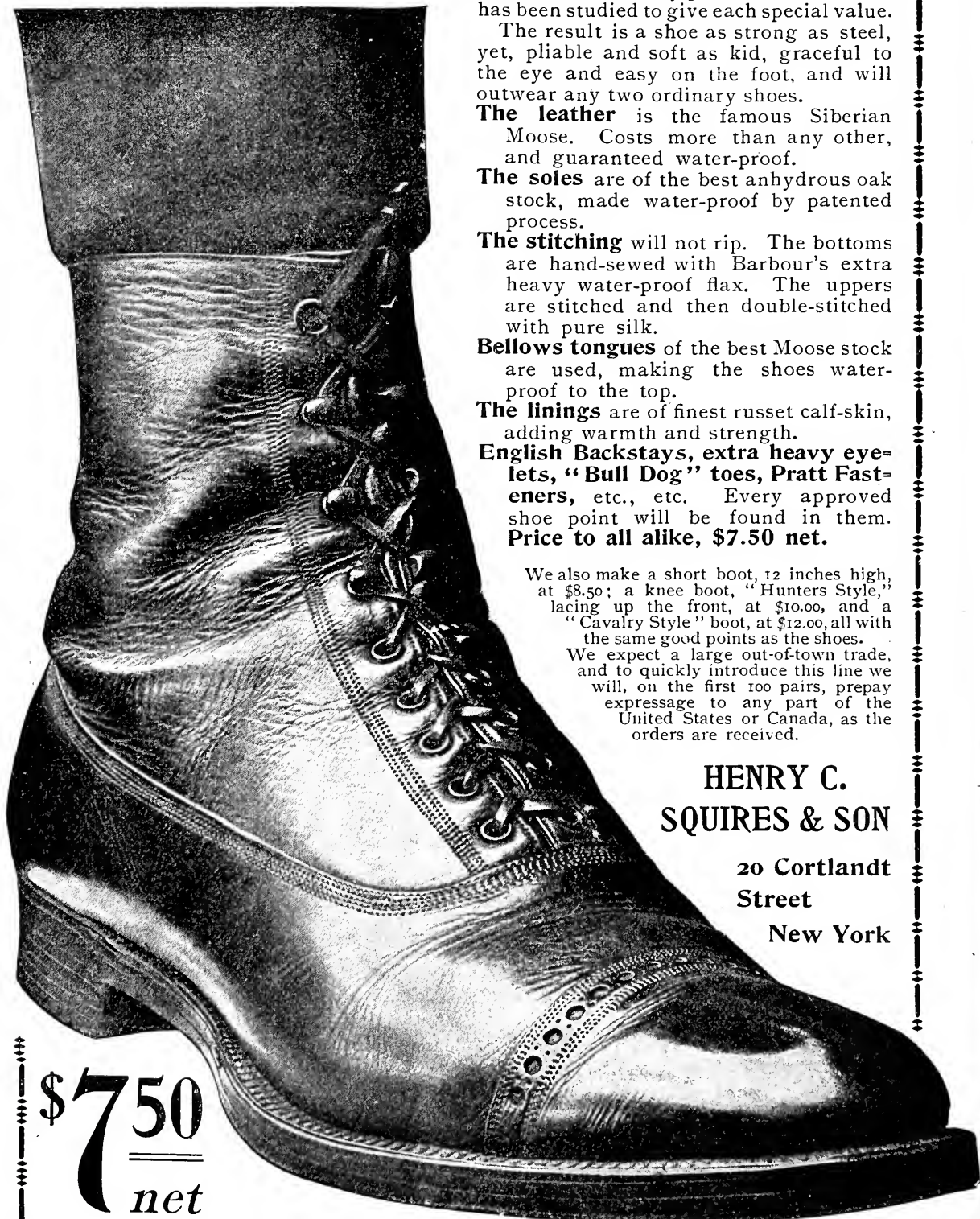

**\$7.50**  
**net**

The cut is a photograph of our tan walking shoe after having been worn two months.



# In All the World No Trip Like This

TO tour the Great Lakes and their connecting rivers would, under any circumstances, be a journey full of charm and interest; but to make the round trip from Buffalo to Duluth by the magnificent steamships of the Northern Steamship Company is to experience the most delightful 2,000 miles of travel it is possible to take.

**Starting** from Buffalo at 9.30 P. M. on any Tuesday or Friday during the summer season, the route is through Lake Erie, touching at Cleveland early the next morning, and at Detroit that afternoon, passing through the "Straits," the beautiful Lake St. Clair, and the St. Clair River by daylight, then into Lake Huron and through the great inland sea, reaching historic Mackinack Island at 10.30 the second morning, thence up the extremely picturesque St Mary's River, dotted with full 5,000 islands, and passing through the "Soo" and its world-famed locks, all by daylight. The following night and day are spent on the vast expanse and in the invigorating atmosphere of Lake Superior, Duluth coming into sight as the evening shadows fall. After three quarters of a day in the Zenith City the return trip is made in the reverse order, so that the entire route is seen, going or coming, by daylight, and Buffalo reached at noon of the seventh day.

"Seven halcyon days of blessed rest,"

worth a month's ordinary vacation to the weary brain and tired body.

While to this unequalled cruise for rest and health and pure enjoyment Nature has contributed so much that is grand and beautiful, nineteenth-century progress, as evidenced in the flourishing cities, summer resorts, and the immense commerce of the Lakes, has added that requisite so necessary to interest one, and so noticeably lacking in a mere ocean voyage. But it remained for the Northern Steamship Company to bring all within the experience of the tourist by a fleet of steamships which are to the Great Lakes what the finest hotels are to the most celebrated summer resorts.

*The North* and *The North West* are, indeed, nothing less (and at the same time a great deal more) than great summer hotels afloat.

Banish from your mind at once any idea of the

"cabined, cribbed, confined"

quarters of the ordinary steamship, and re-

place it with the picture of private parlors *en suite*, with bath, brass bedsteads, couches, easy-chairs, electric lights, etc., with state-rooms finished in Cuban mahogany.

No freight is carried. Every precaution and every appliance known to marine architecture of the very latest type, for the safety and the convenience of the passengers, are provided.

The cuisine is equal in every respect to that of the finest hotels, while the appetizing air gives a zest to the enjoyment of the meals peculiar to this ozone-laden atmosphere.

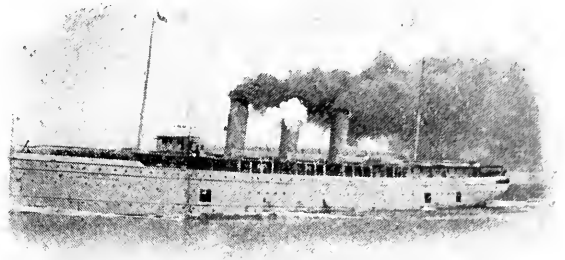

The price of the round-trip ticket from Buffalo to Duluth and return is \$29, less than 1½ cents per mile. The price of berths, state-rooms, and suites of rooms varies, according to the location, capacity, and elegance, from \$9 round trip. Meals are served *à la carte*, so that their cost can be regulated by the passenger. The menu prices are moderate, and, liberal portions being served, two or more persons traveling together can materially reduce the cost of each.

Passengers wishing to make longer stops at Cleveland, Detroit, Mackinack Island, Sault Ste. Marie, or Duluth than is made by the steamship, can obtain stop-over checks good for the entire season.

Connections are made at Duluth with the Great Northern Railroad, Northern Pacific Railroad and diverging roads, for all points farther west to Yellowstone Park, Great Falls, Helena, Butte, Pacific Coast cities and Pacific Steamship lines.

Further particulars will be furnished by addressing

I. M. BORTLE, Gen. Pass Agent,  
Northern S. S. Co., Buffalo, N. Y.

W. C. FARRINGTON, Vice-President.

Or any railroad ticket agent, or the following agents of the Northern S. S. Co.:

Boston, Mass., 211 Washington St., W. A. Seward, Gen'l Agt.  
Chicago, Ill., 220 S. Clark St., W. M. Lowrie, Gen'l Agt. Pass. Dept.  
Cincinnati, O., Fifth and Walnut Sts., W. J. Byrth, Gen'l Agt.  
Cleveland, O., 239 Superior St., D. J. Colver, Ticket Agt.  
Detroit, Mich., Foot First St., E. B. Clark, Gen'l Agt.  
Duluth, Minn., 432 W. Superior St., C. D. Harper, N. Pass. Agt.  
Minneapolis, Minn., 300 Nicollet Ave., V. D. Jones, City P. & T. Agt.  
Montreal, Quebec, 1761 Notre Dame St., W. G. McLean, Trav. Agt.  
New York, N. Y., 375 B'way, E. D. Spencer, Gen'l Agt. Pass. Dept.  
Philadelphia, Pa., 42 So. Third St., A. C. Harvey, Dist. Pass. Agt.  
Pittsburg, Pa., 405 Fifth Ave., Delano Luce, Pass. Agt.  
St. Louis, Mo., 505 Olive St., W. J. Evans, Gen'l Agt.  
St. Paul, Minn., 109 East Third St., W. J. Dutch, City P. & T. Agt.  
Toronto, Ont., 2 King St., East, H. G. McMicken, Gen'l Agt.



# FOWLER CYCLE MFG. CO.

CHICAGO.

NEW YORK, BOSTON,

PROVIDENCE, LONDON.

DROP US A POSTAL FOR A 97' CATALOGUE.

FOR THE

**SKIN**

**SCALP**

...and...

**COMPLEXION**

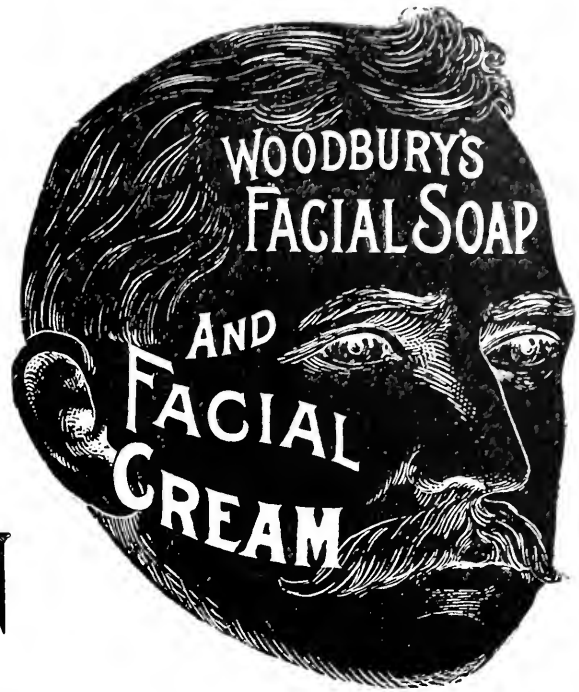

*Pure, Antiseptic, Medicinal*

The grandest combination known for curing a bad skin and protecting a good complexion. Manufactured by Dermatologist John H. Woodbury, who has made the Skin, Scalp, and Complexion a study for over twenty-six years.

*Woodbury's Facial Cream*

being absolutely free from grease or oil of any nature can be used freely on the face or hands without causing a superfluous growth of hair. It is delightfully perfumed and an acquisition to the toilet.

*Woodbury's Facial Soap*

contains the best Antiseptic known to Medical Science and will allay any irritation of the skin. Its daily use will eradicate Blackheads, Freckles, and Pimples, and when used in conjunction with Woodbury's Facial Cream will leave the skin clear, soft, and beautiful. They are sold everywhere.

**JOHN H. WOODBURY, Dermatological Institute**

Offices for the Cure of Skin and Nervous Diseases and the Removal of Facial Blemishes:

New York, 127 W. 42d St.:

Boston, 11 Winter St.:

Philadelphia, 1306 Walnut St.:

Chicago, 163 State St.

Address all letters to 127 West 42d Street, New York.

A sample of either Woodbury's Facial Soap or Facial Cream, with 132-page illustrated Beauty book, mailed on receipt of 10 cents by mentioning *Recreation*.



# THE VICTOR

# OFFICIAL LEAGUE BALL

is recognized far and wide as the best league ball that money can buy

Why not  
Use the  
Best?

*It is the only ball that conforms exactly to the specifications of the National League*

*It is always uniform in size and shape*

*It will outwear any other league ball*

*It is honestly made of the finest materials only*

We make a specialty of Team Outfits—  
Uniforms, Bats, Mitts, and Gloves

## OVERMAN WHEEL CO.

Makers of Victor Bicycles and Athletic Goods

New York

Boston

Chicago

Detroit

Denver

Pacific Coast: San Francisco

Portland



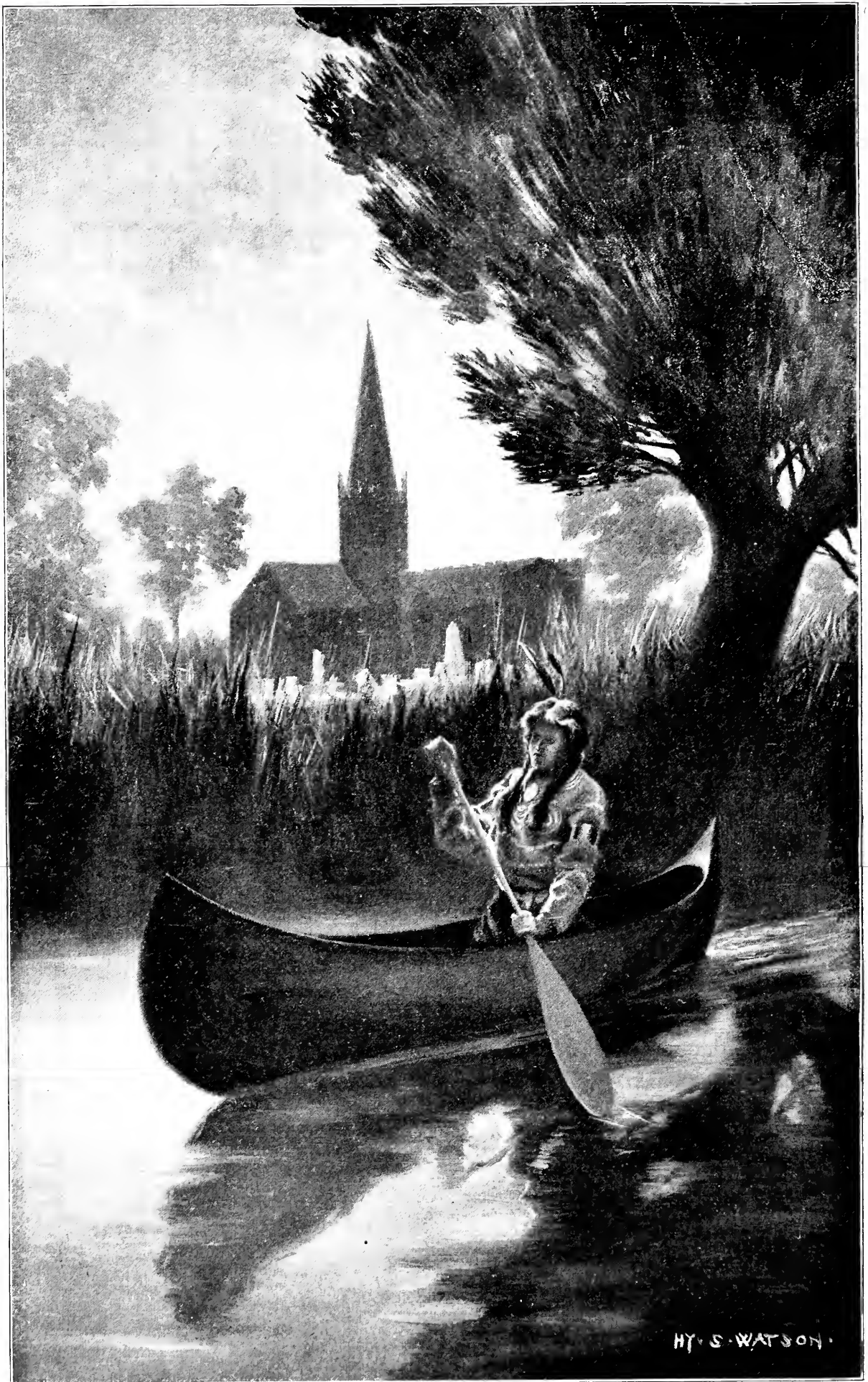

H. S. WATSON.

"WITH ONE LONG, SILENT STROKE SHE GLIDED INTO MID-STREAM."

# RECREATION.

Volume VII.

JULY, 1897.

Number 1.

G. O. SHIELDS (COQUINA), Editor and Manager.

## POCAHONTAS IN ENGLAND.

J. C.

The chimes in the church tower, which were ringing the prelude to twelve, scattered their soft notes into the moonlit heavens. She was cold, very cold, and numb from lying long in her narrow cell. She threw off the damp winding-cloth and stood out from beneath the willow trees, in the light of the moon. It warmed her pale limbs.

Two people were sitting by the river side, in the cool of the midsummer night. Their canoe, not far off, was held by its bow in the shore.

"They say Pocahontas was buried over there in the churchyard," said one, thoughtfully. "Poor lady, she must have been tired enough of cities and captains and kings before she died."

"Times have changed since then," said the other, softly. "Pocahontas would lie more at rest by the old British Thames if she knew that every day it swarms with canoes from her American wilds, and that people here have grown to love out-of-doors as their forefathers did, and to live nearer to Nature."

As she heard this she stepped forth to the bank; stiffly at first, though warmed by the moon. Her feathers rose and fell along her back as she trod, and the white wampum on her leggins moved noiselessly. She stepped into the canoe and sank on her knees in the bottom. With one long,

silent stroke she glided into mid-stream. She did not look back at her gravestone, white in the moonlight, nor at the two people on the shore; but swept on and on, stroke after stroke. The cities of men she forgot, and the kings and the warriors, for her knees were on the floor of the craft she loved, and in her hands was the paddle, as of old, in the Indian wilds beyond the ocean.

The slow bell was tolling—seven—eight—

"Look!" said one of the people on the bank, shuddering, and caught the other by the arm.

"I see nothing."

"We will go to the inn," the first went on; "I am trembling."

"Wait," said the other. "The canoe is gone. It must have drifted away. I will find it."

"I can not wait.—I saw it float away.—Come. I am cold."

The bell tolled—nine—ten—. The bow of the canoe struck the opposite shore. The Indian girl stepped lightly forth and drew it up on the grass. She was warmer now—quite filled with the ghostly rays from the moon.

The clock struck eleven, twelve, and then the vast silence of midnight fell upon the sky. Her hour had just begun.

"Come," said the watcher; "come quickly. I am trembling. The night air has chilled me."



AMATEUR PHOTO BY MYRA A. WIGGINS.

#### HUNTING THE BIG HORN.

Winner of First Prize in RECREATION'S Second Annual Photo Competition.  
Photo made with a Gundlach perigratic lens.





AMATEUR PHOTO BY W. L. RATHBONE.

IN THE SWIM.

Winner of Second Prize in RECREATION'S Second Annual Photo Competition.



AMATEUR PHOTO BY F. T. HARMON.

GEE!

Winner of Third Prize in RECREATION'S Second Annual Photo Competition.

Made with a Blair Camera, on a Stanley plate.

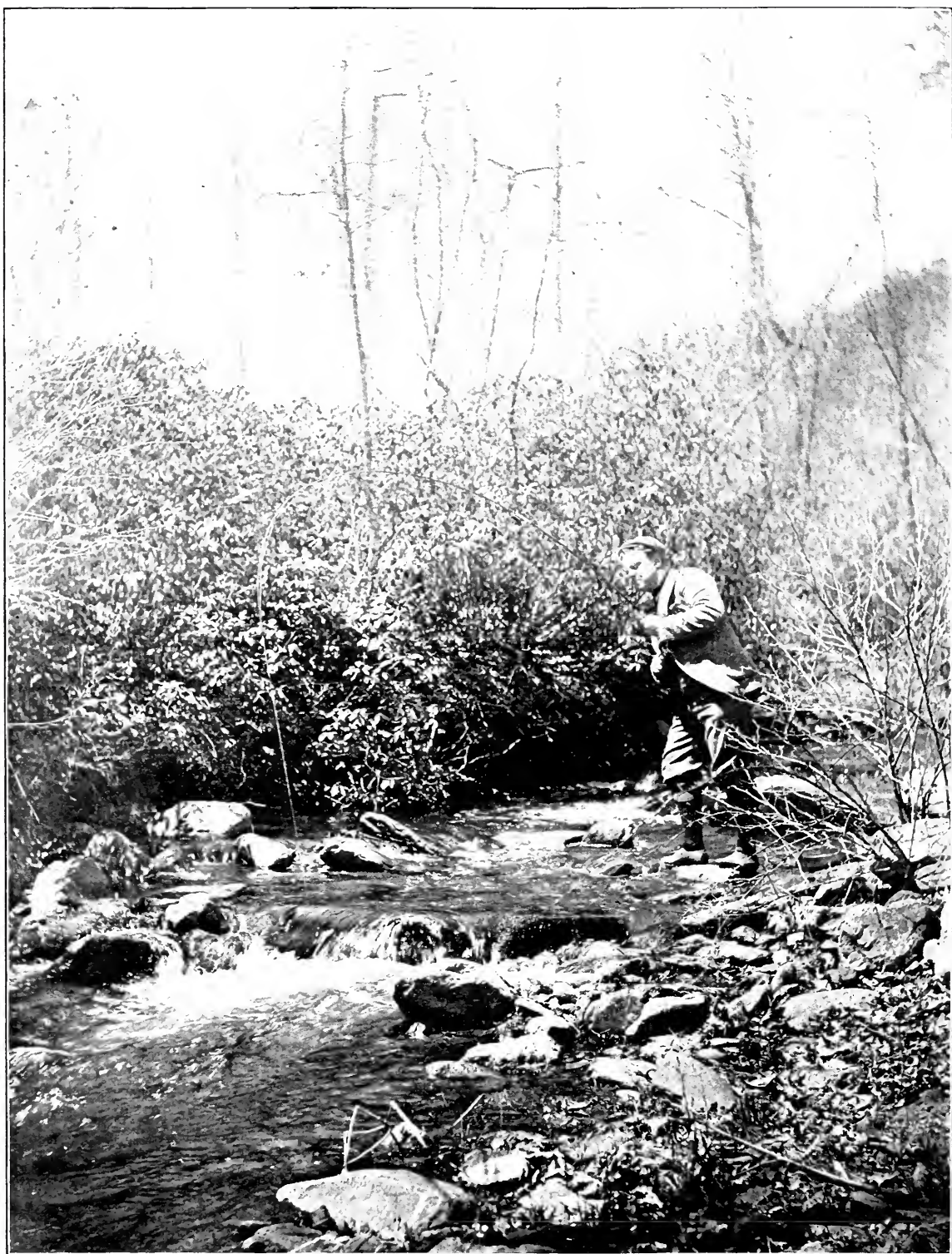

AMATEUR PHOTO BY F. C. FEARRE.

A BIG ONE AT LAST.

Winner of Fourth Prize in RECREATION'S Second Annual Photo Competition.

Photo made with a Rochester Optical Co.'s Premo Camera, fitted with a Victor lens, on an Eastman Red Seal plate.



AMATEUR PHOTO BY W. H. WALTERS.

ALONE, PERHAPS.

Winner of Fifth Prize in RECREATION'S Second Annual Photo Competition.



AMATEUR PHOTO BY D. M. FALL.

AFTER BLACK BASS.

Winner of Seventh Prize in RECREATION'S Second Annual Photo Competition.

Made with a Premo Camera, on a Stanley dry plate.



AMATEUR PHOTO BY A. C. MELLETT.

AN AFRICAN HUNT.

Winner of Sixth Prize in RECREATION'S Second Annual Photo Competition.



AMATEUR PHOTO BY J. T. GRAVES.

A PORTRAIT STUDY.

By Gas Light.

## ACETYLENE GAS IN PHOTOGRAPHY.

One of the latest illuminants, for photographic use, is acetylene gas, the spectral analysis of which shows identically the same range of colors as daylight. Only a year ago acetylene gas became a commercial commodity and it is but a few months

since experiments were made to test the light for photographic purposes. One of the leading Chicago photographers tested the light and found that excellent negatives could be made with it, with almost the same speed as in daylight. Since then the Camera

Club, of St. Catharines, Canada, placed an installation of the gas in its studio (one of the finest equipped galleries in Canada) and has, for the past few months, been carrying on extensive experiments. Several of the members now assert that artistic and beautifully lighted portrait studies can be as readily made with this light as by daylight. Of course the gas is not powerful enough to allow snap shots, in the studio, as necessary for children or nervous people; but for all adults who can allow from 3 to 5

seconds exposure magnificent results can be obtained.

On the opposite page is shown a portrait study, made by Mr. J. T. Groves, one of Canada's most expert amateur photographers, using acetylene gas as the illuminant. It is altogether probable that the next few months will find acetylene gas introduced into every up-to-date gallery in the country, especially as an installation of acetylene costs but little and, used intelligently, it is as safe as any other gas.

## HOW THE BIG RAM WAS KILLED.

F. W. S.

"I have killed a great many mountain sheep," old Scotty MacDougall wrote from the Selkirks, to a friend in Tacoma, "but this is the craftiest old ram I ever undertook to corral. I have followed him no less than 500 miles, from one range to another. He has left the band and gone off by himself; and always when I get sight of him he is out of range, standing across on some peak, looking at me.

"I have tried many long shots at him; have seen the snow fly, close to him, at times; but have never yet hit him. I have had to almost stand my old 40-90 Ballard on end to make it reach that far" (meaning he had to hold so high above the game).

Finally, after the old man had been after this sheep 2 or 3 months, he wrote again:

"Well, at last I've got the old Ellick! I've had a — of a time following him. I've grown 20 years older, and my hair has turned white, on the trail of the old Turk. How did I get him, you ask? Well, it was this way:

"I had been after him so long he seemed to have got disgusted with life—tired, poor, and pretty well worn out; so he did not travel so far, when I jumped him, as formerly; but would sneak up among the highest peaks and glaciers and hide. So I was able to get closer to him. Still, I could get only a glimpse of him; then he would be out of sight again. The only time I could ever see him standing was when he was safe across some great canyon, out of range. Then, as long as I would stand and look at him, he would not move; but the minute I undertook to make a sneak, or to back track, so as to make a circle, he was off. Then, when I got over near where I had seen him, he would be back on some other peak, near where I started from, looking for me to come up where he had been.

"Well, I got gray headed thinking how I could fool him. My partner hunted with me several days. Then he got disgusted and quit; for when 2 of us hunted, this old

ram would keep right on the jump and would travel clear out of the country without stopping; never giving us a chance to make a sneak on him.

"Finally one day, after I had travelled about 20 miles after him, always to see him just out of range, I was plumb worn out, and had about made up my mind to quit him. I was away up on a peak, sitting on a rock taking a smoke and looking at old Ellick. (I had named him 'Smart Ellick.') He was across on another peak, as usual, about 500 yards away, looking at me and taking a nip of grass or moss, once in awhile; but all the time keeping his weather eye on me.

"We had now got well acquainted and often entertained each other in this way. We had some nice social visits, at long range, but the ram was always very attentive. While I would rest and smoke, he would eat brush. When I got ready to go, he was always ready.

"Well, as I said, I was lying on the rock smoking and watching old Ellick. I noticed that when I would make a move, even to take off my cap, he would notice it; and a thought struck me. 'Now Ellick,' I said, 'I will just fool you once, for luck!' So I took out my hunting knife, cut a limb, made a cross piece and planted it on the rock. Then I took off my old blouse and my fur cap, and dressed up my scarecrow, keeping carefully behind it meanwhile.

"Then I rolled off the rock backward, out of sight, leaving old Ellick looking at my old cap and wondering, I suppose, what in the dickens I was doing. I went down the hog back, out of sight; got the wind in my favor, made a circuit and came up within 75 yards of old Ellick, and for the first time found him where I had left him.

"I have killed bear as big as a covered wagon, and never was excited; but when I saw that old ram there, watching the old coat, I was plum rattled. I could not have



A RECORD HEAD?

Circumference of horn, 18½ inches; length of horn, 52½ inches.

hit a buck Indian at 10 yards. All I could do was to lie there, like a tenderfoot, all out of breath, with just my eyebrows showing above the rocks.

"I lay there what seemed to me 3 days, watching that old duck, with my heart thumping like a woman's. I wish you could have seen the old cuss. The expressions on his face were a curiosity. Sometimes he looked as if he were afraid. Then again he looked mad, and seemed to be frowning about something. Then he would get impatient. He wanted me to come on, I guess. Again he would take a good, long, steady gaze, as if saying, 'what in the — is the matter with that tenderfoot? Has he gone to sleep? Or is that really he? He has not moved for 2 hours. He must be dead.'

"I was worse scared than a squaw. I was afraid to shoot, now that I had a chance, for fear I should miss him, and for the first time in my life I wished for one of those guns that has a reaction business, full of cartridges. I would not have cared if the — thing did blow up, so I killed my sheep.

"Well, I finally got my second wind. The old Turk was getting uneasy, as though he had about made up his mind it was not

I over there. I slid the old crowbar quietly, inch by inch, up over the rock, and put the stock in the middle of my breast. I was lying flat on my belly, and could not move my shoulder or raise above 2 rocks I was wedged into. It was an awkward position to shoot in, but I dare not move. I got the sights lined up on his right shoulder, and before I pulled I looked several times to be sure I was right. Then I let her go.

"When that old crowbar went off she almost made a consumptive out of me, by crushing in my chest. I was so wedged in that for a minute or 2 I could not get up, nor see anything; but when I finally pulled myself out, old Ellick was there all right. He was kind of pushing around, but was hit in the right place, and did not need any more.

"I went up to him and said, 'Well, old pard; you took me for a tenderfoot did you? And you got left. I put up a cold deck on you I know, and played you a crooked game, but I can't climb over these hills all winter for nothing. I have got to have a grub stake and Sheard is offering a big price for horns like yours.'

"I tried to excuse myself for playing such a dirty mean trick on the old cuss;

but it was no use. I felt as if I had slipped up and shot a squaw in the back. When I looked him in the face, as he lay there with his big eyes staring at me, he seemed to say, 'Old pard, I never thought you would take a mean advantage of me, like that.'

"And I tell you, now, I felt worse than a horse thief. I would have given a whole lot if I could have had that shot back. It seemed as if I had killed an old partner of mine, for his money. I have killed lots of

buck Indians, and never cared about them, but am superstitious, and should be afraid to use the money this head would bring, after all; so I shall not sell it unless I get broke and need money, bad."

\* \* \*

Four years later this man was killed in a snow slide, and Sheard bought the head from his partner. The horns measure 18½ inches in circumference, and 52½ inches in length, around the outside of the curve.

## MY TWENTY-TWO POINT BUCK.

F. D. HULBURT, M.D.

My youth was spent where game was plenty; so at an early age, a fondness for hunting was acquired. Many happy days were passed in rambling through ravines and over hills. Even now I recall the feeling of pride with which I would return home with my quarry, the result of a long and toilsome tramp through the woods with the old muzzle-loading gun. The time finally came, however, when I must leave the farm, with its pleasures, to pursue my studies in a distant city. The old gun and its accoutrements fell into other hands and I have never seen them since. Although actively engaged since I left the old home and farm, I have never quite succeeded in ridding myself of an occasional desire for an outing in the woods—a longing for the favorite pastime of my boyhood days.

In response to this feeling, in October, 1896, I arranged for a few days' absence in the Northern pine-lands, for a deer hunt. The men with whom I had intended to go, went at a time when I could not leave, and were in a place not easily accessible without the loss of valuable time. The open season for deer would soon expire, so I decided to strike out alone for a hunting-ground that could be reached in the shortest time.

I arrived at Solon springs, October 28, and at once made inquiries for a guide. I found none, however, for they were all out hunting. I was a stranger there, but the station agent finally came to my rescue. Sixteen miles from town, he told me, a half-breed lived in a good game country. I might secure accommodations there.

Acting on this hint, and being willing to undergo almost any hardship for a few days' good hunting, I began at once to look for a man to take me out. After some delay, one was found. We arrived at the half-breed's about 4 p.m. The house, made of poles covered with bark, was in a wild forest region, near the bank of a stream.

As we approached the dwelling, women and children appeared at the door, with evident surprise. The mistress told me her husband was not at home and would not

return until night. She was reluctant about taking me as a boarder, offering no encouragement to my entreaties. I was confident, however, that as soon as the man should return, it would be all right.

Not wishing to waste any time in getting

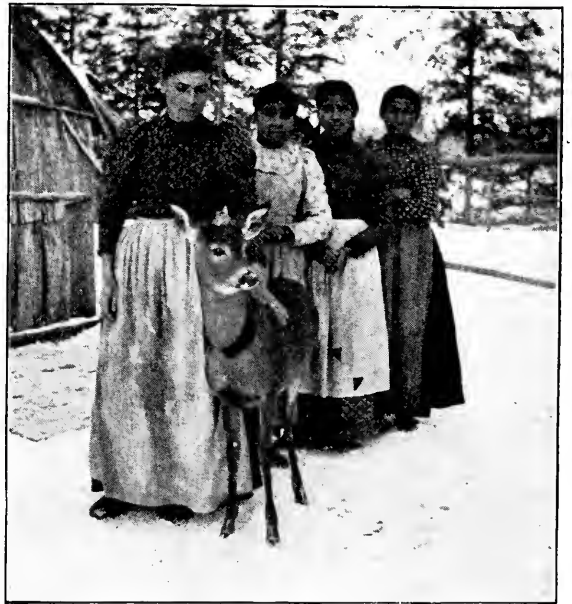

"A FAWN HAD BEEN CAPTURED BY ONE OF THE GIRLS, AND WAS THE PET OF THE WHOLE FAMILY."

located, I told the teamster to unload my baggage, and return to town. After getting permission to take my trunk into the house, I unpacked it. The woman and daughters crowded about to see what it contained. Besides my rifle and hunting outfit, I had brought along a liberal supply of tea, coffee, sugar, dried fruit and canned goods. As these were taken out, it soon became evident I was winning the good graces of my new acquaintances. They tasted the tea and sugar, sampled the prunes, and with evident delight carefully examined each package.

At dusk the half-breed returned. For a



short time he was sullen and disposed to act ill-tempered at my intrusion. He soon mellowed, however, and became social, finally assuring me I would be welcome as long as I wished to stay. He told me I should find fair hunting in the locality; deer were often seen near his house. He would be busy for a day or two, but in case I were unsuccessful, he would go out with me. He cautioned me not to go too far away, saying, "Stranger easy get lost here."

During the evening my host entertained me by relating Indian legends, tales of adventure, and incidents of hunting life. When bed-time came, deer-skins and blankets were spread out on the floor. I was assigned a place at one end of the small one-roomed shanty. I had my own blankets, and after rolling up in them, announced myself ready for sleep. The others soon went to bed. A fawn had been captured by one of the girls early in the summer, and it was the pet of the whole family. The little animal was tame, and at evening was let into the house. It would then nestle down close to some member of the family for the night.

As we all lay stretched out on the floor, I no longer regarded myself as an intruder, but felt I had really been adopted into the family.

We were up by daybreak. After breakfast, I started into the woods. I traveled Northward, finally reaching a well-worn game-trail. This I slowly followed, winding through the dense forest, until nearly a mile from the cabin. After ascending a small hill, I sat down on a log, near the trail, to watch for game.

The morning was lowering and gloomy. In a short time rain began to fall, and I shifted my position to the sheltering boughs of a balsam. The wind moaned through the treetops, sending a melancholy wail over the land, and the scattering drops of rain fell through the overhanging boughs. As I sat there in meditation, a tall dead tree, that had withstood the blasts of many years, but which was now weakened with decay, toppled over, and fell with a crash. A deer, startled by the noise, sprang from its bed near by, and came bounding toward me. It was a buck with a fine set of horns.

So nearly was his course toward me, that for a moment I wondered if he were not mad, and was really charging me. When he reached the foot of the hill—less than 60 yards away—the old fellow stopped under cover of a small hemlock tree, turned partly around and looked back, as if to see what had alarmed him.

Now was my chance; but my heart was beating sledge-hammer strokes. Slowly the rifle came up, and as the front sight showed against the shoulder of the deer, my finger pulled convulsively. The buck went down with the report. After making a few frantic efforts to rise, he rolled over. The 300-



"THE TROPHY IS A GREAT ATTRACTION TO MY LITTLE SON."

grain bullet had entered the shoulder, passing out at the base of the neck, on the opposite side.

Although I regarded my success as being due more to good luck than to skill, I could not but feel pleased; for my buck was the largest I had ever seen. The antlers were exceptionally well-developed, having in all, including the anterior projections at base of horns, 22 points.

I finally succeeded in hanging my deer on a bent sapling. After disembowelling him, I started to return. The rain had now changed to sleet and snow. When I reached the cabin, the half-breed had also come in.

Late in the afternoon, despite the weather, we went out with a pony and brought in my buck. I now began to think of home, for I was satisfied to quit. A bargain was made with the half-breed to take me to the station. Early the next morning the ponies were hitched up, and with baggage and buck we rode to town. Arriving at the station, I at once weighed the deer—287 pounds, the scales showed. The head was then shipped for mounting.

The trophy is a great attraction to my little son, who occasionally takes an imaginary deer hunt on his father's lap.

For those whose tastes turn toward the chase, it is hoped that the picture of the mounted head will revive old memories. It may serve to recall pleasant associations and fond recollections of some camp-fire long since gone out; or to render more vivid the reminiscences of a pleasant outing in grand old forest regions, where nature charmed and hearts were free from care.



## THE FIRST DAY OF THE CHICKEN SEASON.

A. B. COWIE.

The persistent whirl of my alarm clock finally brought me to a proper realization that it was the morning of the long awaited day—the 1st of the chicken season in Minnesota. I had been elected to awaken the other members of our party, to get them on the road by 4 o'clock. There were 4 of us: the Mayor and the Postmaster, 2 veteran chicken slayers; the Doctor and I, both young and green at the business.

A mist was falling when I got out of the house, which gave me great joy; for I had heard that something of this kind was needed to make it easier for the dogs, on the 1st day. After I had awakened the veterans, I went to the depot to meet the Doctor, who was to come on the 3.20 train from St. Paul. The train was an hour late.

During that hour, I received more abuse, and was threatened with more kinds of deaths than ever mortal was before; and all because I asked an operator a few questions, and got 2 sleepy hunters up a few times to see that it was clearing. It finally did clear; the train came and we started; the Postmaster and the Doctor, with the former's Irish setter, Pat, in one rig, and the Mayor and I, with his Irish setter, Crank, and his pointer, Teddy, in the other.

The slaughter was to take place on the great flats, as they are called, between Rothsay and the Red River of the North. We had just reached the Eastern margin of the flats when one of the dogs, ranging ahead, showed signs of game. In an instant the veterans were out and following their dogs closely. Soon a chicken rose, almost out of range. The Postmaster tried one charge from his repeater, but never touched it. I saw the Mayor smile, as the bird sailed away. He told me, on the way out, he did not like to hunt with the man with the repeater on the 1st day, because "the cuss always shoots as well on the 1st day as the last; while I can't hit anything." That was why he smiled at the miss.

We were all out now. A few stray birds got up, and it was my turn to smile when the Doctor missed an easy shot. We soon decided this was not the kind of hunting we were looking for, so moved on. Soon we came to one of the "very places." It was a swale covered with green grass, while on either side was a narrow strip of wheat stubble. The Postmaster and Doc followed one strip; the Mayor and I the other. After going some distance, Ted took a

back tack and located a small covey. My fat companion got 1 bird, and I tried to get another, but failed.

The other hunters were now ahead of us, coming up on our side of the swale. When they were within about 40 rods, Pat found a scattered covey. To their disgust and our amusement, the gunners wasted several charges without getting a feather. We saw them look curiously at each other and then move on carelessly in our direction. Suddenly a bird got up between them and flew toward their rig. Doc raised his slaying machine and was about to fire, but hesitated for fear of shooting the horse. The Postmaster, however, was getting desperate, so blazed away, missing the bird, but hitting the horse. The animal was too far away to be injured, but near enough to be well stung. He wheeled around, nearly upsetting the buggy, and started for home at a brisk trot. His owner took after him, yelling: "Whoa, whoa," in a voice that would have stopped a coyote.

Fortunately, a haystack was right in the line of flight, and the animal decided to sample the hay before going farther. He had cause to regret this, or the run, or something else, for he was treated to a sound flogging when the irate Postmaster caught him. We drove down to congratulate the Doctor on his skill in sending so many charges of shot into the air, and were making it generally pleasant for him, when our friend returned with his horse. We showered congratulations on him, also, for his good shot and his big game; but he did not seem to appreciate it.

To our surprise, a bird got up within 2 rods of one of the rigs. By some accident my gun went off and the bird dropped. Then our fun commenced. The Mayor and I each had a bird, and the other boys not a feather. We made it interesting for them for a while, giving all kinds of advice; which they tried to laugh away.

They finally left us, and we did not see them again until the noon roundup. Then we found they had nearly as many birds as we, and were therefore inclined to be sociable again.

Though the chicken crop was light, we returned in the evening with 27 birds in one rig and 24 in the other. The Doctor was happy because he had beaten me by 1. Now, when we want to make the Postmaster very tired, we ask him if he ever shot any large game.



AMATEUR PHOTO BY F. E. MATHEWSON.

#### A FRIENDLY HAND.

Winner of Eighth Prize in RECREATION'S Second Annual Photo Competition.  
Photo made with a Universal Camera, fitted with a Baush and Lomb lens, on a Cramer plate.



AMATEUR PHOTO BY H. L. CHRISTY.

#### AT THE FOOT OF THE PASS.

Winner of Ninth Prize in RECREATION'S Second Annual Photo Competition.



AMATEUR PHOTO BY SERGT. WM. H. VAN BUSKIRK.

**WE'RE HUNGRY.**

Winner of Fifteenth Prize in RECREATION'S Second Annual Photo Competition.



AMATEUR PHOTO BY SERGT. WM. H. VAN BUSKIRK.

**BREAKFAST FOR SIX.**

Winner of Twelfth Prize in RECREATION'S Second Annual Photo Competition.



COPYRIGHT, 1897, BY WRIGHT & CARLIN.

TREED.

## GOOSE SHOOTING IN COLORADO.

W. E. KING.

Colorado affords as fine a field for the lover of sport with the gun, as any part of the country. Geese, ducks and other kinds of feathered game are plenty; though of course the range of wild fowl is limited.

Now I have a friend who is a thorough sportsman and a fine shot; and when we heard of a field, some 12 miles from town, where the Canada geese were accustomed to feed, we determined to bag a few. They came in from the South Platte river every morning; so we laid our plans accordingly. We left the town of Sterling at 2 o'clock one afternoon for the ranch of a friend, near the feeding ground of the geese.

coming up from the West, right over us.

Rising quickly, we turned our guns loose. After the rattle of smokeless powder was over, we gathered 3 birds. One struck 200 yards away.

The large flock, unsuspecting of danger before, turned at our shots, lighting with the 2 out on the prairie. We had to wait only a few minutes when we had another shot, this time bringing down 4 birds.

The flock from which we killed these also joined the geese on the prairie.

I suggested going out and flushing them, for they would go back to the river; but

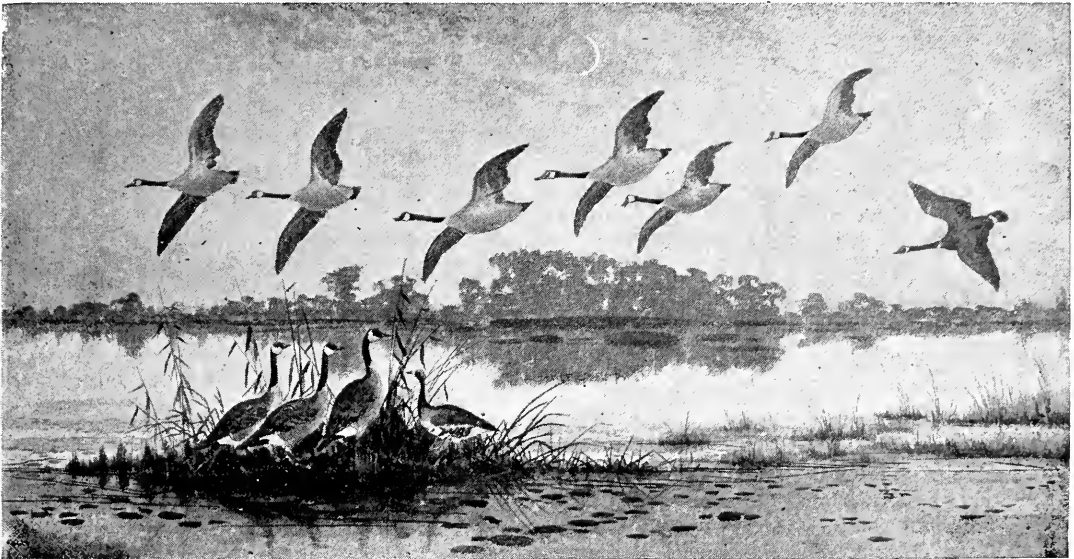

BY COURTESY OF "THE PROFESSIONAL PHOTOGRAPHER."

"THE LARGE FLOCK TURNED AT OUR SHOTS."

From a Painting by Chas. A. Zimmerman.

On our way down we killed 11 ducks—brown-heads and mallards. Arriving at the ranch, we put up for the night.

The next morning we made an early start for the stubble field, reaching it by daylight. My companion placed the decoys, 30 in number; while I gathered weeds and straw to make a blind. This was built in an irrigating ditch near the middle of the field. Before our blind was finished, 2 geese were seen coming. Of course they saw us and turned while well out of range; but lit some distance away on the prairie.

The blind and decoys were hardly arranged when we saw a large flock outlined against the Eastern sky. Yes, they were coming toward our field. We hugged the ground closer and lay securely hidden, listening to their loud and familiar "honks." In a few minutes they would be in range. Suddenly we were surprised by 6 geese

later in the morning would probably return to the field. I scared them up, and had barely returned to the blind when we saw 3 birds coming directly to the decoys. Of these we got one each. The 3d, frightened and squawking, came circling around, trying to locate its companions. Within easy range we fired a volley that almost made the ground tremble; but every shot was a clean miss. The frightened bird, shaking its tail as if bidding us a long farewell, made its way safely back to the river.

We remained in the field until 10 o'clock, but the first flocks did not come back. As the flight was over, I started to gather up the decoys and birds, while my friend went for his buggy to haul them in. We did not care to pack such a load to the ranch.

With 9 geese and 11 ducks, we were satisfied to start homeward. On reaching Cedar creek, we gathered in 5 more brown-

head ducks. All considered, we were well satisfied with our trip.

We both used Dupont smokeless powder with number 1 shot for geese, and 5's for ducks. My companion shot a Greener, while I used a repeater.

When the geese were dressed, we found some of them had been hit with as high as 13 shot, many going through the bodies. This speaks well for the penetration secured with smokeless powder.

## A GOOD INDIAN.

NELSON YARNALL.

Chief Washakie was born in the Flathead valley, Montana. His mother was a Flathead, but his father belonged to the Shoshones. The old chief has always been reticent about his age.

"The Indian," he would say, "has no means of keeping the snows that have gone, as the white man has. My years have gone with the snows."

However, judging from his early associations with the once famous guide and scout, "Jim" Bridger, he was probably born about the year 1810.

Of his earliest recollections, he says: "The first white man's money I ever had I earned when a young man, herding ponies for a party of trappers. I worked for those men one snow and until the water was high. Then they started in the direction of the rising sun. They said they would return when the leaves began to fall. I agreed to meet them at the place where we parted.

"My father tried to persuade me not to go with the white men again; but my first experience with them was so pleasant I had determined to go. I had learned to eat the white men's bread, and drink their coffee, which I liked very much. Then they had promised to bring me a gun.

"The trappers returned and I met them at the place appointed, which was on the Green river. They brought my gun; and I liked them so well I promised them never to go on the war path against white men, and to try to prevent my people from doing so. This promise I have always kept.

"The trappers also brought a lot of beads, needles, thread, calico, paint, powder, caps, and a few guns, to trade with the Shoshones. Most of the work I did that winter was to bring in parties to trade with the trappers. This I liked very much, as I had a good gun, and the trappers had given me a pony to ride and one to pack.

"When I told my people how good my new friends were, some of them, who had never seen a white man, visited the trappers with me."

It seems the Indians looked upon Washakie as a leader, even when he was a young man. From this time he made war against other Indians—principally the Blackfeet

and Grosventres. He says, in connection with his first attempts at war:

"I had a good gun, and all the young men of my tribe followed me, because I could shoot farther than they."



CHIEF WASHAKIE.

From a photograph kindly loaned by Mr. Chas. F. Fish.

In speaking of the trappers again, he said: "When they went away and returned again, there came with them a young man, about my age, who could ride and shoot well. We were soon good friends, and were together most all the time. He loaned



me traps, and showed me how to set them for beaver."

This young man was Bridger. Washakie's friendship for him was deep and lasting. He still carries his old friend's photograph, on a cord about his neck.

The young chief's time was divided between acting as agent for the trappers, and in making war against the Blackfeet and Grosventres. This continued until about 1850.

"I was camped with part of my tribe on the Sweet Water," he said, in recalling this time, "when Bridger, with a party of white men, came to my camp. He asked me to go to Fort Laramie. The white men wished me to sign a treaty of peace with the whites, and with all other tribes of Indians. I was not then head chief, but was made so the next day. Yellow Hand, who was then head chief, refused to go with Bridger, but I, being anxious to make a treaty, decided to go.

"On the following morning, I rode through the village, telling the Shoshones what I intended to do, and asking them to follow me. Then with Bridger I started in the direction of Laramie. Before night nearly the whole village had overtaken me, and I was declared their chief. This pleased Bridger's party so well, they made me and each member of my family a present of a blanket.

"When we reached Laramie, I found a great many men, all dressed alike; when they stood up in a row they all looked alike. Bridger told me these were the fighting men, and were called soldiers. He said the noise they made with the yellow horns was a sort of language, by which they received orders while fighting. They belonged to the great father at Washington. This greatly impressed me; I had never before seen a soldier.

"There were many Indians also: Sioux, Cheyennes, Arapahoes, Crows, Grosventres, Blackfeet, Utes, and others. The good things on the wagon train, Bridger had told about, had not arrived. After waiting a few days, we moved down the Platte river until we met the train. Then all went into camp, and the good things were unloaded on the prairie, and divided among the different tribes of Indians."

Washakie's surprise at this display shows how little the Indians then knew about the Government.

"We had no idea," he said, "that the great father at Washington was rich enough to load a whole train of wagons with good things and send it so far to meet us!

"After the things were divided, the head

men of all the tribes, with Bridger and his party, signed a treaty of peace never to fight among themselves, against the great father, nor his people. The big council then broke up, and all the tribes went back to their own countries."

It is Washakie's proudest boast that out of all the Indians who signed the treaty, he is the only one who never afterward raised his hand against a white man.

Washakie has done good service for the Government, and has always been a strong ally of our soldiers. He fought with them against the Arapahoes in 1874, and again with General Crook against the Sioux and Cheyennes in 1876. His counsel was sought in troublesome times and his advice always respected.

While encamped on Goose creek with General Crook's army, in 1876, a council was called by the General. Washakie's advice was asked as to the best manner to attack the Sioux, who were then encamped on the Little Bighorn. After looking over the General's army, Washakie frankly said: "My friend, you are not strong enough to fight the Sioux that are now collected together. You may brush them off for a time, as you would mosquitoes, but they will keep returning until they devour you. I advise you to send for more soldiers."

A council was called, and while sitting in the same place, on the following day, 3 men rode up with a report of the Custer massacre.

"Ah, I told you yesterday you were not strong enough to fight the Sioux," said the old chief to the General. "Had you been there you would have gone as they did."

Washakie's advice to other Indians during the last troubles with the Sioux, when all the Indians were crazed with "ghost dances," probably saved the country from a terrible war. Runners were constantly arriving from all the Western tribes; from the Southern Arapahoes, Comanches and Kiowas, trying to induce the Shoshones to join in the war. The chief's advice to them was always the same: "Go back to your country; go to work, and try to make a living. I long ago made a treaty of peace with the white people, and I shall keep it while I live."

If the Shoshones had listened to the runners and joined the Sioux, the Utes, Bannocks, Arapahoes, Crows and others would have followed.

As the old chief is now growing feeble, it would be a kind act of a grateful Government to provide for him during his few remaining years.

# An Up-to-date FISH STORY

It was one bright summer morning,  
I'll ne'er forget the date —  
We sat beside the river  
With our fishpoles and our bait.  
Her first attempt at catching <sup>fish</sup>  
But not at catching hearts —  
And tho' awkward with her fishpole  
She was free with Cupid's darts.

~~~~~  
She fished for me instead of fish  
Sweet smiles she used for bait;  
And on that sunny morning  
I nearly met my fate.

'Tis true she nearly caught me  
With smile and roguish look,  
But I like many other fish —  
At last jumped off her hook.



H. P. Bigelow - 97.

## THE RENTED BICYCLE SUIT.

WALTER I. SHAY.

"Let's take a spin down the gulch, as far as the junction and come home on the train," said my friend Walters, as we sat in front of his shop, one afternoon last summer.

"Just the thing," I assented.

"Well, let's start as soon as we can get ready," he continued, "because," with an expressive wink, "we might have to stop for repairs, and it would never do to miss the train." I fully understood what he meant by stopping for repairs. Widow Schaefer's ranch is about half way between Martinsville and the junction, and the widow's eldest daughter, Kate, would be the cause of the probable stop for repairs.

"All right," I answered, "I will have my wheel here in 15 minutes."

At the appointed time I was back, with my wheel, but Walt was ready and waiting for me. He is a favorite with the fair sex, and on this afternoon, clad in a new bicycle suit, he would have made a first class picture for a bicycle ad.

Away we went, and a most delightful ride lay before us! Martinsville is a mining camp, in the heart of the Rocky mountains. It is 15 miles, by rail, to the junction; but by the wagon road which, for the most part is excellent, the distance is but 5.

As we passed the last saloon, in the lower end of the town, and got on the grade I noticed a 4 horse team hitched to a wagon with an empty hayrack, standing beside the road.

"Old Ford is inside, investing the proceeds of his hay in stomach tonics," I remarked. But, just at that moment, Walt was busily engaged in guiding his wheel with one hand, using the other hand in tipping his hat to a lady acquaintance.

"Great riding, isn't it?" he said, as with our feet on the coasters, a firm grip on the handle bars, and sitting well back, we began to skim down the grade at an increased speed.

"Indeed, it is great," I answered, and, putting one foot between the front fork and the tire, I began to slacken up our increasing pace.

Ah, fellow wheelmen, that was what you would call riding. On either side of us rose the lofty walls of the canyon; up, up, like majestic sentinels, while before us spread the grade like a huge anaconda, now dipping, now turning; and far ahead the smiling little valley spread out like a huge painting, with a back-ground of gold. "Click, clack, click, clack," said our cyclometers. "Burr, burr," echoed the rapidly revolving pedals, while our easy, breezy, motion was one a lark might envy.

"Let us slacken our pace a little," said Walt, "we're nearly to the saw-mill turn."

The road for the next 2 miles was graded into the mountain side; while on the lower side it was a sheer drop of 30 feet to the little mountain stream that was dashing merrily along the bottom of the gulch. We slowed down, and had just made the short turn, when I heard a rumbling in our rear. Walt must have heard it too, for he remarked that old Ford must be coming along behind.

"Well, he must have got a decided move on those horses," I said, "for we have not been losing any time ourselves, and we passed him back at John's saloon."

But heavens! That rumbling was drawing nearer, with lightning rapidity. We looked back, and, horrors! What a sight met our astonished gaze. Just turning the short bend, 4 infuriated horses were bounding down the grade like fiends and behind them the wagon and the great, empty hayrack were swaying and tossing from side to side, while the noise it all made was like the roar of the Yellowstone falls.

"What's to be done?" we both cried at once. There was but one thing to be done, and that was to go. The team was so close to us it would have been next to impossible to slacken our pace, and jump. Besides, what good would it have done to have jumped off the wheel's? The bank on the upper side was at least 10 feet, straight up, and it would have been madness to attempt to jump down that 30 foot grade into the stream below.

Acting with one impulse, we took our feet off the coasters and caught the pedals.

"Hit them hard, as long as you can hold them," I yelled, "and then let her coast for all she cost."

We pumped as hard and as fast as we could; then again got our feet on the coasters and away down the grade shot our wheels, while behind us, coming like a cyclone, were those crazed horses hitched to that great wagon.

Talk about your Tam O'Shanters! The gait we made, in that awful race, would have left him at the post. We were cutting through space like a cannon ball, yet that awful avalanche of horse flesh, iron and wood seemed to be gaining on us. For the next mile or so, the grade was of the same character as where we started the race; now dipping a little, now turning a little, but not one single place where we could turn out. Great God! I thought; if we were to meet a team or a band of cattle! But my thoughts on this line were cut short in my efforts to keep my flying steed of



H. J. WATSON

"FOUR INFURIATED HORSES WERE BOUNDING DOWN THE GRADE LIKE FIENDS."

steel under control. I glanced across at Walt. His set face had the right look in it. That awful clatter, clangor, rumble, rumble, sounded as loud as ever. And how we did go! Every now and then we broke just a trifle, just enough to keep our wheels under control; while the banks, the grade, and the gulch bottom seemed like one rapidly revolving blur.

We finally passed the last bad turn, and I hoped the hayrack would tip there, for I had not seen old Ford on the seat. The road from here on was not so dangerous though the grade was equally stiff. "I don't wish old Ford any ill luck, but I hope that old concern will go into the river," yelled Walt, through his clenched teeth. But old Ford was not on, as we found out later. The team had started of their own accord, and the brake was knocked off the first jump they made.

"Stay with her," I yelled back, for my oiled Victor had been forging ahead of Walt till I was now 15 or 20 feet in the lead.

"If we have good luck until we get to the forks, we are all right." We knew once we were at the forks, we could turn on to the old wood road and let the team go on down the grade. But now the water in my eyes began to trouble me. It "was coming out in chunks," as Walt expressed it afterward. This awful clip was telling on us, and we were now within a half mile of the forks.

"Slack up a trifle before you get to the forks," yelled Walt, "or you can't make the turn." "All right," I answered.

RECREATION came very near not getting this story; or at least not from my pen, for Crash! went my front wheel against a rock that had rolled down from the bank. Like a streak of forked lightning, my wheel darted from side to side, but with an intuition that we find often comes to us, quicker than thought, I had her righted again. I recovered my breath and looked over at the front wheel, but could see nothing wrong. Walt was up even with me again.

"A narrow escape," I muttered, more to myself than to Walt.

"I would call it a close shave," said he. The forks of the roads were in sight now, and we slackened up.

"I don't think I hear the team," said Walt. "Neither do I," was my answer. The fork was just ahead of us, and now we had slowed down to something like an ordinary fast clip.

"Thank goodness!" I said to myself, as I made the turn from the grade to the wood road. Walt was just making the turn. His foot went farther into the front fork than he expected, and up went his rear wheel like the subsequent end of a circus horse. Over and over went rider and wheel, landing high and dry on the soft bank of the wood road. By this time, I had dismounted, and was just starting to his assistance, when he untangled himself, and

dragging his wheel after him clambered up the bank to the wood road.

"Well, that was a hot ride, I'll swear," were his first words; and, perspiring like stokers on a steam-boat, we sat down on a log. Then, when we found we were out of danger we breathed naturally.

"I agree with you," said I; "it was certainly pretty warm the first mile or two."

"The horses must have taken a tumble or they would have been along before this," said Walt.

Regaining our composure, we examined our wheels. A piece the size of a lead pencil was stripped from my front rim, the result of my collision with the stray rock. But the wheel was as solid as before. Walt was not hurt; neither was his wheel, but there was a rent in the seat of his trousers, as large as your hand. I was about to tell him of it when a happy thought struck me. I would be revenged for his joke on me at the last lodge dance.

Finally the team showed up—coming at a slow walk. They had rounded all the turns safely, had run out their fright and were now simply going home. We pulled them out of the road and tied them up to await the coming of old Ford. Then I said:

"Come on, let's be moving," and away we went down the grade again, but with a far more comfortable feeling than before.

In a few minutes we were out of the gulch and at the widow Schaefer's. Invited to a seat on the front porch, a large, cool glass of milk, a chat about the runaway, and in the pleasant company of the young ladies time flew rapidly. Finally we arose, much refreshed, to continue our ride to the junction.

As Walt, with a polite tip of his cap, started down the path to the gate, for the first time the ladies noticed the rent in his trousers.

"Mr. Walters," said Miss Kate, "do you know that—that you might catch cold by having your clothing ventilated too freely? Goodbye," and with a mischievous laugh she disappeared in the house.

"I wonder what Miss Kate meant by ventilated clothing," said Walt.

"I am sure I could not say," I answered innocently, and changing the conversation he soon forgot her remark. The coasting part of our journey was now over, but for all that, we made excellent time, and arrived at the junction on the dot. Depositing our wheels in the baggage car, we sauntered into the local coach. Only a few passengers were aboard, and all these were Martinsville people. Fortunately we were all acquainted, and after a genial and general conversation about our trip, in which I did not forget to tell of Walt's fall, we were nearly home before we realized we had started.

Just before reaching Martinsville, I

turned the conversation to Walt's new bicycle suit.

"Did you say you wished a glass of water, Miss Dunne?" I remarked to one of the young ladies, who, by the way, was one of Walt's friends. Before she could reply, Walt, who sat nearest the aisle, gallantly rose from his seat, and started up the car to the water tank, leaving the rent very much in evidence, to my extreme delight.

Returning with the water, he could not comprehend the meaning of the half-concealed merriment.

"Yes, I bought this suit because I liked the color so well," remarked Walt.

"You bought it, you say?" asked Miss Dunne, with a smile, as she took the proffered glass of water.

"Why, certainly," answered the smiling but embarrassed young man. "How did you suppose I got it?"

"Well," said she, "judging by appearances, I—I thought you must have *rented* it."

"Martinsville!" yelled the brakeman, sticking his head in the door. And Walt never knew what she meant by a rented suit until he reached home and changed his clothes.



AMATEUR PHOTO BY MRS. H. L. DARLING.

"WHY DON'T YOU SHOOT!"

Winner of Tenth Prize in RECREATION'S Second Annual Photo Competition.

## MY LAST HUNT IN KANSAS.

GEN. F. W. BENTEEN.

During the winter and spring of 1871, I was stationed, as a Captain of the 7th U. S. Cavalry, at Fort Hays, Kansas. From there we were ordered across to the forks of the Solomon river; for the settlers in that part of the State had been somewhat unnecessarily stampeded.

On our first buffalo hunt, when *en route* to give the settlers surcease from imaginary sorrow, I shot, while running alongside of her, a fat buffalo cow. After getting the carcass ready to put into the wagon, it was

On arriving at our destination, we learned exactly what we were satisfied of before leaving the post: there were no live Indians in that section of country. Nevertheless, the folks were glad to have the cavalry around. To render assurance doubly sure, I had the forks thoroughly scouted; then started homeward by the route most generally taken by hostile Indians going Northward.

No Indian signs were seen save the dead fellows in the crotches of trees. These had



CATLIN, THE ARTIST, SHOOTING BUFFALOES.

found that the bullet from my revolver had gone through the animal and the forefoot of an exceedingly fine Russian mastiff. I had not noticed the dog running at the side of a buffalo calf, this was not at all strange. With a piece of old shelter-tent and some grease from an axle, we bound the mastiff's foot, gave him a drink of water from our canteens, and laid him with care alongside the buffalo, in the wagon.

A few miles from that scene, our dogs started an immense wildcat and drove it into one of the ponds, which in springtime abound on the plains. The cat was such a vigorous fellow we shot him—not caring to have any more of our dogs hurt.

become good Indians, and had started on the journey to the happy hunting grounds.

In the Saline river valley we ran into a band of not less than 400 elk. Such a time as we had running them down and shooting them from horseback, does not occur very often in one's lifetime. Our wagons, which had been pretty nearly emptied of supplies, were now about packed with the finest and fattest of buffalo, elk and antelope meat. None of it was to be wasted, for, as we were nearing the station, it would be divided among our less fortunate companions in arms, the infantry. They had fewer opportunities than we to add to their larder.

The last day, while approaching the line

of the Kansas Pacific railroad, I was out in front, hunting a "divide" along which the wagon train might easily roll, when I dropped into a bunch of antelopes. With my revolver I broke the left fore leg of the patriarch buck; which about knocked him out, as I thought. Not having another shot left, he could not be dispatched. I could easily ride him down, and with a sabre could have killed him; but could by no means get my horse sufficiently near to knock him in the head with the butt of my pistol. When the buck was well enough rested, off he would go, I after him. At length my orderly came up, but neither had he a round of ammunition. As the dogs had chased the wildcat into a pond, so we chased the antelope. Then he was seized by the horns, drawn out, and his throat cut. He was left by the pond for the wagon to pick up.

I wanted to get to the railway that night, to leave only a short march for the next

day to our station. By the time the road was reached it was dark; however, there was plenty of water in ponds, and grass was abundant. There were piles of ties along the railway, and with these we soon had a signal-fire going for the train of wagons. All of them, with the troops, were soon in camp.

The next morning I was somewhat disgusted to find in the pool that supplied us with water, a decomposed antelope. If you think such a "find" upset the even tenor of my way in any respect, you do not know the kind of stuff an American cavalryman's stomach is made of.

I know but one officer of the cavalry who is a survivor of that trip; and he, poor fellow, never knew anything of the glory of the chase. At least he was the only one the decomposed antelope affected; and that may have been to get a pull at our pocket-flasks—something he did not keep for himself.

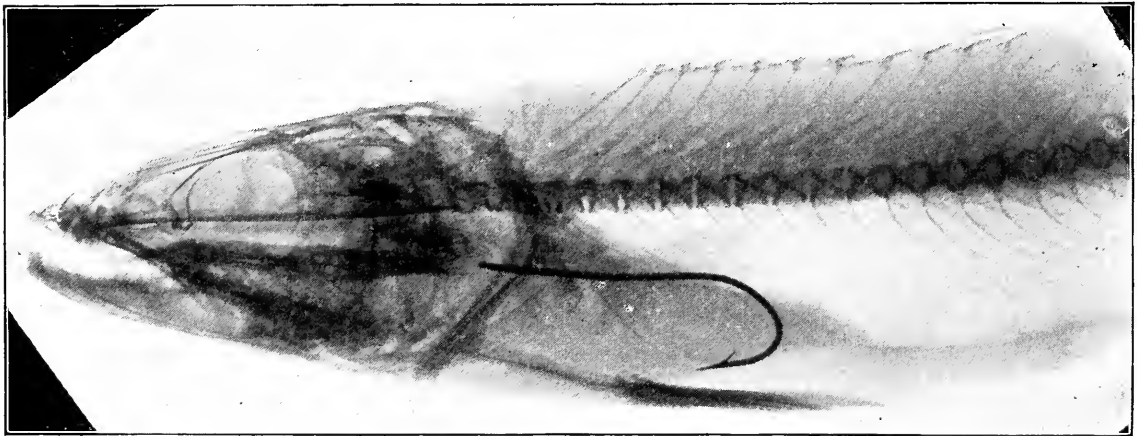

RADIOGRAPH OF WALL-EYED PIKE, IMMEDIATELY AFTER BEING TAKEN FROM THE WATER, BY WM. SCHUTTE.

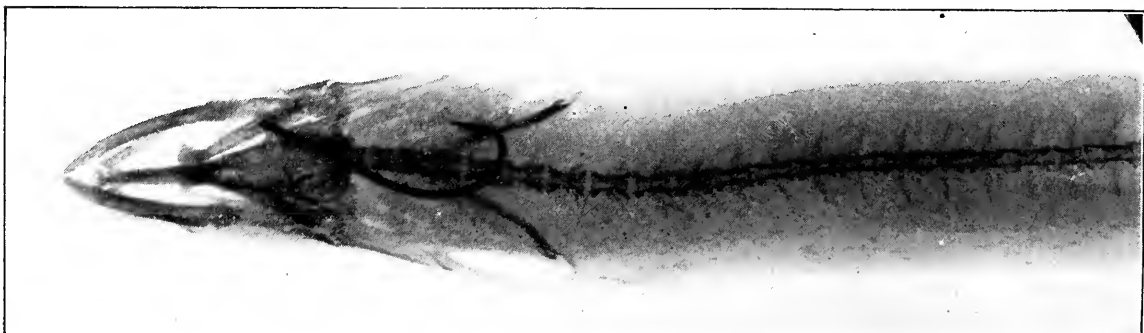

RADIOGRAPH OF AN EEL, BY WM. SCHUTTE.



## HEROIC FISHING.

For a number of years parties fishing for cod, near the Isles of Shoals, have hooked halibut of enormous size and several times these huge fish have been brought to the surface after a struggle of considerable length; but until last summer no one had succeeded in landing one. The principal trouble seemed to be that the teeth of the fish chafed the snood off; though sometimes the line itself was parted in the first mad rush of the halibut for liberty.

of the Oceanic Hotel, and it was here the halibut was caught. The boat was one of the regular fishing boats of the fleet connected with the hotels, about 30 feet over all and well adapted to deep sea fishing.

The line used was a new and extra large cod line, 60 fathoms long. The depth of water at Little Ledge is 30 fathoms and Mr. Ilsley's halibut ran out the whole length of the line 5 times before he gave up the struggle.

This is said to be the largest edible fish ever caught on a hand line.



HALIBUT.

Weight, 356 pounds. Caught at Isles of Shoals, N. H., Aug. 18, 1896.

For several successive seasons Mr. G. L. Ilsley and his cousin, Mr. C. H. Merrill, had tried to bring in a halibut, and while they had no difficulty in hooking them they could not succeed in landing one.

After one or 2 unsuccessful attempts, in the early part of the season, Mr. Ilsley decided to try a wire snood.

His first attempt was an entire success, and after an hour's fight he had the satisfaction of seeing the magnificent halibut, shown in the cut, alongside the boat. After the skipper had despatched the fish, it was hoisted aboard. It weighed 356 pounds and was 8 feet long. The picture represents Mr. Ilsley and the skipper, Joe Hooker, standing beside the great fish.

Little Ledge is the name of the favorite fishing grounds patronized by the guests

A few days later, Messrs. J. D. and D. N. Green, with similar tackle, landed a halibut weighing 270 pounds, with same skipper and at same place.

J. K. Manning and Dudley Hall captured the third and last of the season. Its weight was 221 pounds.

Great interest was aroused in the sport, and some of the best known fishermen in the country have signified their intention of trying their skill with these monsters of the deep, during the coming season. As a sport halibut fishing equals tarpon fishing.

When the wife goes chasing bargains,  
Hubby wouldn't grudge the pelf,  
If she'd only buy such misfits  
As she hankers for herself.



## THE COWBOY'S VERSION OF THE PRODIGAL SON.

It was at the Camp Fire Club. We had had our beefsteak and coffee, and story telling was in order. Captain Jack, the "Poet Scout," was introduced, and, among other choice bits of Western oratory, gave us this:

More than 40 cowboys had gathered, from every direction, to hear Poney Bill, the only sinner-herder on the range "jerk his jaw on pious talk," as one of the boys expressed it. After the cowboy quartette had sung "Rock of Ages" and "Nearer, my God, to Thee" Poney Bill read a selection from the Prodigal Son, and then said:

"Boys, it makes my heart dance and cavort around as joyful as a spring calf on a June mornin' to see so many of ye here to-day. It don't mean that because I'm the only sinner-herder on the range you put me up for a curiosity and sail in here, from all quarters, to take in the percedens, like you would a circus. No, it don't mean that. Well, then what does it mean? It means that you've bin thinkin' over matters an' hev come to the conclusion that it are foolish to hang on to the ranges of sin while the pastures of the good Lord is afore ye, invitin' ye to come in and feed to your fill on the never failin' feed of righteousness.

"Boys, the Bible story I just read to ye is a touchin' one; and one that I hope has corkscrewed its way into your hearts. Here we see a young feller, a mere kid, possessin' all the comforts of a happy home. He had kind, indulgent parents; wore nobby clothes; was a fav'rit in society; in fact, he had everything the heart could long for, an' yet he was dissatisfied.

"His wild broncho spirit wouldn't be curbed by the bit of wisdom, and by some hocus pocus he made a successful play on the old man and induced him to whack up his share of the boodle, ahead of the sot time, and to let him go forth to see the world. We next hear of the kid in the gay palaces of sin, blowin' in his dust like a thoroughbred and paintin' everything red. Every day he stuffs his pale hide with booze, and every night he goes to bed a whoopin'.

"Women whose eyes is like the light of the sunbeams, but whose hearts is as black as the night, caresses him and sings to him the song of the Syrens: while they sips the costliest wine and eats the daintiest grub, for which Prod's called on to put up the boodle. He soon goes dead broke on this racket, and then what's the result? His good clothes is in soak; his diamonds is in soak; and his late angelic companions is smilin' at his greenness and lookin' out for another sucker. And the once petted

darlin' of the East is ekin' out a miserable existence herdin' hogs on a Jonah ranch, and afoot at that.

"Boys, jest close your eyes for a minute and take in the picter of that poor boy. It's to be supposed the outfit hed run short of grub allowance and that Prod was so hungry he'd 'a bin glad to get down and rastle shucks with the hogs ef he'd bin built for chewin' that kind o' truck; but he wasn't. As he sits thar on the corral fence he begins to take stock of his condition, and he ses, sorta talkin' to hisself, like:

"'Thar's lots o' room at the old home ranch. Thar's lots o' grub in the cellar, and dead oodles o' cash in the treasury. I can stand in with all this agin if I'll jest make a bold play, an' ask to be taken back—not as a son, but as an ordinary hired man, at reasonable wages.'"

May be the old man would run him in for vagrancy; or set the dogs on him; or meet him with an armful o' clubs; but it didn't matter. The spirit of the Lord was a workin' in Prod's soul and he finally giv' the hog ranch the shake and lit out for the ole homestead.

"When he was a long ways off the old man happened to be out lookin' after the stock and he saw a figure approachin' acrost the prairie. He shaded his ol' eyes with his hands as he said, 'Thar comes some poor, sore footed wanderer. Mebbe he's lookin' for a place to lay his head and somethin' to satisfy his hunger. God knows but my boy may be in the same fix to-day, an'—an'—Why! that looks like my boy. He's got my boy's gait; he swings his hands jest like him, an'—Why! 'tis my boy!'

"Did the ole man pick up an armful o' clubs; or call the dogs; or think up a lot o' cuss words to hurl at the approachin' prodigal? No. The Good Book tells us, he met him with arms wide open. He hugged him till he saw stars; an' he kissed him; and then he tuck him in the house, togged him out in store clothes and yelled to one o' his herders to round up a bunch o' cattle, corral 'em; cut out the fattest calf in the outfit and kill it quick; for says he, 'We're goin' to have the grandest jubilee blowout of the season. The lost has bin found and the wild, reckless boy that was dead is alive agin.'

"And boys, that was the grandest night that was ever spent around that old home ranch.

"Now, boys, do you know you are a lot of fool prods? An' the first thing you knows the devil will get a rope on to ye: your feet will be snatched from under ye; he'll put his pitch fork brand into ye, and throw ye into a corner, where the temper-

ature would knock the tar out of the thickest hidid burro. The devil's got his herders out, all the time, a lookin' up stray stock and runnin' 'em towards the corral of perdition.

"Some times you see 'em behind the bars of saloons, and they'll meet ye with a good natured friendliness a shootin' out o' their eyes. Sometimes you see 'em behind the green covered gamblin' table, wearin' good clothes and big diamonds; but they're all herders o' Satan, an' you fool maverick cowboys knows it jest as well as I do; for you've all bin thar, en so have I. But thank God, a rider from the big home ranch

above got a rope on me—a rope o' salvation—an' he put on my soul the brand o' the Redeemer.

"Now boys, why will ye waller in the mire o' sin while the pastures o' the good Lord is afore ye?"

"Why don't ye take stock o' your condition, as Prod did, and giv' the devil's den the shake; start for the home corral; an' never ease up on your gait, nor look back on the trail till you're on the glorious ranges o' Zion, luxuriatin' on the never failin' feed of righteousness and eternal life, and bearin' God's own brand, the holy brand o' the Cross."

## SPRING.

W. T. JONES.

And here you are, agin.  
Been floatin' round with Winter,  
You naughty thing.  
Purty tough  
To have snow, flyin' low, an'  
Teeth chatterin' so I couldn't  
Say Gee, or Haw.

Hot enough now, you bet.  
Fact I never seed horses sweat  
Worse 'n they did yesterday. An' say!  
It was a caution the way  
They took me round that land,  
For 'bout an hour. I can stand  
Right smart,  
Of trampin' yit;  
But I must say for my part  
I was dern glad when they quit  
Their racin' and settled down  
To a steady gait. Plowin'  
Aint the easiest work  
For horses, anyhow.  
Right down to it, no chance to "shirk,"  
So when they fret  
And jog along, 'bout four  
Mile an hour, you get  
Somewhat riled, and swear  
I guess; leastwise 'taint fair  
To blame a feller if he does.  
'Bout the "trynist" thing 't ever was.

And this is Spring,  
You old sweet thing.  
Blow cold or hot  
Jist like as not  
Fish 'll bite.  
So everything is jist all right  
I guess. And we'll forgit

About the snow; and yit  
Only a week ago it quit.

In writin' of this "owed" to Spring  
Perhaps I oughter try and ring  
In something 'bout bees,  
And birds, and leafy trees,  
And May apples, and sich;  
Like all good poets which  
Has the hankerin' for fame  
Would do. But I don't hanker  
Much as I used to. My sheet anker  
Aint 'zactly Spring nor Fall  
Nor June. But 'bout July,  
When bass is risin' to the fly  
And woodcock's loafin' along the river.  
Then we somehow diskiver  
That summer time  
'S good enough for us.  
Fact is we don't keer a cuss  
'Bout things we ust to;  
Sich as swings, and flyin'  
Jinnies, an' posies, an' tryin'  
To swing funder 'n any one;  
An' go in swimmin' Sunday;  
An' feel so ornry Monday  
Couldn't hoe, or plow,  
Or anything. Somehow  
I felt clean gone.  
But generally the blister on  
My back was on't for 'bout a week;  
"Suffered in silence" so to speak.

Don't keer 'bout these things, I said;  
But lots o' other things 'bout as bad  
I do. And I'll gist say  
I aint 'zactly stuck on May,  
Or June, or Jiniuary; but I  
'M awful friendly tow' rds July.

## ONLY A DOG.

A. W. DIMOCK.

It is not expected that the Supreme Court of the United States will ever be found in the van of the Nation's march toward liberty and justice. Its traditions forbid. The Judicial department of this Government never gave birth to a Lincoln, nor construed a beneficent law in favor of freedom or humanity, when it could escape the necessity.

But if it cannot join the procession, it ought to keep in sight of it, for in this land of law the Sceptre is in its hands, and in the words of the greatest of our race,

"There thou might'st behold the great image of authority;

A dog's obeyed in office."

In a recent opinion written by Justice Brown, for the Supreme Court, in a case involving only a dog, it was held that dogs belong in the category of monkeys, cats, and parrots, and are not on the higher plane of horses, cattle, and sheep; that as dogs have no intrinsic value (unlike a Justice of the Supreme Court), their recognition as property is entirely within the discretion of the Legislature; that property in them is of a qualified nature, and regulations affecting them, which, if applied to domestic animals generally might be unconstitutional, are lawful, and the owner of a dog has no right to complain of them.

Under this decision a dog or his owner has no right which any one is bound to respect.

In classifying dogs with monkeys the court was oblivious of the obvious fact that the latter were created only as a joke.

In antiquity the dog ranks at least with man.

Fossil dogs have been found in great number. The monuments of Egypt bear witness to the race. Books and inscriptions prove that in the remotest historic periods dogs were as now; while the earliest systems of pagan theology recognize them.

Cuvier asserted that the dog was necessary to the establishment of human society, while other authorities allege that nations owe much of their elevation, above the brute, to dogs.

Herodotus records that in olden times, when a greyhound died, members of the family shaved their heads, and the dog was buried in consecrated ground; while death was the penalty for killing this dog.

The memory of Walter Scott is en-

shrined in his poem to "Bonny Heck," while the name of his "Maida" is linked with his own.

Embodied in the literature of many lands, is the story of "Gelert."

"And marbles storied with his praise  
Poor Gelert's bones protect."

It is not alone in fiction that the dying eyes of the dog turn feebly toward his master and companion. His very name typifies affection, courage, and faithfulness.

Life is possible, under the polar star, to the Esquimaux, because of his dog; while herds of cattle and flocks of sheep have been protected and cared for, by dogs, since before the star of the East shone over Bethlehem. The St. Bernards of the Alps have, for generations, struggled through the snow with their burdens of food and clothing, seeking the lost or bewildered traveler.

There was cabled over the world an account of the death of Bismarck's "Tyras," whose soul was released while struggling to save his master's property from the burning palace; and to-day that Prince finds consolation in the steadfast faithfulness of his Great Danes, for the coolness of the great German whom he had made, but whose gratitude was that of the "place expectants" of the elder Walpole. It is as easy to imagine the Prince grinding a hand organ as finding his consolation in the monkey with which Judge Brown classifies his pets.

The story of the devotion of the dog to man involves the history of both races. He guards his cradle and he lays a broken heart upon his grave. Who shall criticise the man, who, having inspired the life-long devotion of a faithful dog, believes with Pope that

"Admitted to that equal sky,

His faithful dog shall bear him company,"

to a country where a higher Court will review Judge Brown's decision and Judge Brown himself!

What American citizen would not choose to sleep under the Adirondack sod, with the humanitarian fanatic of Harper's Ferry, rather than on the Supreme Bench with his namesake?

## HOOVER'S RANCH.

JAS. HANKS.

Wishing to make the acquaintance of the stock men in the Judith Basin, Mont., I determined to drive from Armington to Lewistown, a distance of 110 miles; so I had Simon (my colored driver) hitch a pair of native horses to a light, open wagon, and, in company with my wife, set out one fine morning in September. The stage road through the basin is level and fine, running through the center of the valley, which is 15 to 25 miles wide, with high mountains on either side.

We drove to every ranch we came in sight of, and consequently saw little of the road. Game, such as grouse, sage hens, deer, antelope and wolves, was plentiful along the route, and having a 40-65 Winchester, and a No. 10 shotgun, I had no trouble in keeping plenty of meat on hand. Often while talking to a cattle man, I would see a flock of grouse or a band of antelope, which would make me forget everything else, while they were in sight; whereupon the rancher would remark:

"Why, if you like hunting, you ought to go and hunt up old Jakey Hoover."

I heard, so often, that old Jakey could give me all the hunting I wanted, and all I wanted to write about, that I determined to find him. So, after we had made a pleasant and profitable trip, I told my wife that as she then had a good place to stay, I would take a week off and endeavor to pay old Jakey a visit.

She remarked that she hadn't seen old Jakey for some time, and she believed she would go along. Some of the ranchmen told me they had met Jakey; others that they had not; but every one knew him as the boss hunter and the greatest "bar killer" in Montana.

We drove up the Judith river to the Peck ranch, the last habitation of any kind up the stream. Here we stopped over night and got our final directions, and although Mr. Peck was confident we could not find the way, without a guide, we started. He told us we had to drive up the stream, crossing it every few rods, for about 20 miles. Then, he said, if we looked sharp enough, we might see an old trail turning off to the right. This was old Jakey's trail. "But you'll not find it," was his parting salute.

We traveled steadily till about 3 P. M., when we found a doubtful looking trail turning so sharply to the right, that it had the appearance of going back. We took it, secretly wishing it would lead us back to the Peck ranch. But no—it led us over a ridge, covered with stunted pines; thence down a ravine which grew deeper and deep-

er till, in a few minutes, we were in a gulch barely wide enough for our wagon, the hubs nearly touching on either side and the walls rising, perpendicularly, a hundred feet high. It looked as if night were setting in; yet it was light enough to see great caves, under ledges, on either side; and in what little dirt and dust there was at the entrance, were plenty of bear tracks.

Now I like sport, but the idea of being in such a plight, with a woman, and no help in time of need but a negro who was so scared I could nearly see his eyes from behind, was not the kind of sport I like. I expected every minute to get stuck in this narrow defile and to have to tear the wagon to pieces to turn around. My heart sank below zero when I saw, a short way ahead, what I took to be the end of this gulch; but it proved to be a sharp turn to the left, and where the wagon hub struck the corner, in turning, I saw some red paint on the rock which convinced me some other wagon had been through.

This was a great relief to my mind. A few rods farther we emerged from the gulch into the water—beautiful, cold, clear water. The stream is about 2 rods wide and 2 feet deep. After crossing it we were in Jakey Hoover's park, which is about  $\frac{1}{4}$  of a mile wide by one mile long. It is completely surrounded by crags and peaks, on whose tops rest the fleeting clouds. We had entered this beautiful park by the only way accessible. A short drive brought us to Jakey's cabin. Several deer, some of which he had raised and others that had become tame from association, and from being salted and protected, were grazing in the meadows.

I saw a man at the door shading his eyes with his hand, and watching our approach. He looked about 35 or 40 years old; had long, dark hair, high forehead, was of medium height, and had pleasant, blue eyes. He was withal a kindly looking man, seemingly in the prime of life; yet I afterward learned he was 54 years old. He had lived in this beautiful place 22 years.

I asked him if his name was Hoover, and, on being answered in the affirmative, I said he was the man I was looking for. I explained my business and said I was there simply for a visit of a day or 2; whereupon he unbent with the movement of a steel trap; opened the door and gave us a welcome that made us feel perfectly at home. His cabin stands by the stream, with a deer house back of it capable of sheltering 20 or more deer. He leads water from a spring, by pipes, to his house; and such water is never found East of the mountains.

The floors are carpeted with the hides of deer, elk, bear, caribou and lions.

We spent a week with him, during which time we had enough experience fishing, hunting deer, grizzlies, and lions to make a book. I often got tired and hungry, only to go home and eat in a manner that surprised myself.

Space forbids my writing of old Jakey's mode of living. The meats at one particular meal consisted of elk steak, deers' rigs boiled and stewed down, deers' brains, rolled in pulverized crackers and fried, and a large platter of mountain trout. These, with Jakey's coffee and biscuits, made, it

seemed to me, a meal good enough for any one.

This first visit to Jakey's ranch occurred in 1893, since which time I have made him several visits, spent many days with him on the trail, and many nights with him by the camp fire, of which I may write again. I hope to be in Hoover's park in the near future. If any of your readers wish to make a trip to the mountains, in quest of sport or health, I will gladly write them directions and letters of introduction that they may visit the prince of hunters and see, in the wonderful park, the wondrous beauty I cannot describe.

---

## TROUTING ON THE THUNDER.

A. D. CURTIS.

"De Veney comes with me to go fishing to-morrow. Get bait. Cook."

Thus read a telegram received one day early in May. The bait was dug, the minnows caught, the flies carefully looked over. In short every preparation was made for the first trout fishing trip of the season.

The desire to get into a trout stream, that had been growing stronger every day, finally reached its head. The result was, 6 Marinette (Wis.) members of the Wau-che-wense Rod and Gun club, with 2 Chicago Calumet club friends, alighted at noon, the 9th, at Ellis Junction.

There we found 2 rigs backed up to the platform. The skiff, in sections, was stowed in the bottom of the heaviest wagon and a few minutes sufficed to pack everything carefully. The Joker gave the minnows a change of water and a few drops of brandy, which livened them up surprisingly. Then the start was made.

The highest point in Wisconsin, elevation 4,000 feet above Green bay, distant 23 miles, was our destination—known to the Indians as Wau-che-wense, and to the whites as Thunder mountain. The country had been "logged"; jack pine now being the prevailing timber until within a few miles of our fishing ground; there the virgin forest began.

Camp was reached 2 hours before sunset, and rods were hastily rigged. Some of the party fished the North branch of the Thunder, flowing merrily past camp. The rest, with the assistance of Wade, our lodge keeper—the greatest talker in the State—carried the sections of the boat up the mountain to the little lake half a mile from camp. Soon the bottoms and ends of the skiff were nailed to the sides, the tar boiling and ready to be applied, but no swab

had been brought. Handkerchiefs were too valuable so far from the source of supply, so 3 of us held Wade down while the Doctor skilfully amputated his trousers half way to the knees. The improvised swab, tied to a stick, did the work satisfactorily.

It was too late to try for trout, so a bee line was taken through the woods for camp. Supper was awaiting the hungry crowd, and the trout, caught by the other members of the party, fried to a delicious crispness disappeared with astonishing rapidity; 80 going down before the 9 appetites were appeased. Cigars and pipes were produced, and, lounging in the balmy evening air, stories were told of former exploits with rod and gun, and plans made for the morrow. Wade talked and talked; but as he is left alone in the wilds for weeks at a time, some allowance was made.

It was seemingly but a moment after crawling into our blankets, when his voice was heard again, but not an unwelcome sound; for it was: "Turn out boys; it's 5 o'clock; a fine day for fishing and breakfast is most ready." The meal over, 2 of the party were driven 6 miles up stream to fish in the vicinity of an old logging camp; 2 others went along to fish down stream; some went East a mile to fish the Handsaw creek; while I fished from the camp down stream.

These waters have always been celebrated for excellent trout fishing. Both the North branch on which we were, and the South branch, about 5 miles away, are ideal streams. All kinds of fishing grounds can be found. Rapids are frequent, where the gamy trout respond to the cast with a savage rush. The wading is good, though the rocks are slippery and the pressure of water so strong one may be swept into a

hole if not careful. The excitement of the fishing is great and chances are often taken, so amusing and chilly experiences are not infrequent. A pair of old trousers, with shoes joined at the ankles with a string, are the best outfit for hard and successful work. Hip boots are soon filled with water. The spawning grounds, usually the level places between the rapids in the shelter of overhanging alders, abound in deep holes. Here it is necessary to work carefully along the bank and patiently try the different kinds of bait, to overcome the shyness of the big trout. Our minnows, kept hard and fresh by the method of packing, proved the right kind of bait, and tempted many trout, of  $\frac{3}{4}$  to  $1\frac{1}{2}$  pounds in weight, to their death.

Old logging corduroy bridges are favorite retreats for the fish; but the angler must be careful not to let a shadow of even the rod flit above the still water, nor to jar the logs by a careless step.

Cautiously creeping through the tall grass to these spots, you cast a fly or bait into the current. With a rush the line is pulled across the pool with a strength that bespeaks a big one. The utmost skill is needed to keep the fish from getting under the logs or into the willows. Back, forward and across goes the trout in its frantic endeavor to release itself. The struggle may be long or short, but when a successful landing is made, a chuckle of satisfaction accompanies him into the creel.

The hungry but successful anglers straggled into camp one by one; every creel full. Wade commenced to talk and clean fish, with the appearance of the first man, and he was kept busy for several hours.

After dinner the fishermen lay around in the shade, each one telling of his biggest catch, and how it was done.

One of the party, however, had not returned; probably not wanting to come back without a full catch, was the decision. He had not taken a lunch, but would likely roast a fish or two, and fill up on brook water.

The most enthusiastic again started out at 4 o'clock, to fish the stream; while some went to the lake. A beautiful little lake it is, at the foot of a high hill, bordered on one side by rocky cliffs; on the other by hardwood timber that cast dark reflections in the deep water along the shore. The trout rose well, and our 5-ounce split-bamboo rods were tried to their utmost. The trout that had given up the creek for

the cold spring lake, were gamy to the last rush.

Wade paddled the boat, and, wonder of wonders, threats of a gag answered as well as the real thing. Not a sound was heard save the swish of the paddle and the sighing of the wind through the treetops, with an occasional exclamation as a good fish was hooked or landed. Twilight approached and the reflection of the trees became darker, the murmur of the wind grew to a weird roar, as one of the sudden storms of the mountain foretold its coming.

The rumble of thunder was heard afar, and an exceptional day it would have been without it, on this mountain; for it is rightly named. Probably from being daily accustomed to it, the trout did not cease biting. The darker it grew, the more frequent were the exciting splashes, tugs and rushes, as the hungry fish, anxious for a last morsel before dark, savagely took the flies. Some jumped clear out of the water, taking them on the downward turn; some seized them on the upward rush; while a few were caught in the wrong end, as they struck at the flies with their tails.

Of all my varied fishing experiences, this was the most peculiar. The roar of the wind on the mountain above, while the lake was comparatively calm; the deepening twilight; the excitement of the sport, all combined to make a lasting impression.

This part of the outing was a decided success in the size of the catch. We went to camp lugging over 50 pounds of trout. Here we found the whole party assembled; the missing one having at last turned up in a very bedraggled and exhausted condition.

Having lost his way, he had, after traveling in a circle for several hours, forced himself to think rationally. Then he took a bee line West by the sun until he struck the main Thunder. After that he worked his way up stream to camp.

Every day was varied by different experiences. The worries and cares of business were forgotten, and our lease of life lengthened accordingly. On the 4th day, as most of the men must return to civilization, preparations were made for the homeward journey. Before going, however, Wade was presented with several pairs of trousers, to recompense him for the abbreviation of his own. As we rumbled down the road, he talked until we were out of hearing, and for all we know, is talking yet.

---

“When I’m reduced to my last dollar I go right out and spend it.”

“What good does that do?”

“Nature abhors a vacuum—and it brings in money to burn, right off.”



## MARK EAST!

S. T. EARNS.

Within sight of the sand dunes of Long Island and Great South bay, are Smith's point, Middle ground and Barn flats. These, with places of lesser advantages are, because of the prevailing South or South-west winds, lee shores, and consequently feeding-grounds for myriads of ducks in autumn and winter, and shore birds in the late summer. From the first of July, shooting on Great South bay and Shinnecock yields good bags of snipe; and the shooter who goes to Canoe Place inn, Lane's or Ackerly's, for a week, is absolutely certain of good sport, part of the time at least.

With the ducks it is different. For punt shooting, arrangements should be made about 10 days ahead, and the date positively fixed; or it will be found, on arriving unheralded, that every punter is engaged. Then comes the aggravation of hearing reports of more successful gunners, and seeing the puffs of smoke from their guns, away across the bay. In consequence, on your return to the city, you will stop at Fulton market and grimly "put up" for 6 or 8 pairs of birds, to be sent to expectant friends.

If the sport is to be battery shooting, the same preliminaries should be observed. You are expected on the evening train. The hack quickly takes the party, never more than 2, to Capt. Ackerly's cottage on the bay, for instance. There your supper, always duck predominating, is served; you uncivilize yourself, assume the duck shooter's habiliments, and are rowed out to the "cat." Then, off for Middle ground, where anchor is cast.

Four o'clock strikes. After a hurried breakfast, the double battery and its 150 decoys are anchored; the shooters gingerly flatten themselves in its coffin-like interior; and, with a parting, "They'll see you before you see them, if you don't keep down," the sloop fills her sails and quickly disappears. You are left with a  $\frac{3}{4}$ -inch plank and 12 feet of water under you; but 600 pounds of lead for ballast, light canvas wings and anchors, fore and aft, hold the battery steady and safe. One's apprehension of a watery grave and no ducks, gradually fades and expectancy reigns. Peering Eastward, for, the wind being South-west, from that direction the flight should come, one sees from out the darkness, stealing softly up the horizon, a white mist, paling the twinkling lights. As Fire island

grows dim and its flashes less bright, the white beach and the life-saving station assume shape. Finally a golden rim appears above the horizon. "Mark East!" and a few black spots appear. Then their wings are bowed, their feet drop, they tip up to settle among the decoys. "Spat! Spat!" and their careers are ended. The sport has commenced.

Thus it continues till noon; doubles, singles, flocks great and small; blue-bills, redheads, coots, shelldrakes, with an occasional mallard, brant or whistler. Sometimes a file of geese will give additional excitement to the shooting. The Captain blows his horn and beats up, when the flight slackens, and we go aboard for dinner. Shooting is resumed at 3 o'clock, and stopped at sundown.

It must not be supposed that this is the rule. Many times the signs and weather will be favorable; but with the sun, the wind will often veer and spoil everything. Again, when the "rig" is out, the birds are found "using" Barn flat, and a change is imperative. At another time, from a moderate breeze the wind increases to a gale, and tin cup and sponge cannot keep the water down in the battery. It sweeps in at every plunge, and though the flight is fine, self preservation is supreme, so the sloop is reluctantly signalled.

The greatest difficulty in battery shooting is to keep warm; but it becomes *un fait accompli* if the following ideas as to outfit, the outcome of 30 years of shooting, are followed:

A dark corduroy cap, with ear-laps; dog-skin coat, and mole-skin vest lined with paper—wind-proof. Mole-skin trousers, buttoning at the ankle; army brogans and 2 pairs of long woolen stockings; good gloves; fleece-lined underclothes; and a piece of soap-stone, 12 inches square by 3 inches thick, to be heated and kept in a padded cloth bag between the feet. A good marine glass and a small cushion complete the list. Eschew everything of rubber. Cut a finger hole in your right mitten, which should be large enough to pull on and off readily.

No flask? Bad! worse than 3 degrees below zero!

Given all these, with good gun and ammunition, and an ideal day, a man is dead indeed if his senses do not tingle at, "Mark East!"

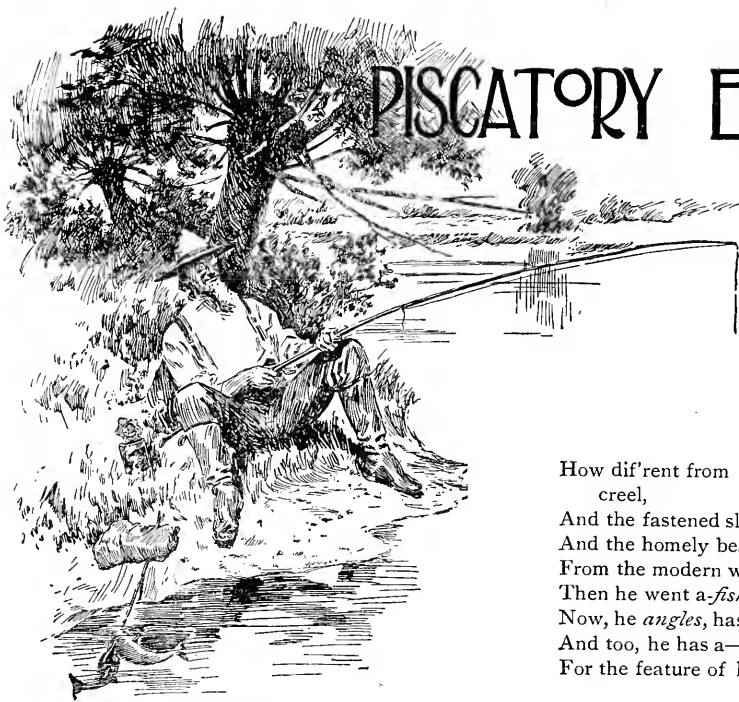

# PISCATORY EVOLUTION.

FRANK E. PAGE.

## PRESENT.

How dif'rent from the forking twig is the modern woven creel,  
 And the fastened slip-a-noose unlike the buzzing reel,  
 And the homely bean-pole that the fisher used in lieu  
 From the modern work of art—the 10-ounce split bamboo.  
 Then he went a-fishing—never burdened with supplies,  
 Now, he *angles*, has his waders, and a book of gorgeous flies,  
 And too, he has a—has a—but need a person ask?—  
 For the feature of his outfit is a nobby, yum-yum flask.

## PAST.

The piscatory devotee in happy days of yore,  
 Never got his trappings from the *fin de siècle* store;  
 But with his wetted jackknife he trimmed a fishing-pole,  
 Just long enough to overreach the bull-head's farthest hole:

## FUTURE.

Year by year the fishing vogue is changing more and more,  
 Tho' Ananias ever will be keeper of the score.  
 Of one thing we are certain, the evolution brings  
 A sense that fishing outfits are full of needless things.



And as a sort of habit, or identifying mark,  
 He carved in fancy letters his initials on the bark.  
 'Then he hied to pasture green, through which the river ran,  
 With his nice fat angle-worms in an old tomato can.

Of the changes promised, the one that's most benign,  
 Enables one to catch his fish with neither hook nor line.  
 So the angling artiste will have fewer traps to lug  
 For his entire equipment will be carried in a jug.



## A HARD RIDE IN THE MOUNTAINS.

J. G. T.

At a little frontier garrison in the mountains of Oregon, where the long winter days hung in cold monotony, we usually hailed any change of duty with pleasure; albeit the variation might be of a kind bringing only a grim delight. One snowy evening in January, Lieut. M— put in an appearance at our post, bearing an order from headquarters, 359 miles away, for a court-martial to be convened at camp Warner, still 140 miles farther on, across the wilds of Oregon.

The detail named him, Lieut. R— of our camp, and me as members, besides others at the camp beyond. The prospect was anything but pleasant, but the thought of meeting comrades whom we had not seen for months, easily reconciled us to the chilly ride. The quarter master furnished us transportation from his limited supply, which consisted of one rickety ambulance drawn by 4 wagon mules, and a spring wagon for baggage, witnesses, and one prisoner to be tried. With this outfit we took our departure. Owing to our late start and the bad condition of the road, only 15 miles were made that day. Toward dusk a spanking team approached, and we were soon hailed by the cheery driver, Lieut. Charley Roe, of my regiment. His rig consisted of an open buggy drawn by 4 handsome horses—his own property—gaily decked with sleigh bells.

Having the same destination as ourselves, he was promptly invited to join our mess. The next morning Roe asked me to take a seat beside him for the rest of the journey. We in due time arrived at camp Warner.

A few days finished the business of the court. Then we prepared for the journey home. As before, I was to ride with Roe. The wagon containing baggage and 4 soldiers, witnesses and cook, was started some hours in advance. Roe and I left the post later; while the ambulance was to follow.

We with the spanking team started in high spirits about noon. We were bowling along merrily, when, at a crossing of a creek in the narrow valley, Roe touched up the leaders. They being unaccustomed to the lash, sprang into the air. This started the wheelers and away they all went. Swerving at a bend in the road, the buggy was upset. Roe clung to the reins, and after a few desperate plunges, the horses became entangled; 2 were thrown and all came to a sudden stop. The buggy was badly broken, so we extricated the team, and returned to the garrison. Fortunately, as it might seem, though not so as it came about, the ambulance had not started. Into this

we got; but Roe insisted on hitching on his team. All went well for about 6 miles, when we reached the summit of a hill with a long descent before us. The team started down, but strangely enough, Roe did not touch the brake till the wagon had such headway it was of no avail. The horses started on a mad gallop; the old ambulance swaying, bumping and jumping. About 100 yards from the bottom of the hill, the road curved. Here the old trap, taking the outside rut, slid beautifully in the groove. This great effort at equilibrium exhausted its strength, and one tire parting, on a hind wheel, down we went. The horses were finally stopped within 50 yards of a gorge, that would soon have received us.

There we were, in the snow, 8 miles from the friends we had just left, and 30 miles from our base of supplies. Our pride would not allow us to return after this 2nd disaster, nor would our condition permit our proceeding bareback. We concluded to bivouac and brace up against the gathering snow storm. The prisoner, who was by no means a criminal, showed his pluck by volunteering to go forward and bring back the wagon. Mounting a good horse, he set out. As it was sunset the next day when he returned, it can be imagined how we amused ourselves meantime, without blankets, food or stimulant, and the mercury at zero.

After a short rest for the team that was brought to our rescue, we set out for a night's travel. We all bundled into the little vehicle, from which we soon bundled out; for it was impossible to make time with the snow 18 inches deep. All that night we trudged beside the wagon, alternating the belaboring of the mules, by lifting on the wheels. The horses had to be hitched in at intervals to relieve the mules. The whole night's journey was fraught with misery, which our chagrin augmented.

We marched 30 miles the next day, and 25 the following; our progress continually retarded by the deep snow. Sometimes it was a little distraction to watch the usual small band of hungry coyotes or little wolves, that followed close beside and behind us; coming so near at times that we could hear the hungry snap of their jaws.

On the night of the second day we made camp in a cheerless hole called Buzzards canyon. The Westerner can always be relied on to give an euphonious title to a locality. Now, the next day would be the last day of the month; in fact, the last day of the 2 months; which means in military

parlance, muster day—or did, some years ago.

Lieut. Roe being absent on leave, felt in duty bound to be present at the muster of his troop. It was the alternative of a fearful night ride, or a reported absence on the muster rolls. He chose the former. Selecting his 2 best horses, one to ride, the other to lead—first adjusting a fur robe on the back of one in lieu of saddle—he mounted and set out by the chilly light of a midwinter moon. The distance was 54 measured miles, with the road merely a trail in places—hilly and covered deep with snow. The thermometer marked 12 below zero.

We learned 2 days later, that Roe arrived in camp Harney, plucky, but badly

frozen. He lost a bit of each ear, besides sustaining a general numbness which lasted him for 3 months.

At his cabin door he was greeted by his mother, who had journeyed from her home on the Hudson to this secluded spot, to spend a winter with her son.

He was the same officer who rode one horse the same distance—140 miles—in 22 hours, and without the slightest injury to man or horse. This on duty, however.

When in the saddle, he always seemed infatuated; not with pleasure, but an apparent desire to go on and on. He is now Capt. Roe, of the crack Troop of Militia National Guards of New York—raised and equipped, I think, principally by his own efforts.

---

## RABBIT SHOOTING IN KANSAS.

A. W. BITTING.

From the time I learned to point my grandfather's old muzzle-loader in the direction of game, I have enjoyed hunting rabbits. While the sport may be thought rather mild by some, yet with a well trained dog—one that will set the rabbit and not run in—enjoyable shooting may be had. It takes a quick eye to stop a prohibition cottontail, scudding under full sail, on a Kansas prairie.

One bright morning last December, my friend Whittier dropped in on me and suggested a day after bunnies. It did not take long to get the light hunting-wagon loaded with tent and camp outfit. Then we were off for the Ninnescah river, some 20 miles South of Wichita. The roads were in excellent condition, as Kansas roads generally are, and we went bowling along at a lively gait, reaching our destination before noon.

After the horses had been taken care of, we selected a sheltered nook in a small grove, on the South side of a steep bank, so as to be out of the North wind. We soon had camp in good shape. The stove was placed in position near the entrance of the tent: camp utensils arranged in order, and then we were ready for lunch.

It is always my custom, when camping, whether for a day or a longer time, to put the camp into good shape the first thing. Then, in case of bad weather, I am ready for it. In this Western country, one gets to depend on his own resources, for there are no hotels scattered over the country, as "back East"; and settlers' homes are not always convenient. The most satisfactory way, therefore, is to take a tent: for then you can stop whenever and wher-

ever you please; and can go to bed with your boots on, if you wish.

We had with us a pointer and a setter, both well broken on birds and rabbits; and when they made a stand, there was always business ahead. It was generally impossible to know whether the game was quail or rabbit. My friend and his pointer Sancho took one edge of a cornfield, while Bird and I followed the other. Before we had gone 50 yards, my dog came to a stand. Moving up, I gave him a gentle push. Away went a bunny, bounding along until brought to grass with a load of 6's.

Alternating between prairie and cornfields, we repeated the same movements: the rabbits often coming to bag, sometimes getting away. More escaped in the cornfields than on the prairie. Having all the rabbits we could easily carry, we returned to camp an hour before sundown.

It was a beautiful evening, so we built a fire outside the tent, and put the kettle over the fire. While Whittier was stirring the mush, I prepared a generous supper of stewed bunny and sweet potatoes.

After the meal, we were ready for "swopping" the usual camp-fire stories of former hunting trips. While my companion was giving me a "whopper," we were joined by 2 lads from the neighborhood who had seen our fire and came to see "what was going on." They were pleasant boys and gave us some information about the game of the vicinity. The quiet of the evening was enlivened, occasionally, by the howling of coyotes in the valley; otherwise everything was in repose. Feeling the need of rest ourselves, we sought our downy couch.

We were awakened by a howling storm. It was wind, hail and snow. We rose with the dawn and after a red hot breakfast, were again ready for business. Several inches of snow had fallen, and the trees and bushes were covered with the fleecy mantle. Here in sunny, Southern Kansas, one is not often greeted with such beautiful winter scenes. It brought to my mind similar ones in the East, in "auld lang syne."

Pulling on our rubber boots, we forded the river, to hunt among the wild plum bushes on the sand hills. We walked leisurely and had an enjoyable half day's sport, bagging numerous rabbits and a few quails.

My friend killed a large coyote, that unwisely attempted to pass him, on his way to better cover. He had a beautiful coat, which now, as a rug, adorns my friend's hall.

Until I have explained, it may be doubted that I got a rabbit up a tree. This, however, actually occurred. Although we had agreed to shoot only running rabbits, I saw one at the foot of a small plum tree, some distance away; so thought to touch him up. At the report, the rabbit sprang straight into the air and landed, dead, in the fork of the tree, over 2 feet from the ground. Was not that treeing a rabbit?

Could an Eastern sportsman have seen our camp, he would have exclaimed: "Game hogs!" Well, if the killing had been done in a locality where rabbits were less plentiful, the term might be justified. Rabbits have no protection here; indeed, they are so numerous and destructive to young orchards that the county pays a bounty of 4 cents for every pair of ears. Even then they seem on the increase, especially jack rabbits; as they are not esteemed much for the table and therefore little hunted. Good sport is had chasing jacks on horseback, with hounds.

In recalling my hunting trips in Eastern Pennsylvania, several decades ago, I remember many a weary tramp of miles, over hill and dale, with a result of perhaps 1 or 2 rabbits and a squirrel or so. Yet, if the game-bag was light, the jaunts were happy ones for all that.

At the conclusion of our hunt, and on our return to camp, I proposed a final lunch of broiled rabbit, but was ruled out by my friend, who had already had enough of that kind of fare.

On account of the snow, the return trip was rather tiresome, but we finally got through. For years to come I shall think with pleasure of our day after bunnies, on the Ninnescah.

## SOME OLD GUNS.

CAPT. PHILIP READE, U. S. A.

### EARLY FRENCH MILITARY BREECH-LOADER MOUSQUETON.

The Mousqueton des Cent Gardes was invented in France. The order of introduction of breech-loading arms, for military service, was as follows: 1. The United States Army. 2. Norway and Swedish Marine. 3. Prussia. 4. France. In his "Report of the Military Commission to Europe," 1855-56, Maj. A. Mordecai says that this "Cent Gardes" arm was destined for the special corps connected with the Emperor's Palace. The arm was of what, in 1856, was small calibre, being 0.36 inch. The ball was long in proportion to its diameter; powder charge 30 grains. The ball, powder and fulminate were contained in one cartridge, covered at the rear by a copper cap containing the priming. Mr. W. W. Greener states that the cartridge used was similar in construction to the Le-faucheux: that is, the pin fire cartridge. The last named authority states that the pin for the cap was placed "under the base of the cartridge and projected barely  $\frac{1}{8}$  of an

inch." Greener also says the manipulation of this arm "was difficult and dangerous." It will be observed that the 2 authorities quoted differ as to the priming system employed.

Maj. Mordecai's report describes the Mousqueton des Cent Gardes as having a

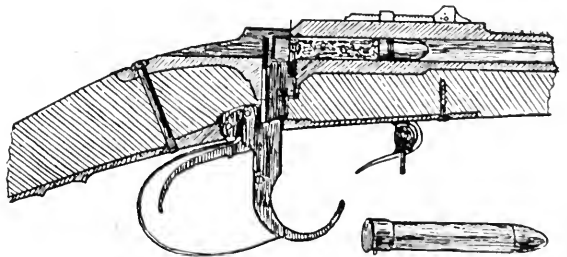

*Early French Military Breech-loader.*

breech-loading arrangement somewhat similar to the American Sharp's carbine. The carbine was finished with a slender sword bayonet, 40 inches long, with which it formed a lance  $7\frac{1}{2}$  feet long. I quote from Maj. Mordecai's report:

"This breech-loading arrangement appears to act well, as it may in an arm of so small a calibre and charge, used only under cover of a roof; but it would not seem to be adapted to use in the ordinary vicissitudes of military service. However, M. Pruille, *chef d'escadron d'artillerie*, proposes to make arms for the general service on the same plan: to use a very long grooved ball, weighing about 180 grains, with a charge equal to 31 grains. He says a ball of this kind penetrates, at 20 paces, through a cuirass which has been proved in the ordinary manner: that it has a range of 650 yards with an ordinary sight, and an extreme range of 2,186 yards."

#### THE LEFAUCHEUX BREECH-LOADING SHOT GUN AND PIN FIRE CARTRIDGE.

This non-military arm is illustrated here; 1st, because Lefauchaux is stated to have been a workman under the celebrated Jean Samuel Pauly, just as Jean Nicholas Dreyse, the alleged inventor of the Prussian needle gun, had been. 2d, because the sporting arm of Lefauchaux was one of the first fire arms of any kind, "drop down" system, to use a gas-tight cartridge shell, or case, to properly fit the breech of the gun: the cartridge carrying the means of its own ignition. The first Lefauchaux gun used a pin-fire cartridge, which is shown in the illustration. After this comes the rim-fire cartridge; then the centre-fire metallic cartridge. The pin-fire cartridge of Lefauchaux required a pin-hole in the breech part of the gun for the brass striking pin to stick up through, acting as a nipple for the cock or hammer. This pin hole was a great objection, as the pin had to fit into the notch in the barrels before the barrels could be closed. In very rapid loading, and during excitement, delay was caused in properly fitting the cartridge. The liability of the pins to be bent out of shape, or displaced, was also an objection. The Lefauchaux cartridges were not handy to carry on account of the projecting pin. Yet the introduction of the central fire cartridge

met with opposition from many who asserted that the system was dangerous because they could not see, at a glance, if the gun was loaded. The hammerless shot guns were opposed, 18 years afterward, on the same ground, with the further objection that sportsmen could not see when they were cocked or loaded. Patented "indicators" followed but were discarded as useless and unnecessary appendages. Some of Lefauchaux's pin-fire cartridges were of pasteboard, re-enforced with foil near metallic base.

On page 102, "Hints to Riflemen," 1864, by H. W. S. Cleveland, is a sensible defence

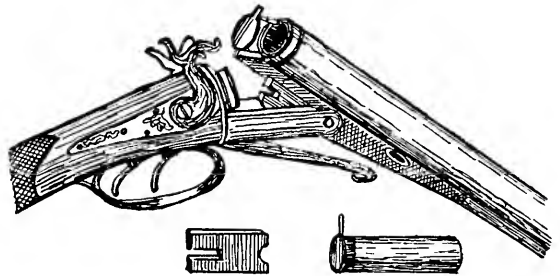

*Lefauchaux Breech-loader. Single grip.*

of cartridges loaded at factories and self-primed. Even at that date, objections were urged by some who preferred muzzle loading arms and percussion caps, based on the ground that loaded cartridges were dangerous: that if the sportsman's or soldier's supply of such was exhausted his fire-arms were of no more value than so many sticks: that they could only be used with the special ammunition provided for them: that their use restricted the firer to precisely the same quantity and quality of powder and ball under all circumstances and at all ranges; that they encouraged waste of ammunition, carelessness, etc., etc.

The success of breech-loading small arms is due in a great measure to the cartridge, in the improvement of which there has been the same advance as in the arms themselves. No matter how inferior may be a breech arrangement, a perfect cartridge can be used with safety and efficiency.

---

#### TO A PICTURE.

LAURENSTINE YORKE.

New sorrows smite me from thine eyes  
 And I am blanched and dumb;  
 Hope, the alluring siren dies,  
 And leaves me cold and numb.

## FROM THE GAME FIELDS.

### ON THE MOULEE MARSH.

W. T. D.

After being cooped up in an office all winter, I naturally enjoyed my 1st outing of the season exceedingly. I do not believe in spring shooting, though to get into the country, I usually spend at least one day on the marsh. I prefer the woods, not because of the woods, but for the action and the unexpected whir of a partridge or quail. To lie in wait for a duck, seen afar, coming dead on, is, to my mind, "too Indian."

My friend and I left Trenton, and with a Northwest wind made the 8 miles to the marsh just below Huron river, in time for breakfast. No record of time was kept, but we could not have been 2 hours in making the trip. Our boat, a 16-foot open skiff, was old and heavy, but a good sailer, stiff in the water.

After breakfast we walked down the beach and punted through the marsh, not trying to kill birds, but lazing around. Away back in the marsh were thousands of pintails, and although 2 or 3 miles away, we could hear them rise with a roar known well to duck hunters.

The Moulee marsh is probably one of the best ducking-grounds in the country. Members of the club there kill hundreds of ducks in a day. It is said that Harvey Brown, of Cleveland, who is the best shot in the club, shoots 3 guns and kills with every barrel. I have heard of his getting 28 teal out of one flock.\*

We killed more time than birds, but had a good time. Late in the evening we heard the birds coming into the marsh. An occasional mallard would fly over with a "quack, quack"; then we heard it repeated away back in the marsh. The teal would whiz by, disappearing in an instant. This kept up until long after dark.

Many an evening, in the fall, have I spent in the marsh to catch the flight, when I shot so fast my gun barrels became too hot to touch. For half an hour it is good sport. When you are through you find you have killed, in the short half hour, enough mallards, grey and black ducks, to satisfy you.

The next afternoon we started home in a gale. Three other hunters, who were at the marsh, came with us; one in our boat. We took in a lot of stuff that loaded us down, but being accustomed to wind and water we hoisted sail and flew before the

wind. One was kept busy bailing. Several times, when the wind came too strong, we had to let the sail fly out in front, like a flag; even then we made great time. Once a big wave covered our bow, six inches. My friend was at the tiller and saw it coming. He was afraid one of us would see it and move; then all would be over, perhaps, with all of us. I had a few pails of water to bail out, as a result. Our next trouble was going through a bed of bowlders. I don't know how we got through and will not try to tell.

We stopped at Story's bay and looked back for the other boat, but they were not in sight. For a time we were worried, but after a time we saw them coming and they were soon with us. We then held a council on the beach.

"Now what shall we do?" said one. We had made only about 3 miles.

"Let's go into Story's, leave our stuff and have him drive us to Trenton," I suggested. All agreed, and that was what we did.

The gun that Story—an old market hunter—has is a murderous weapon. It is 4 gauge, nearly 8 feet long, with a big pad on the stock. Story said he had killed 42 ducks at one shot. His load was 12 ounces of shot—could shoot 14, but it kicked too much. From a boat, he would get in line with the ducks, rest the muzzle, hold the stock against him somewhere and let it go. The recoil would send the boat flying through the water and save him. I am thankful the law prohibits the use of such guns, now.

---

### FROM LAKE CHELAN.

Trapping in this section last winter was not good. Several men were engaged in it, but no good catches were made. The country about the lake has been trapped every winter, for the past 7 years, and marten are getting scarce. The Pearl brothers wintered in the Stehekin valley, at the head of the lake, and caught a few marten, a fisher or 2, several mink and 5 lynx. This last named catch is curious. In the winter of '88 a party of 4 trapped at Railroad creek and got 31 of these whiskered cats. A few years later one of the same men and I hunted and trapped there 2 winters. We got a large number of marten, some fishers, a dozen wolverines and a varied assortment of other fur; but only 1 lynx. Nor did any of the other hunters catch anything feline except an occasional bob cat. Lynxes have been caught in several localities, lately, and some people believe they

---

\* There are many club men who are also game hogs. Mr. Brown, if this report be true, may not squeal for his food nor put his feet in the trough when he eats, but he has all the other characteristics of a first-class hog.—  
EDITOR.

are like bears, in one respect—i.e., some years they will be seen and caught freely, and in others they apparently desert the same section altogether, or nearly so. Is the lynx inclined to be migratory in its habits?

Mountain lions have been killing deer, to an unusual extent. During January and February several half-eaten carcasses were found, and I saw the remains of a large doe floating in the lake. She had been killed and partially devoured. This was evidently a lion's work. One of these had been staying in the Stehekin valley for several winters, but Redmond Pearl saw it one day and wounded it, with his 38-40 Winchester. He then followed and killed it—a male, 7 feet 10 inches long and weighing 131 pounds, on a steelyard, just after being brought in. It was very fat, and is supposed to be the one that has been heard so often for 3 or 4 years past.

Deer wintered well here and few were killed during the later winter months; but they are not so plentiful as formerly; nor are goats shot so often. Two men from Southern Oregon, came in lately, bringing 4 large dogs with them. They have gone up Railroad creek after bear and intend hunting them all the spring. Hides are good until the middle of June, away up in the mountains. Trout are biting freely and some good catches have been made. Prospectors are preparing to go out now, in the hope that the new forest reserve order will be amended. Mining is the coming industry in Washington, and if the order stands as made, it will utterly ruin this country.

C. Greenwood,  
Lake Chelan, Wash.

---

## WHERE THE BUFFALO WENT.

ANACONDA, MONT.

Editor RECREATION: In 1876 I was Government scout under General Miles. Little did I think then that the immense herds of buffalo which were continually in sight, would so soon be swept off the earth.

In September of that year, "Yellowstone" Kelly, "Billy" Cross and I were sent by General Miles to locate the camp of the Ogallalah Sioux. We followed down the Yellowstone 50 miles, and about 10 o'clock that night, found where their camp had been during the day. The next morning we took a straight cut for Cedar creek, reaching it at dark, then travelled up stream 8 miles. Every half mile we ran into herds of buffalo. They were not wild, and at times it seemed certain they would run over us. It was a peculiar situation—hunting Indians and dodging buffalo.

We camped in a thicket that night. In the morning, Miles' command was seen

about 8 miles away, exchanging shots, at long range, with the Indians. Cross and I were for lying low until night; but Kelly insisted on taking daylight for it. So, with almost a certainty of being shot, we started for the command.

The Indians had set fire to the prairie, and the smoke had shut off our view; but every time the wind lifted the screen, we got our bearings. Fortunately for us, the enemy had gone to the farther side of the command, leaving clear sailing for us. The Indians told Cross, afterward, they saw us, but through the smoke took us for Indians.

When within 250 yards of the troops, we saw them sitting on a sidehill, resting. As the air was still smoky, they also took us for Indians, and fired volley after volley at us. The bullets rattled about like hail. We found shelter in a convenient washout until a sergeant, with a small detail, came down to scalp the dead. The soldiers were certain they had seen a number of Indians fall from their horses; but it was only us, as we tumbled to the ground, looking for holes in which to cache ourselves.

From '76 to '82, on both sides of the Yellowstone, buffalo were slaughtered ruthlessly by whites and Indians. At every shipping point there were thousands of hides piled up. All that was saved of the animals were the hides and horns. The former averaged the hunter \$2.50 each, while for the horns he got 1 cent a pound.

In those days, from any prominence, 10,000 buffalo might be seen "at one look." It was certainly a magnificent sight. The cattlemen wanted the buffalo exterminated, so the cattle could have the grass. As no one interfered, the white hunters slaughtered, indiscriminately, male, female and young.

One day, on the Redwater, 35 miles North of Glendive, I counted from a butte 18 hunters, all shooting into different herds of buffalo, with their Sharps rifles. Yet people wonder how the buffalo could have been so quickly exterminated.

In '83 there was practically but one herd left. That was between Moreau and Cannon Ball rivers, in North Dakota. There were about 10,000 animals in this herd. In September of that year, Sitting Bull, with his followers, went up the Cannon Ball, hunting. The 1st day they killed 1,100—an average of 1 buffalo to each Indian. White hunters would have killed 20 to 60 in the same time. By the middle of the following November the herd was completely wiped out. From that month, the American bison was practically a thing of the past.

Vic Smith.

---

"Buttons used to cost \$100 apiece."

"Yes; men used to need more decoration than they do now."



INDIANS ARE AMENABLE TO  
GAME LAWS.

Some weeks ago the District Attorney at St. Paul, Minn., filed an opinion with the Game and Fish Commissioners of that State, to the effect that under existing treaties between the U. S. and the Chipewa Indians the latter have the right to hunt anywhere, and at any time, and that they are therefore not amenable to State game laws.

I wrote Mr. S. F. Fullerton, Executive Agent of the Game and Fish Commission, referring to a case recently decided in the U. S. District Court, for the District of Wyoming, in which substantially this same question was involved, and Mr. Fullerton replies as follows:

"I am very glad to be able to say to the readers of RECREATION that the attorney general of our State, as also the chief justice of our Supreme Court, has given us an opinion adverse to that of our district attorney, and they say the Indians have no more rights than the white men have.

"Of course we, as a commission, intend to keep on arresting the Indians, whenever we find them breaking the law, and we are glad the matter has been finally decided in the supreme court of Wyoming. I am also glad RECREATION is of the opinion that the Wyoming case covers our case here in Minnesota. If this point had been decided otherwise than it has been, it would be one of the most vital blows at game protection that was ever dealt in Minnesota. If the Indians could hunt when and where they pleased then all our efforts at game preservation would be in vain; and I am glad to know such is not the case.

"We have just passed our new game bill and think we now have a good law; in fact, one of the best in any State in the Union. The legislature has been very kind to us and has increased our appropriation from \$15,000 to \$25,000 a year.

"Sentiment is growing in Minnesota in favor of game protection, as indicated by the action of our legislature in increasing our appropriation in these hard times. RECREATION is doing splendid work along the same lines, and the Game and Fish Commission wishes it every success."

---

I have read one of your charming books and buy your magazine, regularly, at the book store. RECREATION is the best of its kind published. I am a lover of nature and my hobby is canoeing. I wish you would publish some articles about canoe outfits and complements.

C. F. W., Cleveland, O.

I should be only too glad to print such articles if some of my friends will write them.

EDITOR.

## THE WOLF QUESTION.

In future numbers RECREATION purposes taking up the very serious question of wolf-extermination in the ranching country.

As nearly as can be ascertained, the region chiefly concerned at present is Wyoming, Eastern Colorado, Eastern Montana and Western Dakota.

The damage done in one year by a single gray wolf has been variously estimated by ranchmen at \$50 to \$500.

If the lowest estimate is correct it would pay the Government to offer a \$25 or even a \$50 bounty for each wolf scalp. But it is one matter to go wolfing and another to kill wolves.

Of the 3 usual methods of carrying on the war, poisoning, hounding and trapping, detailed accounts will be given in future numbers. In the meantime it is very desirable to have careful answers to the following questions, with a view to getting the evidence necessary to bring the whole matter forcibly and intelligently before the authorities, as well as the public.

Personal experiences are what are desired and it is hoped that correspondents will at least sharply distinguish between what they themselves know, and mere hearsay.

1. Where are you located?
2. Are gray wolves troublesome in your region?
3. What do they destroy? Horses? Cattle? Sheep?
4. About what amount of damage should you estimate they do in a year, in your county or range?
5. Did you ever *know* of a gray wolf killing or harming a human being?
6. Are wolves increasing in numbers?
7. Have you any reason to believe that wolves can signal across country, and so tell each other what parts are dangerous or where the hunting is good?
8. What is the average and the greatest weight and measure of a wolf, according to your certain knowledge?
9. Do you consider the coyote a nuisance; or do you consider the harm done in killing lambs, etc., more than balanced by the good they do in keeping down gophers, ground squirrels, etc.?

10. What do you consider the best means—legislative and practical—of dealing with the wolf question?

If sufficient interest is taken in the subject, by ranchmen and others immediately concerned, RECREATION will publish a series of articles on the best methods of killing wolves; and the whole matter will be put in such shape that the State and territorial governments will be obliged to consider, seriously, the advisability of offering a maximum bounty for each gray wolf scalp taken within their respective limits.

## HOW TO LEARN.

A. C. H.

In answer to D. T. R., who asks, in *MARCH RECREATION*, how to learn to shoot on the wing, I would advise him to get a copy of "The Dead Shot," by "Marksman," published in 1864 by W. A. Townsend of New York. I have a copy of this work, and found it invaluable when learning to use the gun. It is just the thing for beginners and can be studied with great profit, by old shooters. There is always something to learn and to pick up; and this book treats the whole question in a very simple manner.

I would advise D. T. R., if he has an ordinary, every day length of neck, to use a gun that has about a 2 inch drop to the stock and a length, from butt to trigger, of about 14½ inches, or what may suit the length of his arm. The barrels should be 28 inches in length.

I advocate the straight stock, as there is no fear of a beginner shooting too high, or too far in front. The trouble is they shoot too low, and straight at the object, when they first start in. More birds are missed by shooting under, than over. One forgets that gravitation acts on the shot, in its passage; and when the object is aimed at point blank, the shot will strike below it.

All birds, when flushed, are rising, except when flushed on top of a hill; and the shooter will not kill his bird, if when in the act of pressing (not pulling) the trigger, he can see the bird above the muzzle of his gun. This is one strong point.

Another is, don't try to sight along the barrel. Keep your eyes open, and on the bird, and remember the hand must work with and obey the eye. Remember how you hit a chum in the back of the neck, with a snow ball. You don't look at your hand, but at the neck, and let go.

Keep your gun moving, at the moment of pressing the trigger. Don't stop it to pull the trigger, for if you do, you will miss and your shot will pass behind the bird. This is the secret of many a miss at a rapidly crossing bird.

Here are 3 secrets from "Marksman." If you master them—and you can with practice—you will be a good shot.

1st. At straightaway shots, keep your head up. Cover the back of the bird at the instant you press the trigger and let go.

2d. If a bird is crossing to the right, lay your head well over the stock, keeping the visual line on a level with the head of the bird, more or less in advance, according to distance, and speed with which it may be flying when you shoot.

3d. If the bird is crossing to the left, keep your head straight, letting the visual line be on a level with the head of the bird, and in front, from one to 24 inches, according to distance and speed of flight. Bear in

mind, that the most skilful and deadly shots, sometimes miss fair open shots.

In throwing your gun up, run your left hand well in advance of trigger guard, and keep in mind that the hand that presses the trigger must obey the eye. To learn this, correctly, take a common playing card; blacken it over; stick it up on a white fence, or board, say 25 yards away. Load with 2 drms. powder and 1 oz. shot. Turn your back to the card. Then in the act of turning about to face the card cock your gun, chuck it to your shoulder, keeping your eyes on the card, and the instant the butt touches your shoulder press the trigger. When you can fill that card full of shot, 9 times out of 10, I will guarantee you will down your grouse or woodcock, in cover, almost every shot; as you will then be able to pitch your gun on the object, every time, without poking about trying to take aim.

Never point your gun at a living object, unless you intend to kill it. Keep the muzzle from constantly staring at your friend.

## HOW THE SAVAGE WORKS.

CARRITUNK, ME.

In December last I started on a moose hunt with W. D. Sullivan and J. D. Merrill, of Boston. We made Hackett's camps, at Moxie pond, our headquarters. The first day out we saw 10 deer, but owing to the crust we got only 1 of them—a big buck. His antlers spread 23 inches. We next climbed Moxie Bald mountain, hoping to find caribou there; but found only some old signs. We had no good still hunting until ready to return home. We brought out 1 moose and 2 deer. We started 2 moose, a cow and 2 calves, within 1½ miles of Hackett's camps.

I find the Savage rifle will kill a moose as quick and as dead as any rifle I ever used. I know of a number having been killed with the Savage, and they all stopped within a few yards of where they stood when shot. Some of these I have killed myself, and none of them ran more than 100 yards. I have kept a record of game killed with this rifle, which I give below:

1st. Deer shot through point of shoulder; bullet passed through the heart and was found near kidneys; distance, 60 yards; ran 25 yards.

2d. Deer shot in neck; bullet lodged under skin, on top of neck; distance 100 yards; was dead when I got him.

3d. Deer shot back of shoulder, through lights; bullet passed clear through him; ran 50 yards; was dead when I got to him; distance, 50 yards.

4th. Deer shot through



.303 SAVAGE BULLET TAKEN FROM A MOOSE.

shoulder; dropped where he stood; died in a few minutes; distance 60 yards; bullet not found.

5th. Buck shot in neck, at 100 yards; bullet lodged on top of neck. This bullet I found, and send it to you herewith. Buck weighed 200 pounds. The other buck that was shot in the neck weighed 278 pounds.

6th. Buck shot through shoulders; bullet not found; distance 75 yards; did not run at all; weighed 210 pounds.

7th. Buck shot through body; ran 100 yards; gave him second shot; bullets not found.

8th. Deer shot through the body; distance 100 yards, dropped where he stood; died in a few minutes; bullet not found.

9th. Moose shot through shoulder low down; bullet passed through lights. He started to run, when I fired the second shot. He did not run more than 25 yards, and died in a few minutes; distance, 100 yards.

I think the Savage rifle will kill any game we have in Maine. I have killed a great many deer and moose, and used all kinds of rifles; but do not think I ever saw deer and moose die so quickly, or with so little shooting.

I find moose are becoming numerous in the country around Moxie pond. Have seen the signs of 22 different moose, within 10 miles of that pond, since the 1st. Hackett's camps are finely located for this hunting region. George C. Jones.

#### FROM OREGON.

I have just returned from a long trip in the Cascade mountains and will give you a few pointers as to Southern Oregon. The best fishing I know of is on the head of the North Umpqua river, above the canyon, although both North and South rivers are pretty good. Rogue river is also reasonably good.

There are plenty of deer all over Southern Oregon except in the valleys; that is, a good hunter can get 1 to 4 a day. Bear are quite plentiful about West Fork, just now, feeding on raspberries. There are still a good many elk both in the Cascade and Coast mountains and on the high ranges well back from the settlements. If any of your friends wishes to have some good bear hunting let him come to West Fork about the 1st of September, for a month's outing at Bear Camp, or Eden Valley. The bear hunting lasts only about a week, but owing to the late and early seasons it varies some, requiring parties to be on the ground when it does come or they may lose the chance for the season. No dogs required, for when the bear come they come by the dozens and are in plain sight in the short brush that carries the acorns, on which they feed.

Mr. Arrowsmith is an old friend of mine and anything I can do for any of his friends I will do with pleasure. I received RECREATION and am very much pleased with it. I found in the March number just what I was looking for; that is, information as to the work of the small bore smokeless rifle. I have never seen one of them and should like to try them on large game.

I will send you some short stories later in the season, but at present am too busy in the hills, as this is the time I make my money. I think of a trip through the mountains of Northern Washington next fall, if everything goes right, as that is a part of the Western coast I have never yet visited. I may be able, on this trip, to send you some photos of hunting scenes. Should you happen to visit this coast give me a call and see how I will treat you.

W. A., West Fork, Ore.

#### THE TEXAS GAME MARKET.

FROM THE "GALVESTON NEWS."

The convention of game protective associations, called to meet in Austin, is a declaration of war on the market hunter. The other kind, the man who takes life for the keen pleasure derived from the taking of it, poses as a friend of the game. The probable outcome of the conference will be a bill before the legislature prohibiting the shipping of game beyond Texas points. While this could not be called unfair to the market hunter, as far as regards the greater varieties of game, yet there are some kinds that are not salable at their best prices in our state. The lordly canvasback and the regal terrapin are not for us. They are for our betters, in New York and Washington. Rich epicures in those places do not hesitate at paying for a pair of canvasbacks a price that would buy a yearling steer in Texas. Terrapin, plover and the 2 ducks, canvasback and redhead, are the only game that can be shipped to Northern markets at a profit.

For Texas markets the canvasback classes with the mallard. This latter variety is seldom shipped out of the state, and sells in the game houses of Corpus Christi, Rockport and Lavaca at seldom more than \$2 a dozen. These same houses are paying \$8 a dozen for canvasback for their New York trade. Should a law be passed as intimated, the slaughter will go on as before. The only change will be that the sum realized by the market hunter will be less.

The ultimate extermination of game is certain; legislation can only defer the result. Game recedes from settled communities, and as the coast counties are now settling fast it is but a question of time when the waterfowl will be as scarce as that noblest of all Texas game, the wild turkey.

## A BELLIGERENT BULL MOOSE.

NORTH PLATTE, NEB.

We were camping on the East branch of the Penobscot, in 1891, between the head of Grindstone falls and the mouth of Wisataquoik stream. Priest was an old guide and hunter, but had been converted to a lumberman. He was short and heavy, and had a stiff leg. One day he started out exploring for lumber. About 9 o'clock he was going through a pine growth, when he ran upon a large bull moose. The animal charged him at once. Priest started up a tree, but before he got 5 feet from the ground, the moose was upon him. The man had always been in the woods and was accustomed to shinning up trees, so managed to keep on the side opposite the bull.

Three times the moose reared and struck down the sides of the tree, his hoofs swishing by Priest's head like rifle bullets. He kept on climbing, and soon was out of reach. Reaching a large limb, he seated himself, lit his pipe and awaited developments. The moose kept rearing and striking the tree, knocking off bark and pieces of wood. Well, the old man was kept there until about 4 o'clock in the afternoon, when the bull went away, releasing his prisoner.

Priest slid down the tree and came to camp as fast as his stiff leg would carry him.

That evening he prepared a birch-bark horn, for calling. After dark he and I started up the river in a bark canoe. The old man was mad, and wanted to kill some kind of a moose, to relieve his feelings.

The bank, where we intended to watch, was steep and high; the water deep along shore, but about 70 feet out it ran off shoal to a gravel bar. I held the canoe by a bush, from the bow, while my companion called, from the stern.

When everything was ready, Priest gave a long, low bellow on the horn, that rang for miles around. In about 2 minutes we heard an answer. After 20 minutes another call was given. The answer was nearer and louder.

On the bull came to within 30 yards, and stopped. Priest filled his horn with water and let it drip into the stream. In an instant the old fellow came with a bound and a roar. Before I had time to shove the canoe from the shore, he plunged over the bank, striking his forefeet fairly into the middle of the boat, driving them through the bottom. Kicking with his hind feet in the water, he was sending the canoe out toward the gravel bar. When we got into shallow water, I jumped and sang out to Priest to fire. He did so, and one shot did the work. This was the biggest moose I ever saw.

I have seen the old man many times since, and he never fails to recall the moose hunt, on the East branch.

C. E. H., Medway, Me.

Editor RECREATION: Duck and goose shooting was good last spring, although no one has made large bags of Canada geese, and many hunters returned empty handed. The unusual amount of rain and snow filled the sloughs and overflowed the prairies, so that the ducks had a large territory over which to feed and were comparatively safe from the hunters. Some of the best bags were made shooting from sandbars in the river. Redhead ducks were more abundant than usual and canvasbacks rather scarcer. The snow geese, or white brant, as they are commonly called, were so abundant, at some points along the Platte river, as to fairly whiten the fields where they feed; and an engineer recently told me he saw a 40-acre corn field literally covered with them. For some reason they are not hunted so much as the Canada geese, although they are much less wary. They are not considered so good for eating.

Old prairie chickens were more abundant last spring than for 3 or 4 years, and we hope for another season of good chicken shooting. As I was dressing, this morning, the booming of the cocks floated in at the open window, from the prairies adjacent to town, and raised bright visions of fine sport, with the large coyveys, in the fall. A wet spring is always most favorable, here, to a good hatch and an abundance of full grown grouse in the fall.

M. K. Barnum.

Sportsmen are beginning to realize that game is becoming less abundant each season. The conclusion reached by many, therefore, is that game laws are either loosely regarded, throughout the country, or the present laws are not strict enough.

Even in the olden times there were many strict laws for protection of game, which made poaching no less a crime than theft. The promptness with which General Washington acted, on one occasion, in punishing a poacher, might serve as an example for the proper treatment of pot hunters.

There was a certain worthless fellow, notorious as a poacher, who was known to frequently trespass on the grounds belonging to Mount Vernon. He had been warned time and again, by Washington, but continued his depredations. He would cross the river in a canoe, and with fowling piece make havoc among the canvasbacks that flocked to the low marshlands.

One day, as Washington was going about the plantation, he heard the report of a gun in the direction of the river. Surmising what was in the wind, he spurred his horse toward the sound. Dashing through the bushes, he came upon the culprit, just as he was pushing from shore. The fellow, seeing his danger, cocked his

gun and, with a threatening look, leveled it directly at Washington. He, however, without heeding it in the least, rode into the water, seized the canoe by the painter, and dragged it ashore. Leaping from his horse, he wrenched the fowling piece from the astonished poacher, and belabored him in such a manner as to make him wish the wide Potomac was between him and the irate General. He never trespassed again on the forbidden grounds.

Ralph Latson, Iowa Falls, Ia.

Editor RECREATION: One of the best and oldest ways of cooking fish or game in the woods, is as follows:

Having built a fire of size in proportion to the amount of food to be cooked, let it burn down to a glowing mass of coals and ashes. Wash and season your fish well and then wrap them up in clean grass, leaves, bark or cotton cloth. Then, after scraping away the greater part of the coals, put the fish among the ashes, cover up with same material, and heap the coals on top.

The fish cooks quickly—15 or 20 minutes—according to the size. Having once eaten fish or game cooked in this way you will agree with me that it is the best in the world for camp cooking.

Clay also answers the purpose of protecting the fish or game from the fire, if no other material is at hand, and in fact for game, or anything that requires more time for cooking, it makes the best covering. Wet paper is also good and is about the best of all for fish.

Probably most of the old veterans have tried this method of cooking, when in the woods or on the shore, but I have shown it to many guides and others to whom it is new, and now mention it for the benefit of any of RECREATION'S younger readers who may get caught away from home or camp without a frying pan. You should always carry a small bag of salt in your pocket when in the woods. It will often provide you the savor for a good meal, when otherwise you would have to go hungry.

Bergen, Hackensack, N. J.

Editor RECREATION: Deer hunting promises to be good next season, for deer are now low down and numerous. A few days since, I jumped 2, in sight of the house, and later saw a bunch of 20.

This morning a flock of black geese, so called, passed over. The river is high and muddy, and the ducks have gone to the lakes, back in the hills. A flock of ducks new to this section was on the lake a few days this spring.\*

At the last session of our Legislature, game laws were made more stringent. Perhaps the most important change is that

prohibiting the killing of elk at all times, thus placing this animal on the same footing with the bison and the mountain sheep. Owing to the rapidly diminishing numbers of elk, this is a wise provision, though I fear protection comes rather late. Trappers on the Little Snake river, in Routt county, say that for the past 3 or 4 years, elk have been going Northward into Wyoming, in bands of 300 to 400, while none have come back.

Under the new law, deer may be killed from August 15 to October 15. The open season for fishing, formerly June 1 to December 1, is shortened 1 month.

Many people in this vicinity, who depend on the tourists for a livelihood, are dissatisfied with the new law: though in my opinion it should be rigidly enforced. Every sportsman in the State should co-operate with the game warden, and aid him in every way possible. L. D. G., Dotsero, Col.

Editor RECREATION: Having hunted the wild bee for 25 years, from the Atlantic to the Pacific, I am satisfied that for hard work, the Puget sound region beats everything else on the continent. In following hives, one encounters a tangled jungle, composed of small thickets, so close a dog can hardly get through. Sallal, huckleberry brush, devil's club, and profanity make impenetrable thickets. On a warm day, this beats a Turkish bath by several points.

Again, when the tree is found, it is likely to be such a sky-scraper, as to make it practically impossible to save either bees or honey.

In favored locations the woods are full of bee-trees. To my knowledge, during the season of '95, in a small swamp, 19 bee-trees were cut. Even then all were not found, for more were discovered last season, and the wind recently blew down still another. I was told that last season one man near here found and cut 27 trees.

The find, in honey, yields from nothing to 150 pounds or more, according to season and time of cutting.

In one tree, with the hive 60 feet above ground, which I cut, the honey was so impregnated with formic acid as to be almost worthless. Another with the hive 98 feet high, was then cut to see if the greater height would have the same effect on the honey. The result was a mass of bees, honey and rotten wood. About 40 pounds was gathered, boiled, strained; and re-boiled until clear. Then it was too strong with formic acid to be used.

A week of hard work, with a glass, was occupied in finding this hive, after locating the tree. It is more profitable, on finding such a tree, to leave the bees in their sweet and lofty home.

Beeswax, Tacoma, Wash.

\* From the description that followed, I should judge the ducks to be redheads.—EDITOR.

While passing through Bismarck and Mandan, over the Northern Pacific, just after the floods of the Missouri, I had for some time been watching the vast fields of ice, on the Mandan flats, when my attention was called to the body of a deer that had evidently been crushed between heavy blocks of floating ice. It was lying on a stranded ice floe, not far from the railway embankment. This started the inquiry, how many deer were killed by the immense fields of floating ice that swept over the great stretches of low lands, where the deer congregate in winter?

I learned that citizens in the neighborhood of Bismarck had braved the dangers of flood and ice fields, with their boats, in the work of saving the deer. Over 100 were rescued. One party saved nearly 40. Some of the animals were driven ahead of the boats, through openings in the ice, while others were so chilled as to make it necessary to carry them. Almost all of the deer were liberated where they could take to the hills. A very few of the weaker were kept and cared for as pets. It is to be hoped other localities are blessed with sportsmen having the same noble spirit.

A. J. Stone.

I send you this clipping from the Gloucester "Daily Times" hoping you will find use for it.

Be it enacted by the Senate and House of Representatives that

Whoever takes or kills a rabbit, grey squirrel or chipmunk, or any land bird, except the English sparrow, within the limits of that section of this Commonwealth bounded by Squam river, Ipswich bay, Atlantic ocean, Massachusetts bay and Gloucester harbor, at any time within 5 years of the passage of this act, shall be punished by a fine of \$20 for every rabbit, squirrel, chipmunk or bird so taken or killed.

After the law was passed parties in Gloucester and Rockport bought 10 or 15 pairs of Canada hares, and liberated them in different parts of the cape.

If the law is strictly enforced it will do a great deal of good; as there are a number of quails, and a few partridges. Interested parties secured 2 pairs of pheasants. I do not know whether they were Mongolian or English, but they are going to breed them with a view to stocking the woods.

B. F. B., Rockport, Mass.

Many geese passed over here last spring. Warren is a good place for sportsmen. It is on the Great Northern railroad, 330 miles North of St. Paul. October is the best month for geese.

A man makes a mistake when he uses an 8 gauge gun over decoys. A 10, with No. 2 shot, is better for geese. I got into my pit at daylight, one frosty morning last October, with an 8 gauge gun. The shooting was lively for an hour; 12 flocks of geese came to the decoys, and I fired 24 shots,

dropping only 12 birds. With a lighter gun, I might have had at least 20.

The field was good for sneaking and that evening was covered with geese. The farmer wanted me to crawl up and kill "20 at a shot," but I did not disturb them, knowing they would come to feed in the morning. The fun of seeing 12 geese fall beats a pot shot every time. My gun was built for one bird at a time; and the reason I missed so many was because I did not have a crack shot in the pit to shoot at the same time. As it was, I could count every miss.

E. S., Warren, Minn.

ST. ANTHONY, IDAHO.

Editor RECREATION: I have just returned from a trip through the country where the game winters. Most of the game from the National Park formerly wintered here, as also that from Jackson's Hole, but the last few years the game has changed about a good deal; that is, the deer, elk and mountain sheep. The moose and antelope don't change much.

I started from St. Anthony, with my brother and another man, on the 1st day of May, and on the 2d we found where 7 or 8 buffalo had wintered, in 2½ feet of snow. As the snow goes off they work back into the National Park. I think the same bunch wintered here a year ago. I heard there were some out in the lava beds, and on January 1st, '96, went out to look after them. I found their trail. The man who told me where they were, wounded one but didn't get it. I followed the trail, by the blood, 6 or 8 miles, but it was storming so hard I had to give it up.

The past winter has been a hard one on game. A large band of elk wintered close to the buffalo, but no deer. The snow was so deep the antelope and deer wintered low down.

There are plenty of bear here, and I expect to catch some. Their hides will be good until July 1st.

A buffalo hide went from here, last winter, to a man in Chicago; and there is a nice mounted head for sale in a store in this town. I think there is also one that is not mounted.

George Winegar.

When a man kicks 3 times, good and hard, on my cabin door, at 5 o'clock in the morning, I naturally think something has gone wrong; but when he gets his wind sufficiently to tell me he is a reader of RECREATION I throw my door wide open; extend to him the right hand of fellowship and cordially invite him in. He is welcome to eat of my dough-gods and breakfast bacon; to smoke my new cob pipe and to ride my pinto bronk, who never hogs. Then I will loan this stranger my favorite rifle—a 50-95 Bullard express—which, by

the way, is a little out of date but never goes back on a friend. Well, in short, as this man is our kind of people, so I will just go along with him myself, and will show him over the finest hunting and fishing grounds on the earth.

W. H. Hubbard, Glenwood Springs, Col.

RECREATION improves every month and no sportsman can afford to be without it. I'm glad to see you roasting the game hogs. That's what they need. Enclosed find 10 cents for the fresh-air fund. "It's a good thing, push it along."

C. G., Tacoma, Wash.

It is estimated that 25,000 to 30,000 elk have wintered on the East side of Green river, and they have lately gone back to their summer ranges in the mountains. It is a picture not soon to be forgotten, to see a band of 500 or 600 elk, moving swiftly along the top of some high ridge, on their way to their breeding grounds.

Fully as many deer have also recently returned to their summer homes. Antelope are, in the words of the country sale bill, "too numerous to mention."

While on the range a few weeks ago I saw 11 mountain sheep. Among them was a ram with large horns. I also saw fresh signs of a much larger bunch. In the fall I shall try to get some of them.

Anyone in search of fine hunting can have it in this country, next fall. Grouse, sage hens, geese and ducks are plentiful, and trout are abundant.

Come out, Coquina, and pull on my latch string. I will send you away happy and loaded with trophies of the chase.

H. D. DeKalb, Big Piney, Wyo.

I have been a subscriber to RECREATION only a few months, but consider I already have value received. It is a magazine which gives a sportsman an idea of what game protection means, and what a game hog is. We have some true sportsmen here and also some "kill-it-all-to-day sportsmen."

I heard of a party hounding deer near by, so 2 friends and I took our 40-60's and watched them several days. They got scared and left the woods. Next season we will not go after the dogs, but after the men. I think they will then understand lawful deer hunting.

We are about to organize a boat and gun club. I expect soon to get a number of subscribers to RECREATION.

O. E. D., Siverly, Pa.

I am pleased to see that RECREATION is getting the large circulation it so richly deserves. My newsdealers, Hamilton &

Kendrick (the largest in the city), tell me that each month the demand increases.

I have had good sport coursing jack rabbits, with my greyhounds, near Denver, and have also had several coyote hunts on Kiona creek. During the winter, a tally was kept on the coyotes killed by greyhounds, near the creek. The number was 106. The neighboring stockmen and sheep-raisers are getting packs of greyhounds. Mr. Nott, who made the big killing, has only 5 hounds in his pack, but it is a rare occurrence for a coyote to get away.

L. F. B., Denver, Col.

We have lately had an example of what a game hog will do when he gets a chance. A. S. Eaton, and a party of 4 or 5 others, went out a few days ago and killed 240 ducks and 5 geese. It seems to me there ought to be some way to punish men who go to such extremes. Game is being rapidly exterminated by men who are thus wasteful of it.\*

Ducks are plentiful here just at present and the black bass and perch, in Seeley's lake, are beginning to bite freely.

Ed. L. S., Greeley, Colo.

A Canadian exchange reports that George Soles, of East Chezzetcook, shot 2 moose and a bear in 2 days, last fall. He got out the carcass of the first moose safe, but lost the other. He left the second moose in the woods to get help of neighbors to bring the carcass out. When the hunter returned for the meat he found it torn to pieces and a large part missing. The tracks showed a bear had been there and had made a meal off the moose. Soles waited for the bear, who came back about dusk and Soles killed him. The bear was a big black fellow, estimated to weigh 700 pounds. The skin measured 7 feet in length and nearly the same across the body.

The correspondent who signs his letter "An office man" is informed that many articles, containing such information as he asks for, have been published in previous issues of RECREATION, and if he will kindly give me his name and address, I will gladly cut out and mail him some of these. Other articles, of a similar nature, will be printed in future numbers. The list of guides who live in points on Long Island, in Sullivan Co. and in near by Jersey points, together with the kinds of game and fish they undertake to find for sportsmen, may be consulted advantageously. By corresponding with these guides the reader would get valuable points and need not thereafter employ the guides unless he chose to do so.

\* I hope the Colorado Legislature will soon provide for sending such swine to the State corral where they belong.—EDITOR.

P. C., Carthage, Mo., evidently meant to say, in exploiting his father's shooting abilities, "before they got off the ground," instead of, "before they got out of range." With reference to my brother's shooting, as reported in RECREATION: The birds were flushed by me, after having been found by "Sister," the best little pointer in Ohio, and my brother killed 3 dead and crippled the 4th so badly that we got it, too. It will be remembered he was shooting a Winchester repeating shot gun. But that's right, P. C. Make 'em give you all the details.  
Bert Cassidy, Chicago, Ill.

The Legislature made some changes in the game laws, but they are hardly any better than before. The provision for a State game warden was killed. There might as well be no laws, when there is no one to enforce them.

Illegal netting is going on in the Missouri, between Logan and Canyon Ferry. The result is a diminution of trout and grayling. Thousands of geese and brant passed over here, on their way North, last spring. The flight of ducks was small. Prospects are good for feathered game generally.  
A. B., Helena, Mont.

Our new game law is similar, in some respects, to others passed in Montana. With no game warden to enforce it, game will be killed and sold by pot hunters as heretofore. Every one who knows of it seems afraid to inform. One big party, coming into the State to hunt, leaves enough money to pay 2 or 3 wardens. With game properly protected, settlers and ranchers could get all the winter's meat they need, with plenty of game every year for sportsmen. As it is now the ranchers have to eat hog and tough beef.

W. A. H., Fridley, Mont.

A letter from the Rangeley region says: "Three deer, a buck and 2 does, made their appearance in front of the Ledge house April 22d, the first for the season. They came near to the house, and were tame. Apparently they were looking for their old place to get salt, which was then overflowed with water. The deer have become so accustomed to being fed with salt, and not being molested in any way, that one is almost sure of seeing from one to half a dozen every day, in the summer months, from the Ledge house piazza."

Colorado will be for some time a fine game State, if the laws are enforced. I think all reliable guides should be licensed and then appointed game wardens. There should also be a bounty on lions, coyotes, wolves, lynx, and bob cats, as they kill more game than do hunters.

I know where 2 big silver-tips holed up last fall, in a canyon about 20 miles from here. I am going after them soon.

C. A., Dotsero, Col.

For the benefit of W. C. S., and some others who have been annoyed by my letter printed in February RECREATION, I will say the game spoken of in that letter was part of the game I killed in 1896, and not in 2 or 3 days as it appeared in print. I regret the error should have been made but supposed every reader would understand that it was an error and that I had no intention of claiming I bagged it in so short a time.

W. H., Akron, O.

The spring flight of Canada geese was unusually large this year. The rainfall was heavy, and all the "sand hill" lakes are full. The prospect for fall shooting is good. Ducks and geese will be plentiful, though chickens are scarcer every fall. The sportsmen about here are making strong efforts to put a good big "crimp" in the game hogs, who slaughter thousands of young chickens for the market every year.

G. H. P., Pine Ridge Agency, S. D.

The deer have been about all run out of here, by prospectors; but I killed what I needed—6 in all. During the winter, I caught 2 foxes, 3 lynx, 1 cougar and 1 fisher. There is little sign of fur now. The foxes nearly all left last fall, but will come back up in the mountains when the snow is settled. This is the poorest point for fishing I was ever in.

J. H. C., Silver, Wash.

I am a regular reader of several sportsmen's periodicals, but RECREATION is away ahead of the others. We have good fishing and hunting in this locality. I hunted 2 days last fall and killed 8 deer. Bear and mountain lions are plentiful, with a good supply of small game, such as rabbits, grouse, ducks, etc.

J. B., Kalispell, Mont.

In the Northern counties of our State, deer are plentiful, with fair numbers of cats, lynx, foxes and an occasional black or brown bear; also quails, pigeons and grouse. Should any reader of RECREATION desire to come to this State on a pleasure trip, or to go hunting, he might arrange to accompany us on our annual outing.

Benj. W. Ferris,  
962 B'way, East Side, Oakland, Cal.

I like RECREATION very much and read it from cover to cover.

Game is plentiful around here. I saw 29



ducks Saturday. A boy shot one that day, but he did not know about the game laws.

I like to read about the old hunters, and the Indians, who killed buffalo before I was born.

H. L., Haverhill, Mass.

I saw in April RECREATION a few lines from E. N. H., of Reedsburg. I should like to ask that he favor us with a fuller account of the party's last fall hunt, in North Wisconsin, as I understand they had some experience with large deer, as well as some other fine sport.

A. H., Reedsburg, Wis.

Would like to know in what County, in the Western part of North Carolina, we could find the best hunting for deer, turkeys, quails and grouse; also good fishing.

C. W. L., Springfield, Mass.

Will some reader please answer?

EDITOR.

Not since I can remember has the prospect been so good for the next season's shooting. Rabbits, quails and squirrels are more numerous than for years. Game laws are generally respected, though the farmers nearly all concede the present rabbit law a farce.

J. T. M., Portersville, O.

About 30 of the lovers of outdoor sports have lately organized the "RECREATION GUN CLUB," at Eau Claire, Wis. Its membership includes the best shooters in the city, and will, no doubt, soon take a high rank among the gun clubs of the Northwest.

Geo. Hall, Eau Claire, Wis.

Mr. Benson, of Bass Harbor, has the only native grey fox in captivity, in New England. They are rare and this fellow is a beauty. Mr. Benson has been offered \$100 for the fox and refused it.

Two lads strolling about a piece of woods, on the Maine coast, ran across a den which contained 4 young foxes and a skunk. They captured the foxes but didn't disturb their partner.

The Manitoba Field Trials Club has selected Thomas Johnson, of Winnipeg, Manitoba, to judge their 11th annual Field Trials, which are to be held at Morris, Manitoba, on September 6th next.

Our State Legislature has passed a law prohibiting the killing of deer for 5 years, and the Governor has appointed E. F. Smith, of Hinton, State Fish and Game Warden.

John J. Baker, Fairmount, W. Va.

Would like to say, in regard to Dr. Cox's buck fever, that I shot the first 2 deer I ever saw, in less than one minute. Two shots killed them both and I never thought of buck fever.

E. N., Lynn, Mass.

Game is scarce about here, except rabbits and grouse. Fishing is good along the Missouri. RECREATION is a beauty.

J. G., Helena, Mont.

There is a law in this State prohibiting the chasing of deer with hounds; but it is not strictly enforced. A few days ago a doe was killed, by a party hunting with dogs. As a consequence of this nefarious practice game is becoming scarce.

N. N. B., Vancouver, Wash.

We have excellent deer hunting here, in season, and the fishing cannot be excelled in the State. This town is on the Wisconsin river and in the big woods, in the Northern part of the State.

J. C. W., Tomahawk, Wis.

The ruffed grouse shooting scene, in a recent number of RECREATION, is the most natural I have ever seen. The fallen timber, flight of birds and position of shooters are truly natural.

L. W. M., Dillingersville, Pa.

Your efforts in making a sportsmen's periodical have far surpassed my expectations. I do not see how any sportsman can get along without RECREATION. I am anxiously waiting to hear more from your expedition in the Rockies. I hope to hear from your own pen soon, at which Friend Leach says, "Amen."

A. G. T., Auburn, N. Y.

We had an abundance of snow last winter and ponds and streams are full this spring, for the first time in some years. Many lakes were entirely dry, and fish all gone; but when they fill up again the fish will return, in some mysterious way, and we shall have sport once again. Success to you.

W. O. R., Parker, So. Dak.

Will secretaries of gun clubs please send me several copies of their constitution and by-laws? Sportsmen organizing new clubs often ask for these.

Not a great deal of snow in the woods last winter. No crust and deer have wintered well.

S., Blue Mountain Lake, N. Y.

Quails are plentiful here, though last winter was very cold for them.

N. C., Susanville, Cal.

## FISH AND FISHING.

### A GOOD DAY FOR DOUBLES.

W. C. KEPLER.

The long purple shadows of evening stretched Eastward until they mingled in one broad band, subduing the colors of the foliage; and the more active sounds of daylight hushed with the gathering twilight. The soft voice of the river spoke more and more distinctly; joined now and then with the shriller voices that come with night.

In this delightful twilight hour, with rod in hand, I cautiously approached a deep pool that I knew, where the big bass loved to lie. Wild rice, now beginning its rank growth, formed a blind, back of which I could stand and cast almost to the farther side of the pool. A short distance below, Drummer and Tom were skilfully whipping the water, every now and then dropping bass into their creels. From time to time they would advise me to keep up with the procession. Drummer seemed anxious to have me in sight; for, as I was 1 or 2 ahead at noon, he was keeping a close tally on my afternoon's catch, for fear that in some way I should outwit them.

Unmindful of their attention, I loitered, dropping my flies on the smooth surface of the pools in every likely-looking place. After one cast, there was a moment of uncertainty; then, with a rush, a fly was taken. Hardly had the fish started on his first run, when a second shock set my rod quivering. I had hooked a double.

What uncertainty, what anxiety, attends such a catch! As you play the frantic pair, how intense your eagerness to land them! Here and there they went; sometimes starting in opposite directions, but bringing up with a surge that would have parted any but a good sound leader. Sometimes one was in the air, then the other; once both at the same time.

By careful handling, I gradually worked back from the pool; gently urging them in my direction. It was a difficult place, for it was necessary to draw them through a narrow channel in the river-grass. Into this the fish might easily dart, and by entangling the leader, free themselves. However, I managed to get them through and into shoal water. Even then I was disappointed, for the hook pulled from the larger one's mouth and he quickly disappeared into the grass. The smaller bass was easily captured.

The result of another cast was a repetition of the first; even down to the loss of the best fish. Three times more my flies landed in the pool; every time raising doubles. Three pairs were landed safe. The last cast brought the largest bass of

the lot—a 3-pounder—with a companion of about  $\frac{3}{4}$  of a pound.

After the last double, I tried once more; succeeding in lightly hooking a good sized bass, but lost him.

Although I have hooked doubles before, I never had the good fortune to land so many.

Leaving the pool, I soon joined my companions. The broad tail of the 3-pounder showed under the lid of my basket, and I could see Drummer screw his eyes around toward it.

"Well, how do you like the sample?" I asked him, exultingly.

"Huh! Been using bigger ones for bait all afternoon," was his calm answer.

"What a liar you'll be, Drummer, if you keep on! Better reform while there's time."

"I'll leave it to Tom, here, if I haven't been throwing back bigger ones right along."

I gave up; for what is the use of talking to such a man! After you have told a true story, that has a spice of novelty about it, he will tell some outlandish lie—no matter if the moss does cover it—and all hearers will laugh. Then you will feel as if your own true story was a fabrication. Some day that man will die, and I shall probably be hanged for murder!

---

### LAKE TROUT FROM MONTANA.

MAGDALEN, MONT.

Editor RECREATION: I have read in RECREATION the notes of Mr. Cummins and Professor Evermann, regarding Mackinaw trout in Elk lake, near the Madison divide, and as I live within a mile of that lake I can give you some information that may interest ichthyologists.

The picture on the cover of RECREATION, for February 1896, represents the fish as nearly as I can judge. I should say it is the same fish. The question as to whether these trout will bite has never been definitely settled. We have caught them with a net and have speared them at night, with a jack. As Mr. Cummins says, 8 pounds is the largest one that is known to have been caught, but many have been taken that weighed 3 to 5 pounds.

They spawn in the slide rock, at the edge of the lake, in September and October, the eggs being very large. The lake has no visible inlet nor outlet, except in the spring, when it overflows and a small stream runs out for a month or so. I irrigate from the lake and last spring when the overflow was running I opened my dams and let a lot of greyling run into the lake. These grow to

good size here, but will not spawn. We have never seen a small greyling in the lake.

There are also ling in this lake, which average about 10 inches in length. It is easy to account for these. They doubtless ran up some spring, when the water was high, from Red Rock lake. The latter, however, has none of these trout in it.

Elk lake is 70 feet deep in places. Between here and Madison river there is a chain of 4 lakes, Elk lake, Hidden lake, Cliff lake, and Wade lake. They are all in a canyon and it looks as if a river had run through there at some ancient time. The land no doubt slid in, in places, stopped the flow and made the lakes.

Elk lake is about 4 miles long and  $\frac{3}{4}$  of a mile wide at the widest part. Hidden lake is about  $1\frac{1}{2}$  miles long by  $\frac{3}{4}$  mile wide; no inlet or outlet. Deepest place about 70 feet. No fish have ever been seen in it. Cliff lake is about  $3\frac{1}{2}$  miles by  $\frac{1}{2}$  mile wide. In the middle is the top of a round mountain, covered with timber, and sticking out as if it had sunk there at some time. This lake has 2 inlets, but no visible outlet. Depth about 70 feet.

There are thousands of fish in Cliff lake, which look a good deal like our white fish. Some of them grow to be 2 feet long. They spawn in the fall and winter when one can go along the shore, where there are some small springs, and see thousands of them, some with their fins out of the water. You can shoot among them, with a rifle, and kill from 5 to 40 at a shot.

Wade lake, about  $2\frac{1}{2}$  miles long by  $\frac{1}{2}$  mile wide, has a large spring inlet, no visible outlet. No fish known to be in it. All these lakes have large springs breaking out below them.

I have never heard of the Mackinaw trout being in Henry's lake. I think the way Professor Evermann heard of them there, was through Sawtell and Rash, of Henry's lake, who sent some of the trout from Elk lake, to Washington, to learn what kind they were.

There is another lake in Montana that I know has the same trout in it. This lies West of the Big Hole basin, high up in the mountains. The outlet of it empties into the Big Hole river. It is a deep lake too. In the spring of 1888 E. W. Robbins and I caught 2 trout there, with hook and line. We were told some had been caught there that weighed 25 pounds. If these are the genuine Mackinaw trout, please say so in RECREATION; as nobody in this country knows what kind of trout they are.

James Blair.

This letter of Mr. Blair's is deeply interesting and the information given concerning the lake trout is important.

There are in the U. S. National Museum 3 specimens of the lake trout, which were received fresh November 12, 1887, from "Mr. Gilman Sawtell, Alderdice, Beaverhead Co., Montana." It is said they were obtained by him in Henry's lake. Each of these specimens is about 14 inches long, to the base of the caudal fin, and they seem to agree closely with other specimens of the same size from Lake Superior. They are therefore the Great Lakes trout, or Mackinaw trout (*Cristivomer namaycush*). This is the trout which is called "longe" in Vermont, or "togue" in Maine.

Its nearest relative in the West is the bull trout, Dolly Varden trout, or Western charr (*Salvelinus malma*).

The Mackinaw trout, or any species of the genus *Cristivomer*, can be readily told from all other trout by the color as well as by important structural characters. In all species of *Cristivomer* the spots are always gray instead of red, orange or black.

The Mackinaw trout is widely distributed. It occurs throughout the Great lakes region and in the lakes of Northern New York, Vermont, New Hampshire and Maine, Northward to Labrador and Boothia Felix—70° North. It is also known from Great Bear lake, from Camin lake, 20 miles East of New Westminster, British Columbia, and Mr. Ashdown Green, of Victoria, has obtained it on Vancouver Island, and perhaps elsewhere in British Columbia. It was also found by Dr. Eigenmann at various places along the Canadian Pacific, viz: at Calgary, Banff, Devil's lake, Golden, and Revelstoke. These localities represent the basins of the Saskatchewan and Columbia.

Many years ago Dr. Coues found it in Chief Mountain lake, on the boundary of Montana and Alberta. This is also in the Saskatchewan basin. In Alaska it has been found as far North as the Kuwuk river, within the Arctic Circle.

The finding of this trout in Elk lake, in the Missouri river basin, is interesting as it does not seem to have been hitherto reported from that basin.

All who are interested in questions connected with the geographic distribution of our game fishes will feel thankful to Messrs. Cummins and Blair for calling attention to the presence of this species in Elk lake. Cannot Mr. Blair tell us more about the other lake in which he caught the Mackinaw trout—just where it is, its name, how to reach it, etc.?

And now about the trout which Mr. Sawtell sent to the National Museum in 1887: It is very important to know, definitely, whether they came from Henry's lake or Elk lake. The letter accompanying them evidently said "Henry's lake." Can Mr. Blair unravel the matter?

Barton W. Evermann,  
Ichthyologist U. S. Fish Comm.

## HE WHO LAUGHS LAST, LAUGHS BEST.

E. G. H.

An amusing incident took place one day last May, at the opening of the trout season.

Charley and I, provided with our tackle and lunch, started one morning for a trout stream a few miles from the city. It was the second day of the season, and an ideal one for fishing, so we soon had our baskets well filled with good ones and went to a house on the farm, through which the stream flowed.

During the dinner hour the Italian farmer entertained us with stories of the large trout that were to be found near a small neck of woods about a mile distant, where his cattle were accustomed to graze; so after dinner we wended our way to this much lauded strip of land.

The stream made a large bend here and I took the upper part while Charley was below, about 100 yards away in a direct line but fully a quarter of a mile by water. We tried our luck. Intent on catching a big one I failed to notice, for a time, the low bellowing in the woods. Nearer came the sounds and louder. Charley had already heard them and said to himself, "Ah, ha! the bull. Krog will think it's a bear."

I finally looked up and saw a number of cows, as I supposed, coming toward me. Again, after another cast, I looked up and beheld a large black animal in the lead, throwing his head in a significant manner and emitting a low, grumbling noise.

Not being particularly anxious to make the animal's acquaintance, I reeled up and started toward Charley. When I looked back the bull seemed nearer. I increased my pace; so did the bull. What was Charley doing all this time?

"Look him in the eye." "Tickle him under the chin." "Look out or he will make a touchdown!" were some of the exclamations hurled at me.

But I did not follow Charley's advice. The bull was now close behind me. A few yards ahead I espied a log extending out in the stream. With one mighty effort I reached it and another took me across. Then I looked around and saw the animal, with uplifted head and tail, evidently much disconcerted at the loss of such an opportunity.

Meanwhile Charley was roaring and splitting his sides with laughter. The bull, attracted by his gesticulations and now thoroughly infuriated, started for Charley. The meadow was wide. There was no log to cross. The nearest place of safety was a hill, 200 yards away. With basket in one hand and rod in the other, Charley began the race. The bull gained. Charley dropped his basket but still the bull gained.

Then the rod was cast aside but this only seemed to lessen the distance between the 2. He could not reach the hill; but a high stump was before him and with one final effort he reached it and clambered on top.

It was now my turn to laugh. "Talk to him in Italian." "Are you getting any bites?" "Mesmerize him!" were wafted over the stream to Charley. He implored me to go after the owner of the bull, which I did after I got through laughing. The Dago's first exclamation was:

"Oh, he no bite."

I yelled to Charley to come down; that the bull would not bite; but for some reason Charley would not come.

The bull was finally led away and we resumed our fishing in peace, deciding not to say anything about it when we reached town; but it was too good to keep.

## CATFISH IN LOUISIANA.

WASHINGTON, D. C.

Editor RECREATION: I have just returned from a trip through the South, during which I devoted some time to a study of the catfish industry of Louisiana. This business centers chiefly at Morgan City, 80 miles West of New Orleans, on the Atchafalaya river, though a good many fish are shipped from Melville and Plaquemine.

The catfish industry is an important one, the shipments from Morgan City alone amounting to about 2,000,000 pounds annually. Nearly the entire catch consists of 2 species of large catfish, the first being known as the blue cat, or *poisson bleu* (*Ictalurus furcatus*), the other the yellow cat, or goujon (*Leptops olivaris*). One or 2 other species are occasionally taken.

These catfish reach an immense size, examples of each species weighing 80 to 110 pounds being frequently taken. The largest I saw, however, was a goujon which weighed 48 pounds.

This is the only place I know of where an important fishery is carried on in the woods! During ordinary stages of water the fishing is done principally with trot-lines, or set-lines, which are placed in the river or its connecting lakes and bayous; but when the Mississippi "gets up" somewhat, the greater part of the Atchafalaya region becomes flooded. Then the catfish take to the woods and the fishermen follow them. The fishing is done in this way: One end of the line is tied to a limb of a tree, and the hook, on the other end, is allowed to hang about 18 inches under water. The hook is baited with a piece of a hickory shad, or with a crawfish. Each fisherman ties his lines to the trees along the edge of one of the "float roads," if possible, so they may be easily found. If he places them promiscuously around, through the

woods, he blazes the trees to enable him to find them again.

This method of fishing in the woods recalls certain lines I once saw in *Punch* apropos of the proposed introduction of the American catfish into England:

"Oh, do not bring the catfish here;  
The catfish is a name I fear.  
They say the catfish climbs the trees  
And robs the hen-roosts; down the  
breeze  
Sends the prodigious caterwaul.  
Oh, leave him in the Western flood,  
Where the Mississippi churns the mud.  
Don't bring him here at all."

There are 3 firms at Morgan City which handle catfish exclusively. The fish are dressed, then shipped in ice to various Western States, chiefly Texas, Oklahoma, Kansas, Colorado and New Mexico, though a good many are sent North and are served in the best restaurants of Chicago and other large cities, as "trout tenderloin."  
B. W. Evermann.

#### A WHOLE HERD OF FISH HOGS.

The same bunch of Stevens Point (Wis.) swine, who a year ago boasted of having gone to a creek near Plainfield, and, in one week caught over 1,000 trout, returned to the same water, a month ago, put in another week of hard work and caught but 500 trout.

That's right, piggies. Clean them out, as fast as possible. Don't let one of them escape. These 2 reports would seem to indicate that you won't be able to get any trout there next year unless the State comes to your aid, meantime, and restocks the stream. Then you can get another crop of fingerlings.

Here are more "records":

B. B. Park, C. H. Grant, and R. B. Johnson spent Saturday and Sunday with the 4 lone fishermen, Hadcock, Boston, Ball, and Sherwood, who were trout fishing at Idlewild, Waushara county. In a few hours 4 of them succeeded in capturing 121 trout.

H. G. Curran, E. Ruben, and Dr. Houlehan spent part of Tuesday near Liberty Bluff, Marquette county, where they caught 196 trout.—Stevens Point Gazette.

Fishing is good now. White bass plentiful. One man caught 136, from 9.30 A.M. to noon to-day.—Oshkosh Correspondent.

Truly Wisconsin is in great need of a branding law. These men should all be marked, so that sportsmen may know them wherever found.

Here is more of the same kind of news:

People of this city and vicinity, who delight in catching fish, have had fine sport the past week. Mackenzie creek, which enters Cannon Lake 4 miles west of Faribault, is the attractive place. The finny tribe are being caught by the

wagonload. Lines and spears are not used, but instead pitchforks, corn-scoops, and shovels are used to shovel them out. Several wagon boxes full of fish have been standing on the market, offered for sale, many of the fish yet squirming. Buffalo, bullheads, and some pickerel are among the catches.—Faribault (Minn.) paper, Feb. 11th.

Andrew H. Jackson, a millionaire real estate agent of New York city, fished in Sand Bar creek, near Mountain-dale, in company with Jacob Gunther, one of the most experienced fishermen of this city, to-day, and secured 142 trout, weighing from a quarter of a pound to one pound and a half each. This is considered one of the greatest catches made in years.—Middletown, N. Y., despatch to "New York Herald."

And still another:

All other claims to the championship record, in trout-fishing, have been thrown into the garbage-dump since John K. Bryden returned from Tidioute. While there, on business, this week, he was taken by William Grandin, of that place, on a fishing trip to Minister creek and Queen Run. For some reason best known to themselves the trout took to biting with phenomenal fury. The 2 fishers actually basketed 500 trout, all fine ones. So large was their catch that the "sportsmen" (?) had quite a task to distribute them among their friends.—"Franklin (Pa.) News."

If any of their friends had been real sportsmen they would have refused to receive any of the trout, or ever after to associate with the swine who slaughtered them.  
EDITOR.

#### THE FIGHT AT THE BIG HOLE.

ELMER E. FRENCH.

You may have fought the silver king in Florida, or the salmon in Northern waters. You may have captured the fierce muskallonge of the St. Lawrence, and won many other hard fought battles. Yet as you sit by your fireside and recall happy incidents that occurred afield or on the water, there will rise before you the struggle with that monster fish caught when you were a lad.

When a boy, up in Maine, I had such an experience. In the White mountains, under the shadows of Mt. Whittier, lies beautiful Lake Ossipee. From it there flows Eastward the Ossipee river, which joins the Saco, 20 miles below.

My father's farm was divided by the Ossipee, and the buildings were in sight of the water.

Across the river, was interval land, yielding fine crops of hay. When it came time to cut the hay, the farm hands crossed the river in a boat. The stream here was about 8 rods wide, shallow most of the way, then suddenly going off into what was called the "big hole." Here trout had rendezvoused for years.

One day I stayed behind to fish this hole. I had no fancy rod—just a plain pole, cut in the woods, the small end as big as my thumb. The line cost 5 cents, while the hook was strong enough to hold anything.

I soon had a fat grasshopper on the hook, and took a seat in the boat. The

grasshopper had not kicked more than twice on the water when I had a "good hard bite." I held on, but the fish was master of the situation, for a time. He ran toward all points of the compass, and in one of his rushes, pulled the pole against my head, knocking a new 50-cent straw hat into the water.

I can even now see that hat sailing gracefully down the stream.

The howl I sent up was probably heard for a mile around, when I saw, with one eye, that my hat was gone. I say with one eye, for I kept the other on my line.

At last the fish began to yield; his rushes became weaker and weaker; then he came to the surface, displaying the flag of distress. I left the boat for the shore, not ceasing to cry, and dragged the fish out on the bank.

With tear-stained face, bare-headed, but fish in hand, I started for the interval. My coming was announced by weeping and wailing. My father, in alarm, left his work to see what the trouble was. As he met me, he quickly took in the situation and burst out laughing. A little praise, with the promise of a new hat, put me at ease. I could now sit down to admire my fish—a roach, it was called—which weighed about 2 pounds.

Since that time, I have landed much larger fish from the same hole, yet the day I caught the roach is looked back to as a red letter day.

### BIG TROUT.

Editor RECREATION: I hand you here-with clippings from the Cincinnati "Enquirer" regarding trout and size of same.

We are catching, daily, in Jackson's lake, all the trout we can use; fat and in fine condition, that weigh from 3 to 8½ pounds and measure up to 27½ inches long. We use only pieces of meat or fish for bait, on a short piece of binding cord and a common hook. The lake seems to be alive with trout.

I notice they assume different shades of color. Those caught in shallow water, say 2 feet deep, have a light yellow color and pale spots, and those taken from deep holes, near projecting banks, are deep green—almost black on the back. Does light and shade have this effect on trout?

B. Harris, Jackson, Wyo.

The clipping above referred to says:

Blaine County (Oregon) sportsmen are boasting of a recent catch of mountain trout, in Twin lakes, at the head of the Malad, about 9 miles from Soldier, on Camas prairie. It was made by Alexander Sifers, the sawmill owner. While fishing with hook and line, Mr. Sifers and associates hauled out 3 trout that weighed 11½, 11, and 6½ pounds, respectively, or an aggregate of 29 pounds. The big trout is beautifully speckled, with iridescent or "rainbow colored" sides; is 15¼ inches around the belly and 27½ inches long. They are plump and fat as a fish a year old.

Last fall a Boston paper published this item:

T. D. Ketchen, of Boston, who is at Long Lake, in the Adirondacks, arranged last week a fishing contest, giving \$50 for the largest number of fish and \$5 for the largest pickerel caught. Guides Dunphy and Lafell won the prize for the largest number, 137, weighing 57 pounds. Cross and Girard took the prize for the largest pickerel, weighing 11¼ pounds.

This is wrong. Side, or prize hunts, or fishing contests, of all kinds, are condemned by all true sportsmen.—EDITOR.

### HARBOR SPRINGS, MICH.

Editor RECREATION: No doubt F. D. C. was mad when he read W. G. E.'s letter. His reply indicates that. I have fished Maple river, near Petoskey, and have taken grayling, one after another, exceeding 1 pound and many that weighed 2 pounds each. While I have never taken trout and grayling at a single cast, I have taken them from the same pool.

He says grayling leave as soon as trout come. This is true in part. Trout eventually drive the grayling out, but not at once. Grayling have been taken, during the past season, from this stream, and trout have been there for 6 years, to my knowledge.

If F. D. C. does not believe trout are taken in the vicinity of Petoskey, that weigh 2 pounds each, I would request him to pay us a visit and I will show him a living specimen, taken from the "Minnehaha" last season, that will convince him he knows little about trout fishing hereabouts.

Sinker.

### MAINE FISH NOTES.

E. M. Blanding, of Bangor, has been supplied by the United States fish commission, and the Maine commissioners of inland fisheries and game, with about 5,000 Swiss lake trout which have been placed in waters along the line of the Mt. Desert branch of the Maine Central Railroad, largely in Phillips lake, but a portion in Holbrook's pond. These trout were hatched at the U. S. hatchery in East Orland and average upward of 3 inches in length.

The guides and sportsmen of the locality have formed an organization at Sherman Mills, to be known as the "Southern Aroostook Sportsmen's Association." The following officers were elected: President, P. E. Young; vice president, F. E. Robinson; secretary, H. B. Sleeper; treasurer, C. A. Wren.

F. E. Eastman, of Portland, and C. D. Record of Readfield, Me., landed 12 trout, in Lake Maranacook, 3 of which weighed 11 pounds, the larger weighing 4½ pounds.

S. L. Small and Dana Crockett, of Dexter, caught, in the thoroughfare between Sugar Island and the mainland, 4 trout, the combined weight of which was 14 pounds. They weighed 5, 4¼, 2½, 2¼ pounds respectively.

C. C. Moore, of New York, enjoyed some good fly fishing, killing 12, 14 and even up to 30 trout a day.

A laker weighing 29 pounds was captured off Norcross Brook. The Mohawk Fishing club also had good luck, taking 67 trout in one day.

Geo. Emmett, Attleboro, Mass., secured his full allowance and has the record for the largest square-tailer, thus far. It weighed 4¾ pounds dressed. Mr. Emmett fished most of the time off Green island.

Over 100 landlocked salmon and trout were recently caught at Green lake, Me., in one day.

John T. Clark, Geo. W. Harriman, A. C. Jerrard, F. T. Hall, E. J. Murch, S. A. Maxfield, Charles J. Hutchings, Dr. W. L. Hunt, Dr. C. P. Thomas, and B. L. Hexter, all of Bangor, were among the lucky anglers.

On another day 6 salmon were landed, at the Bangor pool. E. A. Buck, Mr. Burnett, of Glasgow, Scotland, Archibald Mitchell, Judge Briscoe, John Porteous, and J. M. Johnson, all of Norwich, Conn.; J. H. Peavey and Samuel Drinkwater, of Bangor, were the winners in this sport.

The eggs at the fish hatchery, in Liberty, are hatching finely, especially the trout eggs, and it looks as if there might be about 12,000 trout and some 5,000 salmon to put into the lake, when large enough.

Great catches are reported from Sebec lake. The Commissioners of Inland Fisheries and Game visited the lake recently and report numerous catches of fine landlocked salmon.

F. G. Kinsman and Dr. E. G. Briggs caught a fine string of fish at the same place. There were 18 bass weighing 43½ pounds. One of them weighed 4¼.

John Mayers, of Dresden, took a sturgeon from one of his weirs, which measured 8 feet 2 inches in length.

A. W. Thayer, Augusta, caught a square tailed trout, at Lake Cobbosseecontee, that weighed 3½ pounds.

A shad weighing 9½ pounds was recently caught in St. John harbor.

We have a canoe club here, named after your magazine. Why couldn't canoe clubs be organized in all of the places where

there is water enough, and known as the Order of RECREATION Canoeemen. I can think of nothing more pleasant than for the lodges, from 4 to 5 neighboring towns, to take an outing together on some lake or river. If this were done and the qualifications for membership should be the same as in Walton, your subscription list would soon reach 100,000. Some time when you have a little extra space will you please mention this to your readers? I think it would pay. It would furnish sport and a very pleasant outing.

M. Sheldon Brandt, Walton, N. Y.

This is an excellent suggestion and I am deeply grateful to Mr. Brandt for it. I will gladly co-operate with any and all friends who may feel inclined to work on these lines.

EDITOR.

Perch fishing has been excellent in the vicinity of Little Falls, and near Four Mile run. Large strings have been taken. The fish, however, were rather small.

Universal satisfaction is expressed with the new fish law. Everyone is anticipating an excellent bass season when it reopens. With the number of bass transferred from the B. & O. canal to the river, we should have it. Local anglers had fine sport with the bass on the upper Potomac, before the season closed, April 15th.

Large numbers of shad have been brought into the city. It is said this is the best season they have had for a number of years.

E. G. H., Washington, D. C.

I noticed in the April number of RECREATION "F. D. C's." statement regarding trout and grayling in the vicinity of Petoskey. I also read "W. G. E's." statement and it is truthful in every particular.

I am something of a fisherman myself, and have often caught 25 to 60 trout in a day, that would weigh from ¼ pound up to 2 pounds each, and have taken trout weighing nearly 3 pounds. I have seen trout and grayling taken from the same pool, on more than one occasion. I have known of trout being caught, within 16 miles of Petoskey, that weighed over 3 pounds, and can produce plenty of evidence to prove it.

A. I. S., Petoskey, Mich.

The fishing season opened fairly well here. Several fine strings of trout were taken by local fishermen. West Hill pond, about 28 miles from here, is becoming a popular resort; there being excellent shooting as well as fishing. Several new cottages have been built together. With the usual camping parties, there will be a large colony this season.

E. B. G., Hartford, Conn.

## GUNS AND AMMUNITION.

### THE QUESTION OF THE DAY.

J. A. MACKENZIE.

What is the best gun, for the money? The man of limited means, who cannot afford to put more than \$30 or \$40 in a gun cannot go amiss if he buy one of the leading American guns, such as the Hollenbeck, Ithaca, Baker, etc. If anything goes wrong with one of these it is easy to right it, and their cheap grades will wear and shoot as well as their high priced. It is no longer necessary to go abroad and pay \$300 in order to get a good reliable gun. Here in America are firms that turn out weapons that for strength, beauty and shooting qualities are the equals of imported guns at twice the price. The Ithaca, for close hard shooting, is the equal of foreign guns of 4 and 5 times the price; and in many cases it surpasses them. Where can you get, for 4 times the money, such simple, durable guns as the Syracuse Arms Company turns out?

Beware of the cheap shams manufactured in England and Belgium, for the American market. They are a disgrace to any dealer who handles them. Well do I remember my experience with them. My first shot gun was one of these, for which I paid \$25. It shot fairly well but the locks were so soft and so poorly put together that they played out after every 200 or 300 shots, and the notches had to be filed deeper. Screws were constantly stripping and getting lost, causing no end of trouble. I was glad to get \$10 for it; and now I place full confidence in my little Hollenbeck, made by the Syracuse Arms Company.

I believe this Company makes the most thoroughly up to date gun on the American market to-day. Here are my reasons for thinking so. It has fewer parts than any other, and simplicity is strength. The simple cross bolt, working on a vertical axis, is self tightening; takes up wear and passes clear through the extension rib into the other side of the frame, making a fastening that for strength and durability is unsurpassed in any gun. By self tightening I mean, as you will see by the cut, that it draws the barrels to the standing breech.

This system of locking is becoming more popular every year. Shooters are beginning to feel the need of a more lasting and secure method of fastening the barrels to the standing breech, than the underbolt, even when combined with the doll's head extension rib, in order to withstand the tremendous strain of nitro powders, and not shoot loose. Many old reliable guns, that had been shot thousands of times with black powder and had remained tight, were

turned into rattle traps by the new smokeless powders, not to speak of several dangerous accidents. This was owing to the greater strain, at each discharge, which sprung the barrels from the standing breech. To overcome this difficulty gunsmiths have adopted two remedies, namely, leaving more metal at the angle of the frame, and making use of a top connection. Early in the 60's Westly Richards brought out his doll's head extension rib, with sliding bolt engaging in a slot on its rear face. This was followed by Greener's cross bolt, which has come into so general use. This was a great improvement and his guns have a world wide reputation for durability or the power to withstand heavy charges. There is one serious drawback to this bolt, however. It does not draw the barrels to the breech and, if worn by the constant friction, would not hold them there. Without that self tightening power that takes up wear no lasting durability can be had. Greener guns are, however, made of such excellent material, and are so nicely fitted together, that they have been fired thousands of times without any perceptible wear. The doll's head extension rib exerts a holding force, especially if its anterior surface is an arc of a circle, of which the hinge pin is the centre. This is true so long as it fits the slot in the frame, and is held in position by a good underbolt; but the slightest wear on its bearing surface will allow the barrels to part from the breech and this renders it useless. Underbolts always weaken the frame by cutting away the metal at the angle where the greatest strength is needed. Besides a great holding down force is not necessary, as has been proven time and again by discharging the gun when held in the hand, with the bolt withdrawn. Even if this force were needed the top connection has still far the best of the argument, for it acts nearly twice as far from the point of leverage. Consequently, by the laws of forces, it will have twice the power.

The adoption of smokeless powders has also brought about improvements in the appearance and balance of guns. It is well known that nitros exert a much greater bursting strain on the gun barrels than black powders; and various experiments have shown that this train comes mainly at the head of the cartridge chamber, where there is a sudden diminution in the thickness of the metal. If this part of the barrel is made sufficiently strong the remainder may be quite thin. In cylinder bored guns the muzzles may be left as thin as ordinary writing paper; but with full choked barrels more metal must be left at the cone of the choke to prevent its being shot out. Thus



the most of the metal is put at the breech end of the barrels, giving them a graceful taper and bringing the weight more between the hands, making a much more handsome and finely balanced arm.

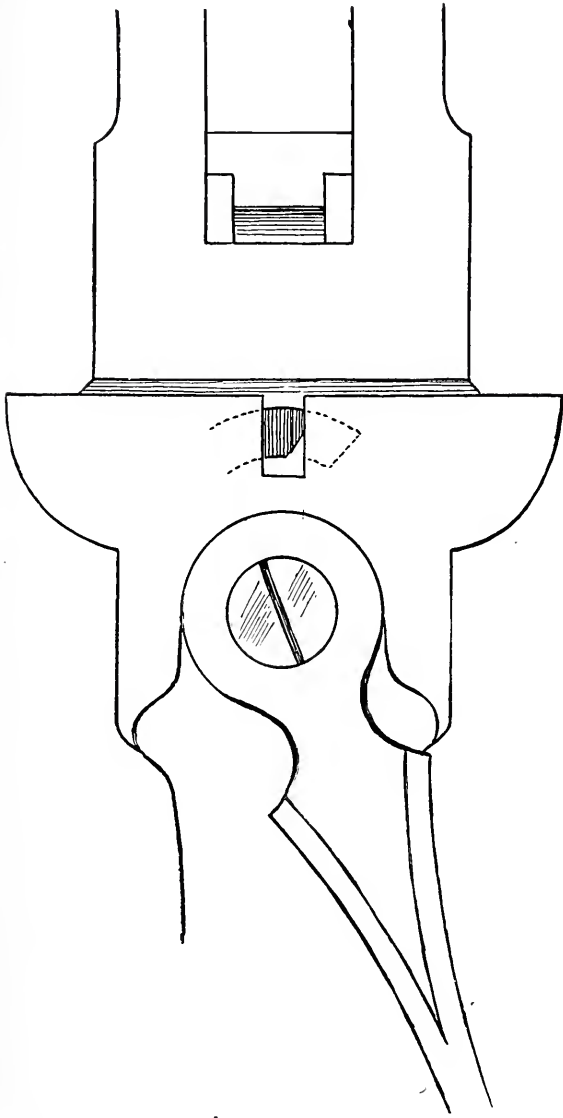

FULL SIZE CUT OF FRAME OF HOLLENBECK GUN, SHOWING POSITION OF CROSS-BOLT WHEN HALF DRAWN BACK, AND WHEN GUN IS CLOSED.

But these are not all the changes made necessary by the new explosive. It was found that to give the best results the gases must be more confined, both in the cartridge cases and in the barrels. This is accomplished by using plenty of heavy felt wadding, one size larger than the bore, in strongly crimped paper shells, and in nitro boring the guns. Guns thus bored are contracted more at the muzzle, and while giving good results, with small shot, are not always satisfactory with the larger sizes. Gunmakers are also boring their guns more true to gauge than formerly:

so that a 12 gauge will take a No. 12 wad, or a 16 a No. 16. In the new vena contracta guns the bore is very much contracted, a gun taking a No. 12 shell gradually tapering down to a 20 bore and so continuing to the muzzle. It is claimed for them that they shoot as good as the ordinary 12 gauge and are much smaller and lighter. The latest change I have heard of is the square muzzle, with which the inventor

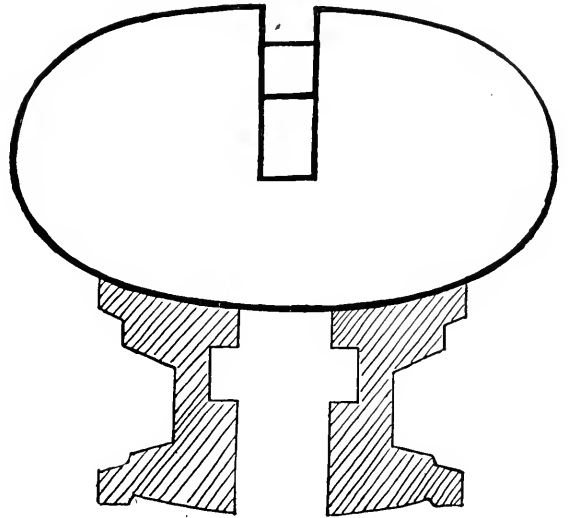

CROSS-SECTION, THROUGH ANGLE OF THE FRAME, OF GUN WITH UNDERBOLTS, SHOWING HOW THE METAL IS CUT AWAY.

claims he can get better pattern and penetration than with the round; but this remains to be proven.

As for repeaters, they are not the thing for brush and grouse shooting. The magazine full of cartridges, under the barrel, makes them clumsy and heavy to handle, especially in quick, snap shooting; and the manipulation of the repeating mechanism destroys the aim for the second shot. In grouse shooting, nowadays, more than 2 shots in rapid succession can seldom be had, and it is a great advantage, in all upland shooting, to have one barrel shoot close and the other open. For quail there is no better combination. On the bevy rise you get in your cylinder barrel and then have plenty of time to use the choked. Two cylinder barrels are not a bad combination, in the early season, as most of the birds can be shot within 25 yards; but in the cold blusterly days of November the full choked barrel will be taxed to the utmost.

The little 16 bore is coming more in favor, for the little brown Bobs. It requires closer holding than the 12. The latter is none too large for the ruffed grouse, which need good hard hitting. With these birds most of the shots, in the early season, are at short range in dense

cover; but even then many long shots are offered as an occasional bird sails off among the trees, or crosses from one cover to another. Late in the fall, when the birds are wilder and the woods more open, shots may be all the way from 15 to 60 yards. Even in woodcock shooting one frequently gets a long shot at an old cock, which, roused by the dog from the deep seclusion of his boring ground, darts in erratic flight over the tops of the willows, to be lost to view among the tremulous leaves of the aspens.

I have never shot snipe, but from all accounts they have their wild and their sluggish days, necessitating the use of a gun equally adapted for short or long range shooting.

To sum up I would recommend, for upland shooting, a 12 gauge, with 28 inch barrels; the right a cylinder and the left full choked; to weigh not more than 7½ pounds. Mine weighs 7, which is heavy enough to carry all day, over rough country. If the sportsman can get a day or 2 at ducks, every fall, or is fond of the traps, he had better get 30 inch barrels, with the right slightly choked. Of course the man who can afford 2 guns, or 2 sets of barrels, need not be hampered in this way.

Whatever you do, get a stock to fit you. I use one 14¾ inches long, with 3 inch drop. My height is a little over 6 feet. Go into some big establishment, where a large stock of guns is kept on hand, and try several. Fix your eyes on some small object and bring up the gun, without removing them from the mark. If the gun covers it correctly it is a fit. It is best to see about 1-3 of the rib, from the muzzle; for then the gun will shoot a little high—a good fault if not overdone.

The craze, nowadays, is for straight stocks, especially for trap shooting. It may be all right for pigeons, which rise fairly regular; or for men with supple necks; but for game you want such a stock that the eye will come naturally at the right height for correct aiming without taking any notice of the breech end of the barrels. When you have found such an one measure the drop at the butt, and the length from the fore trigger to the centre of the butt plate, and send your order to a reliable American firm, or place it with a responsible dealer, and you may rest assured you will get what you want. Most firms will send their guns C. O. D., allowing one day for trial, and will send a pattern and a written guarantee with them. If you are not satisfied all it will cost for the examination is the expressage both ways.

Will some fellow sportsman write an article for RECREATION about the relative toughness, durability, etc., of twist, Damascus, and steel barrels, and of the best methods of choking?

## RELOADING SMOKELESS SHELLS.

ENTERPRISE, IDAHO.

Editor RECREATION: I have read with deep interest the reports given by several of your correspondents as to the accuracy and killing power of the new 30 caliber smokeless rifles. I cannot learn that any of them have ever tried reloading the ammunition. Where a man is so situated that he can get the cartridges when wanted it does not pay to reload; but we who live in the mountains, remote from railways and gun stores, are almost compelled to do so. My partner and I each own 30-30 smokeless rifles. We wanted to reload our cartridges and to use, in some of them, black powder and a hardened lead bullet, which would be equal to a reduced charge. These we would use for target practice, at short range, and for small game.

Using the "Ideal" reloading tools we had been able to reload our 25-25 and 50-110 cartridges perfectly and thought we could do so with the 30-30. At my request the Ideal Manufacturing Company made me a set of 20 caliber reloading tools that was perfection in its work, as are all their gun implements. We began our tests with FFG Dupont's rifle powder, and 160 grain bullets, one part tin to 12 parts lead.

The result was a terrific recoil, a blowing off of the neck of the shell or a splitting of the shell clear to its base. As to accuracy the cartridges were all right and the penetration, at 30 yards, was 13 inches of green pine. The bullets would, however, occasionally turn over and strike sidewise.

In the next lot we reduced the powder charge to 20 grains, which increased the trajectory and decreased the penetration 5 inches. I then used soft lead bullets and 30 grains of same powder, with same results as to recoil and bursting of shells. Then I used a 110 grain bullet and about 15 grains of powder, filling up the shell with sawdust and seating the bullet down solid on top of it. At 50 yards this charge was fairly accurate and the penetration 4½ inches; but after one shot the shells were so swelled as to be unfit for further use.

To sum up, the tests we were able to make were not at all satisfactory. This I conclude is caused by the rapid twist in the rifling of the nickel steel barrel. One peculiar feature was the twisting of the bullets. At least 1 in 8 turned over.

The tests were made with both Winchester and Marlin 30-30 rifles, and with U. M. C. and Winchester shells.

In a recent issue of RECREATION I learn that cartridges for these rifles are now made with a reduced charge of smokeless powder, which will afford the proper results for target practice and small game shooting. We have ordered a large supply of these and have given up all attempts at re-

loading smokeless rifle shells. With good tools and a great deal of care ordinary rifle black powder shells can be reloaded to give good results, but no more second hand smokeless cartridges for me.

The new smokeless rifles give us perfect satisfaction in every respect. We find them thoroughly effective on big game and shall use them exclusively, hereafter. Black powder guns are a thing of the past. The 30 caliber shell, with soft nosed bullet, has about 3 times the killing power of a 50-110 Winchester express and has none of the objectionable recoil and smoke. I am sure it will please all who give it a fair and impartial trial.

Now why can't we have a 22 caliber smokeless rifle, using about 10 grains powder and an 86 grain bullet, for small game and for target shooting? That would be about equal to our 25 and 32 caliber rifles, in range and effectiveness.

M. W. Miner.

I have owned or shot samples of all the better guns made in America, as well as several of English make, and find good shooting qualities in the Parker, Davis, Remington, Ithaca, Baker, Winchester, Lefever, Whitney and several others. The hardest hitting American gun I ever fired was a high grade Whitney safety gun.

A short time ago I had the opportunity of targeting a high grade pigeon gun made by Wm. Cashmore, of Birmingham, England, for a Des Moines sportsman and can truthfully say, the Cashmore gun has the most remarkable shooting power I have ever found in any gun. For pattern, penetration, fine balance, close fitting joints, finish, and all that goes to make up a high grade arm, this Cashmore certainly leaves nothing to be desired.

Your readers who desire to learn more of this make of gun, should write Mr. Cashmore, Steelhouse Lane, Birmingham, England, for a catalogue of his guns, mentioning RECREATION.

C. H. Kessler, Des Moines, Ia.

## TESTING THE ARMY RIFLE.

KANSAS CITY "STAR."

The Krag-Jorgensen rifle, which has been adopted by the United States government, is not a humane weapon of war. It has been the belief of army officers and surgeons that the 30-caliber, steel-jacketed bullet which the Krag-Jorgensen shoots would either kill a soldier instantly or leave a wound which would enable him to fight on without knowing, for a long time, he had been injured. This theory was completely dissipated at a trial of the rifle made yester-

day under the direction of Dr. J. D. Griffith, ex-surgeon general of the Missouri state militia.

The test showed that at any distance under 1,000 yards the ball from this rifle rends human flesh, disintegrates human organs and shatters human bones into fragments. Beyond 1,000 yards—and the gun will carry 3 miles and kill—the bullet bores a small round hole through bone or tissue.

It will bore a hole through an oak tree a foot in diameter at a range of 2 miles; perforate steel plates; plunge into solid earth a distance of 18 inches, after passing through a human body. Yet a small pile of loose, dry earth will arrest its flight and tear it into fragments. Scientists' explanations as to why this is so are very unsatisfactory, but all admit that it is true. To protect himself against the Krag-Jorgensen bullet, a soldier needs neither forts, trees, armor nor steel plates. He can dig up a pile of loose earth, 18 inches in diameter, with his trowel bayonet, and, lying behind this apparently insecure barrier, be assured that all the bullets fired at him will be flattened before they reach him.

For the tests made yesterday a human head and several legs of human cadavers were used. The targets were placed in front of a high embankment and Dr. W. T. Stark and General Milton Moore, of the state militia did the shooting. They began at 500 yards, and over 200 rounds were fired at various distances.

One of the first bullets fired struck the head, just above the nose, at a range of 500 yards. The skull was shattered as if it had been an egg shell and the bullet buried itself in the embankment, where it was dug out later, as bright and perfect as when placed in the rifle. Other bullets pierced the skull and splintered the bone in radiating lines. The bullets also tore the bones of the legs into long splinters.

The test was to ascertain the effect of the bullets on human bones and it was proved that they would not bore small, clean holes through osseous substances, at less than 1,000 yards.

After the shooting at the parts of cadavers a few experimental shots were tried at loose and solid earth. Bullets fired into the solid earth went out of sight, but in loose dirt they were stopped within 2 feet. One bullet, fired from a distance of 20 yards, into a pile of loose earth, was found in the centre of the hillock. It was completely flattened and its steel jacket was twisted into a ragged shape. There was little resistance to the earth, as one could easily push a finger through it.

Two Krag-Jorgensen rifles were used in the experiments, one the infantry gun and the other the cavalry carbine. The only difference between them is that the carbine is a few inches shorter. They shoot with equal accuracy up to 500 yards.

## BLUING AND CASE HARDENING.

Can you give a recipe for case-hardening or bluing, for the purpose of refinishing such smaller parts of guns and rifles as become worn bright, by use, and to restore their original color. G. U., New York.

ANSWER.—For bluing, the general method is to polish the metal thoroughly and then place it in heated charcoal, letting it rest awhile, well covered from the air. Then remove the metal and rub the surface down with waste; then put it back again and repeat this operation 6 or 7 times, depending on the work. Finally the rich blue color will be obtained.

For some of the small parts the method of "dipping" is also used, this being to dip the metal in a bath of saltpetre, manganese, etc. If it is a very small part, or only a portion of a part, the color can be brought back by placing in a gas flame. Heat it until it almost reaches the color you wish; then dip it in cold water.

For general refinishing and re-bluing of parts, it is better to send them back to the factory. The cost of having parts re-blued would not be so great as the expense of making ready to do the work. Parts like sights, forearm tips, triggers, etc., you can probably bring back to a proper color in the gas flame.

## CASE HARDENING.

The case hardening finish is obtained by the following process: The part is polished and then packed in burnt bone. This is usually placed in a cast iron box, and care should be taken to have the metal covered by the bone. The pieces of steel must not come in contact with each other. The box in which the work is placed, covered by the bone, is then placed in the furnace and heated red hot. Then the box is removed and the contents dumped in clear, cold water, running water being preferable. In order to give good colors a fairly large size of bone should be used—that is, say about the size of peas. Finer bone will harden as well, but will not give the colors.

J. V., Cleveland, Ohio, asks for the opinions of some of the small bore cranks as to the best rifle for shooting the 22 short and long cartridge.

I will recommend the Marlin every time, for accuracy, style and workmanship, and am glad to see it advertised in RECREATION. I have a Marlin repeater, model '02, 32 caliber, using both center and rim-fire cartridges and fitted with Lyman combination front and rear sights. It is the most accurate rifle I ever saw. I can drive nails with it at 25 yards, and at 60 yards can

hit 1½ inch pieces of paper nearly every time.

I load my own shells, with a set of Ideal reloading tools, which are as near perfection as any tools can be.

If anyone wants an accurate rifle let him get a Marlin safety repeater, fitted with Lyman sights, and he will have an arm that will make him happy.

Be sure to keep the rifle clean. For very close shooting I clean after each shot, with a clean woolen cloth.

I have tried the square point, 32 caliber cartridge, that O. J. B. speaks of, and am convinced the killing power is very much increased by cutting off the end of the bullet. The penetration is not so great but I think the shock, to whatever the ball hits, is greater; and it makes a hole as large as that of a 38 caliber conical bullet.

RECREATION grows better every month, and I am doing all I can to increase its circulation. F. E. B., Brimfield, Mass.

Editor RECREATION: I notice in RECREATION one problem that has never been satisfactorily solved; and that is how a charge of shot can be held together and made to go in a solid body a certain distance. I have given this subject careful thought and have spent a great deal of time experimenting on it. I have a 12 gauge gun that was once full choked, but it never carried the shot close enough to satisfy me. I took the barrels in my shop, made a steel reamer and commenced scraping them inside. I kept at it until I gave them a true taper, the variation being 1-16 of an inch from breech to muzzle, this being what I term a true taper choke. I have tested this gun with U. M. C. loaded shells, No. 4 shot and ¾ drams powder. I shot at the end of a log, a foot in diameter, at 135 yards, placing 3 shot in the end of the log and several under it. I found, on the snow, the spread of the charge to be 4½ feet.

I think, therefore, a gun with a true taper choke will give any shooter perfect satisfaction. A friend who had a 12 gauge Winchester shot gun made a shot at the end of the same log, with No. 8 shot, placed 4 pellets in the end of the log and 20 under it. The spread was less than 4 feet. His gun is also a true taper choke.

M. B., Conway Centre, N. H.

L. H. B. says he would like to hear from hunters regarding the large bore rifles vs. 45-90 and 50-110. I have been hunting since 1872 and have used all kinds of guns, from a 22 caliber to a 56 caliber. Am now using a 25-35 Winchester smokeless, and there are but 2 guns on the market that can beat it for stopping qualities. These are the 30-30 Winchester, or Marlin, and the 30-40 Winchester.

Two of my neighbors are using 30-30

smokeless rifles. They first used the soft nosed bullet but soon dropped it on account of the great damage done to the meat; and are now using the full cased bullet. I have killed only 3 elk with my 25-35, 2 of which dropped dead in their tracks. The third fell when the ball hit him, but got up and ran 50 or 60 yards, when he fell dead. I shot 1 mule deer, that fell dead in 20 yards. Have also killed 4 mountain goats, 2 of which were lying down and which never tried to get up after being hit. The other 2 were dead before they fell—to all appearances.

I have been using this gun 5 months, and it is plenty good enough for me. I got 100 cartridges with the gun and have 23 of them yet. Have shot a few at target and a good many at grouse.

M. P. Dunham, Woodworth, Mont.

#### TO REMODEL NAVY RIFLES.

There is said to be a great deal of dissatisfaction in the service against the new .236 calibre rifle, in use in the navy. The experimental weapons shot well at first, but after a few rounds the bullet began to strip, and, of course, to fly wild.

This it is said is caused by the tremendous pressure set up in the narrow bore by the large charge of nitro powder, the long, heavy bullet, and the sharp twist of the grooves. This pressure averages 56,000 pounds to the square inch, and is sufficient, after a few shots, to permanently expand the barrel. As it was found impossible to prevent this in any barrel of permissible weight, the naval authorities have been compelled to lighten the bullet from 135 grains to 115 grains, although this will seriously impair the penetration and range of the rifle.

In spite of these drawbacks the lighter bullet will have some advantages. For instance, its initial velocity will be increased from 2,460 feet to 2,550 feet a second, which will flatten the trajectory, during the first 500 yards of its flight; but owing to its relative lack of momentum, it will lose velocity far more quickly than the longer one; hence its range will be shorter and its flight more curved at all ranges over 500 yards.

Happily there is no dissatisfaction felt regarding the action of the Naval Board. The American Lee straight pull rifle has undoubtedly the best military action in the world, and should the .236 bore fail to give satisfaction it would be an easy matter, although perhaps an expensive one, to replace the first issue of arms by rifles of larger calibre.—New York Herald.

NORTH PLATTE, NEB.

Editor RECREATION: I have been deeply interested in the reports of results obtained

with the various .30 calibre rifles and smokeless powder, by sportsmen hunting large game. Everyone who has an opportunity to observe the practical working of these new rifles and ammunition should report his experience to RECREATION for the benefit of less fortunate brother sportsmen.

The points on which there are conflicting opinions about the .30 calibre rifles are: their accuracy at long range; their killing power on large game and their general value as a sportsman's weapon. For such game as antelope, elk and bear the 30-40 ought to be most desirable, for it has great power; yet this cartridge is the one about which there seems the most difference of opinion.

I see the charge of powder variously stated as 36, 40 and 44 grains and would request someone who knows, to say just what the U. S. Government 30-40 cartridge is loaded with, viz., how many grains of powder and of what make. M. K. B.

Will you please ask, in RECREATION, if any reader can give me any knowledge of the shooting powers of the Savage small bore rifle? I am in a quandary as to what rifle to buy for shooting big game. I have seen the Winchester and the Savage rifles (small bore) but have never seen any one use either; so would like to hear from any one in regard to the Savage rifle, in particular; also if any reader can tell me if the soft nose bullet is more effective than the solid bullet.

I am deeply interested in your wonderful little magazine. It is a prize to sportsmen, and the only trouble I find is waiting for it, from one month to another. I have it all read through, long before it is time for another. Guns and ammunition is the first department I strike for, and I wish there were lots more on that subject. Am showing your magazine to all my friends who I think have the least spark of a sportsman's enthusiasm about them, and hope RECREATION will reach the millions, which it will if given justice.

G. R. Roberts, Northfield, Vt.

J. V., Cleveland, Ohio, asks for the opinion of small-bore rifle cranks, as to the gun for using the 22 short and 22 long cartridges. I have used a number of 22 calibre rifles, from the best makers, and find they all shoot accurately the cartridge designed to be used in them. From my experience the best rifle, containing the least number of parts, easiest of action, and simplest of construction, that will handle, with accuracy, the 22 short, long, and long rifle cartridges, is the Marlin repeater, model '92. I use one of these, equipped with Lyman combination rear sight and ivory hunting front sight, and want nothing better. S. E. O., Fort Scott, Kans.

I should like to say to A. H. W., Amarillo, Texas, that I once owned a lever action Winchester repeating shot gun and liked it very much. I now own a model '93 and don't want anything better. They shoot as hard and as close as any gun I ever saw. One of my friends says he is bound to have one this fall, if it is to be had. I have shot both large and small shot out of mine, but would not recommend larger than No. 6 for a full choked gun.

T. A. H., Burnet, Tex.

Will you kindly tell me if, in your estimation, a 22 calibre rifle would be injured by shooting B.B. caps in it?

*Ans.*—It certainly would. The fulminate in the caps attacks the steel and rapidly destroys it. If the use of these caps be extensive, this chemical action will continue and the barrel will, in time, be badly eaten out. I spoiled a good rifle in this way before I learned what I now know on this subject.

EDITOR.

In answer to A. H. W., Amarillo, Texas, I would say that for the last 22 years I have been using both shot gun and rifle, of many different makes, and for the last 3 years I have used a Winchester repeating shot gun, of 12 gauge, with  $3\frac{1}{4}$  drams powder and  $1\frac{1}{8}$  ounce No. 8 shot. I have killed game with this gun at 127 yards. It is also the best gun at the trap I have ever used. In fact it is superior to any gun I have ever seen.

Chas. T. Pinkham, Brooklyn, N. Y.

I have just found that a 16 gauge shell fits nicely inside a 12 gauge, and would like to ask, through RECREATION, if a 16 gauge shell, with base cut off, would not make a good shot case, for long range shooting. If it would go solid for 30 yards, why would it not be as good as a cut shell? My idea is to take a No. 16 shell, cut off the base, put in the shot, wad both ends, load in a 12 gauge shell and shoot from a 12 gun.

E. R., Newton Centre, Mass., Box 109.

I should like to hear, through the columns of RECREATION, from any one who has had experience with the new model '95 Winchester, 40-72-330, box magazine repeating rifle. Should like to know if they are thought nearly as effective on large game, such as bear or moose, as the 45-70 '86 model.

H. M. Bacon, Newton, Mass.

Replying to P. J. M.'s question, in RECREATION, as to Lyman sights: I have used a set of these on my rifle with marked success. Any man can, with a little practice, if he follow the instructions given in Lyman's catalogue, not only shoot much more

accurately but much more quickly and easily than with any other sight I know of.  
"Bang."

I would like to hear from some of the brethren, through RECREATION, who have used both 12 and 16 gauge guns, as to the killing power of each. I do not know which to buy, a 12 or a 16 gauge. Will someone kindly enlighten me?

J. A. B., Osage, Ia.

G. W. Denton, Roswell, New Mex., claims to have one of the first guns the elder Greener ever made. It is a double gun—1 shot barrel and 1 rifle—the latter under the former. It is said to have been owned, at one time, by Abraham Lincoln.

How well will the Winchester shot gun, cylinder bore, 12 gauge, shoot a solid, round ball? In firing rapidly, at game, with black powder, does the smoke obstruct the vision? How well, does the cylinder bore shoot small shot?

Rifle Crank.

## WEN' DE OL' HOUN BAYS.

W. A. KEICKHAM.

Oh de stars is jes' a crinklin'  
But de moon is in de dark;  
De sly ole coon's a-runnin'  
So you listen an' you hark,  
Wen de ol' houn bays.

De pups is runnin' rabbits,  
Cos a pup ain't got no sense;  
Ol' coon is jes' a laffin',  
Cos de show aint done commence  
'Till de ol' houn bays.

Dar's a hummin' in de tree tops  
An' a ripplin' in de run,  
An' it only lacks de music  
Dat's pretty nigh begun,  
Wen de ol' houn bays.

Oh, Glory! did you hear it?  
Oh, Marser! hear it ring;  
It's as meller as de Autumn  
An' as welcome as de Spring,  
Wen de ol' houn bays.

Dey ain't no music like it  
Fer dese ol' ears o' mine;  
It tingles in de fingers  
An' it warms de heart like wine  
Wen de ol' houn bays.

De yeller gals low laffin',  
Wen de moon is in de full,  
Is pretty nigh to music;  
But to feel de heart strings pull,  
Hear de ol' houn bay.

## NATURAL HISTORY.

### A GULL'S FUNERAL.

Gulls have funerals. I have seen one of their funerals myself. My home was, a little time ago, in what was then the Hotel Imperial, at the corner of 12th Street and Michigan Avenue, Chicago, Ill. From the upper stories of this hotel an outlook was had over the water area to the North in front of the heart of the city, and of downtown Michigan Avenue, where many of the great hotels are located. In this waterfront area many breakwaters run out here and there, but the gulls do not mind breakwaters. They hover in vast numbers above the lake close to Chicago; for from Chicago's outlets comes the food which gives sustenance to hordes of them. They are wonderful, these gulls. Cold does not affect them, for they are on the ice-cakes all winter and feed on what drifts to them. They swoop all about, up and down, as cheerful as they were in the warmer months. But this is not a story of their life or nesting, and departure and breeding. It is but the account of one of their funerals.

One Sunday I saw a group of what are called "toughs" creep out along the breakwater. One of them had a gun. He shot into a group of hovering gulls, of which there were myriads dipping up and down in front of the Michigan Avenue fine hotels. He hit and crippled a gull and it fell, shrieking, into the water. Immediately all the other gulls flew away out over the lake, but the wounded bird did not cease its clamor. The ruffian who had shot it clambered from the breakwater into a boat and rowed out clumsily and, finally, caught the crippled thing, pulled it into his boat and killed it.

Then followed something curious. The host of gulls came sweeping back and swirled about above where the city brute was rowing back with the dead gull lying, wings outspread, beside him, in the boat's bottom. They gave utterance to cries quite unlike those they ordinarily make along the Chicago water-front and, though short, as understandable as the notes of the Dead March in Saul. Then, gradually, they rose higher and higher. They rose until there were thousands of them flitting back and forth vainly together, at a height of perhaps 800 feet. Suddenly there seemed to come to them some sense of order. They rose, together, very high, swinging about each other as they rose and giving utterance to a strange, protesting cry. They paid no more attention to the man rowing along with the dead bird in the boat. They began to circle and still to rise until it was hard to distinguish them apart and then began to swing in circles like poised hawks,

the whole open mass of them all the time drifting away slowly to the Southwestward until they were lost in the blaze of the light of the early afternoon. That was the first gull funeral I ever saw.

The other day I saw the same thing again, although the gulls seemed to circle individually on this occasion, till as they came together, like swinging hawks, about 2,000 feet above the city's roofs, they swung off again, far up in the sky, toward the Southwest, floating like a group of buzzards. I suppose that, an hour or two later, they came to the lake again, because the funeral was over.

This all seems odd and unnatural, but, let anyone shoot a gull on Lake Michigan, in front of Chicago, and see what will happen! Is the same phenomena noted on the sea-coast, or do only the inland gulls have these sky-seeking funerals? What does it all mean?

---

### WOMEN TO THE RESCUE.

It is a matter of comfort and congratulation that a movement to protect our singing and other native birds has been inaugurated which promises to bring a permanent result. The old Audubon Society which, for a time, accomplished much good, both in the East and West, had, somehow, failed in energy and, within the last year or two, cheap bird butchers have slain robins, and orioles and purple wing blackbirds (grakles) and bluebirds, and others of our common birds, by thousands and tens and hundreds of thousands. These were for the decoration of women's bonnets. There is likely to be a change now and a permanent one. The women's clubs of the country are actively engaged in the reform and, as they include the leading women of the greatest cities and towns of the country, the crusade is likely to affect the tradesmen and stop the slaughter. As the killing has been done in nesting-time, when birds' plumage is at its best, each bird killed has meant the starving to death of a nestful; and so the decrease in bird life has been enormous. Now there will be a change. At the head of the movement is Miss Ada C. Sweet, late President of the Chicago Woman's Club, and all, or nearly all the women's clubs in the country seem responding to the movement. Mrs. Ellen M. Henrotin, President of the National Federation of Women's Clubs, is not less earnest, and the leading women of the country seem banding together, everywhere, to bring an end to the infamous and cruel fashion.

It is matter of congratulation that the

sportsmen's clubs—for there is no greater lover of birds than the real sportsman—are joining in the movement. The Illinois Sportsmen's Association has already passed resolutions in approbation of and promising support to the new movement; and, no doubt, other sportsmen's clubs will follow. After all, we may keep our native birds as the country grows. The women can accomplish much when they stop to think, and do as their kind hearts really dictate.

### JOIN THE ZOOLOGICAL SOCIETY.

RECREATION believes the New York Zoological Park is bound to be a grand success. It is skilfully planned, wisely managed, and is therefore worthy of universal support. Moreover, it is to be developed on entirely new lines, and the genuine American originality in the idea should commend it to every man who is proud of this nation.

To build an ideal Zoological Park, such as this will be in 3 years, requires a lot of money. The city furnishes the land, which is worth \$1,000,000. It also furnishes \$125,000 in cash, for ground improvements, and an annual maintenance fund starting at \$60,000. The Society must raise \$250,000, by subscription, to be used in erecting buildings, and in the purchase of the original outfit of animals. For the money with which to issue its publications, promote animal painting and sculpture, establish a fine zoological library and a collection of pictures, run its "Members' Building" and do a host of other good things, the Society must rely solely on the annual dues of its members.

We need, and must have, at least 2,000 annual members, paying \$10 each per annum; and RECREATION is helping to get them. All readers who are interested in the work of the Zoological Society are invited to become members, and to help push the work. Full information, and blank applications for membership, will be furnished by RECREATION, on request. Let me hear from you.

The following shows what the officers of the Society think of RECREATION'S efforts in this direction :

NEW YORK ZOOLOGICAL SOCIETY,  
NEW YORK, May 11, 1897.

Editor RECREATION: On behalf of the Executive Committee of the New York Zoological Society, permit me to thank you most sincerely for your very helpful interest in the proposed Zoological Park, and for the 15 good men who have joined the organization through your personal solicitation. Such hearty co-operation is very encouraging. It is of the kind that

will eventually make the Society a great power in the field of Zoology, and its Zoological Park a crowning success.

A few years hence, when we are on the flood tide of prosperity, and in shape to offer substantial returns to every member, we will have members in plenty; but it is the men who come in now—at the beginning—who are willing to take us "on trust" for a year or 2, and who help us to start the ball rolling, that we will always appreciate most highly. The Zoological Park is going to be a big thing, a magnificent institution; something that millions of people will be proud of! The public cannot begin to realize how fine and how delightful, to every sense, it is going to be until it is in our power to make a visible demonstration of it. Again thanking you, cordially, I am

Yours very truly,  
William T. Hornaday, Director.

### AN ANTELOPE AND A GRIZZLY.

I wish to ask for the measurements of the largest antelope head known. I have an unmounted head that measures as follows:

|                                  |             |
|----------------------------------|-------------|
| Length of left horn.....         | 13¼ inches. |
| Length of right horn.....        | 13 "        |
| Spread of horns at tips.....     | 8½ "        |
| Spread of horns at widest part.. | 11 "        |
| Length of skull.....             | 13 "        |
| Circumference of horns.....      | 5 "         |

It was killed in 1894 by my father.

I also wish to know the measurements of the largest bear on record.

A silver-tip was killed in the fall of 1895, by Jas. R. Morganidge, the fresh skin of which measured as follows: from tip of nose to tip of tail, 8 feet 6 inches; across the fore legs, 9 feet 4 inches; between the ears, 9 inches; from between the ears to end of nose, 18 inches. This hide was not stretched to make it measure more. It was measured lying loose on the ground, after having lain there over night, which would make it shrink. The measurements are exact, for I made them myself.

A mule deer was shot near our house that weighed 182 pounds after its entrails were taken out and its head cut off.

John E. Brock, Maysworth, Wyo.

In regard to measurements of prong-horn antelope heads, and of silver-tip grizzlies, the readers of RECREATION have the floor. It is greatly to be regretted that Master John could not have had an opportunity of measuring the dead grizzly in the flesh, for he is evidently a careful observer, and one of the kind whose measurements and notes are valuable. EDITOR.



## THE BAND-TAILED PIGEON.

*(Columba fasciata).*

The boys here have been having lots of fun with wild pigeons, but do not kill many, for they are difficult to approach. I am *positive* in regard to the birds being wild pigeons, for I have killed a good many during the years I have handled a scatter gun, my first ones being killed on the Salinas river, Monterey County, Cal.

One day I saw a flock go over here that I think I am safe in saying contained 1,000 birds. They come from the mountains (the Sierra Nevadas) nearly every spring, stay until about the 15th of April, and then go back.

Have taken 2 pictures of the birds, and if negatives develop properly will send you one. De Witt Salisbury, Chico, Cal.

The interesting notes printed above refer to a bird almost unknown East of the Mississippi, save to naturalists. The species referred to is not the spike-tailed "passenger pigeon," once so common throughout the Mississippi valley, but the "band-tailed pigeon," having a blunt tail with a black band across the middle of it. It is one of the largest of American wild pigeons, and its home is the Pacific coast region West of the Rocky mountains, from the State of Washington to Arizona, Mexico and Guatemala. EDITOR.

## HOW MANY?

How many buffalo are left in the United States, and what is a genuine buffalo robe worth? H. J. A., St. Mary's, Kan.

I assume your inquiry relates to wild buffaloes. There are now but 3 small bands of wild buffaloes alive on the whole North American Continent. In Yellowstone Park there are barely 30 head (some say not so many). There are 15 or 20 head in Lost Park, Colorado, and perhaps 150 head in the British Possessions, Southwest of Great Slave lake. Within 2 years more, the heads and hides of all those now alive, in Yellowstone Park, will be in the hands of the human hyænas who hang around the Park, and who in 6 years have reduced the Park herd from 300 head to 30, or less.

Buffalo robes have not half the value that most people suppose. In 1888 25 good robes were thrust into my hands (without my consent) to be sold. New York fur dealers would not touch them at any price, because the buffalo robe was no longer "in the market," or in demand; and the dealers did not care to create a demand when there were only 25 robes with which to supply it. Finally I succeeded in selling the

robes (untanned) to the Hudson Bay Fur Company, at Winnipeg, at \$20 each. Good tanned robes were then purchasable in Minneapolis, Montreal and New York, at prices ranging from \$20 to \$35, according to size and quality. EDITOR.

## RABBITS CAN SWIM.

I have heard a number of sportsmen say they never knew of a rabbit taking to water and swimming; but I have known of an instance. One day in summer, a few years ago, while Charley Dodge and A. M. Tufts, of Lynn, Mass., were fishing on Spring Pond, near Lynn, they saw a creature swimming. At first they thought it a muskrat; but somehow it seemed to act differently.

By way of experiment, Dodge clapped his hands loudly, when up went Bunny's big ears—and gave him away! At once the boys pulled after him, and he began to swim for dear life.

The rabbit reached the shore ahead of his pursuers, who naturally thought he would vanish instantly, and be seen no more. But such was not the case. When my friends reached the shore, they found Bunny lying there soaking wet, quite exhausted, and unable to run away. They picked him up, looked him all over, dried out his fur, and finally put him down, when away he went.

Now that rabbit took to the water of his own accord, and at the place where he went in, the pond was over 200 yards wide. This is the only case of the kind I know of, but it proves that rabbits can swim.

H. M. G., Morrisonville, Vt.

J. R. Bennett and E. E. Darrow, while cutting wood on a farm 2 miles Southwest of town, made an interesting discovery. In the heart of a pine tree, 4 feet in diameter, and embedded in the solid wood, they found the nest and the shriveled remains of 2 birds which, from their appearance, had been yellowhammers; but unlike the toad that is found, at stated intervals, imbedded in the solid rock, the birds were dead. Although the tree had grown over solidly, there were traces of a hole having been there when it was small.

Estimating the time by the growth over the hole, the birds must have taken their last peep out about the time the Astor party went by, on their way to Astoria, and having missed the train, had to walk. The remains of the flickers look a good deal like a mummy, and there is a sad expression lingering about their eyes that suggests long years of waiting.

Garfield (Wash.) "Enterprise."

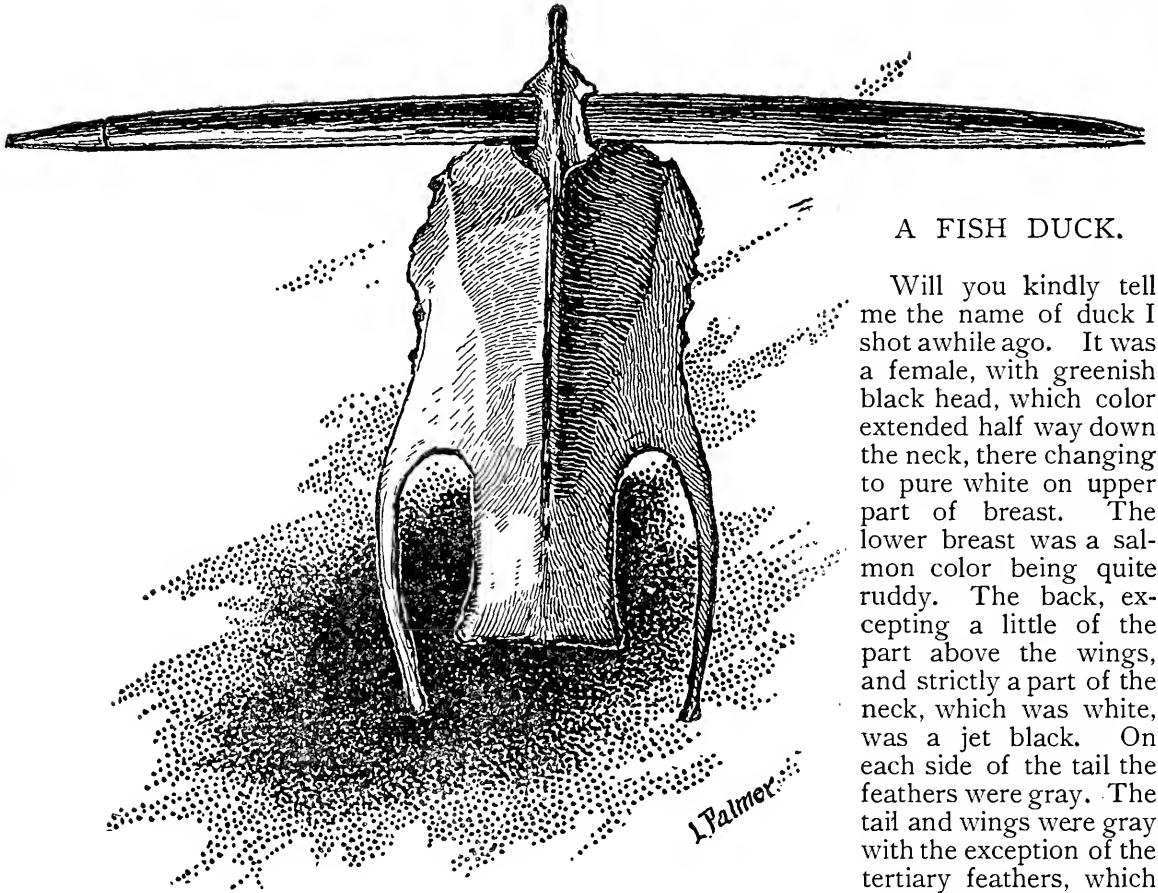

A FISH DUCK.

Will you kindly tell me the name of duck I shot awhile ago. It was a female, with greenish black head, which color extended half way down the neck, there changing to pure white on upper part of breast. The lower breast was a salmon color being quite ruddy. The back, excepting a little of the part above the wings, and strictly a part of the neck, which was white, was a jet black. On each side of the tail the feathers were gray. The tail and wings were gray with the exception of the tertiary feathers, which

were pure white with a single thread of black extending through each feather. The bird weighed 5 pounds, is what is known in our town as "the black and white duck."

Is either this or the black duck considered edible?  
G. E. H., Ware, Mass.

I referred this matter to Mr. Robert Ridgway, Curator of Ornithology in the National Museum, and he says the bird seems to be a male fish-duck (*Merganser americanus*). It is not likely it could have been a female, as no female duck ever normally takes those colors. He requests Mr. Holmes to state whether this duck had a long, narrow bill. If so, then it was a fish-duck and is not good to eat.

A CURIOSITY.

On October 20th, 1871, a farmer living in Lake County, Indiana, shot a brant and on picking it up remarked to his companion that it must have "fallen on a snag." Further examination, however, revealed the fact that the supposed snag, which protruded from either side of the breast, was a bone arrow head, 9 inches in length and  $\frac{5}{8}$  of an inch in width. The brant had carried this weapon so long that it was as firmly imbedded in bone and flesh as though nature had intended it as a part of the anatomical structure of the bird.

Where the arrow passed through the bone, a callous growth tightened about it and the skin was smoothly drawn where the ends were exposed to view. A strange part of the story is, that the bone arrow-head is of Eskimo make, such as those people employ in bringing down birds, and use nowhere outside of the Arctic regions.

This goes to prove that the bird was at one time a resident of that country. When shot by the Indiana farmer the brant was in fine condition and was the sturdy leader of a flock.

While the wound was not in a vital part it is likely that if the arrow point had been made of steel or other metal the bird would have died from blood poisoning.

Editor RECREATION: I wish to report to you a strange freak of the pewee, or phœbe bird. On a beam in the shed that joins my mill, a phœbe bird is building a lot of nests, 13 in number, all joining together, in all stages of construction! Some are almost finished and some just commenced. I see only one bird at work. I have never seen or heard of any such a freak before. The shed is new, having been built 2 years ago. Last summer there was a nest near by in which 2 broods were raised, one in May, and one in July. I thought that uncommon. H. M. Gordon, Morrisville, Vt.

THE NEW YORK WORLD'S  
"MOOSE."

Judging from things seen and heard, it may be said that in spite of all the efforts of RECREATION, many American editors are fast losing all the grip on zoology they ever had. Not long since, a certain magazine published a picture of a saw-fish, and called it a "sword-fish." Now comes the New York *World*, with a scare-head description of the "Antlers of a Moose King," giving elaborate measurements and a picture labeled "The King of the Moose," but the picture shows the head of—a caribou!

In the latest Sportsmen's Exposition, an enterprising taxidermist handed out thousands of copies of a beautifully printed pamphlet containing, among other illustrations, a fine picture of a Virginia deer head legended "Black-tail Deer."

But mistakes will happen. Once upon a time a man I know (who even then thought himself a bit of a naturalist), superintended the making up of an Exposition pyramid of big game, and when the workmen put the (adjustable) antlers on the moose, with the right antler on the left side, and the left on the right, neither the naturalist, nor any other man, noticed it for a whole week!

I note your comment on the report of the musk ox hide which C. F. Periolat, of Chicago, received. He says it was killed near the mouth of the Yukon river, Alaska, and that it took 6 months' travel to get it out. It is strange that men will make such statements in this enlightened age. Boats from the mouth of the Yukon reach here in 20 days, instead of in 6 months. So far as known, there never was a musk ox killed or seen in Alaska. The skin Periolat received came down on a whaler from the mouth of the Mackenzie river, to San Francisco, and was bought by C. D. Ladd of that city, who in turn sold it to Periolat.

I bought 35 musk ox skins that came down on the same vessel.

W. F. Sheard, Tacoma, Wash.

I certainly agree with J. C. D., Jr., Steamboat Springs, Colo., who writes in RECREATION, differing from Dr. Merriam regarding the cry of the mountain lion. My experience, as reported in "Science," March 20, 1896, is that the cry, if not exactly blood-curdling, is most decidedly "unpleasant," as J. C. D. expresses it, and when once heard, in close quarters, will not soon be forgotten.

Meriden S. Hill, Tacoma, Wash.

In the May number of RECREATION, on page 381, G. S. G. gives measurements of deer horns. I have a pair which I secured

near the Black canyon of the Gunnison, which spread 36 inches. They are smooth and even and have 5 points on each side.

I also secured a pair in the velvet, which had 15 points on one, and 17 on the other. They were the heaviest deer horns I ever saw and spread about 32 inches.

J. D. S., Argentine, Kans.

In reply to N. H. H.'s question as to the biggest coon—I would say that of 30 or more I have caught each season, for the last 4 or 5 years, the heaviest one I have weighed, tipped the scales at 18½ pounds. Had this one been caught 6 weeks later he would probably have weighed 4 or 5 pounds more. A friend of mine claimed to have captured one that weighed 26 pounds and several that went better than 20 pounds.

G. W. C., Rushville, N. Y.

I do a great deal of coon hunting around here, having caught 20 coons last fall. There was but one large one among them. It was a buck and he weighed 30 pounds. I caught him in September and he was poor. Game is scarce around here. There are a few quails and pheasants and plenty of gray squirrels and rabbits.

H. P., Wellsville, O.

The way you roast the game hogs is simply great. Give it to them, as often and hard as you can. I hope those Wisconsin slaughterers will come to their senses and never again lend themselves to such contemptible work, much less boast of it afterward. Success to you and to the *only sportsmen's magazine in the country*.

B. F. C., Jr., Brooklyn, N. Y.

On May 1, a large moose visited the farm of J. C. Harvey, Fort Fairfield, Me. When first seen he was within a few rods of the buildings, but on being discovered he trotted leisurely across the field, lightly skimmed a wire and picket fence and disappeared in the woods.

Will Shawantum please inform us in what part of the United States female gray squirrels are heavy with young "late in the fall."

S. F. D., Amarillo, Texas.

"Men are so strange."

"Yes."

"George used to raise Cain when he had to walk the floor with baby——"

"Well?"

"But now that he is raising chickens he turns out at 4 o'clock to look after the incubator, without a murmur."

## EDITOR'S CORNER.

### HOW TO CIVILIZE THEM.

Game protective associations, or other sportsmen's clubs that have for their object the protection of game and fish, can do nothing that will more effectually carry out their purpose than to extend the circulation of this magazine among men and boys who are known to be violators of fish and game laws. Every sportsman who reads RECREATION, will, I believe, agree with me in this statement. RECREATION is constantly endeavoring to elevate the tone of sportsmanship and to promote public sentiment in favor of game protection. It is denouncing men who slaughter fish and game, roundly and unmercifully, and no man or boy, who has any sense of shame or of honor, can read 3 consecutive issues of it without feeling a strong inclination to respect the game laws, in future.

Many instances have come to my personal knowledge of men or boys who, before becoming acquainted with this magazine had been ruthless destroyers of fish and game; who had boasted of their big bags at every opportunity, and who now state, frankly, that they will never again be guilty of such conduct. They say they will hereafter observe the laws; that they will practise moderation in their shooting and fishing; that they will advise others to do so, and that they will, in all cases, discourage and condemn the very kind of work they had heretofore been guilty of.

If you cannot get the pot hunter, or the pot fisher, to subscribe for RECREATION, send it to him anyway, and either pay for it yourself, or have your club pay for it. In this way, you will sow the seed of game protection where it could scarcely be expected to reach in any other way. Even the game wardens have great difficulty in finding and arresting the men and boys who do the greatest mischief; but if RECREATION were placed in their hands every month, they would take it with them into their cabins and would read it while the game wardens are asleep. After reading a few issues, the game officers would have no further occasion to hunt these men.

The August number of RECREATION will contain an interesting story by Geo. G. Cantwell descriptive of a catboat cruise on Puget Sound; another by Captain H. Romeyn on "A Buffalo Hunt in Kansas," some stirring reminiscences of early days at old Fort Smith, on the Big Horn, by Major E. R. P. Shurley; the record of an exploring trip in the Olympic mountains, by F. J. Church; a fishing yarn by J. L. Litman and a cycling story by Thos. Cunningham.

Another series of Carlin's wonderful live wild animal photos, and another installment of the prize winning photos will be published, as also several original drawings.

---

Ask all your friends to answer all the puzzles in RECREATION. The more answers sent in the better, for all concerned.

The time for answering puzzle No. 1, in May RECREATION, is extended to July 31. Please ask every one you know to answer that, especially. A neat and useful little package is being sent to all who solve that puzzle.

---

Some of my enemies are telling advertisers that I have no such circulation as I claim. Whenever you hear a man say this, offer to bet him \$100 that I have an actual paid circulation of 40,000 copies a month. Then I will furnish the proof, and if I win his money, will give it to St. John's Guild, to be applied to the Sick Babies' Fresh Air Fund. If he wins my money, he can do what he likes with it.

---

The owners of Madison Square Garden are talking of selling it. If sold it is likely that it would be torn down. That would be a public calamity. What would sportsmen do without the big Garden? Where could we go with our sportsmen's show, our dog show, our horse show, our wild West show, our bicycle show? It is hoped no such sacrifice may be necessary.

Why cannot the boxes in the Garden be sold, by the year, as in the Metropolitan Opera House? In this way a guarantee fund could be secured that would avert any possible loss to the stockholders. There must certainly be a large number of men in New York who would pay \$100 to \$200 a year for boxes in the Garden rather than see it destroyed.

---

In planning your hunting trips, for next fall, don't take anymore cartridges with you than necessary to kill a reasonable quantity of the game you seek. Then you wont be tempted to shoot at everything you see, just to lighten your belt. At any rate don't kill more game than you need and can save.

---

The index to volume 6 is now ready. If you wish to bind your RECREATION, and have not received a copy of the index, send for it.

---

My subscription receipts for May '95 were \$292, for May '96 \$902 and for May '97 \$1,596—a gain of 500 per cent. over '95. Anything wrong with that?

## BICYCLING.

### AN ENJOYABLE CENTURY RUN.

C. PERCY HALYBURTON.

I have heard it said, on numerous occasions, and by many well informed persons, that century runs, and such "abuses of the wheel," are violations of the rules of health and only help to bring the bicycle into ill-repute.

I have seen many caricatures of the "century run fiend," picturing him as a sallow-faced, wild-eyed, hump-backed idiot—in short, a typical "wild man of Borneo on wheels." If you see any of these characteristics in the group of young men who made the century run I am about to describe, you certainly need the attention of an oculist.

Six young men were seated in the parlor of the club house, of the Penn Wheelmen, Philadelphia, discussing plans for Decoration day, which was only 2 days removed. None of the several schemes proposed for the amusement of the party was accepted, by unanimous consent, and each had almost determined to seek his own pleasures for the holiday. Finally a happy inspiration seized me and I said:

"I have it boys! Just the thing for the whole crowd!"

"Let us have it, Purse!"

"Give it an airing!"

"Trot out the idea, old man!"

"Purse has the floor!" were the replies.

"Well, I'll tell you," I began—

"Oh, will you!"

"How kind!"

"My idea is a century run to New York, on Decoration day, and return the following day, Sunday, on the train."

"That's the best yet," cried Jack Gruel, the club's second lieutenant.

"That's what, Jack!" said Foley. "There is a pleasure trip for us all."

The other 3 members of the coterie, Price, Bong and Daniels, quickly agreed to the plan, and after a little further discussion we dispersed.

The night preceding Decoration day we all presented ourselves at the club house and proceeded to the third floor, where 4 of us were soon asleep. Bong and Daniels did not sleep with us. They had decided to ride to New York during the night, the former being well acquainted with the route.

At 3 o'clock the janitor awoke us, and after having lighted our lamps, we started on our journey. The sleepy coppers eyed us with wonder, as did also a few belated wayfarers. They were not used to seeing cyclists riding at such an unseemly hour.

We rode through Frankford and Torresdale, and at daybreak arrived in Bristol, 22

miles from Philadelphia. From Bristol to Trenton, N. J., a distance of 10 miles, is a stretch of good side-path; but in some places it is very narrow—only 5 or 6 inches wide. The road is miserable and we could not ride on it. We were subjected to a number of falls, owing to the narrow side-paths and slippery grass bordering the path, which was still wet with dew. However we received only a few bruises.

We arrived in Trenton at 6 o'clock and straightway proceeded to a restaurant for breakfast. "It was wonderful to see the amount of fodder those fellows put away," as Foley put it.

Leaving our wheels at the hotel, we walked about New Jersey's capital awhile and at 8 o'clock resumed our journey.

We passed through some very pretty towns—Pennington, Hopewell, Blaensburg and Plainville. At Pennington we were serenaded by a colored brass band and enjoyed the sensation very much.

Soon after passing Plainville we met the great century run of the Quaker City Wheelmen of Philadelphia. The riders had left Newark that morning and were on their way to Philadelphia. There were over 600 wheelmen in line. These people were not out for pleasure as we were. They had a schedule, and rode accordingly, and the consequence was, many looked greatly fatigued.

We arrived in Somerville, 63 miles from Philadelphia, at 11 o'clock, a uniform pace of 8 miles an hour, and no one was feeling at all tired. We remained in Somerville a half hour, watching a parade, and then moved on to Bound Brook, where we stayed another half hour, viewing the town.

At one o'clock we rode into Plainfield, 13 miles from Somerville, and ate a hearty dinner.

All wheeldom was out in force in Plainfield and we stood entranced as we watched the flying wheels, propelled by sturdy young men and pretty bloomer girls.

We tarried in Plainfield until 3 o'clock and then started for Elizabeth, where we arrived in 45 minutes—a distance of 12 miles. The road between the 2 towns is an excellent one, and you can scarcely resist the temptation to ride fast over it. We continued through Elizabeth and Newark without stopping, but halted at a hotel in East Newark for some refreshment. As we stepped out on the porch to rest and enjoy the cool breezes we saw 2 wheelmen approaching, in whom we recognized Bong and Daniels. We hailed them, when they joined us and explained that a broken axle had delayed them and had prevented their arrival in New York before us.

We all rode into Jersey City together and

crossed over to New York. Then we rode out Broadway, on the cable slot, to our hotel.

The next day, Sunday, we visited the Battery, rode through Central park, and over the great bridge to Brooklyn, where we dined. Then we mounted our wheels and rode to Coney Island over the famous cycle path.

After taking a rapid survey of this resort we returned to Brooklyn, thence to New York, over the bridge, and continued to Jersey City by the ferry. Here we boarded the train for Philadelphia, where we arrived at 7 P. M.

The trip was a very enjoyable one, to all of us, and not one of us was fatigued when we reached home. We had seen a great deal in the 2 days and shall make a similar run this year.

---

### THE WHEEL.

The girls were dolls in Gran'ma's days,  
The spinning wheel was half their life.  
Man's equals now, in modern ways,  
Yet spinning wheels is far more rife.  
E. S. T.

---

I intend to spend next winter revelling in the charms of Jamaica, that sunny island of a summer sea, and if any reader of RECREATION would like information about the roads, or the people, of the geography of the isle, I shall be glad to give it.

Our New England roads are again alive with happy wheelers—happy if they are owners of decent mounts, and if they have not been putting good money into bad wheels, to swell the wallets of repairers and of bargain counter men.

On the whole, since the average would-be-cyclist is determined to work against his own best interests, maybe it is well that the drygoods wheel is his first mount; for then he becomes a rider, and next time he buys a good wheel. Meantime he has been picking up experience and sprains, and helping Doctor Fixem to pay his rent.

Any of RECREATION'S cycling readers, who would like to know all about "touring in England at small cost," from start to finish, can secure such by writing the veteran tourist, Arthur Munson, Stamford, Ct.

Those who ignore brakes, and a good lamp, at night, will some time realize that they have gone unprotected once too often. While the doctor is pulling them through they will have time to reflect and to turn over that long neglected new leaf.

Stamson.

---

The National Board of Trade of Cycle Manufacturers has decided that no national or local cycle shows shall be held or sanctioned by it next winter.

In April, '97, the Ticonderoga Cycle Club commenced the building of a path from Ticonderoga to Baldwin, a distance of 3½ miles. Permission was obtained from the town authorities to level off the side of the road, near the sidewalks, and to cover it with cinders. This space was then rolled with an iron roller. In places where drainage was necessary, to carry off surface water, a ditch was dug alongside the path, emptying into the sewers.

The path is 4 feet wide, and will permit an easy and safe passage of 2 wheelmen without dismounting. It is a pleasure to ride on it to the Baldwin dock, on a hot summer day, sit in the cool breeze of the beautiful Lake George, and view the grand scenery for which the locality is noted.

The question as to how to raise the money for this path was a perplexing one; but a subscription paper was circulated among the boys, who were asked to give as much as they felt able to spare. Most of them gave \$1 each. There are about 200 riders here, but the number will be doubled this year.

RECREATION is the *only* sportsmen's magazine published.  
J. C. R.

---

That athletic preacher of ours made a bad break in his sermon yesterday.

What did he say?

He was speaking of the earth and called it God's green football.

---

Miss E. Marguerite Lindley recently gave a lecture for the benefit of the sick fund of the Brooklyn Hospital Training School on the "Care of the Human Machine and the Good and Evil Effects of Bicycling." She included in her discourse these "don'ts":

"Don't feel yourself above advice from other people who know more than you do, when you are going to buy a wheel.

"Don't swallow all advice undigested.

"Don't buy your neighbor's cast off wheel. If it's not good enough for her it's not good enough for you.

"Don't consider your ambition any measure of your staying power. The greatest danger of wheeling is of overdoing.

"Don't try to reduce your weight by scorching.

"Don't give ear to the cyclometer fiend. She is apt to see double when she reads the figures on the dial.

"Don't talk of miles covered, but of hours spent in the open air."

---

"Simpkins is a bicycle instructor, isn't he?"

"No—no; bicycles know everything already; he merely teaches people how to ride."

The Olympia-Tacoma record was recently broken by Frank Cotter, of Olympia, who lowered it 9 minutes; making the 35 miles in 1 hour and 58 minutes.

Improvements are being made on the cinder path from this city to Edison, 6 miles distant. This path is the finest in this neck o' woods, and includes the largest bicycle bridge in the world.

Nearly 2,500 bicycle licenses have been issued in this city, this year, and more are expected. This money goes to build bike paths and bridges, in the city limits.

About 800 cyclists came over from Seattle, last Sunday, to take a spin on our roads.  
C. G.

"Your husband seems jealous of your Scotch terrier?"

"Yes; Charles has never won any prizes on his stories; but dear little Fido has taken 5 blue ribbons this year."

August Summerman, 13 years old, of Union Hill, N. J., lost 2 fingers of his right hand in a curious manner. He had been cleaning his bicycle and stood it on a support which left the wheels free. He revolved the rear wheel rapidly, and, in an effort to stop it, his fingers slipped in between the spokes and were thrown against the fork.

The index finger was cut off almost as if by a knife, while the second finger was mangled so badly that the Doctor was obliged to amputate it. The bicycle was uninjured.

The new ferry, at West 23d Street, is a luxury for wheelmen who wish to use the fine roads in Jersey. It affords the easiest and most convenient exit there is from this city, since 24th Street is asphalted to the ferry house door. The new ferry can now be reached from various parts of the city by 8th, Madison or Lexington Avenues, all of which are asphalted. The time, from 23d Street to Jersey City, is 15 minutes and from there you can get a train every half hour to Elizabeth, where you connect with the various boulevards.

I have never seen, elsewhere, any railway employes who were so polite and courteous to wheelmen as are the Pennsylvania people, at this new ferry house.

I received the Bristol steel fishing rod, for 10 subscriptions to RECREATION. I had it out the other day, and it worked to perfection. I think I am well repaid for my trouble in getting the subscriptions. RECREATION is one of the finest books I have ever read.

John T. McCall, Negaunee, Mich.

## PUZZLE PAGE.

## HIDDEN WORD PUZZLE.

I am composed of 11 letters and come from "away down East." My first is found in Portland, my second in Albion, my third in Belfast, my fourth in Bangor, my fifth in Bingham, my sixth in Andover, my seventh in Berwick, my eighth in Ashland, my ninth in Danforth, my tenth in Eliot, and my eleventh in Exeter.

Whoever will guess me, and send my full name to RECREATION, stating on what page of this issue I am advertised, will receive, in return, a beautifully illustrated book.

Ask all your friends to answer the puzzles in RECREATION. The more the better, for all concerned.

## NEW CASTLE, PA.

Editor RECREATION: You will please find enclosed my answers to the 4 puzzles in May RECREATION. I don't think I have the first one right, but if not, I am willing to give it up; for I have read every line of every advertisement in this issue; and I want to say right here that the Vim tires are as hard to wear out as that puzzle is to get. I have a pair of last year's red road Vims on my wheel. I punctured both front and rear tires, last season; repaired them myself, with a Vim repair outfit, and have had no trouble with them since.

I am going to canvass among my friends for subscribers to your valuable magazine. I will send you names and money as I get them; you may credit me with them, and I will let you know, later, what premium I want. I received a Davenport rifle from you, a year or so ago, as a premium, and it is a fine rifle for the money. I took RECREATION a year, and a friend got me to subscribe for another sportsmen's paper; but I don't like it and am going back to my old love. My friend is going to take up a new love—RECREATION.

Rob Ray.

"Scrymser is an intellectual man, isn't he?"

"Intellectual? I should say not. Why—he likes whist better than poker."

Enclosed please find \$1 for which please send RECREATION to me one more year. I would have to have it, if it took my last dollar.

Harvery J. Flint, Edgewood, R. I.

## BOOK NOTICES.

Aristotle was perhaps the greatest naturalist of early times, and but slight advancement was made, in zoological science, from his day to that of Linnæus, who made the first attempt at grouping animals according to structural characteristics. Cuvier followed with a more thorough and systematic classification, making use of dissection to determine the relations existing between them. Then came de Blainville, who first took up the elements of form among animals.

Scores of naturalists and scientists have since given their life work to the building up of modern zoology, and no branch of science has been more rapidly and steadily advanced.

But the thorough and systematic study of comparative anatomy, from the artists' point of view, is still more recent. Ten years ago there was no text book on this subject; and this fact, in conjunction with his natural bent, induced Ernest Seton Thompson, the animal painter, to devote several years of ardent toil to the production of "Art Anatomy of Animals," a most delightful, thorough and original book. It is so artistically designed, so comprehensive, so redolent of deep study and careful research, so full of nature and of fact, as to be at once instructive and fascinating to students of science and of art. It is really fortunate that no earlier writer or student had put forth such a work, for necessity was, in this as in many other instances, the mother of production, and if Mr. Thompson had found a book on animal anatomy when first he felt its need, he would not have made this. Hence we might never have had so good an one; for few men have been so well equipped as he for such a task. His artistic gifts, and his years of life among and with the wild animals of the Northwest, as well as his love for and close association with dogs, horses and cattle, have fitted him, as no other man was ever fitted, for the work. Another reviewer has said:

"What can an artist learn of the outward form of animals, if he live only in the dissecting room?"

He may, indeed, obtain an accurate muscular outline; but it will be an outline of a cold, rigid corpse, devoid of the soft and rounded form, the delicate tinting, and the breathing grace which invests the living animal. A feeling eye will always discover whether an artist has painted even his details of attire from a lay figure, or whether he has depicted the raiment as it rested on and drooped from the breathing form of a living model.

The zoologist will never comprehend the nature of any creature by the most

careful investigation of its interior structure, or the closest inspection of its stuffed skin, for the material structure tells little of the vital nature, and the stuffed skin is but the lay figure stiffly fitted with its own cast coat."

In the preparation of "Art Anatomy," not only the body on the dissecting table but the living, moving, breathing form was always kept in sight.

No anatomical description of the animal is given, other than those that influence the outward form. Over 100 drawings by the author, contribute to the value of this most admirable work.

The illustrations of the anatomy of the hair deserve special mention, while the nerves, glands, muscles and bones are clearly defined in a manner to make plain their influence on the outward form, as also the expressions, emotions, and movements.

The figures selected are pleasingly familiar. The general character and measurements of many of the animals are fully and elaborately given, and are placed in so simple a form as to be easily comprehended by those whose knowledge of animals is limited. At the same time, the most minute details, in these as well as in the illustrations, are so carefully and perfectly traced as to challenge the criticism of the greatest painter, sculptor, naturalist, or taxidermist.

"Art Anatomy of Animals," by Ernest Seton Thompson. Macmillan & Co., New York and London: Price \$10.00.

G. P. Putnam's Sons, New York and London, announce the publication of "The Encyclopædia of Sport." This work has been planned to cover, as nearly as practicable, the whole range of sports in which English and American sportsmen and readers are alike interested. The book is edited by Mr. F. G. Aflalo, who has secured contributions from the leading authorities, on both sides of the Atlantic, while other contributions are from men who have not before been induced to come into print with their personal experiences or suggestions. The minor and unsigned articles are also the work of experienced sportsmen, and in order to insure all possible accuracy of detail, they have been submitted to the careful revision and scrutiny of experts. The scope of the subject matter includes articles on topics which, while not in themselves to be classed directly under "Sport," may easily become important in connection with sport, such as "First Aid to the Injured," "Veterinary Work," "Taxidermy," etc. It has been the aim of the editor to secure contributions which, while authoritative in all their technical details, are thoroughly readable as descriptive narratives.



The work undertakes to be a dictionary as well as a cyclopædia, and gives definitions of all common and technical terms used in speaking of any kind of sport. All the more important articles, and many of the shorter ones, are carefully and accurately illustrated.

As samples of the more important articles in Part I. of the Encyclopædia, I may cite the following:

Amateur, 3 columns, illustrated.

America Cup,

Ammunition, 7 columns, by H. F. Phillips, illustrated.

Angling, 52½ columns, by H. S. Thomas, illustrated.

Antelopes, 13 columns, by H. A. Bryden, illustrated.

Archery, 16 columns, by H. Walrond, illustrated.

Athletic Sports, 13 columns, by C. B. Fry, illustrated.

"The Encyclopædia of Sport" will be issued in 20 large quarto parts, at \$1.00 a copy. Each part will contain 56 pages, double column, illustrated text, printed on heavy calendered paper, together with 2 full-page illustrations in photogravure. A glossary of technical terms will be included in the last part.

Judging from the first part, which I have examined, this work will be a most valuable one and will become a necessity to every sportsman who wishes to be well informed.

"Travels in West Africa," by Mary H. Kingsley, is a remarkable book. It is rare that a woman's curiosity, great as that is supposed to be, leads her to explore wild countries; nor has she usually the physical endowment necessary to such work. Miss Kingsley was not led, however, by mere curiosity to explore the West coast of Africa. She sought that field as a new one to science and her prime object was to study the fauna of the region. Her researches were rich in results, and she has made many contributions to science.

In a valuable appendix, Dr. A. Guenther describes 16 new species of fauna, discovered by Miss Kingsley, and 8 new species of insects.

She, however, says little about her scientific work; and the book contains so vast a fund of general information, regarding Western Africa, that you wonder when Miss Kingsley found time for special scientific study. Her narrative is delightful. Difficulties and dangers seem only to have amused and inspired her. She mentions them gayly, as having lent zest to the undertaking, and seems to have flitted like a will-o'-the-wisp over the swamps and through the great forests.

Particularly interesting and delightful chapters are those on Bush Trade and Fan Customs, Congo Français, Fetish, the As-

cent of the Great Peak of Cameroons, and Trade and Labor in West Africa. The book contains many valuable illustrations and a good index. It is only a lazy layman who will wish there was also a map.

Published by Macmillan & Co.; price, \$4.

"Easter Bells," a charming collection of Margaret E. Sangster's poems, published by Harper and Brothers at \$1.25, is especially appropriate to the season of the year which is indicated by its title, but it is also a good all-the-year-round book. Its table of contents is grouped under 4 general headings, i.e., "Songs of the Easter-Tide," "Home and Hearth," "Mile-Stones" and "Closet and Altar." No one, be he saint or sinner, can open its pages at random and read without receiving benefit.

In ordering or inquiring about books or other goods, mentioned or advertised in RECREATION always mention this magazine. This attention on your part serves to convince publishers, and other advertisers, of the value of RECREATION as an advertising medium.

Your magazine is greatly admired by the sportsmen in this neck-of-woods. All of our true sportsmen, who delight in the use of the rod and gun, look eagerly for its coming and devour its contents eagerly.

G. N. Mills, Otsego, Mich.

I am glad to see the showing of your monthly cash balance and hope, most heartily, the coming year may show still larger. The dollars are the sinews of war, in newspaperdom.

E. H. Cooney, Great Falls, Mont.

RECREATION, certainly, is one of the high grade magazines, if the price is low.

R. G. Wallace, Chula Vista, Cal.



## PLUGINE ARRESTS PUNCTURES

We positively guarantee your tires if they are treated with Plugine, "the wheelman's friend." Two tubes enough for two tires, sent prepaid for \$1.00. Circular free.

The National  
Specialty Co.,

91 Euclid av.,  
Cleveland, O.

## *Does Not Curl.*

Properly handled, Eastman's Film does not Curl. And to properly handle Eastman's Film is so easy that the "Curl" can be said to exist only in the imaginations of a few beginners who have listened to the vagaries of the manufacturers of cheap plate cameras. A little preliminary soaking in cold water with the face of the film down will make it lie as flat as a glass plate. Development follows just the same as for plates, but with the *film face down* instead of face up. Handle the films one at a time at first, just as you would be obliged to do with plates, and you will find them fully as easy to manipulate—and they won't break. After a little experience you can handle several films in the developer at one time—an impossibility with plates. Photography is Easy with a Film cartridge camera.

Cartridge Cameras, \$5.00 to \$25.00.

Booklet free at agencies or by mail.

\$2,853.00 in Prizes for  
Kodak Pictures.

\$1,475.00 in Gold.

Send for "Prize Contest"  
Circular.

# EASTMAN

KODAK  
COMPANY,

Rochester, N. Y.

## AMATEUR PHOTOGRAPHY.

### TRIALS OF AN AMATEUR.

J. N. BEECHER.

Come into the garden Maud,  
Bring the kodak—largest size,  
And we'll take some stunning pictures  
Maud,  
For RECREATION'S prize.

Sixty days ago I didn't know a hand camera from a hay baler; but in reading RECREATION I ran against your photo prize contest. Then the camera craze struck me square between the eyes and mushroomed. I resolved then and there that I would capture your first prize if I had to load a cartridge kodak plum to the muzzle to do it. How well I have succeeded the picture I send you, with this, will decide. But oh! the trials of an amateur!

First buying a good 4 x 5 camera I went to work and ran the whole shooting match myself, from posing to pasting, and if there are any chemicals listed that I haven't experimented with, or any photo supply house, East of the Rocky mountains, that hasn't heard from me, it's simply an oversight on my part—that's all.

And the subjects! I knew wild animals would make striking pictures; and being something of a trapper I decided to commence on the gentle coyote; for I knew by experience just how pleasant a coyote can look when he has a paw in a No. 2 New-house trap. He can then open his jaws wide enough to swallow his whole body.

When I set my traps every wolf in the hills seemed to know I wanted a prize picture, and it was just 3 weeks later that my "assistant trapper" rushed in on me, at 3 p.m., shouting:

"Hurry up. Big coyote in the trap!"

I snatched my camera, saddled the pinto, "tied the dog loose," and we hit the trail. Gee! but it would have done you good to have seen that pony and dog. They knew something was up for they had been there before; and as we dashed through town, out into the mountains, everybody knew "Beecher had gone crazy again."

We had to make time or the sun would be too low for a snap shot and it wasn't long till we got there. I jumped to the ground, threw the check strap to "Tiger's" collar—words won't hold that old dog when he smells a coyote—and we slid cautiously up the hill; Tiger pulling on the lead till he caught sight of the wolf. Then he gave a lunge that lifted me nearly off my feet, and a howl that struck terror to the heart of Mr. Coyote. The latter didn't stand on the order of going; but went.

One bound into the air—trap and all—when snap! went the chain and off went

the cussed old coyote with one of my best steel traps on his foot. I turned old Tiger loose and he didn't need any urging. He bounded to one side of the trail while I took the other, and the pace, for a few moments, was rather too lively for even a snap shot—shortest time—big stop.

The coyote didn't go far till the trap caught in a bush. I jumped in front of him and gave him one between the eyes, from my revolver, just as a starter. Then Tige came in on the other side and had him by the neck so quick he barely escaped my shot. We soon got even with the brute for breaking away and spoiling our photo contest.

My partner kicked just because, as he said, "I was shooting pretty close toward him." I told him if he thought I was going to take any chances on losing a good coyote skin, and one of my best steel traps, just because he happened to be standing around in the way, he must take me for a tenderfoot; that as long as I hit the coyote I was shooting at, he needn't kick. Then he got mad and said I "could run the dogoned amateur kodunk biz myself, after this." Did I get a good picture? Well, no; for when we called the outfit to order and sorted out the dog, and horse, and dead coyote, from the camera, it was too dark for snap shots. And that's why I didn't get first prize in RECREATION'S amateur contest. Still, as I write this my tired feet rest on a large and handsome coyote rug, and oh! Tige had a pile of fun!

---

To C. P. S., Cleveland, Ohio, who asks how to get the carbon finish on photos, I beg to say you will be obliged to get Velox or Delta matt printing paper. No glace paper will produce a carbon finish. The matt is always in dull finish. Velox paper is developed after printing.

On taking it from your printing frame, it will bear no trace or outline of plate or negative. You then place it in your developing tray and pour (quickly) your toning developer on it, taking care that it covers it at one sweep. Then proceed as in developing other plates, only that you can do this by gas or daylight. When it has reached the desired tone or shade do not rinse in water but toss it in your hypo fixing bath. All directions come with the paper. You can see at once that Velox must be the coming carbon paper. It can be toned any shade, in olive or black. It is very sensitive and prints in 5 seconds, when exposed to gaslight, and in 7 seconds by daylight. You must be governed by the depth of your negative, as to whether it be thick or thin.

Mrs. C. W. K., New Haven, Conn.

## COMBINED TONING AND FIXING BATH.

Why is it used?

Simply because it is less trouble and is thought to be cheaper. The fact is it is just the reverse, and prints toned therein are not always permanent. When toning a print you want the best possible results, and should therefore make it absolutely permanent and with clear whites. The combined bath gives neither. The combination of hypo, borax, alum, lead, etc., is not so staple as one might suppose. A chemical action takes place and decomposes some of the chemicals, at the same time liberating sulphur fumes.

After several years of experimenting I have concluded that a single bath is best. Some amateurs tone as many as 50 4 x 5 prints in 8 oz. of combined bath. Do they suppose, for one minute, that there is enough hypo to fix the prints, or enough gold to tone them, in so small a quantity? Well, I don't, and those of my prints, toned in combined solution, which are in the best condition, are those on which I used 16 oz. of new to 8 oz. old solution. I toned at about 50 degrees, using cracked ice, cleared in salt water (1 oz. salt to 32 oz. water) washed and fixed in an extra fixing bath. Then I washed, thoroughly, in water and allowed 8 oz. bath to each 15 4 x 5 prints.

A combined bath may produce a good print occasionally, but cannot be relied upon. Prints thus treated turn yellow in a short time and finally fade out altogether. This may be due to insufficient washing, after toning; to an exhausted bath; or, most likely, a sulphur tone. Hundreds of my first pictures are faded, and I was compelled to make them over, using the single bath, which, while being a trifle more tedious, amply repays one for the extra labor, from the fact that it insures permanency if properly used.

I do not claim that none of the combined baths give permanent results but have never found one that is absolutely reliable.

Is the print toned first and then fixed? Or, is it fixed and then toned? This question always puzzled me. How can clear whites be obtained if the free silver (not the Bryan kind) is not first washed out? These are puzzles to me and should any reader be able to explain them I would be pleased to hear from him, through RECREATION.

G. A. C.

## HOW TO WORK PLATINUM PAPER.

In the first washing take half a gallon of water and add 2 ounces of saturated sal soda. Put in prints and flatten down. After they are drained and flattened, pour on plenty of clean water. Wash in 5

changes. By handling them over, you will never be bothered with red spots. Tone in 60 ounces of water. Take one teaspoonful of table salt; gold one grain; borax enough to turn red litmus paper blue in 3 or 4 minutes; adding gold enough to keep bath speed 6 to 8 minutes. Tone in this bath to point you desire when finished; bearing in mind that they will not be any warmer when dry. Place prints in salt water—one tablespoonful to half gallon of water. When ready wash them out 3 times to clear them of the salt.

This is the way I work all Aristo and other papers. The acid in papers once removed they tone easier, with less gold, and with clear whites. W.

Mr. Wm. Schutte, who made the excellent radiographs of fishes shown elsewhere in this issue, says he will be glad to give any information desired, on the subject of X ray photography. Address him in care of RECREATION.

A friend of mine asked me if I knew of a remedy for negatives that are too thin. They print the sky and other objects of the same shade. I think his negatives have been left too long in the hypo.

J. R., Yazoo City, Miss.

Most likely these negatives are over-timed and underdeveloped. It would be well to send with all such questions a silver print, unmounted.

An underexposed plate yields a negative full of contrast, with clear glass in the shadows. An overexposed plate yields a flat negative, with no contrast (shadows veiled or entirely blocked), full of detail but with no snap.

## TO PHOTOGRAPH BABY.

Get 6 large wire nails, 6 ounces chloroform, 1 handkerchief. Saturate the handkerchief with the chloroform and press over the nose and mouth of the baby till perfectly quiet. Then drive nails through each ear, hands and feet, into a board large enough for background. Use hammer on parents if necessary.—Photographic Life.

"That photographer is crazy."

"What's the matter?"

"He wanted me to pay cash down for long distance photographs."

"Rose says it is a perfect bore to be married to a photographer." "Why?" "If she doesn't smile all the time he jumps up and down in front of her and rings a little bell."—Chicago Record.

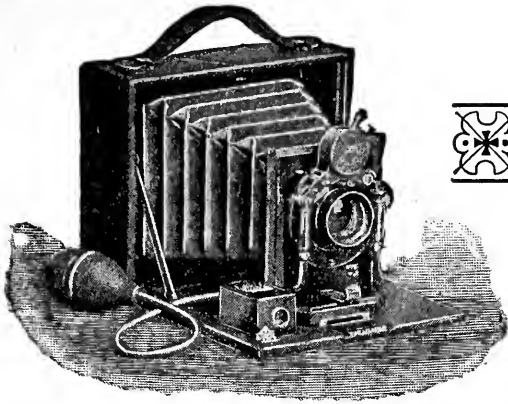

**P**REMIOS  
PRODUCE  
PERFECT  
PICTURES

# Premo Cameras

Have achieved an enviable reputation the world over. Their PERFECT construction and ease of manipulation, combined with grace, beauty, and superb finish, have placed them in the front rank, and they are to-day the Favorite Camera with the foremost Amateur and Professional Photographers.

MADE IN

**20**

DIFFERENT STYLES  
AND SIZES

Special Designs for the Sportsman and Tourist

CATALOGUE MAILED FREE

Rochester Optical Co., Rochester, N. Y.

## PUBLISHER'S DEPARTMENT.

### A "BULLET" FOR BIG GAME.

Editor RECREATION: Two weeks ago we went on a hunt for big game, in the Philadelphia "Zoo." My husband took paper and pencil and I cast about for a camera. Interviews with several friends, resulted in a strong recommendation to try the Eastman No. 4 Bullet. I did not believe a first class camera could be bought for \$15. However, I was persuaded into getting a Bullet for hand work, but at the same time, to provide against failures, I ordered a large, expensive tripod camera for "serious work." To my disgust the order for the large camera was not filled in time for the trip. The Bullet, however, came all right, and I was forced to set out with it alone, feeling that mine was a fool's errand. I did not know my machine, was quite sure it was not worth knowing, and, to quote the salesman, I had never used "fill-ums."

That New Yorkers have to go to the Philadelphia Zoo to study animals, is flattering, no doubt, to that city; but the fact casts a decided reflection on New York. It is to be hoped the New York Zoological Society, under the direction of Mr. W. T. Hornaday, will soon make such a reflection impossible. It will be a great day for New York, and its artists, when the Bronx Park Zoo is thrown open to the public. In the meantime, serious students receive courteous treatment from Mr. A. E. Brown, the Superintendent of the Philadelphia Zoo.

My husband, whose experience has embraced many Zoos, in Europe and in this country, says he "has never found another whose director is so thoroughly in sympathy with any student of art, or zoology, who shows himself disposed to make a proper use of the opportunities afforded by the place."

But to return to the camera. We worked a week, making sketches of the animals, and taking their portraits. Every keeper in the place assisted, cheerfully, as far as lay in his power. To photograph a correct impression of a caged animal, presents more difficulties than one would at first suppose. The lighting, the cage bars, or wire, the animal and the camera are well nigh irreconcilable. Therefore, when a good picture of a caged animal is obtained, the photographer has reason to congratulate himself and his machine.

I made 72 exposures on mammals, with my Bullet. A few of these were time, but chiefly slow snaps. Out of the number, there were but 8 failures, for all of which I was responsible. I got 14 inferior and 50 good pictures. Some of the latter are perfect gems, as you may judge from the

samples herewith; which I should like to enter in RECREATION'S second annual photo contest.

I have gone over to the enemy. If any one wants to buy a good, cheap camera, let him get a No. 4 Bullet, which is warranted for unlimited shots. G. G. S. T.

---

### A SURGICAL BEAUTIFIER.

Dermatologist John H. Woodbury, who has large establishments in New York, Boston, Chicago and Philadelphia, may be justly called the surgical thaumaturgist of modern times. He is a nose maker, an ear refiner and a wrinkle destroyer. Beside this he eliminates freckles, makes cross eyes straight, puts hare lips into normal shape, and generally beautifies the human face and form, undoing the mistakes of nature and the results of accident, and turning monsters into fairies, and freaks into presentable people.

The story of all this is attractively told by "The New York Journal," which narrates how an Omaha lady recently underwent treatment for a corrugated nose, the wrinkles being in the bone, and being anything but fascinating. The lady's nose was speedily made like other people's noses and she went home a happy woman.

The Woodbury Dermatological Institute, No. 127 W. 42d Street, New York, has thousands of testimonials from grateful patients, voluntarily given. Persons suffering from facial blemishes may address Dr. Woodbury with perfect confidence, as consultation is free, in person or by letter. Thousands of people have been successfully treated without leaving their homes. On application a question blank is mailed to any address. When this is carefully filled out it enables the physician at the Institute to judge correctly the disease and condition of the patient. Those who are disposed to employ the skill at their command may rest assured the Institute will not hazard its reputation by giving unwarranted encouragement, or a diagnosis that is not well based and perfectly candid.

---

Among the many good '97 bicycles is one that has many practical and convincing improvements. I refer to the "Fenton." It is a work of artistic skill; the result of thorough tests and careful experiments by wheel makers, of many years' experience. The method of adjusting the bearings is superior to any yet contrived, and the result is strength and simplicity combined. The material is of the finest and the trans-

lucent enamel finish is extremely handsome. The Fenton is as near perfection as can be produced. It will interest any rider to have the special features explained by Mr. Gifford, at 126 Chambers St.

G. P. Granberry.

In the lake regions of Wisconsin, Northern Michigan, Minnesota, Iowa, and South Dakota, along the lines of the Chicago, Milwaukee and St. Paul Railway, are hundreds of charming localities pre-eminently fitted for summer homes, nearly all of which are located on or near lakes which have not been fished out. These resorts range in variety from the "full dress for dinner" to the flannel shirt costume for every meal. If you are planning a vacation trip for the coming summer, send a two-cent stamp for a copy of "Vacation Days," giving description of the country traversed by the lines of the Chicago, Milwaukee, and St. Paul Railway, and a list of summer hotels and boarding houses, with rates for board, to

George H. Heafford,  
General Passenger Agent, Chicago, Ill.

Everyone dreads the breaking in of a new pair of shoes; but after you have worn a pair of the "B.B." shoes you will get over all that feeling. They are dead easy, from the start. They are made of Vici kid and are as soft and as comfortable as a last year's glove. The soles of the bike shoe are corrugated, inside as well as out, so that the air can circulate under your foot as you ride or walk. Therefore your feet keep cool. There is none of that burning sensation, on the bottoms of your feet, when wearing these shoes. Order a pair from the "B. B. Shoe Co.," 121 Duane St., New York, and see if you don't find them a genuine luxury. Mention RECREATION.

### ELECTRICITY IN BELTS.

An engineer in a large factory called the attention of a visiting electrician to the electricity in a big driving belt, and was surprised when the expert informed him the electricity was caused by the belt slipping. The expert added that it was simply a wasting of power and could be prevented by applying Dixon's Traction Belt Dressing, made by the Joseph Dixon Crucible Co., Jersey City, N. J. This dressing was applied and the electricity disappeared at once. Electricity in belts is not only a waste of power, but is also an element of danger from fire.

The fame of the W. H. Mullins metal boats seems to have gone to the ends of the earth, if one may judge by the orders he is receiving for these excellent craft. Mr. Mullins writes me he has lately received an

order for a galvanized steel Get-There Duck Boat, from Le Prince A. W. Bariatinsky, Var, France, to be shipped to him at Wiborg, Finland, Russia. Also an order for one Manganese Bronze Pleasure boat for one of the South American Governments, and for Manganese Bronze Dingey to be shipped to Mexico City, Mexico.

I submit the following to show the popularity of your magazine. Albert Mulholland, little 4 year old son of S. D. Mulholland, on being told that he must remain in-doors this p.m., on account of the stormy weather, said:

"All right! Guess I'll read my RECREATION."

Though he cannot read he is greatly amused by looking at the pictures in RECREATION and pretending to read the stories.

N. B., Port Henry, N. Y.

I have been reading RECREATION for about 2 years, procuring it through the News Co. I have read copies of nearly all the sportsmen's journals, and find nothing that goes to the spot or fills the place of RECREATION, with the "native" hunter and sportsman. It is just what he wants, both in quality and price, and is edited by a man who has been there.

E. L. R., Westville, Ind.

I received the Marlin 44-40 rifle and 38 revolver which you sent me as premiums for clubs for RECREATION. Please accept my sincere thanks. They are beautiful arms. The revolver shoots better than another I have of a well known make. The rifle can't be beaten.

A. N., Worcester, Mass.

The set of "In Darkest Africa" I ordered of you came this a.m. all satisfactory. A gentleman from Miamisburg called at my office, saw the books, took your address and said he would order 2 sets at once, one for himself and the other for a friend.

W. S. K., Dayton, O.

## "Shut Up!"



says "the Corker" to the puncture, and your tire is sound again. Always carry

### "THE CORKER" Repair Kit

a quick mender for cycle tires. Twenty-five cents buys enough for 25 punctures. "CLINCHIT" Rubber Cement, "the stuff that sticks." Ounce tube, postpaid, 15c.

Circulars free.

The National Specialty Co.,  
91 Euclid av., Cleveland, O.

A REVERIE.

BY W. P. CHADWICK.

When the days grow melancholy and the leaves begin to fall  
 From the hickory and the maple, spreading o'er the earth a pall;  
 When the beech nut and the acorn and the hazel nut abound  
 And the busy, frisking squirrels hide their stores in tree or ground;  
 Then there comes that feeling o'er us that cannot be told in words  
 And we long to roam the forest and the prairie, free as birds.  
 This unrest grows stronger, daily, with the rising of the sun,  
 And impels us to go hunting with the rifle or the gun.  
 If we are too busy, ever, on the farm or in the store  
 To enjoy a day off now and then, much less a week or more,  
 Still our hope beams bright before us, in our darkest hour of need,  
 For if we can't go hunting we can RECREATION read.

Bearded Lady—"Wot ails ther ossified man?"

Snake Lady—"He's a-kickin' coz ther drinkin'-worter iz so full o' lime."

**Quad Camera**

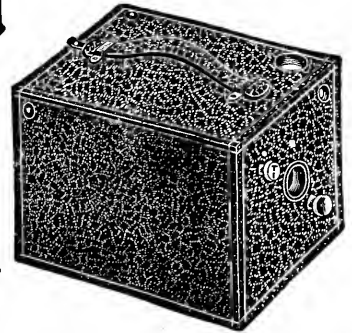

No Separate Parts . . . .  
 3½ x 3½ inch Plates  
 Eminently Practical  
 Handsomely covered with leather

Price, \$5.00 Send 2c. stamp for sample photograph and booklet

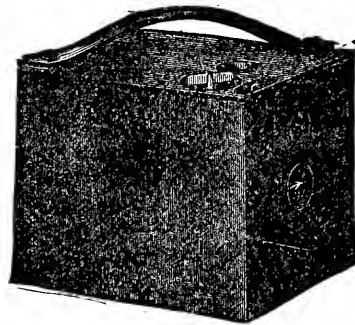

**Buckeye**

Twelve Exposures without re-loading. Loaded in daylight.  
 Simple and efficient.

Price, \$8.00 Send for illustrated booklet.

**E. & H. J. Anthony & Co.**  
 591 Broadway . . . . . New York

If you are in need of  
**A Camera that will produce a Perfect Picture,**  
 obtain  
**The HAWK-EYE, Jr.**

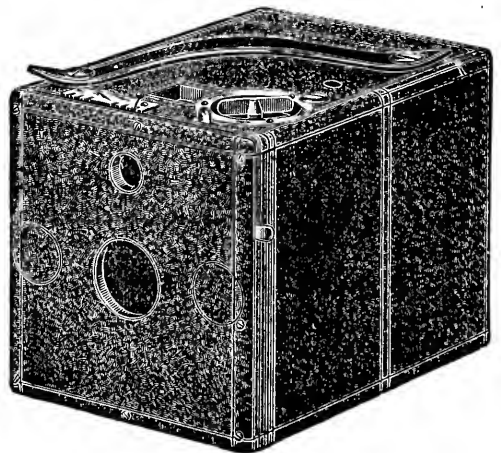

which will be found  
**a faithful friend at all times.**

The simplicity of its working parts enable the novice to obtain results that will astonish old photographers. Size, 4¾ x 4¾ x 6¼ in. Photo, 3½ x 3½ in. Weight, 20 oz.

**LOADS IN DAYLIGHT, USES EITHER ROLL FILM OR GLASS PLATES.**

Send for Catalogue, giving description of all kinds of Cameras and Supplies.

**PRICE, \$8.00**

**THE BLAIR CAMERA CO., 471 Tremont St., Boston, Mass.**



# The Baby Wizard Camera

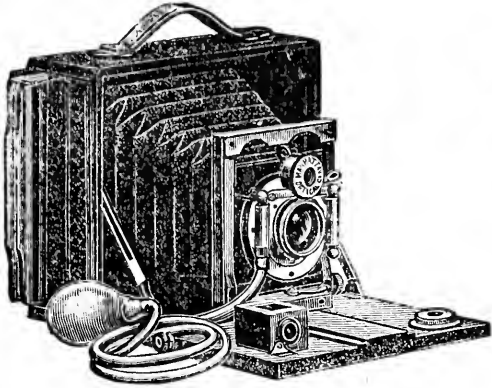

Only  $2\frac{3}{8} \times 5\frac{1}{2} \times 6\frac{3}{8}$  inches

*Is the  
Ideal Camera*

FOR TOURISTS, WHEELMEN  
OR SPORTSMEN GENERALLY

*Fitted with our Extra Rapid Rectilinear Lens (unequaled in this country), and the Bausch and Lomb Optical Company's Iris Diaphragm Shutter.*

Complete with Carrying Case

**\$25.00**

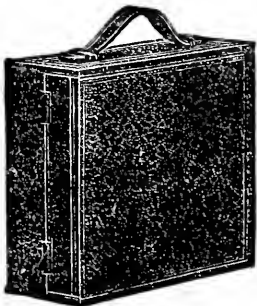

Same without rack and pinion, for focussing, and swing back

**\$20.00**

SEND FOR CATALOGUE

Manhattan Optical Co., Cresskill, N. J.

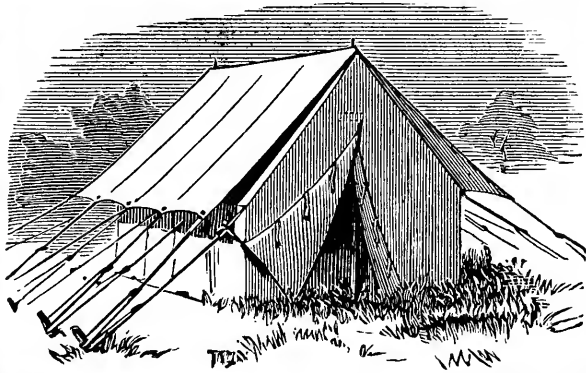

Every  
Sportsman  
Should  
Have a

# WATER-PROOF TENT

A camper knows the advantages of a tent that is an absolute protection against rain and dampness. We secure this advantage by **OUR** water-proof **PROCESS** and avoid the extra bulk and weight of a fly.

We make tents of all sizes, shapes and materials, suited to the needs of hunters, campers, travellers, canoeists; also

## Water-Proof Sleeping Bags

**CANVAS BUCKETS, AMMUNITION, PROVISION,  
CLOTHING AND SADDLE BAGS, POUCHES,  
PACKS, BICYCLE COVERS, FLOOR CLOTHS,  
and many other Canvas Specialties**

**Our Sleeping Bag** is unique, excellent in pattern and finish, and has been highly approved.

SEND FOR CIRCULAR R, SAMPLES OF MATERIALS AND PRICE-LIST TO

# DERBY, ABERCROMBIE & CO.

36 South Street, New York

The Only Practical  
**Camping Bag**

IS THE . . .

# Kenwood



Enthusiastically endorsed by campers everywhere—not an experiment. Now made with improvements suggested by usage under all conditions—as, for instance, the outside waterproof canvas cover, the middle bag and the soft, warm, light inner bag—to be used separately or combined, thus giving perfect protection from cold, rain or sudden climatic changes. Strong, durable and useful, as a hold all.

A perfect  
 shelter.  
 Tents  
 unnecessary.



No stiffened muscles. No uncovering.

The Prices

**\$6.00 to \$16.00**

are a revelation to buyers of the old, heavy and unsatisfactory square blankets.



## The Kenwood Hunting Cape

meets every requirement of the sportsman "waiting for a shot," whether at a deer, ducks or pigeons. Better than coats. Carefully made to combine all desirable features. Excellent as a Driving Cape.

Price

**\$15.00**

## The Kenwood Storm Hood

for use with the Bags, or for anyone exposed to severe weather, will be found very serviceable and a comfort in cold or windy weather.

*Every Camper, Hunter, Angler, Prospector or Military Man should send for our FREE illustrated circular, about these goods and camping information*

**THE KENWOOD MILLS, Albany, N. Y.**

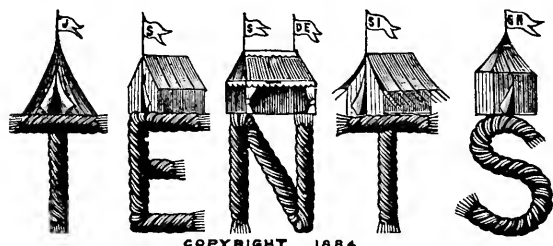

COPYRIGHT 1884

# AND CAMP OUTFITS

We manufacture the largest and most complete line of tents in the country, and our goods are celebrated for their wearing and waterproof qualities.

Send 4 cents in stamps for our new 40-page illustrated catalogue showing all styles of Tents and Camp furniture.

**GEO. B. CARPENTER & CO.**

202 to 210 S. Water Street, CHICAGO

Established 1840.

JUST THE THING...

For Yachts and Country Homes

## THE STELLA



Our new Music Box, playing any number of tunes on tune sheets, without pins or projections of any kind; surpasses all others in quality of tone and in durability; it occupies little space and compares favorably in tone with the piano. Call and see it, or send for catalogue and list of tunes to

JACOT & SON, 39 Union Square, New York.

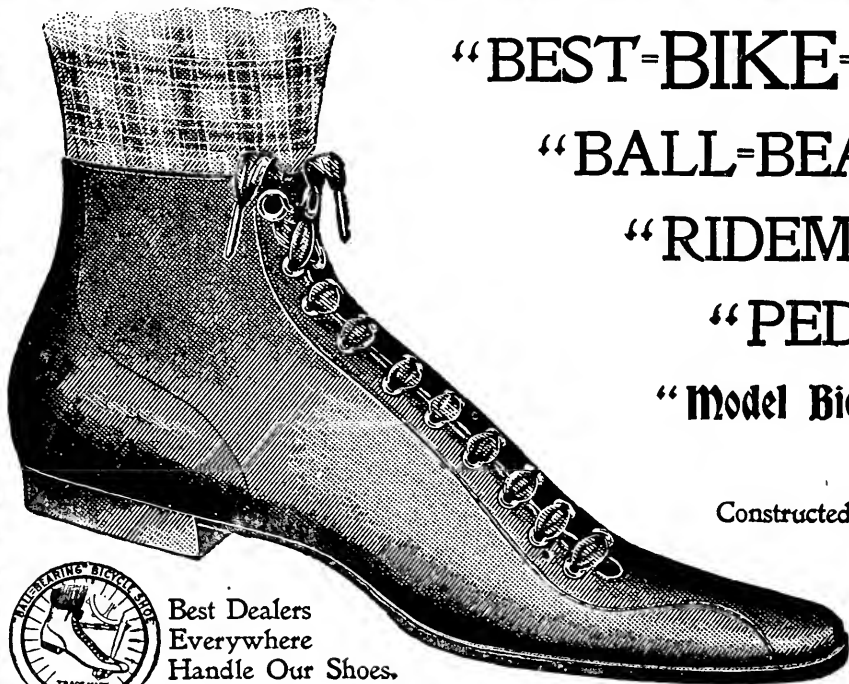

“BEST=BIKE=SHOES,”

“BALL=BEARING,”

“RIDEMPHAST,”

“PEDALSHOE,”

“Model Bicycle Shoes  
of the World.”

Constructed on scientific principles.

EASY TO RIDE IN—

EASY TO WALK IN.



Best Dealers  
Everywhere  
Handle Our Shoes.

... Pratt Fasteners Hold Laces ...

**THE “B=B” SHOE MFG. CO.,**

121 Duane Street,

New York.

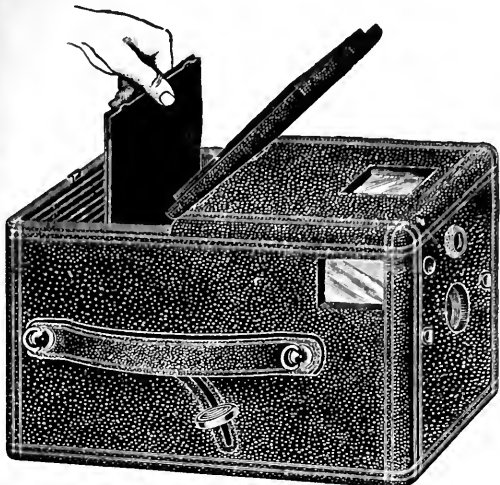

## Do you Know about The New Camera?

The first one with which Amateurs can do Professional work. Results equal the work of \$25 cameras. No failures. No mistakes. No light-struck plates. You can't help doing expert work with it.

## The Adlake Camera

COMPLETE WITH TWELVE METAL  
LIGHT - TIGHT PLATE HOLDERS,  
Prepaid to any part of the United States }

**\$12<sup>00</sup>**

Takes 12 pictures on glass plates at one loading. Takes a standard size plate 4x5 inches and cuts a sharp, clear picture to the extreme edge. Is fitted with an expensive, extra rapid achromatic lens, specially ground.

THE Adlake Shutter has no projecting levers, nothing to break off, give out or get lost, and the diaphragm has three stops. Camera has finders for horizontal and perpendicular pictures and two tripod sockets. Handsomely covered with seal grain leather.

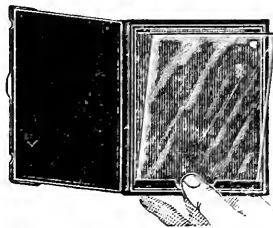

Made to open in  
**BROAD DAYLIGHT**

For loading and adjustment. Each camera fitted with 12 single metal plate holders, light proof and dust proof. No "extras" needed. Get your plates anywhere.

Our "Adlake Camera Book" tells all about it. Free for the asking. Sample mounted photograph 5cts. in stamps.

The Adams & Westlake Company, 122 Ontario Street, Chicago.



"SAY, CULLY, DIS IS A GOOD HEALTHY PLANT, AIN'T IT?"

---

# Camping and Camp Outfits

A MANUAL OF INSTRUCTION FOR YOUNG  
AND OLD SPORTSMEN.

Edited by G. O. SHIELDS ("COQUINA")

Author of "CRUISINGS IN THE CASCADES," "RUSTLINGS IN THE ROCKIES," "HUNTING IN THE GREAT WEST," "THE BATTLE OF THE BIG HOLE," "THE BIG GAME OF NORTH AMERICA," "THE AMERICAN BOOK OF THE DOG," "AMERICAN GAME FISHES," ETC.

---

12mo. 200 Pages. 30 Illustrations. Cloth, \$1.25.

---

**T**HIS book contains practical points on how to dress for Hunting, Fishing, or other Camping Trips; what to carry in the way of extra Clothing, Bedding, Provisions, Cooking Utensils, and all classes of Camp Equipage; how to select Camp Sites; how to make Camp Fires; how to build Temporary Shelters; what to do in case of Getting Lost, etc. It contains check lists of articles constituting Complete Camping Outfits; a list of the names and addresses of Guides, in various hunting and fishing countries, and much other information of value to Campers, and which has never before been given to the public.

The instructions given are based on an experience of twenty-five years in Camping, and in the study of Camp Lore, Woodcraft, etc., and it is believed that the work will prove of great value to thousands of men and boys, who have not had such favorable opportunities for study.

The book also contains a Chapter by

**DR. CHARLES GILBERT DAVIS, on CAMP HYGIENE, MEDICINE AND SURGERY**

ONE BY

**COL. J. FRY LAWRENCE, on CAMP COOKERY,**

AND ONE BY

**FRANK F. FRISBIE on THE DIAMOND HITCH, or HOW TO LOAD A PACK HORSE**

---

This book should be in the library of every Sportsman, and will be sent, post-paid, on receipt of price, by the Author,

*G. O. Shields, 19 W. 24th St., New York.*

---

*Given as a Premium for Four Subscriptions to Recreation*



This is the old Aztec idea of the game hog. He eats all he can hold of the fruit. Then he fills his apron full to overflowing. Then he cuts off the limb on which he sits; meantime heralding his exploits to the world by a great shouting and ringing of bells. He would have blown his horn, also, but in those days game hogs had no horns—nor even bristles. Finally this aztec game hog is undone by his own folly.

How like the modern game hog!

## 20 BOOKS

ON 20 DIFFERENT SUBJECTS,  
BUT ALL RELATING TO SOME  
DELIGHTFUL PHASE OF  
AMERICAN TRAVEL, VIA  
"AMERICA'S GREATEST RAIL-  
ROAD."



ILLUSTRATED CATALOGUE SENT  
FREE, POST-PAID, ON RECEIPT  
OF A 1-CENT STAMP BY GEORGE  
H. DANIELS, GENERAL PASSENGER  
AGENT, NEW YORK CENTRAL &  
HUDSON RIVER RAILROAD, GRAND  
CENTRAL STATION, NEW YORK.



"GEE!! LET'S GIT."

# Cruisings in the Cascades

A NARRATIVE OF

## TRAVEL, EXPLORATION, AMATEUR PHOTOGRAPHY, HUNTING, AND FISHING

WITH SPECIAL CHAPTERS ON HUNTING THE

**Grizzly Bear, the Buffalo, Elk, Antelope, Rocky Mountain Goat, and Deer; also on  
Trouting in the Rocky Mountains; on a Cattle Roundup;  
Life Among the Cowboys, Etc.**

BY G. O. SHIELDS ("COQUINA")

AUTHOR OF "RUSTLINGS IN THE ROCKIES," "HUNTING IN THE GREAT WEST," "THE BATTLE OF THE  
BIG HOLE," ETC.

12mo. 300 Pages. 75 Illustrations. Cloth, \$2.00; Half Calf, \$3.00.

The learned writer, scientist, and sportsman, Col. W. D. Pickett, better known as "P.," says of this book: "The true lover of nature who delights to occasionally escape from the annoyances and worriments inseparable from so-called civilized life, and to wander amid scenes that tell only of the infinite power, the beneficence, and the grandeur of the Great Ruler; who delights to worship in the grandest of all His temples—the mountains; who realizes and feels His presence on every mountain peak, in every dark canyon, in every rushing wind, in every gentle zephyr, and who, amid such scenes, above all realizes his own weakness and littleness; he it is who will take pleasure in following the author amid some of the grandest and most beautiful scenery on this continent. If, added to this, the reader should be imbued with some of the tastes and sympathies of the sportsman, additional zest will be given in the pleasant, graphic, and truthful descriptions of fishing and hunting incidents. The young sportsman who is desirous of hunting large game, will find here many indispensable hints as to their habits and the best methods of pursuing them. This book will meet with universal favor."

Mr. T. S. Van Dyke, author of "The Still Hunter," and other popular books, says: "It is one of the most entertaining books on field sports yet published. Mr. Shields always has something to say, and says it in a way that makes one see it. He is never dull, and there is an air of truth about his work that fully satisfies the reader."

Mr. Orin Belknap, known and loved of all sportsmen by his familiar pseudonym "Uncle Fuller," says: "The author of this work has placed the sportsmen of America under lasting obligations by his pleasing descriptions of his adventures in the wilds of these little-known mountains. Any writer who calls the attention of American sportsmen to the wonderful opportunities for legitimate sport—worth a trip across the continent, or a life-time of the tame enjoyment of Eastern sportsmanship—hidden away in the mysterious gorges of the Cascade range, deserves the thanks of each and all who ever shouldered gun or rod. May this book prompt others of America's adventurous lovers of the wilderness to more thorough search for the hidden wonders of these mighty hills."

"Boone," the writer of so many charming reminiscences of days among the hills, says of this book: "To the reader whose calling in life, or whose personal limitations shut him off from the privileges enjoyed by Mr. Shields, there is given in these pages descriptions of scenery so vivid as to enable him to realize the grandeur in nature of the land that gives us birth. There are given him descriptions and traits of animals, in their wild state and in their native haunts, that he may never see save in collections. Let me commend it to all into whose hands this book may come—and they ought to be many—to give it a *careful*, not a cursory reading. On second, and attentive reading, I was really struck by the accuracy of the author's descriptions of the bison, elk, antelope, grizzly bear, and mountain goat; and the delineations from his camera make the whole work graphic indeed."

"Sillalicum," another well-known and popular contributor to the sportsmen's journals, has this to say: "Mr. Shields evidently saw everything that could interest the sportsman, farmer, lumberman, or tourist; and has described the country and its objects of interest in an effective and truthful way, with the eloquence of the artist, and the enthusiasm of the sportsman. No book ever published on Western sports is so delightfully written. A perusal of its pages places the reader among the scenes described, and he imagines himself looking at the rushing schools of salmon; he hears the murmuring of the mountain stream; the whispering of the alpine zephyr; and can almost catch the gleam of the mountain lake as it washes the foot of the cragged peak on which roams the white goat."



Says W. B. Leffingwell, the gifted author of "Wild Fowl Shooting," and of "Shooting on Upland, Field, and Marsh": "I have rarely encountered, anywhere, such vivid descriptions of life in the mountains, as are found in 'Cruisings in the Cascades.' My blood tingles as I follow the author, through these pages, in his encounters with the noble game he found in the great hills; and I long to lay aside the cares of business and seek those mighty fastnesses wherein he had such grand sport."

"Men who enjoy jaunts into the woods, in search of big game, will find this book extremely interesting."—*New York Herald*.

"'Cruisings in the Cascades' is by far the best thing Coquina has ever written."  
—*American Field*.

"It is a handsomely printed and finely illustrated volume, made up of spirited sketches of travels, explorations, hunting, and fishing. It is charmingly interesting. The author mingles solid facts of great value with accounts of his wild adventures, and tells the story in an offhand style that banishes sleep from tired eyes."—*Chicago Inter-Ocean*.

"Mr. Shields handles a much diversified group of subjects with a master hand, and adheres throughout to a singularly pleasant and original way of expressing himself. His chapter on 'Trouting in the Rocky Mountains' is as delicious a bit of word-painting as we have ever met with."—*Sports Afield*.

"'Cruising in the Cascades' is Mr. Shields' latest, and, we think, best publication. It will be heartily appreciated by American sportsmen. One of the most important chapters in the book is that on the Rocky Mountain goat. Heretofore little has been written on that animal, and Mr. Shields has treated the subject in a thorough and careful manner. He has recorded much valuable matter, with regard to this animal, which can be referred to by naturalists and sportsmen with profit. Many of the illustrations in the book are from photographs taken by the author, and are unusually good."—*Shooting and Fishing*.

"Coquina is widely and favorably known as an entertaining, practical writer on outdoor sports, and 'Cruisings in the Cascades' will add to a well-earned fame in his special field. His pen-pictures of wild life and wild sports, in the Far West, are accompanied by many excellent illustrations of fish and game, and of the scenes and places visited, adding greatly to the attractive character of the work."—*The Independent*.

"The pages are breezy and the illustrations numerous and attractive, the camera having been freely used by the author in his travels."—*The Bookbuyer*.

"Mr. Shields touches on numerous subjects. Nothing seems to escape his keen eye, and whatever he describes becomes vivid to the mind of the reader, full of interest and clearly defined. His pen-pictures of hunting adventures, boating, and the sports of the ranch, tingle with the warm glow of quickened pulse-beats and rapidly coursing blood."  
—*Book Chat*.

"The author's style of writing would make even a dull subject enjoyable, but with such a theme—his own extended and rich experience—we have a book whose wide circulation seems assured. There are enchanting sketches of scenery, pleasing stories of mountain climbing, of hunting and fishing; excellent estimates and delineations of Indian character, drawn from personal contact; a fine description of salmon and their habits, and such accounts of bear, elk, deer, and goat hunting as to make the blood of the hunter tingle in every vein."—*Public Opinion*.

"Mr. Shields is not only a hunter, but an angler, and an amateur photographer, and on his excursions in the mountains has made good use of his opportunities. As a narrative of adventure the book is entertaining, and as a record of sport it will delight many readers."—*The Literary World*.

"It is sure to meet with a large sale."—*Chicago Tribune*.

"It is by all odds the most fascinating book on big game hunting ever published."  
—*The Journalist*.

"The illustrations are, for the most part, made from photographs, and are one of the chief charms of the book. Those who have read 'Rustlings in the Rockies,' by the same author, are familiar with the charm of his style."—*Photographic Times*.

"It is beautifully printed and profusely illustrated, detailing a great variety of adventure in travel, exploration, hunting, and fishing. Mr. Shields is an enthusiastic lover of nature, in all her wilder forms, with an eye quick to see the beauty and grandeur of river and plain, and forest and mountain, and a ready pen to describe them. He is a keen and tireless sportsman, a quick and accurate judge of men, with that curious quality of humor that enables a man to see and enjoy the oddities, even in perilous passages, all grounded on the restless spirit of the born rover. To the great majority of men, for whom wild adventure possesses an irresistible fascination, this book is full of the most absorbing interest."—*Chicago Times*.

Mailed, post-paid, on receipt of price, by the Author,

G. O. SHIELDS, 19 West 24th Street, New York,

Or given as a Premium for 5 Subscriptions to Recreation

# TO VACATIONISTS

## SUMMER LITERATURE RELATING TO EASTERN HILLS, OCEAN SHORES AND ISLANDS

**Manual of Old Colony Summer Resorts.** Containing a list of Summer Hotels and Boarding-houses within the Old Colony territory; Excursion Rates, etc. It embodies also a list of villages and points of interest not on the direct line of the Old Colony System, reached by stage or other conveyance. Sent upon receipt of two-cent stamp.

**Along the South Shore.** A new booklet devoted to the advantages, situations, etc., of the "South Shore" as an Ocean Summer Resort. It includes all the shore territory lying along the Bay coast south of Boston, or between Braintree and Duxbury inclusive. For two-cent stamp.

**Plymouth as a Summer Resort.** A book devoted to the attractions, historic associations and localities, and natural endowments of ancient Plymouth, as of interest to summer visitors and sojourners. Mailed for two-cent stamp.

**Quaint Cape Cod and its Summer Delights.** "Quaint Cape Cod" presents the claims of that section as a Summer Resort, and affords all information regarding Cape Cod, its localities, scenery, recreative features, etc. Sent on receipt of four cents for postage.

**Martha's Vineyard, its Attractions as a Summer Resort.** Presenting a sketch of the Island of Martha's Vineyard, its towns, villages, and summering places. Sent upon receipt of two-cent stamp.

**Nantucket, an Island in the Ocean.** Descriptive of Nantucket, its institutions, natural features, attractions, etc., with something of its history and characteristics. Sent on receipt of two-cent stamp.

**Handbook of Newport, the "Queen of Watering Places."** Containing general information for visitors, concerning walks and drives, location of streets, public parks, grounds, estates, their occupants, etc. Sent for two-cent stamp.

**A Sketch of Narragansett Pier.** A folder descriptive of this beautiful section, containing historic and local matter relating thereto, with such information as the visitor or sojourner will find of interest. Mailed for two-cent stamp.

**Manual of Summer Resorts on the New Haven System.** Containing a list of Hotels, Boarding-houses, Ticket Rates, Excursion Points, and various information. Mailed on receipt of two-cent stamp.

**The Berkshire Hills.** Descriptive of the localities along the Berkshire Division of the N. Y., N. H. & H. R. R.; the natural beauties of the Housatonic River and the country through which it flows. Will be sent for two-cent stamp.

Any of the above will be forwarded on receipt of postage stamps as stated. Mention RECREATION and address O. H. TAYLOR, Gen'l Passenger Agent, Fall River Line, Pier No. 18, North River, New York City; A. C. KENDALL, Gen'l Passenger Agent, N. Y., N. H. & H. R. R. (Old Colony System), Boston, Mass., or C. T. HEMPSTEAD, Gen'l Passenger Agent, N. Y., N. H. & H. R. R. (New Haven System), New Haven, Ct.



"NOW I'LL JIST FINISH PLANTIN' 'EM, 'N 'EN I'LL TAKE THAT BOODLE HOME."

**Wanted.**—A few men to form stock company for cattle business. A few thousand dollars required. Ranch already established. Investment will be safe and will pay 40 per cent. profit. Those who are fond of hunting and fishing could spend a few months each year at the ranch, which is beautifully situated near the Rocky Mountains. Good cabin and out-buildings. Excellent opportunity. Best of references given and required.

Address, "Edgar,"  
Room 191, 45 Broadway, New York City.

### WHERE TO GET BIG GAME.

Have you located your happy hunting ground for next fall? If not, I will agree to take you to moose, elk, deer, bear, plenty of mountain goats, fish and grouse galore, providing you wish my services as guide. Only 40 miles from the R. R. to the hunting grounds. Good pack outfits, tents, etc. Horses good and gentle. Terms reasonable. Best of references; 18 years' experience as guide.

Vic Smith, Anaconda, Mont.

**For Sale.**—The  $\frac{1}{2}$  rater yacht "Die Hexe." Built in 1896, of  $\frac{3}{8}$  inch planking and steam bent timbers, thoroughly fastened. Has hollow spars throughout, and 2 full sets of racing sails, consisting of 2 jibs, 1 balloon jib, 1 square and 1 leg of mutton mainsail. Is in perfect order and is one of the fastest of her class. Address,

Becker & Murken,  
169 South 4th St., Brooklyn.

**Jas. L. McLaughlin.**—Experienced Guide. Best references furnished. Elk, moose, deer, mountain sheep, antelope, lions, bear, sage hens and grouse. Best trout fishing in the country, within 10 minutes' walk of my ranch. Would take a few boarders. Tourist outfits furnished on short notice. Address,

Ishawood, Big Horn Co., Wyoming.

### ANY PARTY

wanting to see the  
**National Park,**  
or to hunt in the  
Teton or Jackson's Hole countries,  
should write me.

These are the best big game ranges in the United States. Moose, elk, deer, bear, mountain sheep, mountain lions, and all kinds of small game abundant; also the best of trout fishing in the West.

Have put in 16 years hunting, trapping, and guiding in Wyoming, Idaho, and Montana, and know where to go for any kind of game you want. Write me and I will give you full particulars.

GEORGE WINEGAR, St. Anthony, Fremont Co., Idaho.

**For Sale:** A new Idea! Loading Machine, price \$5; 3 Hills Patent Releasing Sparrow Traps, \$5. Will take \$10 cash for the 4 articles, or will trade anything useful, for an equal amount.

George Burkhardt, 14 Baitz Ave., Buffalo, N. Y.

### A RARE OPPORTUNITY

**A Willsie Pocket Camera, Valued at \$5.00**

As a premium for 5 yearly subscriptions to RECREATION. This Camera makes a picture  $2\frac{1}{2} \times 2\frac{3}{8}$  inches, and can be loaded with 24 cut films. You can get the 5 subscriptions in one hour.

Write This Office for Camera Catalogue.

**Who wants a Florida home?** 11 $\frac{1}{2}$  acres of good land; good house, stable, air, water, and healthy country. Fruit—oranges, lemons and grapes. Game, such as deer, turkeys, quail, rabbits, snipe, woodcock, etc. Price \$1,000. Terms easy. L. Allen, Oak Hill, Fla.

## KAREZZA ETHICS OF MARRIAGE.

A bold, brave book teaching ideal marriage, rights of the unborn child, a designed and controlled maternity.

**Union Signal:** Thousands of women have blessed Dr. Stockham for Tokology, thousands of men and women will bless her for Karezza.

**Arena:** Karezza is worth its weight in gold.

Sample pages free. **Agents Wanted.** Prepaid \$1.00.

**ALICE B. STOCKHAM & CO., 277 MADISON ST., CHICAGO.**

**For Sale:** Two large Moose heads, with horns, mounted in first-class style. Spread of horns, 50 and 51 inches. Horns uniform and perfect. A snap for someone. For particulars and price, write

R. STRUTT, Pembroke, Ont., Canada.

**Information** about Hotels, Camps, Summer Resorts, Farm Board, Outfit for Fishing and Hunting, and Guides to Maine woods and waters. Reliable. Free.

Maine Information Bureau,  
Phillips, Maine.

**For Sale:** Winchester rifle, model 73; 22 caliber, Lyman rear sight; in perfect order; price, \$8.00.

Louis K. Ervin, Bear Creek,  
Hinds Co., Miss.

**Wanted:** Illustrated catalogue of Ballard rifles. Will pay postage on same.

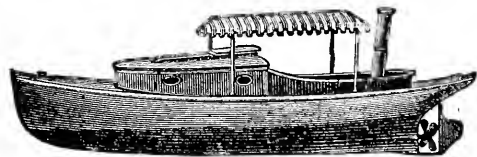

Also  
Vapor  
Hunting  
Launch.

(The hit of the Sportsman's show.) Motor controlled from bow. Valve movement, 12 to 1. 16 to 60 ft. Launches. Twin Screws a specialty. 1, 2, 3, 5, 7, 12, 14, and 20 h. p. No licensed engineer or pilot required. Speed and Safety guaranteed. No dangerous Naphtha or Gasoline used. No disagreeable vibration. *Send Ten Cents in Stamps for 1897 Catalogue.*

MARINE VAPOR ENGINE CO., ft. Jersey Ave., Jersey City, N. J.

## Blair's Pills

Great English Remedy for  
**GOUT and RHEUMATISM.**

SAFE, SURE, EFFECTIVE.

Druggists, or 224 William St., New York.



# THE AMERICAN BOOK OF THE DOG

THE ORIGIN, DEVELOPMENT, SPECIAL CHARACTERISTICS,  
UTILITY, BREEDING, TRAINING, DISEASES, AND KENNEL  
MANAGEMENT OF ALL IMPORTANT BREEDS OF DOGS

*A Book for Dog Fanciers and Dog Owners*

EDITED BY G. O. SHIELDS ("COQUINA")

AUTHOR OF "CRUISING IN THE CASCADES," "RUSTLINGS IN THE ROCKIES," "HUNTING IN THE GREAT WEST," "THE BATTLE OF THE BIG HOLE," "THE BIG GAME OF NORTH AMERICA," "CAMPING AND CAMP OUTFITS," ETC.

8vo, 700 Pages, 85 Illustrations. Cloth, \$5.00; Half Morocco, gilt top, \$6.50; Full Morocco, gilt edges, \$8.00

## CONTENTS

- |                                                                                                                                            |                                                                                                                                       |
|--------------------------------------------------------------------------------------------------------------------------------------------|---------------------------------------------------------------------------------------------------------------------------------------|
| The English Setter. Bernard Waters, Kennel Editor<br>The American Field, and author of "Modern Training, Handling, and Kennel Management." | The Yorkshire Terrier. P. H. Coombs.                                                                                                  |
| The Irish Setter. Max Wenzel, Secretary The Irish Setter Club of America, and B. F. Seitner, Vice-President The Pointer Club of America.   | The Chesapeake Bay Dog. George W. Kierstead.                                                                                          |
| The Gordon Setter. Harry Malcolm, President The American Gordon Setter Club.                                                               | The Bedlington Terrier. W. H. Russell.                                                                                                |
| The Pointer. Charles K. Westbrook, A. M.                                                                                                   | The Irish Terrier. Dr. J. S. Niven.                                                                                                   |
| The Greyhound. Col. Roger D. Williams, President The Iroquois Hunting and Riding Club.                                                     | The Bull Terrier. Frank F. Dole.                                                                                                      |
| The Deerhound. Dr. Q. Van Hummell.                                                                                                         | The White English Terrier. E. F. Burns.                                                                                               |
| The Foxhound. Dr. M. G. Ellzey, Associate Editor The National Economist.                                                                   | The Airedale Terrier. F. H. F. Mercer.                                                                                                |
| The Bassethound. Lawrence Timpson.                                                                                                         | The Scottish Terrier. John H. Naylor.                                                                                                 |
| The Dachshund. William Loeffler.                                                                                                           | The Dandie Dinmont Terrier. John H. Naylor.                                                                                           |
| The Bloodhound. J. L. Winchell.                                                                                                            | The Skye Terrier. Lawrence Timpson.                                                                                                   |
| The Russian Wolfhound. William Wade.                                                                                                       | The Black and Tan Terrier. Dr. H. T. Foote.                                                                                           |
| The Beagle. H. F. Schellhass, President The American-English Beagle Club.                                                                  | The Maltese Terrier. Miss A. H. Whitney.                                                                                              |
| The Irish Water Spaniel. P. T. Madison, Secretary The Indiana Kennel Club.                                                                 | The Collie. Henry Jarret and J. E. Dougherty.                                                                                         |
| The English Water Spaniel. William A. Bruette.                                                                                             | The Old English Sheep Dog. William Wade.                                                                                              |
| The Clumber Spaniel. F. H. F. Mercer, Kennel Editor Sports Afield.                                                                         | The Great Dane (German Dogge). Prof. J. H. H. Maenner.                                                                                |
| The Sussex Spaniel. A. Clinton Wilmerding, President The American Spaniel Club.                                                            | The St. Bernard. F. E. Lamb.                                                                                                          |
| The Field Spaniel. J. F. Kirk.                                                                                                             | The Mastiff. William Wade.                                                                                                            |
| The Cocker Spaniel. J. Otis Fellows.                                                                                                       | The Newfoundland. L. F. Whitman.                                                                                                      |
| The Fox Terrier. August Belmont, Jr., President The American Kennel Club, and The American Fox Terrier Club.                               | The Bulldog. John E. Thayer.                                                                                                          |
|                                                                                                                                            | The Dalmatian Coach Dog. Maj. T. J. Woodcock.                                                                                         |
|                                                                                                                                            | The Poodle. W. R. Furness.                                                                                                            |
|                                                                                                                                            | The Italian Greyhound. Dr. G. Irwin Royce.                                                                                            |
|                                                                                                                                            | The Pug. G. W. Fisher.                                                                                                                |
|                                                                                                                                            | The Mexican Hairless Dog. Mrs. Elroy Foote.                                                                                           |
|                                                                                                                                            | The Toy Spaniels. Miss Marion E. Bannister, Secretary The New York Pet Dog Club.                                                      |
|                                                                                                                                            | The Schipperke. E. R. Spalding.                                                                                                       |
|                                                                                                                                            | Diseases of the Dog, and their Remedies. Dr. J. Frank Perry ("Ashmont"), author of "Dogs; Their Management and Treatment in Disease." |
|                                                                                                                                            | Spaniel Training. F. H. F. Mercer.                                                                                                    |

The Hon. John S. Wise, the eminent statesman and lawyer, President of the Pointer Club of America, and one of the most distinguished sportsmen and dog fanciers in the country, says of this book:

"In selecting contributors to this work Mr. Shields has displayed rare good judgment. His list of writers embraces the names of many gentlemen who are recognized as leading authorities on the subjects of which they write. While those articles may, in some cases, be more or less tinged by the peculiar views of their authors, the book, thus drawn from many different minds, is not only very eclectic in character, but, in my judgment, much more correct and valuable, as a whole, than it could be were it the production of an individual."

"The book is exceedingly interesting. It is free, too, from the sameness of expression and treatment so often found in books of this character, written by one man. It is, moreover, a very instructive book, and of practical value, in many features, to the owners and breeders of dogs."

"A valuable feature of this book is the illustrations. Many of these are artistic and beautiful in a high degree. The portraits of several dogs of world wide reputation are shown, and those of many other typical specimens, less widely known, add to the interest and attractiveness of the work. Nearly every breed is illustrated, and of some breeds several good specimens are pictured."

This book will be mailed, post-paid, on receipt of price, by

G. O. SHIELDS, 19 West 24th Street, New York

Or given as a Premium for 7 Subscriptions to Recreation

# You Get the Profits

Of Dealers, Agents, Jobbers  
and Middlemen by buying di-  
rect from the manufacturer.

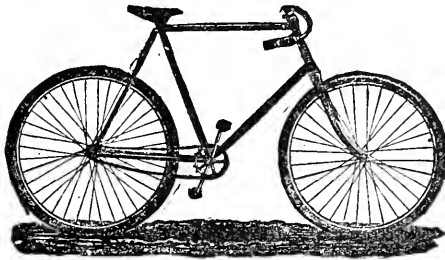

No better wheel made than the

## Acme Bicycle

Built in our own factory by  
skilled workmen, using the best  
material and the most improved  
machinery. *We have no agents*  
Sold direct from factory to the  
rider, fully warranted. Shipped  
anywhere for examination.

WRITE FOR

## Our Interesting Offer

Acme Cycle Co., Elkhart, Ind.

# Tribune Bicycles

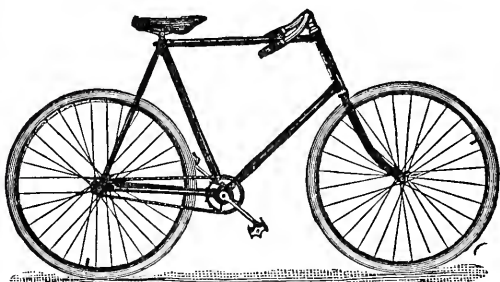

The Best in the World

Send for Catalogue

**THE BLACK MFG. CO.**  
ERIE, PA.

Mention RECREATION.

Use **“Plugine”**  
TRADE MARK  
Beforehand

Then ride your wheel in safety.  
It absolutely prevents punctures.  
We guarantee tires that contain  
Plugine, Easy to apply, Sent  
postpaid on receipt of \$1.00.

**The National Specialty Co.,**  
91 Euclid Avenue, Cleveland, Ohio.

1897 **High Grade Bicycles**



for Men, Women, Girls &  
Boys. Complete line at  
lowest prices ever quoted.  
\$100 ‘Oakwood’ for \$45.00  
\$85 ‘Arlington’ “ \$37.50  
\$55 “ “ \$25.00  
\$20 Bicycle “ \$10.75

\$75 ‘Maywood’ Simplest, Strongest Bicycle on Earth “ \$32.00  
Fully guaranteed. Shipped anywhere C.O.D. with privilege to examine. No money in advance. Buy direct from manufacturers, save agents and dealers profits. Large illustrated catalogue free. Address (in full).  
Cash Buyers’ Union, 162W. Van Buren St. B 359 Chicago



“OH, I DUNNO.”

## HOW WE GOT HIM.

C. G. LATHROP.

My friend and I were patiently and persistently wading the deep crusty snow, through cedar swamp and marsh, on the trail of what we pronounced a moose.

Our chase lasted all day, leading us far into the deep forests, East of the C. & N. W. R. and in the direction of the great lakes. At last night overtook us in the deep, dark forest, and we were obliged to make camp. A fire was lighted and the night was spent amid the tall pines, which were cracking beneath the howling wind. We welcomed the coming of morning, and at daylight again set out on the trail of our moose. Within 2 hours we arrived at a point which showed where he had rested a part of the night. A light snow had fallen during the night, and he had but just left his resting-place. He had headed for a cedar swamp, and my friend followed the track, while I traveled to the East, following the ridge. We were to meet about noon at the East end of the swamp.

An hour had scarcely passed, when the crack of my friend's Winchester rang out, far to the North of me, and my courage fell, for I was sure Brow had bagged the game. I sat down on a log to think and to hope our moose might leave the swamp and that I might yet get a shot with my Marlin. In less than 20 minutes I heard a crashing of the under brush in the swamp. For a moment my heart drummed like a grouse on a hollow log. I leveled my rifle in the direction of the noise and awaited the coming of the long hunted moose. I did not have long to wait, for in an instant the brush parted and, with one mighty lunge, a deer struck the open ground. Alas this was not the moose! I did not lose much time in sizing him up, and at the report of my rifle he leaped into the air and fell dead. I hung him up, dressed him and had scarcely completed my work when I was again startled by a noise coming from the same direction as before. Again I placed my Marlin to my shoulder and kept a sharp lookout. Soon I saw a white flag move among the bushes. I was sure this was some part of the moose so I took good aim and fired at what I could see. The flag dropped at the report of my rifle, and Brow shouted, "Lookout Shep; he's my meat." I had shot at the deer which my friend was carrying on his shoulder. I had not had the buck fever until that moment; and would probably have been shaking yet, but for the coolness Brow showed. We shouldered our 2 small deer and set out to the Southeast in the direction of a clearing, where we would leave our deer before again taking up the trail of the moose; as neither of us had yet got a glimpse of him. Leaving our deer in the edge of the clear-

ing we followed the big fellow until about 3 P.M. when he turned to the South; and we were again heading in the direction of the clearing. When within one mile of the clearing, to our great joy we saw him about 40 rods ahead of us. Our 2 rifles were this time leveled; one report rang out and 2 hearts bounded for joy. As the smoke cleared we saw the animal moving at an unsteady gait. We hurried to the spot and found the snow spattered with blood, so we followed the trail.

We moved cautiously and 3 times caught sight of him, yet he gave us no show for even a snap shot. We finally arrived at the edge of the clearing and saw that he had gone straight across. My friend took the West side and I the East side of the clearing. We met on the hill, near a basin where we saw the moose standing within 25 rods of us. Again 2 rifles spoke. He made one lunge and fell forward, pierced by 2 bullets. Then I heard a shout from the opposite side of the basin, "Lookout Shep, he's my meat." But this would not go this time, and I replied that part of him was my meat.

He proved to be not a moose after all but the largest deer either of us had ever seen. He weighed over 300 pounds and we had hard work getting him and our 2 small deer out of the woods.

---

A. D. Porter and J. A. Dales returned from their fishing camp, on the Little Manistee river, last night. They were in camp 3 weeks. It is claimed they caught nearly 10,000 trout during that time.

Michigan Exchange.

Why quit so soon? Did they quit biting? Why not stay until you cleaned out the stream entirely? No use leaving any. If you did some other hungry hogs, like yourselves, will come along and take them. You might just as well go back and finish the job. We all know you have a great crop of bristles, without looking for them.

EDITOR.

---

Daniel Whitehouse, of Augusta, Me., caught at Bradley's, East Vassalboro, with hook and line and using worms for bait, 3 landlocked salmon weighing respectively 3¼, 3¾ and 4½ pounds. Edward Murphy took one that weighed 6½ pounds.

---

Hon. P. O. Vickery, of Augusta, Me., has been fishing on Swan lake. He was accompanied by Hon. H. O. Stanley. Mr. Vickery took 6 handsome fish—3 salmon and 3 trout, weighing, all told, 22 pounds. The largest of the salmon weighed 6½ pounds, and the smallest trout weighed 2½ pounds.

# THE BANNER

Is the Cycle Lamp for '97.

**\$2.50**

WITH RIGID BALL-SOCKET  
BRACKET LIKE CUT.



5½ IN. HIGH

**HANDSOME!  
PRACTICAL! HONEST!**

A powerful light-thrower, having a  
3-Inch Double-Convex Polished Optical Lens.

**REVERSIBLE OIL POT.  
POSITIVE WICK LOCK.  
WON'T JOLT OR BLOW OUT.**

Burns kerosene. Solid Brass, heavily nickelled; no solder. \$2.50 like cut, attachment for head or forks. \$2.50 with spring bracket. Sent, carriage paid, on receipt of price, when not kept by dealers. Send for illustrated catalogue.

New York. **PLUME & ATWOOD MFG. CO.**  
Boston.  
Chicago. FACTORIES: Waterbury and Thomaston, Conn.

# Do You Travel?

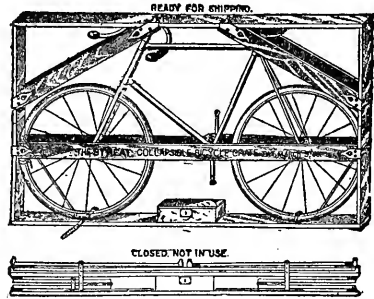

SHIP YOUR WHEEL IN THE

## Street Collapsible Bicycle Crate

Always ready for use.

Can crate your wheel in less than five minutes without the aid of a single tool, with pedals and all on.

Price, \$4; with Canvas Curtains, \$6

BOOKLET FREE

**HERBERT G. STREAT, Manufacturer**  
281 West 128th Street, New York

## OREGON SHORT LINE R.R.

Operating 1,421 miles of railroad, through the thriving States of UTAH, IDAHO, WYOMING, OREGON and MONTANA.

The short line to BUTTE and HELENA, MONTANA; BOISE CITY, IDAHO; PORTLAND, OREGON, and the North Pacific Coast.

The Popular Line to all Utah Mining Districts. The only Road to Mercur, the Johannesburg of North America.

The Fastest Service, in connection with the UNION PACIFIC SYSTEM, to all points West.

Buy your Tickets to the West and Northwest via the OREGON SHORT LINE, the Fastest and Best Railroad.

General Offices, 201 S. Main St., Salt Lake City

S. W. ECCLES *Gen'l Traffic Man.* D. E. BURLEY *Gen'l Pass. and Ticket Agent*

W. H. BANCROFT  
*Vice-President and General Manager*

## NOVA SCOTIA'S FULL OF FISH

Ever tried Tusket or Maitland River for trout? There's famous fishing there. Nothing in the United States compares with it. The Tusket region is just back of Yarmouth; Maitland River is a little farther in. It's a quick sail from Boston to Yarmouth—only 17 hours.

## A PERFECT VACATION LAND

is Nova Scotia, whether you want to fish, boat, or just loaf—delightful climate, fine scenery, good roads, and there's boating everywhere, and it's

## A DELIGHTFUL TRIP

going by the steamers "Boston" or "Yarmouth," of the Yarmouth Steamship Co., the finest and fastest steamers leaving Boston. They leave Pier 1, Lewis Wharf, Boston, every Tuesday and Friday at 12 o'clock, noon, during April, May, and June. Commencing June 24, they will leave every Monday, Tuesday, Thursday, and Friday at 12 o'clock, noon. "Beautiful Nova Scotia," our new 1897 Guide Book, handsome, entertaining, profusely illustrated, sent on receipt of 10 cents. For folders and information, write

J. F. SPINNEY, Agent

**YARMOUTH STEAMSHIP CO.**  
43 LEWIS WHARF





FATHER TIME: "WHAT ARE YOU DOING WITH THAT GUN, KID?"

CUPID: "WELL, YOU SEE THESE BICYCLISTS WERE TOO RAPID FOR MY OLD FASHIONED BOW AND ARROWS— BUT I GET 'EM ALL, NOW."

# The Prospect House



## ...Blue Mountain Lake

**L**ARGEST and finest hotel in the Adirondacks. Electric light, elevator, heated by steam, open fireplaces, hot and cold water baths. Finest hunting and fishing in the Adirondacks, over 100 deer being shot within two miles of the hotel in the season of 1896. There are over 30 ponds and lakes that can be reached for hunting and fishing purposes by leaving the hotel in the morning and returning the same day.

For terms and particulars, apply to

## PROSPECT HOUSE

REACHED BY NEW YORK CENTRAL  
AND DELAWARE AND HUDSON R. R.

Blue Mountain Lake, Hamilton Co., N. Y.

LONG BRANCH AND BACK, 50c. Baggage  
ASBURY PARK AND BACK, 80c. Checked Free

## : PATTEN LINE :

N. Y. and Long Branch Steamboat Co.

"Mary Patten" "Pleasure Bay" "Elberon"

### TIME TABLE, JUNE 1st, 1897

"Down the Bay." "Through the Narrows." "Up the Picturesque Shrewsbury."

Pier in New York, Foot of West 13th Street.  
Battery Landing Near Barge Office.

#### WEEK DAYS :

|                                               |       |            |       |
|-----------------------------------------------|-------|------------|-------|
| Leave New York, Foot of Bloomfield Street     |       |            |       |
| 8:30 and 9 A. M.                              |       | 2:40 P. M. |       |
| Leave Battery (Near Barge Office)             |       |            |       |
| 8:55 and 9:30 A. M.                           |       | 3:05 P. M. |       |
| Arrive Long Branch, 12 M., 12:30, and 6 P. M. |       |            |       |
|                                               | A. M. | P. M.      | P. M. |
| Leave Branchport, . . . . .                   | 7:00  | 4:00       | 5:00  |
| Leave Rockwell Avenue, . . . . .              | 7:10  | 4:10       | 5:10  |
| Leave Pleasure Bay, . . . . .                 | 7:20  | 4:20       | 5:20  |
| Leave Seabright, . . . . .                    | 7:45  | 4:45       | 5:45  |
| Arrive New York, . . . . .                    | 10:15 | 7:15       | 8:00  |

For the greater accommodation of through passengers, we have decided to make the steamer leaving New York at 8:30 A. M. (Battery 8:55) an "Express Boat," running through to Pleasure Bay, without stop, in three hours.

#### SUNDAYS :

|                                                       |                     |       |       |
|-------------------------------------------------------|---------------------|-------|-------|
| Leave New York, Foot Bloomfield St., 8:30 and 9 A. M. |                     |       |       |
| Leave Battery, . . . . .                              | 8:55 and 9:20 A. M. |       |       |
|                                                       |                     | P. M. | P. M. |
| Leave Branchport, . . . . .                           |                     | 4:00  | 5:00  |
| Leave Rockwell Avenue, . . . . .                      |                     | 4:10  | 5:10  |
| Leave Pleasure Bay, . . . . .                         |                     | 4:20  | 5:20  |
| Leave Seabright, . . . . .                            |                     | 4:45  | 5:45  |

The afternoon boat from New York connects at Seabright with boat returning to New York at 5:45.  
"The Surf Always in View."

Freight for Asbury Park or Ocean Grove carefully handled at lowest rates.

## Amateur Photographers

WILL FIND THAT THE

# WEST-SHORE RAILROAD

PRESENTS most delightful and varied Scenery for PHOTOGRAPHING AND SKETCHING. Its Mountains, Woodlands, Streams, Lakes, and Valleys, provide subjects for an

Infinite Variety of Pictorial Gems . . . . .

THE HUDSON RIVER

THE CATSKILL MOUNTAINS

THE MOHAWK VALLEY

THE NIAGARA FALLS

All contribute to make this the most desirable route for persons of artistic temperament.

Five elegant Fast Trains with through Sleeping Cars to Kingston, Albany, Utica, Syracuse, Rochester, Niagara Falls, Toronto, Cleveland, Detroit, Chicago, and St. Louis.

**DIRECT ROUTE** to the Adirondacks, making close connections with railways, steamers, and stages for all the choice hunting and fishing grounds of that delightful region.

FOR INFORMATION, ADDRESS

H. B. JAGOE, G.E. Pass. Agt. J. WOLFE, Gen. Agt.  
363 Broadway, New York Albany, N. Y.

C. E. LAMBERT, Gen. Pass. Agent  
8 Vanderbilt Avenue, New York

# A Summer

## AT THE ISLES OF SHOALS

Is equivalent to a long ocean voyage. Ten miles at sea, possessing an unequalled climate, and wonderful natural attractions, the islands have been the leading ocean resort for twenty years. Immunity from hay fever guaranteed. The finest fishing, bathing, boating, yachting, and all in-door and out-door amusements.

Send for illustrated booklet to

### OCEANIC HOTEL

Isles of Shoals  
Off Portsmouth, N. H.

H. G. MARVIN, Manager.

THE . . .

## ADIRONDACK . . .

## MOUNTAINS Called in Old Times

"THE GREAT NORTH WOODS."

A marvelous wilderness, abounding in beautiful lakes, rivers and brooks, filled with the greatest variety of fish.

An immense extent of primeval forest, where game of all kinds is to be found.

This wonderful region—located in Northern New York—is reached from Chicago by all lines, in connection with the New York Central; from St. Louis by all lines in connection with the New York Central; from Cincinnati by all lines in connection with the New York Central; from Montreal by the New York Central; from Boston by a through car over the Boston & Albany, in connection with the New York Central; from New York by the through car lines of the New York Central; from Buffalo and Niagara Falls by the New York Central.

A 32-page folder and map entitled "The Adirondack Mountains and How to Reach Them" sent free, post-paid, to any address, on receipt of a 1-cent stamp by George H. Daniels, General Passenger Agent, New York Central & Hudson River Railroad, Grand Central Station, New York.

# The Press Button Knife

FOR

## Hunting, Fishing and Camping

Our 4-inch or 5-inch jack-knife is invaluable in emergencies when you need a strong knife quickly. Press button and blade is open for use.

- Four-inch Blade, Stag Handle, . . . . \$1.00
- Five-inch Blade, Stag Handle, . . . . 1.25

SENT POSTPAID

**LOTT & SCHMITT**

112-114 Walker Street  
NEW YORK

Can be Opened Instantly with One Hand by Slightly Pressing the Button : : : :

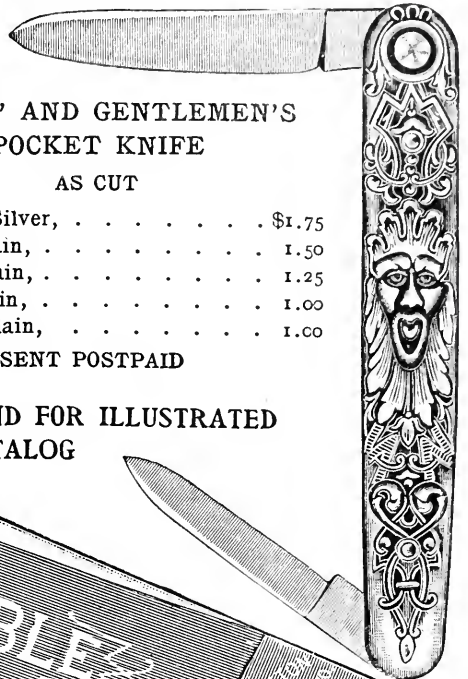

LADIES' AND GENTLEMEN'S  
POCKET KNIFE

AS CUT

- In Sterling Silver, . . . . . \$1.75
- In Pearl, Plain, . . . . . 1.50
- In Ivory, Plain, . . . . . 1.25
- In Stag, Plain, . . . . . 1.00
- In Ebony, Plain, . . . . . 1.00

SENT POSTPAID

SEND FOR ILLUSTRATED  
CATALOG

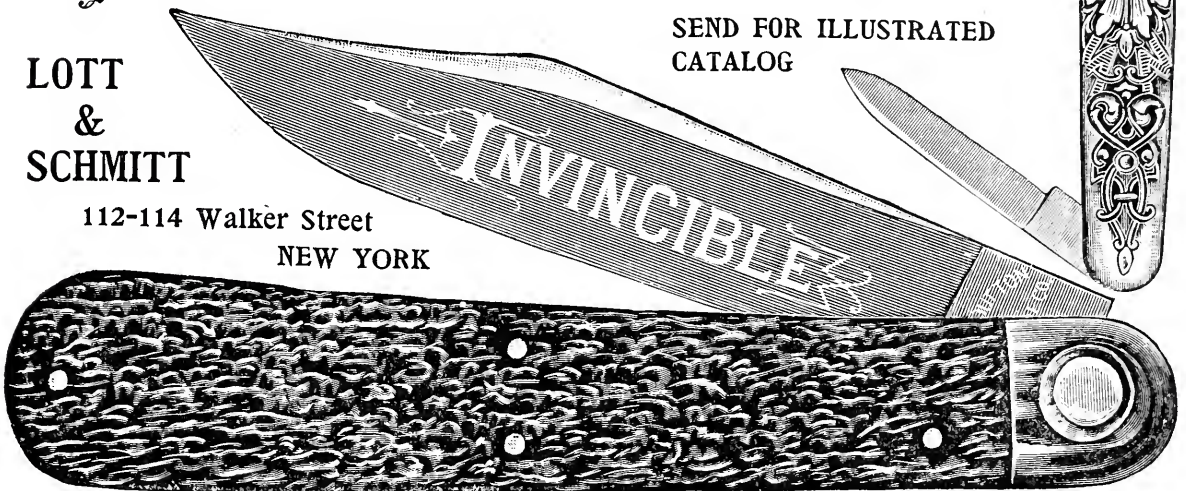

"Blanche got even with that old magazine editor who declined her poem."

"What did she do?"

"She went back while he was at lunch, and altered his sign to read: 'This is my boozy day.'"

"Somebody says the bath tub is the badge of civilization."

"I don't know about that; the biggest bores on earth are the people who brag about how often they bathe."

Sing a song of sixpence—  
A pocket full of rye;  
Four and twenty blackbirds  
Baked in a pie.  
Do the women eat it?  
Yes—but what of that?  
All they object to—is  
Blackbirds on a hat.

"Bridget looks strong enough in the arms to make a crack pitcher."

"Well—she's next thing to it—she's a pitcher-cracker."

A Trial will Convince You that  
**GOLDEN SCEPTRE**  
SMOKING TOBACCO  
Is Almost Perfection. We will send on receipt of 10c. a sample to any address. Prices of Golden Sceptre, 1 lb., \$1.30; ¼ lb., 40 cts., postage paid.  
— CATALOGUE FREE.—  
**SURBRUG, 159 Fulton Street, New York City.**

# FOR SALE

A fine St. Lawrence Skiff, with complete outfit for rowing and sailing.

Address Box 640, HARTFORD, CT.

**For Sale Cheap:** Two black and white fine bred dog hound pups. Half beagle. Or will exchange for lens or camera. Photo of dogs sent on request. Address

H. D. L., Box 218, Crown Point, N. Y.

# ON A YACHT

or in the woods—camping out or in a cottage—wherever you have any

thing to cook or water to heat, this little **LAMP STOVE** will do the work.

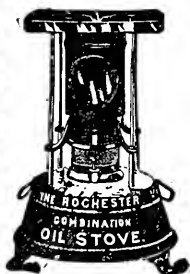

Saves room and bother. Holds 3 qts. of oil and burns 24 hours with one filling. Sent anywhere, securely **\$2.00.** packed, on receipt of

Complete Catalogue sent FREE on application. Address Dept. R. E.

**THE ROCHESTER LAMP CO.**  
42 Park Pl. and 37 Barclay St.,  
NEW YORK CITY.

# The Declaration of Independence and Mullins' Boat Catalogue

boats on the market. Need no repairs. Practically non-sinkable. We solicit your correspondence.

Are two documents that should be read by every true patriot and sportsman on the Fourth of July. The latter gives a full description of **MULLINS' PATENT SHEET METAL BOATS.** The handsomest and most durable

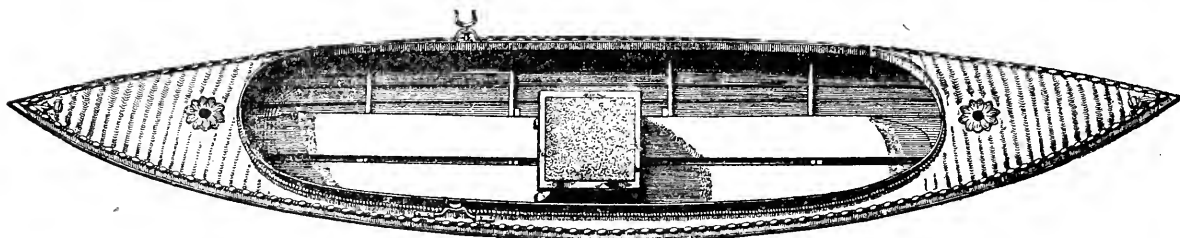

W. H. MULLINS, - - 228 DEPOT STREET, SALEM, OHIO

Sectional View

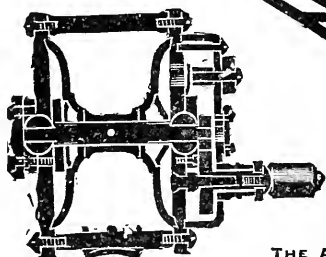

Globe Bearing.

# HENDRYX

Don't believe imitators of "**HENDRYX**" standard goods when they say their Fishing Reels "are **NOW** as good as **HENDRYX**". The fact that they imitate proves the "**HENDRYX**" is the **recognized** standard line of Fishing Reels. Ask your dealer for them.

THE ANDREW B. HENDRYX CO., NEW HAVEN, CONN., U. S. A.



# LYMAN'S RIFLE SIGHTS.

Send for 96 Page Catalogue of Sights and Fine Shooting Rifles.  
WILLIAM LYMAN, Middlefield, Conn.

J. B. CROOK & CO. Established 1837

1180 Broadway, Cor. 28th Street

Manufacturers and Importers of NEW YORK CITY, U. S. A.

# HIGHEST GRADE FISHING TACKLE HIGHEST GRADE

SPECIALTIES FOR 1897

Featherweight Rods, Aluminum Reels  
Trout and Salmon Flies

The only Waterproof Fly Lines: The London Black or Trout, Salmon, and Black Bass.  
Send for catalogue. Mention RECREATION.



# EARN A BICYCLE

600 Second Hand Wheels. All Makes. **GOOD AS NEW.** \$5 to \$15. New High Grade '96 models, fully guaranteed, \$17 to \$25. **Special Clearing Sale.** Ship anywhere on approval.

We will give a responsible agent in each town **FREE USE** of sample wheel to introduce them. Our reputation is well known throughout the country.

Write at once for our special offer.  
D. N. MEADE & PRENTISS, CHICAGO.



BOSTON WOVEN HOSE  
**VIM**  
AND RUBBER CO.

BOSTON WOVEN HOSE  
**VIM**  
AND RUBBER CO.

*Specify  
Vim  
Tires  
on your high-grade wheels.  
With Vimoid, which goes free  
with every pair of '97 Vims,  
you can make  
your own re-  
pairs.*

## WHAT THEY SAY OF IT.

Enclosed please find \$1, for renewal of my subscription to RECREATION. My boys would put me out of the house, if I did not get it regularly. Please change the address from my office to my house, as they bother the life out of me, every month, asking, "Has RECREATION come yet? Tie a string on your finger; then you won't forget to bring it home."  
Geo. F. Scannell, 48 E. 30th Street, N. Y.

At first I refused to subscribe for RECREATION, but when I got one copy from an agent, I gave him my subscription the next day. Now I am always looking forward for the time when the next number will come.  
Wm. E. Weisheit, Albany, N. Y.

I am greatly pleased with RECREATION. It requires little work to get up a club. All that is necessary is to show a copy to any one interested in any or all of the different lines of sport of which it treats.  
C. J. McKay, Fonda, N. Y.

I am very much pleased with RECREATION. It seems to improve with age. It stands alone as the best of sportsmen's papers. I recommend it heartily to all my friends.  
Paul J. Huelser, Brooklyn.

I began taking RECREATION last August and like it very much. I wish it would come every week. Hope you will have the 50,000 subscribers before December, '97.  
Albert L. Hill, Derry, N. H.

RECREATION is the best magazine I ever read. I have read 4 other sportsmen's journals, but yours is far ahead of them. I take great interest in your puzzle page.  
J. B. Watkins, Albany, N. Y.

RECREATION is the boss sportsmen's periodical of the country. There are 3 or 4 coming to this town, but RECREATION takes the doughnut, every time.  
H. S. Vogler, Young America, Minn.

I have only been a subscriber since January, but am already in love with RECREATION. It is the greatest value for the money ever offered.  
P. S. Miller, Stillwater, N. Y.

I received my first copy of RECREATION last week and it is a dandy. It is simply out of sight. Every sportsman should subscribe.  
F. A. Bill, Lockeport, Canada.

RECREATION is the "only shirt in the laundry." Hope it will still continue to take sweep stakes as "the Magazine."  
C. G. Porter, Springdale, Pa.

I enclose \$1 for renewal of my subscription to RECREATION. I cannot keep house now without RECREATION.  
O. F. Bike, Jackson's Hole, Wyo.

I think RECREATION is about as neat and newsy a Magazine as is printed. Am always glad when it comes.  
Geo. E. Long, Cleghorn, Ia.

RECREATION is a dandy. It grows better and better and I look forward to its coming with the keenest delight.  
Frank A. Dykeman, Catskill, N. Y.

I have read RECREATION for the last 2 years, and it is the best sportsmen's magazine I have ever seen.  
Lyle H. Thomas, Frankford, Pa.

Enclosed find \$1 for renewal of my subscription to RECREATION. I can't do without it.  
C. C. Bailey, Cookshire, Que.

Have been reading RECREATION for the last 2 years and could not get along without it.  
B. D. Hilford, Rudolph, O.

I find RECREATION one of the most interesting magazines I have ever read.  
R. A. Backman, Lunenburg, N. S.

Cannot get along without RECREATION. It's the boss, and no mistake.  
C. M. Allen, Marshfield, Wis.

RECREATION is the best monthly published. I only wish it came semi-weekly.  
Arthur Sussman, Long Branch, N. J.

I am a reader of RECREATION and think it is the only true sportsmen's journal going.  
Roy Camp, De Kalb, Ill.

I like RECREATION very much. The pictures being particularly fine.  
Daniel A. Duryee, Everett, Wash.

I have been reading RECREATION several years and value it above all other magazines of its class.  
Joseph Stuart, New York City.

RECREATION is the ideal publication of its class.  
J. W. Durham, Lockland, Ky.

# The Wing

# Piano

STYLE 7.

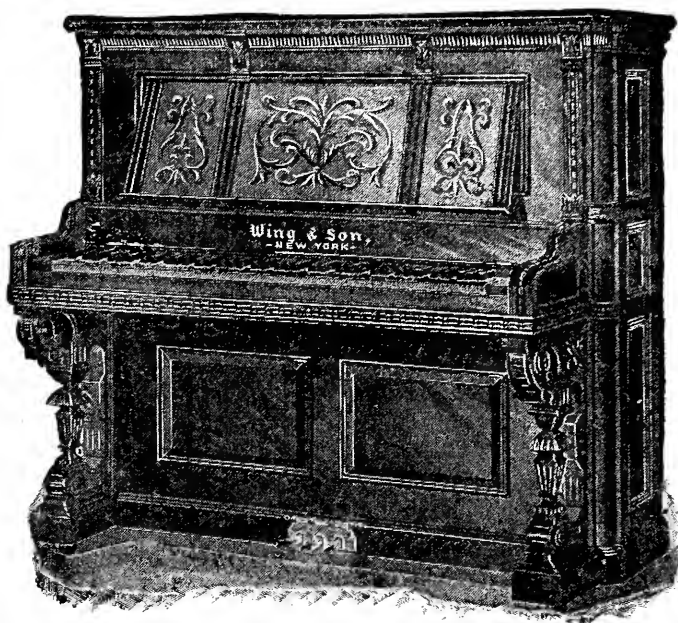

You do not have to pay an extravagant price for a first-class piano



In justice to yourself write for prices of the Wing Piano before you buy

## The Instrumental Attachment

imitates perfectly the tone of the Mandolin, Guitar, Harp, Zither and Banjo, giving the effect of an entire orchestra of these instruments playing in concert with the piano

**SENT ON TRIAL** We will send this piano, or your choice of four other styles, to any part of the United States *On Trial* (all freights paid by us), allow ample time for a thorough examination and trial in the home, and, if the instrument is at all unsatisfactory, we will take it back at our own expense. No conditions are attached to this trial. We ask no advance payment; no deposit. We pay all freights in advance.

**OLD INSTRUMENTS EXCHANGED  
EASY PAYMENTS**

OUR BOOK should be in the hands of every one who intends to buy a piano. It contains many valuable hints and instructions, and tells a great many things every buyer ought to know. We will send it free with our catalogue to any one who writes us.

**WING & SON,** 443 and 445 West 13th St., N. Y. City  
ESTABLISHED 1868

### WHAT THEY SAY OF THE PREMIUMS.

The enclosed order for \$15 is for 15 subscriptions for RECREATION. The names and addresses you will find attached, for which you may send me the Premo B. camera. The premiums I received from you, for the other 2 clubs I sent you a short time ago, were more than satisfactory. This makes 3 clubs I have sent you, in less than 3 months, and have received, in premiums, full value for same, for which accept my thanks. I have another club started, at this writing. It is no trouble at all to get subscribers for RECREATION. It is the best sportsmen's magazine published. It pleases them all.

Geo. Rushton, Cologne, Minn.

I have received the Marlin rifle for the 25 subscriptions, and to say I am pleased with it does not express my gratitude. I have tried it thoroughly and find it is not a toy, but exactly what Marlins claim for it. I have got my brother-in-law, of Danbury, Conn. working for you, and he has already (in 2 days) booked 19 names. He is starting out for 35 subscriptions and if I don't try and get up another club will help him out in his. It is an honor to say I got my rifle and trappings all for nothing, or for a few hours' work.

Howard M. Judd, Bethel, Conn.

It is with great pleasure that I announce the receipt of the 2 beautiful Marlin rifles, direct from the Marlin Arms Company, and they are all any sportsman could wish. I have tried them both and am well pleased with them. No one can afford to be without 1 of these guns, if he is a lover of hunting. I thank RECREATION for the splendid treatment and opportunities that have enabled me to become the proud possessor of 2 such fine guns.

O. H. Odell, Sidney, O.

Let me extend my sincere thanks for your most generous present (for such it is) for the 35 subscribers to RECREATION which I have sent you. The Ithaca gun received is not (as I supposed it would be) a cheap, roughly made, ungainly one, but is a beauty, well made, well balanced and a first class shooter. I have already showed it, with a good deal of satisfaction, and with a loud voice for the goodness of RECREATION. I certainly shall not forget you.

V. J. Elliott, Jackson, Mich.

I received the Bristol steel fishing rod, and the Yawman & Erbe automatic reel, that you ordered for me as premiums for 20 subscribers to RECREATION, and they are just what I wanted, and just what you

represented them to be. I thank you for your promptness and liberality. Will continue my canvass for subscribers to your excellent RECREATION.

H. O. Matter, Harrisburg, Pa.

I thank you for the Premo D. Camera. It is a beauty. Have taken some good pictures with it. I also wish to thank you again for the 32-40 Marlin rifle. Have given it a good test, and it will do more than it is advertised to do. It will carry 300 yards point blank, and that is about 150 yards better than I expected. I wish RECREATION the best of success.

O. E. Loomis, Akron, O.

I have received the repeating rifle, sent me as a premium, and do not see how on earth you can give such valuable premiums for so few subscribers. Let me thank you for such a handsome gift. I shall not lose interest in the king of sportsmen's magazines, but will do my best to increase its circulation, as far as lies in my power.

P. W. Tooth, Bath-on-Hudson, N. Y.

My new Premo camera is a dandy. I received it last Friday evening. Have made 4 exposures with it, and they are all fine. I always intended to buy a Premo, but I found something better than buying one. I was about 2 weeks getting the subscribers and it was easy work. This is a good way to get a No. 1 camera.

R. J. Bugbee, Ferndale, Cal.

The Bristol steel rods came to hand today, after a week's patient delay. They are beauties and I thank you heartily for them. In a short time I shall send you another club. The Bristol steel rods are the finest I ever saw, and I can hardly wait till the spring opens up sufficiently so that I can test them.

Edwin Morgan, Alliance, O.

The Forehand gun you sent me, for 35 subscriptions, received, and to say that I am well pleased with it is putting it mildly. For beauty and workmanship I do not think it can be beat. I have owned several guns but the Forehand comes nearer filling the bill than any I ever had. Many thanks to you and the Forehand Company.

W. S. Lander, Bloomington, Ill.

I wish to thank you for the Syracuse gun I received as a premium. I have given it a thorough trial, and am more than satisfied with it. It is a close, hard shooter. It surprised people around here greatly. I made some long shots at doves with it, last summer, and I cannot thank you enough for it.

W. H. Carman, Dunellen, N. J.





.... FISHING ....  
AND HUNTING  
.... REGIONS ....  
... OF MAINE ...

REACHED BY THE

## Bangor & Aroostook Railroad

The lakes and ponds teem with the most gamy of game fish; the speckled square-tailed trout, salmon, pickerel and togue. Visit such places as the

- MOOSEHEAD LAKE REGION
- PENOBSCOT RIVER REGION
- BIG MACHIAS LAKES
- FISH RIVER REGION
- AROOSTOOK RIVER REGION
- THE KATAHDIN PONDS

The Sportsmen's Paradise of the World!

The shipment of game by visiting sportsmen from our stations greater than from all New England put together.

Shipped in October, November and December, 1896: 2,245 Deer, 133 Moose, 130 Caribou, 15 Bears.

Through trains with Pullman Buffet Cars into the very heart of the wilderness. For an illustrated guide book, containing maps, rates of fare, etc., enclose two 2c. stamps to the General Passenger Agent.

**F. W. CRAM**  
Vice President and General Manager  
**GEO. M. HOUGHTON**  
General Passenger and Ticket Agent

General Offices, Bangor, Me.

## A New Lake and New Trout

Rear Admiral Beardslee, of the Pacific Coast Squadron, U. S. N., about a year ago brought to the attention of tourists and anglers a beautiful lake in Northwestern Washington, that contains new varieties of monstrous trout.

President Jordan of Stanford University, California, an authority on fishes, pronounced them entirely new to science. They are very large, weighing from 10 to 13 pounds and ranging from 10 to 30 inches in length. They are caught by trolling, at a distance of 30 feet or more below the lake's surface, and are the gamiest sort of trout, full of fight. Already, anglers have gone from the far east to Lake Crescent to enjoy the rare sport found there.

A long chapter on this beautiful lake and its finny inhabitants, located in the heart of the Olympic Mountains, is found in the Northern Pacific New Tourist Book, Wonderland '97. Send six cents for it to

**CHAS. S. FEE**

General Passenger Agent  
St. Paul, Minn.

...To "the" Pleasure Resorts of...  
**Texas and Gulf of Mexico**

TAKE



Via CHICAGO, KANSAS CITY, or  
ST. LOUIS

WAGNER BUFFET SLEEPERS  
FREE "KATY" CHAIR CARS

For further information, address

W. S. ST. GEORGE, Gen. East. Agt.  
409 Broadway, New York

THE  
**Racycle**  
NARROW TREAD

The Only Mechanically  
Correct Wheel on Earth.

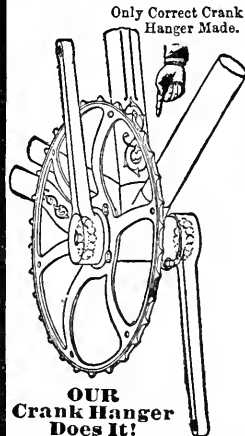

OUR  
Crank Hanger  
Does It!

Special Racycle, N. T's, \$100  
Special Racycle T'dems, 150  
Racycle, N. T's, . . . . 75  
Our Bicycles, . . . . 50

AGENTS WANTED.

Write for Terms.

CHICAGO, 323 Wabash Ave  
NEW YORK, 108 Fulton St.  
WASHINGTON, D. C.

MIAMI CYCLE & MFG. CO., Middletown, O.

The Racycle crank hanger has from 20 per cent. to 30 per cent. less pressure on the bearings than the crank hanger of any other bicycle on the market.

**\$1,000 in cash**

will be paid to the first person who can demonstrate that the above assertion is not a fact. No cycle considered without the consent of the maker. All infringements barred. Address all communications to

**RACYCLE**  
Middletown, O.



Model No. 3—\$100.

## WHAT THEY SAY OF IT.

RECREATION is the best magazine published, and every sportsman should take it. It is interesting from the first page to the last; so much so that I can hardly wait for the news agent to tell me it has arrived. I have only one objection to it, and that is it does not come often enough.

J. T. Gale, Bethany, Mo.

I enclose my check for \$2 for 2 years' subscription to RECREATION. I have taken a great deal of pleasure reading it, since I handed you my subscription at the first Sportsmen's Show, 3 years ago. The book grows better and better each month.

R. C. Reed, Fair Haven, Vt.

I send you this day \$1 to renew my subscription to RECREATION. I ought to stop it on account of the row it makes in the family, every month, when it comes. They all want to read it first, but I am too selfish and can't do without it myself.

M. H. Warner, Ten Sleep, Wyo.

RECREATION is the best magazine I have ever read, and I will always speak a good word in its favor, whenever I have a chance. Will do all I can to help enlarge its circulation; for it deserves all the praise any one can give it. You have my best wishes for success.

H. R. Rush, Lynn, Mass.

RECREATION and its advertisers are the fairest and squarest of their kind. I am glad to see you rub it into the fish and game hogs. I have just finished reading the current number of RECREATION, and I am anxiously awaiting the next.

Frank Greenhalgh, Paterson, N. J.

RECREATION is the best sportsmen's magazine published. When I want to go hunting or fishing, and have no time to go, I read RECREATION, and it fills the bill.

Theo. Lohr, New York.

I want to thank you for making RECREATION such a bright, and attractive magazine, and you can depend on me as a subscriber as long as I live.

August Ginter, Peotone, Ill.

Enclosed find \$1 for another year of RECREATION. I really enjoy it more than any of the other sportsmen's periodicals, and I take them all.

Dr. E. R. Kellogg, Chicago, Ill.

RECREATION is surely a thing of beauty. We intend having the volumes bound.

Mrs. M. H. Littell, Dallas, Texas.

RECREATION is far ahead of any periodical of its kind. Any one who loves the woods and streams can but admire it.

C. W. Perry, Helena, Mont.

Your mode of giving the fish and game hogs the "hot foot" is a source of gratification to the old sportsmen here.

Walter I. Shay, Marysville, Mont.

I am delighted with your wonderful book, RECREATION. It teaches one more than any other book of its class.

Geo. Colgan, Haverhill, Mass.

All sportsmen should study RECREATION well. If they would do so, there would be more game in the country.

D. Barclay, Bloomington, Ill.

RECREATION is the best thing of the kind I have ever read. I am pleased to introduce it to my friends.

C. T. Tupper, George, Iowa.

Your magazine takes the cake. The stories are great, and the half tones the best I ever saw.

L. A. Chapman, Dorchester, Mass.

RECREATION is the best sportsmen's magazine in the world. It should be in the hands of every intelligent family in America.

L. O. Lohr, Orange City, Ia.

Hope RECREATION will soon be found in every home, for it is pure, healthful reading for all.

Mrs. D. C. Bryant, Omaha, Neb.

I look with pleasure for the 1st of each month, for then RECREATION comes.

Chas. A. Patterson, Park Avenue, and 34th Street.

The May number of RECREATION is a beauty and it secured 4 subscribers yesterday.

W. R. Coleman, Massilon, O.

I congratulate you on the fact that RECREATION is getting better each month.

J. H. Madsen, Winnetka, Ill.

Yours is the magazine for me.

J. H. Jenny, Jr., Merrill, Wis.

RECREATION is a hummer.

F. M. Thomas, Catskill, N. Y.

# ASHLAND HOUSE

FOURTH AVE.  
and 24th ST.  
Two blocks from  
Madison Sq. Garden

...HEADQUARTERS FOR SPORTSMEN

American and  
European Plan

### RATES:

|                       |         |             |            |          |
|-----------------------|---------|-------------|------------|----------|
| Rooms, with board,    | \$2.00, | \$2.50      | and \$3.00 | per day  |
| Rooms, without board, | \$1.00  | and upwards |            |          |
| Breakfast,            |         |             |            | 75 cents |
| Lunch,                |         |             |            | 50 "     |
| Table d' Hote Dinner, |         |             |            | 75 "     |

# PROVIDENCE LINE

For BOSTON, WORCESTER, the NORTH and EAST. The Rhode Island and Massachusetts leave NEW PIER 36, N. R., one block above Canal St., at 5:30 P. M., daily, except Sunday. Shortest rail ride. FINE ORCHESTRA on each steamer.

STONINGTON LINE for Narragansett Pier, Watch Hill, all points East. Steamers MAINE and NEW HAMPSHIRE leave Pier 36, N. R., daily, at 6 P. M.

# The Phillips Phonograph (Maine)

is doing more for the woods there than anybody or anything else but the fish and game.  
SEND FOR A COPY—IT'S GAMY EVEN NOW.

# RUPTURE ABSOLUTELY CURED . . . . .

without truss, operation or confinement, on strictly scientific professional principles, based on an experience of many years. My method of treatment is known only to myself, and I object to long letters explanatory thereof. An interview is positively necessary for those requiring information.

Complete cure effected in 6 to 8 weeks; one treatment each week, with no detention whatever from business.

# SAGREDO

Care F. C. PRESTON, 98 Hudson Street, New York

# GOLD MEDAL CAMP FURNITURE MANUFACTURING CO., RACINE, WIS. U. S. A.

Manufacturers of the celebrated Gold Medal Camp and Folding Furniture, and Folding Portable Bath-tubs.

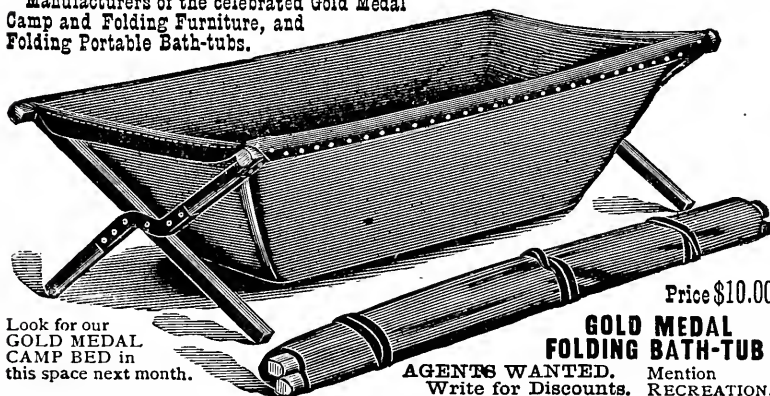

Look for our GOLD MEDAL CAMP BED in this space next month.

Price \$10.00

### GOLD MEDAL FOLDING BATH-TUB

AGENTS WANTED. Mention RECREATION. Write for Discounts.

None so Portable, none so Thoroughly Good and none so Comfortable.

This cut represents our Gold Medal Folding Bath-tub. These have been in use a year and have proved entirely satisfactory. The frame is constructed with our patent metal joints, in such a way that it folds in an exceedingly small space. The cover is made of very heavy, closely woven duck, coated with pure, thoroughly refined rubber, cured in such a way that it is tough and elastic. The duck is specially rubbered for us and we warrant it not to crack. This tub is made with no separate parts and is so arranged that it can be picked up and carried even when it contains water for the bath; and empties by simply raising one end, the other forming a trough through which the water is poured into a pail. It is in every way a practical bath-tub, strong enough to hold the heaviest person, and will last a generation. Folds 5 ft. by 5 in. square. Send for free Catalogue of Camp and Folding Furniture and Bath-tubs.

# Wyoming...

For Antelope, Bear, Cougar, Deer, Elk, Fish, Goat, Moose, Sheep, Grouse, Duck, and Sage Chicken Shooting,

ADDRESS H. D. DEKALB, BIG PINEY, WYO.

ADIRONDACK LANDS FOR SALE in Various Parts of that Region; Suitable for GRAND PARKS. GAME PRESERVES. COTTAGE SITES. FOREST LAND CO., SYRACUSE, N. Y.

IN ANSWERING ADS, IF YOU WILL KINDLY MENTION RECREATION YOU WILL GREATLY OBLIGE THE EDITOR.

## A RARE OPPORTUNITY

A Willsie Pocket Camera, Valued at \$5.00

As a premium for 5 yearly subscriptions to RECREATION. This Camera makes a picture 2½x2¾ inches, and can be loaded with 24 cut films. You can get the 5 subscriptions in one hour.

Write This Office for Camera Catalogue.

Cycle Touring in England at small expense. All about it, for 25c.

Arthur Munson, Stamford, Ct.



This is a picture of Sewell Newhouse, inventor of the celebrated **NEWHOUSE STEEL TRAPS**

known the world over as the best traps made for catching fur-bearing animals. Send to

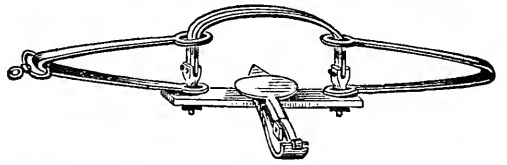

**ONEIDA COMMUNITY, Ltd., Kenwood, N. Y.**  
for catalogs, prices and discounts.

# The Operaphone

with it every word from the stage or platform can be heard in perfectly natural tones, by those sitting in remote parts of the Theatre, Opera House, Lecture Room or Church. By using the **OPERAPHONE** people hard of hearing can distinctly hear ordinary conversation at from 10 to 30 feet. Write for descriptive circular, price, etc. **Compound Micro-Audiphone Co. Westfield, Mass. U.S.A.**



Used similar to Opera Glasses



## ALUMINUM Chain Guard

For Ladies' bicycles. Light, strong, ornamental. No more torn or greasy dresses. No troublesome lacing. No accidents. Infinitely superior to old style guards. Weight only 7 oz. Fits any wheel. Sent prepaid anywhere in U. S. on receipt of \$1.50. Circulars free. **The Turner Brass Works, 163 Kinzie St., Chicago.**

## A QUIET, RESTFUL, IDEAL RESORT

for sportsmen, tourists, and their wives, with comfortable beds, nice table, good fishing and hunting in their season, is

### The Crow's Nest, Sandy Bay, Moosehead Lake

Rates reasonable, and only four miles from the railroad terminus. For particulars, write

**BIGNEY & ROWE, Proprietors, GREENVILLE, ME.**

# HYPNOTISM TAUGHT BY MAIL.



**Not Difficult. Spare Moments Sufficient.** Not a natural gift; anyone can use it. Latent powers developed and the otherwise impossible accomplished. Ours the most reliable secrets of the art, making all susceptible to this strange influence. Induced by contact, or at a distance by mail or telegraph. Controlled ones and save them from error. Habits, weaknesses and diseases cured. Nothing aids all classes of every age, sex and condition, in business and social life more than this knowledge. Everything private. Established twenty years. Most advanced and reliable methods. Valuable information upon request. Address, **Prof. L. H. ANDERSON, R. C. 67. Masonic Temple, Chicago, Ill. U.S.A.**

THE  BEST  
OF  ALL  
AMMUNITION

Try .22 Peters' Short Smokeless and New Victor Shells, Loaded with King's Smokeless

FOR ACCURACY, VELOCITY, STRENGTH, PENETRATION AND CLEANLINESS.

## Taxidermists' Supplies

WHEN you get a good specimen of bird, fish, mammal etc., that you would like to get mounted, send it to us. We will do it right and also make the price right. Send five cents for new Taxidermists' Catalogue.

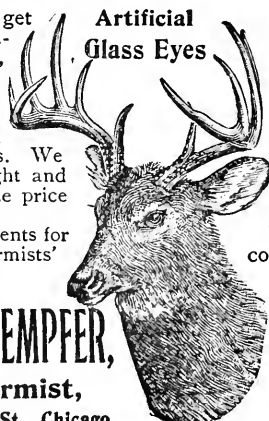

Artificial Glass Eyes

We prepare and mount all specimens of natural history true to nature, in the best style of the Taxidermist's art, at reasonable prices. We also keep a complete line of

Oologists' and Entomologists' Supplies

**FRED. KAEMPFER,**  
Taxidermist,  
217 Madison St., Chicago.



INSIST ON YOUR DEALER SUPPLYING YOU  
**THE PETERS CARTRIDGE CO.**  
CINCINNATI, O.

FOR SALE EVERYWHERE

SOME GOOD GUIDES.

Following is a list of names and addresses of guides who have been recommended to me, by men who have employed them; together with data as to the species of game and fish which these guides undertake to find for sportsmen.

If anyone who may employ one of these guides finds him incompetent or unsatisfactory, I will be grateful if he will report the fact to me.

ALASKA.

William York, Juneau, moose, bear, deer, sheep, goats and small game.

CALIFORNIA.

Chris. Ringsin, Avalon, Santa Catalina Island, goats, water-fowl, and salt water fishing.  
John Meier, Sweetwater Lake, Dotsero P. O., Eagle Co., ditto  
John Broder, Visalia, trout, deer, bear, grouse, and quails.  
S. L. N. Ellis, Visalia. ditto

COLORADO.

J. M. Campbell, Buford, elk, bear, deer, antelope, trout and grouse.  
Chas. Smith, Buford, ditto  
Frank Allen, Dotsero, Eagle Co., "  
Charles Allen, Dotsero, Eagle Co., "  
Wells and Patterson, Meeker, "  
R. W. McGee, Debeque, "  
Lem Crandall, Debeque, "  
Sam. T. Himes, New Castle, "  
Luke Wheeler, Pinkhampton, "  
Nathan Fisher, Gunnison, "  
W. H. Hubbard, Glenwood Springs, "  
W. L. Pattison, Buford, "  
J. E. Borah, Glenwood Springs, "  
Ed. L. Stockton, 527 11th St., Greeley, "

FLORIDA.

C. L. Farnham, Avon Park, bear, deer, turkeys, quails, ducks, black bass, etc.  
Oliver Tinny, Ozona, Hillsboro Co., deer, bear, turkeys, quails, ducks and salt-water fishing.  
E. M. Reynolds, Fort Myers, ditto  
Wm. Webb, Osprey, Manatee Co., "  
Frank Guptill, Osprey, Manatee Co., "  
W. J. Meyer, Tarpon Springs, "  
Robt. E. Hammond, Key West, "  
Frank Carson, Ft. Meyers, "  
E. T. Robinson, Keuka, "  
T. C. Cato, Inverness, "  
J. L. Sandlin, Punta Gorda, "  
Oliver Archer, Clearwater, "  
L. W. Scroggins, Homeland, "  
Capt. Jas. Argo, Oviedo, "  
F. J. Adams, Sanford, "  
C. B. Bailey, Winter Haven, "  
W. H. Steacy, Pt. Tampa City, "  
Wm. J. Lyon, Interlachen, "  
L. L. Sutton, Sutherland, "  
M. B. Carson, Frost Proof, Polk Co., "  
W. D. Isler, Eagle Lake, "  
George W. Hawthorn, Hawthorn, "  
C. H. Hill, Maitland, "  
J. E. Bowen, Laughman, "  
Margan Bass, Kissimmee, "  
B. C. Lanier, Leesburg, "  
John Hunter, Winter Park, "  
H. Shipman, Haskell, "  
Robert James, Emporia, "  
Alex. Brown, Martin, "  
W. J. McCullough, Boardman, "  
Frank Smith, St. James City, "  
Jinks McCreary, Higly, "  
Baldwin Cassady, Lisbon, "  
W. H. Howell, Centre Hill, "  
Ed. Brown, Dunedin, "  
G. B. Lawson, Lake Maitland, "  
J. H. Maddox, Wauchula, "  
Will Montgomery, Arcadia, "  
T. E. Fielder, Calvinia, "  
W. F. Hays, Webster, "

IDAHO.

W. L. Winegar, Egin, Fremont Co., elk, bear, deer, antelope, mountain sheep, trout and grouse.  
Geo. Winegar, St. Anthony, Fremont Co., ditto  
R. W. Rock, Lake, Fremont Co., "  
Ed. Stailey, Lake, Fremont Co., "  
J. S. Sadorus, Sarilda, Fremont Co., "  
Geo. W. Rea, Orange, Fremont Co., "  
Wm. Fraser, Beaver Canyon, "

IOWA.

Geo. Jenkins, Spirit Lake, ducks, prairie chickens, black bass, etc.  
Wilbur Clark, Spirit Springs, "

MAINE.

Wm. S. Emery, Blakesley Camps, Eustis, moose, caribou, deer, trout, grouse.  
Algie Spearin, Moro, ditto  
Charley Condon, Moro, "  
Wm. Atkins, Oxbow, "  
Miles D. Arbow, Oxbow, "  
Frank Cram, Oxbow, "  
Nathan B. Moore, Bingham, "  
Charley Powers, Medway, "  
Charley Hale, Medway, "  
Walter Dacey, Medway, "  
Elliott Rich, Bethel, "  
John C. Lamb, Kineo, "  
John H. Quilty, Kineo, "  
Winn McKenney, Patten, "  
Mitchell Francis, Patten, "  
Royal E. Paine, Stratton, "  
Charles Hathaway, Medway, "  
Victor Scott, Millinockett, "  
C. O. Norton, Dover, "  
Benjamin J. Woodaid, Dover, "  
Benjamin Woodard, Dover, "  
Col. N. D. Brown, Roach River House, "  
Alonzo Davenport, Shesuncook, "  
Ichabod Smith, Greenville, "  
Ernest Ham, Guilford, "  
Charlee Capen, Capens, "  
Ed. Masterman, Moosehead, "  
Marsh Carlton, Rangely, "  
Freeman Tibbetts, Rangely, "  
Fred Reed, Medway, "  
Dan Hale, Medway, "  
Will Meyer, Eustis, "  
Charles Haley, Eustis, "  
H. R. Horton, Eustis, "  
Abner McPhiters, Norcross, "  
Albert McPhiters, Norcross, "  
Horace B. Cushman, Norcross, "  
Irving Hunt, Norcross, "  
Wm. O. Shaw, Dobsy Lake, Washington Co., "  
Ran. Day, Princeton, Washington Co., "  
Geo. C. Jones, Carritunk, "  
Geo. Douglass, Eustis, "  
David Quint, Eustis, "  
Davis Moody, Stratton, "  
Gus Jones, Stratton, "  
Fred Viles, Stratton, "  
John Darling, Lowell, "  
Joe Francis, Old Town, "  
Sebat Shay, Old Town, "  
Louis Ketcham, Old Town, "  
Granville M. Grey, Old Town, "  
L. A. Orcutt, Ashland, "

MASSACHUSETTS.

Recommended by Dr. Hitchcock, Cliftondall, grouse, squirrels, salt water fishing.

MICHIGAN.

Bony Markelty, Negaunee, deer, bear, grouse, trout, black bass, and muskalonge.  
Thos. Starr, Alpena, "

MINNESOTA.

C. L. Porter, Glenwood, ducks, geese, prairie chickens, and black bass.  
E. L. Brown, Warren, ditto  
Jack Baldwin, Jackson, "

## SOME GOOD GUIDES (Continued.)

## MONTANA.

M. P. Dunham, Woodworth, elk, bear, deer, antelope, mountain sheep, trout and grouse.  
 G. H. Heywood, Red Lodge, ditto  
 Mr. William Jackson, Browning, Montana, ..  
 W. A. Hague, Fridley, ..  
 E. E. Van Dyke, Red Lodge, ..  
 James Sheehan, Butte, ..  
 Vic. Smith, Anaconda, ..  
 James Blair, Magdalen, ..  
 George Whitaker, Gardiner, ..

## NEW HAMPSHIRE.

Philip Marden, Wolfboro Falls, black bass, grouse and quails.  
 Frank Britton, Wolfboro Falls, ditto  
 Blake Abbott, Wolfboro Falls, ..  
 Ned Norton, Colebrook, moose, caribou and deer.  
 John Bresette, Diamond Pond, ditto  
 Henry Bresette, Diamond Pond, ..

## NEW JERSEY.

Billy Throckmorton, Mannahawkin, ducks, geese, brant, shore birds, grouse, salt-water fishing.  
 Dory Hulse, Mannokoking, Ocean Co., ditto  
 Ernest Worth, Bayville, Ocean Co., ..  
 James Emmans, Jr., Swartwood Lake, Swartwood, black bass, pickerel, quails and rabbits.  
 Mr. Riker, Culver's Lake, Branchville, perch, black bass and pickerel.

## NEW YORK.

Cal. Blanchard, Upper Jay, deer, grouse, rabbits, squirrels and trout.  
 Abe Rundle, Eldred, Sullivan Co., ditto  
 A. W. Rundle, Eldred, ..  
 Eugene Scrafford, Eighth Lake, Old Forge, ..  
 Elias Hall, Paul Smith's, ..  
 John McLaughlin, Paul Smith's, ..  
 Fred Martin, Paul Smith's, ..  
 Ceylon Clarke, Piseco, Hamilton Co., ..  
 Joe White, Horseshoe Pond, Tupper Lake, Franklin Co., ..  
 Edson Brown, Spring Cove, Franklin Co., ..  
 William Boyea, Owl's Head, Franklin Co., ..  
 Will Simonds, Franklin Fall, Franklin Co., ..  
 Harry Freeman, Axton, Franklin Co., ..  
 Fred Reeves, Axton, Franklin Co., ..  
 Gean Clark, Axton, Franklin Co., ..  
 Geo. P. Finnegan, Smithville Flats, Chenango Co., ..  
 L. C. Pendell, Athol, ..  
 Geo. Goodsell, Old Forge, ..  
 Philip Christy, Old Forge, ..  
 Chris. Goodsell, Old Forge, care Rocky Point Inn, ..  
 Joe Ward, C. & A. branch, R. N. & O., Oswegatchie, ..  
 Martin Humes, Harrisville, ..  
 Myron Humes, Harrisville, ..  
 Raymond Norton, Glendale, Lewis Co., ..  
 Andrew Watson, Glendale, Lewis Co., ..  
 Frank Perkins, Greg, Lewis Co., ..  
 Henry N. Mullen, Harrisville, Lewis Co., ..  
 Chris. Wagner, Beaver River, ..  
 Peter Back, Beaver River, ..  
 Nelson Foster, Saranac Lake, ..  
 Rant Reynolds, Saranac Lake, ..  
 Chas. McKaffery, Saranac Inn, ..  
 Wess Wood, Saranac Inn, ..  
 Justin Farrington, Saranac Inn, ..  
 C. I. Stanton, Blue Mountain Lake, ..  
 C. L. Stanton, Blue Mountain Lake, ..  
 George W. Fuller, Blue Mountain Lake, ..  
 G. W. Fuller, Blue Mountain Lake, ..  
 Lawrence Sweeney, Lake Clear, ..  
 Ed. Ovis, Lake Clear, ..  
 Geo. Otis, Lake Clear, ..  
 Leonard Bunting, Greenfield, Ulster Co., grouse, woodcock and trout.  
 Thomas Flake, Cape Vincent, pickerel, muskalonge, black bass.  
 Antoine Seymour, Cape Vincent, ditto  
 Wilfred Dodge, Cape Vincent, ..  
 Ren Dodge, Cape Vincent, ..  
 Warren Aldrich, Greenwood Lake, black bass, trout, grouse, squirrels, rabbits, etc.  
 Charles Lane, Good Ground, L. I., ditto  
 Peter Post, Seaford, L. I., ..  
 Harry Rogers, Eastport, L. I., ..  
 Geo. Rolston, Lake Ronkon, Koma, L. I., ..  
 Geo. M. Still, Lake Ronkon, Koma, L. I., ..

Willet Ellison, Freeport, L. I., black bass, trout, grouse, squirrels, rabbits, etc.  
 W. C. Raynor, Freeport, L. I., ditto  
 W. N. Ackerley, Patchogue, L. I., ducks, baybirds, salt-water fishing.  
 Hugh Smith, Moriches, L. I., quails, woodcock and grouse.  
 Dan Havens, Centre Moriches, L. I., ditto  
 Hugh Smith, East Moriches, L. I., ..

## NORTH CAROLINA.

Fenner S. Jarvis, Haslin P. O., deer, bear, turkeys and quails.  
 Robert Waterfield, Knotts Island, ditto  
 Jas. Tooly, Belleport, ..  
 W. C. Halsted, Currituck C. H., deer, turkeys, quails, ducks, salt-water fishing.  
 Fred. Latham, Haslin, ditto

## OREGON.

Wm. Ascher, West Fork, Douglass Co., deer, bear, elk, trout, grouse, ducks and geese.  
 E. L. Howe, Creswell, Lane Co., ditto

## PENNSYLVANIA.

Leonard Champion, Prop'r Lehigh Valley Hotel, Mahogany, Wyoming Co., bass, pickerel, salmon.

## VERMONT.

E. Ward, Fair Haven, woodcock, grouse, black bass and trout.

## VIRGINIA.

M. Corbel, Virginia Beach, geese, brant, ducks, shore birds, quails, salt-water fishing.  
 Captain R. E. Miles, Machipongo, ditto  
 C. A. Spencer, Buckingham, ..  
 James Daniel, Buckingham, ..  
 Fred Spencer, Buckingham, ..  
 M. A. Barner, Clarksville, ..

## WASHINGTON.

John S. Wood, Morton, Lewis Co., deer, grouse, trout, etc.

## WISCONSIN.

T. R. Page, Bruce, deer, grouse, trout, black bass and muskalonge.  
 Charles Johnson, care Williams, Salsich & Co., Star Lake, Vilas Co., ditto  
 L. L. Thomas, State Line, ..  
 John Thomas, State Line, ..  
 Chas. French, Three Lakes, ..  
 M. E. Monsell, Star Lake, Vilas Co., ..  
 H. E. Soule, South Range, ..  
 Judd Blaisdell, Camp Franklin, Woodruff, ..  
 Alexander Gillies, Camp Franklin, Woodruff, ..  
 C. J. Coon, Camp Franklin, Woodruff, ..

## WYOMING.

Mark H. Warner, Ten Sleep, elk, bear, deer, mountain sheep, antelope, grouse and trout.  
 Milo Burke, Ten Sleep, ditto  
 James Fullerton, Ten Sleep, ..  
 Nelson Yarnall, Dubois, ..  
 Geo. Y. Hayes, Dubois, ..  
 S. A. Lawson, Laramie, ..  
 R. C. Tregoning, Laramie, ..  
 A. Pache, Laramie, ..  
 N. E. Brown, Marquette, ..  
 H. D. DeKalb, Big Piney, ..  
 Ira Dodge, Cora, ..  
 S. N. Leek, Jackson, ..  
 W. P. Redmond, Jackson, ..  
 Frank L. Peterson, Jackson, ..  
 O. F. Bike, Jackson, ..  
 F. E. White, Jackson, ..  
 W. A. Hague, Pleasant Valley Hotel, via Mammoth Hot Springs, ..

## CANADA.

Christopher Bowers, Shelburne, Nova Scotia, moose, bear, grouse, black bass and trout.  
 E. Thompson, Hammond Plain, Nova Scotia, ditto  
 John Bowers, Shelburne, Nova Scotia, ..  
 Billy McCoy, ..  
 Frank Komondo, Desert or Maniwaki, P. Q., ..  
 Philamon Gashon, Three Lakes, P. Q., ..  
 Robert Elliott, Kennebec Road, Armstrong, ..  
 County Beauce, P. Q., ..  
 Geo. Gillard, Little Bay, Notre Dame Bay, Newfoundland, caribou, bear, ptarmigan, ducks and geese.

The Most Elegant Folding Camera in the Market • •

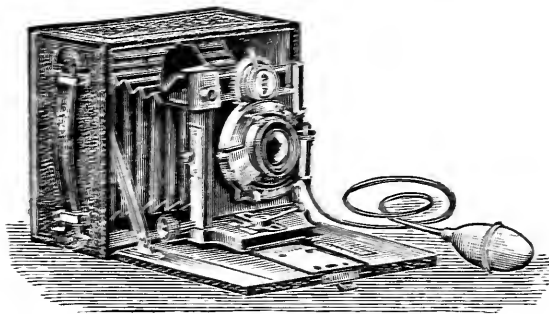

QUALITY  
... Can't be Beaten for ——— OR ———  
PRICE ❧ ❧

Send for Circular

GUNDLACH OPTICAL CO.

761, 763, 765 South Clinton St.

∴

ROCHESTER, N. Y.

**A Practical Common Sense Camp Stove.**

In 6 Sizes. Patent applied for.

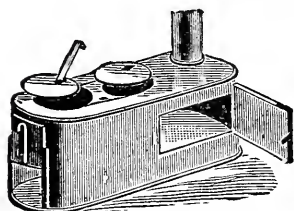

The lightest, most compact, practical camp stove made; either with or without oven. Won't get out of shape, combination cast and sheet steel top, smooth body, heavy lining, telescopic pipe carried inside the stove.

Burns largest wood, keeps fire longest of any stove made. For full particulars address

D. W. CREE, Manufacturer, Griggsville, Ill.

**A RARE OPPORTUNITY**

**A Willsie Pocket Camera, Valued at \$5.00**

As a premium for 5 yearly subscriptions to RECREATION. This Camera makes a picture 2½x2¾ inches, and can be loaded with 24 cut films. You can get the 5 subscriptions in one hour.

Write This Office for Camera Catalogue.

**Gall & Sembke**  
OPTICIANS.

21 Union Square, N. Y.

The Telescopes furnished by you to the Signal Corps, National Guard, State of New York, I find remarkable for definition and clearness of objects at long distances. Yours, etc.,

HOMER W. HEDGE,

1st Lieut. and Ass't Signal Officer.



**TYPEWRITERS ALL MAKES**

All the Standard Machines for SALE or RENT at HALF manufacturers' prices. Full guarantee. Express charges prepaid if this medium mentioned. Privilege of Examination. Write for catalogue. 202 LaSalle St. CHICAGO.

Typewriter Emporium,

**G. CRAMER**

**DRY PLATE WORKS**

ST. LOUIS, MO.

Full descriptive catalogue mailed to any address on application

**Dixon's Graphitoleo**

Lubricates not only the chain and sprockets, but also the pins in the links of the chain, which stick Graphite cannot do and is not intended to do. For gun locks, for copying presses, and for office chairs it is unequaled. If your dealer does not keep it, mention RECREATION, and send 15 cents for sample.

JOS. DIXON CRUCIBLE CO., Jersey City, N. J.

WANTED.—LIVE ELK, MOOSE, CARIBOU, BLACK-tail deer, wild turkey, European roebucks, fallow deer, etc., for Litchfield Park, Adirondacks. Address, with particulars, EDWARD H. LITCHFIELD, 59 Wall Street, New York.

**EARLY TROUTING.**

In April, last, Mr. P— and I went on a fishing trip to Spragueville, Munroe Co., Pa. We stayed at Stites Mountain house, which is the only hotel within 7 miles of the place.

There are 2 beautiful streams, one running at the front and the other at the back of the hotel.

I jointed my rod and was soon on the banks of an deep pool which is within 200 feet of the hotel. After a few casts and many changes of flies I gave up and was soon back in the comfortable steam heated sitting room.

For the first 2 days the weather was very cold, the thermometer touching 30 degrees, and the water froze to our leaders.

After waiting a day for the water to warm a little, we drove up the back stream 3 miles and then fished down. The water was too high to fish comfortably, and not knowing the stream and pools we caught only a few trout.

During our stay Mr. P— caught many large fish, some weighing 1 pound each.

I am highly pleased with RECREATION and think it the best sportsmen's magazine published. J. L. P., New York City.

The Premo A. came to hand on the 21st. I have not had time to try it yet, but the reputation of the Rochester Optical Company is a guarantee that it will be O. K. Many thanks for your prompt and courteous treatment in this matter. I have a great deal of pleasure in securing this club, and consider myself doubly paid.

C. E. Tucker, Hannibal, Mo.

I have been so busy I neglected to announce the arrival of the Premo camera. I have tried it, and to say I am pleased would be a tame way of expressing my feelings. I can only say, as hundreds of others say, "How can you do it?" RECREATION alone is worth more than you ask for it. It is clean, bright, and interesting, inside and out.

Z. R. Jacoby, Amsterdam, N. Y.



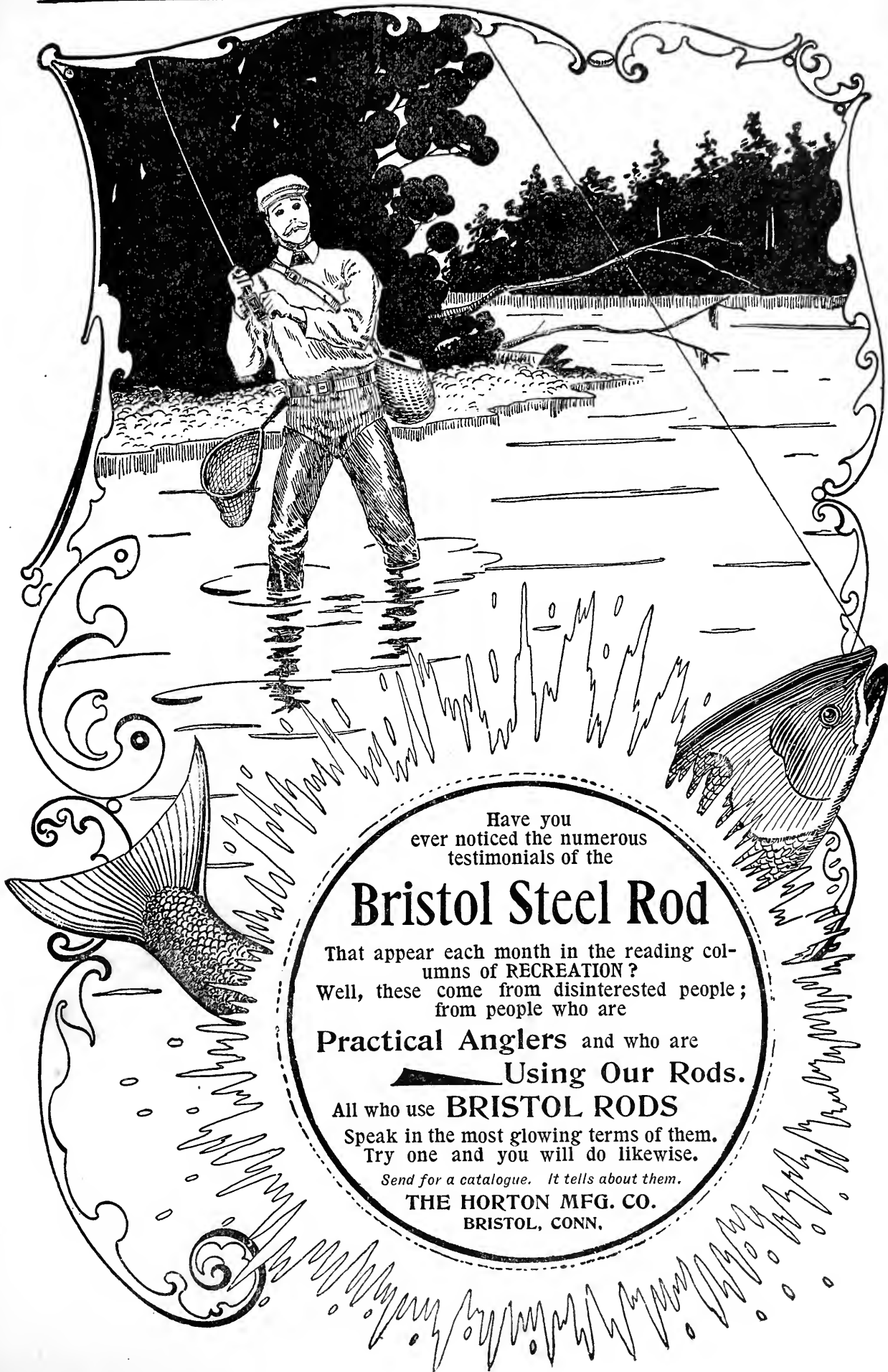

Have you  
ever noticed the numerous  
testimonials of the

## Bristol Steel Rod

That appear each month in the reading columns of RECREATION?  
Well, these come from disinterested people;  
from people who are

**Practical Anglers** and who are  
Using Our Rods.

All who use **BRISTOL RODS**  
Speak in the most glowing terms of them.  
Try one and you will do likewise.

*Send for a catalogue. It tells about them.*

**THE HORTON MFG. CO.**  
**BRISTOL, CONN.**

# New Ithaca Guns

Self compensating,  
taking up wear  
at every point

Bored  
FOR BLACK AND  
NITRO POWDERS

Close and Hard Shooting Guns  
at long range a specialty

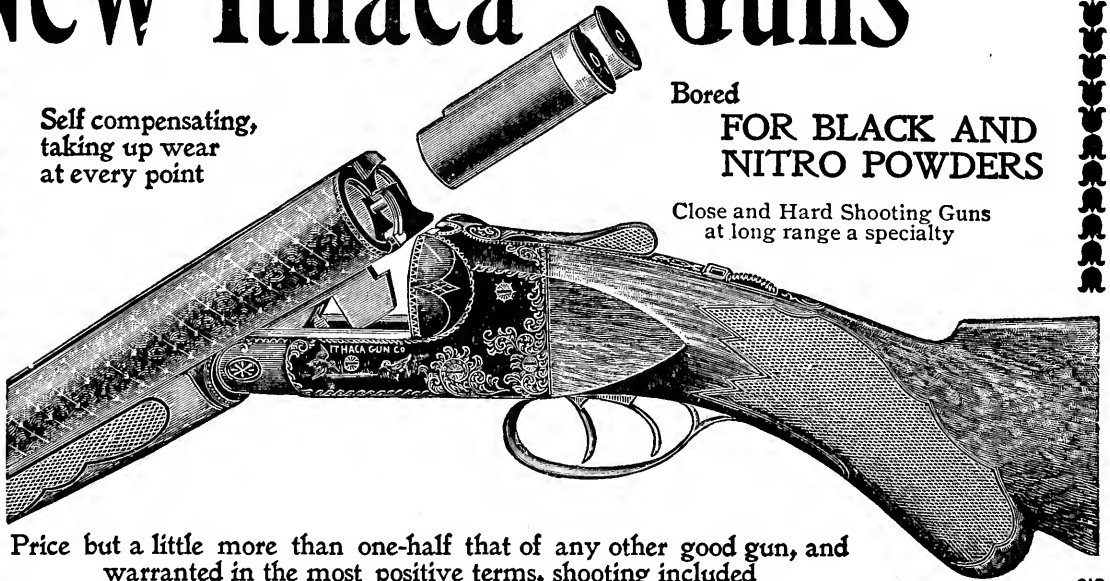

Price but a little more than one-half that of any other good gun, and warranted in the most positive terms, shooting included

## ITHACA GUN COMPANY, ITHACA, N. Y.

Send for circular  
Mention RECREATION

Manufacturers of fine Hammer  
and Hammerless Guns

### GOATS AND BEARS.

The 1st of September last, Capt. W. S. Turner, with Vic Smith as guide, and me as chief of the culinary department, started on a trip for big game. We made our home camp about 35 miles from the railroad. The 3d day a herd of elk was seen. Vic acted as reserve, in case the Captain should miss; but it was unnecessary, for 2 bulls were killed without Vic's help.

There were a number of moose near camp; their tracks being seen every morning, in the park where the horses grazed. I kept the camp supplied with grouse and fish, while the Captain provided big game.

After 2 successful weeks, we moved about 20 miles, to the Goat hills. Camp was pitched at a beautiful mountain lake. The Captain spread his blankets and lay down to rest, while Vic and I sprang the tents and cut fir boughs for our bed. The Captain scanned the hills with a field-glass a few seconds, then exclaimed: "See the goats!" Sure enough, there were 21 white goats in sight, not a mile away. It was a beautiful sight. After supper, we lounged around, watching the animals. They paid no attention to us.

The next morning, the big-game hunters started for the goats, which were feeding along the base of the mountain. They got within 40 yards of the game, then the Captain turned loose his Winchester 44, and 4 handsome billies surrendered uncon-

ditionally. Vic called a halt on the shooting, reminding him that the law allowed him to kill but 8 goats; and that he had better reserve his shots a few days. We camped there 2 weeks, seeing goats from camp every day.

The Captain easily killed all the law allowed, and could have killed 50 more. Their hides were good, the hair being nearly 6 inches long.

Vic went down to the river after mail, one day, and on his return killed a buck antelope. He discovered signs of a silver-tip, around the remains of a goat carcass, about 2 miles from camp. So next day the hunters laid for the bear, which put in an appearance about 4 in the afternoon. The Captain knocked her over, though it took 6 bullets to do it. There was no prouder man in the mountains that day than our military friend. Vic calmly looked on during the shooting.

We had a 50 pound balance scale in camp, and with this I accompanied the others, next morning, to assist in cutting the bear into chunks small enough to weigh. Her weight was exactly 651 pounds. The fat on her back was 4 inches thick.

Two days later we broke camp, having been out a month. Captain Turner, who has been on many hunting trips, pronounced this the most successful one he ever had. He says Vic Smith is the Prince of guides.

Ben Osborne, Big Hole Basin, Mont.

For nearly 50 Years the name

**"Davenport"**



has been identified with the manufacture of

**Guns...**  
and **Rifles**  
\*\*\*\*\*

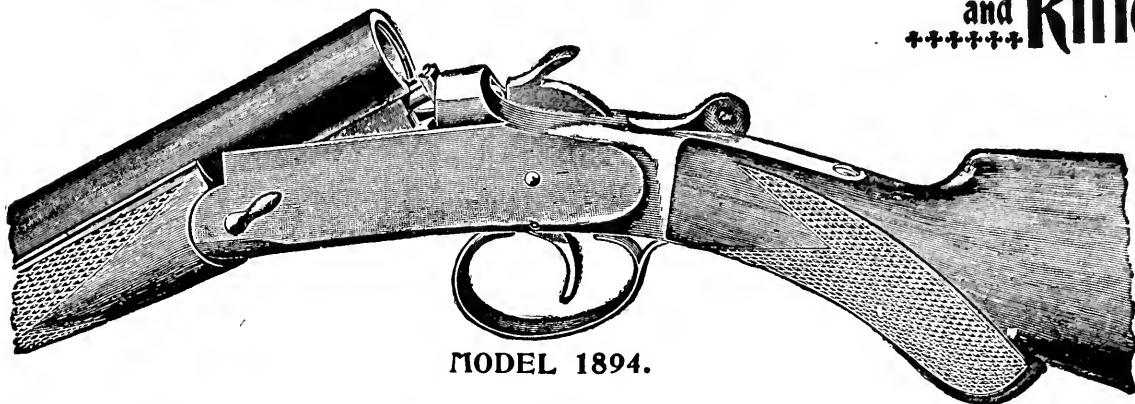

MODEL 1894.

**AUTOMATIC EJECTOR**

Our present line is complete and varied and shows the result of years of experience.

For catalogues and information address

**THE W. H. DAVENPORT FIRE ARMS CO.**

**NORWICH, CONN., U. S. A.**

Mention "RECREATION"

*Ejector Guns  
no longer a  
luxury*

**Good News for Sportsmen**

Lefever Automatic Ejector Guns at a price within the reach of every sportsman.

OUR NEW EJECTOR MOVEMENT

*Has only two pieces: One in the Hammer, One in the Frame.*

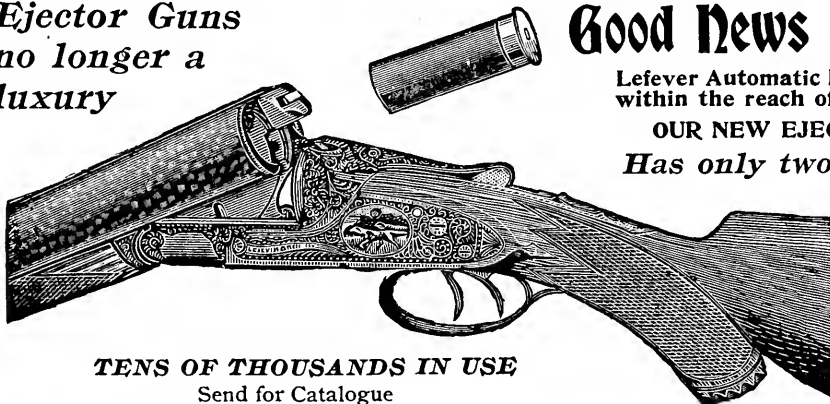

We have decided to meet the demand for *medium* price Ejectors, and are now prepared to accept orders for all grades of our hammerless guns fitted with Ejectors.

**TENS OF THOUSANDS IN USE**  
Send for Catalogue

**LEFEVER ARMS CO. - - Syracuse, N. Y.**

(Mention RECREATION.)

Date,.....1897.

G. O. SHIELDS,

Editor and Manager of RECREATION, 19 West 24th St., New York:  
Herewith find One Dollar, for which please send me RECREATION  
for one year beginning with..... number.

Name,.....

Remit by P. O. or Express Money Order, or New York Draft.

DETACH THIS; FILL OUT, AND SEND IN.

# A FINE PERFORMANCE GRAND AMERICAN HANDICAP, 1897

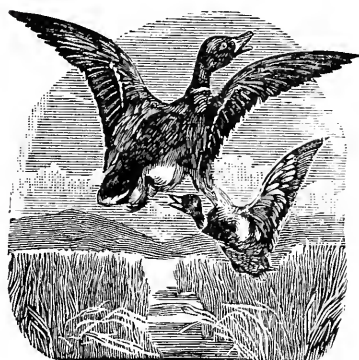

- 1st—Hon. T. A. MARSHALL,  
Keithsburg, Ill., 25 kills straight.
- 2d—Dr. W. F. CARVER, Chicago,  
24 straight, and 25th killed but  
carried out of bounds by wind.
- 2d—Dr. J. L. WILLIAMSON, 24  
ex. 25.

All  
Using  
Cashmore  
Guns

FIRST AND TWO SECONDS OUT OF 136 COMPETITORS

TRAP GUN BUILDING A SPECIALTY

NEW LIST FREE

Address, WM. CASHMORE, Gunmaker  
BIRMINGHAM, ENG.

Telegram, "Extractor, Birmingham"



FOR FIELD OR FOR TRAP,  
FOR POT HUNTING OR FUN,  
NO SPORTSMAN IS EQUIPPED  
WITHOUT A SYRACUSE GUN

"MORE TRUTH  
THAN POETRY"

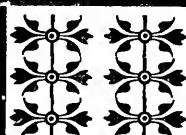

We do not say that SYRACUSE HAMMERLESS GUNS

"Are as Good" as any gun in the market.

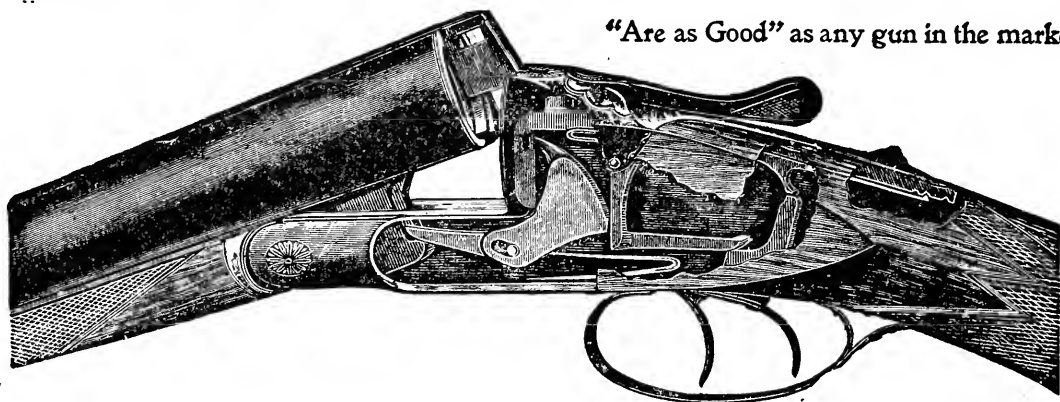

Their simplicity of construction and superiority of finish stamp them "BETTER" for practical all-round work than any gun in the market. The "old, old story" but, nevertheless, substantiated by every man who ever drew a Syracuse to his shoulder.



SYRACUSE ARMS CO., SYRACUSE, N. Y., U. S. A.



# Forehand Arms Co.'s

EJECTOR AND NON-EJECTOR  
HAMMERLESS DOUBLE GUN

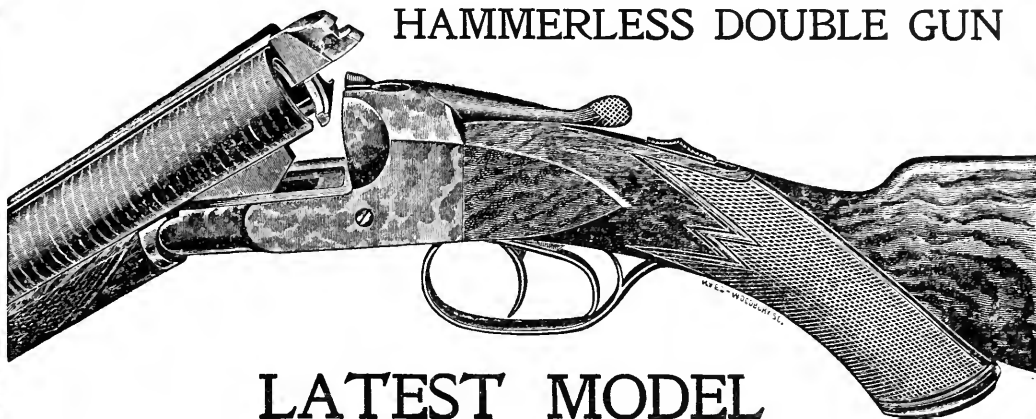

## LATEST MODEL

WARREN, ILL.

The Forehand Hammerless Gun you sent me, for 35 subscriptions, has arrived. I am delighted with it, and shall recommend it highly. It is a good, close-shooting gun, simple in action, and of fine workmanship. I made two long shots with it yesterday at grouse in heavy brush, killing both birds at distances of forty to forty-five yards. I would not wish for a better gun than the Forehand for trap shooting.

DR. A. C. CZIBULKA.

**READ WHAT MEN  
SAY OF THE  
FOREHAND, WHO  
ARE USING IT.**

MOLINE, ILL.

I have received from the Forehand Arms Co., of Worcester, Mass., the double-barreled, hammerless, breech-loading shot-gun as a premium for 35 subscriptions, and it is a beauty. It is light, strong, handsome, and shoots as well as any gun I know of. Got four squirrels and a rabbit yesterday—all the game I saw—and one shot at each was enough. I compared my gun with an \$85.00 gun today, of another make, and mine gained in value greatly, in my estimation.

W. B. KENT.

**WE GET THOUSANDS  
OF SUCH  
TESTIMONIALS—  
ALL UNSOLICITED**

**"WHAT EVERYONE SAYS MUST BE SO"**

*We challenge competition in Beauty, Workmanship, Simplicity of Mechanism, Shooting Qualities and Price. We target all our guns with nitro powder. For Catalogue, address*

**FOREHAND ARMS CO., WORCESTER, MASS.**

# DOG HAMPERS

FOR SHIPPING DOGS OR CATS BY RAIL

5 SIZES, \$6.00 TO \$15.00

(RATTAN OR WICKER)

Order through your Dealer and send for catalogue to

**SPRATTS PATENT LIMITED**

245 EAST 56TH STREET, NEW YORK CITY

**DOG AND POULTRY  
SUPPLIES**

**THE OLD  
RELIABLE**

# Parker Gun

**HAS  
NO EQUAL**

*Has stood the test  
of over 30 years*

*"Built on Honor"*

*Simplicity and dura-  
bility combined with  
handsome finish and  
perfect shooting  
qualities*



*Experience and ability have placed "The Parker" in an enviable and well deserved position as the best gun in the world. Made by the oldest shot gun manufacturers in America. Nearly 100,000 in use.*

SEND FOR CATALOGUE

New York Salesrooms  
96 Chambers Street

**PARKER BROS., Meriden, Conn.**

# Decorations for Sportsmen's Dens

## Tapestry Paintings

2000

Tapestry Paintings to choose from. 38 artists employed, including gold medalists of the Paris Salon.



## Wall Papers Given Away

Fine Satin, French or Leather Papers, 10 cents per roll; former price, \$1.50. Have drapery to match. State color and for what rooms. **Will send sample book if you will pay expressage.**

## SPECIAL DRAPERIES

to match. Venetian, Roman, Dresden, Marie Antoinette, Delft, Russian, Grecian and Oriental.

## TAPESTRY MATERIALS

We manufacture tapestry materials. Superior to foreign goods, and half the price. Book of samples, 10 cents. **Send \$1.50 for trial order, for 2 yards of 50-inch, No. 6 goods worth \$3.00.**

## DECORATIONS

Write for color schemes, designs, estimates. Artists sent to all parts of the world to do every sort of decorating and painting. We are educating the country to color-harmony. Relief; stained glass; wall paper; carpets; furniture; draperies, etc. Pupils taught. **Send \$25.00 for a color scheme to decorate your home.**

## SCHOOLS

Six 2-hour tapestry painting, china or miniature lessons, in studio, \$5.00. Complete written instructions by mail, \$1.00. Tapestry paintings rented; full size drawings, paints, brushes, etc., supplied. Nowhere—Paris not excepted—are such advantages offered pupils. New catalogue of 125 studies, 25 cents. **Send \$1.00 for complete instructions in tapestry painting and compendium of 140 studies.**

## THE GODDESS OF ATVATABAR

A trip to the Interior World. "Jules Verne in his happiest days outdone." 318 octavo pages, 44 illustrations, price \$2.00, postage prepaid. Paper covers, 50 cents.

## MANUAL OF ART DECORATIONS

The art book of the century. 200 royal quarto pages. 50 superb full-page illustrations (11 colored) of modern home interiors. **Send \$2.00 for this \$50.00 art book.**

# JOHN F. DOUTHITT

American Tapestry and  
Decorative Company

286 Fifth Avenue, New York  
Near 30th Street

*Spend the Summer at . . . .*

# *DEER PARK*

*On the Crest of the Alleghanies  
3,000 Feet Above Tide-Water*

*Season Opens June 21, 1897*

**T***HIS famous mountain hotel, situated at the summit of the Alleghanies, and directly upon the main line of the Baltimore & Ohio Railroad, has the advantage of its splendid vestibuled express train service, both east and west, and is therefore readily accessible from all parts of the country. All Baltimore & Ohio trains stop at Deer Park, during the season. There are also a number of furnished cottages with facilities for housekeeping.*

*The houses and grounds are supplied with absolutely pure water, piped from the celebrated "Boiling Spring," and are lighted by electricity. Turkish and Russian baths and large swimming pools are provided for ladies and gentlemen, and suitable grounds for lawn tennis. There are bowling alleys and billiard rooms; fine riding and driving horses, carriages, mountain wagons, tally-ho coaches, etc., are kept for hire; in short, all the necessary adjuncts for the comfort, health, or pleasure of patrons.*

*For terms apply to . . . .*

**D. C. JONES**

*B. & O. Central Building*

*BALTIMORE, MD.*





## What's the Use

of walking when you can get a first-class, high-grade bicycle for nothing?

## How?

By getting 75 subscriptions for  
**Recreation**

If you live in a town of 3,000 or more, and if you are a hustler you can get these in 2 days.

I can give you the names of 20 people who did this in 1896, and who now have their wheels.

Write for particulars.

## RECREATION

19 West 24th Street  
New York



## Sargent's

# R

EADY  
REFERENCE  
ROTARY

## Book Cases



SARGENT

A brain worker's best tool.

A Labor Economizer.  
A Time Saver.

All kinds for all needs.  
New and perfect anti-friction Rotary principle.

Write for Catalogue D, free; postage 2c.

Our new Catalogue C, 48 pages of **Reclining, Easy Library and Study Chairs and Couches**, is just out, and is the most complete ever issued.

We can suit anybody.

If interested, write for it, postage 3c.

Mention Recreation.

**Geo. F. Sargent Co.**

289 Fourth Ave.,  
(Next 23d St. Moved  
May 1 from 814 B'way)

NEW YORK.

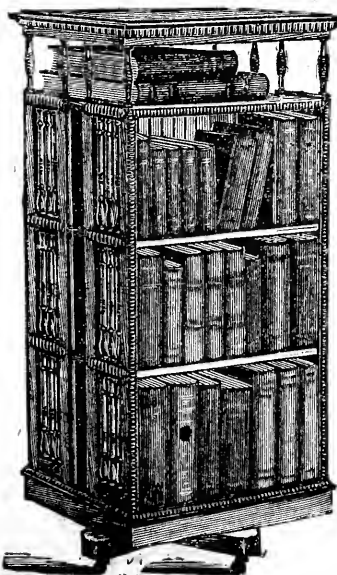

## BOOKS BY G. O. SHIELDS (COQUINA)

### THE BIG GAME OF NORTH AMERICA

Its Habits, Habitat, Haunts and Characteristics. How, When and Where to Hunt it. 8vo, 600 pages, 80 illustrations. Cloth, \$3.50; Half Morocco, \$5.00; Full Morocco, \$6.50.

### CRUISING IN THE CASCADES

A Narrative of Travel, Exploration, Amateur Photography, Hunting and Fishing, with Special Chapters on Hunting the Grizzly Bear, the Buffalo, Elk, Antelope, Rocky Mountain Goat, and Deer; also on Trout in the Rocky Mountains; on a Montana Roundup; Life Among the Cowboys, etc. 12mo, 300 pages, 75 illustrations. Cloth, \$2; Half Morocco, \$3.

### AMERICAN GAME FISHES

How, When and Where to Angle for them. 8vo, 400 pages, 50 illustrations. Cloth, \$2.50; Half Morocco, \$4.

### HUNTING IN THE GREAT WEST

(Rustlings in the Rockies)

Hunting and Fishing Sketches by Mountain and Stream. 12mo, cloth. Over 300 pages. Illustrated. Price, 75 cents.

### THE AMERICAN BOOK OF THE DOG

The Origin, Development, Special Characteristics, Utility, Breeding, Training, Diseases and Kennel Management of all Breeds of Dogs. 8vo, 650 pages, 100 illustrations. Cloth, \$3.50; Half Morocco, \$5; Full Morocco, \$6.50.

### CAMPING AND CAMP OUTFITS

A Manual of Instruction for Young and Old Sportsmen. 12mo, 200 pages, 30 illustrations. Cloth, \$1.25.

### THE BATTLE OF THE BIG HOLE

History of General Gibbon's Engagement with the Nez Perce Indians in the Big Hole Basin, Montana, August 9, 1877. 12mo, 150 pages. Profusely illustrated. Cloth, \$1.

These books will be mailed, post-paid, on receipt of price, by the author.

**G. O. SHIELDS**

19 West 24th St., New York

# Some Rare Oppor- tunities

These goods are all new, and will be shipped direct from factory. Prices named are those at which manufacturers and dealers usually sell. Here is a good chance to get

**A BOOK  
A GUN  
A CAMERA  
A TYPEWRITER  
A BICYCLE**

**FREE OF COST**

Subscriptions need not all be sent at once. They can be sent in installments as taken and credit will be given on account. When the required number is obtained the premium earned will be shipped.

**“Recreation”**

19 West 24th Street  
New York

## To any person sending me

- ✦ TWO yearly subscriptions to RECREATION at \$1 each, I will send a copy of *Hunting in the Great West*, paper.
- ✦ THREE subscriptions at \$1 each, a copy of *The Battle of the Big Hole*, cloth.
- ✦ FOUR subscriptions at \$1 each, a copy of *Camping and Camping Outfits*, cloth.
- ✦ FIVE subscriptions at \$1 each, a copy of *Cruising in the Cascades*, cloth; or a Will-sie Pocket Camera, valued at \$5. It makes a picture 2½x2½ inches and can be loaded with 24 cut films.
- ✦ SIX subscriptions at \$1 each, a copy of *American Game Fishes*, cloth.
- ✦ SEVEN subscriptions at \$1 each, a copy of *The Big Game of North America*, or of *The American Book of the Dog*, cloth.
- ✦ EIGHT subscriptions at \$1 each, a Pocket Kodak, made by the Eastman Kodak Co., and valued at \$5.
- ✦ TEN subscriptions at \$1 each, a single-shot Davenport Rifle; or a Bristol Steel Fishing rod, or a Yawman and Erbe Automatic Reel, worth \$9; or a Kenwood Sleeping Bag, worth \$10; or a No. 10 Gramophone, worth \$10.
- ✦ TWELVE subscriptions at \$1 each, a Manhattan Improved Hand Camera, made by the Manhattan Optical Co., and valued at \$12.
- ✦ FIFTEEN subscriptions at \$1 each, a Davenport Single-barrel, breech-loading Shotgun, worth \$15; or a Premo D Camera, worth \$6 to \$10; or a Kenwood Sleeping Bag, complete with canvas cover, worth \$16; or a No. 2 Bullet Camera, loaded, worth \$10.
- ✦ TWENTY subscriptions at \$1 each, a 14-karat Gold Hunting-case Watch, with Elgin Movement, worth \$20; or a Marlin Repeating Rifle, listed at \$20; or an Improved Night-hawk Hand Camera, made by the Manhattan Optical Co., and valued at \$25; or a No. 4 Bullseye Camera, made by the Eastman Kodak Co., and worth \$12; or a Premo B Camera, worth \$16.
- ✦ TWENTY-FIVE subscriptions at \$1 each, a Premo A Camera, worth \$25, or a No. 4 Bullet Camera, made by the Eastman Kodak Co., and worth \$18.
- ✦ THIRTY-FIVE subscriptions at \$1 each, a Forehand or a Syracuse Double-barrel Hammerless Breech-loading Shotgun, worth \$35.
- ✦ FORTY subscriptions at \$1 each, a Premo Sr. Camera, worth \$30.
- ✦ FIFTY subscriptions at \$1 each, a Marlin Rifle, with fancy curled walnut stock, pistol grip, checkered four-end, handsomely engraved, half octagon, half magazine, with take down, listed at \$50.
- ✦ SEVENTY-FIVE subscriptions at \$1 each, a Safety Bicycle, worth \$85 to \$100; or a Bo-peep Camera, for 5x7 plates, made by the Manhattan Optical Co., and valued at \$90.
- ✦ EIGHTY subscriptions at \$1 each, a Premo Sr. Camera, worth \$65.
- ✦ ONE HUNDRED subscriptions at \$1 each, a fine Lefever Hammerless Gun, worth \$85; or a Bo-peep Camera, for 6½x8½ plates, made by the Manhattan Optical Co., and valued at \$120.

# "THE LITTLE FINGER DOES IT"

## The Fisherman's Automatic Reel



# THE AUTOMATIC



# REEL

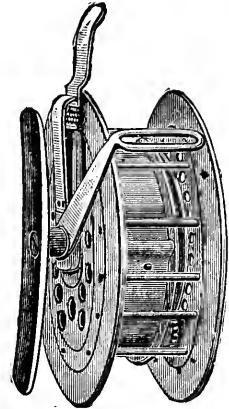

Manufactured by  
**YAWMAN & ERBE**  
344 No. ST. PAUL Street,  
ROCHESTER, N. Y. U. S. A.



SEND FOR CATALOGUE

### What we claim for the Automatic Reel

**First**—It will wind up the line a hundred times as fast as any other reel in the world.

**Second**—It will wind up the line slowly if the angler chooses.

**Third**—No fish can ever get slack line with it.

**Fourth**—It will save more fish than any other reel.

**Fifth**—It will prevent tips, lines, and snells from being broken by large fish.

**Sixth**—The reel is manipulated entirely by the hand that holds the rod.

**Seventh**—It enables the angler and makes it desirable to use lighter tips.

# The Big Game

## OF North America

ITS HABITS, HABITAT, HAUNTS, AND CHARACTERISTICS  
HOW, WHEN, AND WHERE TO HUNT IT

A Book for the Sportsman and the Naturalist

EDITED BY

G. O. SHIELDS ("COQUINA")

AUTHOR OF "CRUISING IN THE CASCADES," "RUSTLINGS IN THE ROCKIES," "HUNTING IN THE GREAT WEST," "THE BATTLE OF THE BIG HOLE," "CAMPING AND CAMP OUTFITS," ETC.

8vo, 600 Pages, 80 Illustrations.

Cloth, \$3.50; Half Calf, \$5.00; Full Morocco, \$6.50.

### CONTENTS

- |                                                                                                                                                                                                                                                                                                                                                                                                                                                                                                                                                                                                                                                                                                                                                                                                                                                                                                                                                                                                                                 |                                                                                                                                                                                                                                                                                                                                                                                                                                                                                                                                                                                                                                                                                                                                                                                                                                                                   |
|---------------------------------------------------------------------------------------------------------------------------------------------------------------------------------------------------------------------------------------------------------------------------------------------------------------------------------------------------------------------------------------------------------------------------------------------------------------------------------------------------------------------------------------------------------------------------------------------------------------------------------------------------------------------------------------------------------------------------------------------------------------------------------------------------------------------------------------------------------------------------------------------------------------------------------------------------------------------------------------------------------------------------------|-------------------------------------------------------------------------------------------------------------------------------------------------------------------------------------------------------------------------------------------------------------------------------------------------------------------------------------------------------------------------------------------------------------------------------------------------------------------------------------------------------------------------------------------------------------------------------------------------------------------------------------------------------------------------------------------------------------------------------------------------------------------------------------------------------------------------------------------------------------------|
| <p>Introduction. By the Honorable John Dean Caton, author of "The Antelope and Deer of America," etc.</p> <p>Moose Hunting in the Rocky Mountains. Newton Hibbs ("Roxey Newton").</p> <p>Elk Hunting in the Olympic Mountains. W. A. Perry ("Sillalicum").</p> <p>The Wapiti (Poem). By "Wah-bah-mi-mi."</p> <p>The Caribou. By William P. Lett ("Algonquin") and Dr. R. B. Cantrell.</p> <p>The Mule Deer. Rev. Joshua Cooke ("Boone").</p> <p>The Mule Deer of Southern California. T. S. Van Dyke, author of "The Still Hunter," etc.</p> <p>The Columbia Black-tail Deer. Thomas G. Farrell.</p> <p>The Virginia Deer. Walter M. Wolfe ("Shoshone").</p> <p>A Deer Hunt (Poem). "Wah-bah-mi-mi."</p> <p>Hunting the Grizzly Bear. Rev. Dr. W. S. Rainsford.</p> <p>The Polar Bear. Sergt. Francis Long, of the Greely Arctic Expedition, and George S. McTavish, of the Hudson Bay Company.</p> <p>A Polar Bear Hunt.</p> <p>The Black Bear. Col. Geo. D. Alexander.</p> <p>The Buffalo. Orin Belknap ("Uncle Fuller").</p> | <p>The Musk Ox. Sergt. H. Bierdebick, of the Greely Arctic Expedition.</p> <p>Still-hunting the Antelope. Arthur W. du Bray ("Gaucho").</p> <p>Coursing the Antelope. M. E. Allison.</p> <p>The Death of Venus (Poem). Wm. P. Lett.</p> <p>The Rocky Mountain Goat. John Fannin.</p> <p>The Rocky Mountain Sheep. G. O. Shields ("Coquina").</p> <p>The Peccary. A. G. Requa.</p> <p>The Cougar, or Mountain Lion. W. A. Perry ("Sillalicum").</p> <p>The Lynx. J. C. Natrass.</p> <p>The Wild Cat. Daniel Arrowsmith ("Sangamon").</p> <p>The Wolf. Wm. P. Lett.</p> <p>The Wolverine. C. A. Cooper ("Sibyllene").</p> <p>Coon Hunting in Southern Illinois. Daniel Arrowsmith ("Sangamon").</p> <p>Fox Hunting in Virginia. Dr. M. G. Ellzey.</p> <p>Alligator Shooting in Florida. Cyrus W. Butler.</p> <p>The Ethics of Field Sports. Wm. B. Leffingwell.</p> |
|---------------------------------------------------------------------------------------------------------------------------------------------------------------------------------------------------------------------------------------------------------------------------------------------------------------------------------------------------------------------------------------------------------------------------------------------------------------------------------------------------------------------------------------------------------------------------------------------------------------------------------------------------------------------------------------------------------------------------------------------------------------------------------------------------------------------------------------------------------------------------------------------------------------------------------------------------------------------------------------------------------------------------------|-------------------------------------------------------------------------------------------------------------------------------------------------------------------------------------------------------------------------------------------------------------------------------------------------------------------------------------------------------------------------------------------------------------------------------------------------------------------------------------------------------------------------------------------------------------------------------------------------------------------------------------------------------------------------------------------------------------------------------------------------------------------------------------------------------------------------------------------------------------------|

The Hon. John Dean Caton, the eminent naturalist and jurist, author of "The Antelope and Deer of America," etc., says of this work:

"Altogether, there is given here such a study of the natural history of our game quadrupeds, and of the thrilling incidents encountered in hunting them, as has never before been offered to the reading world. Each chapter in this book is in itself a complete work, and the book, as a whole, is a most valuable library.

"Any one of the names on Mr. Shields' list of contributors should insure the sale of an entire edition of his book, and when we multiply this possibility by twenty-six, the whole number of names on his title-page, the result obtained indicates the magnitude of the success that should, and that we hope will, crown his labors and those of his collaborateurs."

"This sumptuous volume, profusely and elegantly illustrated, written by a score or more of sportsmen, is a very captivating book. No single writer could have had all the experiences here narrated. The descriptions and incidents cover every variety of large game on the continent. \* \* \* \* \* The stories are as excellent in their variety as in their quality. There are no dull chapters in the book. In fact, it may be said it is the finest collection of hunting stories ever published."—*Chicago Inter-Ocean*.

"This is one of the best and most valuable of the books as yet written or edited by Mr. Shields. It comprises a collection of intelligently written monographs on all the various kinds of big game to be found in North America, from the grizzly to the polar bear, and from the Virginia deer to the Rocky Mountain goat. Each writer speaks from his own experience, tells what he has done and seen, and recounts the often thrilling incidents he has met with in hunting. All the contributors to the volume are well-known writers on field sports and hunting, and each one writes of a species of game he has studied for years in the field, on the mountain, or in the forest."

"The paper on the Rocky Mountain sheep is by the Editor, and is a fine account of the wildest, wariest, and most difficult animal to hunt on the continent. Mr. Shields is a most enthusiastic sportsman, and moreover, wields the pen of a ready writer, as indeed all these sportsmen do, so that one follows him in his adventures with almost breathless interest.

"From beginning to end and in every chapter this book is positively fascinating."—*Chicago Herald*.

*This book will be mailed, post-paid, on receipt of price by the editor.*

G. O. SHIELDS, 19 West 24th Street, New York

Also given as a Premium for 7 Subscriptions to Recreation

# ANOTHER WINNER

Made by Mr. Walter Winans, at the North London Rifle Club, London, England, 9 shots at 30 yards, target actual size, Smith & Wesson 45 calibre revolver and U. M. C. cartridges. The best 9-shot 30-yard revolver score as to string measurements for England. ❀❀❀

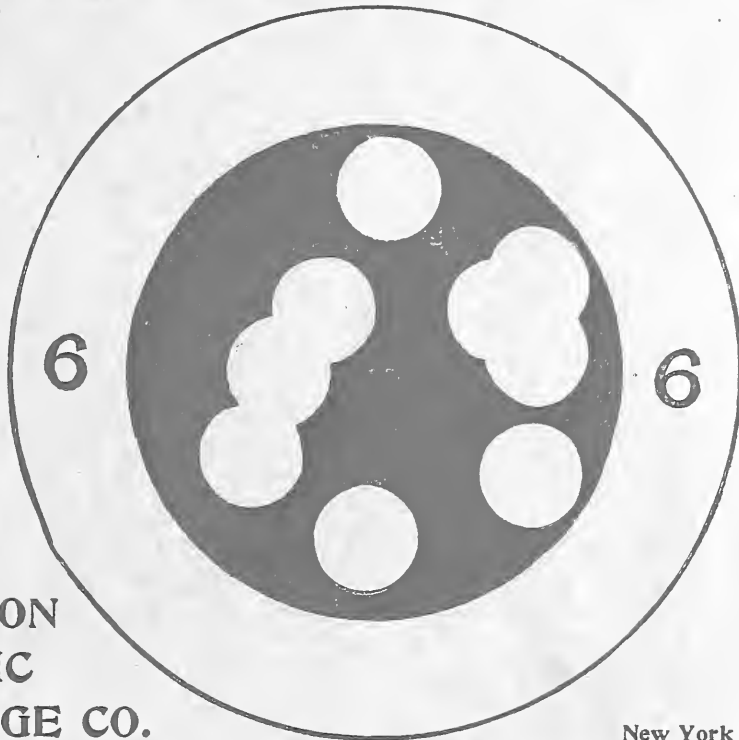

**THE UNION  
METALLIC  
CARTRIDGE CO.**

**FACTORY:**  
Bridgeport, Conn.  
**AGENCIES:**  
New York and San Francisco

**SCORE**

## HIGH GRADE REMINGTON

Hammerless Double Barrel Shot Guns are the finest guns made in America and are not excelled by any foreign make ❀❀❀

FITTED WITH  
AUTOMATIC OR  
NON-AUTOMATIC  
EJECTORS

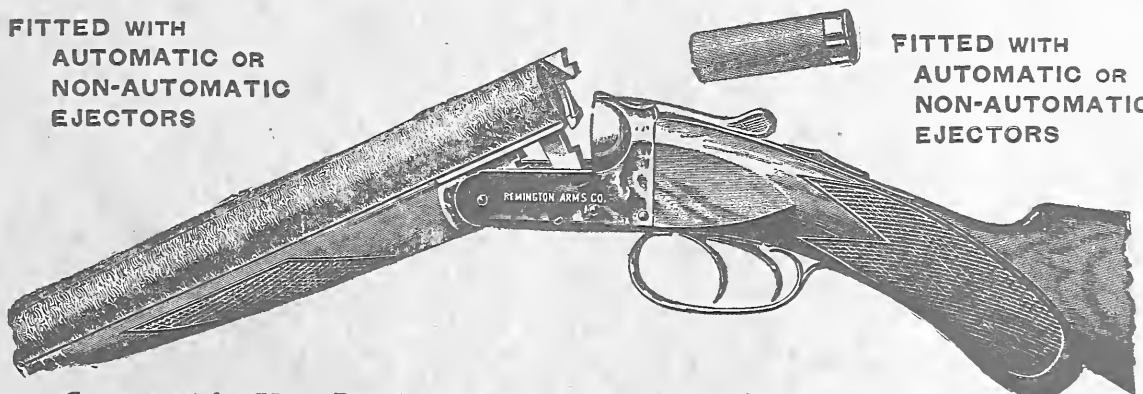

FITTED WITH  
AUTOMATIC OR  
NON-AUTOMATIC  
EJECTORS

Guaranteed for Nitro Powders and free from all imperfections. Grade E.E. Finest Damascus Barrels, finest quality bird and game engraving, best English walnut stock, checkered sides and gold name plates. List \$230.00 each. Twelve different grades from \$45.00 up to \$230.00.

SEND FOR CATALOGUE. Remington's are sold by all dealers.

**REMINGTON ARMS CO., ILION, N. Y.**

New York Office, 313-315 BROADWAY

The Sun Never Sets on the

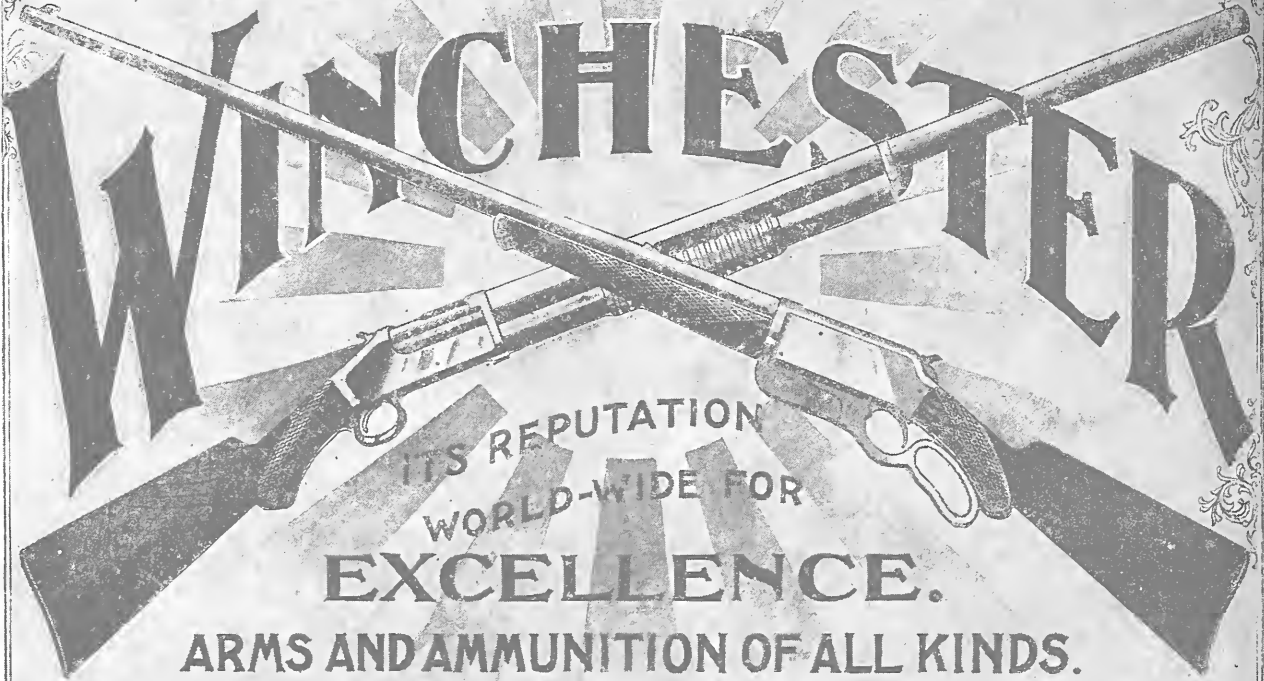

ITS REPUTATION  
WORLD-WIDE FOR

**EXCELLENCE.**

ARMS AND AMMUNITION OF ALL KINDS.

MANUFACTURED  
BY THE

**WINCHESTER REPEATING ARMS CO.** New Haven, Conn.

FREE - 136 PAGE ILLUSTRATED CATALOGUE.

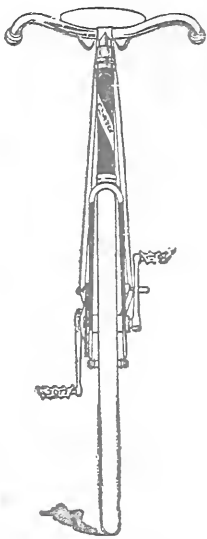

## Clipper Bicycles

are the product of one of the oldest and most successful builders of "safety" bicycles. The Clipper factory is one of the 10 largest in America. The Clipper people have sold from 200 bicycles in '90 to nearly 12,000 in '97,

with the aid of but \$1.00 per wheel spent in advertising. Clippers are sold on their merits and through the free advertising given them by satisfied customers. The New Clipper is the wheel you ought to buy at the price you ought to pay.

MADE BY THE **GRAND RAPIDS CYCLE CO.** GRAND RAPIDS, MICH.

## Look to your Bearings!

The bearings are the vital point

**"Fenton"**  
BICYCLES

have good ball bearings.  
No others half so good.

Send for Catalogue

**Fenton Metallic Mfg. Co.**  
Jamestown, N. Y.



NEW YORK AGENTS  
C. M. MOSEMAN & BRO.  
126-128 CHAMBERS ST.

# RECREATION

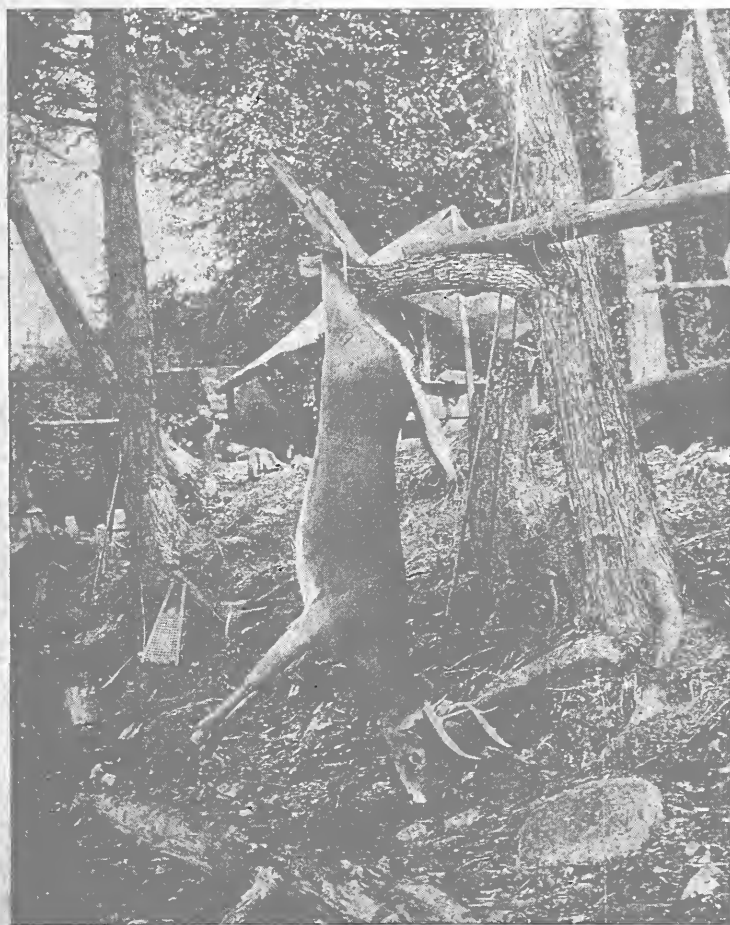
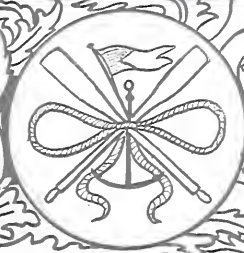
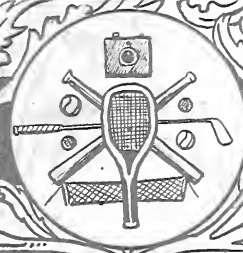

AMATEUR PHOTO BY J. H. DEMAREST  
A FRESH SUPPLY OF VENISON  
Awarded Sixteenth Prize in RECREATION'S Second Annual  
Photo Competition

PUBLISHED BY G. O. SHIELDS (COQUINA)  
19 WEST 24TH ST. NEW YORK

T. A. Cleland

# Hon. Thomas Marshall

Mayor of Keithsburg, Ill.

25

STRAIGHT



WINNER OF

## Grand American Handicap

March 24, 1897

Used DU PONT  
SMOKELESS POWDER

E. I. Du Pont De Nemours & Co., WILMINGTON, DEL.

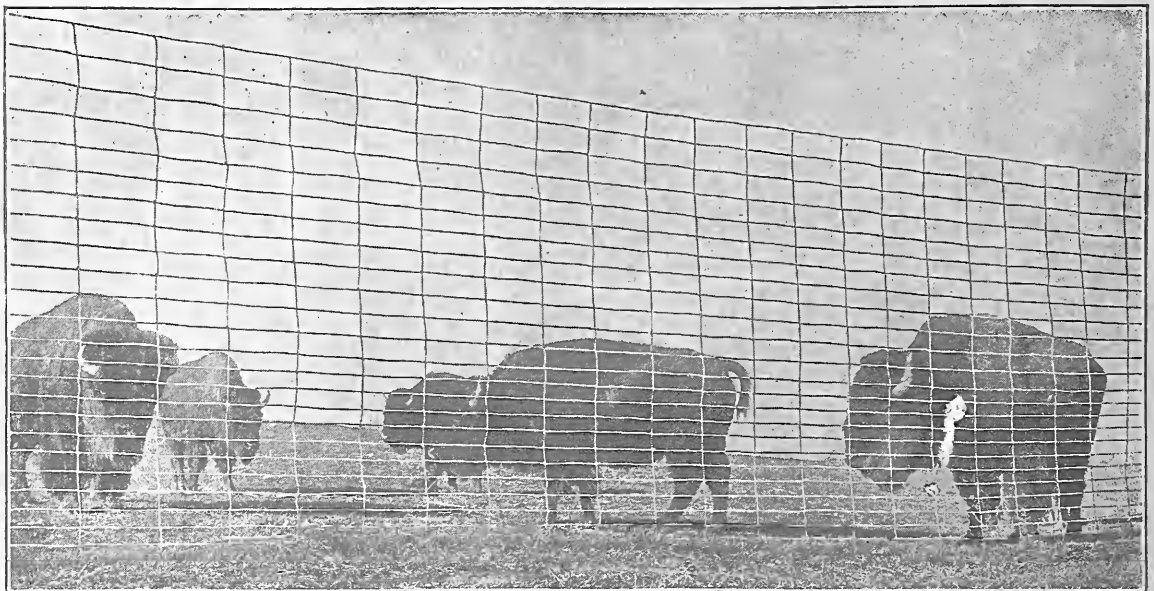

**STOP THE GAME!!! KILL THE UMPIRE?**

**NO!**

Simply build a PAGE FENCE around the premises and you've got 'em. No obstruction to the view. Holds Buffalo, Deer, Elk, anything.

Write for Particulars . . . .

**PAGE WOVEN WIRE FENCE CO.**

ADRIAN, MICH.



# RECREATION

Copyright, December, 1896, by G. O. Shields

A Monthly Magazine Devoted to Everything the Name Implies

\$1.00 A YEAR.  
10 CENTS A COPY.

G. O. SHIELDS (COQUINA),  
Editor and Manager.

19 WEST 24TH STREET,  
NEW YORK.

## CONTENTS OF THIS NUMBER

|                                                                                | PAGE                           |
|--------------------------------------------------------------------------------|--------------------------------|
| "He had White's Right Arm in his Capacious Mouth"—Frontispiece. BERT CASSIDY   |                                |
| A Bad Grizzly.....GEORGE W. KELLOGG                                            | 87                             |
| The Confessions of Lynx Canadensis. Illustrated.....W. E. CARLIN               | 89                             |
| "Oh Mother, Take the Wheel Away".....OLD SONG                                  | 93                             |
| Our Alaskan Exploring Expedition. Up the Stickeen. Illustrated.....A. J. STONE | 94                             |
| "Pete" Illustrated.....H. A. HORTON                                            | 105                            |
| Record Buffalo Heads. Illustrated.....W. T. H.                                 | 107                            |
| My Wife's Moose. Illustrated.....W. E. BEMIS                                   | 109                            |
| In the Gaulies. Illustrated.....D. C. BRADEN                                   | 116                            |
| A Reminiscence of Buffalo Days. Illustrated.....CAPT. H. ROMEYN, U.S.A.        | 117                            |
| A Salt Water Breeze. Illustrated.....GEORGE G. CANTWELL                        | 119                            |
| Old Fort Smith.....MAJ. E. R. P. SHURLY, U.S.A.                                | 121                            |
| In the Land of the Shag.....F. J. CHURCH                                       | 122                            |
| Fishing in the Mountains of Maryland.....L. L. LITMAN                          | 124                            |
| Camped in the Canyon. (Poem).....JAMES HANKS                                   | 126                            |
| A Montana Dream. (Poem).....JOHN V. COLE                                       | 158                            |
| From the Game Fields.....127                                                   | Bicycling.....157              |
| Fish and Fishing.....140                                                       | Book Notices.....160           |
| Guns and Ammunition.....145                                                    | Puzzle Corner.....161          |
| Natural History.....151                                                        | Amateur Photography.....162    |
| Editor's Corner.....156                                                        | Publisher's Department.....166 |

Entered as Second-Class Matter at New York Post-Office, Oct. 17, 1894.



YOU have confidence in things which  
have stood a real test of years?  
Then you must have faith in

# Sozodont

With our grandparents it was the favorite family dentifrice. To-day it is no less a favorite. Back of this there must be reasons. What they are you can best determine by a trial of this famous dentifrice.

A sample for three cents (postage) if you mention this publication. Address the Proprietors of SOZODONT, Messrs. HALL & RUCKEL, NEW YORK.



RIDE A MONARCH AND KEEP IN FRONT



MONARCH CYCLE MFG CO.,

NEW YORK.

CHICAGO.

LONDON.

SEND FOR 40 PAGE ART CATALOGUE.



THE NEW LUNDBORG PERFUME  
"Heather of the Links"

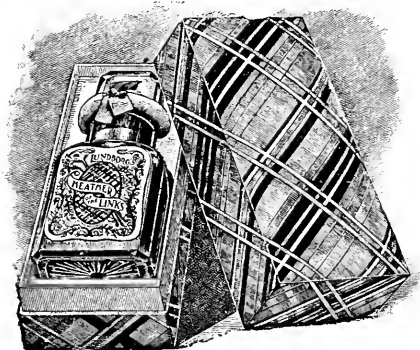

IS UP-TO-DATE AND AS ROYAL  
AS THE ANCIENT GAME OF GOLF.

LADD & COFFIN,  
PROPRIETORS AND MANUFACTURERS  
OF LUNDBORG'S PERFUMES.

1 oz. bottle 90c.  
Will be sent express paid on receipt of price.

24 Barclay Street, New York.

THE REPEATER WITH THE SOLID TOP

# The Marlin Model 1897



IS A



22 CALIBRE  
TAKE DOWN

Model 1897 Rifle Apart

This uses in one rifle the 22 short, 22 long and 22 long rifle cartridges, black and smokeless



We have endeavored to make this the best 22 calibre rifle ever made, and it is.



Weight only 5 1-2 pounds



Action finely finished inside and outside

The Receiver is made of our "Special Smokeless Steel," same as used in our Smokeless Rifles.

The working parts are of tool steel. This insures a perfect working rifle and a permanent adjustment.

Barrel gracefully tapered, with elevating rear, and German silver for sights.

Easy to clean. No single shot can be more conveniently cleaned.

Simplest to take apart.

Send · for · Catalogue

## THE MARLIN FIRE ARMS CO.

\_\_\_\_\_New Haven, Conn.

# The Model 1893

is the rifle using the 30-30 Smokeless Cartridge. This cartridge as made for our rifle is loaded with 32 grains of Military Smokeless Powder, giving a velocity of 2,000 feet per second, a full 2,000, not 100 or so less. This, with our flat pointed bullet, makes as accurate a 30 calibre cartridge as can be loaded, and also one without a superior for hunting purposes.

## THESE ARE THE FACTORY CARTRIDGES



Full Metal Cased Bullet  
(For Target Purposes)

Soft Pointed Bullet  
(For Hunting Use)



Six grains of  
smokeless powder  
100-grain  
bullet



For Short Ranges

The Barrel and Action of this rifle are made of our

## Special Smokeless Steel

guaranteed to stand the highest pressure. We also use this steel in all the rest of our Model 1893 Rifles, viz., 25-36 Smokeless, 32-40 and 38-55, and also in the Model 1895 taking the 38-56, 40 and 45 calibre cartridges. We are determined to have our rifles just as strong and safe as good material can make an arm.

Our new catalogue is a veritable encyclopaedia of information regarding rifles, ammunition, etc. Free for the asking, but stamps will help pay postage.

## THE MARLIN FIRE ARMS CO.

New Haven, Conn.

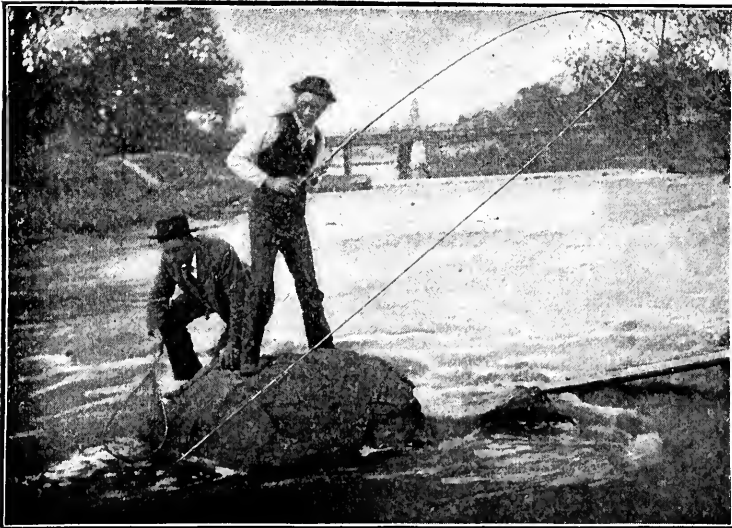

A Critical Moment



There is.....

**GOOD  
FISHING**

ALONG THE

# PICTURESQUE ERIE

Let Us  
Suggest.....



The Delaware River

For Salmon, Bass and  
Wall-Eyed Pike

Greenwood Lake

For Bass, Pike and  
Pickerel

and the hundreds of trout  
streams and lakes men-  
tioned in our little book  
on fishing, which will be  
mailed on application



**D. I. ROBERT'S**

Gen'l Passenger Agt.  
21 Cortlandt St., New York



Fishing on the Picturesque Erie





Farrand

What's this? DURKEE'S SALAD DRESSING! Well! Well! Captain Kidd did know a good thing!  
We're on the right track—the treasure's here.

Send for Free Booklet on "Salads, How to Make and Dress Them," containing many novel and valuable recipes for Salads, Sandwiches, Sauces, Luncheon Dishes, etc., etc. Sample Bottle, Ten Cents.

**E. R. DURKEE & CO., 129 Water Street, New York**

# "HALF THE FUN"

in cycling is to know what you have accomplished....



THE

## Veeder CYCLOMETER

tells exactly. —————

\*\*\*\*  
DUST PROOF,  
WATER PROOF,  
POSITIVELY ACCURATE.

\*\*\*\*  
The Veeder has banished all other forms of cyclometer, and its success has aroused imitations that resemble it only in appearance. Be sure your purchase bears the name that assures perfection—VEEDER.

AT ALL DEALERS.

Booklet Free from

**VEEDER MFG. CO., Hartford, Conn.**

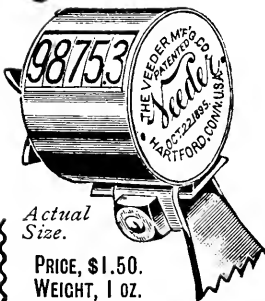

Actual Size.

PRICE, \$1.50.  
WEIGHT, 1 oz.

## A GREAT OFFER BY GERMANIA WINE CELLARS

HAMMONDSPORT and  
RHEIMS, N. Y.

In order to introduce our goods we make the following offer, good for the next thirty days only. Upon receipt of \$5.00 we will send to any sportsman or reader of RECREATION one case of our goods containing eleven bottles of wine and one bottle of our extra fine double-distilled Grape Brandy, all first class and put up in elegant style, assorted, as follows:

- 1 Quart Bottle Grand Imperial Sec Champagne
- 1 Quart Bottle Delaware
- 1 " " Riesling
- 1 " " Tokay
- 1 " " Sweet Catawba
- 1 " " Sherry
- 1 " " Elvira
- 1 " " Niagara
- 1 " " Angelica
- 1 " " Port
- 1 " " Sweet Isabella
- 1 " " Imperial Grape Brandy

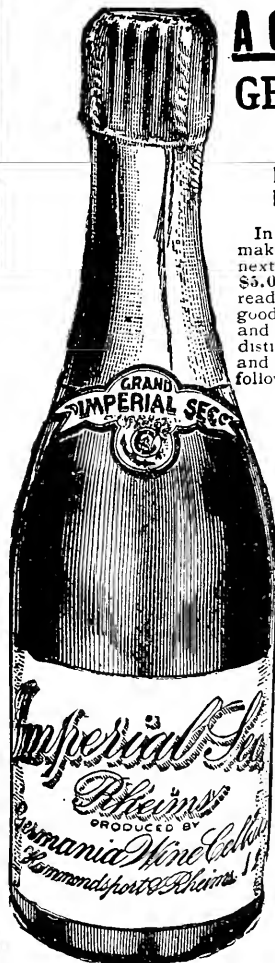

This offer is made mainly to introduce our Grand Imperial Sec Champagne and our fine double-distilled Grape Brandy, without which no Sportsman or Hunter should start on an expedition, as it is very necessary where such exercise is taken. This case of goods is offered at about one-half its actual cost and it will please us if our friends and patrons will take advantage of this and help us introduce our goods.

# Decorations for Sportsmen's Dens

## Tapestry Paintings

### 2000

Tapestry Paintings to choose from. 38 artists employed, including gold medalists of the Paris Salon.



## Wall Papers Given Away

Fine Satin, French or Leather Papers, 10 cents per roll; former price, \$1.50. Have drapery to match. State color and for what rooms. **Will send sample book if you will pay expressage.**

## SPECIAL DRAPERIES

to match. Venetian, Roman, Dresden, Marie Antoinette, Delft, Russian, Grecian and Oriental.

## TAPESTRY MATERIALS

We manufacture tapestry materials. Superior to foreign goods, and half the price. Book of samples, 10 cents. **Send \$1.50 for trial order, for 2 yards of 50-inch, No. 6 goods worth \$3.00.**

## DECORATIONS

Write for color schemes, designs, estimates. Artists sent to all parts of the world to do every sort of decorating and painting. We are educating the country to color-harmony. Relief; stained glass; wall paper; carpets; furniture; draperies, etc. Pupils taught. **Send \$25.00 for a color scheme to decorate your home.**

## SCHOOLS

Six 2-hour tapestry painting, china or miniature lessons, in studio, \$5.00. Complete written instructions by mail, \$1.00. Tapestry paintings rented; full size drawings, paints, brushes, etc., supplied. Nowhere—Paris not excepted—are such advantages offered pupils. New catalogue of 125 studies, 25 cents. **Send \$1.00 for complete instructions in tapestry painting and compendium of 140 studies.**

## THE GODDESS OF ATVATABAR

A trip to the Interior World. "Jules Verne in his happiest days outdone." 318 octavo pages, 44 illustrations, price \$2.00, postage prepaid. Paper covers, 50 cents.

## MANUAL OF ART DECORATIONS

The art book of the century. 200 royal quarto pages. 50 superb full-page illustrations (11 colored) of modern home interiors. **Send \$2.00 for this \$50.00 art book.**

# JOHN F. DOUTHITT

American Tapestry and  
Decorative Company

286 Fifth Avenue, New York  
Near 30th Street



# GAS ENGINE & POWER CO.

and CHARLES L. SEABURY & CO., Builders of

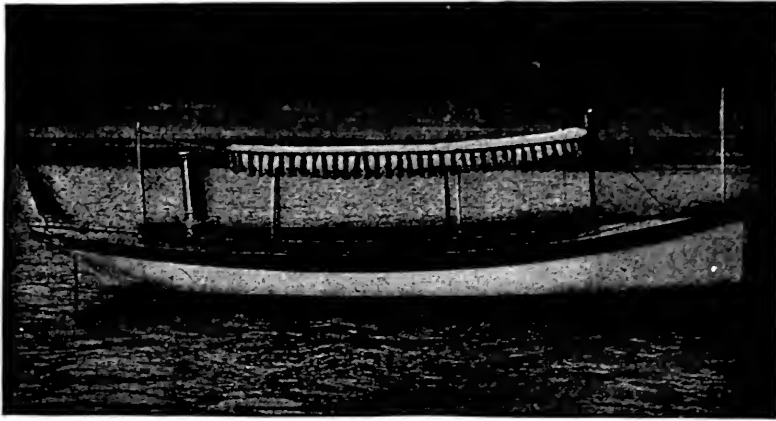

## The Only Naphtha ..Launch..

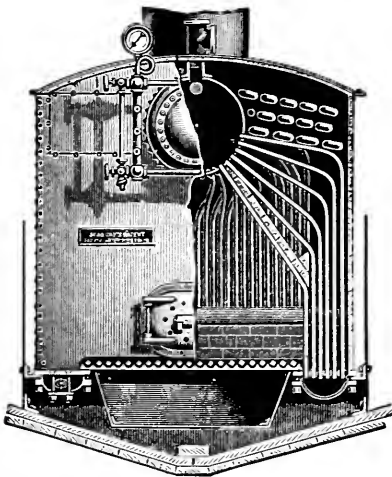

Our Patent Tubulous Boiler  
for Steam Yachts

High-class Steam Yachts  
Sail Yachts  
Electric Launches  
Dinghys  
Gigs and Yacht Tenders  
Seabury's Water Tube Boilers  
Marine Engines

Storage Basin and Ship's ways. Overhauling of  
all kinds promptly done. Charters and Insurance.  
Boats bought and sold on commission . . . .

CORRESPONDENCE  
SOLICITED . . . .

Send ten cents in stamps for catalogues to downtown office,  
50 BROADWAY, or to factory at

MORRIS HEIGHTS, New York City



BEST LINE  
TO  
**DENVER**

# ST PAUL AND MINNEAPOLIS LIMITED EXPRESS

THE FINEST TRAIN IN THE WORLD  
LEAVES CHICAGO DAILY AT 6.30 P. M.



BEST LINE  
TO  
**ST. PAUL  
AND  
MINNEAPOLIS**



BEST LINE  
TO  
**OMAHA**



BEST LINE  
TO  
**KANSAS CITY**



BEST LINE  
TO  
**COUNCIL  
BLUFFS**



BEST LINE  
TO  
**BLACK HILLS**



BEST LINE  
TO  
**PUGET  
SOUND**



BEST LINE  
TO  
**CALIFORNIA**



BEST LINE  
TO  
**MONTANA**

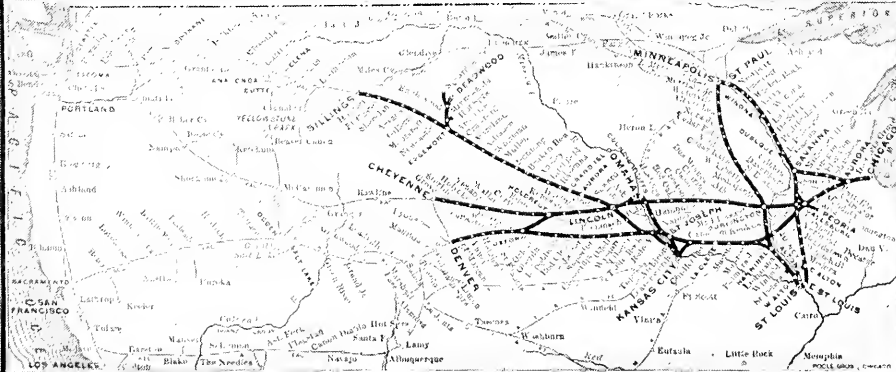

BEST LINE  
TO  
**TEXAS**

## SINCE NOVEMBER, 1896

We have been doing our best to keep up with the increasing demand for Gramophones : : : : :

Our manufacturing facilities have been steadily extended; work has been carried on night and day; much foreign business has been declined; yet (on July 7th) we find ourselves with hundreds of orders unfilled. : :

*But one conclusion can be drawn from this unprecedented demand: the Gramophone is without question the most popular, as it is the simplest and most wonderful, talking machine. It is the only sound reproducing instrument in the world that gives such results as were witnessed in the Metropolitan Opera House test, referred to in the following unsolicited letter. : : : :*

OFFICES OF  
 ABBEY, SCHOEFFEL & GRAU, LTD.  
 Metropolitan Opera House  
 CORNER 39TH STREET AND 7TH AVENUE  
 NEW YORK

April 24, 1897.

National Gramophone Company,  
 874 Broadway, New York, N. Y.

GENTLEMEN:—Enclosed please find my check for \$31.00 to pay for Gramophone and records.

By the way, I was very much interested in a trial of the Gramophone in the Metropolitan Opera House a few days ago. I had no idea that so small an instrument, with a horn only about twelve inches long, could fill every nook and corner of the largest auditorium in New York City. Every word seemed to be distinct, and the rendering of the selections nothing short of marvelous.

I congratulate you upon the possession of such a wonderful instrument.

Yours very truly,

JOHN B. SCHOEFFEL,  
 Managing Director Abbey, Schoeffel & Grau

*Arrangements have now been completed whereby it is believed that after July 25th all orders can be promptly filled. Great improvements have been made in quality and volume of tone since the above letter was written, and what was a marvelous reproduction before, is even more so now. All orders for style No. 25, spring motor, will be filled with our new improved machine, with the new exhibition sound box. New Catalog ready—by request.*

*National Gramophone Co., 874 Broadway, New York.*

# Genuine Siberian Moose Hunting, Golf or ABSOLUTELY WATER-PROOF TO THE TOP. Walking Shoes

**NOTHING SO GOOD EVER PRODUCED BEFORE AT ANY PRICE.**

This is a **special** line of Boots and Shoes in every way. Special water-proof leather, special anhydrous soles, special lasts of new design, special stitching, special lining, in fact, every point of shoe worth has been studied to give each special value.

The result is a shoe as strong as steel, yet, pliable and soft as kid, graceful to the eye and easy on the foot, and will outwear any two ordinary shoes.

**The leather** is the famous Siberian Moose. Costs more than any other, and guaranteed water-proof.

**The soles** are of the best anhydrous oak stock, made water-proof by patented process.

**The stitching** will not rip. The bottoms are hand-sewed with Barbour's extra heavy water-proof flax. The uppers are stitched and then double-stitched with pure silk.

**Bellows tongues** of the best Moose stock are used, making the shoes water-proof to the top.

**The linings** are of finest russet calf-skin, adding warmth and strength.

**English Backstays, extra heavy eye-lets, "Bull Dog" toes, Pratt Fasteners, etc., etc.** Every approved shoe point will be found in them. **Price to all alike, \$7.50 net.**

We also make a short boot, 12 inches high, at \$8.50; a knee boot, "Hunters Style," lacing up the front, at \$10.00, and a "Cavalry Style" boot, at \$12.00, all with the same good points as the shoes.

We expect a large out-of-town trade, and to quickly introduce this line we will, on the first 100 pairs, prepay expressage to any part of the United States or Canada, as the orders are received.

**HENRY C.  
SQUIRES & SON**

**20 Cortlandt  
Street  
New York**

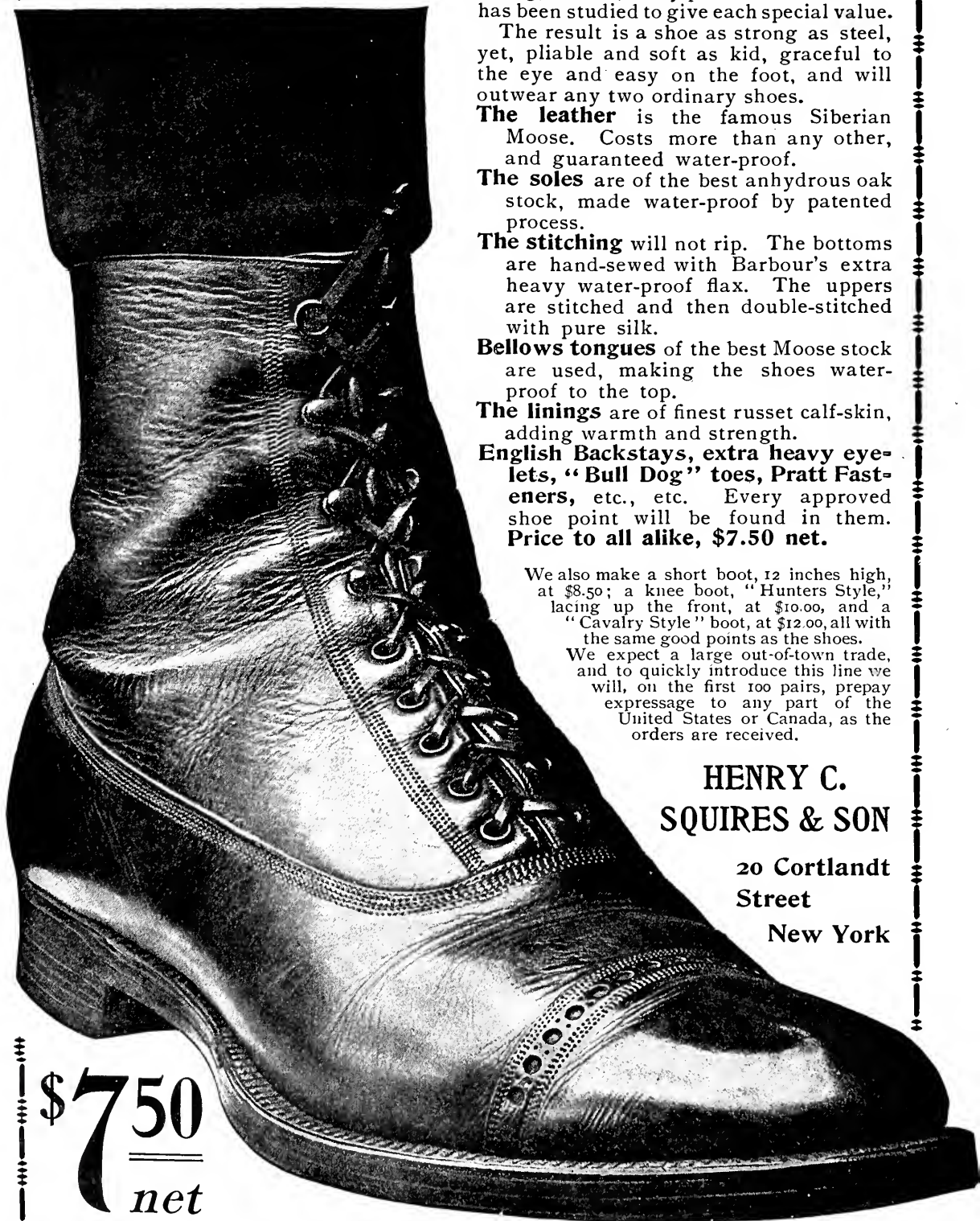

**\$7.50**  
**net**

The cut is a photograph of our tan walking shoe after having been worn two months.



# The Pearce Hygienic Fleeced Underwear

**DON'T SHRINK NO IMITATION**

A decided advance over all other undergarments. Prevents colds and secures comfort and health.

All moisture (whether from perspiration or sudden drenching) passes through the woollen fleece-lining to the cotton on the outside, and the part next to the body becomes almost instantaneously dry.

Made in shirts and drawers, vests and pants, combination suits and night-ropes; all sizes and weights, for men, women, and children, in white, ecru, and colored.

For sale by leading Dry-Goods, Furnishing, and Clothing Stores.

**THOS. A. PEARCE & CO.,** Manufacturers  
PHILADELPHIA

WM. EWART & SON, Ltd.

(Underwear Dep't, J. B. Seward, Mgr.),  
115 and 117 Franklin Street, New York  
Sole Agents for United States

**A GEM  
AMONG JEWELS**

In appearance a jewel may be perfect—in reality, imperfect. It is so with a bicycle. Paint covers a multitude of sins, but will not insure safety against flaws or imperfections.

**THE HOWARD  
PLATE**

on a Howard Cycle is a guarantee of Howard perfection, backed by an old and honorable firm

**THE HOWARD CYCLE \$ 100**  
Men's and Women's Models

**THE HOWARD \$ 150**  
TANDEM

THE E. HOWARD WATCH & CLOCK Co., 383 Washington St., Boston. 41 Maiden Lane, New York

# MENNEN'S BORATED TALCUM



# TOILET POWDER

AFTER  
BATHING

## MENNEN'S BORATED TALCUM ❀ ❀ ❀ ❀ TOILET POWDER

Approved by the Highest Medical Authorities as a Perfect  
Sanitary Toilet Preparation for infants and adults

*WRITE FOR FREE SAMPLE*

Positively relieves Prickly Heat, Perspiration,  
Nettle Rash, Chafed Skin, Sunburn, etc.  
Removes Blotches, Pimples, and Tan; makes  
the skin smooth and healthy. Decorated  
Tin Box, Sprinkler Top. Sold by druggists  
or mailed for 25 cents. (Name this paper.)

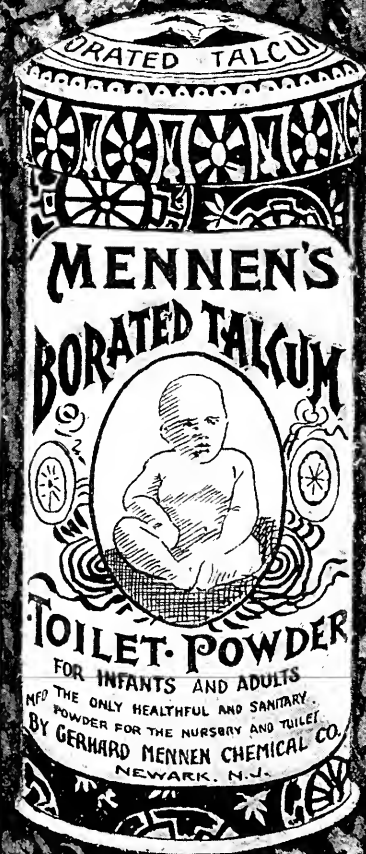

GERHARD MENNEN CO., 597 Broad Street, Newark, N. J.

WAGSTAFF & CO. N.Y.

FOR THE

**SKIN**

**SCALP**

...and...

**COMPLEXION**

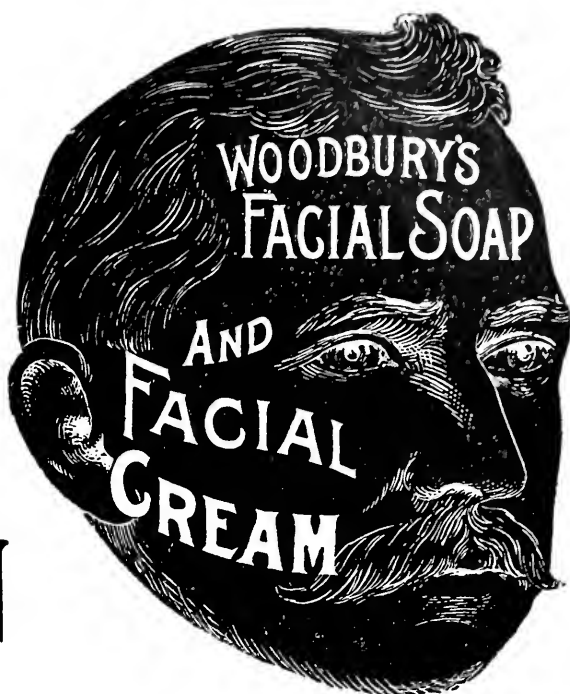

*Pure, Antiseptic, Medicinal*

The grandest combination known for curing a bad skin and protecting a good complexion. Manufactured by Dermatologist John H. Woodbury, who has made the Skin, Scalp, and Complexion a study for over twenty-six years.

*Woodbury's Facial Cream*

being absolutely free from grease or oil of any nature can be used freely on the face or hands without causing a superfluous growth of hair. It is delightfully perfumed and an acquisition to the toilet.

*Woodbury's Facial Soap*

contains the best Antiseptic known to Medical Science and will allay any irritation of the skin. Its daily use will eradicate Blackheads, Freckles, and Pimples, and when used in conjunction with Woodbury's Facial Cream will leave the skin clear, soft, and beautiful. They are sold everywhere.

**JOHN H. WOODBURY, Dermatological Institute**

Offices for the Cure of Skin and Nervous Diseases and the Removal of Facial Blemishes:

New York, 127 W. 42d St.:

Boston, 11 Winter St.:

Philadelphia, 1306 Walnut St.:

Chicago, 163 State St.

Address all letters to 127 West 42d Street, New York.

A sample of either Woodbury's Facial Soap or Facial Cream, with 132-page illustrated Beauty book, mailed on receipt of 10 cents by mentioning *Recreation*.

Send for Catalog of.....

# VICTOR FOOTBALL GOODS

They are leaders for quality of material, fine workmanship, and improvements



## The Victor Intercollegiate Football

Is used and recommended by leading college players

(Examine our new model, pointed end ball, the latest shape)

The New Victor Face Mask and Head Protector  
has many advantages over the old style



We manufacture our own Football Shoes  
and can quote lowest prices

Special prices for team outfits furnished on application

# OVERMAN WHEEL CO.

Makers of Victor Bicycles

New York

Denver

Boston

San Francisco

Chicago

Portland, Ore.

Detroit





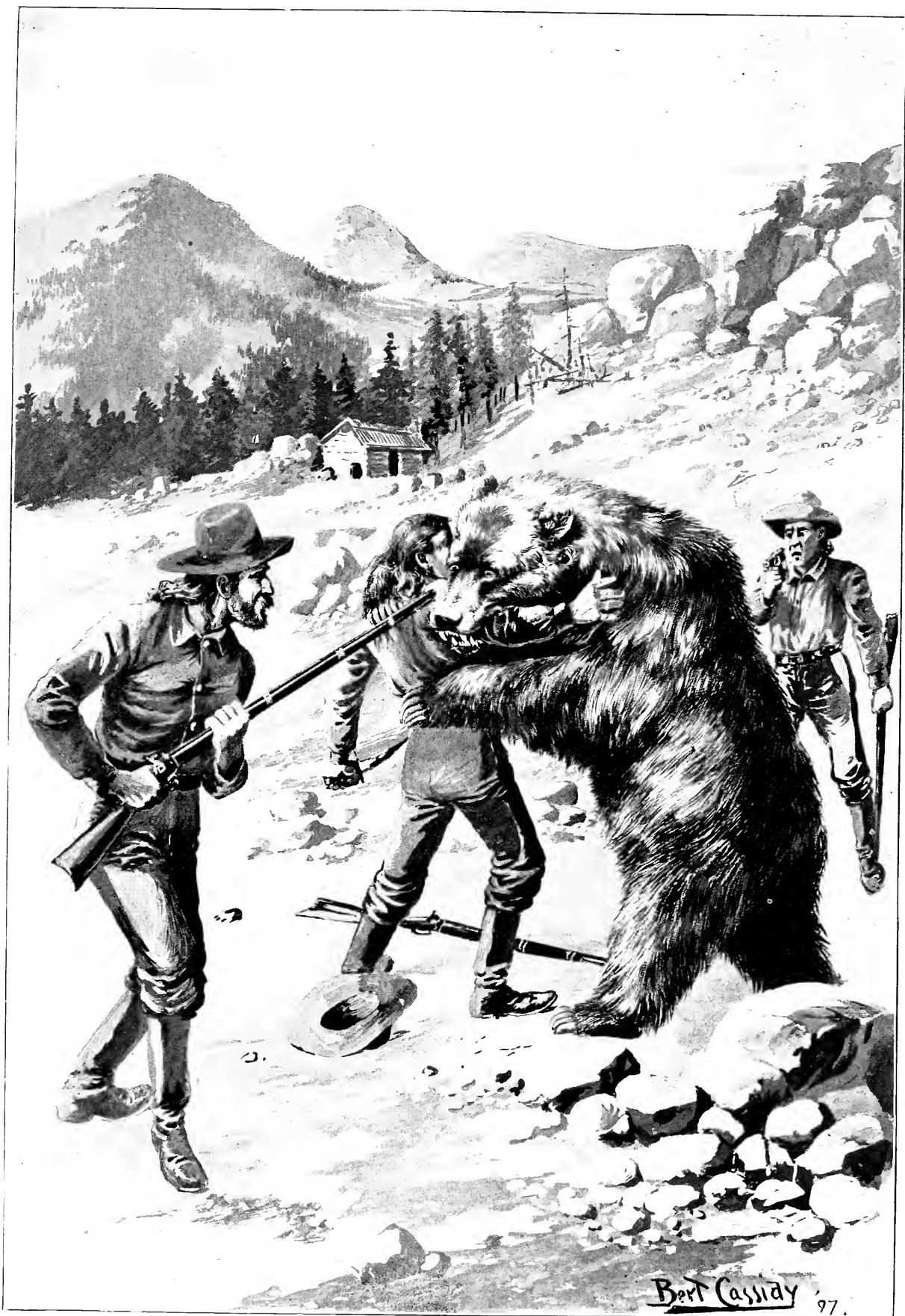

"HE HAD WHITE'S RIGHT ARM IN HIS CAPACIOUS MOUTH."

# RECREATION.

Volume VII.

AUGUST, 1897.

Number 2.

G. O. SHIELDS (COQUINA), Editor and Manager.

## A BAD GRIZZLY.

GEORGE W. KELLOGG.

In 1850 there were scattered over the mountains of California adventurers from everywhere, who had come to dig for gold, of which there had been so many wonderful stories. Careless of danger, in their persistent hunt for the precious metal, some were left, mangled by wild animals; some were scalped by hostile Indians and some were stricken by the mountain fever, and were never heard of more. But, regardless of the dangers and privations, many penetrated the wilds of the mountains, exploring every gulch and ravine, climbing hills, examining streams and prospecting for gold everywhere. Where all was so wild and desolate then, towns are now built up, railroads are winding through, and the wild experiences of 45 years ago are almost forgotten. In those days a person was seldom known by his true name, but some trifling incident would fix a nickname to him that he would carry ever after.

During the autumn of 1850 I was with a companion called "Mountain Joe," a hardy, resolute fellow, and we prospected along up the Cosmos, and afterward followed the Mokehoma river to its head, probably then as wild a place as man ever saw. Going still farther North we passed over what is now called Grizzly Flats. We finally came down and located at a place called Cold Spring, on Weber creek, 5 miles from Coloma, where gold was first discovered.

During our prospecting tour we

located some rich finds of gold, but in some cases we could find no way to bring in provisions, and in others the hostile Indians kept on our trail, and we had no time to do anything but watch, fight or run. We had some delightful times and some narrow escapes, but none that quite came up to a certain adventure, or what some would call "a lively episode," crowded into a few seconds.

In November I had left Cold Spring, alone, and, going farther up, had come across an acquaintance whom I had known by the name of "Jim." He was mining in a small stream, at the foot of the mountain, in company with a man named White. Jim was a good-natured fellow, and about as resolute and hardy a man as could be found. White was a great, strong, muscular fellow, and afraid of nothing. They had a cabin and had lain in provisions for the winter. I was invited to stay with them awhile, and decided to do so.

One night, soon after I reached there, we heard something rummaging about, outside the cabin, and White said it was probably a bear; but, as we could not fight a bear, very well, in the dark, he thought it best not to disturb him until daylight, and then, if he stayed about, we would have some bear meat. As soon as it was light enough we took our guns and strapped on our knives. I had a revolver, which I shoved into my belt. When we opened the door and looked

out the bear was in sight, not far away, but too far to shoot from the cabin. He was an enormous grizzly, and was going slowly away. White ran down toward him and I followed. As we got nearer to him we both blazed away. Before either of us could load (we had no Winchester or other breech loaders then) the grizzly turned on us, and, with surprising quickness, had White between his paws, with his (White's) right arm in his capacious mouth. His eyes glared down on Jim, who had reserved his fire and was casting about trying to get in a shot without hitting White. White's left arm was still free. He had gotten hold of his knife and was driving it into the bear's side with terrible force, which soon made the bear let go White's arm and catch his head in his mouth. Just then Jim sent a ball crashing through the bear's heart,

and I had meantime emptied my revolver into his back. He rolled over, but not until he had taken White's scalp entirely off, with one ear and 2 small pieces of skull bone with it.

We pulled White away from the bear and got him to the cabin, as soon as possible. His head was an awful looking sight, but he was in his right mind and gave us directions how to wash off and bind up his head. After awhile, when he became quiet, he told Jim to take the pickle jar and put his scalp in it, with the ear and bones, and fill it with whisky, so they would keep. Jim said he would do it, but that it was "an awful waste of whisky."

The bear was a very large one, and made one of the worst fights I had ever seen. Jim stayed with White until he recovered, while I returned to Cold Spring and sent in such supplies as they needed.



No use to print this man's other name. Every reader of RECREATION will recognize him at sight.

# THE CONFESSIONS OF LYNX CANADENSIS.

W. E. CARLIN.

Having met with 2 fellows who were photographing for you, and having been forced to have my own picture taken, for reproduction in RECREATION, whether I liked it or not, it appeared to me an opportune time to write you a few words concerning my-

seemed so true and realistic that my heart (and my head, I fear) swelled with pride at the accounts of my prowess.

Then I sallied forth determined to dine on old man Long, or on any other trapper who might come my way. But



STEALTH.

COPYRIGHT, 1897, BY WRIGHT & CARLIN.

self and to clear up, in the minds of the younger generation, some of the ridiculous stories that have been told of me, by romancers.

What boy has not shuddered as he was told hair-raising tales of the monster catamount, wild-cat, bob-cat, or "painter" who spends his time in waiting for the poor, lonely man; pouncing on him at sight, and tearing him, savagely, limb from limb, preparatory to a hearty meal? When I read these stories of myself, they

my new-born pride met with a sad reverse; for although Long is only 5 feet high, and weighs only 120 pounds, my spirits oozed out of my long legs when I saw the ease with which he handled his 80 pound pack; and it occurred to me that my little 25 pounds of nerve and sinew would count for naught, in case of any serious trouble with him. I therefore quickly got out of his way, and was forced to steal an old piece of dried meat, from his camp, for my supper.



COPYRIGHT, 1897, BY WRIGHT & CARLIN.

DEFIANCE.

I wish to say to the younger sportsmen that my kind of critters does not attack men, under any circumstances, when we can get away. In fact we do not like men at all; and I have heard old mountaineers say, when talking over their campfires, that as many years as they had been in the hills, they never had seen a cussed cat yet, and they wondered where they kept themselves, anyway.

We have no special range, but roam from the highest peaks to the lowest bottoms. In the day time we sleep in



COPYRIGHT, 1897, BY WRIGHT & CARLIN.

READY TO SPRING.

some dense thicket—occasionally in some cave, in or under the shelving rock, where the sun does not penetrate. As cool dusk comes on we prowl softly about, looking for some snow-shoe rabbit, or some grouse that has gone to roost on a low limb. Grouse are our favorite food. If there is anything we dote on it is a nice, tender, fat spring grouse. Many a young brood, or old drumming cock have I devoured, as the light grew dim, in the spring evening. It is very amusing to sit and watch an old cock grouse, as he swells and struts along his log; and when he has his thoughts full of his sweetheart, and begins to drum, to just make about 3 jumps, and then with one stroke to crush the life and conceit all out of him.

Of course squirrels, martens, etc., are all acceptable, when they come my way. I am also fond of the remains of deer, or other animals, killed by hunters, and I make a business of

stealing old man Long's bear baits; for I know the pan of his trap is held up by a No. 2 spring and that my weight won't set it off.

Now about my expressions and attitudes. It is past belief how taxidermists have managed to twist and distort me. You will see, by my various portraits, in this and the July issue of *RECREATION*, that I don't stand up, with my ears pitched forward—like a horse neighing. Neither do I show my teeth and growl. Not at all. When I get mad I lay my ears well back, just as any other cat does; and the madder I get the lower I lay them, producing a "snaky" expression, such as you

will see in Evert Von Muyden's etchings of tigers and leopards.

In order to get any large and satisfactory photos of me, you must either tree me, with dogs, or catch me in a trap. After once getting me, it will depend on your knowledge, and your handling of me, as to what expressions and what attitudes you succeed in catching. I forgot to mention that having deemed it best to spare old man Long's life, for reasons already set forth, I decided to get a piece of his bacon, but happened to step in a blamed old Newhouse trap; and that accounts for my sending you these notes.



HERE THEY COME.

AMATEUR PHOTO BY WILLIAM MOHAUPT.

Awarded Twentieth Prize in *RECREATION*'s Second Annual Photo Competition.



"AND I AM LONELY HERE."



OH MOTHER, TAKE THE WHEEL AWAY.

OLD SONG.

Oh mother, take the wheel away and put it out of sight,  
For I am heavy hearted and I cannot spin to-night:  
Come nearer, nearer yet, I have a story for your ear  
So come and sit beside me, come and listen, mother dear;

You heard the village bells to-night; his wedding bells they were  
And Mabel is his happy wife, and I am lonely here;  
A year ago to-night, I mind, he sought me for his bride,  
And who so glad at heart as I, that happy Eastertide?

But Mabel came among us, and her face was fair to see,  
What wonder was it, mother, that he thought no more of me?  
When first he said fair words to her I know she would not hear,  
But in the end she listened,—could she help it, mother dear?

And afterward we met, and we were friendly all the same:  
For ne'er a word I said to them of anger or of blame  
Till both believed I did not care, and maybe they were right,  
But, mother, take the wheel away, I cannot spin to-night!

## OUR ALASKAN EXPLORING EXPEDITION.—UP THE STICKEEN.

A. J. STONE.

John Muir, who canoed the Stahkeena, or Great river, from mouth to head, in 1879, epitomized its finest reach as "a Yosemite 100 miles long." It is said that 300 living glaciers drain directly into the Stickeen, and Professor Muir claimed to have counted 100 from his canoe. The river is wide and shallow at its mouth, with a current of about 5 miles an hour.



GUIDE, IN THE SERVICE OF RECREATION'S ALASKAN EXPLORING EXPEDITION.

When RECREATION'S exploring party made a second and successful attempt to stem the current of this mighty stream our monster Indian canoe was shoved from the landing at Ft. Wrangle, by a picked crew of Tlingit boatmen. I carefully noted the clock-like movements of these hardy, well drilled, muscular fellows, as they handled the long, heavy single sweeps, that shot our vessel into the open waters of the bay; and all doubts as to our being able, this time, to

reach the head waters of the Stickeen vanished at once.

The big, square sail was hoisted, and the 10 miles run on salt water to Pt. Rothsay, at the mouth of the river, past picturesque Pt. Highfield, through Labouchere bay, past Kadin and Sergieff islands was quickly made.

We were but 2 short miles from Wrangle, when we passed from the dark green to the yellowish, dirty white glacial flood of the

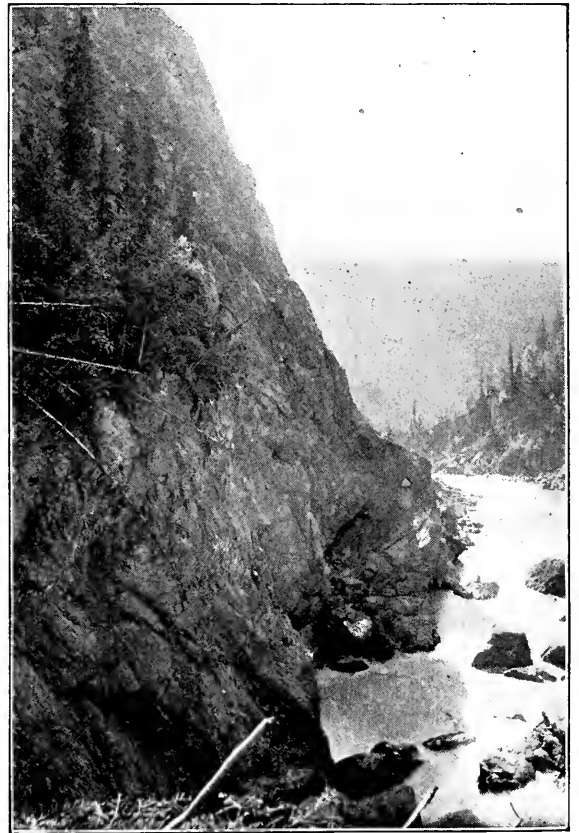

A GLIMPSE OF THE TAHLTAN RIVER, ALASKA.

Stickeen. This stream is never clear. Draining these many glaciers of their milky waters, and cutting away its banks of yellow clay and sand, its waters are well mixed ere they reach the sea.

Just before reaching Pt. Rothsay we met a number of fishermen; and pulling alongside one of their dories inquired as to their success. As a result of the day's work they had hundreds of big, fat salmon. These were principally the kisutch or silver salmon, and king, chonicha or quinnat salmon.

As we were pulling away, one of the fishermen tossed a magnificent king salmon into our boat, weighing at least 35 lbs, remarking as he did so, "there's your supper." I have no desire to excite the envy of my readers, but when camp was pitched that night, on one of the low, sparsely timbered islands, 5 miles farther on, juicy salmon roasts and thick, luscious steaks, disappeared in a manner most agreeable to tired, hungry men.

How different to eat one of these fish when just leaving the salt water, fat and fresh, from taking even the same fish, a year later, as dealt from a tin can.

Salmon were now plentiful in the river

principal growths. These are thickly underlined with willows, alders, and devils thumbs in such tangled masses, as to make it next to impossible to penetrate them.

The climate is moist and the heavy growth of moss that covers the earth, burying rocks and tree trunks in its slippery folds, makes an unsafe footing.

After passing the canyons, however, the country is much drier, and in many places rolls back into softly rounding but high hills. A perceptible change in the timber also takes place, birch and black pine becoming quite frequent.

One of the first objects of interest, on the way up the river, is the Popoff glacier. We



PHOTO BY A. J. STONE.

VIEW FROM THE GREAT GLACIER, STICKEEN RIVER, ALASKA.

and as we traveled up stream together, we feasted on them day and night. Whenever we hungered the cruel salmon hook would bring us food, fresh from the icy flood. The man in the prow, pole in hand, would lift a big salmon without checking the motion of the boat.

The principal tributaries of the Stickeen are the Iskoot, the Scud, the Porcupine, the Clearwater, the Tahltan, the Tooya, the Tanzilla, and the 3 South forks.

The principal glaciers are the Popoff, the Great, or Olebar, the Mud, the Flood and the Porcupine.

For more than 100 miles from its mouth, the Stickeen's narrow valley is shut in by precipitous mountain walls, whose white mantling never disappears. The banks of the stream are heavily wooded, spruce, hemlock, cottonwood, and cedar being the

viewed it from the opposite side of the river, some 2 miles from its base. Here the sun shines fairly on its deeply corrugated face, just where it forces its way down a steep incline, from among higher mountains beyond, and displays a great variety of shadings, or tintings, from its snowy crest to the deep blue of its lower strata.

Some 15 miles farther up, the Iskoot joins its waters with those of the Stickeen, cutting its way through the rugged and imposing Iskoot mountains, a branch of the Glacier range, to the South.

The Glacier range shows hundreds of glittering needle points, apparently shaped from blocks of snow and ice. RECREATION RANGE, so named in honor of the great magazine which sends out this expedition, lies farther inland and to the West of the Clearwater. This range is also clad in per-

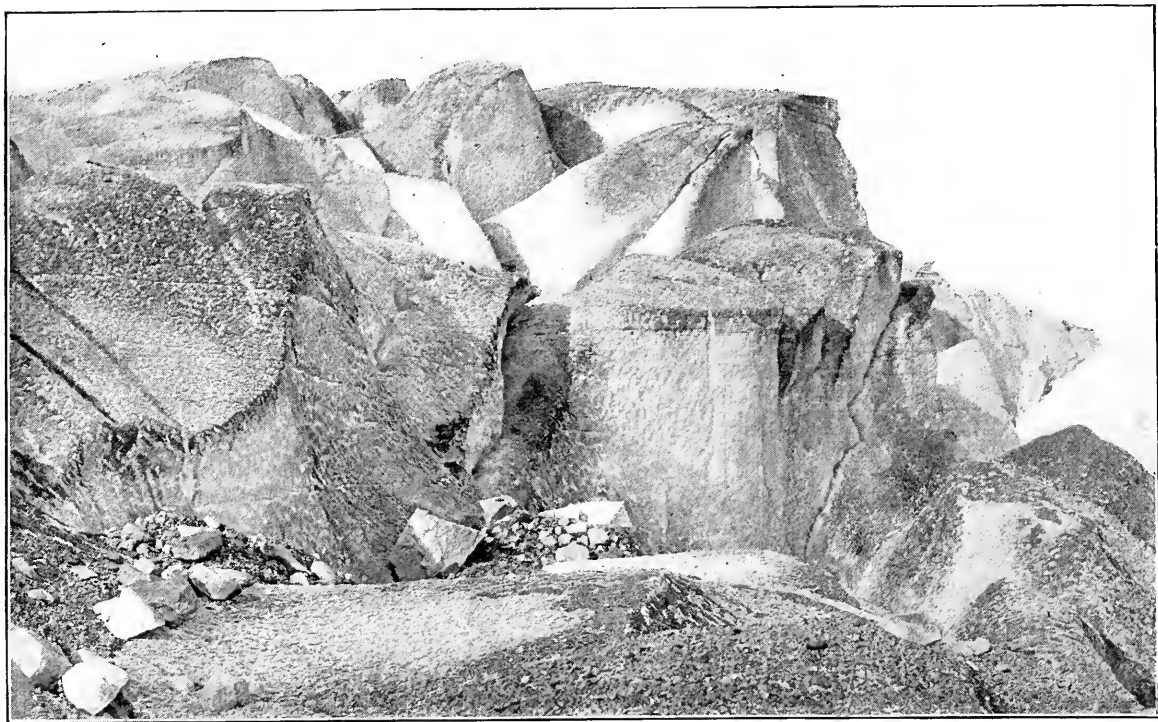

PART OF THE ICE FRONT, GREAT GLACIER, STICKEEN RIVER, ALASKA.

petual snow, is saw-tooth-like in appearance, and with the thin, soft veiling of fleecy clouds, like so many plumes of white, fluffy feathers, forever hovering over and about it, presents the grandest, most beautiful and bewildering picture to be found anywhere in the coast range.

The Iskoot is so large as often to be mistaken for the Stickeen, by canoemen unaccustomed to these waters, and several such parties have perished in trying to ascend it, believing they were yet on the Stickeen.

It is almost impossible to navigate the Iskoot, even with Indian canoes, except at most favorable stages of water. Throughout its first 50 miles it winds through deep, rocky gorges and canyons, cut through wild mountains, with many rapids and boulders to endanger navigation. The source of the stream is in a high, rolling plateau of softly undulating hills that stretches away in rear of the main coast range, Eastward toward the Rockies. Moose, caribou and mountain sheep, find in the regions of its head waters, fields unmolested by either the Indian or white hunter. Black bear are found throughout its entire limits, and the sitka, or big brown bear, in its lower districts. Goats are numerous in the high rocky districts near its mouth.

A short distance above the mouth of the Iskoot you sight the Great Glacier, until recently supposed to be the largest emptying into the Stickeen. It is often visited in small steamers, chartered by parties who leave the large mail steamers at Ft. Wrangle, and offers a most delightful and interesting excursion.

Here the tourist may have the satisfaction of walking and climbing over immense fields of ice, and of making an interesting collection of ferns, arctic mosses and pieces of wood that have been thrown out from underneath the glacier, where they have been traveling many centuries.

The ice cliffs composing the front of the glacier rise in most places, abruptly, 500 to 700 feet high. There are 3 or 4 places, however, where the climb to the upper levels is easily made.

From the surface the scene is a grand one. Looking up this great field of ice, as it stretches away and disappears in the bend of the mountain walls, you can scarcely realize that such a monster stream of ice has wound its way through the mountain range for more than 80 miles; yet such is the case. This glacier has never been fully explored, nor has its motion ever been recorded.

Two Russian army officers once came down from Sitka for the purpose of exploring it, to its source; but were never heard of afterward. They were supposed to have been lost in one of the many crevices that break the surface of the great ice field. It is deeply gashed and difficult to traverse. In places great granite boulders cover the surface; and at one point I found them piled high, in a confused mass, forming a ridge on the surface of the glacier more than a quarter of a mile in length.

Just in front of the ice wall, we found the snarled and twisted remnants of ancient tree trunks. Some of them were of immense size, their surfaces worn smooth by

being rolled over and over, for ages, under this great body of ice, until finally thrown out on the moraine.

Chief Shakes tells me that when his father first traveled on the Stickeen, this glacier extended to the river; and that he, himself, knew it when it was very much nearer than now. Just back of Buck's bar, on the opposite side of the river, facing the Great glacier, is another and much smaller one. Indian tradition has it, that many years ago the 2 met, forming a great arch over

from below, as proof of their having successfully passed through.

These old men were ever afterward held in the highest esteem by their tribal associates. Canoes were no longer carried around, but travelers passed up and down stream beneath the ice bridge until, in the course of many years, it gradually wasted away and tumbled into the river.

A few miles above the Great glacier, Mud or Dirt glacier pours through a defile, and still farther up is the Flood glacier. These first 4 are to the North of the river. The

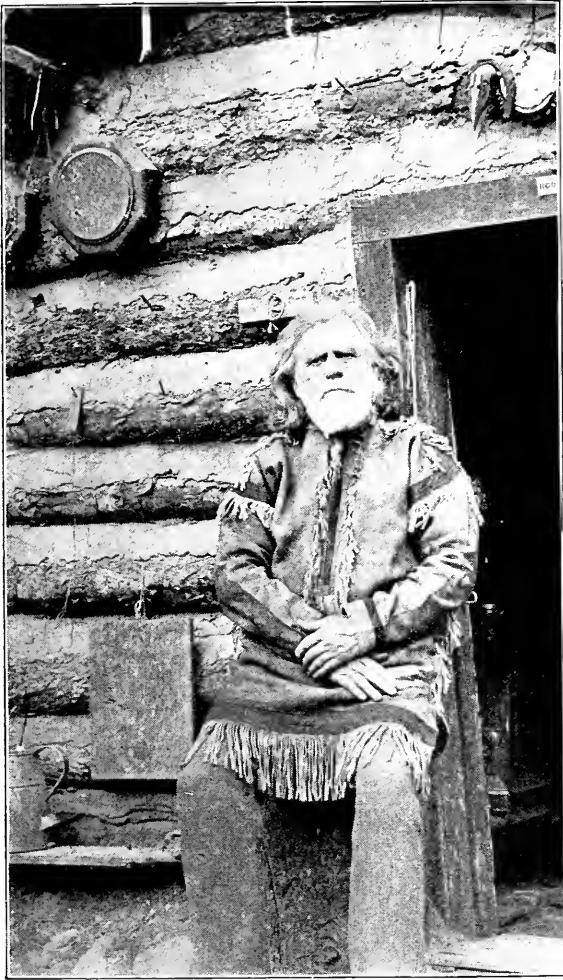

A FRIEND OF RECREATION'S EXPLORING EXPEDITION.

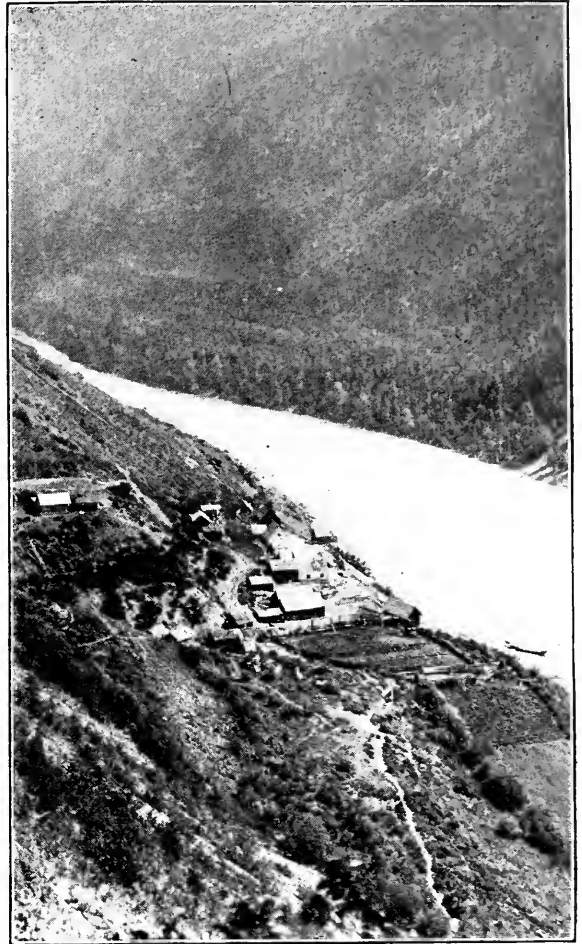

TELEGRAPH, ALASKA; THE ONLY "CITY" ON THE STICKEEN RIVER.

RECREATION has ten subscribers who get mail at this Post-Office.

the river several miles wide, around which the Indians carried their canoes and traps, over the ice. It is said that once, while a party of them were camped on the river's bank, just above this barrier, they concluded to put 2 of their number—"men who had grown worthless with age"—into a canoe and send them down stream, under the ice bridge, in order to ascertain if the passage could thus be made.

Imagine the surprise of the camp when, several hours later, these 2 aged canoemen came paddling back up the stream, bringing with them the green branches of trees,

Flood glacier is so named from its walls of ice, high up in the mountains, so formed as to shut in behind them the waters of a large lake. Several times this dam has been known to break, turning loose the waters of the lake and flooding the country below.

Last of the important glaciers is the Porcupine, which is South of the river and which is recognized as being the largest in the Stickeen region, though as yet but little known.

Beyond the Porcupine moraine is the



RECREATION RANGE, NEAR STICKEEN RIVER, ALASKA.

So named in honor of this magazine, by MR. A. J. STONE.

much dreaded canyon, a gorge  $\frac{2}{3}$  of a mile long, where the Stickeen river—often a mile in width—narrows in between high, perpendicular walls of granite to a width of 100 feet. The current here is terrific, the waters swirling and boiling in the wildest confusion.

Nothing but the most heroic effort on the part of every man in the canoe, finally landed us in an eddy above, completely exhausted. Our big canoe tossed about from side to side, danced back and forth and more than once turned almost around, seemingly as helpless as a feather, tossed by the wind.

Farther up we passed through the Kloocheman's, or Woman's canyon, so-called by the noble Stick, who, exhausted from paddling through the little canyon, here leaves the work of navigation entirely to his squaw.

Still farther on we worked our way over the big riffle and our last difficulty, in reaching the head of navigation, was passed.

We now reached the summer camps of the natives who fish in that great salmon stream, the Clearwater.

Here a much drier and wholly different climate sets in, and the country opens out, in many places, into high rolling uplands, the timber growth much smaller and the under brush less dense, entirely disappearing in places. Here you get a farewell view of RECREATION RANGE, on your way up stream, after having been in sight of it most of the time during 40 miles of travel.

We stopped at Shakesville, a place where our chief, "the master of the boat," dries his salmon catch. From there it is but a

few hours to Glenora, a queer little town, composed of a single row of low one story log houses, strung along the banks of the river for some distance, and now entirely deserted, by all its former inhabitants with the exception of the venerable Mr. Pritchett, the Canadian customs officer, from whom we obtained much valuable information.

Ten days from Wrangle we landed at Telegraph Creek, 12 miles above Glenora. This is 200 miles from Wrangle. Telegraph Creek is the head of navigation on the river and is the only trading post in the Stickeen river country. It has 2 general stores, 4 or 5 white and a few native residents.

It is a romantic little place, situated on the banks of the river; shut in from either side by deep canyon walls and facing the hills on the opposite side of the river which rise to such a height as to completely shut out the sun for 3 months, during the winter.

Here the Great canyon begins. Its formidable walls are cut from a solid bed of lava forming a gorge 60 miles long, through which no craft can travel. It is grand and beautiful in the extreme. In winter it forms an excellent highway for snow shoes and sledgemen, into the well stocked hunting grounds farther back, where moose and caribou abound.

The surveyors on this section of the Columbia overland telegraph route, which was to extend from Puget Sound through British N. W. Territory and Alaska, and to connect with a line on the Siberian coast by a cable through Bering straits, were here recalled, in 1866, after the announcement of the successful laying of the Atlantic cable.



RECREATION PEAK, NEAR STICKEEN RIVER, ALASKA.

So named in honor of this magazine, by MR. A. J. STONE.

A little creek empties into the river here, where the party was encamped and the place took the name of Telegraph Creek. It was at Glenora that the thousands of miners landed, in 1874, bound for the Cassiar district. It was from this place, by way of Telegraph Creek, that the Canadian government built a trail to Dease lake, for their accommodation. In that year 2,000 men produced \$1,000,000 in gold; and now the old Cassiar district is all but forgotten.

From Telegraph we traversed the country drained by the first South fork, reaching the high table land, 65 miles to the South, from which the Iskoot and the South fork take their course; the Iskoot making a graceful sweep to the West and then Northwest into the Stickeen. The South fork flows Northwest, into the Stickeen, 2 miles below Telegraph.

The plant life of this high plateau, which stretches away for many miles, in every direction, consists chiefly of mosses, though a few tiny willows are found in the low swales, and a few small, stunted pines grow in the canyons.

From the rear of this table land, rises a series of low mountain peaks or domes, some of which are completely buried beneath everlasting fields of snow and ice. Others are partially or completely exposed.

We visited a number of the latter and were surprised to find that in many cases a distinctive individuality in geological composition exists; one being composed largely of obsidian, mingled with broken masses of granite; another entirely of dark

gray granite; another a perfectly rounded dome of reddish felsite and yet another of dark colored shales and slates, mixed with lime stone.

Scattered along the beds of shallow ravines, that extend across the table land, parallel to each other and draining the fields of snow and ice, we found large quantities of lava, many pieces of which were nearly round and about the size of a man's head. They were honey combed, or perforated, and were so light as to float when thrown in the water.

We later passed some time on the Tahltan river, among the Tahltan Indians, at a point where they take their winter's supply of salmon. Here they construct lodges by means of small, leaning poles, for walls, and spruce bark for a covering.

The salmon are stripped and hung beneath the roof to dry, the natives sleeping on the ground, in the corners, with the fire in the centre for cooking. Near a number of these drying houses was a long beach, the rock and gravel of which were completely saturated, for weeks, with the blood of the slaughtered fish.

The fish, when dried, is not carried to the villages, but to the cache, or store house, of the family. In the timber scattered over the hills, in the country 2 to 5 miles from their village and drying station, each family has its cache where all surplus foods, blankets, guns, ammunition, etc., are stored; and here the stock of dried salmon is taken, every fall, to be drawn upon as needed.

They say that should the village burn

while its people were away in the Stick, on their big hunt, they would still have their food left.

The cache is constructed by placing in the ground, at right angles, 4 round posts, 8 to 10 feet high and usually occupying a space about 6 by 8 feet. On top of these 2 long logs are fastened, opposite each other. Across these a floor is made, of straight poles, carefully fitted to one another. On top of this a log house is built, about 4 feet above the floor, and covered with spruce bark. It is made sufficiently tight to shed snow and rain and the height puts the contents out of the reach of bears and wolves.

A striking illustration of the honesty of these people, and of the confidence they have in one another is given in the fact that natives have been known to starve, but never to rob one another's caches. They might pilfer the ictas (merchandise) of the white trader, from his place of business, but the personal effects of the white man they would not touch. All summer long the cabin in which we kept our supplies was left unlocked and we were away in the mountains for weeks, leaving expensive guns, field glasses, hunting knives, ammunition, and many other articles an Indian would delight in; but they were never disturbed. These Indians, as well as all others, like the best of a trade, but they will not steal.

When we were in camp on the Tahltan these people had just commenced carrying their dried fish to the cache. Old, feeble men and women, and small children, all joined the middle aged and the strong, on the trail to the cache. Each carried a bale as large as he could manage, and as they climbed the high bluff, from the drying station at the river's edge, winding in single file back and forth along the crooked trail, the entire party joined in a monotonous chant.

I learned that this same song was always used on departing from or returning to the village and they told me it denoted happiness, or at least contentment.

As showing the thriftiness of the Tahltans I will relate an incident that occurred while traveling in their country. We had pitched camp one evening on a long, dry beach, shut in by high, dry lava walls. There were 2 or 3 acres of this little level tract and about 100 yards from where we made our halt, several native families were camping. We threw our duffle on the ground and opened it out promiscuously. Among my traps was a small case in which I carried a comb, a brush, and other things, including a number of papers of needles, put up in fancy wrappers that I had brought along to use in trading with the natives.

Fuel here was scarce and while Ed. and our Indian, Billy, were picking up some small dead branches, left by some previous camper, with which to start a fire, I went to skirmish for wood. After searching al-

most every part of the little flat, I finally found a good dry stick that was about as large as I could carry. It was the only stick of wood I could find.

It was soon blazing on the camp fire and the heat from it was just browning the pan bread, when a stalwart Indian, somewhat past the middle age, came walking hurriedly up to camp, looked us over, then looked at the fire and with an expression of anger depicted in his face, commenced talking to Billy. The latter told me this man claimed the wood. He said wood was very scarce there, and was secured at the expense of great labor, by the Indians, who had gone several miles up stream to gather and float it down. The old man demanded that we take this wood from the fire and return it to him.

I told him, through my interpreter, that I was sorry we had made the mistake, but that the wood was burning and could not now be returned if we wished; but our visitor grew only the more angry. No argument I could offer had any effect on him.

Finally, I stepped over to my pack, took out a paper of needles and offered them to him. This saved our wood and our supper. He took the needles and examined them carefully. The expression on his face brightened. He shook me by the hand and then hurried away to show them to his kloochman.

I now felt sure the wood was ours; but imagine my surprise when, in a few minutes, another Indian appeared on the scene and claimed the same stick of wood! He wore, if possible, a more angry and foreboding look than his predecessor. Again we parleyed but it was no go. The old Indian grew wild and seemed determined to have the wood. Supper was almost ready and we were all very hungry. I therefore closed the argument by again paying for the wood, with another paper of needles, and receiving the old man's blessing.

When the bread was baked we drew from the fire the remnants of the log, believing it was now doubly our property and knowing we should need it in the morning. We were just comfortably seated at our evening meal, when to our astonishment, up bobbed a third claimant. This one acted differently. He sat down on the ground, some distance away, and contented himself with eyeing us while we ate. He wore a sad, dejected look and acted as though he realized he was too late to run a successful bluff. He was not so well supplied with nerve, and was not so capable of pushing a business proposition as the men who had come before him.

Finally he came around and examined our guns and other traps. He expressed great surprise at all he saw. He placed my 12 pound rifle to his shoulder and sighted along the barrel. Then he took from my cartridge belt a 45-100-550 Sharps special,



and examined it with profound astonishment. Finally, pointing to the cartridge and then to some hills, several miles distant, he signaled his faith in this great engine of death.

The little open box containing the needles finally caught his eye. That was the thing. It was the wonder of wonders. He stooped low over the box and examined it from every side. Then he very cautiously lifted a package of the needles, looked at them and carefully replaced them. Standing erect he now gazed at me, and then at the needles. All this time not a word had been spoken, but that face—what a study

with different members of this tribe and learned much of their history. They are the only tribe living on the Stickeen and number 270 souls. The Sticks, from Ft. Wrangle, hunt the lower Stickeen but have no homes there.

The Tahltans are tall, slender and athletic; good travelers and good hunters. They produce, annually, in addition to other furs, about 100 silver foxes, or 1-14 of the world's output.

The Tahltans live in comfortable log houses, or rancheries, covered with boards. Many of the houses are also partially or completely floored with rough pine boards,

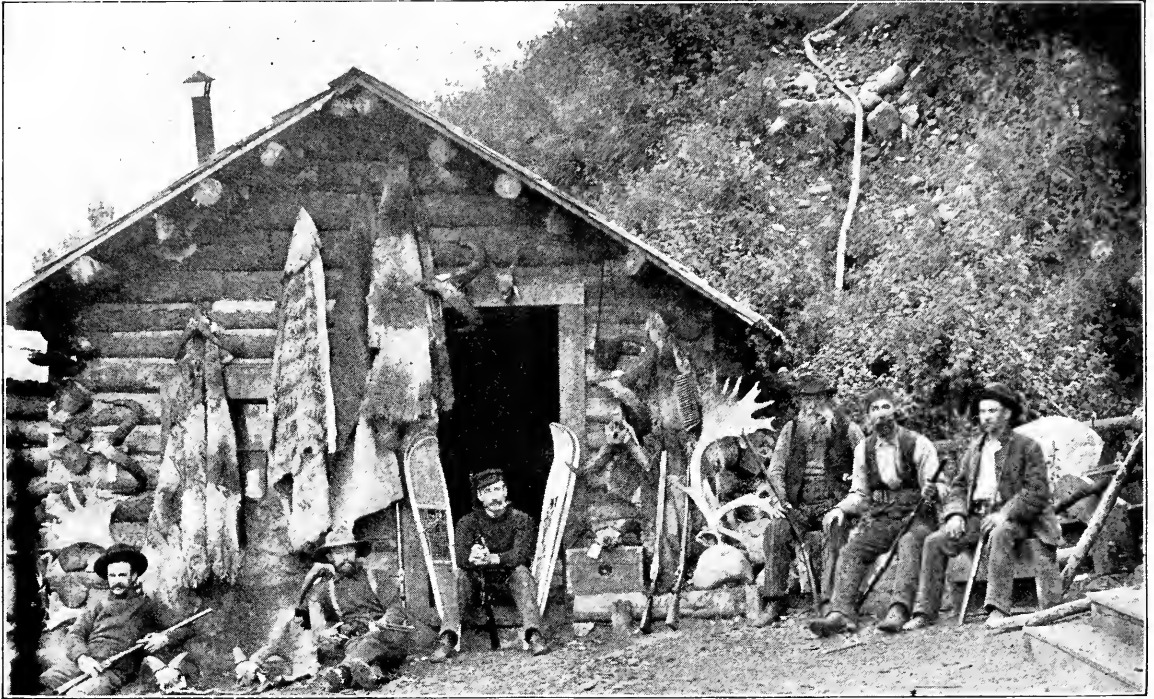

HOME CAMP, RECREATION'S EXPLORING EXPEDITION.

Head of Canoe Navigation, Stickeen River, Alaska.

for an artist! Expressions of wonder, amazement, curiosity, delight, doubt, anxiety, hope, expectation, all followed one another over it with the greatest rapidity.

He was no ordinary business man. He was a diplomat, and he won his case by the practice of native sagacity and cunning. I walked over to the pack, gave him a paper of needles and his delight and gratitude were unbounded.

So ended the embarrassment of the early evening. It had been converted into an unusually interesting entertainment, affording me a most excellent opportunity for a study of the character and expressions of these simple minded people. Later in the fall I met in camp this same outfit on the same camp ground, and they brought us wood and tent poles to burn. They did not ask for pay. We were friends now.

I spent many evenings in conversation

with different members of this tribe and learned much of their history. They are the only tribe living on the Stickeen and number 270 souls. The Sticks, from Ft. Wrangle, hunt the lower Stickeen but have no homes there.

The Tahltans are tall, slender and athletic; good travelers and good hunters. They produce, annually, in addition to other furs, about 100 silver foxes, or 1-14 of the world's output.

The Tahltans live in comfortable log houses, or rancheries, covered with boards. Many of the houses are also partially or completely floored with rough pine boards,

The Tahltans no longer recognize a chief,

but those who are ambitious to become prominent in the tribe, must buy such honors. To do this means hard work, self-denial and the exercise of good judgment.

When one of these fellows determines to become a *Ti-ye*, or great man, among his people, he puts forth extra efforts in the pursuit of furs. He becomes economical in his living expenses, and allows no opportunity to pass by which he may add to his stores.

At the end of the season's hunt, he brings his catch to the trader, squares accounts, and, if his efforts have been rewarded and a balance is due him, he receives this balance in blankets, guns, muslin, and tobacco. These are taken to his cache and carefully put away. Fortunate hunters have been known to accumulate, in one year, \$500 worth of this truck, though rarely more than \$100, and generally less. The deposit is added to during a period of 5 to 20 years, according to his success and ambition.

When finally satisfied that his wealth is sufficient with which to buy the honors he wishes, his goods are all brought to some place convenient to his *rancharie*, and invitations are sent to all those he desires present, generally the entire village population.

A *rancharie* is usually about 30 or 40 feet square, with but one entrance.

When the time arrives for the ceremonies of the potlatch to begin, the host takes the seat of honor, at the rear of the room, facing the door. Several young men are appointed to act as a reception committee and to seat the guests as indicated by the host. His chosen friends and the most distinguished men are seated at the immediate right and left of the host, and the others are disposed of according to their social importance. Those of but little consideration are seated, or left standing, near the door. Pipes and tobacco are now distributed alike to all present, and while the smoke proceeds the ushers bring the goods to be distributed, piling them in a confused mass in the centre of the room.

When all are brought the host makes a speech, expressive of his good will toward his fellow men and of his desire to honor them as is their due. Then begins the distribution of gifts, the ushers delivering the parcels after his directions. The value of the gifts depends entirely on the goods accumulated and on the number of guests present. If the donor has been successful in all probability the present to the first man on his right will be 5 blankets and a rifle. This latter is always a Winchester—they know no other. The man on the left will get 4 blankets and a rifle, and so on down.

When nearing the door, or entrance, 10 yards of muslin is usually given, and to those immediately next to the entrance, only one yard of muslin is allotted. Every-

one accepts his position and his gift without question, and all express profound thanks. Many of the more prominent guests, make short, enthusiastic speeches in honor of the now great and influential man—the big *Ti-ye*.

Social etiquette demands that whenever one of these guests gives a potlatch he must invite the present master of ceremonies and give him 2 like articles for each one received here.

The Tahltan and the Tooya rivers are 2 of the few tributaries of the Stickeen not

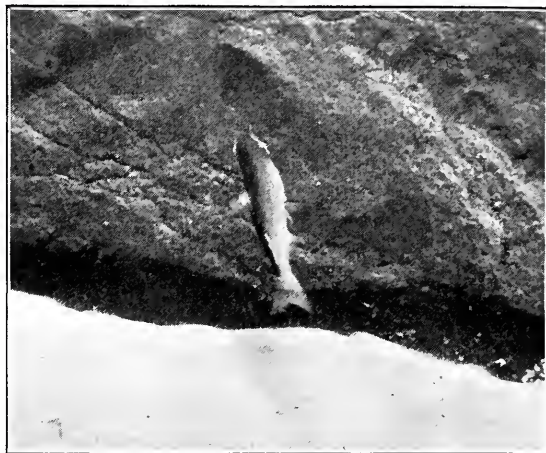

THE LEAPING SALMON.

fed by glaciers. From the Tahltan to the Tooya our route followed high, dry ridges; and on making our descent into the canyon of the Tooya I thought, for a time, the river would never be reached. Down, down, we went, zig-zagging back and forth as though on a winding stairway; and the climb on the other side of the river was equally long and tedious.

The canyon of the Tooya is the grandest, boldest, and most picturesque illustration of Nature's carving to be seen anywhere within the Stickeen basin. In many places solid granite walls rise to a perpendicular height of more than 1,000 feet. At one place, facing one of these from the opposite side of the river, equally imposing and far more interesting, was a wall composed of a great many different layers, of as many different formations. Each layer presented a distinct color. There were subdued shades of pink, ecru, red, slate, and green.

Along the crest of these high walls grows a lace-like fringe of the slender, graceful black pine, just back of which rises, one upon another, great high benches, up which our path wound through scattered clumps of stunted pines.

In many places sections from the granite walls have tumbled into the narrow channel of the river and dammed it to a height of 50 feet. Through these obstructions it forces its way in torrents of foam and spray.

At every point we visited the river came pouring through these beds of rocks, yet the monster king and silver salmon, would continue to fight their way up stream, seeming to, in some way, surmount every obstacle. I spent several days watching the salmon, and was astounded at the wonderful pugnacity with which they fight their way to the source of the river. I have seen them repeatedly attempt the passage of a certain fall until, completely exhausted, they would retire to some convenient eddy for rest, preparatory to a renewed effort; but never have I seen one of them give any indication of surrender, or show inclination to return down stream. What a lesson to doubtful, weakened, and discouraged humanity! What a striking illustration of the determined effort necessary for the human traveler through this Northern wilderness.

Among a number of salmon taken from the Tooya, the noses of several were battered or torn off against the rocks. I managed to get pictures of several salmon during their efforts to clear the falls.

The source of the Tooya is in a large lake, to the North, near Level mountain. This mountain is also the home of the woodland caribou.

From the Tooya we passed over a stretch of high land, through forests of small spruce and black pine, 35 miles to the Tazilla, the last important tributary of the Stickeen from the North. Crossing the Tazilla into the Hoo-tai-luh mountains, we pitched camp, for several days, on a high, rolling, moss covered plain. From this camp we climbed a high, rocky knoll, from which we could overlook a country drained by the Stickeen, the Yukon, and the Mackenzie, which empty their waters, respectively, into the Pacific ocean, Bering sea, and the Arctic ocean.

Wherever we went, on this mountain we found it covered with a deep, spongy moss, thickly studded with tiny flowers of every conceivable color and shape. Small groves of balsam grew here and there, and their branches made soft sweet scented beds.

Returning to Telegraph Creek we made several long journeys into the mountains, in various directions. Black bear are fairly plentiful throughout the entire Stickeen region. The grizzly is found on its head waters and the sitka, or big brown bear, in the lower river country.

Goats are plentiful in the mountain adjacent the river, as far up as the little canyon, or 100 miles from the coast, but are not numerous above that point. Sheep

are found in the Chee-on-nee and Et se-zah mountains, to the South of Telegraph. Moose and caribou are in fair numbers in the whole of the upper country, but are rarely found below the canyon or on the coast side of the range.

The moose confine themselves to certain general territories, but not so closely to any particular locality as do the caribou. The former are great travelers and are known to indulge in some peculiar cross country runs.

Spruce or Canada grouse are plentiful in some of the timbered districts, and willow and rock ptarmigan are found on the higher stretches of country.

Any ambitious sportsman, who may make a trip up the Stickeen in July, returning in late fall, will be richly rewarded. He will have opportunities to get bear, moose, caribou, sheep, and goats.

Telegraph Creek is the best point to hunt from and parties going could secure comfortable passage on the "Alaska," a small steamer that plies the Stickeen from Ft. Wrangle.

At Telegraph Creek can also be had blankets and provisions of all kinds necessary for the hunt. This would obviate the necessity of carrying much luggage. Here, too, the traders will provide you a cabin to camp in and will take the best of care of you. If you want a guide they will select for you a young Indian, who is trusty, a good hunter, and a good camp maker.

Captain Callbreath, of the Alaska, makes the trip pleasant for people traveling with him and gives them a chance to visit some of the glaciers and other points of interest on the river. You can shoot bald eagles from the deck of the steamer, as they sit in the lofty cottonwoods that line the stream, or as they pass over. You can take salmon, with an Indian salmon pole, weighing 20 to 65 pounds. You can bring home some fine game heads, Indian curios, beautiful specimens of lichens, mosses, and arctic flowers. You will see little wax-like buttercups, just showing their heads along the edges of snow and ice, in August. You can sleep on sweet scented camp beds, made of spruce and balsam, drink pure water and breathe pure air; and you will return home with renewed health and vigor.

A delightful route to Alaska, from the East, is via the New York Central, the Grand Trunk, through Canada and Michigan, the Chicago, Milwaukee, and St. Paul, the Northern Pacific Railway to Seattle and thence by the Pacific Coast Steamship Company's steamers.



"AS SOON AS OLD PETE HEARD THE BELL TINKLE, HE PROCEEDED TO CUT HER OUT."

## "PETE."

H. A. HORTON.

Pete was only an aged cow-pony, when I became acquainted with him; but what a good companion he was! He was brought up to the mine for my use, from the ranch down near Orchard, where he had been raised and thoroughly instructed in his profession. He had a well developed vein of humor, which would come to the surface just at the time when it was not wanted. He was also proud of his education, and

The "ghost had walked" a few days before the friends arrived, and, knowing there was a tender spot in the makeup of most ladies for candy, I had sent down to the city for a 5 pound box. The visitors had been with us 2 days when one of the men brought me word there was an express parcel for me, at the office. I went out to get Pete, and while cinching on the saddle told him what I was going after; the hopes



"I PLAYED MULE; HE WAS THE BOAT AND I TOWED HIM."

without asking one's permission would display it. One day our friendship was broken: and although Pete was thoroughly repentant, after the occurrence, it was a long while before we were back on the old terms again.

Some company came up to see us, among whom was one of the brightest young ladies I ever had the pleasure of meeting. She could shoot and cast a fly, and as for riding, it was a picture to see her come across the flat, on her pony, her hair streaming out behind, quirt flying and the pony going as only they do when the "brush" is in sight and the "pack" in full cry.

I had, in connection with the bundle, and for gracious sake not to make an exhibition of me. But fate was against me. As I pulled up in front of the house to take some letters with me, to mail, I noticed some cattle on the side of the mountain. As soon as old Pete heard the cow-bell tinkle which was on one of the critters he proceeded to "cut" her out. The drama was well staged and the audience was vociferous in its applause. Pete was the hero, the bell-cow the villain, I the unwilling comedian, the cattle the populace.

I didn't want the cow, but as Pete was so determined about it he had his own way. I tried to convince him he had come on be-

fore his "cue" had been given, but it was no go—he cut.

To be sure it was only a curtain raiser, but it was a dandy. When I left him he was doing his part well. The curtain had become hung up, some way, and I made a hasty exit over Pete's tail and walked down to the office, after the candy.

The following spring, when the warm spell came on and the willows and cottonwoods had fuzzed up, one of those itching spells came on me. For the partial allayment of this I pulled out my fly book, rod

taken the antidote and felt well again. How I did enjoy it! The delicious air was like champagne, just opened, and made me feel as though I could fly. The beautiful little meadow, with the brook running through it, singing its song of gladness because grim old winter had gone, and the grand mountains rising on either side, clothed with spruce which mercenary vandals had not reached as yet, were as a dream of elysium.

But food does not grow on trees, out that way, and not being herbivorous, like my



"HE HESITATED A MOMENT, AND CAUTIOUSLY STARTED."

and line and went out and talked it over with Pete, with whom I had become friendly again. We came to a mutual agreement that the only cure was to go over to the Park and try the trout. We went—rather I went and Pete followed. I played mule; he was the boat and I towed him over the divide in true Erie canal style. I carried the bridle over my shoulder, pulling for all I was worth, while Pete's nose, the top of his head, his back and tail formed a good illustration of what a straight line should be.

We had 2 glorious days in the Park. To be sure I caught but one little trout and he was returned whence he came; but I had

friend Pete, I reluctantly pulled up and started for home. Pete expostulated with me, the best he could, for he wanted to stay and burst his sides with the fresh grass, in which he had wallowed with true equine delight. But I didn't see it that way.

Poor old Pete! I wonder if he felt he was starting on a long, unknown journey. I don't think he did, for a more frisky old horse never trod the range. As we got up to the top of the range we found it had been snowing and the trail was extremely slippery. I walked for I knew it would make better traveling for him. A more careful fellow I never saw. In fact, he traveled as though he had been bred in the

mountain. Coming to a greasy spot, in the trail, he would squat down and slide, after the manner of a small boy going down an incline, on a barrel stave. Pete didn't have a stave, but only that with which Dame Nature had provided him.

We had come to a portion of the trail which was extremely dangerous. It was a heavy down grade, of smooth rock, and a corner had to be turned at a sharp angle. On one side the rock dropped off into the canyon. On the other it rose so steeply that only a mountain sheep could hold on. Pete didn't like it. Neither did I, but we couldn't go around. He hesitated a moment and cautiously started. He went all right a short distance, but I saw he could not hold himself. His shoes were worn smooth, and were almost as good a toboggan as the barrel stave. He had, by this time, obtained such headway that I saw he could never turn the corner and that it was

all day with him. He realized it too, I think; for just before he went over the edge he gave me a backward look that I shall never forget. When I had climbed down to where he lay he was dead.

\* \* \*

It was noon the following day before I had finished the cairn over him, for I was determined nothing should disturb his body if I could help it. I was only sorry I could not do better by him.

His memory is green beside that of the homeliest and best dog I ever had, who was cruelly poisoned and who came home to die. I am not bloodthirsty but there are times when one feels murder is justified.

But why dwell; I know that when the time comes for me to "cash in" and go over the great divide the first being to greet me will be Commodore, his stubby tail wagging merrily; and Pete will be a good second.



### RECORD BUFFALO HEADS.

The man who first began to judge buffalo heads by measuring their horns, should have been called down off the ladder before the silly fashion was set. To

ignore the bulk of a buffalo head and the hair that adorns it, and to base everything on the measurements of the horns, is simply absurd. If persisted in, it is inexcusable; and the cut on the cover of *MAY RECREATION* is all I need in proof of this assertion. The big horns are there, but, heavens! what hair! The head looks as if it had been industriously trimmed, by one of those infernal barbers who insist on cutting your hair shorter than you want it—even when you have none to spare.

The glory of a buffalo head lies in its hair,—the length, the texture, and the color of it. Next in importance is the actual bulk of the head. Nobody, that I ever saw, cares a rap about the horns, so long as they are perfect in shape and symmetry. If the tumble of wavy, chestnut-brown tufts, in the frontlet, is sufficiently luxuriant to half bury the horns, so much the better. The horns of a buffalo are no more an index to his greatness, or his beauty, than are the ears of a Dublin donkey. It would be just as sensible to measure front teeth, to find the prize winner in a beauty show, as to measure horns to find the finest bison head.

As an illustration of what I consider a superlatively fine buffalo head, and one which I challenge the world to surpass in real magnificence, I will ask the editor of *RECREATION* to reproduce the head of the big bull that forms the principal figure in the group of buffaloes in the National Museum.

W. T. H.

It is shown herewith.—EDITOR.

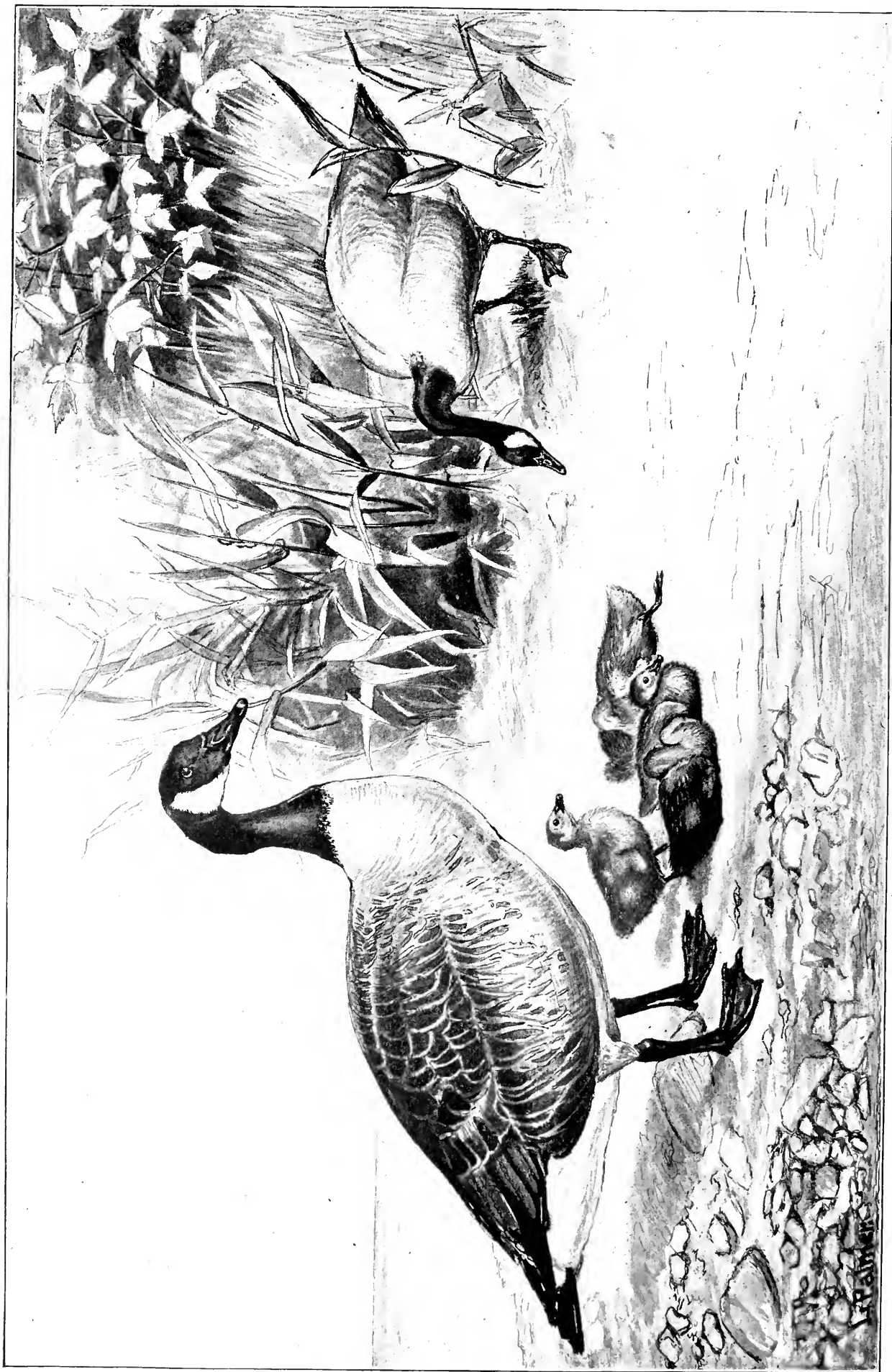

THE CANADA GOOSE (*BRANTA CANADENSIS*).



## MY WIFE'S MOOSE.

W. E. BEMIS.

We had fished for bass and hunted for partridges a number of seasons; my wife had learned to handle her rod and shotgun with skill, but we longed to try our hands on big game. Thus it happened, that the last week in September, 2 innocents were fairly started for Will Atkins' camps, on the headwaters of the Aroostook river, in

with clothing and actual necessities. These rubber bags are almost indispensable, taking, as they do, everything from a camera to toilet articles. What is more important, they keep them dry, too.

A 3-mile drive brought us to the river, where we found 2 canoes, very cranky affairs, of cedar, canvas covered, with small



ON THE AROOSTOOK RIVER.

Northern Maine. The camps are 50 miles from Masardis, the nearest railroad point. One rainy afternoon we left the caboose of a way-freight, at this station, where we were met by our guide.

A drive of 12 miles, through a drenching rain, brought us to a place called Oxbow, the end of civilization, where an old-fashioned farm house had been turned into a postoffice and hotel. Here an excellent supper and the cheerful glow of a log fire, revived our dampened spirits. I learned during the evening, we were to be "poled" up the Aroostook river about 40 miles. It was necessary to have 2 canoes and a second guide.

The next morning, having dressed for the woods, we packed 2 rubber navy bags

seats in the bows. With Spinney to guide my wife, and Fred, long pole in hand, standing erect in the stern of my canoe, we were off with a shove that sent us out into the current.

I vowed I would learn the trick of poling; but after several disastrous attempts, was forced to admit as a poler I am not a success. It is wonderful how far an experienced boatman can send his canoe with one shove; and how, poling from one side only, he pushes around rocks and through eddies. At 2 o'clock we arrived at Salmon pool camp, where we remained for the night.

We made an early start, the next morning, and after covering 14 miles, arrived at the lean-to. Here we had our first meal



BACK CAMP, CHANDLER LAKE, ME. MR. AND MRS. BEMIS AND GUIDE.

over a camp-fire; and the moose-bird, or Canada jay, came and made friends with us, and ate off the same board.

There was no time to linger, so we were soon on our way again. With 10 miles to our credit, night came on as we approached the falls. The guides were to "carry" and to work the canoes up, while we were to follow a path through the woods, to a point above the falls.

It was dark, but my wife and I felt our way along, until, somehow, we lost the path. The thought of spending a night in the woods was anything but pleasant. We were grateful indeed when the light of the moon came through the trees; for by its aid we managed to reach the river. We could not see the falls, nor did we know whether the guides had gone on ahead; but no more forest for us. On the bank of that river we would stay until called for. Soon we heard the men coming, having been delayed, in patching one of the canoes.

Two miles farther we glided into Round pond, and the poles were lain aside for the paddles. To go suddenly from the rushing river, with the splashing and pounding of brass-pointed poles, into smooth water, and on such a night, was delightful. A glorious moon turning the foliage to silver; not a sound from any living thing; not the rustle of a leaf, nor even the air stirring; not a sound from the paddle, not so much as a drop of water. Never until that moment had I realized what is meant by stillness.

Soon we came to a dam, over which we

carried, and Millnocket lake spread out before us.

The canoes were paddled swiftly toward an island in the centre. A light appeared; then another and another. Fred said, "Camp," and I was glad, for I was cold and hungry. Our host was at one of the back camps, but his wife expected us. A cabin had been prepared and a log fire awaited us.

It rained steadily the next 2 days, so we simply rested. When Atkins returned he explained the situation of the back camps, and I consulted him as to which would be the best for moose. All but 2 were occupied. One, an old logging camp, at Chandler lake, was very rough, but in a good game country, where practically no hunting had been done. I decided on this.

After breakfast, the 3d morning, our little party started. Soon we crossed the lake, took a parting shot at 2 screaming loons, beached our canoes, and, loaded down with packs, plunged, Indian file, into the woods on a tramp of 9 miles. We were now in the country of big game, and life in the woods was a fact.

Evidences of game were seen all along the trail. Here a big bull moose, there a cow, then a buck and a doe, occasionally a caribou. Stopping now and then to study a fresh track, while our guides explained it all, learning at every step something of game, the day passed; and it was a day never to be forgotten.

At 5 o'clock the dead water of Chandler lake was reached. Here was a canoe, into

which we placed our packs. My wife got in with Spinney and started up the dead water. Fred and I had 2 miles to go, through the woods, to meet them at the upper end.

Just as the sun was setting, we approached the water, at an opening in the woods. A splash and the click of a reel were heard, and then I saw my wife, very much excited, her fly rod bent nearly double, her reel running away from her, while down stream there was a swirl and a splash. She certainly had hold of something. The guide and I sat on a log and watched the sport.

It was her first big trout. Three times she brought him to the canoe, not so bad, for the water was filled with stumps, rocks, and tree tops. The landing-net had been forgotten, and the guide could not land him. Each time he got away with a rush. With my wife standing in a cranky canoe, scolding her guide—he, poor fellow, having his hands full to keep the canoe from upsetting—it was sport indeed. The 4th time she brought her trout up he laid over on his side, and they took him in.

Once more she made a cast, and had a rise; a 2d cast and she hooked another. Profiting by her experience with the 1st trout, she soon landed this one. I got the scales from the pack and weighed them. The first weighed exactly 3, the other 2¾ pounds.

They were the largest brook trout I had ever seen. These, with the signs of big game all around, made me feel we had indeed come to the right place.

It was almost dark when we arrived at camp. A more forlorn looking place I never had seen. A cabin of rough logs having 2 small windows, partly closed with pieces of glass; flooring of round logs, with spaces between; rough beds covered with fir boughs; a board across 2 barrels for a table; a barrel of flour and some salt pork, the provisions. One good thing was a stove, in which we soon had a fire. Then with the lamp lighted, biscuits in the oven and trout frying, our dismal quarters assumed a more cheerful air.

Our first morning in the wilderness was warm and pleasant. A few yards away lay Chandler lake, 3 miles long and one wide.

Here was a 2d canoe, so it was decided that my wife and Spinney should explore the lake while Fred and I hunted along the dead water. On the way to our canoe 3 deer were started, but they were too quick for me. I saw their flags, then they were gone; noiselessly, swiftly, like shadows. By the time we were afloat I was pretty well excited. I fully expected to meet a whole menagerie at every step. It was a remarkable morning. Fred said "everything is coming our way."

We paddled slowly down the stream; a narrow strip of water 2 miles long, wind-

ing in and out of a big marsh. The forest grew to the edge and game trails led to the water. At a clear spot of several acres the water was covered with lily-pads; and many of the succulent roots had been pulled up and partly eaten by moose.

An hour passed; cautiously the boat was paddled in and out through the marsh. I sat in the bow with rifle across my knees; ready. A blue heron rose and flapped slowly away. Two ducks that we disturbed rose with a splash. Each time I had a sudden chill, and thought of buck fever.

"Deer; straight ahead!" Fred suddenly whispered. Fully ¼ of a mile away, I saw my 1st deer, a black-eared doe. Then commenced an exciting time. The guide paddled swiftly and noiselessly, nearer and nearer. The deer grew suspicious, cocked her ears, turned and looked at us. Fred stopped paddling and I was almost afraid to breathe. She was satisfied and began to feed. The instant her head went down, Fred began paddling. Again and again she looked up, and our actions were repeated.

Finally I whispered to the guide to let me shoot, but he would not. Nearer and nearer until she threw up her head and was off like a flash, disappearing behind a projecting point, and my opportunity was lost. Slowly Fred worked the canoe around the point. It was an exciting moment, for I knew the instant the bow turned the point, we should be in full view, and I must shoot quickly or not at all. I did not see the deer where I expected to, but farther back. I saw her going, and fired. "You've hit her," my companion called out. We quickly reached the shore. He found no blood, but so many tracks he gave it up. "It was a hard shot," he said, trying to let me down easy.

I was not satisfied, however, and wanted to see for myself. Just as I, too, had given it up, Fred called me, and there was my 1st big game, dead, with a bullet hole through the left shoulder.

Starting back to camp, we had gone only a short distance, when the guide whispered, "There's your moose!" In a clearing at the water's edge was a cow moose and 2 calves, feeding. To me, it was a wonderful sight. The canoe was pushed behind some alders, and I waited for the bull; but he did not come. Soon the cow winded us and moved off with her family.

The days passed. We fished for trout, and still hunted in the daytime, and called for moose at night; but there was not another morning equal to the first. I killed my second deer, and altogether the luck seemed to be with me. Though my wife had to her credit the largest trout and a number of grouse, her big game was one hedgehog. She had seen a buck, but was so paralyzed at the sight, he disappeared before she could shoot.



MRS. BEMIS AND HER MOOSE.

Spinney was sent to the home camp for supplies, one day. It happened, very fortunately, for my wife and I hunted together the night her moose was called. At sundown we started for the dead water, taking blankets with us, for the night was cold. My wife was to do the shooting, and I was to take a hand only if necessary. Wrapped in a blanket, she sat in the bow. The guide fastened the jack to the stick at her left, and she practiced at opening the shutter until she was able to do it noiselessly.

Although we had called 4 nights, without success, an indefinable something seemed to whisper this would be our great night. The guide picked out a likely spot, pushed the bow of the canoe on the edge of the bog, facing up wind, where he could get away easily, took a drink of water to clear his throat, and picked up his moose horn.

How that 1st call sounded on the still night air! It fairly startled me. The notes went out over the marsh and were echoed back to us from the surrounding hills. Any moose within 5 miles surely heard it. Fred gave the second call and then the last. We waited and listened, our ears strained to catch the slightest sound. Calling at intervals of 20 minutes, an hour passed and darkness settled. No answer, not a sound, save those created in imagination, and the occasional splash of beavers as they came out around us.

Fred thought he heard a deer in the water, and paddled out to investigate. We had gone only a short distance when we were startled by a terrific crash behind us.

Our bull was coming across the marsh, grunting at every step. I could hear the ring of his horns as they struck the trees, and the splashing as he stepped into water. Never had I heard anything like it.

As the canoe moved nearer, every grunt sounded louder, until it seemed as if I could almost touch him. My wife tremblingly whispered she was "too frightened to shoot," and begged the guide not to go nearer. I whispered a word of encouragement I did not feel.

When it is considered she was 8 feet nearer than I, and 18 nearer than the guide, and being rapidly pushed toward a snorting bull moose she could not see, it is no wonder she trembled. The old fellow stopped grunting and seemed to be going away. It was a critical moment. Fred picked up his horn, gave a little coaxing call, at which the bull came on again, grunting.

"Open the jack," Fred ordered. At the words my wife recovered her nerve. She carefully laid her rifle on her lap and noiselessly opened the jack.

"I see his eyes," she whispered.

"Shoot! Shoot!" I cried. She raised her rifle, aimed between his eyes and then said, aloud, in her excitement, "That's too high." She calmly lowered her rifle, raised it again, aiming at his shoulder, which she could see dimly outlined, and fired. Throwing out the shell, she fired again, then 3 times in quick succession in the direction of the noise made by the retreating moose.

I did not think for a moment she had hit him; and when I heard him going away, I



HEAD OF MOOSE KILLED BY MRS. BEMIS.

thought he was lost. Up to this time I had not seen him. I stood up in the canoe, in my anxiety to get a shot, and to this day I wonder how Fred kept it from upsetting.

All was still. A brook emptied into the dead water at this spot, very shallow, with a mud bottom. Slowly the guide paddled up the brook, my wife throwing the light on shore; but we could not see anything of our game. Turning and coming back, close to the shore, Fred lost his paddle and the canoe grounded in the soft mud. Fifteen feet from the bow, the moose suddenly loomed up like a huge spectre, and charged.

In my dreams I even yet sometimes hear the guide's shrill command: "Fill him! Fill him!" I can hear my wife's last shot, which broke the animal's leg and brought him down. I can see her throwing out imaginary shells for several minutes after her magazine was empty, the shot that broke his leg being her last.

Using the moose horn for a paddle, the guide finally succeeded in getting the canoe off and we floated into deep water. After some minutes, all being quiet, Fred, protesting meanwhile, took us ashore. With jack in hand, we went carefully over the marsh until we came upon the moose, dead. Only 2 shots hit him; the first through the shoulder, and the last, a fortunate one, broke his leg.

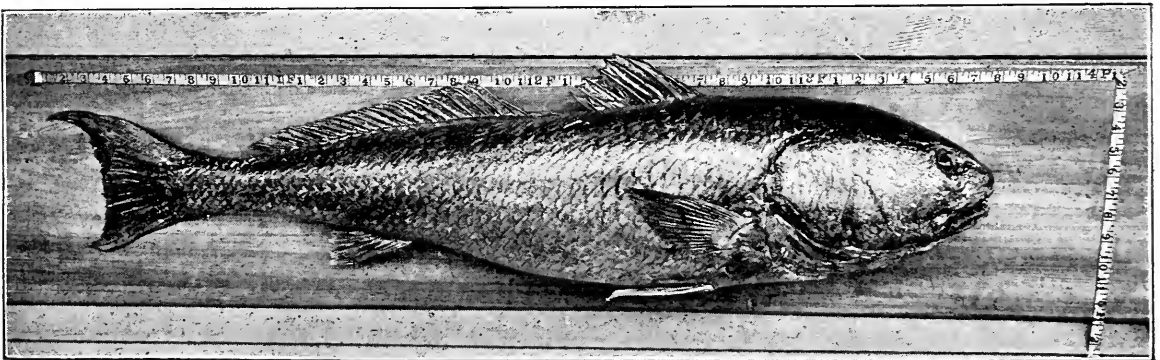

Rock ledge, on the Indian river, Florida, is a favorite place for Northern sportsmen. Quail and ducks abound; alligators are numerous and there is plenty of other game.

The best sport, however, is fishing. The favorite in this line is trolling for weakfish or sea trout. A dozen fish in an hour, weighing  $1\frac{1}{2}$  to  $2\frac{1}{2}$  pounds, is an every day affair; though occasionally a trout is taken weighing up to 10 pounds.

The aim of most anglers is to secure one or more channel bass—for which the place is famous. Stopping at the New Rock Ledge hotel you can always find genial

companions, who have made a practice of going there, for years past, to indulge in their favorite sport. The channel bass usually run from 15 to 20 pounds; but specimens up to 30 and even 40 pounds have been landed.

The channel bass shown in the accompanying photograph weighed,  $\frac{1}{2}$  hour after landing, 28 pounds and measured 44 inches. The bait used was dead mullet, the tackle was rod and reel, and nearly one hour was required in which to boat the big fish. Mr. Jos. L. Arguimbau, of Hackensack, N. J., was the fortunate angler.

J. G. Ackerson.

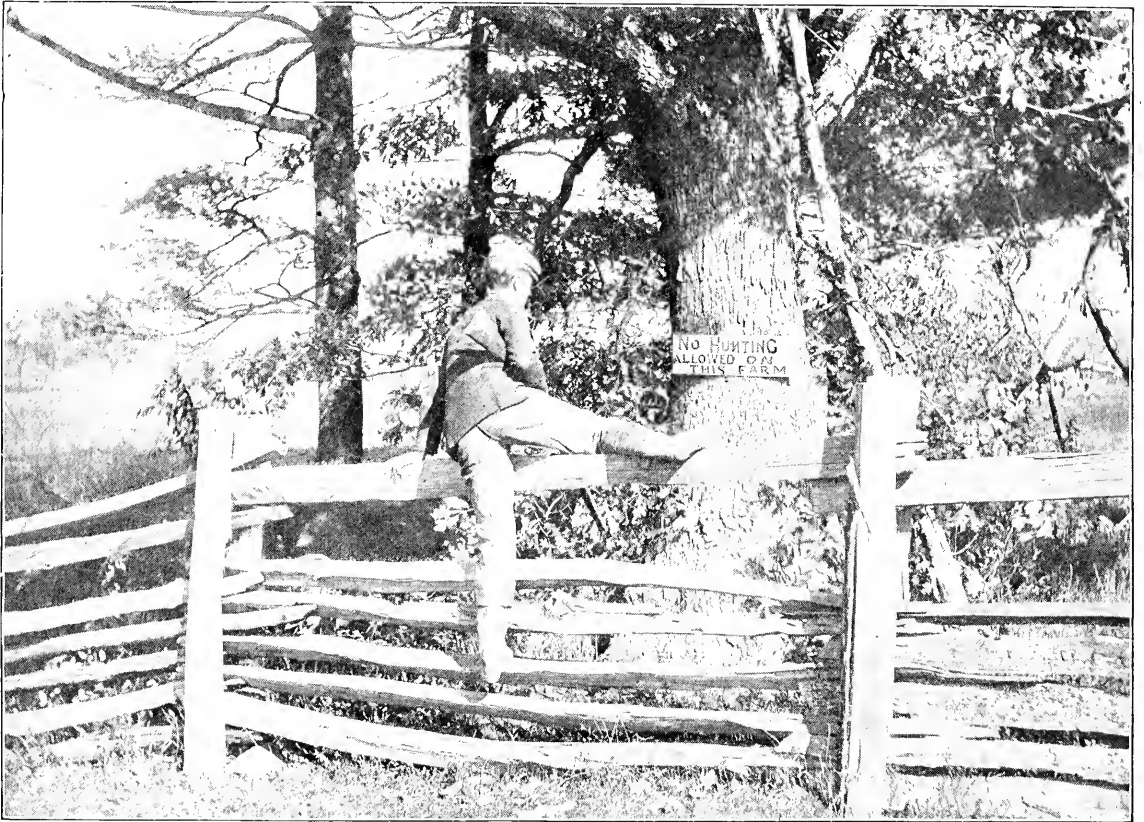

AMATEUR PHOTO BY H. G. READING.

LOOKING FOR TROUBLE.

Awarded Twenty-sixth Prize in RECREATION'S Second Annual Photo Competition.

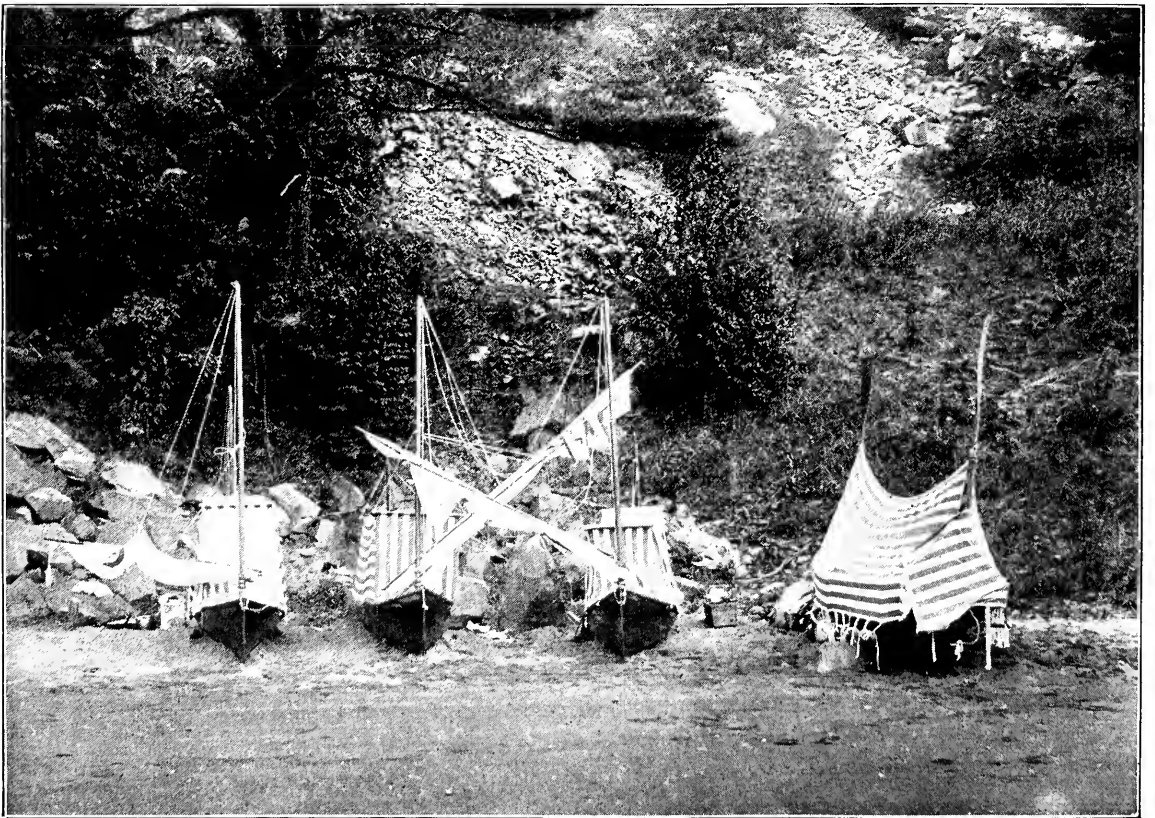

AMATEUR PHOTO BY WM. ALLEN.

END OF THE CRUISE OF '89.

Awarded Thirteenth Prize in RECREATION'S Second Annual Photo Competition.



AMATEUR PHOTO BY CAPT. JNO. S. LOUD, U. S. A.

A FINE CATCH.

Awarded Seventeenth Prize in RECREATION'S Second Annual Photo Competition.



AMATEUR PHOTO BY JOHN BOYD.

A HIGH GRADE TUMBLE.

Awarded Eleventh Prize in RECREATION'S Second Annual Photo Competition.

## IN THE GAULIES.

D. C. BRADEN.

November, 1895, found us on our annual hunting trip to the Gaulie mountains, of West Virginia, our party consisting of A. J. Braden, H. R. Nye, J. B. Eckford, Frank Blood, Jim Judson, Capt. Fee, B. Griesinger, McClellan Leonard and I. We met at Pittsburg and a short and pleasant ride, over the B. & O. and West Virginia Central railways, landed us at Beverly. Then in 2 wagons, we drove 30

At last came the long looked for and welcome rain; and the boys, with the exception of Leonard and I went over to our hunting lodge, 3 miles away in the Gaulie mountain. The next day Leonard and I started down Elk river to look for turkeys. Leonard was about a quarter of a mile ahead of me, when rounding a bend in the river I saw a big buck, about 300 yards away, coming out of the timber and



VARIETY IS THE SPICE OF SPORT.

miles up the Tiggert valley, between the Cheat and Rich mountains, to the foot of Middle mountain, where we stopped at the Hotel Marshall. Another drive of 11 miles and we were at the home of our old time friend and guide, H. B. Sharp, on Elk river.

We killed 19 big gray squirrels and 2 ruffed grouse, which we ate for breakfast next morning. The weather being dry and warm we spent several days hunting grouse and squirrels which we found very plentiful. We also located a big gang of wild turkeys, on Slaty Fork mountain.

Hunting turkeys is great sport, and requires a deal of skill and good judgment, on the part of the hunter. We killed 11 on the trip. Several of these, with some squirrels and grouse, are shown, with our Bill Nye, in a snap shot from Leonard's camera.

making for the water, into which he plunged and started to wade down stream. I slipped 2 buck shot shells into my gun and the deer now being out of sight, behind the river bank, I made a quick run and got within about 45 yards of him, when he saw me and sprang out of the water. I cut loose on him, with the right barrel, and broke a leg. I then fired the left and tumbled him over. He had a handsome pair of antlers, 5 points on one beam and 4 on the other. Leonard, when he heard the racket, started up the creek. He saw a deer running toward him and opened fire on it. At a distance of 30 yards he put several buck shot clear through it. One barrel did the business. It proved to be a large doe.

We hung them up, with a turkey that had been killed the day before, and Leon-



ard exposed a plate on them, before we dressed them.

The boys over at camp were in great luck, too. It began to snow, and soon the ground was covered with a good tracking snow. Deer proved plentiful and a number of bear trails were found, but no bear were killed.

When the boys came over from camp

they brought with them 5 deer they had killed.

Not being market hunters, and having all the game we wanted, and sport enough to last a year, we turned our faces toward home. This was our sixth trip to the Gaulties, in which time we have killed 37 deer, 3 bears, 55 wild turkeys, and a large amount of smaller game.

---

## A REMINISCENCE OF BUFFALO DAYS.

BY CAPT. H. ROMEYN, U. S. A.

The plains of Western Kansas furnish a rich field for the fossil hunter. They have, in pre-historic ages, been the bed of a shallow sea, and in the blue shale, which underlies most of this area, and crops out in the sides of the wind and rain-swept buttes, the geologist and palæontologist find many rare and valuable specimens. During the years in which I served in that region, several of the first scientists of the country paid visits to the sections lying about Forts Hayes and Wallace, and many of their discoveries were valuable. They generally came to the posts provided with letters or orders from Department Commanders, or from the Secretary of War, directing commanding officers to furnish them with such escorts as could be spared, and the duty was one sought after by both officers and enlisted men. The professors were generally genial men, good talkers, and ready to impart information to any one who wished it. One, a naturalist, who looked after the things of the present as well as of past ages, created a commotion at a dinner table one day, when a small snake, which, for want of a better place to confine it, he had placed in an inside pocket of his coat, and covered with his handkerchief, escaped from it to the table, just as the company had seated themselves. The ophidian was as harmless as an antelope, but the stampede was complete, and the really strange and beautiful "sarpint" was mashed out of all proportions by the boot-heel of one of the gentlemen present before it could be recaptured by its owner.

But "the champion bone-hunter," as he was designated by the soldiers, was a professor of palæontology from one of the Eastern colleges, who was accustomed to make extended tours with classes of students of his favorite science; and who, except in the instance about to be related, had no use for any bones that did not antedate Old Father Adam; and the further back they had existed, the better. Not wagon loads only, but carloads of fossils were found and shipped by him, and he was

known to have worked for days, with a pick and spade, unearthing a single specimen.

His first visit was made the next autumn after the events already related had occurred. With a dozen or more of students, he had spent weeks in the valley of Snake river, in Idaho, and, on his way East, stopped at Fort Wallace, with 3 or 4 of his party. His time was limited, but he wished to take a look at the country, and to see a buffalo hunt, as he had not seen any of these animals in a wild state. They could be found within a few miles of the post, and the morning after his arrival 2 officers, with half a dozen mounted soldiers, reported as his escort for the hunt. His party was furnished with an ambulance for the trip, and I handed him a rifle and 40 rounds of ammunition. The students had their own Winchesters. He thanked me, but said he did not need the rifle. He "had no desire to do any shooting; was only going to look on," etc., but yielded on being told that no one was allowed to leave the post without being armed.

The officers took seats with the party in the ambulance, for the time, leading their saddled horses, while the mounted enlisted men accompanied a wagon that was taken along to bring in the beef. Only a cursory examination of the rocky defiles was made, the savant deciding at once that they contained no fossils, and the party was soon near the head of one of the ravines, from which egress to the prairie above was practicable for vehicles. A man sent ahead to reconnoitre, reported several small herds on the prairie not far away, and tightening their pistol-belts, and the "cinches" of their saddles, the officers threw their outer coats into the ambulance, and mounted for the run. The "fossil party" were told that they could see most of the chase from some rising ground half a mile ahead, to which the driver was directed to proceed. The visitors were also cautioned to keep a lookout for other game, which was probably in other ravines, and would run for the prairie as soon as it "winded" the hunters.

As the mounted men reached the upland, probably 2,000 buffalo, in small herds, were seen, some of them not more than 200 yards away.

The charge was ordered, and, "every man for himself," the hunters started. I kept up the chase till both my revolvers were emptied, and had dropped 3 bulls. I then pulled up to find myself alone, and more than a mile from the nearest of my friends.

There was always one danger in running buffalo in the Indian country. The hunter, engrossed in the pursuit of his game, lost all idea of course or distance, and a run of 4 or 5 miles was not an unusual thing. At the end of that the sportsman often found himself alone on the prairie, with empty pistols and a tired steed, in a most defenceless state if suddenly attacked. I was soon joined by the other officers, and we waited for the wagon to come up and get our



"WE FOUND THE TEAM ALL RIGHT AND THE PROFESSOR AT WORK."

game, in the meantime scanning the ground along the horizon for some sign of the ambulance. But we looked in vain, and as soon as the beef was loaded we retraced our steps in search of the Professor. Nearly 2 miles back we met one of the party, his face wearing a disgusted look, as though he did not think much of buffalo hunting. To our inquiries about the others, he replied,—

"I don't know where they are. The driver took us up to that place you pointed out, and just as we reached it a small herd came rushing up from the ravines, and 'the old man' told us to get out and get a shot. As we jumped out another herd came along, and he told the driver to drive on, and left us out in the cold, and by that time the herd we had first seen had run out

of reach. The last I saw of the team it was away off in that direction (pointing to the Southwest), and I think it was running away."

Turning in the direction indicated, we galloped off in search of the lost man, and rode nearly 2 miles before, as much farther away, we saw the ambulance halted, and a man apparently at work on a carcass. Riding up, we found the team all right, and the Professor at work. He was a sight! He had killed a young bull (as the driver told it), "had filled him too full of lead for him to carry." He had lost his hat, and in lieu of it had tied a white handkerchief about his head,—thrown off his coat, and, with a knife "hacked worse than 2 saws," and which had been used all the trip for digging fossils, he was trying to cut off the animal's head to take home as a trophy. His hands and arms were bloody, his face dripped with perspiration. In trying to wipe it away he had forgotten that his hands were bloody, and had stained his face, hair and handkerchief with gore, till he looked worse than a Chicago butcher. We sent the driver back to bring up the wagon, and then proceeded to assist in getting off the skin, as he said he must have it dressed and the head mounted. After we had returned to the post, had a bath, and the professor had cooled down, mentally, he began to think how he must have looked and acted, and after his return to the East it was soon a tabooed subject. The driver's story, told to his fellows, was couched in language more forcible than eloquent. Leaving out the expletives it was about as follows:

"He wasn't goin' to shoot no buffalo! Oh, no! But after he got them young fellows out, he jest went plumb crazy, an' when about the third bunch of 'em run past, he poked his gun out past my head an' fired right over my mules, an' they went in spite of me. His hat blowed off, and I wanted to go back fur it, but he sung out not to mind his hat, but go on. And bimeby he banged away again, and then the buffaler stopped, an' I began to circle 'round, and then the old fellow jumped out and was goin' to run right up to him; till I hollered that he'd git h'isted if he did, and then he jest stood off, and pumped lead into him till he dropped. Talk about 'buck ager'—if he didn't have 'buffaler fever' I'm a tenderfoot."

The Professor came back the next year, and with him came one of the same party. Scarcely had we shaken hands when he said, "Don't say buffalo to the old gentleman—it is a sore subject."

## A SALT WATER BREEZE.

GEORGE G. CANTWELL.

"How about that trip to the Nisqually flats"—I looked around to see the familiar figure of Chauncey Pötter beaming over the fence—"All right" I answered, "I'm ready any time you are."

So a day or 2 later we had all our traps stowed away in his green boat and started down the Puyallup river for the Sound, then in and out among the pretty islands for the tide flats of the Nisqually river.

The Puyallup was low and rapid, the 12 mile ride to the mouth furnishing plenty of unexpected pleasures and excitement, now gliding rapidly along the smooth places among the tall firs—to be suddenly twisted into a strong eddy and stranded in a mass of drift-wood. While afloat it was one continual dodge to keep clear of the ugly snags, just below the surface, but we came out of it with a dry boat and no mishap.

We had some difficulty in passing a queer lattice work of a fish trap the Siwashes had built across the river, in direct violation of the law.

At the mouth of the river we came upon a number of fishermen catching salmon, with gill nets.

We stopped at one camp to get a few strings of salmon eggs, for trout bait, and looked over the last catch—a boat load of fine fish, principally silver salmon, a few tye salmon and a monster jack salmon, as long as a man and as trim and graceful, in outline, as any trout.

Once on the salt water we made better time, and settled down to our 22 mile row, to be relieved by the sail when the wind favored us.

We camped for the night a few miles around the bay from Tacoma. There is always a novelty about the first night's camp of any trip, but our excitement finally died out with the fire and folding the flaps of the tent together we had but just quieted down when a disturbance on the beach caused us to investigate. The full moon showed a party of fishermen drawing a seine. We went out and watched them pull their net into shallow water. The fish, for there were thousands of herring in front of it, were frantic in their efforts to escape, lashing the water into a foam; but the fatal net had crowded them and there they were laid, several tons of them, on the sand. There were among them about a dozen salmon, a few dog fish, some of the curious little rat fish, with mouths full of sharp teeth, and a big sea bullhead whose spread of fins, from all sides, would eclipse the rig of a racing yacht.

Their catch was larger than the men could

take care of and after their boat was loaded the half still remained on the beach where the receding tide had left them.

We picked up what we could use and had herring for the next few days, as well as a hot skillet of them then and there that made us a delightful midnight lunch.

The dead herring soon attracted a swarm of dog fish to the spot and the phosphorescent streaks that criss-crossed through the water, in all directions, told the numbers of the hungry creatures that were moving about. What they left were devoured, in the morning, by a flock of gulls and terns.

The next 3 days were spent among the different islands along the way. We took our time and loafed along, shooting a few ducks and ruffed grouse, and feasting on huckleberries. Occasionally we made a meal on clams or muscles.

Salmon were continually jumping, some making splendid leaps of 4 or 5 feet into the air and often keeping it up for several rods, leaving a long chain of glittering splashes behind. Porpoises and seal often came in view. We were unable to get a shot at a porpoise but killed several seal, which sank before they could be reached with the boat.

One night we camped on the soft sand of the beach, just beyond the high tide line, and were no sooner comfortably settled inside the tent, perusing "Huckleberry Finn," than we noticed the sand was alive with a queer little jumping insect. They were all coming to the head of the tent, where the lantern sat. They were more the shape of a shrimp than anything else I can recall; were about  $\frac{1}{8}$  inch long, with a stubby sort of tail that they kept curled underneath them. It only required a sudden straightening out of this member to send them a foot or more; and they were flipping about all over the blankets and between them. Although they did not seem inclined to taste of us they were a terrible nuisance and the only way we could get any peace at all was to crawl under the covers, kill what we could catch and let the remainder roam about the tent at will.

One morning, after an early start, the low land of the Nisqually flats appeared, in a break in the fog that the sun had not yet melted away. With the sight of the flats came the whistle and roar of the frightened water fowl that drift about, in enormous flocks, over the shallow waters. They rose on all sides and wheeled by, well out of range, only to settle down again where they might feed undisturbed.

We decided to try the South side of the flats first, so we were soon at the Mouth of McAllister creek, up which we rowed a

short distance and found an old lean-to, made of cedar shakes, that had been used by lumbermen in getting out timber. This was an ideal spot to camp on, so we soon had the grub box and blankets under the roof, the tent spread over one side and the sail over the other, leaving the front open for a fire place.

Grouse were plentiful in the brush, behind, and the duck shooting, on the marsh, was all that could be asked. Plenty of trout were everywhere in the creek.

The first night's slumber, on our bed of boughs, was disturbed by a pair of mink



"PLENTY OF TROUT WERE EVERYWHERE  
IN THE CREEK."

that came in and got mixed up in an empty paper bag. One would hardly imagine a bit of loose paper could produce such a racket; but a big rubber boot, that dropped into their midst, drove them off and all was quiet again, save for the dismal hoot of a great horned owl that took up his stand just behind our camp. With almost clock like regularity, snap! snap! would go his bill, followed by deep "hoo—hoo's" and, although it bothered us some at first we soon got used to it.

Daylight was sure to find us up—generally on the marsh for the morning flight.

We were always rewarded by a string of birds and an astonishing appetite for breakfast.

The tide rose and fell 6 feet or more, in the creek, and mornings, when the banks were full, large numbers of seal would go drifting up stream, to come back a few hours later, in bunches of a dozen or more, barking, diving, and splashing about, having a high old time of it. But let a man appear on the bank and all this hilarity suddenly ceased. Then, sinking down to their eyes, they would glide swiftly along, ready to dive at the least suspicion of danger. They would then reappear half a mile below.

One of the brilliant things I did was to row into the middle of the marsh at daylight, one morning, and allow the tide to run out and leave the boat in the mud—this, too, on an empty stomach. Both boats were soon full of water, and a cold wind coming in from the bay, but the only thing to do was to make tracks for camp. I went to the head of the creek, to a bridge, where I got a drink of fresh water and a few green apples to eat; then down the other side, coming into camp, about 4 in the afternoon, completely done up.

Rather than take the long tedious walk around again, for the boat, I had concluded to swim the creek and bring the boat back, now that the tide had set in; but Potter, by a lucky chance, found a piece of a raft, paddled across and was soon back with the boat.

The relief at the thought of not being obliged to swim the ice cold creek, that afternoon, was a balm that soon put me to sleep. It needed only a good smell of the salt sea air, next morning, to put me on my feet again.

We passed the best part of a week here; shooting ducks and grouse and catching elegant strings of trout. These took the bait of salmon eggs with an eagerness that was fatal to them. They traveled in little schools, with the tide, and when we found them it was no trouble to fill a basket.

During the last few days we laid in a supply of fish and fowl for the folks in town, and then set sail on the homeward tack. A few hours later we were again sleeping on feather beds.

---

Now doth the little busy bee  
Add much unto the woes  
Of Johnny, footbare on the lea,  
By getting 'twixt his toes.  
—Indianapolis News.

## OLD FORT SMITH.

MAJ. E. R. P. SHURLY, U. S. A.

In 1865, after the close of the war, the Government authorities had leisure to take up Indian affairs. For some time the different tribes had been in an unsettled state.

Rich gold mines had been developed in the vicinity of Virginia City, and a general stampede of thousands of prospectors followed. In a short time the place grew from a straggling hamlet to a town of considerable size. Now the route, West of Green river and the mountains, to Virginia City, was roundabout and difficult. There was another road, however, via Fort Laramie, up the Eastern slope of the Big Horn mountains. Most of the distance was through one of the finest countries in the world. Good grass, game in plenty, and magnificent scenery; but there was one drawback to this route—the Indians.

The Sioux and Kiowas objected to having the last of their hunting-grounds desecrated by the whites. Here were found buffalo in thousands, elk, antelope and bear. The country was fruitful, in season, with wild plums, grapes and berries; while the streams were alive with trout. Notwithstanding the objections of the Indians, the authorities at Washington decided to take possession, establish posts and open a shorter route to the Gallatin valley.

The 18th infantry, to which I had the honor to be appointed, was stationed at Louisville, enjoying peace and the hospitality of that pleasant city. One day it received an order to repair to the "land of the Dacotahs" without delay; there to establish the necessary posts to protect emigration, and to open a route to Virginia City, Montana.

Why the 18th should have been selected, which had only recently returned from the front, was to us a problem, unless it was because the commanding officer was not in the graces of Secretary Stanton. The story was told that the Secretary, on opening another letter from our Colonel, who was after a "soft snap" in the East, turned to his clerk and demanded: "Which is the next place to hell to send a regiment?" "To the Powder river country," was the reply.

"Then order the 18th infantry there at once," commanded Stanton.

It would have been well if the old 18th with its 3 battalions had gone; but before it could start, it was divided into 3 regiments. The 2d battalion was numbered the 27th, and sent to the Powder river country. This regiment did a great deal of fighting; and about 200 officers and men are buried at Forts Reno, Phil. Kearney and C. F. Smith, sacrifices to an impotent Indian policy on the part of the Government.

In 1866 not a wagon train passed up or down that did not have to fight its way. The 27th established the 3 posts mentioned. I was attached to the column of Gen. John E. Smith, who, in 1867, with 350 men, left Fort Sedgwick the 2d of May, arriving at Fort Phil. Kearney July 3d. The General was a gallant officer. He had made his mark while commanding a division in the Army of the Tennessee.

When Gen. John E. Smith's column, as it was called, reached Fort Phil Kearney, it was suggested to the General that an old boiler and engine, then at the post, could be used toward building a saw-mill at Fort Smith. These were parts of a mill burned by the Indians. Accordingly, the quartermaster, Gen. Daudy, caused a 6-wheel truck to be made for transporting the engine. Drawn by 12 yoke of oxen, it was, after much trouble, hauled to Smith. Then it took all the expert mechanics in the ranks to get the thing into shape.

It was a wonderful mill when completed. All of the running gear was made of wood. An original saw-mill, surely; but by its aid the question of lumber for the new barracks was settled.

Old Fort C. F. Smith was situated on one of the most pleasing sites in Wyoming. It was built on a bluff 500 yards from the Big Horn river, and a mile above the great canyon that extends Westward 100 miles, to the Stinking Water river. Fort Smith was one of 3 posts built to hold the Indians in check. It was a stockade post, and once stood an assault against a force of Indians 20 times the strength of the garrison. After our arrival, the old wooden barracks were replaced by buildings of adobe, the bricks being made by the men, the lumber sawed at the mill.

The Indians were bad. The Government did not mean war, but the Sioux and Arapahoes and Kiowas did. They lost no opportunity to let us know it.

We were then considered as out of the world; and were so far as getting news from the East was concerned. Months intervened between mails. Wagon trains were strongly guarded, and even then there was constant fighting with the large bands of Indians, who took advantage of any inattention of the escort to "jump the train."

The garrison at the fort was most of the time in a state of siege. A man going from the stockade to the river took chances. Occasionally our friends the Crows (Absracas) to the number of 300 or 400, would camp near us. Then we had lively times. Their old enemies, the Sioux, would come in to give them a fight; and the garrison would look on.

Old Smith at times was a monotonous post. The sun would rise out of the plains and disappear over the mountains. Slowly the days passed. Game was abundant. From the top of the stockade could be seen buffalo, elk, antelope and sometimes bear. Small game was equally plenty, but it was risking one's life to hunt. Many took the chances, however, so we were usually provided with game. During the winter of

'66 the garrison lived mainly on corn. No train came through, while the Indians, numbering thousands, had their winter quarters on the Little Horn river.

I have not been in that country since 1868, but I am told the remains of the old post are visible amid the civilization that has sprung up around it. The valley of the Big Horn now blossoms as the rose, and all is peace.

## IN THE LAND OF THE SHAG.

F. J. CHURCH.

A glance at a map of the United States shows the extreme Northwestern part of our country to be a peninsula, lying between Puget sound and the Pacific ocean. Rugged mountain ranges practically cover this whole region. The coast line, mouths of rivers, and a few prominent peaks, are correct on the maps; but the interior is an unknown country. The greater ranges are on the North and East, but many long spurs run down to the Pacific, jutting into the ever tumbling waters in the shape of precipitous promontories of black and reddish rock. These rugged cliffs have been worn into fantastic shapes by the action of the waves. Scattered here and there in the ocean, often 5 miles or more seaward, stand portions of former coast lines that have resisted the assaults of old Ocean. These small rock islands, often of much greater height than their horizontal extent, as well as the promontories, are dwelling places for sea fowl of all descriptions, but principally of the red-breasted cormorants, known as shags.

They are peculiar birds, in appearance, in habits, and in odor—particularly the latter. Winter and summer, storm or calm, thousands of them may be seen sitting on some bleak rock, just beyond the full force of the billows, or flying with their yard of neck stretched out, their comparatively small wings flapping in an absurdly rapid manner.

Three of us had spent nearly 2 months knocking about in the interior of the peninsula, packing our outfits on our backs; so right glad we were to hear the roar of the ocean, and feel the cold sea breezes. The giant Western forests are beautiful and wonderful, but when one is tramping among trees that grow as close together as the bushes in a thicket, with tops 200 to 300 feet in the air, the view is necessarily limited. The ocean beach, therefore, which gave us plenty of room, was a welcome change.

Having rested over Sunday at the Gort agency, at the mouth of the Quinault, we started out refreshed on Monday. After wading streams and climbing rocks and windfalls, the smooth, hard ocean beach seemed better than any pavement we had ever trod.

Just North of Quinault, a long promontory juts out into the ocean—Pt. Granville. Through this a hole has been worn by the waves, some 15 feet in diameter. Clambering over the slippery rocks that form the floor of this double-ender cave, we were gladdened by the sight of a long stretch of beach that would have put to shame the finest "pike" in the land. It is 3 miles long, nearly 500 feet wide, at low tide, hard and so nearly level that water stands in shallow pools all over it.

The shag were everywhere, walking the beach, sitting on the rocks and cliffs, and flying about in all directions. To the Westward, a constant stream of them were flying up and down the coast. We were guilty of shooting a number of them with our rifles; but they offered such exceptional marks, and made such absurd haste to get away when not hit—which was usually the case—that we could not resist the temptation.

The coast, from the mouth of the Quinault to Cape Flattery, is peculiar in its characteristics, in part decidedly dangerous. While there may be a quarter of a mile of beach at low tide, when the tide is in, there is no beach at all—the long giant rollers from the Pacific dash against the foot of the cliffs that everywhere fringe the coast.

After plodding steadily onward for an hour or so, we saw with some apprehension that the tide was running in rapidly. Off we started at the highest speed a long race and 60-pound packs would allow. Our object was, to make the mouth of the Raft river, where we could wait for the ebb tide, and get fresh water. Toward the end, matters got entirely too interesting for com-

fort. We were constantly wading through the tail end of breakers, while occasionally a big one would cover us from head to foot; once or twice thumping us against the rocks. At last Castle rock, which juts up out of the beach immediately to the South of the Raft, was seen. With gladdened hearts we pushed forward on the final spurt, reaching the sand dune, above high water, none too soon. A big fire of driftwood dried our garments, while copious draughts of brackish tea warmed us.

When the tide receded, we crossed the Raft in a small canoe, which was found behind a log. The mouth of the Queeto was reached at dusk. Here a crowd of dirty, disagreeable looking savages gathered around us, all jabbering at once. We wished to cross the river that evening, to have no delay in the morning; but we could not persuade any of these fellows to pole us over for less than 6 bits (75 cents). This we regarded as an imposition, as the distance was under 200 feet. We tried to bluff them by preparing to make camp, intending to borrow a canoe—when they had retired. They evidently knew exactly what was in our minds, for they carried all the poles and paddles into their shacks, then hauled the canoes up high on the pebbly beach.

One miserable specimen of a man, robed in a single tattered blanket that was off more than it was on, stood around and chattered until we almost thought an Egyptian mummy was haranguing us on the deeds of his forefathers. We finally decided to give this ancient mariner his price if he would land us on the other side where there was fresh water. Once across, we ceased to be the suppliants, and when the ancient gentleman was unable to change \$1, we simply shrugged our shoulders, told him we were excessively grieved, but could not help it. He hopped around in an awful state of mind; finally seizing a piece of bacon and an ax, and starting for his canoe. He was promptly grabbed by the long hair and yanked to the ground. Then he became very humble, telling us he would take "ictas" (odds and ends) instead of the "chickamin." We finally compromised by giving him 30 cents and 2 pounds of bacon.

About 3 in the morning we awoke to find the entire camp under water, the tide having come in at a tremendous rate. Pots and pans were floating around in what, to a spectator, would have been a ludicrous fashion. When the sun appeared we found that the old reprobate of the day before had come back in the night and had stolen all of our bacon. As there was absolutely nothing to do but to grin and bear it, we made a breakfast of smoked salmon, "choke-dog," and tea; then shouldered our packs.

Now fast progress was made along the

smooth, hard beach. Again we were forced to follow an obscure trail over the cliffs, through salal brush 15 feet high, to get around some promontory. At Klalops creek, 4 miles North of the Queeto, we met a man named Brown, noticeable principally for his whiskers, which reached nearly to his knees.

Brown was decidedly hard of hearing, and apparently thought every one else was afflicted with a similar complaint; for, although only a few inches from him, he roared as if he were trying to speak a ship in the offing. Paying no attention to our salutation, he walked up to us in a threatening sort of way, then bellowed:

"Young men, do you know what you are standing on?" Not knowing whether he spoke of sacred ground, or wished to intimate that we were on the edge of eternity, we jumped back and looked at the ground under our feet. Seeing nothing but some long, reddish streaks of sand, we answered in the negative. With dramatic gesticulations, he howled: "You are standing on GOLD. Wherever you see that ruby sand, there is GOLD." As we had just tramped over some 25 miles of it, we were not particularly impressed, simply advising him to "get a hustle on him and start to digging." He told us he and his sons were staking out claims; so we bade him adieu, wishing him luck.

As we were moving off, he yelled: "Say, do you boys want to kill an elk?" This query brought us to an abrupt halt, for it interested us more than possible gold mines on the Pacific beach.

He told us there was a big herd of elk 2 miles up the creek; so we walked to his ranch, left our packs, and started on the hunt. Our friends the shags were, as usual, all around us, a long stream of them going up and down the creek. It seemed queer to be hunting elk with these sea-birds flying about.

If I ever have a particular grudge against anyone, I shall advise him to go up Klalops creek hunting. Between swamps, dense thickets of poisonous devil's clubs, and long stretches of salal jungles, that no man could force a way through without an ax, we had an awful time, being over 2 hours in making a mile. Sitting on a log, mopping perspiration, and resting, we nearly decided to turn back. Roland said he had not lost any jobs like this, while Frank thought, being so close to the clams, the elk were probably fishy, and therefore we did not want them. After puffing at our pipes, we felt better, and decided to go another half mile anyway.

We had not gone over 200 yards when a cracking in the brush attracted our attention. Looking in that direction, we saw a big cow elk standing under a hemlock, flapping her big ears to keep off the flies. Near her was a small bull, while farther

off we saw 3 more cows and 2 calves. We wanted meat alone, as it would have been impossible to pack antlers; so, drawing lots for the shot, we knocked over the yearling bull. Cutting off as much of the meat as we could carry, we blazed trees in the neighborhood, so Brown could find the game.

The remaining elk did not appear to mind us or the shot; several being still in sight when we turned back.

Brown was surprised and pleased at our good fortune. I very much doubt if he knew the elk were there; although if he did not, it was a strange coincidence. As it was too late to make the Hoh that night, we spread our blankets in a hay-mow, on a small flat near the creek, and enjoyed

well earned repose. On the morrow we reached the Hoh without particular incident.

There we found a picturesque Indian village, peopled with the finest looking Si-washes we had seen; though not many of them would have taken prizes in a beauty show. One of the head men, Hoh William, treated us very generously indeed. He was a good Samaritan after the miserable little scamp on the Queeto.

I asked Hoh William if he ever ate shags; to which he replied: "Yes, they are just as good as crow or cranes;" a statement we were unable to contradict.

As curiosity and a desire to rest kept us several days at the mouth of the Hoh, I will leave the 3 tramps there for the present.

## FISHING IN THE MOUNTAINS OF MARYLAND.

L. L. LITMAN.

Early one morning, in August last, our party drove out toward the mountains. We were 2 sisters, a brother-in-law and I, and were leaving the hot and dusty city for a cooler atmosphere, and a few days' bass fishing. Our destination was Friendsville, Maryland. We took advantage of the morning to make the drive of 28 miles. The horses seemed as anxious to be going as we were, for they trotted to the foot of the mountain, 3 miles distant, at a 3 minute gait. For the next hour the road took a winding course up Chestnut ridge, a spur of the Allegheny mountains, for a distance of 3 miles, to the summit.

Here we stopped for a breathing spell, and to look back over the valley, 1,000 feet below. Then down, and up, until we had gone 17 miles over the old National road. This was built by the Government, in 1818, and until 1852 was the highway for trade, and the mails, between the East and the West. Henry Clay, Jackson, Harrison, Polk and other distinguished men were familiar figures to dwellers along the road, in their time. Fort Necessity, and the grave of General Braddock, may be seen from the roadside.

At length, we saw the river hills, then in the valley below the Raging "Yough," wending its way through the little village of Friendsville. Away beyond a white speck nestled among the giant oaks and maples. It was our summer home. We were soon pleasantly settled in our cottage, and then followed golden days of fishing and of rest.

The Youghiogheny is here a mountain stream, clear, and pure; its waters, rushing

and tumbling over a rocky bed, make a perfect home for black bass. I had the good fortune to spend several weeks of last summer along this stream, fishing when the spirit moved me, and it moved me often. Having the advantage of being able to wait for the best weather and water, I caught enough bass for our table at Bear creek.

My experience does not warrant an attempt to advise any particular time to fish in the Youghiogheny, for I have taken bass there in May, June, July, August, September, and October. However, if I had but 2 weeks of the summer to spare, I should choose August. Being but one of a number who fish this stream, I should judge that hundreds, and perhaps thousands of bass were taken from it, each summer.

One should not go there expecting to fill his creel in an hour, or even in a day. Bass are plentiful enough, however, for anglers who are after real sport and who are not out to kill as many fish as possible.

There are 2 sides to most fishing excursions: the bright and the dark. The bright begins days or weeks before the date of the contemplated trip. You go to bed each night thinking, and may be dreaming of it. Fishing clothes, minnows, and lunch are finally made ready, the night before the start, to be picked up when you are called in the morning. An early start is everything, for that is when the fish are feeding and are most likely to bite. As you wend your way through the field; and up the river, the bracing air, the picturesque surroundings, the thought of eating your



lunch on some big rock, in the middle of the stream, and more than all, the thought of making a fine catch—all these and a hundred other pleasures make you forget the laborious return trip.

The laborious return trip! I was picturing it in my mind as on the dark side. Let us see if it is. A few miles from home, tired, wet, and hungry. Your fish, basket, minnow-bucket, wet clothes and heavy shoes pulling you down; now wading the river, picking your way through laurels, over logs and rocks, with perhaps an occasional fall on the smooth boulders; then home, a steaming supper, and to bed. "Hard work, and we will never go again," we say. The next morning, however, finds us seining minnows preparatory to another trip. So it is, and always will be. The dark side? Come to think of it there is none. It dwells only in imagination, for when memory takes its flight to other days, these 2 sides blend brightly into one.

Some days, when I tire of near surroundings, I get on the train at Friendsville, ride  $2\frac{1}{2}$  miles to Manon lands and walk a mile or so up the tram road that follows along the river. The scenery is picturesque; the river has more fall, making many pools; and bass are more plentiful than below. Then down to the river, with my Bristol steel rod, and usual trimmings, to give the finny tribe of the Youghiogheny an argument; fishing first those places that can be reached from the shore, before going into the water. Without wading you cannot hope to be successful. It is well to note the places where the large fish are likely to be. Then cast the tempting bait; let it sink to a depth of 2 or 3 feet, and as you lead it here and there, should you lure from his haunts and hook a 2 pound bass, it will behoove you to use your finest art to land him. When you get a strike, out runs the line, your prize seeking the deepest part of the pool. Not relishing the barb, with a sudden plunge, he darts along, the reel making sweet music all the while. He shows his glistening sides, then, resisting, still, allows you to reel him in, and the struggle and excitement are over.

You are thinking of a tale to be told of his capture, when you are again awakened from your reverie by the whirr of the reel. Ah, another. No! he hardly bends the rod. Gently he is disengaged from the hook and thrown back. Let your work and sport be for a few large fish. They are worth many small ones.

Of the many fishing excursions to the Youghiogheny, one of 2 hours, with a friend at Frederick's Dam, is often brought to mind. We went one evening in August, just at twilight. While we sat on the bank enjoying a lunch, the moon rose above the hill, shedding a silvery splendor over the valley. We could see the bass rising to the surface, making little swirls in the still

water. After fishing 2 hours, we waded ashore with 17 bass. Within an hour, we were home and in bed, lulled to sleep by the murmurings of Bear creek.

One who has fished during the day only, has yet a new experience to undergo. To move along in the semi-darkness, feeling your way over the rocks, you must be something of a gymnast to escape a wetting. Trees, logs, and rocks assume grotesque figures in the shadowy foreground. The noises of the day have given place to those of the night. Bats flutter overhead, with soft whirr of wings, uncomfortably close, at times, occasionally striking rod or line; while from some neighboring pine, on the hillside, come the doleful notes of the owl and the whippoorwill.

Flowing into the Youghiogheny river are 15 or 20 tributaries; Bear creek is the largest. Its source is a small spring, in the Maryland hills, at an elevation of 2,000 feet above the sea. As it rushes down the mountain, numerous small creeks, clear and cold, flow into it. Here brook trout are found. In times past this stream abounded with them, but during the last year the development of timber resources along its course, has almost spoiled trout fishing. The forest is being cut down; saw-mills have been erected on one of the branches, and the deadly sawdust turned into the stream. To catch the logs, dams have been built, while dynamite was used to clear the creek of projecting rocks. So, during freshets, thousands of saw logs are sent rushing down the stream to be piled in a jam at the mill, at the mouth of the creek.

In spite of all this, trout may still be taken in the branches above the mills. Sawdust does not appear to affect bass. They run up the creek, from the river, occupying the largest holes and growing fat on the minnows, mullets, and cray-fish.

I was enjoying Bear creek breezes last July, when a party from Altoona, Pa., came to visit us. They had been looking forward, all winter, for this 2 weeks' outing. When the time arrived for their coming, my minnow box was in the creek, filled and ready. My visitors brought with them a trunk full of photo apparatus and fishing tackle, but this world is full of disappointments. It was the summer of their discontent. The pleasures they expected in fishing, and the views they would take back, picturing the scenes and happy hours, were dreams that did not materialize. The sun hid himself the day they arrived, and the rain descended thereafter, for 10 days. The streams rose to a height never before known. Thousands of saw logs, parts of bridges and drift of every kind filled the streams. It was a beautiful sight but poor comfort for the disappointed sportsmen, who had looked and hoped for better things.

Determined that our visitors should at

least have a taste of fish, I went one day to the river, when the water was at the highest, and with worms surprised myself by catching 3 good sized bass, in 4 feet of water, directly over a country road

The day came for the return of our friends, just as the waters were falling. The next day the sun was shining as brightly as ever; the water fell rapidly, and I was alone at a time when I least desired to be so. There was fine sport with bass, in creek and in river, after the waters fell. My journal tells me of 50 caught in Bear creek, and of many others taken from the Youghiogheny. I have in mind one beauty, captured in Bear creek August 2, measuring 13¾ inches.

The evening of August 26th found me

and a companion standing waist deep in the river, in a pool. It was an ideal evening for fishing—the kind that did not come again during our stay. A warm South breeze came gently down the river, bringing hundreds of small flies—tempting bits to the bass, which were rising in all parts of the pool. The fish bit savagely for a while, and did not criticise our mullets. They did not care, seemingly, whether the bait was dead or alive. In 2 hours, we caught 32 bass, and quit.

The time for our return to town came too soon, but we went back healthy and contented, taking with us the memory of a happy outing, and vowing the next summer should find us again in the mountains of Maryland.

---

## CAMPED IN THE CANYON.

JAMES HANKS.

Wake ye, and punch up the fire, Bill,  
 Let's have jest a little more light;  
 I am tired enough but try as I will  
 I can't go to sleep to-night.  
 My thoughts have strayed out of sight,  
 And I can't jest round 'em in;  
 So I'll spin ye a yarn—'twixt now and day-  
 light.  
 And now, while ye smoke I'll begin.

Together we've braved the storms and the  
 flood,  
 Tryin' to find dirt that would pay;  
 And at night we've slept like babes in the  
 wood,  
 And renewed our search the next day.  
 But to-night something tells me thar's  
 comin' a change;  
 That we'll soon quit hunting for ore,  
 And Bill, ye'll soon be alone on the range—  
 Old Jim won't be with ye no more.

For to-night as I lay here countin' the  
 stars,  
 Tryin' hard to get sleepy again,  
 I tuck my back trail o'er a long stretch of  
 years,  
 And I seed what a failure I've been.  
 Up from the dark, lonely canyon there  
 came  
 The roar of the falls and the rills,  
 And it sounded to me exactly the same,  
 As the wheels in the old Woodbine mills.

And there came to my ears, 'bove the sound  
 of the mill,  
 The voices of children—and then,  
 They passed, one by one, right before me,  
 Bill,  
 And renewed their glad laughter again.  
 And out of the darkness there came to my  
 gaze,  
 (Now drop your pipe Bill—and breathe  
 sorter low)  
 The face of another, I knew in those days,  
 And had loved in the long, long ago.

Her hair was fast growing gray; I could  
 see  
 And—ah—how the time flies!  
 Thar—smoke away Bill—no—never mind  
 me;  
 I—I—jist got some smoke in my eyes.  
 I have seed the old mill so oft in my  
 dreams,  
 Where the river runs deep, and so still;  
 And Bill, my happiest days—it seems,  
 Were passed at the Woodbine mill.

So when I have throwed my last lariat,  
 And shovelled my last pan of ore,  
 And a paper that reads—"this prospect to  
 let"  
 Is nailed to my old cabbin door;  
 Bill plant your old pard where the violets  
 grow,  
 On the banks where the river runs still;  
 And I'll be sung to sleep by the rumblings  
 low  
 Of the dear old Woodbine mill.

## FROM THE GAME FIELDS.

### BIG GAME IN COLORADO.

REV. S. N. M'ADOO.

The heart of the woods, the sinuous bank of a stream, the margin of a lake in the forest, signs of wild game, a chorus of wolves' voices—these things have always had a greater fascination for me than the thoroughfares of great cities. When, therefore, the mountains of Colorado were decided upon as the scene of my vacation last year, the idea was much to my taste.

A Winchester rifle, 45-90, a field-glass and a camera were carried. If, with such an outfit, a man can not have a good time in the mountains, it is not the fault of the mountains. There must be something wrong with the man.

In Denver I learned that Steamboat Springs, in Routt county, was a good place for big game. So I took the train to Wolcott, and thence the stage to Steamboat, 82 miles North, where we arrived the second evening.

The next morning I got a saddle-horse and started for the mountains. Whether it was the roughness of the broncho, or the altitude, or both together, was not clear, but I had not gone far till I began to lose all interest in life. There I was in the heart of the game country, with the mountains about me, lifting their purple heads to Heaven—enough to put a man into raptures; but my miserable stomach began to "buck," so I beat a retreat, ingloriously, to the hotel.

That afternoon as I was sitting in the office talking to a hunter, who had, in his time, killed 16 bear, a good-hearted fellow thrust his head into the room and said: "A few of us are going out a mile or so; don't you want to go along?"

An invitation I was glad to accept. I asked the bear slayer if he thought I might see a deer. "Well, hardly so near town; but then you might," was the reply.

I took my rifle and joined the party. The others were after fish and birds. I separated from them and, with much toil and perspiration, climbed to the top of a hill. So far nothing had been seen but here and there a few tracks, or the place where a deer had lain down.

When descending through a quaking aspen thicket, I looked over the edge of a ridge, down into a valley. To my surprise and gratification there was a young buck. I watched him as he indolently brushed a fly from his flank. He was too far, but was coming nearer. I waited, but fear not with the calmness that befits a crisis. I soon lifted my head above the ridge again. This time he looked me full in the face, perhaps

150 yards away. "Now's your time!" thought I. The next instant the stillness was broken by the voice of the rifle.

Just here it would be very gratifying to tell the readers of RECREATION the deer dropped instantly, never knowing what hit him; but I can not do it. That young buck went off in the very best of health, if activity is an evidence.

Well, when a man has done a piece of work like that, after going a thousand miles, too, he begins to think the fools are not all dead yet. If there had been some difficult situation, or ill condition of things to blame for the failure, it would not have been so bad; but to have a thing come and look you straight in the face, and say as plainly as words could speak it: "Will you be so kind as to shoot me?" Then, too, when you have done your best, to have your game turn tail in apparent disgust, shake the dust from its feet, and cut your acquaintance—that is humiliating. I have heard hunters tell of the fine shots they have made, but I suspect the animals have a good time when they get together and talk over the fine shots we have missed.

Fortune was generous toward me that afternoon. A little farther down the mountain, as I stepped past a clump of bushes, I looked off to my left, and saw, some 75 yards away, a bull elk. His side was toward me and his head was thrust into a bunch of willows. He was either feeding or rubbing his horns. I made a few quick strides forward, stopped, aimed quickly and fired. Silence followed. I could neither see nor hear anything of him. Had he, too, forsaken me? I hastened to the spot. No, there he lay, having fallen at once.

He was a magnificent animal, as smooth and round as a peeled saw-log. When the news spread in the hotel that a tenderfoot from Minnesota had killed an elk, within 2 miles of town, all were surprised, for elk were supposed to be off in the mountain tops. Some offered congratulations, but others were incredulous, and strongly hinted that it must be a big buck. All doubts were dispelled the next day, however, when we brought the head into town—that antler-crowned head that now, from the wall of my study, looks down upon me, though with much milder expression than when it roamed the mountains.

While out after snipe last season, I shot one, as he rose. It was about 2 feet above the grass when I fired. When I picked it up, there was another dead about a rod farther on, still warm, with his bill down in the mud, full length.

J. A. P., South Bend, Ind.

THE ADIRONDACKS AS A RESORT FOR  
SPORTSMEN.

SEAVER A. MILLER.

Long before the "North woods," as the Adirondack region is sometimes termed, became famous as the resort of the invalid, many prominent men had discovered that here was the home of the red deer, the black bear, the beaver, the fox, the otter, the hare, the wolf and the lynx. These men had also learned that our lakes and streams were densely inhabited by trout.

The beauty of the many Adirondack lakes, with their verdant shores, and green islands; the grandeur of the mountain scenery, have made this region famous. In fact it has been called "the Switzerland of America," and has taken rank with the famous watering places of the nation.

Among the well known men who early visited the Adirondacks, in quest of sport, were Ralph Waldo Emerson, James R. Lowell, Professor Agassiz, Dr. Jeffries Wyman, Dr. Estes Howe, John Holmes (the brother of Oliver Wendell), Judge Hoar, Horatio Woodman, Amos Binney, Joel T. Headley, and W. J. Stillman. Several of these have given to the world graphic accounts, in prose or verse, of some of their hunting and fishing experiences in these hills.

Many people still have vivid recollections of the famous "Murray raid," when hundreds of tourists and sportsmen rushed to the mountains, lured by the glowing description by W. H. H. Murray in his well known book.

Have the Adirondacks ceased to be, to the sportsman, the "Paradise" they once were? Have the rod and gun no place here, since the advent of the invalid? Have the trout forsaken the streams, or the stalwart buck and timid doe the forest?

No. Each year finds more people in the mountains than the preceding one found. An army of these come here purely for recreation and diversion. Official reports show that 5,083 deer were killed in the Adirondacks during the open season of 1896.

In this section there are more than 200 guides pledged to support and to aid in the enforcement of the forest and game laws of the state. The law allows each individual but 2 deer, and this provision has not been noticeably violated. Allowing to each man this number it appears that more than 2,500 sportsmen visited these mountains during the months of September and October last.

Within that period I had the pleasure of being one of a party of 5 which killed, by hounding, 5 deer in 3 days. Several other parties, in nearby camps, had even better success; while tourists and sportsmen frequently saw 5 to 20 deer in a single

day, proving that deer are as plentiful in the Adirondacks as ever.

I consider the custom of butchering deer, by driving them into the water with dogs, unsportsmanlike, and it should be prohibited.

The reports regarding the fishing are not less flattering than are those of the hunting; for, in addition to the natural production, millions of trout fry are put into Adirondack waters annually.

The Adirondack Guides' Association, consisting of 250 of the best guides, representing every section of the Adirondack region, and nearly 100 honorary members, among whom are statesmen, bankers, brokers, lawyers, editors and hotel-men, has done a great deal toward enforcing the forest and game laws of the state, in preserving the fish and game of the Adirondacks, and in encouraging tourists and sportsmen to visit what Governor Hill aptly calls, "The Nation's Play-ground."

With its thousands of acres of forests, filled with game; its innumerable lakes, rivers and brooks, filled with speckled trout and black bass, and with the enactment and enforcement of wise and practical forest, fish and game laws, the Adirondack region will continue a popular resort for sportsmen, for many years to come.

WING SHOOTING.

R. C. BEECROFT.

In a recent number of RECREATION D. T. R. asked for hints on wing-shooting. Having hunted quails, woodcock, plover, snipe, teal, canvasback, wood-ducks, prairie chickens and ruffed grouse, I will give some ideas gained through observation and experience.

For game not larger than woodcock, or bobwhites, use number 9 shot. For wood-ducks, prairie chickens, grouse, teal, etc., early in the season, use 7's. Later, when the birds are old, number 6 are better. For large water fowl and wild turkeys, 4's are large enough.

In shooting at a flying bird, the aim should not be directly at it, unless it is flying straight away and about the height of the eye.

When a bird has a rising flight, the aim should be a little above. If it is flying on a level, straight away and above the line of the eye, the aim should be a little below. When a bird flies to the left or right, hold ahead.

Always move the gun in the direction of the bird's flight, but do not "poke" or follow. Cover the object by a quick, steady motion; press the trigger at once. Some say to shoot with both eyes open. Others, to shoot the way that is most natural. I believe in the latter. If one can shoot better by closing one eye, do so; but

if as well with both open then that is the way for that person to shoot.

If you miss with the first barrel, recover your aim and fire the other. Or, if there be 2 or more birds, and you hit with the first, instantly select another bird and fire the second barrel.

When your dog stands or points game, do not hurry to flush it. Always try to drive the birds toward low, light covert instead of high or dense.

Giddy-flying birds, such as snipe and plover, will rise against the wind, so the time to shoot them is just as they turn. To do this, hunt down wind, if possible.

Always wait, when the field is open, for a bird to steady its flight before firing. Game generally appears to be farther from you than it really is. At 30 yards all kinds of birds are most easily killed, and at that distance the shot do not tear.

In quail and prairie chicken shooting, the dog should always retrieve the game as soon as it falls. If he does not, a wounded bird may run and be lost.

Snap-shooting is done by raising the gun and firing as soon as it can be leveled—absolutely necessary for woodcock, and quail, in covert.

Teal and canvasback ducks are rapid flyers, sometimes going 65 miles an hour. If the shot travel at the average rate of 800 feet a second, how far ahead of a green-wing teal, flying at a right angle to the shooter, must one aim when the bird is 40 yards away?

It takes the shot, practically, 1-6 of a second to go 40 yards. In 1-6 of a second the duck flies about 15 feet. Then this is the distance one must hold ahead. Of course this is not exact, but is near enough. A few trials will help one, and the eye soon becomes trained in judging distances. Perhaps, under ordinary circumstances, at what appears to be 40 yards; the lead should be about 10 feet, if it is a cross-shot. Less if the flight is diagonal.

When the bird is flying toward you, allow it to pass, before shooting. The breast feathers of water fowl are thick; then, too, it is difficult to allow for the flight of an incoming bird.

In quail shooting, bear in mind that the game is rarely killed at longer range than 30 yards. Ordinarily the lead for a cross-flying quail should be about 3 feet, though no fixed rule can be laid down.

In hunting with a companion, always refrain from shooting birds flushed nearer him than to yourself. Remember "there are others."

Treat an unloaded gun with the same care you would if it were loaded. Never drag a gun toward you from a boat or wagon. Many accidents have been caused in this way.

Be very cautious when in thick covert; for, in such places, one may be near another shooter and not see him.

## ABOUT THOSE COYOTES.

Gardiner, Mont.

Editor RECREATION: Your letter of May 15th, informing me that my picture of "Game Keeper and Antelope" won 12th prize, at hand. In reply beg to state that in making the picture I used a No. 4 Bullseye Kodak, size 4 x 6 inches, with the regular lens furnished with that instrument, and the film furnished by the Eastman Kodak Co., Rochester, N. Y.

Since writing you before I have left the army and am now located here, prepared to handle tourist parties for the Yellowstone Park, and hunting parties for the game ranges of Montana, Eastern Idaho, and Wyoming.

In June RECREATION R. G. W., of Horr, Mont., quotes me as saying "I can stand in the streets of Gardiner and see coyotes kill antelope." He also says "I don't say anything about seeing or hearing of the 2-legged coyotes killing elk, for their teeth or horns," and that "when you hear of antelope being killed by coyotes you can bet the most of the killers have but 2 legs;" that "when the antelope got outside of the park, last winter, a party of brave guides and hunters (of Gardiner), surrounded them and killed about 100."

I would like to say to R. G. W., and incidentally to the readers of RECREATION, that when the antelope left the park, last November, it was still the open season for that game, in Montana; that certain residents of this town, among them only one professional guide and hunter, killed antelope for their winter's supply of meat; that none of the men killed any in excess of the number allowed by the law of Montana; that previous to that time, and since then, I have seen the remains of antelope, killed by coyotes; that I have stood in the streets of this town and seen them killed, in the park; that I have seen (and can bring as witnesses a whole troop of cavalry) the remains of antelope, killed by coyotes, within 1½ miles of Mammoth Hot Springs. If "R. G. W." is the man I think he is, he is one of the class he is pleased to term "2-legged coyotes." I have heard that he killed antelope in his yard, at the time they left the park, last November, they having been driven out by the deep snow and the coyotes.

As regards Geo. Scott and Will Decker, neither of them was a resident of this town. Mr. Scott lived at Aldridge, a coal camp adjoining Horr, and Decker lived at Cinnabar. It was proven on the trial that Decker did not kill any elk, but that he was employed by Scott to help pack out the meat. Decker, being only a boy and not knowing the park lines, was brought into this trouble through no fault of his own.

The elk which "R. G. W." claims was killed by the residents of Gardiner, was

driven out by the deep snow, on the 13th and 14th of December. About 3,000 of them came over the trail from Hell-Roaring creek and passed out of the park over Crevasse mountain. I rode over that country, on the afternoon and night of December 17th, and saw where about 100 had been killed; but so far as I know none was killed by residents of Gardiner, in excess of the number allowed by law. Of all that number only one was killed for his horns. That one was killed by Geo. Scott, within the limits of the park. Much of this game was killed by residents of Cinnabar, Bear Gulch and by people living near these places. All the meat was taken, showing plainly that the elk were killed only for food.

During the winter of 1895-1896 elk and deer were killed in the park, near here, for the saddles and horns only. The men who did the killing were arrested, tried, convicted and punished, under the laws then governing the park.

During the past winter, so far as known by any of the persons patrolling the park, no game has been killed within or near the park, for tusks or horns. I have ridden over the country a great deal and have seen nothing to indicate that game has been killed for such purposes. The past winter was a hard one, and the game died by the hundreds. I have seen bunches of 5 to 9 elk, all dead in one place, with their tusks gone; but from personal examination, I am positive they died from exhaustion and starvation.

Owing to the fact that all lawless characters caught in the park are brought here, when discharged and turned loose, some people seem to take a delight in claiming that all the residents here are lawless. To show the feeling that exists in regard to law and order in this town it is only necessary to state that last winter a man was arrested by the State Game Warden, for illegally killing elk, and was brought here for trial; but fearing he would be convicted here, he took a change of venue to Horr, where our law abiding friend "R. G. W." claims to live, and was promptly acquitted.

William Van Buskirk.

---

#### ON ARKANSAW LAKE.

LEWIS C. BURNELL, JR.

The cool night air gently fanned our faces as we drove up to the "O" ranch. With 2 companions, I was out for a hunt, and in a few minutes after reaching our destination, we were seated around the little table, trying to satisfy appetites made vigorous by an all-day's ride across the rolling sand-hills of Western Nebraska. After supper we gathered around the stove, to discuss the shooting on Arkansaw lake.

This lake is in the heart of the sand-hills. Here, during the migratory season, geese and ducks gather in great numbers. One may find canvasbacks, mallards, redheads, bluebills and other varieties of ducks, where they come to feed on the wild rice along the marshy shores.

The clock struck 10 as we rolled in for the night; and I was sure I had not slept 15 minutes when I received a rude thump in the side, which I was half inclined to resent; but my friends were up and dressed, while the aroma of coffee filled the room.

We probably looked somewhat like armored knights of old, in the dim light, as with hip boots and Stanley helmets, we marched across the hills. H. jumped a jack rabbit, and after giving it both barrels, watched it disappear over the top of a ridge. He redeemed himself soon, by killing a grouse that crossed our front.

Sharp-tailed grouse were plenty a few years ago, in Western Nebraska; but the merciless pot hunter, shooting before the law was off, killed the birds in such numbers they are now a thing of the past. Where hundreds could be found, only an occasional one is left.

Arriving at the lake, we saw many flocks of water fowl scattered over the glimmering surface of the water. Stationing ourselves about in the rushes, every thing was ready for the sport to begin. Presently some one got a shot and the ducks began to fly. A flock of mallards headed for my blind. Nearer and nearer they came, and in a moment were over me. Giving them both barrels, I was pleased to see 3 of the beauties strike the water. Next came a flock of bluebills, and 2 left the ranks at my summons. Then followed a miss.

So the sport continued for an hour or more. The incessant banging, on my right and left, told that my comrades were not idle. From the noise, one might have thought there was a small battle going on.

My attention was suddenly attracted by a steady "ho-onk, ho-onk." Glancing up, I noticed a long, V-shaped line coming straight toward me. Frantically I dug into my pockets for some shells loaded with heavy shot, and had just gotten them into my gun when the geese sailed over, not 50 yards high. Covering the leader, I pulled the trigger and then gave number 2 the second barrel. Both birds fell with an immense splash; one striking so near I was drenched with water.

The ducks having left for quieter places, I gathered up my birds.

Throwing the spoils on the grass, I counted 2 geese, 2 canvasbacks, 4 mallards and 8 blue-bills. My comrades soon came up with 20 birds, making 36 for the morning's shoot.

In an hour we were back at the ranch, packing the ducks in the wagon for the start homeward.

## DUCKING ON PUGET SOUND.

North Yakima, Wash.

Editor RECREATION: A few years ago I sent word to George Sneider, of Hoaquim, Wash., I would be with him for a duck hunt. Now Sneider is a hearty, jovial fellow who has shot ducks till he has it down to a system. He ran a sail-boat from Hoaquim to Owyehut, 17 miles, across the harbor. The boat was 30 feet long, carried a mainsail and a jib, and was well-built throughout. He had about 60 decoys, mostly canvasbacks; a skiff, an Irish setter and a 10 gauge Lefever gun.

When I met him at Hoaquim, he told me he had to take a small load of lumber up to the Humptulips, a river emptying into the harbor. This we landed in the evening, after a pleasant sail with the outgoing tide, and dropped anchor in the mouth of the river. During the night a storm arose and increased in violence. We could not expect any shooting till it ceased.

On the morning of the third day the storm lifted and we sailed for Owyehut. A stiff breeze blew inshore, and as we neared the landing, Sneider cried out: "Look at the canvasbacks!"

The rough weather had driven them into this cove. There were hundreds of them, flying back and forth, about a quarter of a mile from shore, where they were feeding. We had to do our shooting before the tide came in too heavy; so we worked with a will, got everything into the skiff, and pulled for the shore, to get willows for a blind. With a boatload of willows, Sneider rowed to where the ducks were feeding. The blind was quickly built and the decoys put out.

All the time we were at work, the ducks were flying. Many times I was tempted to grab a gun and shoot, but checked the desire. What a sight it was! Over 50 decoys bobbing with the motion of the waves. The ducks were moving swiftly back and forth. Now, a good bunch comes right toward our flock. They drop a little but fly on up the bay. After going several hundred yards they wheel. This time there is no mistake. Some of them settled. Others were looking for a good place, when we opened on them. Three dead, one winged. "Shoot quick or you lose that bird! If he dives, he will not come up within range." Now the dog plays a part. He brings them all in. Even while he works, we drop others for him.

This is a time when you live intensely. Every moment is full of thrilling interest. I remember distinctly how much I wished for a leather lining to Sneider's shell-box; for the noise of the shells, against the tin, sounded harsh. One feels that nothing should mar the completeness of the sport, in such a time.

They came fast enough. We tried to get

in a shot at all of them, but could not. Often a bird was hard hit and fell where the dog could not see it. Then out one of us would go, pulling as if for big wages; back again to the blind, eager for a chance at the dashing birds. How strong they are! What shooting it takes to kill them! What beauties they are, lying in the boat! Almost all canvasbacks, though there are a few mallards and pintails.

Now the tide makes its way toward the blind. The ducks have ceased to come; so we row to the big boat, after 2 hours of the best shooting I ever enjoyed. Over 50 ducks were unloaded and hung in the warehouse.

## SUMMERING IN THE TETON COUNTRY.

Tampa, Fla.

Editor RECREATION: Any one who likes to travel, should go over one of the scenic routes in Colorado. Take in Salt lake and Salt Lake City, thence on to Market lake, Idaho. From there a good stage line will take you 80 miles to Teton City, thence 20 miles, over the Teton Range, crossing it at 9,000 feet elevation to the Jackson Hole country, fetching up at the hospitable ranch of that gentlemanly guide, S. M. Leek, of Jackson, Wyoming.

A day or 2 spent resting at the ranch, and fishing in Snake river, will relieve all fatigue. Have Mr. Leek put a boat on a wagon and, either by vehicle or saddle and pack horses, go to Jackson lake, some 25 or 30 miles away. Here the outing really begins. The mighty Tetons, clothed near the base with timber and verdure, lift their snow-capped heads something like 15,000 feet high, while against their sides, at an elevation of 7,000 feet above sea level, lies beautiful Lake Jackson, 5 miles wide and 20 miles long. The scene is so grand and so beautiful that one might liken it to an Alpine range; but such American scenery needs no comparison.

There is a succession of lakes here, all near together, and connected by Snake river. The water is very deep and full of rainbow, salmon and other trout. Some have been caught that weighed 15 pounds. The air is so dry, clear and cool; the waters so cold and smooth; the scenery so captivating, that one will be loath to leave it, and several weeks will quickly pass.

The country abounds in game, and one will doubtless see many elk, antelope and deer, but these can not be hunted before September. Grouse and sage hens are plentiful, and bear can be found in the remote mountain fastnesses.

Should one tire, then on to Yellowstone National Park, only 2 days' travel. All along the route the scenery is constantly changing.

On reaching the park you can take park

coaches, or, better still, continue by your own conveyance; see the geysers and other wonders, go via Yellowstone lake to Yellowstone falls. Here you can dismiss your outfit and take the stage to Cinnabar, and thence by the N. P. Railway home. I made this trip last season, and found July 20th to September 1st the best time, as the mosquito season was then past.

It will take you some time, after you have reached home, to digest all you have seen and learned. You will begin to realize the vastness of the country in which you live, and how little you know of it. Your mind will be broadened, you will look back upon the outing with pleasant recollections, and will wonder how you could have seen so much at so small an outlay; viz. \$250 to \$300.

W. H. Beckwith.

---

#### LOOKING FOR WINTER MEAT.

Jackson, Wyo.

Editor RECREATION: Having missed the elk when they moved into Jackson's Hole, which they did during a big snow storm in November, and when thousands of them passed within 2 miles of our place, we kept looking for more elk; but could not make much headway on account of the continual snowfall. At last I had to give up getting my winter's meat from that band. However, my experience in Northern Minnesota came in handy and I made a toboggan out of a plank, a pair of web snowshoes out of a wagon bow and an elk skin. Then, with a companion, I started out to get meat, on another tack.

Having on a suit of white, canvas covered clothing, with mittens and gun-cover white, I knew if I found game I was sure of a shot. We tramped 2 days, through 3½ feet of snow and storm, to Cedar mountain, whose cone is usually swept bare of snow and where some game winters.

Putting up at a ranch our first inquiry was for game. The man said he had seen thousands of elk pass and that getting behind a bunch of 300 he had driven them past his neighbor's door, and they killed enough to last till summer. He graciously offered us all we could haul home. However, I knew deer were plentiful and wanted some venison. In the morning my partner and I started out. The weather having cleared we went to Cedar mountain and climbing it found ample signs of deer, elk, wolf, lynx and mountain lion but no game. They seemed to have gone up the river and into a large tract of willows.

Separating from my companion we took to the open plain, or sage brush flat, as it is called. I went in the open and my partner skirted the foothills. Presently I heard a shot and looking in the direction taken by

M— could see some deer running up a canyon. I could not get there in time to head them off.

I went through a cut, in some low hills, and climbed a knoll. Presently a big buck jumped up, in a bunch of poplars, and started down the hill. I could not get a good shot and saw him join a bunch of about 30 deer that had been lying in the sage brush, on the flat. Then he left them and turned into some quaking asp, in the foothills. I followed and was making good headway when I heard a snort above me and looking up caught a glimpse of his flag going over the crest of the hill.

On climbing up I saw where he had doubled on his track and waited just long enough for me to come in sight of him when he took after the bunch again. I took up the trail, skirting a bunch of willows and soon saw 4 pairs of elk antlers.

Going in I routed the elk, and waiting until they got into the open and started up the hill I picked the largest, fired and broke his back. The other 3 bulls ran about 50 yards and stood on the side hill looking back. I did not shoot at them, for I had meat enough.

I arrived at the ranch at 8 P.M. and found my companion had killed one small buck deer.

Burt Harris.

---

#### CONDENSED RATIONS.

After careful deliberation, 45 of the most experienced officers in the U. S. Army have adopted a highly-condensed emergency ration—and now we wonder why this was not done long ago. The daily ration, as issued, weighs 35 ounces, and consists of the following items: 16 ounces of hard bread, 10 ounces of side bacon, in paraffin paper; 4 ounces of pea meal (for soup), in a cloth bag; 2 ounces of coffee; saccharin (solid sugar), 4 grains, in the form of 2 tablets; ½ ounce of salt; ½ ounce of tobacco, and ⅔ ounce of pepper, in a pill-box. The total cost of the ration is 17¼ cents, and in bulk it is so small that when first issued it was viewed with anxiety akin to alarm.

On May 18, Troop E. 1st U. S. Cavalry, commanded by Capt. W. C. Brown, left Fort Sill, I. T. for a 12 days' trip, through a wild and uninhabited country, to test the staying qualities of the condensed ration. On the last 10 days of the trip, the entire troop, of 2 officers and 44 men, subsisted on only 5 full rations each; or, in other words, ½ of an emergency ration each day. The soldiers found the ration better than it looked; that it fully satisfied hunger, and sustained health and full vigor, in spite of long marches and stormy weather.

The continuous rain had a far more depressing effect on the troop than the half-rations. Although the men lost an average of 3 pounds each, in weight, in the 12 days,



they gained strength until the troop, as a whole, lifted, at the end of the trip, one ton more than when it set out.

The possibilities of the condensed ration are almost infinite. A cavalry regiment can now move long distances quite independent of the slow-creeping wagon-train—which is the hostile Indian's best friend! The independence of the soldier, in a hot campaign, would certainly be doubled.

The hunter and the explorer can now reduce their packs very considerably; and if the condensed ration is soldered up in aluminum boxes, to protect it from dampness until consumed, it may even enable him, with the aid of the sustaining kola nut, to reach the North pole, or to cross Borneo, from side to side.

---

#### WHAT CONSTITUTES A REASONABLE BAG?

The greatest duck, squirrel and quail shooting to be found anywhere is in Posey county, in the Southwestern part of Indiana. The year 1896 was a grand one.

During the shooting season of that year Mr. Seth Leavenworth, of Mt. Vernon, killed over 300 squirrels. He is a hunter for the love of the sport, and never took more than he could use. He was frequently accompanied by his wife, on his shooting trips. She is also a good shot and killed many squirrels.

The quail shooters enjoyed a lot of fine sport. The best record made, in one day, was that of Mr. John F. Kight, of Indianapolis, who, in company with Sam Stallings, bagged 105 quail in a 10 hour hunt, last November. The birds were flushed by Stallings' famous setters, and were all killed on the wing. Most of them were used by Mr. K. who sent them to his friends.

The best duck ground is Hovey's lake, where Mr. Charles J. Hovey has built a club house. Shooters from Louisville, Chicago, Indianapolis, Henderson, and Owensboro belong to the club.

The prospect is good for 1897. The squirrel law expired on June 1st, and shooters who have been out report them numerous. The number of young quails is said to be greater than ever before known. Great sport is expected next fall.

P. W. Roche, Mount Vernon, Ind.

Mr. Roche writes me a personal letter, in connection with the above notes, in which he says, "The men mentioned are all expert hunters, and not game hogs; so do not be mistaken and take them for such."

I have a high regard for Mr. Roche, and for his opinion; though I cannot agree with him in his estimate of these men. I claim that the killing of 300 squirrels by one man, in one season, is excessive. It is out of all reason, and out of all proportion

to what any ordinarily high minded sportsman would have the time, the opportunity or the desire to do.

I claim that the killing of 105 quails by 2 men, in one day, is also extravagant and unjust. In many states, there are laws which limit the killing of game, to each man, in open season. In the other states, and among sportsmen at large, there are unwritten laws which say only a reasonable number of birds or animals may be killed in one day, by one man. The consensus of these statutes, and these unwritten laws, is that 15 to 25 quails, or one dozen ducks, prairie chickens or squirrels, is enough for any decent man to kill, in one day. When any man goes beyond these limits, he is encroaching on the rights of fellow sportsmen. He is killing more than he is entitled to; and as game is gradually decreasing everywhere, at all times, he is helping more rapidly than he has any right to help, toward the total extermination. When a man makes such a bag as provided by the laws above cited, he should be ready to quit, even though the day may still be young, and plenty of game yet in sight. He should be content to sit in the shade and commune with nature, or with his companions, and to enjoy the results of his reasonable day's work.

Suppose a man spends one day each week after squirrels, during the 3 autumn months. That would be 12 days of shooting, and would certainly be enough for any but a game hog. Suppose he kills his full quota of 12 squirrels each day. He would then have, to his credit, say 150 squirrels. Mr. Leavenworth is credited, in the above report, with over 300 in one season. I therefore submit, to the readers of RECREATION at large, the proposition that he has killed at least 150 more than he is entitled to, or than he could reasonably wish to kill.

Let me hear from my readers, on this subject. I should like a frank and free expression on the question as to what really does constitute a reasonable bag, for a day's shooting, on any kind of game, in states where the law does not limit the number to be killed.

EDITOR.

---

#### PLENTY OF GAME.

Jackson, Wyo.

Editor RECREATION: I came here 3 weeks ago for recreation, and find lamentable evidences of an unusually severe winter. The decaying carcasses of elk are to be seen everywhere. The natural supposition would be that elk are being exterminated; but from careful investigation I am satisfied they are increasing rapidly. More elk have been seen the past winter than for years. This is no doubt due to the better protection resulting from the enforcement of

the game laws and the driving out of the Indians.

The young elk seem to have fared worst last winter. It is estimated, and I think correctly, that about 4,000 calves succumbed to the cold and snow. The old animals withstood the winter as well as usual and few carcasses of these can be seen. This great mortality among the young elk is due to their lack of strength to break the crust of the snow, to get at the feed.

However there are more calves left than usual and fine sport may be anticipated later. Every day, for the first 10 days after my arrival, elk and deer could be seen from the ranch, feeding on the hillsides; but the disappearing snow has given them wider range, and they are passing back into the mountains.

Antelope are traveling North, to their summer range. Bands of 20 to 80 are seen every day.

Trout fishing is poor on account of rising and muddy waters. However, a few small creeks yield fair sport. On the day after my arrival at the ranch S. N. Leek, at whose place I am staying, caught, with fly, 9 trout that weighed 24 pounds—4 of them weighing 16 pounds. All this in 3 hours. I have made several fine catches, some exceeding Steve's in numbers and total weight, but not so large. Ducks and geese are nesting as are, in fact, all kinds of birds.

B. F. Jones, M.D.

#### SALT LAKE, UTAH. WHERE TO GO.

Editor RECREATION: For the benefit of the devotees of rod and gun the following pointers are given as to the game to be found in the Rocky mountain country, about Glenwood Springs. Among the birds are the sage grouse, the largest of the grouse family. These are found in the open country. Blue grouse are found, in large numbers, along the trout streams and in parks. The pin-tail grouse inhabits the streams and willows. It is a quick bird and affords rare sport. The ptarmigan is about the size of the ruffed grouse and is found only above timber line. In winter its plumage is snow white. The following varieties of ducks abound in the mountain lakes: Mallard, canvasback, redhead, bluewing teal, greenwing teal, cinnamon teal, golden eye, butter ball, wood-duck and shell-drake.

Elk still abound and are in prime condition by September, in which month they commence bugling. Large bands are in the more remote parks, and near the flat-tops.

Deer are at their best in the fall months. They frequent the valleys and lower mountain ranges until winter, when they move down to the low country. The sportsman who wants bear can have his chance of cinnamon, black, brown, silvertip and grizzly.

As to the mountain lion, or puma, it has occasionally been captured in this neighborhood, measuring 9 feet 6 inches from tip to tip. Plenty of bob-cats, wolves and wolverines. Mountain sheep are to be found in the higher ranges.

W. H. Hubbard, Glenwood Springs, Col.

A curious case was passed on by Attorney-General Fowler, of Wyoming, with reference to the right of J. A. Adams, a Jackson's Hole ranchman, to retain, in his possession, 77 head of elk. These came into Mr. Adams's corral, during the past winter, and were eating his hay, when he fastened them in and kept them. A demand for their release was made by the State Game Warden and Mr. Adams refused to comply, saying he intended domesticating the animals and that as he had saved them from starvation he was entitled to their possession. The Attorney-General's opinion is to the effect that the elk are the property of the State and that their retention is a violation of the State game law, which forbids capture of wild game, by pit-fall or trap.—Salt Lake "Tribune."

Above clipping is indeed an interesting one, in that it opens up a fine point of law.  
L. M. Earl.

#### DEER IN THE ADIRONDACKS.

Saranac Lake, N. Y.

Editor RECREATION: It is usual at every session of the Legislature to offer numerous amendments to the game laws. In my opinion, what we need is not new fish and game laws, but the enforcement of those we have. In some parts of the Adirondacks, the game laws are frequently violated every year. This is not, however, the fault of the Game Warden, but because of lack of sufficient resident assistants.

The Adirondack Guides Association includes the best guides from nearly every portion of the Adirondacks, and it seems to me proper the game protectors for this region should be appointed from among its numbers.

I believe that killing deer in the water should be prohibited, and that if hounding is permitted at all, shooting on the runway only should be allowed.\* I think the majority of sportsmen and guides are agreed that the killing of does and fawns is inhuman, and should be prohibited. Anything that will preserve the game of the Adirondacks and increase the number of deer, birds and fish, will be beneficial to the region and to the business of the railroads, hotels and guides.

Seaver A. Miller.

\* Hounding and jacking are now prohibited in New York, for a term of 5 years.—EDITOR.

#### LOOKING FOR DUCKS.

On the morning of March 8th, with 2 friends, K— and S—, I left the train at Beardstown, Ill., on the Illinois river. We rented a boat big enough to hold 3 men

and pulled down stream; finally landing and engaging board at a farm-house.

Now we were ready for the ducks. We could go in any direction, for the river was out of its banks and all over the country. Crossing to the South side, I left S— and K— among the trees, while I rowed around to stir up the ducks. The men in the timber blew their calls until the woods echoed with their duck music, but the ducks could not be induced to come within gunshot. We did not give up until approaching darkness drove us to the house.

In the morning we rowed up a creek 2 miles. The rain soon came and drove us to shelter. No ducks yet—rather discouraging, we thought. We stayed around the fire, at the farm-house, until about 4 o'clock, when S— started out alone. He saw some mallards go down in a cornfield and thought he could make a sneak on them. He did succeed in killing a duck—canvas-back, he called it—and came in elated.

During the afternoon a member of the Griggsville Gun Club came to the house. On examining the duck, he said it had been wounded before S— killed it, and was sick and not much of a duck anyway. We did not tell S— of this, for fear he would be discouraged.

That evening we all went out but failed to get any game. The next day, our success being no better, we returned to town.  
W. H. Whitney, Chatham, Ill.

#### AN UNWELCOME STORM.

Glenwood Springs, Col.

Editor RECREATION: Bill and I had walked our soles thin in trying to get a shot at some elk we had seen, up in the mountains. Leaves and twigs were so dry game could hear us a mile away, in spite of our "noiseless, non-slipping, guaranteed waterproof" shoes.

After a pow-wow, we went to camp to await snow, which seemed about due. It came, and it was of the wet kind. We had a small tent, with a poor excuse for a centre pole. At 2 o'clock in the morning we were called on to awaken.

The pole had broken, and there we were. Dark as pitch, and snowing as it can snow only high in the mountains. After a consultation, we decided to take things coolly. This worked all right at first, but about 5 o'clock, the warmth from our bodies began to melt the snow. The water came inside, in rivulets, until it would have been a credit to anybody to be jolly under such conditions.

Another pole must be cut. After scraping for half an hour, to see which should have the honor of going for it, Bill was victorious. When he came back with the pole, it was about 3 feet too long. I

thought it would be a good plan to stand up under the tent, letting it rest on my head, while he was chopping off the pole.

In pulling the tent around, to get the centre over my head, I found a slit 15 inches long, made by the pole in breaking. My head slipped through this before I knew what had come over me; but I felt sure half a ton of the beautiful went down my back.

Like 2 jays, we had pitched the tent under a balsam, for the shade, not thinking of the snow that might come. While I was shouting to Bill to hurry with the pole, he knocked all the snow off the tree, from the ground up. I was right where I got the only snap I ever had in my life.

I did not have a camera and a flash-light, but I would give a good price for a picture of Bill in his "mighty," out in the snow, cutting a pole just the right length; and the other fellow taking a snow-bath at 5 a.m. on the 22d of October. However, we killed an elk. All's well that ends well.

J. E. M.

#### WHERE DID HE STAY THAT NIGHT?

Editor RECREATION: Last September our party of 4 left this place for a 2-weeks' deer hunt in the Adirondacks. While there, we had a peculiar experience. If any reader of RECREATION has had a similar one, I should like to hear from him.

We camped at our old grounds of several years before, on Twitchell creek, Herkimer county. In '95 I shot 2 deer within ½ mile of this camp; but last fall game was not so plentiful.

While 2 of our hunters were returning to camp one evening they fell in with a guide. As they were all walking on a skid-way, about 5 rods apart, a deer bounded across their path. The guide gave it 2 shots; the next hunter fired 5; while 2 more were given it by the 3d man. At the last shot the deer dropped, or at least disappeared.

On going to the spot where it was supposed to be, nothing was found. Tracks led to that spot, but no farther. The hunters circled for a quarter of a mile around, but not a sign of a deer. About 20 rods from the mysterious spot, at a point where the skid-ways joined, the hunters stood and talked the matter over.

The peculiar part of the story is that on the following morning, at the very spot where the consultation was held, the deer was found dead. Five bullets had hit it; 2 of them, ordinarily, would have dropped a deer at once.

Now, where was that deer when we were looking for it?  
Schenevus.

As water is the standard in specific gravity, RECREATION is the standard of sports-

men's periodicals. Although not a hunter myself, and, in fact, unable to stop the easiest mark that walks the woods, I do not believe in game destruction. During October the number of outside hunters in this State was large. A Wisconsin Central railroad man told me he saw over 300 sportsmen, from Ohio and Indiana, unloaded from one train, between Chippewa Falls and Abbotsford. The State law forbids the shipping of game out of the State, and none of these men ever sell what they kill. So there certainly is, on the one hand a needless destruction of game, or an unlawful shipment of venison out of the State. It is safe to say that fully 1,500 visiting sportsmen come to Wisconsin each year.

L. J., Marshfield, Wis.

The law protecting quail in Indiana, allowing no open season for 2 years, has resulted already in a notable change in the habits of the birds. They are tamer, and are nesting in the meadows and orchards, on all sides. In one of 2 nests, found this week, were 17 eggs; and in the other 40—an extraordinary sitting. Two broods in a season are frequent, in this latitude, and such a nest of eggs shows how rapidly quail may propagate if left undisturbed, for a time, now that so many of their natural enemies have become practically extinct.

The law allows the shooting of young squirrels, with the beginning of June, and thereafter the beech woods of this hilly region—Orange county—will echo with the sound of shotguns and rifles. Just now there appears to be a gray squirrel for every bush.

Stanley Waterloo, Paoli, Ind.

That was an interesting article, in RECREATION, on "Wing Shooting." The boys should be delighted with it. It contains such a fund of information and pointers, that they should have no difficulty, now, in becoming expert shots.

Why not give the fish hogs a rest and turn your attention to those miserable suckers who call themselves sportsmen and who, in your part of the world, have been out killing off the snipe and woodcock, as they land from abroad, on your hospitable shores? Do you know the birds have their eggs and young, with us? How much earlier must they be with you? Don't you think it a cruel, beastly shame to shoot these birds in spring, when the females are carrying their eggs, and in some cases have their nests and even their young? I can not understand why any fair minded sportsman would countenance such murderous, brutal, unfeeling and damnable action.

Get out from under such a stigma, as

quickly as you can. Use your best efforts to protect, instead of to destroy, birds and their young.

Get your wise senators to pass a law to keep these migrants from landing on your shores. Let the birds come on here, and we will see that they are not destroyed in the breeding season.

H. Austen, Halifax, N. S.

Mr. Austen is right. The killing of any game bird, or animal, in spring, is nothing more nor less than slaughter, and all the better class of sportsmen have long since quit it. The other kind should be compelled to quit.—EDITOR.

Your latest number of RECREATION at hand, and it is all right, of course. They all are. I thoroughly agree with you in the stand you take for better game protection.

There is more money to a community of business men, working-men, or farmers, for every head of large game honestly killed and used by sportsmen, than for an equal number of domestic stock. Every outfit that goes into the hills pays \$10 to \$100 a head for all the game it gets. This money is left where it is most needed. Therefore I say "Why kill the goose that lays the golden egg?"

I believe in a small license for non-resident hunters, merely nominal; say \$1; just to require them to show their good intentions, and to place each man on record.

A. R. Randles, Seattle, Wash.

There is practically no game here, although a few years ago excellent small game shooting was to be had. Game hogs have done the work. To see a gray squirrel, ruffed grouse or quail is now a rarity. Formerly there was fine bass fishing in the streams and dams, but the carp have cleaned the good fish out. I think the carp more of a curse than the English sparrow. Several men here have been prosecuted for illegal hunting. I am glad to see it, and am pleased to know that brother sportsmen are touching the thing up in other localities.

I have RECREATION on my desk and can say of what it advocates, "them's my sentiments too."

J. H. C., Salem, O.

The following is a list of the officers elected at the annual meeting of the Bergen County Gun Club, held in Hackensack, N. J., June 10th, 1897.

President, G. P. Griffiths; Vice-President, Marshall Herrington; Treasurer, H. D. Warner; Secretary, E. A. Jackson. Trustees, Graham Van Keuren, H. N. Hall, H. J. Blauvelt.

This club was organized in June, 1896, and had its first shoot on July 4th of that year. Since that time the club has trapped 100,000 targets and has sold, on the club grounds, 17,000 loaded shells. It has 85 active members on its list, and no honorary members. The club shoot is on the 4th Saturday of each month. The principal attraction, on the calendar, is the impending shoot for the RECREATION cup, representing the amateur championship (clay targets) of the State of N. J. This trophy is shot for once every 2 months, during 1897, on dates as announced by the Club.

There is a regular practice shoot each Saturday afternoon, and all readers of RECREATION are invited.

Sportsmen have been very successful in this county, the past hunting and fishing season; but the pot-hunters were also active. We have, about here, woodcock, pheasants, Wilson's snipe, ducks, rabbits, and squirrels, enough to please any reasonable man, if he knows their grounds. Black bass, pickerel and carp are caught in fair numbers in the streams and lakes.

The non-enforcement of game laws has made some hunters, who may call themselves sportsmen, bold in their shooting, out of season. They come here under the pretense of shooting woodcock, early in the season, and kill many young ruffed grouse. My old woodcock dog nearly always turns tail and skulks away, on meeting such men in the brush, as if ashamed to be seen near them.

Enough of this "calamity wail"! All that we lovers of rod and gun ask, is to have a fair field and game killed only in season—none for market.

H. H. E., Springboro, Crawford Co., Pa.

New Petersburg, O.

Editor RECREATION: Squirrels and rabbits are plentiful this year, although a great many were killed by the market hunters. One party of 2 killed over 400 gray and fox squirrels during last open season, September 1 to December 15. Many were killed out of season, also.

Another party killed, in one day, 53 rabbits and 64 quails. I heard a game butcher say he killed 16 quails at one shot, as they were on the ground, huddled together.

I went squirrel hunting one afternoon last season, starting about 2 o'clock. I hunted till 5, killing 8 grays, which was as many as I wanted.

RECREATION is the best magazine published, and I would not be without it for 3 times the regular subscription price.

Wm. Dwyer, M.D.

Allow me to correct the statement of "E. L. B.," in June RECREATION, in reference

to the law of this State governing the killing of moose and caribou.

Our last legislature passed a new game law and the following is the provision, at present, on this subject:

"No person shall hunt, catch, ship or have in possession, or under control, at any time, any moose or caribou; except that antlered moose and antlered caribou may be killed between the 5th day of November and the 10th day of November, in the same year; but no person shall kill more than one moose and one caribou in any one season."

The law has the usual provision, forbidding shipment out of the State.

W. W. S., Duluth, Minn.

On returning from my Florida hunting trip, I found RECREATION awaiting me. I derived so much enjoyment from it that I feel like thanking you and doing something in return.

A writer in RECREATION mentioned shooting quails in trees, and the idea was ridiculed by some hunters. While in Florida, I had the misfortune to have a yellow cur for a companion; and he was better for snakes than for quails. He thrashed around 50 to 100 yards ahead, frightening the birds so they often took refuge in the pines. I killed more from the trees than on the wing. I imagine I hear shouts of laughter, from wing-shots.\*

D. T. T.

A green match at live birds took place on May 12, 1897, under the auspices of the RECREATION Gun Club, of this place. Prof. B. P. Gentry and C. E. Darrow challenged Dr. C. E. Still and H. E. Patterson to shoot a friendly match of 10 live birds, at 25 yards rise, 100 yards boundary. None of the gentlemen had ever shot at a live bird, from a trap. All however have had some experience in the field, and at inanimate targets.

The birds were exceptionally tame, and fairly good scores were made, considering everything. Following are the figures:

Gentry 9, Darrow 6—15; Still 8, Patterson 10—18.

H. C. D., Kirksville, Mo.

We have a fish and game association, with 34 members. We turned out 10 dozen quails last year, and had fine shooting in the fall. In 10 minutes after leaving town, one afternoon, my dogs were standing a large bevy. I killed 6 and returned, being gone only an hour. If we had more sportsmen who would turn out birds in the spring, use common sense and not try to kill them all in one day, no one would have to take a week every fall to kill a few birds.

W. H. C., Dunellen, N. J.

\* It is not unusual for quails to light in trees; but it is unsportsmanlike to shoot any bird while sitting in a tree or on the ground.—EDITOR.

We have all kinds of game here, and it is on the increase, excepting deer. Quails have increased 50 per cent. in the last 5 years, owing, perhaps, to the law prohibiting killing them for 5 years.

Would say to A. M. C. I am using a 16 gauge gun, and for small game, such as rabbits, grouse, and ducks, I find it equal to a 10 or 12 gauge.

In answer to G. M. C., in regard to Red lake, Minn.—there are ducks, geese, deer, grouse, chickens and rabbits in that vicinity.

I am getting some subscribers for RECREATION, for I think it the best magazine published. E. W. D., August, Wis.

Greater slaughter than was visited on the rabbits last season has not been seen in this locality for many a year. It was not uncommon for some of our Indian pupils to bring in 6 or 8, each, daily, caught in wire snares. Previous years the majority of the older hunters thought it beneath their dignity to go rabbit hunting, but this year every one who could shoulder a gun was stricken with the rabbit fever. Big game, too, was very plentiful.

The Indians report that the deep snow had little effect on deer and moose; but when thick crust forms after the snow begins to melt, destruction comes to them from the game hogs who prowl about the reservation. K. H. C., Leech, Minn.

In the vicinity of Hammonds Plains, this Province, as good woodcock shooting can be had as in any place I know of. That is about 15 miles from Halifax. Ed Thompson, of Hammonds Plains, and I have bagged, in one day, 15 cocks and 10 ruffed grouse.

There is good moose shooting near here; also fine fishing. Trout are taken weighing 4 and 5 pounds. During June, July and August, sportsmen can generally kill good numbers. C. F. R., Halifax, N. S.

About the middle of March I saw a deer cross the Delaware, at this place. The river was high and full of running ice. The little buck plunged in, swam a short distance, then clambered up on a cake of ice. In this way, swimming and floating, he crossed; but a crowd of boys started for him. The buck turned and plunged in again; swam to the New York shore, where he was once more scared into the water. This time he drifted down the stream, probably making good his escape. This was the first deer seen here in a long time.

Louis Boettger, Callicoon Depot, N. Y.

Texas is a big state, and a good field for missionary work in sports. I think the best way is to get RECREATION well circulated. It will undoubtedly do the rest.

Quails are abundant here, but trapping

is thinning them out rapidly. There is a restaurant keeper here who kept about 2 dozen live quails in his window all winter, killing and serving them whenever called for; the supply being kept up by his game hog accomplices. I never went past the place that I did not feel like smashing the window—and the proprietor too. I would like to see the guilty parties roasted, brown. The English language is too poor to express my sentiments.

G. A., Ft. Worth, Texas.

I am willing to stop spring shooting if laws are passed prohibiting it; but I hope a law limiting the number of ducks killed, in the fall, will pass first. Some bags we read of being made, down in Texas, ought to start an army down there with guns; not to shoot game but game hogs.

I would like to see a national law passed, limiting the amount of game to be killed or held in possession, at one time, to 1 deer, 5 geese, 10 ducks or grouse and 20 quails. Would not all sportsmen be benefited by it? E. S. Billings, Syracuse, N. Y.

I greatly enjoy reading RECREATION, and look for its coming each month. We have many sportsmen here, and a good many game hogs. I know one man who killed over 90 grouse last fall. If our game is not protected, in the near future, it will soon be as scarce as eels' feet. We have excellent duck shooting here, from about the first of September till about the middle of October. My favorite hunting ground is along the shores of the beautiful Richelieu river.

Some good catches of fish have lately been made. E. G. F., Noyan, P. Que.

We have just organized a gun club, of 20 members, in our ward, and have named it the RECREATION Gun Club. We have had quite a discussion in the club as to the proper drop of a gun. An answer from some of the readers of RECREATION would be appreciated.

F. W. Kutz, Easton, Pa.

I thank you, gentlemen, most heartily, for the honor you have conferred on RECREATION, in the choice of a name for your club, and it affords me great pleasure to send you herewith a handsome flag, appropriately inscribed. EDITOR.

A den of red foxes was unearthed, from a hay stack near here, recently. Five puppies were found and the old ones were seen, but they kept just out of gun range. The finders intend to domesticate the little fellows, which appear to be about 4 weeks old.

Bob Whites, pinnated grouse and fox squirrels are plentiful. I flushed 3 ruffed grouse a few days ago in the woods near my residence. Sangamon, Ellsworth, Ill.

I would like to say a few words about game protection. I see the different states are passing laws limiting the number of deer to be killed or held in possession, at one time. This is right. It strikes directly at the game hog and the market shooter, alike. I favor neither but consider the market shooter the better of the 2.

I read a great deal about spring duck shooting. Some men go out in the fall and kill 20 or more birds in a day. Would it not be better for that man's health if he went out one day in the fall, and killed 10 ducks, then stopped and killed the other 10 some day the next spring? Would it be any worse on the ducks, provided shooting was stopped after April 1st, before the ducks begin to nest?

It would please all true sportsmen if these game hogs would, when they so long to slaughter something, adopt the same plan we did, last Saturday, at the Woodland Gun Club grounds, and scatter inanimate targets all over a 5-acre lot. When this was done there was just as much game in old Connecticut as before and we were just as happy as if we had killed 100 birds.

The following scores were made, out of a possible 50: Burbridge, 49; Bisley, 47; O. B. Treat, 44; Lucas, 44; Geiselman, 43; Cushman, 42; See, 36; Owen Treat, 35; F. Olmstead, 33; Pitkin, 27, and Waterman, 27.

Geo. W. Lucas, Hartford, Conn.

I live in a nice little city, at the highest point of the Ozark mountains, in South Missouri. We have nearly all kinds of small game, i.e., foxes, coons, 'possums, red and gray squirrels, quails, ruffed grouse, turkeys, minks, and some deer. The streams furnish plenty of fish, both for home and shipping. There are bass, pickerel, cat, suckers, red-horse, perch, buffalo and carp. The game laws are so strict as not to allow much chance for "game hogs."

RECREATION is the best sportsmen's book published.

T. A. Chapman, Mountain Grove, Mo.

Game in this locality wintered well. Mountain sheep are seen here quite often. Last spring the swans sat around on the ice for over a month, waiting for the lake to thaw out. They fed in the creeks at night. They get very weak, and it was sometimes possible to catch them in the creeks, as they could not rise without having 50 yards of straight course. I think RECREATION is getting better all the time. I could not do without it.

J. B., Magdalen, Mont.

The Kensington Gun Club was organized here, on Wednesday, May 12th, with 20

charter members. The following officers were elected: President, H. P. Bennett; Vice-President, C. B. Woolley; Secretary, C. L. Edwards; Treasurer, H. G. Woolley; Captain, H. C. Mapes, Jr.

The new club will shoot on the Kensington Park grounds.

Chas. L. Edwards, Long Branch, N. J.

I have been so busy this spring I went hunting only twice. Got 2 ducks each time, but as spring shooting is not a good thing to engage in, I am not sorry I did not kill more. The prospects for fishing and hunting, the coming season, are good.

Enclosed find \$1 for renewal to RECREATION. Can't do without it.

J. J. McN., Cimarron, Col.

I am an enthusiastic sportsman, but have had no outing for 3 years, except to wheel 15 or 20 miles, occasionally, and to shoot gophers with a little Winchester 22. In the winter I hunt rabbits, with the same rifle, just after a light snow. There is worse fun than that, when a fellow can get nothing better.

A. McE., St. Paul, Minn.

We have not much game here, owing to the game laws not being enforced. The foreigners, who work in the glass factories, from lack of information or with no regard for the laws, kill game at all seasons. I have known some of our enlightened American citizens to do the same.

J. H. C., Springdale, Pa.

I am interested in game and its preservation. This part of Colorado was at one time full of game, but the redskins and game hogs have thinned it out. We have a new game warden who means business. Perhaps things will improve.

R. B., Durango, Col.

I like RECREATION, as does everyone who once reads it. Good duck shooting on the lakes and ponds along the Big Muddy last season. Market was glutted with mallard, teal, and other wild fowl all the time.

G. A. H., Kansas City, Mo.

Several deer have been seen here this winter. Ruffed grouse are very plentiful, but Bob Whites are scarce. These, with foxes and rabbits, are our only game.

H. B. B., Kent, Conn.

Please send me the names and addresses of all the sportsmen of your acquaintance, in order that I may send them sample copies of RECREATION.

## FISH AND FISHING.

### TROUT CULTURE IN MONTANA.

Editor RECREATION: I am thinking of starting a private fish hatchery here soon, and intend to raise various kinds of trout, land-locked salmon, and grayling.

What is the best trout to stock with? The ones that grow quickest and to the largest size, are what I want.

I also want some books on fish culture, in all its stages. What are the best books on this subject?

I think of stocking my pond with black bass, also, but understand they and trout cannot live together. Will you kindly tell me if this is so?

W. Plunkett, Toston, Mont.

I referred this letter to Prof. B. W. Evermann, who replies as follows:

"Nearly all the species of trout will do well in the waters of Southwestern Montana. The native species, the cut-throat trout, will do especially well. In addition, I would recommend such of the other varieties of that species as he can get. Among them are the Columbia river trout, Rio Grande trout, Colorado river trout, Yellow-finned trout, etc.

"The Rainbow trout (*Salmo irideus*) is one of the most hardy and most rapid growers. The grayling and the Rocky mountain whitefish are excellent fishes to experiment with. The black bass should not, of course, be put in the same ponds with trout, if you want the trout to live.

"Here is a list of the more important books on fish culture."

"Domesticated Trout: How to Breed and Grow Them," by Livingston Stone. For sale at Cold Spring Trout Ponds, Charleston, New Hampshire. Fourth Edition, 1891.

"Practical Trout Culture," by J. H. Slack, M.D. For sale by The American News Company, 41 Chambers St., N. Y.

"Fish Hatching and Fish Catching," by Seth Green and R. B. Roosevelt. Union and Advertiser, Rochester, N. Y.

"Trout Culture," by Seth Green. For sale by Morey & Co., Rochester, N. Y.

"Artificial Propagation of Fish," by Theodatus Garlick. For sale by J. B. Savage, Franklyn St., Cleveland, Ohio.

"American Fish Culture," Thaddeus Norris, Porter & Coates, Philadelphia, Pa.

"Fish Culture," by Francis Francis, 128 Grand St., N. Y.

"The Goldfish and its Culture," by Hugo Mulertt, 173 Nostrand Ave., Brooklyn, N. Y.

"The Amateur Aquarist," by Mark Samuel, 10 E. Sixteenth St., New York.

"Carp Culture," by L. B. Logan, Youngstown, Ohio.

"The History of Howietoun," by Sir Ramsey Gibson Maitland. For sale by J. R. Guy, Sec. Howietoun Fishery, Stirling, N. B.

"An Angler's Paradise," by J. J. Armistead. For sale by Wm. Wesley & Son, 28 Essex St., Strand, London, W. C. England.

"The U. S. Fish Commission will soon publish special reports, or manuals, on the culture of several species of trout. They will be just what Mr. Plunkett will want,

and I shall have copies sent him as soon as they are published.

"Mr. Plunkett will find it helpful to visit the U. S. Fish Hatchery at Bozeman, Mont., and to confer with the Supt., Dr. Henshall."

In reply to Professor Evermann Mr. Plunkett writes again:

Editor RECREATION: Your letter, enclosing Prof. Evermann's, and list of books on Fish Culture, received to-day.

In Helena there is a great demand for Eastern brook trout, and they command nearly double the price paid for Montana trout. Under these circumstances I should like to stock my pond with these fish, and should like to know if they would do well here. Could I obtain yearlings, from the Government, to stock my pond with? How many fish can be kept healthy (without feeding) in a pond 300 yards long by 100 to 150 yards wide, with a depth of 20 feet at the lower end and sloping back to nothing? The pond is fed by spring water, and has a steady flow, in and out. It has also an abundance of natural food—small snails, etc.

W. Plunkett.

To this second letter Professor Evermann replies:

"I have no doubt the Eastern brook trout (*Salvelinus fontinalis*) would do well in Mr. Plunkett's pond. The experience of the Commission indicates that he would have no trouble in rearing them in that region. The number he can keep will depend largely on the abundance of natural food in the pond. With plenty of food, such a pond would accommodate at least 600 to 1,000 adult fish; but this question of food will be an important one.

"I can not say whether he would be able to get a supply of yearlings from the Fish Commission or not; but would advise him to send to the Commissioner for blanks, on which to make his request for the fish. When he receives the blanks he should fill them in and forward to the Commissioner through his Congressman."

### EXCESSIVE CATCHES.

Carritunk, Me.

On May 28th I went to Indian Pond to meet Mr. W. Y. Wadleigh and Mr. A. E. Wheaton, of Boston, who were making their annual fishing trip to Mike Marr's camps; but owing to the high water and poor fishing we only remained there 2 days. We then went to Parlin Pond, where N. W. Murphy has a fine sportsmen's hotel. We arrived there June 1st and caught 20 trout, in one hour, in the afternoon. Wednesday



we went in to Grace Pond, 5 miles from Parlin, where Mr. Murphy has some good log cabins for the accommodation of his guests. Wednesday afternoon Messrs. Wadleigh and Wheaton took 120 trout, in one hour. Thursday, in 3 hours, they took 130 trout. Friday morning they took 162 trout, and returned to Parlin Pond in the afternoon. All the trout were taken with the fly. Grace Pond is one of the best fishing Ponds in Maine. I have seen 100 trout taken there, on the fly, in one hour. These trout are not large—running from 1 pound down—but they are very gamy.

On this trip we saw 26 deer, 5 of which were seen from the hotel at Parlin Pond, where they come to feed, in the fields, night and morning. Deer are increasing rapidly, owing to the light snow last winter, and to the vigilance of the game wardens.

Geo. C. Jones.

Please note the statement that on Wednesday afternoon Messrs. Wadleigh and Wheaton took 120 trout, in one hour. This is, we will say, 60 to each man, or one trout each minute to each man. What kind of fishing is that? It reads as if the men "yanked" the fish out, yanked the fly from their mouths and returned it to the water as quickly as possible. That is not the way sportsmen fish.

Further: Mr. Jones says these men took 120 trout on Wednesday, 130 on Thursday and 62 on Friday—a total of 412 trout for 2 men in 3 days. What kind of fishing do you call that? In what department of the animal kingdom do these men belong? Will the class in Natural history please answer?

EDITOR.

#### IS THE BULL-HEAD THE REAL OFFENDER?

New York.

Editor RECREATION: I noticed on page 372, of May RECREATION that "E.C." says "a man caught 200 bull-heads in one afternoon." This statement elicited the remark from you, that he should be branded as a fish-hog. If those 200 fish were trout, or even pickerel, there might have been some excuse for your censure; but as it stands, I don't think there was.

I had the pleasure of spending all of last summer in the Adirondacks, at Indian lake, Franklin County, where fair trout fishing is to be had, by going some distance for it. There was a time, not very long ago, when the lake was simply filled to overflowing with trout; but about 6 years ago, some short-sighted person emptied 2 pailfulls of bull-heads into that lake, and now where are the trout?

The spawn of the trout has a peculiar fascination for bull-heads, and this is the cause of the decrease in the quantity of trout; while the bull-heads live, multiply and continue the work of destruction.

To be sure, numbers of sportsmen visited

the lake, during the summer months, and helped to rid it of trout; but the bull-heads are the principal offenders.

Now, Mr. Editor, if these bull-heads are not "fish-hogs," who are? If the lake, "E. C." speaks of, is as full of bull-heads as Indian lake is, there is no fear that human hands will ever rid the place of them. They are, also, a constant nuisance to those who are fishing for trout, sometimes in their greediness even taking the fly.

Instead of an indirect censure, I think a vote of thanks should be extended, by all trout loving anglers, to this fisherman, who has killed 200 fish-hogs in 1 afternoon. Surely his was a most noble day's work.

It has been plainly shown that trout and bull-heads cannot peaceably occupy the same waters, and of the 2 which is preferable for eating and for sport? To show the little value of the bull-heads, they are unprotected, and, in my mind, it would not be going too far to offer a bounty for them.

I am a close reader of RECREATION, and like it very much. I especially like the stand you have taken against market-hunters, game and fish hogs; but in this instance, I think the fish itself was the fish-hog.

W. G. C.

If the lake in which the man is said to have taken the 200 bull-heads is trout water, that would put an entirely different phase on the subject; but it was not so stated in the note referred to.

EDITOR.

Editor RECREATION: Your magazine is the best of its class published. In fact, it is in a class all its own. But once in a while your level head gets wrong. You take exception to the appointment of the Rev. Z. T. Sweeney as State Fish Commissioner of Indiana, for some unknown\* reason. You are doing a clever gentleman and an ardent sportsman a great injustice. He has been in office but a few months, and has accomplished great good. He has broken up two gangs of dynamiters and seiners, in the Northeastern part of Indiana, and has captured and destroyed over 100 seines. He has compelled a number of factories to build fish ladders. This, in addition to appointing a good staff of deputies, is his record, up to date.

Give him a chance. He is so far ahead of any of his predecessors that the improvement is noticed already. He will prove the best fish protector Indiana ever had. I am not personally acquainted with Mr. Sweeney, and am not defending him for any reason, other than that his record is such a contrast with that of former officers that it is deserving of praise. I welcome the change. It means that our waters (and

\* I did not object to Mr. Sweeney's appointment, for an "unknown reason." My reasons are fully and frankly stated on pages 468 and 469 of June RECREATION. I am delighted to learn, however, that Mr. Sweeney is doing such good work, and heartily commend him for it.—EDITOR.

there are none better for game fishes), are to be protected if it is in the power of man to do so.

P. W. Roche, Mount Vernon, Ind.

Why is it no salmon are seen, or caught, in a pond which several years ago was stocked with both land-locked salmon and black bass, the salmon being the larger at that time? What is the proper time of year to fish for the salmon? What bait is best? Is deep or shallow water best for the fishing ground?

Mrs. O. R. Hood, Abingdon, Mass.

Experience has shown that it is never safe to put black bass in the same pond, or stream, with any other fish, if you want the other fish to live.

The life of a land-locked salmon is not worth much when pitted against that of the large-mouthed black bass. In the case mentioned it is impossible to tell just why the salmon disappeared, without knowing more about the conditions which exist there. Granting that the physical conditions were equally favorable to salmon and black bass, which was probably not the case—then if the salmon disappeared they were either caught out, or the bass had something to do with it. The bass could easily keep any salmon that might be hatched in the pond, from growing to any size.

Don't put bass and salmon in the same pond. It is hard on the salmon.

A gentleman who has had much experience fishing for land-locked salmon, in New England, says the last half of May, and during June, is the best time to fish for them. They take the fly readily; but are also taken with live minnows or smelt. At that season they rise to the surface readily and can be found in shallow water.

Editor RECREATION: I enclose you a newspaper clipping *re* a big salmon, caught in the Columbia river, which will perhaps interest your readers and give them an idea of the size to which some of our salmon grow.

The largest salmon ever caught in the Columbia river was delivered at a packing house at Astoria last week. It was a royal chinook salmon and measured, from tip to tip, 4 feet 5½ inches. Its largest circumference was 3 feet, the girth, close to the tail, being fully 1 foot. The spread of the tail was 1 foot 4 inches, and the exact weight 81½ lbs. The head, when severed from the body, weighed 8½ lbs. On being cooked and packed the fish filled 5¼ dozen one-lb. cans.

Some prominent fish dealers tell me larger salmon have been caught in these waters, but the largest I have seen, weighed only 78 pounds. What a shame that such a grand specimen of the king of fishes should be cut up and canned, instead of being preserved, whole, for exhibition!

A short fish story may be excusable, in this connection, and while it may be en-

tirely unlike the usual fish yarn, it is absolutely true. The Yellowstone lake, in shape, is similar to an open hand. On the shore of what is known as the West Thumb of the lake, is a small cone-shaped geyser, which, like others, gives up its boiling water. A wonderful feature of this geyser is the fact that it is half covered by the ice-cold waters of the lake. On the crest of this wonderful little geyser I stood, fishing-rod in hand, and, baiting the hook with a grasshopper, threw my line into the icy waters of the lake, hooked a 3 pound trout, reeled it in, dressed it, and with the line in hand dropped the fish into the boiling geyser, cooked it, and 3 of us ate the fish without its having left the hook. It took just 6 minutes to cook the trout, and during that time it was pulled out twice in order to ascertain whether or not it was sufficiently done. During the time consumed in catching the fish, dressing and cooking it, I did not move 4 feet.

L. M. E., Salt Lake, Utah.

I noticed an article in RECREATION commenting on a press despatch from Ashland, Wis., regarding the fishing on the Brule. It is said lumbermen are driving on this stream. This is true, and they have driven it for the last 8 years; but the lumbering is on the lower part, below the clubhouse.

I live about 11 miles from the head of the Brule, on Ox creek, and have been here 9 years. Ox creek is 9 miles North-east of Gordon station. This stream is as good as the Brule. Last spring we caught trout that weighed 2¼ pounds. A ½ pound trout is thought a big fish, on the Brule.

F. B., Gordon, Wis.

A paper published at Neenah, Wis., says: Will Nelson and E. F. Taylor fished yesterday on Lake Winnebago, and made the largest catch ever reported by any 2 fishermen,\* for one day's fishing, with the spoon hook. The catch included pike, black bass and silver bass, and numbered in all 246 fish. Johnny Garvey and Cliff. Lansing, in an afternoon's fishing of 3½ hours succeeded in catching the modest number of 77 of like species. Many other large catches were reported by all out from the Neenah mouth of the Fox, and Southward.

Denver, Colo., May 28, '97.

Editor RECREATION: I enclose a clipping from the Denver Times, which may be of interest to RECREATION'S many readers.

Justice Hunt this morning found F. Oppenheim, proprietor of a restaurant, guilty of violating the new state game law by selling fresh mountain trout and having it on the bill of fare. The minimum fine allowed by the law, \$25 in each case, was assessed, but was remitted by the court on the

\*The reporter should have said "fish hogs" instead of "fishermen."—EDITOR.

showing made by defendant's counsel, that the law was not yet printed.

The new law is the most sweeping one, on the subject, in any state, and is designed to make Colorado a sportsman's paradise. The law prohibits the sale of mountain trout, by any hotel or restaurant, at any time of the year, and makes it an offense to even print it on a bill of fare. If the fish, as in the Oppenheim case, are imported from another state, the defendant must show that the fish were lawfully taken, according to the laws of the state where the trout were caught. This is a difficult matter, as the laws of Utah, Wyoming and Idaho are now almost as strict as the new Colorado law, and prohibit the exportation of mountain trout beyond their respective limits.

The open season for catching trout, in this state, is from June to October, inclusive. They must be caught by hook and line, all other methods being punishable by heavy fines. From the public waters of the state they can only be caught for consumption, and no one person can take to exceed 20 pounds in one day.

I hope our new Fish Commissioner will be as zealous throughout his term as he is now.  
C. E. Rich.

The unusually high water, in the Wall-kill river, has receded from the meadows, leaving hundreds of German carp stranded on the lowlands. They have adapted themselves to circumstances, are drawing around themselves little patches of leaves, and, like robins, are nesting. It is no uncommon sight to see the males going from nest to nest, and looking after the eggs, to insure the hatching process.

The females seem content in their nests, while the males bring them food. They do not seem to mind the change, from water to dry land, and are getting along nicely out of their natural element; the occasional rain storms being sufficient to keep them in good condition.

This looks as if we were never going to be rid of this inferior fish.

Any adverse comments, on this article, by carping critics, will be resented.

Biff, Middletown, N. Y.

Spirit Lake, Ia.

Editor RECREATION: The hotels and the fishing season opened here on May 15th. The fishing is better than last year, as a result of the law having been enforced. Bass, wall-eyed pike, croppies, pickerel and perch, have been taken in good numbers.

With 2 railroads running directly from Chicago, sportsmen are enabled to reach our lakes very conveniently.

This was an ideal hunting and fishing-ground for the Indians; no wonder they objected to leaving it. Here, too, the mound-builders lived and built their mounds.

RECREATION comes regularly. It is the best of all the sportsmen's journals! That is saying a good deal, but not too much.

M.

Although the names of Pelee, Put-in bay, Old Hen, Middle, and Kelleys islands, and the splendid fishing near them, are known

in our locality, there are probably many readers of RECREATION to whom they are strangers. These islands, with numerous smaller ones, form a group at the upper end of Lake Erie. Around them, and on the adjacent reefs, bass congregate, in May and September.

The middle of last May, C—— and I left Sandusky, Ohio, by steamer, for Kelley's island, where we arrived toward evening. By 6.30 the next morning we commenced to fish.

Trolling with spoon or live minnows is the way most of the fishing is done. We used live bait, Bristol steel rods and heavy sinkers. Fishing until the middle of the afternoon, we took 25 bass, ranging in weight from one to 4 pounds.

C. V. W., Sandusky, O.

Please settle a dispute between me and a friend.

Is there any tarpon, or other fish, caught with rod and reel, weighing 100 pounds or over? Has there ever been one caught with rod and reel so large?

Yes, a great many fish, weighing 100 pounds and upward, have been caught with rod and reel. A few tarpon have been thus taken that weighed over 200 pounds. In the Gulf of Mexico, and at Santa Catalina Island, jew fish and horse mackerel are sometimes taken, with rod and reel, weighing upward of 200 pounds; though these very large fish are usually taken with hand lines.

Of course, special tackle is required for such fishing. The tarpon rod is usually not more than 6½ feet in length and is often a half inch in diameter at the tip. A large reel is used, holding 200 to 300 yards of 15 thread line. There is not much spring in such a rod, when simply testing it by hand, yet a 200 pound fish will bend it into a half circle.

EDITOR.

In reply to inquiry of W. B. McE., Marshall, N. C., I will give my experience of 7 years ago on Big Horicon, Little Horicon, Shut In, Pigeon river, Catalouche creek and Deep creek—all in the mountains of N. C.

Although I fished only in the early spring, I took good catches from each of these streams. I advise him to get a 6-oz. fly rod, good reel, light oil silk line, and a few each of Black Gnat, Brown Hackle, White Miller, Professor, Silver Doctor, Dark Montreal and Red Ibis flies. Those tied on No. 8 hooks are a good average size, where only a limited stock is carried.

I carry about 2 gross, tied on sizes 8 to 16, and have had good success with the small flies, when trout would not rise to the larger ones. R. P. B., Rutland, Vt.

What do you think of this: A special from Peshtigo, this State, to the morning papers says, apparently with pride, that the farmers in that vicinity have found a new fertilizer. They go to the lakes and rivers, with teams and dip nets, and catch thousands of suckers. A few of these are eaten, but the remainder are thrown on the farms for fertilizing purposes.

The State fish commissioners have placed millions of trout, pickerel and the like in streams throughout the State.

Here is another:

Local fishermen think they have found a way to evade the new fish law. They allow their consignments of dressed fish to be seized and sold at auction, buying them back at about 80 cents a hundred lbs. They are then shipped to Chicago, netting the consignor \$5 to \$6 a hundred. About 8,000 pounds of fish were handled this way last week.

The law makers must try again.

L. J., Marshfield, Wis.

I enclose \$1, which I wish to add to the fund for the poor children of your city. We are blessed with such quantities of pure air, beautiful flowers and birds, up here, one forgets the dark corners of our domain. If 10 cents helps one of His unfortunates, 10 of us here wish to aid 10 with you. We thank you for calling our attention to the little ones.

I heard of a fish hog catching 200 trout, in a near-by county, recently. The state inspector is looking up the case. It may not have been done regularly, you know; and it is well to be positive, for it is exasperating to a fellow who gets his ½ dozen a trip, and charges up the balance of his recreation to pure air and a clear conscience.

Dr. W. A. H., Owego, N. Y.

We have good fishing in the Hocking river. Although there are no trout or salmon, we have some game fishes, such as black bass, pike, and perch. The latter are just beginning to bite, while the bass rise to the fly frequently.

The river was recently stocked with several varieties of fish. I hope they will be protected, and think they will, as the State game warden has been severe on some of the violators of the law in this vicinity. Last week he had 5 fellows arrested for spearing fish. They were fined \$25 each for their fun.

W. B. C., Athens, O.

A party consisting of F. A. & G. E. Pearsons, of Vt., Guy C. Dewey and me, while fishing at Wardner's, Rainbow lake, a few weeks ago caught the largest brook trout that has been taken in the Adirondacks for some years. It weighed 4 pounds, 2 ounces and measured 21 inches in length and 13 inches around. Mr. G. E. Pearsons was the lucky angler and Mr. Dewey handled the landing net.

F. J. Taylor, Malone, N. Y.

The West branch of the Brandywine affords as good fly fishing, for black bass, as any stream in Eastern Pennsylvania. This is known to fishermen of Reading, Wilmington and West Chester; and scarcely a day goes by during the season, when representatives from some one of these cities are not along the stream. The bass are 10 to 14 inches in length, and hard fighters.

Lenape, West Chester, Pa.

The trout season opened in this section with rain and high water. Few fish were caught in the near by streams, but a friend and I went to Clark's creek, 10 miles from here, and caught 39 good ones. Most of them averaged 11 inches long. We expect the fishing will be good from now on.

W. V. B., Lykens, Pa.

Where can I buy good trout flies, and artificial minnows?

S. B., Denver, Col.

You can get good flies, made to order, from Dr. Wm. Greenshields, Romeo, Mich., and minnows, or other fishing tackle, from Cornwall & Jespersen. These people advertise in RECREATION and are thoroughly reliable.

EDITOR.

Herewith I hand you a clipping from one of our evening papers, of recent date. Would you call them successful fishermen, or game hogs?

X. Y. Z., Williamsport, Pa.

John Washam, John Updegraff, John Thomas, John Herman and James Updegraff returned last night from a 10 days' fishing trip through Potter county. They fished Slate run, Kettle creek and Youngwoman's creek and caught over 1,200 trout.

These are of the genus *swimus ictus*.

EDITOR.

A correspondent writing from Eagle river, Wis., says: "A. Balaman caught a 10 pound muskalonge, and W. O. Connor caught one weighing 16 pounds, in Yellow Birch lake. M. Frankel caught 21 pike, in 2 hours, in Cranberry lake."

Hundreds of pickerel are being caught here, and some large ones have been taken, the largest weighing 16 pounds. Two Mauston boys recently caught 75 trout.

F. V., Mauston, Wis.

Have been taking a rest, and incidentally catching trout, 8 to 13½ inches long. Will get up another club for RECREATION soon.

M. V., Lykens, N. Y.

We have good trout fishing here.

J. E. B., Dingman's Ferry, Pa.

# GUNS AND AMMUNITION.

## BIG BORES FOR BIG GAME.

R. S. B.

Editor RECREATION: I wish to corroborate what Mr. E. E. Van Dyke says. Also to help him out of a slight error he made in stating that the penetration of the 45-75-405 cartridge is nearly one-half greater than that of the 45-90-300. I have looked up some data and present 5 types of guns for comparison.

lations between different guns I take up the last 2 as representing the extremes of large and small bores. The united energy of the guns, in foot pounds, would be represented by formula

$$\frac{P V^2}{2.9} \text{ in which } P \text{ is the weight of ball in pounds.}$$

$$V \text{ " " " velocity in feet per sec.}$$

$$g = 32.16 \text{ gravity.}$$

Which worked out for No. 4 gives 2092 foot pounds.  
 " " " " " 5 " 2308 " " "  
 Thus showing that No. 5 has the greater power again.  
 But the energy per inch of cir. of ball would be repre-

| No. | I. | 45.   | 70.  | 405. | Velocity ft.<br>per sec. | Penetrations.   |             |         |                      | Momentum.<br>90 ft. lbs |     |
|-----|----|-------|------|------|--------------------------|-----------------|-------------|---------|----------------------|-------------------------|-----|
|     |    |       |      |      |                          | 14. 7/8" boards | plain ball. | 16 1/2. | 7/8" B. patched ball |                         |     |
| "   | 2, | 45.   | 90   | 300. | 1271                     | 13              | "           | "       | 19.                  | 77                      | " " |
| "   | 3, | 40.   | 90   | 370  | 1357                     | 16              | "           | "       | 23                   | 89.7                    | " " |
|     |    |       |      |      | (U. S. new navy.)        |                 |             |         |                      |                         |     |
| "   | 4. | .236. |      |      | 2306                     | "               | "           | "       | 62                   | 56                      | " " |
| "   | 5, | 50.   | 105. | 450  | 1383                     | 16              | "           | "       | 23                   | 125                     | " " |

By looking at the table some queer comparisons are to be seen. No. 3, the old Sharps, was my ideal rifle. Mr. Van Dyke uses Nos. 1 and 2 and says the new No. 5 would be his ideal. I claim that No. 3 was the best rifle, 10 to 15 years ago, for my use on the plains and in the foot hills. Mr. Van Dyke's ideal is a little larger. Probably he can carry a cannon better than I could; but his gun has the same penetration, in pine wood, as mine. I admit Mr. Van Dyke has picked the better of the 2, as it is the gun that has the most power with loads given, as shown in the column of momentums; and just here is where the whole business centres. The fine adjustment of powder charge, gauge, and weight of ball, granting the gun perfect in other respects for certain resistance is admirable. No one gun is adapted for all kinds of shooting.

The various governments have been trying, for years, to produce the best gun to kill men. Now it seems they want to do it in a nice, gentlemanly way—by pushing lead pencils through them. No. 4 in the above table is that kind of a gun. It has high velocity, great penetration and is supposed to revolve a ball so rapidly that it will tear a large hole. Granted. But if that gun were given to me, or I dare say to Mr. Van Dyke, and we were ordered to go hunting with it, we would look for nothing larger than jack rabbits. You all seem to overlook the fact that it is not the ball that does the killing. It is the resistance the animal presents to said ball that determines whether or not he is to yield to it. If the nerve centres, or main nerve cords are penetrated, you will paralyze and kill your game in a much more humane manner than by letting him bleed to death, and you are more sure to get him.

To continue the research as to the re-

presented by formula  $\frac{P V^2}{292 r \pi}$  in which P, V & g are the same

as above, r=radius of ball in inches and  $\pi=3.1416$ .

Worked out we have for No. 4 2851 foot pounds per inch of circumference of ball.

Worked out we have for No. 5 1841 foot pounds per inch of circumference of ball.

The circumference of No. 4 ball is .75" or area .04 sq. in.  
 " " " " " 5 " 1.25" " " 1.21 " "

The area of No. 5 ball is nearly 3 times that of No. 4.

Now as to results in killing animals. That depends on the elasticity or resistance of the parts struck; and on this point we have as yet no reliable coefficients by which to work out formulas.

Referring again to the table: The known penetration of pine boards is as follows:

For No. 4, 62 7/8" boards, 54.25 inches  $\times$  .04 sq. in.=2.17 cu. in. clean hole cut.

For No. 5, 23 7/8" boards, 20.125 inches  $\times$  121 sq. in.=2.43 cu. in. of clean hole cut.

Thus it is seen that No. 5 has actually cut or penetrated more area of wood, or the wood has presented more resistance than to the No. 4 ball; but it is claimed that No. 4 will cut a larger hole in proportion than No. 5. The increase in size is due to the plug of material carried ahead of the ball having a tendency to spread out; as a log or boat propelled through the water forces water ahead of it; this being retained by the pressure of the side water, till this accumulation of bow water overcomes the resistance of the side water, when it passes off in bow waves. The sharper your cut water, and the finer your boat lines, the less resistance is presented by the water to the propelling force of the boat; and this is certainly true of your ball. The twist of the ball does not increase the size of hole very much. Old hunters use soft nose, hollow, or quartered point bullets. Or they cut the point by casting around a piece of

paper in the mould, so as to cause the ball to flatten or mushroom, thereby making a larger wound.

I read all the articles on guns and ammunition in RECREATION, and am much interested in them. I agree with Mr. R. W. K. as to hitting the brain. His gun may be good enough for him but I will tell you what I saw of it. It was in the early 80's. I was on Ten Mile creek, Colorado, looking after some mines. Some friends of mine, from New York, wanted to come out and look at the mines, and have a bear hunt; so I told them to come.

At last they showed up, each with a beautiful 44-40-200 Winchester. One morning I heard their guns going as fast as they could work them. I ran down the mountain to get sight of the performance. As soon as the old bear saw me, he made straight for me, in no very good humor. I did not encourage him nor do a thing to him, till he got within 15 yards of me. I then pulled down fine on his frontal, and handed him my card, endorsed by "old reliable" 40-90-370 Sharps. He received the same in the brain and sat down. We all sat on him and talked of "old reliable" and its work. They had hit the bear 8 times—I hit him once.

---

#### 30-40 VS. 45-90.

Syracuse, N. Y.

Editor RECREATION: I saw, in May RECREATION, the article "Big Bores for Big Game" and should like to tell of my experience with large and small bore rifles.

I have always used a 45-90 and it does its work well. Have found it good for all game, from a woodchuck up to a moose; but of late—since the 30-40's and 30-30's have become so popular I have studied these guns with great care and interest. From the tests I have made of them, I have been convinced and have lain aside my 45-90—probably for ever.

To consider each point of advantage in the small bores, over those of the 45-90, is the only way in which to thoroughly understand them.

First: The 45-90 weighs 10½ to 11 pounds, when loaded; while the 30-40 Winchester, box magazine, weighs but 8 pounds.

Second: There is great difference in the recoil of the 2 guns.

Third: The flat trajectory of the 30-40, as compared with that of the 45-90. The trajectory, or drop, of a 45-90 ball, in 300 yards, is 27.25 inches; while that of the 30-40 is but 14.14 inches. A man with a 45 calibre must calculate his distance on a deer carefully; and if his calculation be wrong he makes a clean miss. With the

30-40 all he has to do is to shoot well up on the shoulder and if he misses it's because he didn't hold steady.

The little steel cased missile travels through space with a velocity of 2,066 feet a second; while that of the 45-70 and 45-90 is between 1,170 and 1,480 feet a second. High velocity materially adds to the penetration. The 30-40 has a penetration of 58 dry pine boards; while the 45-90 cuts through but 19.

Another thing which is greatly to the advantage of the hunter is the lack of smoke, in the use of the small gun. I have had the cloud of smoke, from my 45-90, hang so long after firing that I have lost many a deer that might have fallen to my second shot, had I had a smokeless rifle.

An important question as to the 30-40 is its power to kill. From the tests I have made I can truthfully say these are amazing. My first test was on an old horse, which I first shot through the head. The bullet entered a little to the right of the centre of the head. The skull was smashed to atoms. We were unable to locate the ball, which cut through the neck and must have lodged somewhere in the shoulders.

After propping up the carcass I shot once through the pouch and once through the shoulders, and the results were wonderful. The ball that passed through the pouch never touched a bone. The hole where it entered was hardly discernible but on the other side we found a hole 1½ to 2 inches in diameter. The ball fired into the shoulders passed through them, making a ghastly wound and breaking the bones of both shoulders. We recovered one of these balls and it was mushroomed to the size of a 45 or 50 calibre.

I agree with Mr. Van Dyke that the 22, 32, 38 and 40 black powder cartridges are too small for big game. They have not the necessary power of penetration. Some one may ask why a 38-55 or 40-70 has not the power of a 30-40. This is easily answered, when you consider that 40 grains of smokeless powder is equal to 100 grains of black. You can easily see where a 30 calibre ball gets its velocity and penetration.

Mr. Van Dyke let a fortune slip through his fingers when he neglected to preserve the heart of the elk he shot, with his 45-90, and that ran over 100 yards. His story sounds fishy, when medical men claim that if the heart be punctured with a needle it causes paralysis and instant death.\*

I would like to hear from some one else who has used and tried this 30-40 gun.

Syracuse.

---

\* Mr. Van Dyke's story is not in the least improbable. No modern medical man so far as I know, makes any such claim. There are plenty of instances on record, of large animals having run 100 or 200 yards after being shot through the heart.—EDITOR.

## REPEATING SHOT GUNS.

In answer to A. H. W., Amarillo, Tex., regarding the use of the Winchester repeating shot gun, I will give my experience for what it is worth.

About 12 years ago, when the Winchester repeating lever action shot gun made its debut, I fell in love with it, and bought one. I used it several years, with perfect satisfaction. Then I swapped it for another gun.

During the next few years I used 3 or 4 makes of double guns, both hammer and hammerless, until the Winchester company brought out a shotgun with a forestock action. This struck me as being a good thing; so I bought one of the first pair that came to Southern California. I had a gunsmith cut off 3 inches of the barrel, at the muzzle, as I wanted the gun principally for use on quails and doves. It was a good shooter and many a duck has it brought down, at 50 to 60 yards, with No. 8 shot. The barrel was now only 27 inches long, with cylinder bore.

This gun had but one fault. It would balk, by jamming the cartridges, just when I needed it most. The Winchester people have now entirely overcome this fault, by the adoption of a cartridge guide which makes the passage of the cartridges, from the magazine to the barrel, sure and positive.

Last year I went on an expedition into Old Mexico, and lower Southern California. On this trip I took a later and improved Winchester shot gun, with a forestock action and with barrel cut off. The way it would bring down quails and doves would do any sportsman's heart good. Several times I stood on one spot, and without moving from my tracks killed 4 and 5 birds, in almost as many seconds. On this Mexican trip we sent home, to friends, several bags of birds, of which the little pump gun could rightly claim a large percentage as its share.

I now have gone back to my old and first love, a Winchester lever action. It is the ideal action for me. Well balanced, easily operated, quick and sure. If you will only use a gun like this, with the barrel cut off one or 2 inches, and regularly read RECREATION you will always get more game than any one else in the party. Jack Beldin.

## AS TO LYMAN SIGHTS.

Helena, Montana.

Editor RECREATION: In your issue of May I noticed a query, by one of your many readers, as to the virtue of peep sights on rifles, and beg to give my views on this subject.

I use the Lyman hunting sight for the rear. It is adjustable to any range and my

rifle, a 40-65 Winchester, will carry from point blank up to almost 1,000 yards with proper adjustment of this sight. Any one not used to these sights would be surprised at the accuracy that can be secured, at distances far beyond those to which a bullet can be sent with any chance of hitting, with the common open sights. For a front sight I use one of copper, made to order, with the least possible bead.

I have hunted with these sights 3 seasons and have found I can shoot at least 50 per cent. better than when I used open sights. In rapid shooting (and there is often where the game is bagged), there is no over shooting. Looking through the peep the game is in plain view and all there is to do is to put the bead just where you want the bullet to go, and pull. With the open sights the mistake is often made of holding the gun on the game; but with too much of the front sight showing. This cannot be done with the peep sights.

Another advantage of the Lyman sight is that good shooting can be done with it in the evening and the early morning twilight. With the open sights everything would be a blur; but looking through the little peep the bead comes out finely and the game can easily be covered.

These are but a few of the good points of the peep sight; but any one who uses it would never use any other. The best way to learn all of its virtues is to try it. Do not go at once to the hunting grounds to do this; but after having your sight properly adjusted test it at target until thoroughly familiar with it. At first you will think it impossible to hit anything, with the whole country spread out before you, through the little hole; but a few trials will convince you that you can do a great deal better shooting in this way than in any other.

R. C. Fisk.

## AN EARLY HAMMERLESS.

Roswell, N. M.

Editor RECREATION: I have an interesting old gun that was made by Wm. Greener, father of the late W. W. Greener of London. It is a double barrel gun—a rifle barrel on top of a shot barrel. It is finely made and sighted. Was a flint lock and has been changed to a percussion lock. This was done by Peter Powell, of Cincinnati. The gun was sold to the father of Abraham Lincoln and afterward became the property of the late President. He brought it from Kentucky to New Salem, Ill., near Springfield.

My father, J. A. Denton, traded a yoke of cattle and 10 cords of wood to Mr. Lincoln, delivering the wood to the firm of Lincoln & Herndon, Attorneys.

I have used the gun ever since 1852, and the ducks, geese, rabbits, etc., I have killed

with it I do hope will not all gather around my death bed; but I trust they will let the old, gray haired hunter die in peace.

About 20 years ago a young lady visited our family, from Boston, and when assigned the best room in the house she objected to it on account of "a horrid old gun," being in it; so father told me to take the gun to the shop and have the hammers both taken off, so it surely could not shoot. But the sweet girl said,

"Oh yes, old rusty guns are the very worst to shoot when they are not supposed to be loaded."

So I gritted my teeth, with as sweet a smile as possible, took the gun and bowed myself out of her presence, while father kindly put both arms around her to hold her while I moved the "horrid thing" to the shop.

I was in such a jolly humor, at thinking how father got a good hug, that I removed the hammers and have never seen them since. I never told mother, either. But how I did really love that sweet girl!

And that is how the gun became a "hammerless." It is so old the name and dates are all rusted off, but "New York," and a faint "m" and "London." It had a loading stick on the right side for the rifle, and one on the left for the shot barrel; so that from a muzzle view it looked like a 4 barrel gun.

G. Denton, Roswell, N. M.

#### A FALLING BULLET.

Mr. P. McCarthy, Yonkers, N. Y., asks whether a rifle ball, fired straight up, would have the same velocity as if fired horizontally; also whether, on its downward flight, it would acquire a velocity and penetration, at the earth's surface, equal to that given by the powder charge when fired horizontally or vertically.

I referred this question to Gen. G. W. Wingate, who replies as follows:

"In going up the bullet is kept point first, and straight, by the twist. Consequently it attains a great velocity. Coming down it would turn so that the heavy end would be downward, and it would 'wobble.' Not only is its velocity reduced, from these causes, but in addition, the rule of falling bodies is that after they have obtained a certain speed they go no faster, on account of the resistance of the air. This velocity is not very great, and is far from being equal to the velocity which the ball has when it starts out of the rifle to go upward. Where the bullet is thrown so as to describe a curve and come point down, as in the new rifled mortars, it strikes much harder.

"In firing the Springfield cartridges from a gattling gun, on such a curve that the bullets would fall quite close to the gun, they penetrated, I believe, from 1½ to 2 inches of plank. This was better than

was expected, but was still much less than the penetration which would have been obtained from the bullets if they had entered wood when they started upward."

#### AN ALL ROUND GUN.

Bellevue, Ky.

Editor RECREATION: I have, for 3 years past, used a gun that was about a pound too heavy, and with a stock of ½ inch too much drop. Hope none of my brother readers have been similarly handicapped.

I think E. W. S. in April number, has about the right idea in regard to an all-round gun, i.e., 12 gauge, 30 inch barrels, right modified choke, left full choke, etc. Personally I prefer both barrels full choked, on account of superior range and killing power; as well as on account of an excitable temperament. I have better success, at wing shooting, when making rather long shots.

If you load your own ammunition, such scatter shells as may be needed can be loaded, by dividing the shot charge in 2 or 3 equal parts, with cardboard wads between, and using only 1 ounce of shot. With pink or black edge wad on top of shot this makes a load that is good for brush shooting.

The consensus of opinion, as expressed in letters to RECREATION, seems to be that, other things being equal, the bigger bore will do the greater execution; though I see in the last issue an advocate of the 16 gauge. The arm in question weighs 7¼ pounds, has 28-inch barrels, right modified, left full choke, and the writer says he uses 1 ounce of shot for all shooting. I also am an advocate of 1 ounce of shot for quail and general shooting, when No. 7 or smaller shot is used, and when extreme range is unnecessary.

I hope to have a new gun, some day, and wishing to be satisfied with same, and being unable to see how the above 16 gauge would be superior to a light 12 gauge, would like the following queries answered:

Would not a 12 gauge, 28 inch, 7 pounds or less, full choke, shoot 1 ounce of shot as well or better? Is not the ammunition as cheap and more easily procured? Can more than one ounce of shot be used in a 16 gauge, with good results? Does it shoot the larger sizes of shot as well as a 12 gauge? If the 16 does not shoot the 12 gauge charge of shot (1½ ounce), how can it have the killing circle, or range?

C. D. K.

#### ANOTHER REPEATER MAN.

Britt, Ia.

Editor RECREATION: As everyone seems to have a right to express his opinion, regarding the best make of gun, I will give you mine. I am particularly fond of a re-



peating shot gun, 12 gauge, medium choke. I have used one nearly 6 years and if you want a game gun, and can shoot one of these, it is the gun for you. I have hunted with good shots, with 10 gauges, and never saw them kill as many birds as I could with my 12 gauge. Some of them have traded fine 10 gauge double guns for repeaters and think they are the best on earth. The only objection to the repeater is that it uses a  $2\frac{5}{8}$  shell.

I have killed 5 cranes out of one flock, passing over me, and 4 geese. I have made scores on other game that can't be beaten by any 10 or 8 gauge gun.

L. S. Van Vliet's idea, in not getting a full choke gun is right. At short range a full choke gun, if held on the bird, cuts it up till it is almost worthless. Furthermore, on windy days, or in timber and cornfield shooting, the best shots cannot do good execution with a full choke, and I don't think weight has anything to do with the question of hard shooting. With the 10 gauge more shot can be used; but you will have to load considerably heavier to get the penetration of the 12 gauge load, and most of the good makes of 12 gauge guns will shoot right.

We are too quick to find fault with the gun. Most of the trouble is with us. We all have off days. I have seen smooth bore rifles, not much larger than 44 calibre, shoot shot as hard as any of our shot guns. I prefer a 12 gauge 30 in. gun, 7 pounds.

What is the best rifle for big game?

R. S. Brickey.

Can you or any of your readers, tell me where I can get a book on old guns and pistols?

I have a collection of over 100 old arms, including U. S. Army flint lock, made in Harper's Ferry, 1809; Queen Anne flint lock, 6 ft. long, used in the Revolution, and a lot of old cap and ball pistols, with no maker's name or date. Have some duplicates, which I would be glad to trade.

RECREATION seems to treat of everything, from a "chipmunk" to a moose, and from a minnow to a whale. I could not do without RECREATION, and have it sent to my camp, in the wilds of Maine, when there; so I expect a flood of light from you, or from your readers, about old fire-arms. C. R. Richards, Rochester, N. Y.

"The Gun and its Development," by W. W. Greener, published by Charles Scribner's Sons, N. Y., has a great fund of information about old guns. Captain Philip Reade, of the U. S. Army, has contributed to RECREATION a series of illustrated articles on old guns, which have been printed within the past year.

Will my readers please send me such information, and photographs, as they may have, on this subject?—EDITOR.

I would like to tell the readers of your king of magazines about some of the work of the 25-35 Winchester. It is all a mistake to think it good only for small game. I have killed bear, elk and deer with mine, and have never handled a gun that could do better work. I killed a deer last fall that would not have known he had been hit if I had used a black powder gun. He was standing quartering to me, about 150 yards away. I intended to hit him in the point of the shoulder; but under shot, and only "ticked" his breast, cutting a gash in the hide  $1\frac{1}{2}$  inches long. He ran 20 steps and fell dead. Now what killed him? I examined his heart and it was a mass of clotted blood. If Repeater, of Connersville, Ind., thinks of killing small game, with one of these rifles, he will have to hit it in the head; for if he hits the body of a duck, or a grouse, he won't have any game to take home with him. A 32-40 or 38-55 would be a better target rifle.

I have had 25 years' experience in the Rockies, and the 25-35 is by far the best all-round rifle I have ever used.

M. P. Dunham, Woodworth, Mont.

On page 467, of your June number, P. J. M., Maxwell City, N. M., asks the opinion of those who have used them, as to the Lyman sights.

For 8 or 10 years past I have used these attachments and am highly pleased with them.

When first examined one is apt to think them impractical; but after using them to fire a few hundred shots no hunter would go back to the old "buck horn" and "knife-blade" affairs.

On standing game one can "catch sight" from one to 2 seconds quicker than with an open sight; and that often makes just the difference between getting a shot and not getting it.

On moving objects there is no comparison, at all, to be made. Wm. Lyman has never put a bad thing on the market.

Allow me to suggest that you exclude from RECREATION all illustrations showing any person leaning on the muzzle of a gun.

Our sons and daughters are imitative creatures and RECREATION should contribute nothing to aid the fool factories. Just wait a little and give your readers a portrait of the corpse. V. B.

In my opinion the "best gun" is the Burgess repeater. Beside being one of the smoothest working guns in the market, it has no equal for close, hard shooting. The rapidity and accuracy with which its 6 charges can be delivered into the midst of a flock of ducks, bagging—in almost every instance—ducks that would have gotten away from a double barrel, warms the heart of a sportsman. I have seen an entire flock

of 6 ducks bagged, with a Burgess—not one getting away.\*

It works as well on a sand bar, in a gale of wind, as in the woods. I have been using a Burgess, for nearly a year, at the trap and in the field. Its shooting qualities, for all sizes of shot; its simplicity, rapidity and durability, beat any gun I ever saw or owned and I strongly advise any one looking for the "best gun" to get a Burgess.

Rau McDonald.

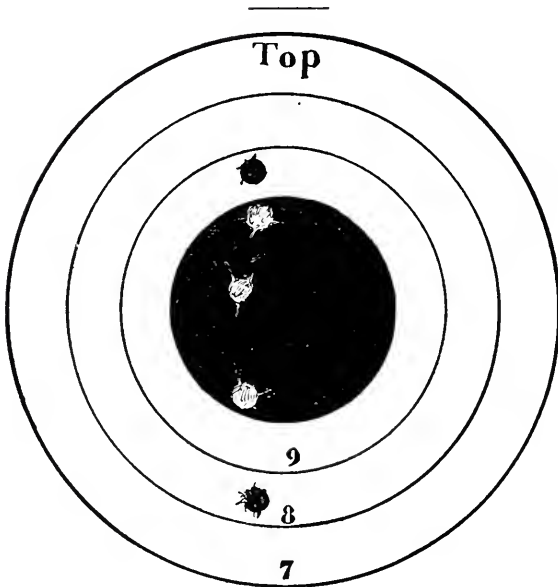

I enclose a copy of a target I made, in testing a 25-20 Marlin. You will notice the vertical line of shots can all be nearly covered with a lead-pencil, and having used only open sights I consider it an excellent target. I believe the Marlin or Ballard barrels cannot be excelled.

L. A. Stave, Champaign, Ill.

Editor RECREATION: I have read RECREATION for a long time and have never found a magazine that comes up with it, though I take a good many. I notice that nearly all the houses I deal with, and deem responsible, advertise in your magazine. If some of the dealers who do not advertise in RECREATION, would try an "ad" in it they would no doubt be surprised at the returns. I noticed that last year a house that was opposed to RECREATION went under. A hint to the wise is sufficient.

Will some kind reader give me his experience with a 16 gauge gun? Tell me what you think of it. What load is best for it and what powder?

What calibre rifle would you recommend, for deer and bear?

What do you think of the model '90 Winchester, 22 short?

C. R. W., Oak Park, Ill.

\* Why kill an entire flock? Why not let a few remain for seed? Was the shooter trying to exterminate game? Or was he in pursuit of legitimate, manly sport?—EDITOR.

Replying to A. H. W., who wishes information concerning the Winchester repeating shot gun: The first 2 guns assembled by the company were shown to the public by J. R. Stice and me. Shortly after this I won one, in a free for all shoot, used it 2 seasons, at the traps, and found it a close, hard shooter.

Although I never used one of these guns in the field I should feel handicapped if I were obliged to carry a double gun where game was plenty, while a companion had a Winchester. I have often broken 3 clay birds, thrown from 3 traps at the same time, and I know that, on an average, these guns will give as good pattern and penetration as any \$100 gun in the market.

T. R. W., New Haven, Conn.

Someone has asked about the 16 gauge shot-gun, and I should like to give my experience. Twelve years ago I bought a 10 gauge gun and used it 3 years; sold it and got another, which I used 3 years.

Then I got a 12 gauge and then another and used them 6 years. Last fall I got a 16 gauge, weighing 6 pounds 15 ounces, and would not trade it for all 4 of the other guns. It shoots as well as any, and is so much lighter to carry. Besides 20 or 30 shells for this gun do not load down a hunting coat as the others did. The 16 can be swung on to game quicker; and that little extra speed means a great deal, sometimes, when the game is just starting, especially in thick cover.

Get a good American 16 gauge gun; and load with 2½ drams American smokeless powder and 7⁄8 or 1 oz. shot; and you can get the game if you could with anything.

E. S. Billings, Smyrna, N. Y.

W. G. E. wants to know the advantages and disadvantages of the new 30-30 and 30-40 Winchester rifles. If killing power is what he wants the 30-40 has the best of it; but if he wants camp meat the 30-30 is best. My partner, and one of the neighbors, use 30-30's. They first used the soft nosed bullet, but soon quit them, as they spoiled too much meat; and are now using the full cased bullet. There is no gun made that can beat the 30-40 Winchester, with soft nosed bullet, for killing qualities.

M. P. Dunham, Woodworth, Mont.

In reply to an inquiry in RECREATION, regarding Lyman sights, I will say they are, without doubt, the best all-round sights on the market. I have them on all my rifles and think they improve my shooting at least one half. The receiver sight is particularly good, for it can be raised or lowered quicker than the others.

RECREATION is another good thing. It is a perfect magazine for sportsmen; in fact, the best published. P. B., M.D.

## NATURAL HISTORY.

### WHY DO WOLVES "DOPE?"

Editor RECREATION: Mr. Ernest Seton Thompson asks, in June RECREATION, if any of its readers have ever seen wolves rolling in carrion. Yes, I have. A few years ago I was hunting elk, early in September, on the head waters of White river, Colorado. Late one evening I fired at a bull elk, standing in an open park near the timber. After the crack of my rifle, a few strides took him under cover of the spruce. It was too dark to trail, but returning early next morning, I found my game had run through this strip of timber, some 200 yards in width, and after going 40 to 50 yards in an open park had given it up. My ball had passed through behind the shoulders, to the skin on the other side.

The meat was soured; so I took off the head skin, with the antlers, for mounting.

Some 2 days later, I was packing in another elk I had killed, and came past the first carcass. I discovered that 2 or more bear had been to the carcass, had disemboweled it, and had made a great feast. The carcass was lying in an exposed place, and although at a high altitude it created considerable stench. I decided to return on the 2d evening, thinking I might encounter "Old Ephraim." I did so but was not favored with a visit from Bruin. I went back the next morning, and while approaching the carcass, discovered the wind was wrong for me; so I circled, which threw me some 300 yards off and above the carcass, at the edge of another strip of spruce. On creeping to the edge and looking over, I saw a large timber wolf at the carcass. I had seen several of these animals in Wisconsin, Michigan and Minnesota, but this was the first one I had ever seen in the mountains. I watched him carefully, through my glasses, and crawled a little nearer, under cover of a clump of willows. I found he was not eating, but "lolling" about the carcass. I saw him roll on it repeatedly. He would sit up, lick himself, jump over the carcass, and at it again. How long before my arrival the "circus" had opened, I cannot say.

I levelled my gun for a 250 yards' shot, and cut loose. I saw a grayish streak with a funnel end to it, reaching from the carcass to the timber, but haven't seen the wolf since. I approached the carcass and found the wolf had not eaten a morsel of it, but had contented himself by rolling in it.

I have frequently seen dogs roll in and about the carrion of a cow or horse, without eating of it. Why they do it I cannot say, unless they have the instinctive desire of all carnivorous animals to linger about flesh, either fresh or carrion; and if it has passed the eatable stage they roll in it to carry that "in-stink-tiveness" with them.

Dall De Weese, Cañon City, Colo.

### WOLVES, DOGS, AND CARRION.

Noting the communication of Mr. Thompson, in June RECREATION, concerning the habit of wolves rolling in carrion, I desire to say this is not limited to wolves; but you will find all hunting dogs—especially the Gordon setter, do it.

I have noticed this for years and could not give any solution save that the odor was pleasant to the dogs. I have known my dog to put his nose into the air and dart off, at a fast gait, notwithstanding my orders to return. Later he would come back with the smell of carrion about him.

I have found great pleasure in Mr. Thompson's articles and pictures, in RECREATION, regarding wolves and their habits. During my service in the regular army, in Arizona and New Mexico, we were greatly troubled with wolves and in one instance a herder was torn to death; but that was an isolated case and when a heavy snow had been on the ground a long time.

James S. Kennedy.

With regard to the query of Mr. E. S. Thompson, in June RECREATION, touching the propensity of wolves for rolling in carrion, may I in measure reply to his theory by asking, why it is that dogs do the same thing? I have noticed it often, not only among common curs, but among high bred sheep dogs.

This habit of the dog being identical with that of his wolfish cousin, I think his reason for indulging it is the same. Mr. Thompson's theory that the wolf wishes to disguise his personal scent is good, but how about the dog? Does it not seem more likely that both wolf and dog, finding the taste of decayed flesh agreeable, find the smell of it equally so?

H. H. Sauber, Willows, Cal.

Mr. Thompson's guess, as to why wolves roll in carrion, may be a good one. I consider it "one of those things that no fellow can find out." I suppose he knows a great many dogs have the habit (or rather the instinct) and the worst dog in the whole heap is the pointer. He takes more delight in a rotten hog, an old skunk skin, a dead snake, or something of that kind, than any other living dog. I have studied your question for years, and have whaled my pointers repeatedly, for doping; but why they want to be such fools, I have never been able to find out. They are willing to take a thrashing to get a wallow on a bad smelling article of that kind, and will sneak around to do it. They seem to want to rub their shoulders good, in the dope; and are not satisfied until both are well fixed. I would like to know "why is it?"

L. W. Byram, Kansas City, Mo.



#### THE LITTLE STRIPED SKUNK.

One day when Dame Nature was in a merry mood, she made the striped skunks, of which *Spilogale putorius*, from Florida, and shown herewith, is the type. At this late day it cannot be determined whether her original intention was to turn out a white animal with black markings, or the reverse. At all events, the result is a four-legged harlequin. One glance at him is enough to fix him in the memory for all time, even though the acquaintance stops at sight.

I am fond of animals generally, but at the skunk I draw the line. I have known him from my small-boyhood, and I'm "agin him." His reputation always was bad, but his acquaintance is worse. He has the colors of a bloody pirate, the impudence of a Piegan Indian, and a breath like a turkey buzzard. He gets into your mink traps when you don't want him; he kills your chickens in the "close season," and when your dogs attempt to remonstrate with him, he sends them into quarantine for 14 days. When you are tenting on the plains he is eternally wanting to get in bed with you, even though there are millions of other camping places available. If you object, he bites you, and either gives you hydrophobia, or a tremendous scare.

In some portions of the South the little striped skunk is commonly called the "Hydrophoby Cat," in the belief that its

bite always produces that distressing fatality. While it is undoubtedly true that a number of persons have died from skunk rabies, it is also true that even the skunks of the South and Southwest are not half so often afflicted with hydrophobia as people generally suppose. Many persons have been bitten by skunks not so afflicted, and of course without fatal results. The trouble is, however, there is but one way to recognize a rabid skunk, and even that is not always satisfactory. Let the skunk bite an Indian. If the Indian dies, the skunk has rabies, and should be killed. If he does not, the skunk is sound and healthy; and the Indian should be killed.

At present there are 15 species of skunks in the United States—all bad. Ten of these belong to the genus of striped skunks (*Spilogale*), and several quite closely resemble the species figured herewith. Nine of the 10 species inhabit the arid regions of the Southwest.

Mr. Ernest Seton Thompson calls attention, for the first time I believe; to the fact that the little striped skunk is a good example of protective coloration, inasmuch as "its peculiar black and white markings are calculated to identify the animal with its surroundings [in the South] when the light sand is barred with the heavy shadows cast by the palmetto fingers, under the rays of the vertical sun."

Possibly Mr. Thompson has correctly divined Nature's intention in coloring this creature so fantastically, but I must say that

of all the animals with which I am acquainted our jet-black-snow-white skunks are certainly the most conspicuous. Either in the woods, with their ever shifting shadows, on the brushy uplands, or on the prairies, no small mammal at rest ever catches my eyes so quickly as does a skunk.

But the doom of the skunk is sealed. His fur is now in fashion (under various names not its own). It is good, durable, reasonable in price, and when the black dye has "knocked the spots" out of it, even a skunk catcher would have hard work to recognize it without an introduction.

W. T. Hornaday.

#### THE WEST INDIAN SEAL.

For 50 years zoologists have believed the West Indian seal (*Monachus tropicalis*) totally extinct, and that not even one stuffed skin survived, as a record of its form and pelage. In 1844, however, a skin came to the National Museum, from Cuba. Then, in 1887, Mr. Henry L. Ward and Professor Ferrari Perez, of the Mexican National Museum, re-discovered the species, alive but fast asleep, on some tiny islets called the Triangles, in the Gulf of Campechy, about 50 miles from the coast of Yucatan. These naturalists collected about a dozen good specimens, which have been distributed among our largest museums.

Three weeks ago Mr. Cobb, of Pensacola, Fla., walked into the office of the New York Zoological Society, and offered to deliver any reasonable number of live seals, of this species, for a modest consideration in cash. It appears that on April 20, the fishing smack "Maude Spurling," of Pensacola, Captain Thos. Miner, visited the Triangles, and found there about 35 seals. Of these Captain Miner picked up 2 and carried them aboard his vessel, but killed none!

The seals lay asleep on the beach, so tame and sluggish that the whole colony might easily have been killed with clubs. This is just as they were described by Mr. Ward. The largest of the seals were about 7 feet in length.

The pair abducted by Captain Miner reached Pensacola alive and in good condition, and created a great sensation. They have been bought by men who will exhibit them at the Nashville Exposition. Four specimens have been ordered, of Captain Miner, for the Washington Zoological Park. Dr. Bean immediately ordered 3 for the New York Aquarium, and Captain Miner has gone to procure them.

The West Indian seal is not a handsome animal, nor is it endowed with an oversupply of intelligence. As for activity, it cannot spell the word. Its color is a uni-

form, dull gray, except where its back is green with moss and algae. Its head is coarse and homely, and its voice—well, it lacks culture. Inferentially it may be said there must be some tired fish around the Triangles, or *Monachus tropicalis* would surely starve to death. But what will our 3 think of life in New York, after they shall have found out what it is like?

#### FEEDING SUGAR TO A WILD BEAR.

The brave and fearless frontiersman is not alone in opportunities to come in contact with the wild beasts of the forest. There is an estimable lady in this city who fed sugar, from her own fair hand, to as fine a specimen of female bear as was ever seen among the mountains of the West. Bruin weighed 600 pounds and had a fur as sleek and glossy as velvet. It had not been 5 minutes since she had left her cubs in the vast pine groves, on one of the mountain sides, within the borders of the Yellowstone National Park.

It came about in this way: This female black bear makes a practice of entering the hotel office, at Old Faithful geyser, in the upper basin, Yellowstone National Park, every evening between 8.45 to 9.15 o'clock.

Of course every one takes the story with a large grain of salt, on hearing it; especially that bruin should be so prompt in making her calls. After spending 2 days at the geysers, paint pots, etc., in the Fire Hole basin, we proceeded to the Upper basin, where are situated the Giant, Giantess, Old Faithful and many other wonders.

The first thing on our programme, for our first evening at this point, was to prove the truth or falsity of the bear yarn, and promptly at 8.30 p.m. we all entered the hotel office. We took our seats and formed a circle. The manager of the hotel left the door open, and we noticed he filled his pockets with loaf sugar and cake. Promptly at 9 p.m. the beautiful specimen of the bear family entered and walked to the centre of the circle of visitors. She sat down on her haunches and was fed by the hotel keeper and by the lady referred to. Bruin lives in the wild forest; has never been caged or chained, and we were told she had 2 cubs; also that she drove all other bears from the locality, and had been coming into the office to get her sweets every evening for 2 seasons. She has never heard the report of a gun, and it would not be well for any one to attempt to harm her. The hotel keeper does not make a practice of allowing others to offer Bruin sugar, cake, etc., but Mrs. E— pleaded so hard, for the privilege of feeding a real live bear, that he gave her a handful of loaf sugar and the lady fed the bear.

L. M. Earl, Salt Lake City, Utah.

## A LAMB-KILLING RABBIT.

A pet white rabbit is about the last creature one would suspect of being likely to develop a taste for bloodshed and murder. Ordinarily a white rabbit is about as dangerous as a dove. The truthfulness of the following item, copied from the Shelby (Ohio) "News," is vouched for by one of RECREATION'S correspondents at Shelbyville, Dr. R. D. Pratt.

Another strange freak is reported by Mr. J. L. Zaring, who lives on the Smithfield pike, and its truthfulness is attested by him as well as by all his neighbors.

For some time he had noticed the devastation wrought among his young lambs and had attributed it to foxes. He instituted a watch and was dumfounded when he discovered the lambs were being killed by a pet white rabbit, belonging to his little son. It would attack the lambs by throwing them down, biting them in the side and tearing them to pieces. It killed 10 of the lambs before being discovered.

Dr. Pratt writes:

"Mr. Zaring is a truthful man and I have not only his assurance that the story is true, but his wife also vouches for it. He got the rabbit from his brother-in-law, and it was given to him because of its destructiveness of its own kind, it having killed a good many other pet rabbits. This particular rabbit Mr. Zaring gave to a friend, after he discovered it was killing his lambs, and it was accidentally killed.

"I regret I could not get possession of it and keep it under observation."

## A SINGING COWBIRD.

That really valuable bird, the cowbird, is not popular but he certainly has intelligence. He and his flock follow the cattle and are not over choice as to food. He is a polygamist, and the ladies of his family have simply no character at all, living abandoned lives and laying their eggs in the nests of other birds. Yet the cowbird destroys many undesirable insects, and a recent incident shows that he has unsuspected vocal powers.

M. A. G. Towle, of Chicago, has been interested in a ranch near Niobrara, Neb., and has spent some time there. He noted the great number of cowbirds following the herds and one day saw a single specimen fluttering about on the ground, with a broken wing. He took the bird to the house where its wing soon healed, though the bird remained unable to fly. It was placed in a large cage, hanging near that of a canary. A few weeks later the family was one day astonished by hearing the cowbird attempt to sing, evidently in imitation of the canary's notes. This effort continued until a fair degree of proficiency was attained. Is not this an isolated case?

Stanley Waterloo, Chicago.

The measurements first given, of my big buffalo head, are incorrect, owing to a lack of knowledge on the part of the gentleman who made them. He did not understand

just how to go about this work. For my own satisfaction, for the benefit of your readers who wish to know just how large the head is, and in order to set myself right with my fellow sportsmen who want things correct, I have had an expert measure the big buffalo head and the following figures are correct.

Circumference at base, right horn,  $14\frac{3}{4}$  inches.

Circumference at base, left horn, 15 inches.

Length of right horn 19 inches. Length of left horn 21 inches.

Spread of horns, at tips,  $30\frac{1}{2}$  inches. Spread of horns at widest point  $41\frac{1}{2}$  inches.

Nose to top of skull  $28\frac{3}{4}$  inches. Nose to base of horn 22 inches.

These measurements were made by Mr. Benjamin Batchelor, taxidermist, of this place.

As above stated they are absolutely correct and he, as well as other reliable men here will certify them at any time if desired. J. Gunther, Middletown, N. Y.

In your May number, G.S.G., Meadow Creek, Montana, gives measurements of a deer head, the spread of which is stated as  $33\frac{1}{2}$  inches, with 15 points. He inquires who has a larger head? R. & W. Gilfort, Orange, N. J., have several heads which compare favorably with the Meadow creek deer, and which possibly surpass it. They have the skull and horns of a mule deer, killed in Idaho, the horns of which measure scant  $33\frac{3}{4}$  inches and have 40 points. This specimen is a perfect one and has not horns of abnormal growth.

Another, larger in spread than G.S.G.'s, if not in points, is a mule deer killed in Siskiyou County, California, which measures  $34\frac{1}{2}$  inches scant spread, and has 10 points.

Two other specimens measure  $32\frac{3}{4}$  inches and  $32\frac{1}{2}$  inches and have, respectively, 18 points and 21 points.

Messrs. R. & W. Gilfort have 900 specimens of horns alone, and their collection represents specimen horns of nearly every animal on the globe. Messrs. Gilfort are readers of RECREATION and are anxious to have G. S. G. bring his measuring rod to Orange.

E. H. E., Newark, N. J.

A friend and I were strolling through the woods, one morning last spring, when we met a hunter and his dog. We joined them and were making our way through some bushes, bordering a small stream, when a fox darted out from them. The dog was a fox hound, and he immediately went in hot pursuit. The hunter did not have a chance to get a shot at the fox, and when we emerged from the brush the fox was not to be seen; but the dog was scratching and nosing around what seemed to be a rabbit burrow.

Noticing that the dog was biting at something in the hole, the hunter pushed him away, reached into the hole and pulled out the fox, which was stone dead! Not a shot had been fired at him and we concluded he had been smothered to death.

He had evidently been close pressed by the dog, and had tried to get into this hole, which proved too small for him. He was a red fox and his fur was in good condition.

A. K., Sheboygan, Wis.

Within the last month, the daily papers have reported the death of a Nebraska boy in a badger hole, also from smothering, like the fox described above. Ed.

I would like to trap sparrows and cat birds. Also would like to know how to pickle different fresh water fish.

R. E. Borhek,  
1st Ave., W. Bethlehem, Pa.

Answer.—You should not trap wild birds, at all; for the chances are as 10 to 1 they would languish in captivity and soon die. About the only way to make cage pets, of wild creatures, is to take the young, and rear them in comfortable confinement. With birds this is exceedingly difficult, and boys should never attempt it unless they have big cages, and know all about bird food.

To preserve fish in alcohol, buy "proof spirits" and dilute with 1-3 water. Open each fish, by making a slit along the belly. Remove the entrails, unless they are specially wanted. Wash the fish clean; then immerse in the spirits. Do not crowd the specimens. A large fish requires plenty of spirits, renewed after 10 days. Seal the jars air tight, to prevent evaporation.

EDITOR.

You ask if the buffalo head, on the front cover of May RECREATION, is a record breaker? From the looks of it should say no. The skin seems too tightly stretched. If he looked that way alive I should say he had been mixing up with poison ivy and was badly swelled. I should also say the set of horns was low; or rather that they lopped down sidewise. I am inclined to think an artificial skull was inside and that the horns are not curved in enough. So far as the circumference of base of horn is concerned, if they are loose, and mounted on pith, they might be boiled or steamed and expanded to a considerable degree by manipulation. However, I am not in the horn business and have none to sell, mounted or otherwise.

Onyitta, Manchester, N. H.

"Why is it?" asked the Elephant of the Lion, "that when any mischief is done in the jungle, the Leopard is always suspected first?"

"Well," replied the Lion, "he is spotted by nature."—Louisville Courier-Journal.

Are 6 toes common to cats? We have 4 kittens, 3 of which have 6 toes on each fore foot, and 5 on each hind foot. The other kitten has 7 toes on each fore foot and 6 on each hind foot.

J. H., North Abington, Mass.

Answer.—Six-toed or "double-pawed" cats are quite uncommon, although occasionally known, from time immemorial. This peculiarity is often transmitted to offspring, but it does not occur with any certainty. However, it is quite likely that by careful selection, a six-toed race could be produced. The "double-pawed" cat is even a greater curiosity than the six-toed freak.

In June RECREATION Angus Gaines, in speaking of the brown thrush, says: "Her 4 eggs are of a delicate light blue color, with perhaps a light shade of green, but free from all spots and markings."

I agree with him as to the color; but think he has made a mistake when he says they are free from spots. I have examined a number of eggs, and have a set before me; and all are spotted with fine dots of reddish brown.

Frank A. Tapley, Haverhill, Mass.

I would like to know what is the best book on Taxidermy, that will teach me the rudiments, as I want to learn the business.

F. E. Parsons,  
8 Union St., Danbury, Conn.

"Taxidermy and Zoological Collecting" by W. T. Hornaday, is the best book in the world, on taxidermy. It is published by Charles Scribner's Sons, 153 5th Avenue, New York City. The price is \$2.50.

EDITOR.

How can the male and the female jack snipe be told apart?

L. McC., Little Rock, Ark.

There is no way of certainly distinguishing the male from the female jack snipe (*Gallinago delicata*) excepting by careful dissection. The females average a little smaller, but otherwise are exactly like the males in appearance.

While dissecting a great blue heron, recently, I took a pickerel from its throat, 16½ inches long.

T. W. Fraine,  
Taxidermist, Rochester, N. Y.

Please send me the names and addresses of all the sportsmen of your acquaintance, in order that I may send them sample copies of RECREATION.

Getting subscriptions for RECREATION is easy. The magazine does its own talking. Turn to the premium list, on page xlvi., and see what you can get by sending in a club.

## EDITOR'S CORNER.

### SOME SENSIBLE ADVERTISERS.

Among the advertisers who are carrying full pages in RECREATION, regularly or alternately, are The Marlin Fire Arms Co., Gas Engine and Power Co., The Century Co. (Century dictionary), Erie R. R. Co., The Boston Woven Hose & Rubber Co. (Vim tires), The J. B. Williams Co. (shaving soap), B. T. Babbitt, Northern S. S. Co., Santa Fe Railway, John H. Woodbury, Overman Wheel Co., Eastman Kodak Co., Rochester Optical Co., Manhattan Optical Co., The Kenwood Mills, Fowler Cycle Mfg. Co., E. R. Durkee & Co., Puncturoid Mfg. Co., Acme Cycle Co., E. C. Stearns & Co., Wing & Son (pianos), Monarch Cycle Mfg. Co., Gundlach Optical Co., The Horton Mfg. Co., Forehand Arms Co., Henry C. Squires & Son, Yawman & Erbe (automatic reels), Ames Mfg. Co. (bicycles), Hall & Ruckel (Sozodont), Hiram Ricker & Sons (Poland water), C. B. & Q. Railway, National Gramophone Co., Derby, Abercrombie & Co. (tents and sleeping bags), John F. Douthitt (interior decorations), B. & O. Railway.

Many of these people started in RECREATION with quarter pages, or half pages, for short terms, and have since contracted for full pages, for long terms. Any advertiser who is in doubt as to whether RECREATION is a good medium is invited to correspond with these houses.

Here are the names of some of the good stories that are booked for September RECREATION: "Hunting Near Steamboat Springs," by S. N. McAdoo; "A Yale-Princeton Foot Ball Game," Courtland Nixon; "A Canoe Trip to Rainy River," Harry Silver; "The Bear, the Belle, and the Blackberries," Francis Webster; "Catching A Tartar," Captain J. G. Leefe, U.S.A.; "The Opening of the Season," R. B. Buckingham; "A Bicycle Race, With A Sequel," Miss C. H. Thayer; "An Autumn Horseback Ride," J. F. Gordon; "A Buck Indian and a Buck Deer," J. B. Jennett.

The departments will be as generously filled as usual.

Several strong testimonials of guns and rifles, not advertised in RECREATION, have lately been sent me, for publication, but all have been promptly returned to the writers. It is a rule as old as the printing press that the man who does not advertise gets no free puffs in the reading columns. RECREATION approves of this rule and adheres to it, in all cases.

Some of the makers referred to advertise in all the other sportsmen's journals,

but boycott this one. Then why should I advertise their wares, in my reading columns?

Sportsmen who like RECREATION will be slow to buy goods from people who fight it.

Two ladies of Williamsport, Pa., Miss L. M. Schneider and Mrs. C. V. Taylor, have recently sent in clubs, of 75 subscribers, each, and have received, in return, high grade bicycles. Williamsport is credited, in the census reports, with a population of 27,132. If 150 subscriptions can be obtained in Williamsport, in a week, why not in any other town of like size or larger? Why walk when you can get a bicycle for nothing? Several smaller clubs have been sent in from Williamsport within the past 2 years.

The Vim Tire people write me they consider RECREATION the best advertising medium, of its class, published. They have tried it, with full pages for 3 months past, and should know.

I am always glad of suggestions as to how to improve RECREATION. Every reader is invited to speak out in meeting, and say what he thinks is wrong about it.

There are still some unfortunate sportsmen who are not readers of RECREATION. If you know any such send in their names, and greatly oblige them and

THE EDITOR.

Will some of my California readers please send me some fine, sharp photos of a rabbit drive? I want them to illustrate a story of that peculiar institution.

Don't fail to read "A Montana Dream," on page 158 of this issue. It is good, and you will like it.

I have been in a good many game countries, but this is the best I have ever seen. Goats and bear are more plentiful than needed, for good sport. Elk are fairly numerous; mule deer are plentiful on the mountains, and white tail deer are thick on all the bottom lands. There are blue grouse on all the mountains and fool hens and ruffed grouse in the low lands. The fishing cannot be beaten. I have seen a good many elk this summer.

M. P. Dunham, Woodworth, Mont.



## BICYCLING.

### THE TRAMP CYCLIST.

THOS. CUNNINGHAM.

"I've got \$100 to bet there isn't a cyclist around here that can beat my boy in a race."

The speaker was Squire Holcomb, and he addressed a crowd of admirers, who had gathered around to congratulate him on his son's victory in the 2-mile race, which had just been run from Brown's crossing to the church.

His son, Edward, owned a handsome Victor racer, geared to 80, and had ridden a wheel for years, while most of the other boys had only recently purchased bicycles. These were second-hand wheels, such as are often termed "ice wagons." Only one boy in the village, Harry Wesley, owned a wheel that could be compared to Edward's. This was a Tribune, also geared to 80, but Harry had ridden it only 2 months, so had not had time to "train down."

It can be seen, therefore, that Edward's victory hardly warranted the Squire's enthusiasm, but he continued to repeat the offer, until, finding no takers, he exclaimed:

"I'll give this \$100 to anyone here who will race Edward and beat him."

"I suppose that offer is open to me as well as to any one else."

Surprised, everyone turned to look at the speaker. As the man stood in the middle of the road, where he had arrived unperceived by any of the group, he was a picture of that specimen of humanity so familiar of late years—the "hobo-dude."

"Well, am I in this?" drawled the tramp, as he adjusted his straw hat and dusted his dilapidated patent leathers.

"No, you're not in it!" stormed the Squire. "Do you suppose I'd have my boy race with a tramp?"

"Oh, it doesn't make any great difference with me, only I supposed you were a man of your word."

At this, the Squire grew red and white by turns. The tramp had touched him in a weak spot; for the Squire prided himself on keeping his word.

"But you have no wheel," exclaimed the Squire, hoping to escape in this way.

"That's easily fixed," quoth the tramp, as he stepped to Harry, and possessed himself of his wheel. The latter offered no objection.

"Ah, a Tribune," cried the tramp. "The last wheel I rode was a Tribune. When you're ready, gentlemen, say the word."

The Squire, seeing no way out of it, appointed 3 of the boys to accompany the

riders to Brown's crossing, as starters, while he and 2 others were to be referees. The tramp threw off his coat and hat, revealing, instead of a white shirt, only the bosom of one, to which was attached a paper collar. A pair of cuffs of the same material were fastened to his coat-sleeves. He then rolled his trousers up above the knees, displaying a pair of legs that made Edward look rather dubious.

These few arrangements completed, he mounted his wheel, Edward following, and accompanied the 3 boys to the place of starting, where the 2 riders were placed in position and the signal given.

At the start, Edward led by several yards, the tramp apparently finding it difficult to "limber up." Their positions remained the same for the first mile, when the tramp spurred and passed Edward, getting the lead by about 50 yards. Edward was unable to close up the gap, and was still about this distance behind, when, on rounding a slight bend in the road, with the goal in plain view, half a mile distant, a startling thing occurred.

A young girl rushed out of a lane, about 100 yards ahead, crying loudly for help. As the tramp reached this point a few seconds later, he had to spurt to avoid a collision with a furious bull, which at that moment dashed into the road after the girl.

With a glance the tramp took in the situation. Paying no attention to the bull behind him, he rode as close as possible to the child, stretched out his right arm and swept her up on the handle-bars in front of him. At the same time, a red sash (the cause of all the trouble) which she wore around her waist fluttered to the ground.

"Put your arms around my neck," he cried, then bent to his task, and drove the wheel ahead with fierce energy.

Had he looked behind, he would have seen that the race was virtually ended, for the bull had stopped and was tearing the sash to pieces; while Edward, having recognized in the little girl his sister Alice, had become completely unnerved. Losing control of his wheel, he took a header and was now on all fours in the middle of the road, looking in a dazed way at the antics of the bull. Unaware of this, the tramp sped on and passed the crowd at the church, amid great cheers, for they had all been anxious spectators of the clever rescue.

When he had checked the wheel, and returned to the church, he was greeted with congratulations from all sides. The Squire extended his hand, exclaiming: "My friend, forgive me for my treatment of you. Your recent conduct compels me to admit

the truth of the old saying: Clothes don't make the man."

"Ah, that reminds me," drawled the tramp, and stepping to the spot where he had left his coat and hat, he put them on.

"Come with me," cried the Squire, "you mustn't wear those things again."

"On the contrary, I must," was the reply. "You see, I'm trying to introduce this style; and that's my object in traveling around—a sort of advance agent of the Prince of Wales you understand."

At this moment Edward rode up looking very tired.

"Down from that wheel, Edward, and turn it over to this man," cried the Squire. Then to the tramp: "Here, my friend, is the \$100, and the wheel goes with it—you have shown yourself worthy to ride it."

The tramp thanked the Squire in his drawling way; then, fishing in his pockets and producing a cigarette, he lit it, doffed his hat gracefully to the crowd, mounted and pedaled slowly down the road.

That evening at the village store, when the usual crowd had gathered to talk over the events of the day, the Squire appeared with a \$100 bill. "I've got \$100," he said, "to bet there isn't a man around here that can beat that tramp. Any takers?"

Touching the tandem, let's decide,  
If they shall fall in love who ride—  
Or if, as may be, this is all,  
That they who ride in love, shall fall.  
—Detroit Journal.

#### USEFULNESS OF THE BICYCLE.

Lack of suitable means of conveyance has practically excluded many people from the study of certain branches of science and art. For instance, the study of microscopy. The student of the smaller things in nature soon exhausts his immediate field of investigation, but when the country, for miles around, is presented him by use of the wheel, interest in the microscope and bicycle are jointly augmented. The discovery of new pools, each teeming with a world of microscopic life, new plants and insects, all add to the value of the wheel in the estimation of the microscopist, and whenever he goes out he is pretty sure to carry his paraphernalia for gathering specimens; so that he not only benefits by the outing, but also secures the means of passing many profitable hours indoors. This applies also to the geologist, mineralogist, botanist, or any other student of nature.

To the artist the bicycle is the missing link between himself and nature. It carries him outside of brick walls and burning pavements, into open fields, among trees and rocks and picturesque buildings where he may sketch or study subjects in their natural environment.

The photographer finds in the wheel his

natural ally. It carries him and his camera to the objective point, and widens his range beyond what could ever have been contemplated before the invention of the bicycle.

Appliances are made for carrying, on the bicycle, the instruments and apparatus of these out-door students of nature, and it would seem a simple matter to provide others which would enable the wheelman to proceed on his journey of investigation without hindrance.

The first American made bicycle was sold March 13, 1878.

"Give her air! Give her air!" "What's the matter? Has the woman fainted?" "No; her bicycle tire has flattened."

—Philadelphia North American.

#### A MONTANA DREAM.

JOHN V. COLE.

I heard of a widow, one time;  
She was plump, she was pretty and neat.  
At that time I hadn't a dime,  
But I wanted this widow, so sweet.

She had stock on the ranges, they said;  
She had mines of both silver and gold;  
It put me most out of my head,  
For where she was at, no one told.

My cabin was lonesome and drear,  
My placer mine all was dug out;  
My grub it was gone—pretty near,  
And my gum boots leaked all round about.

I was mending these old boots one night,  
I had seated myself on the floor,  
When a lady rode up, on her bike,  
And punctured her tire, at my door.

She was hungry, and tired, and lost,  
So I cooked her a meal right away;  
That gum boot cement it was boss  
For mending bike tires so they'd stay.

I saddled my broncho up then,  
And escorted the widow to town;  
I stayed there to chat until ten,  
And I felt like a man of renown.

Now I've traded my bronk for a bike,  
With seats for my wife, self and boy;  
And I gladly remember that fortunate  
night,  
For it filled my life chuck full of joy.

"Our cook is crazy about bicycling."  
"Does she ride much?"  
"Ride? She gets on her wheel to hang  
out the washing."—Detroit Free Press.

## WHEELING FOR PLEASURE.

In February, '96, I undertook to find out how many miles a person, riding merely for pleasure, could cover in a season of 10 months.

At the close of the season I was surprised to learn that I had ridden 3,000 miles; enough to have covered the distance from New York to Yuma, Arizona.

We had a very dry, pleasant summer, that year, and the roads were in excellent condition for wheeling. My riding was done mostly on Sundays, and evenings, with my club friends. By starting in the morning and returning the same day we managed to visit most of the cities, towns, and villages, within a radius of 60 miles of New York.

I rode, during September and October, 874 miles, making only 2 centuries in that time, and these were with the club. The greatest distance I ever rode in one day was 128 miles. This was done in 12 hours.

In all this riding I have never received a scratch. I have been in several collisions, but my wheel always got the worst of them. In one instance I had to ride 22 miles, with only one pedal, the other having been broken off at the crank.

Geo. A. Einsetter,  
Century Wheelmen, New York.

## CHOICE OF NECKS.

See the girl!

The girl is falling on the neck of the man.

Does the girl fall on the neck of the man because they are alone in the gloaming?

Partly.

Chiefly, however, the girl falls on the neck of the man because she is learning to ride the wheel, and the man is her instructor, and she chooses to fall on any old neck rather than on her own.—Detroit Journal.

## GOOD ROADS.

A writer in the L. A. W. Bulletin says: I saw a gang of prisoners, in Atlanta, Ga., building a first-class road. They were working out their salvation, giving the county good roads; conflicting in no way with free labor, and who can say they were not better off, morally, in God's free air than when penned up, in idleness, in a foul-smelling prison?

On the island of Jamaica, where I made a bicycle tour last winter, and where they have the best roads this side of the Atlantic, we saw 2 large prison gangs at work preparing material for roads. There must have been over 300 in each gang, but we could not make a careful estimate of the number because we had to keep moving.

There could be no more effective plan

for getting rid of tramps, or of that class of men who steal and fight, and are sent up for 6 months, filling our jails at great cost to the people, than to make them work. They should be compelled to earn their living by working on the roads, where they would do free labor the least harm.

## RUBBING IT IN.

He was all out of breath as he jumped from his wheel, hastened to a ticket office in the little suburban station, and anxiously inquired:

"Can I catch the 4.30 express to Jersey City?"

Never a hair turned the official, as he looked up from the paper he was reading and answered:

"That depends on how fast you can ride, young fellow. She left here 5 minutes ago."—Exchange.

William H. Baldwin, president of the Long Island Railroad, has joined the L. A. W. and is planning a great scheme for the benefit of wheelmen. His proposition is to convert Long Island into a wheelman's paradise. He proposes to do this by appealing to and encouraging the different communities on the island to improve their highways, to build cycle paths and to arrange for the generous treatment of all touring and visiting riders.

President Baldwin has employed a special agent, in connection with the passenger department of his road, to get up printed matter and maps, showing the various routes for wheelmen with descriptions of roads, scenery and hotel accommodations, showing where best to start from in making short runs or long tours. This literature will be spread broadcast for the information of riders. He says "Long Island will be made a cyclists' paradise before we get through with it."

One of the most delightful bicycle rides, out of New York, is that over what is known as the Seabright circuit. To make this you leave from foot of West 14th street, by steamer Mary Patten or Elberon, at 8.30 or 9 a.m. and reach Seabright at 12 m. Here you disembark and ride down Ocean avenue 6 miles, crossing the Shrewsbury river at Pleasure Bay, near the Hotel Avenel; go West to the famous Rumson road and North on this to Seabright, where you connect with the return boat, reaching New York again at 8 p.m.

The sail is about 60 miles and the ride 22 miles, over the finest series of roads in the country. Steamboat fare, for the round trip, is but 50 cents.

## BOOK NOTICES.

Hon. John S. Wise's dog book is out, at last. It has been referred to in a previous issue of RECREATION, but lest some unfortunate reader may have neglected to order a copy of it, I will state, again, that the title of it is "Diomed;" that it is the most charming dog story ever written; that it is a work of 330 pages, with nearly 100 beautiful illustrations, and that it sells for the very easy price of \$2.

John S. Wise, the author, has done as much to promote a love for dogs, in the minds of the people, as any other man living. He has also done a great deal to elevate field sports and to improve the blood of field dogs. He was for many years president of the Pointer Club of America. When he took that position, dog shows drew only sportsmen, and few of these. Now these shows are crowded by society people, many of whom care nothing for shooting, but all of whom like a good, well bred dog. Mr. Wise has been largely instrumental in bringing about this change. His name, in connection with any dog show, or field trial or strain of dogs, has been, for many years, a guarantee that fairness and squareness could be expected from that source, and this, I am sorry to say, was not the case when he entered the field of dogdom.

Diomed is the life story of one of Mr. Wise's famous hunting dogs, purporting to have been told by the dog himself. It is told so naturally, and in so graphic a way, that the reader forgets, entirely, that the beast is dumb and that some one else is speaking for him.

At a recent dinner of the Camp Fire Club, Mr. Wise was invited to read a favorite chapter from his book, and did so. The 50 ladies and gentlemen present were fascinated, and spellbound by the intensely dramatic interest of this small portion of the narrative, and at every pause they applauded, heartily, and cried "Go on." They would have had Mr. Wise read the entire book, that evening, if they could.

At the close of the reading, there was a perfect tumult of applause, and dozens of the guests crowded around Mr. Wise to commend and congratulate him.

This book is bound to sell, by the thousands, and I trust no reader of RECREATION, who has not already a copy of it, will go to bed without ordering one. Send your order direct to John S. Wise, 44 Broad Street, New York. It will warm the heart of the veteran sportsman, and you will get, in return, a book that will warm your heart, through many a long evening.

Do not forget to mention RECREATION, when you write for the book.

"How to Listen to Music" should be in every home and every library in America. It is one of the most satisfactory books of the year—as fascinating as a romance and as instructive as a text-book. Mr. H. E. Krehbiel, to whose keen perception of our deficiencies and our desires, we owe this delightful book, has been for many years musical critic for the "New York Tribune," and is the author of "Studies in the Wagnerian Drama," "Notes on the Cultivation of Choral Music," etc.; but he never struck a happier note than he has in this, his latest work. It appeals to every lover of music, though Mr. Krehbiel modestly disclaims the attention of professional musicians. It is doubtful if there are many of that class who would not enjoy reading this book; yet it has evidently been written with a genuine desire to reach and benefit a far more numerous class—those who are fond of music, but in the vague, untrained way due to lack of knowledge. For these people, Mr. Krehbiel analyzes the elements of music, defines the kinds, describes and explains the composition and scope of the orchestra, outlines the various divisions of pianoforte music, classifies opera and treats of the value of choral music. His knowledge of the history, purpose and meaning of music is apparent in every line, and is imparted with wonderful clearness and force. He has sifted the learning of a lifetime into a form and compass within the reach and understanding of everyone; but he has served a higher purpose, as well, for no one can read this book without being inspired with a desire to know more of music, both by hearing the best and by studying its historical and intellectual side.

The sales of "How to Listen to Music" have already been enormous and will surely increase as the fame of the book grows. It is seldom so much of value can be had for \$1.25. Twelve fine half-tone plates illustrate various orchestral instruments, each in the hands of a master. The public owes a debt of gratitude to Mr. Krehbiel and to Messrs. Chas. Scribner's Sons, his publishers.

Percy Selous and H. A. Bryden have written an interesting book entitled "Travel and Big Game." It is a collection of disconnected stories of hunting trips, made by the authors in various parts of the world. The following chapter headings indicate the nature of the book: "By sea and land;" "Hunting and trapping in Canada;" "Desert hunting;" "Leopard hunting in Bechuanaland;" "After grizzlies in the Rockies;" "Hunting wapiti and moose in North America;" "Lion

hunting in South Africa;" "Lions again;" "How I shot my rhinoceros;" "Shooting hippopotami on the Limpopo river;" "Once more in the Rockies;" "Giraffe hunting;" "After buffalo and zebra."

There are several full page illustrations by C. Whymper but they are not so good as several of our American artists would have made. English artists are away behind the Americans in the matter of wash drawings.

Travel and Big Game, by Percy Selous and H. A. Bryden. Longmans, Green & Co., New York.

"Life and Immortality; or Soul in Plants and Animals," is the name of a new book by Thos. G. Gentry. This is a carefully prepared study of the life and habits of many of the smaller birds and animals, as well as of certain plants. The book contains 489 pages and many illustrations. These latter are not, by any means, what they should be, in an artistic sense; yet they are in the main correctly drawn, and the pictures are thus highly instructive. There are many new and interesting facts brought out, in this book, and it will certainly be of great benefit to students of nature.

Life and Immortality, or Soul in Plants and Animals; by Thos. G. Gentry, Sc. D. Burk & McFetridge Co., 306 Chestnut St., Philadelphia; \$2.50

Charlie Fee, General Passenger agent of the Great Northern railway, is always doing something handsome for the public, and his "Wonderland" book, for '97, is one of the most beautiful souvenirs he has ever put out. The pictures in it are a perfect panorama of the great Northwest. They portray the wheat fields, the cattle ranges, the hunting and fishing countries, the fruit orchards, the mining camps, the mountains and that greatest of all wonders, the Yellowstone National Park.

You can get this book for 6 cents in stamps, by mentioning RECREATION, and it is worth \$2. Write Chas. S. Fee, G. P. A. N. P. Ry., St. Paul.

The Erie Railway Co. has issued 2 beautiful books, one entitled "Summer Homes," and the other "Fishing on the Picturesque Erie." Both are beautifully and artistically illustrated, and contain a great deal of valuable information. The reproductions from photographs are among the finest I have ever seen and no one can look at them without longing to be among the hills or on the waters they so charmingly represent. Write D. I. Roberts, G. P. A., 21 Cortlandt st., N. Y., for copies of these books, inclosing 6 cents in stamps. Say you saw it in RECREATION.

The Gas Engine & Power Co. and Chas. L. Seabury & Co., Morris Heights, N. Y., have lately issued the most beautiful yacht

catalogue I have ever seen. It abounds in half tone reproductions of photographs, of a large number of the famous steam and naphtha yachts of the country. Many of these pictures are works of art, in which all amateur photographers, especially, will delight. Yachtsmen will examine them with keen interest and every lover of art will appreciate both the pictures and the typographical and press work of the book.

Altogether this is a catalogue that every reader of RECREATION should have. It can be had for the asking, if you mention this magazine.

---



---

## PUZZLE CORNER.

### HIDDEN LETTER PUZZLE.

There are just seven letters in  
My bi-syllabic name,  
Three vowels and 4 consonants,  
With 2 of each the same.

The first 2 are in Wheeling seen,  
Two in Lawn Tennis stay,  
The fifth in Coaching, but the sixth  
And last are in Croquet.

In playing golf on Scottish links  
My whole is often found  
Its fragrance cannot be excelled  
Where'r it doth abound.

### ENIGMA.

I am composed of 20 letters and of ingredients which are absolutely pure.

My 4, 9, 7, 13 is a part of the face.

My 14, 10, 19, 1 is a part of the ear.

My 18, 17, 11, 20 is a bivalve.

My 8, 2, 16, 6 is a vegetable.

My 15, 5, 3, 12 is a house made of cloth.

My whole is useful all the year round, but invaluable in warm weather.

Here are 2 new puzzles. A package of merchandise is offered each person who solves it. This offer is good until September 30, '97.

Always state on what page the ad. is printed, which contains the involved word.

---



---

I received my gold watch and thank you sincerely. I am much pleased with it, as it is better than I expected. I intend working harder than ever for RECREATION.

Eddie Cousins, Toronto, Ont.

I received the Premo camera you sent me, as premium for 20 subscriptions to RECREATION. I am much pleased with it, and recommend your magazine to all.

O. Vermilye, Sandwich, Ill.

Thanks for the Ideal reloading tool, which I received O.K. I have tested it and find it complete. Can hardly tell the shell I loaded from the factory one.

A. McKay, Seckerton, Ont.

## AMATEUR PHOTOGRAPHY.

### HOW TO USE BROMIDE PAPER.

Rochester, N. Y.

Editor RECREATION: Mr. P. F. Shea, Chicopee Falls, Mass., requests some amateur photographer to inform him, through RECREATION, how to use Eastman's bromide paper. He does not state whether he wants to use it for contact printing or for enlarging purposes. However, I have had some experience in both, and take pleasure in stating my *modus operandi*. The Hydrochin developer suits me as well as any, for either negatives or bromide prints. The powder form, as supplied by Eastman, is convenient to use and keeps a long time.

Of course, bromide paper is entirely different from printing out papers, on account of its being so much more sensitive, which necessitates special care to prevent being fogged by light, and on account of the image not showing until developed. For these reasons the paper is treated more like a negative. Bromide has one great advantage over printing out papers, in that it can be manipulated at night. Flashlight exposures can be made, the negatives developed, and bromide prints made, in one evening.

For contact work, from either film or glass negatives, I use an ordinary printing frame, for exposing, and with the average negative allow say 15 seconds exposure, to the light of a good oil burner, about one foot distant. If daylight was used for exposing, probably 1-10 of this time would be sufficient. The Eastman enamelled paper comes in 2 grades—hard and soft. The latter seems the better for artificial light. Of course, with bromide paper the tone is obtained entirely in developing; so that when the print is dark enough you throw out the solution; then rinse once or twice, and immerse in the fixing bath.

In enlarging I use a No. 5 Folding Kodak. The window in the dark room has a slide in the centre, which lifts up with a cord, and the opening is covered with a ground glass frame having a groove in the front into which the negative carrier slides. The kodak is placed on a shelf, just in front of the negative carrier, with the back toward the negative, and the focussing glass removed. The back of the camera is dropped down and the case connected with the negative frame by black cloth, to keep the light from entering the room excepting through the lens, in which way it reaches the exposing table, standing in front. This table is simply a large box, in a vertical position, with the side next to the camera covered with white paper. The image is focussed sharply, by means of the focussing lever, after which the shutter is closed, the

sensitive paper put in position by pinning at the corners, and the exposure made. Of course, the desired size of the print has previously been secured by moving the box back and forth.

The most difficult part about enlarging is to secure the correct length of exposure. This can easily be ascertained by making some trial exposures. Tack a small piece of paper on the exposing table and try it, for say one minute. On developing you can easily tell whether it is over or under timed. If the latter, the development will be slow and the print will be faint. If over timed, it will develop quickly. It should develop about the same as a negative. This applies also to contact prints.

One great advantage in making prints by enlarging is that you can vignette out any part of the negative so as to give the balance more exposure. This can be done by the hand or with a piece of cardboard, cut in a suitable shape. Of course, a small stop in the lens will give sharper prints than a full aperture. Any kind of a camera can be fitted up for enlarging purposes. Daylight is best, as condensers, which are quite expensive, are not required.

W. W. Day.

---

### MAKE THEM LOOK THE OTHER WAY.

I must once more call the attention of amateurs to the great mistake many of them make, of allowing their subjects to gaze at the camera. I receive photos nearly every day that are unfit for publication, on this account, and that otherwise contain much good material.

Now comes one showing a team, stalled and apparently broken down, in the woods; but the 4 hunters and the driver, instead of making any effort to repair the damage, or to get the team out, are sitting quietly in the wagon and staring at the camera in order to have their pictures taken, and in order that their friends may all know them when they see the picture. It would seem that practical men would have been employed in trying to get out of the difficulty. Even if they had only made believe they were busy, and if the plate had been exposed on them at such a time, the picture would have been full of interest; but as it is, it merely shows that the condition of affairs was brought about simply for the purpose of having the picture taken. It is therefore entirely worthless.

All amateurs should study the pictures shown on the cover, and on the lower half of page 411, and the lower half of page 430, of June RECREATION, and on pages 5, 6, 7, and 16 of July RECREATION. Here are ideal photographs. The situations are worked

Definition of the word

**“KODAK”**

The *Standard Dictionary* says:  
 “Kodak is an arbitrary word constructed for trade-mark purposes.”

We originated and own this trade-mark. No camera is a “Kodak” unless manufactured by the Eastman Kodak Company.

Don't let the clerk sell you any other camera under the name of “Kodak.”

If it isn't our make, it isn't a “Kodak.”

**Bicycle Kodaks, \$5.00 to \$25.00.** *Booklet free.*

*“You press the button,  
 We do the rest.”*

\$2,853.00 in Prizes for  
 Kodak Pictures.  
 \$1,475.00 in Gold.  
 Send for “Prize Contest”  
 Circular.

**EASTMAN KODAK CO.**

**ROCHESTER, N. Y.**

up purely for the purpose of making good pictures, yet one would think none of the subjects knew they were being photographed. It looks as if they had merely been caught in the act; as if they were entirely unconscious of there having been a photographer anywhere near them.

If you want to photograph a man, in conjunction with a deer he has killed, or a string of fish he has caught, put him at work, measuring, dressing, hanging up, or in some way looking after and looking at his trophy. If you cannot prevent him from looking at the camera in any other way, get a big club ready and threaten to hit him between the eyes, if he turns them toward you.

---

#### RED SPOT ON PRINTS.

They appear on all styles, varieties and brands of paper, whether it be albumen, platinum, bromide, carbon, glace or aristo. They come from the hypo, and in most cases can be traced back to the washing of the negative.

An under-washed plate, or negative, after it comes from the hypo or fixing bath, will cause you endless trouble, from start to finish.

Red spots, on all brands of paper, are due to the careless way in which you handle prints while having hypo on your fingers, from toning. First you begin to tone, and the first print, second and third are giving you complete satisfaction. You imagine you are on the road to success and that you know it all, now. The next moment you take up your fourth, fifth and sixth prints, which are still in the gold bath, and behold you find a red speck on one, a long red mark on another and a big thumb mark in the centre of your pet print. Then you wonder what the matter can be. Possibly you neglected to wash your hands, after placing your first prints in the hypo bath, and handled these prints with the hypo still on your fingers.

Never, in any case, place any chemicals in platinum toning dish or gold toning dish but their own respective baths. If you do you will never be able to use them for toning again. The platinum bath dish must not be used for gold bath, and "vice versa." They will become absolutely useless for toning purposes if you do. Soap, of all kinds, is also disastrous (except castile).

Mrs. C. W. K., New Haven, Conn.

---

This is the time for amateur photographers to be making pictures for RECREATION'S 3d annual Photo Competition, and I trust all who are interested in this art, will improve present opportunities. You are now thoroughly familiar with the wants

of RECREATION, in this line, and should be able to profit by the experience of the past 2 years. Strive for novelty and originality, in everything you do. Aim to surpass, in every respect, your work and that of your competitors entered in the former competitions.

---

#### APPLYING COLOR TO LANTERN SLIDES.

If moist water colors are to be used, it will be found that the film rather repels the water, in places, and absorbs it unevenly at other places. To minimize this, keep the brush rather dry, i.e., use as little water as convenient, and add to the water a little "prepared oxgall" (to be bought of artists' colormen). As the application of colors to slides now-a-days is almost entirely restricted to flat washes for diagrammatic purposes, e.g., maps, plans, drawings of apparatus, etc., etc., it is important to use as large a brush as convenient, and not to go over the same place more than once.—The Amateur Photographer (English.)

---

I am a reader of RECREATION, and would not be without it for twice the price. Will you kindly say, through its columns, that I would like to exchange photos with other amateurs. I make what I consider good pictures. I get a great deal of information from RECREATION and hope the boys will continue to write their experiences. D. B. Fales, Plattsburgh, N. Y.

---

Where would you aim at a grizzly, if he were walking slowly by, at 50 yards? This is a mighty serious question, when you come to sit down and think of it. Take 3 shots at the one on page viii, and send in your score.

---

If you have sent in a club of subscriptions to RECREATION, and have gotten your premium, and if it be satisfactory, please tell all your friends about it and advise them to do likewise.

---

Please send me the names and addresses of all the sportsmen of your acquaintance, in order that I may send them sample copies of RECREATION.

---

"Madge surprised me last night."

"What did she do?"

"Threw a book at me."

"—and smashed the lamp?"

"No; it broke my new eye-glasses."

---

"Queer about law in this country."

"What is queer?"

"It is able to stop vitascope pictures of prize fights, but it isn't able to stop prize fights."



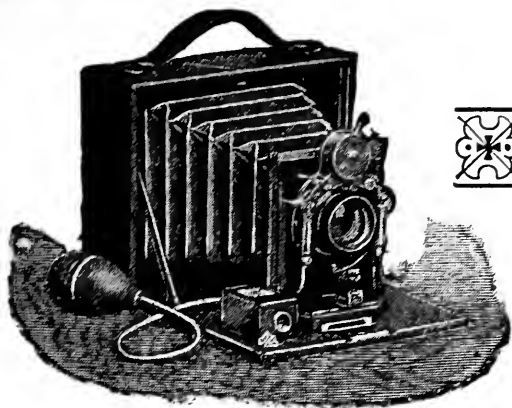

**P**REMOS  
PRODUCE  
PERFECT  
PICTURES

# Premo Cameras

Have achieved an enviable reputation the world over. Their PERFECT construction and ease of manipulation, combined with grace, beauty, and superb finish, have placed them in the front rank, and they are to-day the Favorite Camera with the foremost Amateur and Professional Photographers.

MADE IN

**20**

DIFFERENT STYLES  
AND SIZES

Special Designs for the Sportsman and Tourist

CATALOGUE MAILED FREE

Rochester Optical Co., Rochester, N. Y.

## PUBLISHER'S DEPARTMENT.

### METAL BOATS.

The following will interest all anglers and duck shooters:

Boston, Mass., April 5, 1897.

Mr. W. H. Mullins,  
Salem, Ohio.

The metal ducking boat I obtained from you, last summer, was received at the Me-gantic Club House, on Spider lake, P. Q. I spent several weeks there, soon after the boat arrived, and had an opportunity to test it under all conditions of water and weather. I was surprised to note the fine behavior of the little craft in a rough sea. In skilful hands I think it can be kept perfectly dry under any conditions of sea which are found in our inland bodies of fresh water; and the best feature about it is that if by unskilful handling it fills, it will not sink. My boat will float nicely with more than 700 pounds of weight in it; and has, when filled with water, sustained the weight of a man and 3 boys. I am quite positive that with 2 men it might be depended on, if filled with water. There is no room for doubt that it is the safest boat of the kind afloat. This feature is of the utmost importance when one has boys about, who are not always as careful, in a boat, as they should be.

For shallow water, or for poling up a shallow rapid stream, I found the metal boat excellent. I was fearful that drawing it over pebbles, or running it into stones, might dent or destroy it; but such was not the case. It had a good deal of such usage, and is just as good now as when I received it. The only mark of wear, which was visible, was the scraping of the paint off the bottom. It is a great advantage of your metal boats that they may be taken from the water, wiped dry, painted and as soon as the paint is dry put into the water again. The slow drying out process, which is necessary with wooden boats before they are ready to be painted, is wholly avoided. Where many boats are in use, and it is desirable to have them constantly in readiness, this is a valuable feature. Yours truly,  
Wm. A. Macleod.

Mr. Mullins writes me: "I shipped a car-load of boats to Denver, Col., about 2 weeks ago, and immediately on their arrival there, received an order for another car-load, duplicating the first order."

He is having a large trade on his metal boats, receiving many orders from Europe, as well as from all portions of the United States.

The American and Continental Sanitas Company employed an expert chemist to

make a thorough analysis and a series of tests, of the Sanitas preparations, to determine their exact powers and qualities. The man selected for this important work was A. B. Griffiths, Ph.D., F.R.S. (Edin.), F.C.S. (Member of the Chemical Societies of Paris and St. Petersburg, author of "A Manual of Bacteriology," "The Physiology of the Invertebrata," etc.). His report has lately been printed and may be had by writing the Sanitas Co., 636 W. 55th Street, New York.

This report is exhaustive and is deeply interesting. It should be read by all who are interested in maintaining proper sanitary conditions in their homes, their offices or in public institutions of any kind.

Professor Griffith's concluding remarks are as follows:

There is no doubt that "Sanitas Oil" and "Sanitas Fluid" are most powerful disinfectants; consequently they should not only be used for disinfecting rooms, hospitals, barracks, prisons, etc., but also employed in the treatment of infectious diseases—such as cholera, diphtheria, scarlet fever, measles, glanders, typhoid fever, tuberculosis, puerperal fever, etc.

My investigations prove that the "Sanitas" preparations are most valuable disinfectants or germicides.

---

The Burton automatic adjustable handle bar is certainly a great invention for wheelmen.

It is provided with a locking device which can be locked and unlocked while riding, and which will remain rigid by means of compensating devices, which take up the wear of the lock.

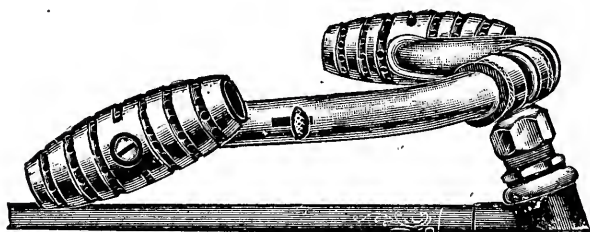

It is made of the best seamless tubing. Interior working parts are of steel and the grips of aluminum. These grips are hollow, are ventilated, and can be adjusted to any desired position, as you ride. It is exceedingly restful to the hands to occasionally change your grips from one position to another.

This new bar is made by Thomas Kane & Co., 64 and 66 Wabash Avenue, Chicago. Ask for a descriptive circular, mentioning  
RECREATION.

The Forehand gun you so generously sent me, as a premium, is a beautiful weapon, and shoots as well as it looks. I cannot thank you too much for the munificence that placed so valuable an arm in my hands.

RECREATION talks for itself, and I am sure many of your readers do not comprehend the plan you have adopted for increasing its circulation, or you would keep the various factories running, on your orders alone.

I have no hesitation in saying you are publishing the cleanest sportsmen's journal in America, and one that the entire family may read with profit and interest. I say, sincerely, long life to RECREATION and its editor, and wish them every success. They will always have a good word from

Jno. Boyd, Toronto, Ont.

The 20th Century Bicycle Headlight is said, by those who use it, to be one of the best bicycle lamps ever made.

It is made in 2 sizes, the larger being designed for country roads, and for tandems. This larger size is known as the "Tandem," and the regular size, of last year, is known as the "Standard."

A good way to find out all the details of construction, of this lamp, is to write the makers for a catalogue. Address Betts Patent Headlight Co., 17 Warren St., N. Y. Mention RECREATION.

Two correspondents of RECREATION have lately given testimony as to the excellence of Vim Tires, and I am glad to add mine. I am riding a pair of these tires and the way they hold their position on wet asphalt, even in making short turns, is mighty reassuring. Few wheelmen who have once ridden Vim Tires would ever ride any other.

I have done well, in my fly-tying business, and every fly has been sold through my ad. in RECREATION. Another magazine solicited an ad. from me. I finally consented to place one, but got no business from it, and hereafter will stick to RECREATION, the leading magazine in this country.

Dr. Wm. Greenshields, Romeo, Mich.

If you have any idea of buying a trunk, a gripsack, or a gun case, write Crouch & Fitzgerald, 161 Broadway, New York, for a catalogue. They make mighty good furniture. I have used their trunks 20 years and have seen many a baggage smasher throw up his hands and admit that he could not break them.

"I cannot longer keep the wolf from the door," he sighed, his head sinking dejectedly on his breast.

Thus he sat until his wife came and kissed his throbbing temples and sought to cheer him.

"Perhaps the wolf will go around to the back door," she whispered.

It was woman's way of reflecting on the bright side of things. She hadn't much use for a side she couldn't reflect on.—Detroit Journal.

"Freddie, why did you drop the baby on the floor?"

"Well, I heard everybody say it is a bouncing baby, and I wanted to see it bounce."—Boston Traveller.

I received the Premo D camera yesterday, and am very much pleased with it. It is a great deal better than I expected, and an expert photographer, who looked it over, said I could not get a better one, anywhere, for the money.

Albert L. True, Lancaster, Mass.

If you know any sportsmen who are not yet readers of RECREATION send me their names and addresses and I will send them sample copies. Thus you will confer a favor on them, as well as on me.

Received my Bristol rod on the 20th of April, and many thanks for your promptness. It is a very handsome rod, and one that will do good service.

H. H. Melcher, Cumberland Mills, Me.

Being myself a practical printer and engaged, with my father and brother, in the publication of a newspaper, I cannot see how you can make such wonderful inducements to secure subscriptions, when your magazine is worth double the price you ask for it. Unquestionably, you must have an enormous circulation to do this.

F. N., Helena, Mont.

Your journal affords me and my family much pleasurable reading, and your puzzle page helps while away the evenings, besides being a profitable mental occupation. RECREATION occupies a prominent place on my reception room table, and I never fail to put in a good word for it—an easy matter, since it also speaks for itself.

S. S. Davidson, L.D.S., Ottawa, Can.

I like RECREATION better than ever. Have read it 2 years, and hope never to be without it. I consider it an educator in the highest order of sportsmanship. I see only one way to educate the boys of our town to true sportsmanship, and that is to have them read RECREATION.

Thos. A Harrison, Burnet, Tex.

I enjoy reading your excellent magazine more than any of the others I take; and although it is cheaper than the others, I think it excels in quality as well as quantity. I especially enjoy the excellent reproductions of the amateur photos which it contains.

C. F. Worthen, Barre, Vt.

RECREATION is the most interesting periodical I have read I read it from cover to cover, and can hardly wait till the next number is out. I wish it would come oftener.

J. G. Danner, Baltimore, Md.

RECREATION should find its way into every family. The illustrations alone are well worth the price.

M. V. Turner, Huntsville, Mo.



(Taken on a Carbutt Orthochromatic Plate.)  
By ALOIS BEER, Photographer to Emperor of Austria.

## To Obtain Artistic Results

as much care must be used in the selection of the Plates or films as the Camera.

**CARBUTT'S PLATES AND FILMS**  
(STANDARD FOR 20 YEARS)

Give Universal Satisfaction

Also J. C. DEVELOPING TABLOIDS, put up in 3 sizes, price 25c., 40c., 75c.

If you intend competing for prizes let us assist you in winning by the aid of our Plates, Films, and Developer. For sale by all dealers. Catalogue free.

JOHN CARBUTT, <sup>WAYNE</sup>JUNCTION Philadelphia, Pa.

# Quad Camera

No Separate Parts . . . .  
3½x3½ inch Plates  
Eminently Practical  
Handsomely covered with leather

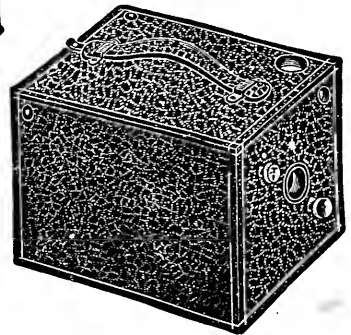

Price, \$5.00 Send 2c. stamp for sample photograph and booklet

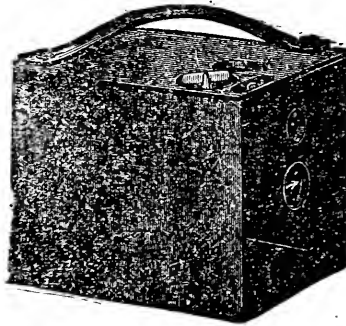

## Buckeye

Twelve Exposures without re-loading. Loaded in daylight. Simple and efficient.

Price, \$8.00 Send for illustrated booklet.

E. & H. J. Anthony & Co.

591 Broadway . . . . New York

If you are in need of  
**A Camera that will produce a Perfect Picture,**  
obtain  
**The HAWK-EYE, Jr.**

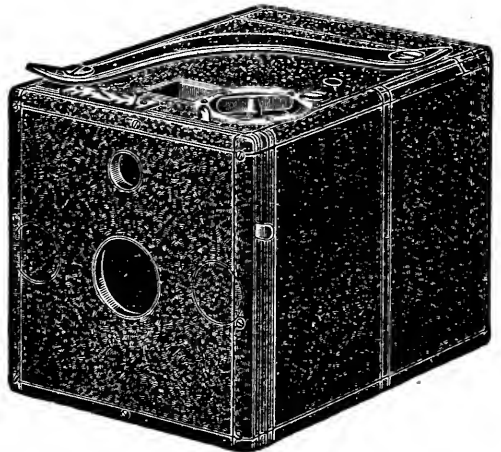

which will be found  
**a faithful friend at all times.**

The simplicity of its working parts enables the novice to obtain results that will astonish old photographers. Size, 4⅜ x 4¾ x 6¼ in. Photo, 3½ x 3½ in. Weight, 20 oz.

**LOADS IN DAYLIGHT, USES EITHER ROLL FILM OR GLASS PLATES.**

Send for Catalogue, giving description of all kinds of Cameras and Supplies.

**PRICE, \$8.00**

**THE BLAIR CAMERA CO., 471 Tremont St., Boston, Mass.**

# The Baby Wizard Camera

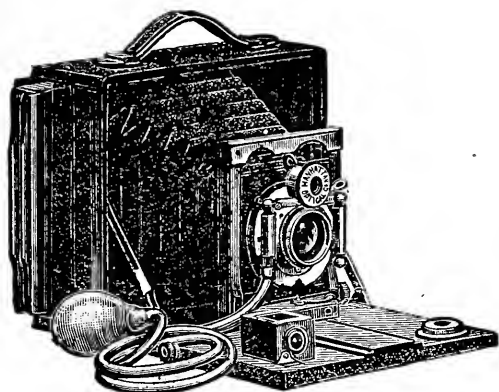

Only  $2\frac{3}{8} \times 5\frac{5}{8} \times 6\frac{3}{8}$  inches ]

*Is the  
Ideal Camera*

FOR TOURISTS, WHEELMEN  
OR SPORTSMEN GENERALLY

*Fitted with our Extra Rapid Rectilinear Lens (unequaled in this country), and the Bausch and Lomb Optical Company's Iris Diaphragm Shutter.*

Complete with Carrying Case

**\$25.00**



Same without rack and pinion, for focussing, and swing back

**\$20.00**

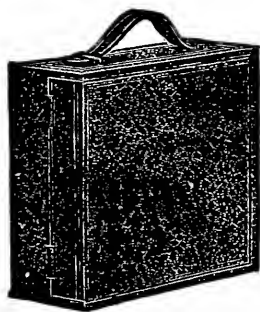

SEND FOR CATALOGUE

Manhattan Optical Co., Cresskill, N. J.

## Little Puck Camera \$2.00

Sent Prepaid on Receipt of Price

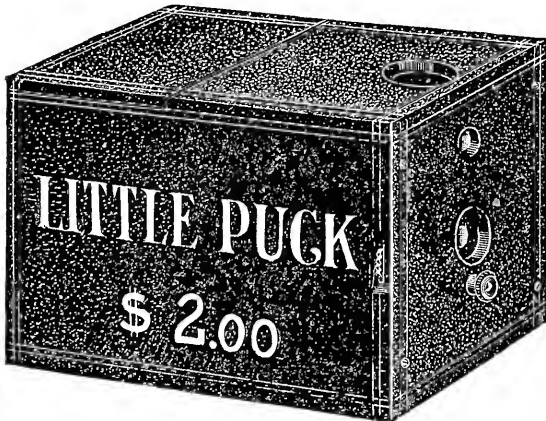

For picture 2½x2½. Capacity six pictures

The most complete camera of its size ever put on the market for the price. Adapted for time and instantaneous pictures. Compact, light, and easy to work. Camera is handsomely covered with black grained leather. Fitted with achromatic lens and safety shutter. This camera takes plates and supplies of standard size. Do not buy until you have investigated the merits of "Little Puck." Puck illustrated catalogue free. Send two 2-cent stamps for sample photograph.

**SWEET, WALLACH & CO.**

*Cameras, Kodaks, and Supplies of all Kinds*  
225 Wabash Avenue, Chicago

### THE REMEDY.

J. H. K.

If in your city life  
With its turmoil and strife,  
You like to think  
Of the river brink;  
Or of some quiet nook  
By a woodland brook,  
Where there's plenty of trout  
That are a sailing about;  
And where sometimes a deer  
Will come without fear,  
To drink in the stream  
While you idly dream;  
If the Creator above  
And nature you love  
'Twill be a vacation  
Just to read RECREATION.

I wish to thank you for the Premo B. camera, I received some time ago. It's a beauty and I am very much pleased with it.  
John C. Strubing, Elgin, Ill.

I received the 40-82 Marlin rifle you sent me, for 21 subscriptions to RECREATION, and am well pleased with it. Accept my sincere thanks.

R. Haskell, Ottawa, O.

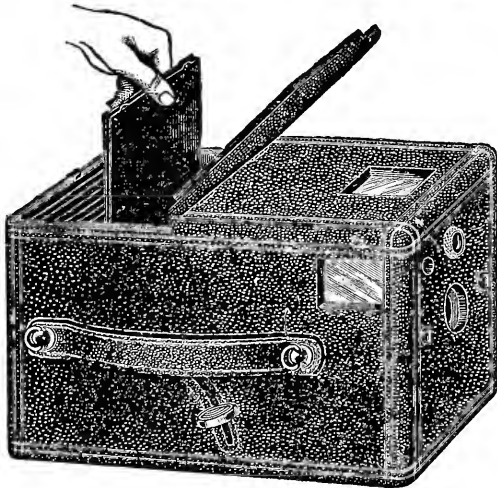

## Do you Know about The New Camera?

The first one with which Amateurs can do Professional work. Results equal the work of \$25 cameras. No failures. No mistakes, No light-struck plates. You can't help doing expert work with it.

## The Adlake Camera

COMPLETE WITH TWELVE METAL LIGHT-TIGHT PLATE HOLDERS. } \$12.00  
Prepaid to any part of the United States }

Takes 12 pictures on glass plates at one loading. Takes a standard size plate 4x5 inches and cuts a sharp, clear picture to the extreme edge. Is fitted with an expensive, extra rapid achromatic lens, specially ground.

THE Adlake Shutter has no projecting levers, nothing to break off, give out or get lost, and the diaphragm has three stops. Camera has finders for horizontal and perpendicular pictures and two tripod sockets. Handsomely covered with seal grain leather.

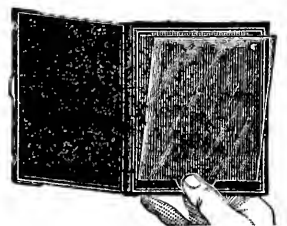

Made to open in  
**BROAD DAYLIGHT**  
For loading and adjustment. Each camera fitted with 12 single metal plate holders, light proof and dust proof. No "extras" needed. Get your plates anywhere.

Our "Adlake Camera Book" tells all about it. Free for the asking. Sample mounted photograph 5cts. in stamps.

The Adams & Westlake Company, 122 Ontario Street, Chicago.

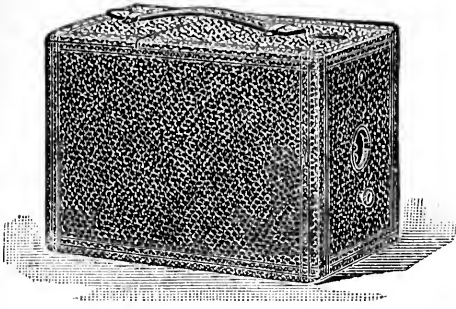

# Ray Cameras

\$2.50 Excel all Others \$5.00

We were the first and original manufacturers of a \$5.00 plate camera. Others have imitated us, and still imitate us. None excel

**10,000 Sold in One Month**

Show they have merit and why others imitate them. Before buying a Camera send for our descriptive circular and price-list. Sent free. Four cents in stamps for mounted photo made with the Ray or Ray, Jr. It costs less to make pictures with the Ray than any other camera of equal size. Complete Outfit and Instructions how to finish your own pictures for \$1.50

**MUTSCHLER, ROBERTSON & CO.**

177 MAIN STREET : : : ROCHESTER, N. Y.

Is a moonlight picture admissible to your competition? The one I send you was exposed from 7.30 p.m. to 12.15 a.m., Carbutt's eclipse film. Are the white spots stars, and what do you make of the thin, light streak over the house? Here I've been loading my plateholder by moonlight, for years, supposing it had no effect. I don't for a moment suppose we could take a prize, with our one horse outfit. Have not even a graduate glass; have to guess at everything; but if moonlight goes we'll fix one up as a sample. We can find another to go with it. What a great variety of photos you must get, in this competition!

James Fullerton, Ten Sleep, Wyo.

Answer: Your moonlight photos at hand. They are exceedingly interesting, but even the best one is scarcely strong enough to reproduce properly. It is hard to explain what a photograph must be, in order to reproduce by the half tone process, but it must be sharp, clear, deep and brilliant. It takes a fine lens—one costing \$25 or more—to make a picture that will give creditable results in this way. Therefore, these pictures would stand no show of winning a prize in my competition.

Your largest picture is remarkably good, considering the conditions, and your history of it is deeply interesting. The white

streak you refer to, over the house, is the track of a star that moved that distance during the time of exposure.

You have certainly injured your plates in loading by moonlight. I have loaded many plates in camp, at night, but always, if the moon shone, or if there was even starlight, I spread a blanket, or a piece of canvas, over me and over the plates, while so engaged. You can change plates on a dark, cloudy night, if entirely away from the camp fire, or other artificial light, without thus covering yourself and without danger of fogging your plates.

The white spots you refer to, in the sky, are not pictures of stars. They are simply defects in the negative, or results of improper treatment in developing, toning or fixing. The star that made the track is the only one that appeared within the scope of your lens, at that time, which was bright enough to show in the picture. If others had shown they would have left merely white streaks across the plate, as this one did.

Yes, I have many hundreds of photos on hand, many of which are not good enough to reproduce. They are nearly all useful to my artists, in making drawings, and I am always glad to have pictures, of almost anything out of doors.

EDITOR.

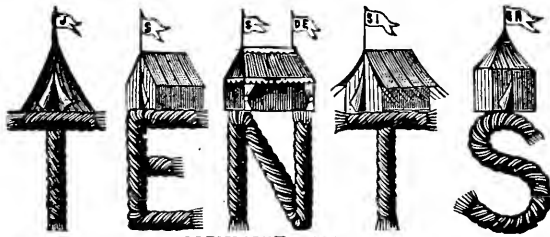

# AND CAMP OUTFITS

We manufacture the largest and most complete line of tents in the country, and our goods are celebrated for their wearing and waterproof qualities.

Send 4 cents in stamps for our new 40-page illustrated catalogue showing all styles of Tents and Camp furniture.

**GEO. B. CARPENTER & CO.**

202 to 210 S. Water Street, CHICAGO

Established 1840.

JUST THE THING...

For Yachts and Country Homes

## THE STELLA



Our new Music Box, playing any number of tunes on tune sheets, without pins or projections of any kind; surpasses all others in quality of tone and in durability; it occupies little space and compares favorably in tone with the piano. Call and see it, or send for catalogue and list of tunes to

JACOT & SON, 39 Union Square, New York

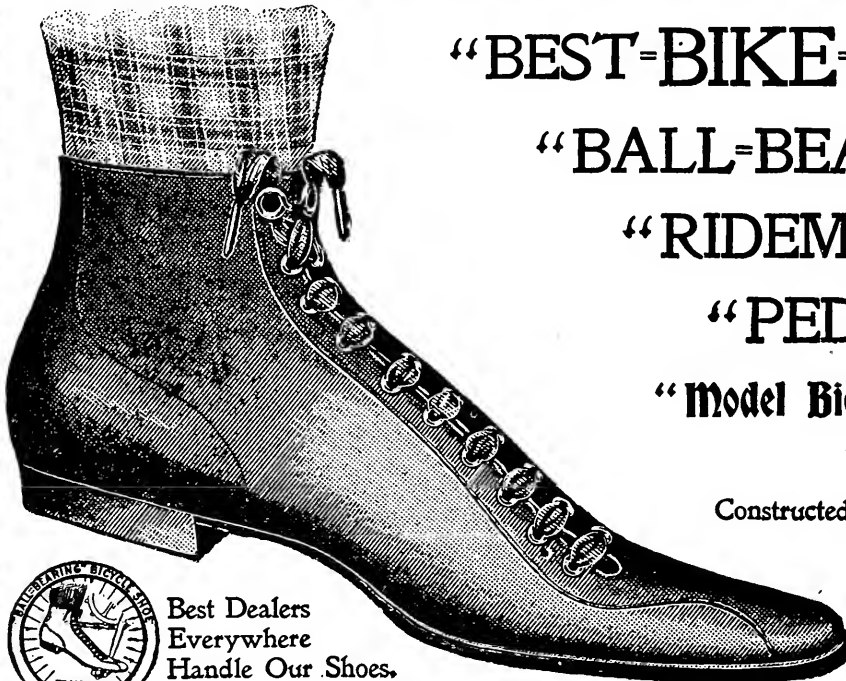

“BEST-BIKE-SHOES,”

“BALL-BEARING,”

“RIDEMPHAST,”

“PEDALSHOE,”

“Model Bicycle Shoes  
of the World.”

Constructed on scientific principles.

EASY TO RIDE IN—

EASY TO WALK IN.



Best Dealers  
Everywhere  
Handle Our Shoes.

...Pratt Fasteners Hold Laces...

**THE “B-B” SHOE MFG. CO.,**

-121 Duane Street,

- - - - - New York.



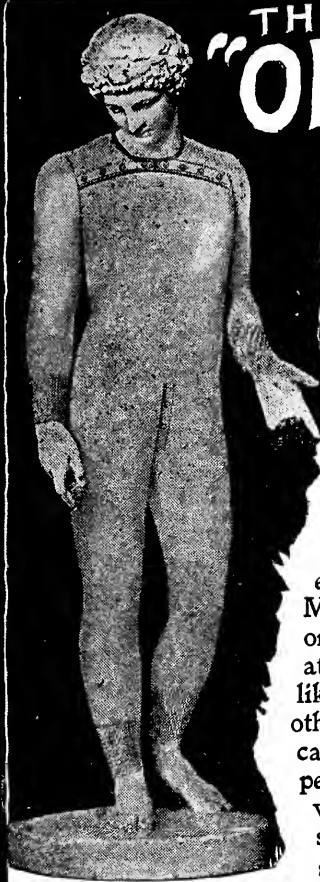

**THE "ONEITA"**  
PAT. APL 25<sup>TH</sup> 1893.

**Elastic Ribbed Union Suits**

are complete undergarments, covering the entire body like an additional skin. Perfectly elastic, fitting like a glove, but softly and without pressure. No buttons down the front. Made for Men, Women, and Young People. Most convenient to put on or off, being entered at top and drawn on like trousers. With no other kind of underwear can ladies obtain such perfect fit, for dresses, or wear comfortably so small a corset.

Send for illustrated booklet

**ONEITA KNITTING MILLS** Office: 1 Greene St.  
New York

## Hose to Wear

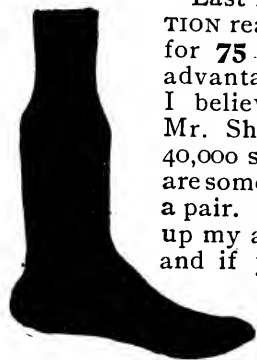

Last month I offered RECREATION readers a **\$1.00** Golf Hose for **75 cents** and several took advantage of my offer. They, I believe, will remember me. Mr. Shields tells me he has 40,000 subscribers. Then there are some of these who did not buy a pair. To these let me say, look up my ad. in June RECREATION, and if you wear bicycle hose, buy a pair of **No. 11.**

I have another offer to make to readers of RECREATION. Send me **\$1.00**, and I will send you **8** pairs of socks, easily worth **20 cents** a pair, black, tan, blue, or mixed colors, summer weight. If you don't want to risk \$1.00, send me **50 cents** for **4** pairs or **25 cents** for **2** pairs. I have ladies' hose too, **25 cents** a pair, good enough for anyone. In fact, I sell everything in hosiery. If I fool you once, I can't do it twice. Give me an order, and, if what I send you is not worth your money, send back the goods and you will get your money back.

**GEO. F. WEBBER** Dealer in all kinds  
DETROIT, MICH. of Hosiery

### GLAMOUR.

E. C.

Was it the fountain's rippling flow—  
The soft waves murmuring free—  
Or Daphne's voice—so sweet and low—  
Sang melody to me?

Was it the moon's clear, silvery ray  
That moved my heart to sighs—  
That witched the happy hours away—  
Or—Daphne's tender eyes?

### A JUVENILE PARADISE.

"I wisht'at I lived over at Junny Jinkses house."

"Why—Dicky?"

"Cos—he has more better times 'n I do; his sister's hump-backed, 'n' his paw's got a glass eye, 'n' his maw's allus in bed 'th th' roomatiz."

Mary, Mary,  
Quite contrary,  
How does your cycle go?  
It's not to my mind,  
For the trouble I find,  
Is to keep both the wheels in a row.  
—Exchange.

### THE WAY TO ARRIVE.

The speed by wheelmen reached and kept  
Was not attained by sudden flight;  
But they, while kind policemen slept,  
Went scorching onward—out of sight.

### SUMMER JOY.

"What is your idea of perfect bliss, Miss Leggins?"

"Well—a tandem and a long cycle path, with an ice-cream saloon at each end."

"Chicago is a pretty wild old town, isn't it?"

"Yep—pretty near as wild as Coney Island."

"Papa won't let me marry Harvey, he has bad habits."

"Why—did he catch him coming out of a saloon?"

"No; he saw him scorching."

Turn to my premium list, on page xlviiii of this issue of RECREATION, and see the tempting array of articles that can be had for merely a few hours' work.

Please send me the names and addresses of all your friends who are sportsmen, in order that I may send them sample copies.

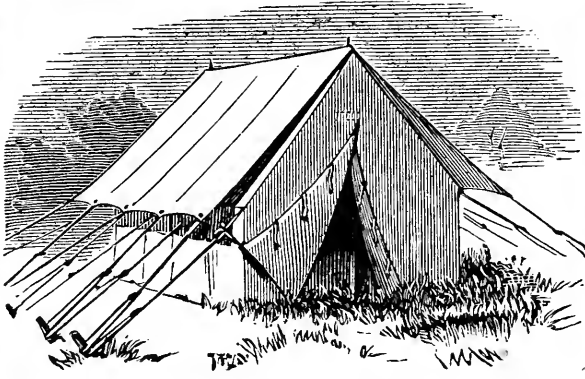

Every  
Sportsman  
Should  
Have a

# WATER-PROOF TENT

A camper knows the advantages of a tent that is an absolute protection against rain and dampness. We secure this advantage by **OUR** water-proof **PROCESS** and avoid the extra bulk and weight of a fly.

We make tents of all sizes, shapes and materials, suited to the needs of hunters, campers, travellers, canoeists; also

## Water-Proof Sleeping Bags

**CANVAS BUCKETS, AMMUNITION, PROVISION,  
CLOTHING AND SADDLE BAGS, POUCHES,  
PACKS, BICYCLE COVERS, FLOOR CLOTHS,  
and many other Canvas Specialties**

**Our Sleeping Bag** is unique, excellent in pattern and finish, and has been highly approved.

SEND FOR CIRCULAR R, SAMPLES OF MATERIALS AND PRICE-LIST TO

# DERBY, ABERCROMBIE & CO.

36 South Street, New York

The Only Practical  
**Camping Bag**

IS THE . . .

# Kenwood



Enthusiastically endorsed by campers everywhere—not an experiment. Now made with improvements suggested by usage under all conditions—as, for instance, the outside waterproof canvas cover, the middle bag and the soft, warm, light inner bag—to be used separately or combined, thus giving perfect protection from cold, rain or sudden climatic changes. Strong, durable and useful, as a hold all.

A perfect  
shelter.  
Tents  
unnecessary.

No stiffened muscles. No uncovering.  
The Prices

**\$6.00 to \$16.00**

are a revelation to buyers of the old, heavy and unsatisfactory square blankets.



## The Kenwood Hunting Cape

meets every requirement of the sportsman "waiting for a shot," whether at a deer, ducks or pigeons. Better than coats. Carefully made to combine all desirable features. Excellent as a Driving Cape.

Price  
**\$15.00**

## The Kenwood Storm Hood

for use with the Bags, or for anyone exposed to severe weather, will be found very serviceable and a comfort in cold or windy weather.

*Every Camper, Hunter, Angler, Prospector or Military Man should send for our FREE illustrated circular, about these goods and camping information*

**THE KENWOOD MILLS, Albany, N. Y.**

(N. Y., 3318. Ed. 3—25,000.)

# MEMORANDUM OF WEIGHT.

DATE OF MAILING.

| DAY.         | A. M.     | P. M.        |
|--------------|-----------|--------------|
| <i>Apr 2</i> |           | <i>5 30</i>  |
|              | <i>to</i> |              |
| <i>" 30</i>  |           | <i>10 25</i> |

ORIGINAL.

New York Post Office,  
*5-4<sup>th</sup>* 189*.7*

Received from

*Recreation*

IN WEIGHT, AS FOLLOWS:

|                               | TARE. | GROSS WEIGHT.    |
|-------------------------------|-------|------------------|
| <i>244</i> No. 1 Sack, 3 lbs. |       | <i>13554</i>     |
| No. 2 Sack                    |       | <i>732</i>       |
| Net weight,                   |       | <i>12822</i>     |
| Rate per pound,               |       | <i>.01</i>       |
| Amount of postage,            |       | <i>\$ 128.22</i> |

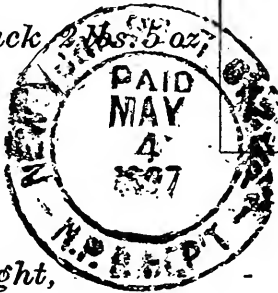

Per *A. M. Lamb* Postmaster.  
 Receiving Clerk.

NOTE.—It is important that this receipt be compared with its duplicate, signed by the Postmaster, and issued at the close of each month.

Post-office receipt for May number of RECREATION. Other receipts cheerfully shown on application.

A copy of RECREATION weighs  $\frac{1}{2}$  lb. and the postage is 1 cent a pound. This means a subscription list of 25,600 copies a month. Figure it and see. Then call for further proof.

Address RECREATION, 19 West 24th Street, New York

(N. Y., 3316. Ed. 5—25,000.)

MEMORANDUM OF WEIGHT.

DATE OF MAILING.

| DAY.   | A. M. | P. M. |
|--------|-------|-------|
| May 25 |       |       |
| to     |       |       |
| June 2 |       |       |

New York Post Office,

6-2-1897

Received from

*Recreation*

IN WEIGHT, AS FOLLOWS:

|                          | TARE. | GROSS WEIGHT. |
|--------------------------|-------|---------------|
| 185 No. 1 Sack, 3 lbs.   |       | 16718         |
| No. 2 Sack, 2 lbs. 5 oz. |       | 555           |
| Net Weight, - -          |       | 16163         |
|                          |       | .01           |
| Rate per pound, - -      |       | 161.63        |
| Amount of postage, -     |       | \$161.63      |

Per *AML* Postmaster.  
Receiving Clerk.

2-1-96

Post-office receipt for June number of RECREATION. The postmaster does not stuff the returns for any publisher.

This is for subscriptions only. The News Co.'s trade of 11,000 a month is not included. Total circulation, 40,000 a month.

If interested call for further proof.

Address RECREATION, 19 West 24th Street, New York

**For Sale:** Good furniture and undertaking business in Goldendale, Klickitat County, Wash. County Seat, good farming and stock country, located at foot of Cascade mountains; 4 snow peaks—Hood, St. Helens, Adams and Tacoma—in sight. Fine trout fishing in stream running through the town. Grouse, ruffed, sharp-tail, sage, and mountain; black bear, mule deer and goats within 50 miles. An ideal location for a sportsman.

Good schools, churches, and local option law. Owner has an interest in, and is manager of a large wholesale and retail general merchandise store, that takes all his time. Buyer would find a choice circle of congenial spirits, and though in a healthy climate, there is but one other undertaker in the county, 120 miles long by 25 to 35 miles wide. Purchaser would have the assistance of 6 doctors, all sportsmen and jolly good fellows.

O. D. Sturgiss, Arlington, Oregon.

**For Sale:** Remington Hammerless Automatic Ejector, 12 gauge, 7½ pounds, 30 inch barrels; stock 14½ x 2½ drop. Good as new. Perfect inside and out.

Elmer Breckinridge, Ashtabula, O.

## L. L. BALES

...Wholesale and Retail Dealer in...

### FISH, FURS, AND RAW SKINS

Full information given brother sportsmen as to good hunting, trapping, and fishing grounds in Washington, British Columbia, and Alaska.

Am well acquainted with the haunts of the elk, deer, bear, mountain sheep, mountain goat, moose, and caribou; also with the whereabouts of all fur-bearing animals in this region.

*Correspondence promptly  
and cheerfully answered*

Everett, Wash.

The 38-55 Marlin, which you so kindly sent me, was received in good shape and it is a beauty.

L. C. Danner, Wormleysburg, Pa.

The Marlin rifle came O.K., and I am greatly pleased with it. I think there is nothing living that the gun will not kill.

Ralph Bateman, Fort Sherman, Idaho.

Many thanks for the beautiful Marlin rifle I received for getting up a club. To say that I am pleased is putting it mildly.

Wm. H. Foss, Lynn, Mass.

The Marlin rifle, which I earned from you, is a fine one and I am well pleased with it.

Don M. Harris, Zanesville, O.

I have received the Premo B., which you sent me as premium, and it is grand.

Albert B. Bauman, Chicago, Ill.

### A GOOD ONE ON ED.

The following story was told me while on a camping expedition in Northern Wisconsin, last summer. I have never seen it published and it may be new:

Two young men, while sailing on one of the Northern lakes, were struck by a sudden squall, which capsized their boat. John was a strong, sturdy youth, while Ed. was weak and delicate. Both held on to the boat for some time, struggling to keep their heads above water, but Edward's strength was gradually waning; and with one more grasp at the floating boat he told John he could not possibly hold on any longer. John reassured and encouraged him, but despite all efforts he saw his friend was gradually growing weaker.

"Just another minute, Ed., and help will come."

"No," replied Edward, "and now that my time has come—I am not afraid to go—only the thought of my dear mother—and that dear girl—whom I've loved—so dearly—for so long—the thought of leaving them almost crushes me. Take this message to them John: Tell them I—died with a strong heart—and left messages—of love—and affection—for them."

John—with a heavy heart—promised all; but importuned the poor boy to summon strength for a short time anyway. Edward's strength was now but a memory and with one hastily uttered prayer—and breathing the name of his beloved—his hands loosened; his face paled, and he sank in 4 feet of water!

## Some Rare Opportunities

...YOU CAN GET...

A \$75 Bicycle for 75 yearly subscriptions to *Recreation*.

A \$35 Hammerless Breech-Loading Shot Gun for 35 yearly subscriptions.

A \$40 Camera for 25 subscriptions.

A \$20 Gold Watch for 20 subscriptions.

A \$20 Repeating Rifle for 20 subscriptions.

A Good Single Barrel Shot Gun for 15 subscriptions.

A Single Shot Rifle, or

A Bristol Steel Fishing Rod, or

An Automatic Reel, or

A Kenwood Sleeping Bag  
For 10 subscriptions.

WHY DON'T YOU GET THEM?

Write for premium list and sample  
copies of *RECREATION*

**To Sportsmen and Tourists:** I am located in Northwestern Colorado, in a paradise for sportsmen. Large game abundant and trout fishing unexcelled. Gentle saddle horses, pack outfits, etc. Everything first class. Correspondence solicited.

J. M. Campbell, Hunter and Guide,  
Buford, Colorado.

**For Sale or Exchange.**—Folding canvas boat, new in 1896 and used but once. Will trade for bicycle, 12 gauge gun or 22 calibre rifle.

C. H. Tolman,  
85 Exchange St., Portland, Me.

### WHERE TO GET BIG GAME.

Have you located your happy hunting ground for next fall? If not, I will agree to take you to moose, elk, deer, bear, plenty of mountain goats, fish and grouse galore, providing you wish my services as guide. Only 40 miles from the R. R. to the hunting grounds. Good pack outfits, tents, etc. Horses good and gentle. Terms reasonable. Best of references; 18 years' experience as guide.

Vic Smith, Anaconda, Mont.

**For Exchange.**—A 30-30, '94 model Winchester, pistol-grip stock, set trigger, Lyman rear and front sights, with reloading tools for soft bullets. I wish to exchange same for a Marlin rifle with pistol grip, fancy walnut stock, or a Union Hill Ballard, with set triggers.

E. R. Rives, Micanopy, Fla.

**Jas. L. McLaughlin:**—Experienced Guide. Best references furnished. Elk, moose, deer, mountain sheep, antelope, lions, bear, sage hens and grouse. Best trout fishing in the country, within 10 minutes' walk of my ranch. Would take a few boarders. Tourist outfits furnished on short notice. Address,

Ishawood, Big Horn Co., Wyoming.

### ANY PARTY

wanting to see the  
**National Park,**  
or to hunt in the  
Teton or Jackson's Hole countries,  
should write me.

These are the best big game ranges in the United States. Moose, elk, deer, bear, mountain sheep, mountain lions, and all kinds of small game abundant; also the best of trout fishing in the West.

Have put in 16 years hunting, trapping, and guiding in Wyoming, Idaho, and Montana, and know where to go for any kind of game you want. Write me and I will give you full particulars.

GEORGE WINEGAR, St. Anthony, Fremont Co., Idaho.

**For Sale:** A new Ideal Loading Machine, price \$5; 3 Hills Patent Releasing Sparrow Traps, \$5. Will take \$10 cash for the 4 articles, or will trade anything useful, for an equal amount.

George Burkhardt, 14 Baitz Ave., Buffalo, N. Y.

I have a female cocker spaniel 3 months old, weight 16 pounds, jet black, with a small bunch of pure white on breast. Not broken but will make an excellent retriever. Would sell cheap or trade for anything desirable.

C. R. Wagner.

**Who wants a Florida home?** 11½ acres of good land; good house, stable, air, water, and healthy country. Fruit—oranges, lemons and grapes. Game, such as deer, turkeys, quail, rabbits, snipe, woodcock, etc. Price \$1,000. Terms easy.

L. Allen, Oak Hill, Fla.

## KAREZZA ETHICS OF MARRIAGE.

A bold, brave book teaching ideal marriage, rights of the unborn child, a designed and controlled maternity.

**Union Signal:** Thousands of women have blessed Dr. Stockham for Tokology, thousands of men and women will bless her for Karezza.

**Arena:** Karezza is worth its weight in gold.

Sample pages free. Agents Wanted. Prepaid \$1.00.  
ALICE B. STOCKHAM & CO., 277 MADISON ST., CHICAGO.

**For Sale:** Two large Moose heads, with horns, mounted in first-class style. Spread of horns, 50 and 51 inches. Horns uniform and perfect. A snap for someone. For particulars and price, write

R. STRUTT, Pembroke, Ont., Canada.

**Information** about Hotels, Camps, Summer Resorts, Farm Board, Outfit for Fishing and Hunting, and Guides to Maine woods and waters. Reliable. Free.

Maine Information Bureau,  
Phillips, Maine.



### File Your Business

papers, accurately and systematically by using the

**Globe Filing Cabinet.**

Illustrated Catalogue—free.

**The Globe Co., Cincinnati,**

Cor. Fulton & Pearl Sts., N. Y., 111 Madison St., Chicago.

## Blair's Pills

Great English Remedy for

**GOUT and RHEUMATISM.**

SAFE, SURE, EFFECTIVE.

Druggists, or 224 William St., New York.



A certain Cincinnati doctor returned from an unsuccessful snipe hunt, remarking to his wife, "I couldn't kill a thing to-day."

"If you had stayed at home," was the unsympathetic reply, "and attended to your regular business, you might."

# THE AMERICAN BOOK OF THE DOG

THE ORIGIN, DEVELOPMENT, SPECIAL CHARACTERISTICS,  
UTILITY, BREEDING, TRAINING, DISEASES, AND KENNEL  
MANAGEMENT OF ALL IMPORTANT BREEDS OF DOGS

*A Book for Dog Fanciers and Dog Owners*

EDITED BY G. O. SHIELDS ("COQUINA")

AUTHOR OF "CRUISING IN THE CASCADES," "RUSTLINGS IN THE ROCKIES," "HUNTING IN THE GREAT WEST," "THE BATTLE OF THE BIG HOLE," "THE BIG GAME OF NORTH AMERICA," "CAMPING AND CAMP OUTFITS," ETC.

8vo, 700 Pages, 85 Illustrations. Cloth, \$5.00; Half Morocco, gilt top, \$6.50; Full Morocco, gilt edges, \$8.00

## CONTENTS

- |                                                                                                                                          |                                                                                                                                       |
|------------------------------------------------------------------------------------------------------------------------------------------|---------------------------------------------------------------------------------------------------------------------------------------|
| The English Setter. Bernard Waters, Kennel Editor                                                                                        | The Yorkshire Terrier. P. H. Coombs.                                                                                                  |
| The American Field, and author of "Modern Training, Handling, and Kennel Management."                                                    | The Chesapeake Bay Dog. George W. Kierstead.                                                                                          |
| The Irish Setter. Max Wenzel, Secretary The Irish Setter Club of America, and B. F. Seitner, Vice-President The Pointer Club of America. | The Bedlington Terrier. W. H. Russell.                                                                                                |
| The Gordon Setter. Harry Malcolm, President The American Gordon Setter Club.                                                             | The Irish Terrier. Dr. J. S. Niven.                                                                                                   |
| The Pointer. Charles K. Westbrook, A. M.                                                                                                 | The Bull Terrier. Frank F. Dole.                                                                                                      |
| The Greyhound. Col. Roger D. Williams, President The Iroquois Hunting and Riding Club.                                                   | The White English Terrier. E. F. Burns.                                                                                               |
| The Deerhound. Dr. Q. Van Hummell.                                                                                                       | The Airedale Terrier. F. H. F. Mercer.                                                                                                |
| The Foxhound. Dr. M. G. Ellzey, Associate Editor The National Economist.                                                                 | The Scottish Terrier. John H. Naylor.                                                                                                 |
| The Bassethound. Lawrence Timpson.                                                                                                       | The Dandie Dinmont Terrier. John H. Naylor.                                                                                           |
| The Dachshund. William Loeffler.                                                                                                         | The Skye Terrier. Lawrence Timpson.                                                                                                   |
| The Bloodhound. J. L. Winchell.                                                                                                          | The Black and Tan Terrier. Dr. H. T. Foote.                                                                                           |
| The Russian Wolfhound. William Wade.                                                                                                     | The Maltese Terrier. Miss A. H. Whitney.                                                                                              |
| The Beagle. H. F. Schellhass, President The American-English Beagle Club.                                                                | The Collie. Henry Jarrett and J. E. Dougherty.                                                                                        |
| The Irish Water Spaniel. P. T. Madison, Secretary The Indiana Kennel Club.                                                               | The Old English Sheep Dog. William Wade.                                                                                              |
| The English Water Spaniel. William A. Bruette.                                                                                           | The Great Dane (German Dogge). Prof. J. H. H. Maenner.                                                                                |
| The Clumber Spaniel. F. H. F. Mercer, Kennel Editor Sports Afield.                                                                       | The St. Bernard. F. E. Lamb.                                                                                                          |
| The Sussex Spaniel. A. Clinton Wilmerding, President The American Spaniel Club.                                                          | The Mastiff. William Wade.                                                                                                            |
| The Field Spaniel. J. F. Kirk.                                                                                                           | The Newfoundland. L. F. Whitman.                                                                                                      |
| The Cocker Spaniel. J. Otis Fellows.                                                                                                     | The Bulldog. John E. Thayer.                                                                                                          |
| The Fox Terrier. August Belmont, Jr., President The American Kennel Club, and The American Fox Terrier Club.                             | The Dalmatian Coach Dog. Maj. T. J. Woodcock.                                                                                         |
|                                                                                                                                          | The Poodle. W. R. Furness.                                                                                                            |
|                                                                                                                                          | The Italian Greyhound. Dr. G. Irwin Royce.                                                                                            |
|                                                                                                                                          | The Pug. G. W. Fisher.                                                                                                                |
|                                                                                                                                          | The Mexican Hairless Dog. Mrs. Elroy Foote.                                                                                           |
|                                                                                                                                          | The Toy Spaniels. Miss Marion E. Bannister, Secretary The New York Pet Dog Club.                                                      |
|                                                                                                                                          | The Schipperke. E. R. Spalding.                                                                                                       |
|                                                                                                                                          | Diseases of the Dog, and their Remedies. Dr. J. Frank Perry ("Ashmont"), author of "Dogs; Their Management and Treatment in Disease." |
|                                                                                                                                          | Spaniel Training. F. H. F. Mercer.                                                                                                    |

The Hon. John S. Wise, the eminent statesman and lawyer, President of the Pointer Club of America, and one of the most distinguished sportsmen and dog fanciers in the country, says of this book:

"In selecting contributors to this work Mr. Shields has displayed rare good judgment. His list of writers embraces the names of many gentlemen who are recognized as leading authorities on the subjects of which they write. While those articles may, in some cases, be more or less tinged by the peculiar views of their authors, the book, thus drawn from many different minds, is not only very eclectic in character, but, in my judgment, much more correct and valuable, as a whole, than it could be were it the production of an individual.

"The book is exceedingly interesting. It is free, too, from the sameness of expression and treatment so often found in books of this character, written by one man. It is, moreover, a very instructive book, and of practical value, in many features, to the owners and breeders of dogs.

"A valuable feature of this book is the illustrations. Many of these are artistic and beautiful in a high degree. The portraits of several dogs of world wide reputation are shown, and those of many other typical specimens, less widely known, add to the interest and attractiveness of the work. Nearly every breed is illustrated, and of some breeds several good specimens are pictured."

This book will be mailed, post-paid, on receipt of price, by

G. O. SHIELDS, 19 West 24th Street, New York

Or given as a Premium for 7 Subscriptions to Recreation



## You Get the Profits

Of Dealers, Agents, Jobbers  
and Middlemen by buying di-  
rect from the manufacturer.

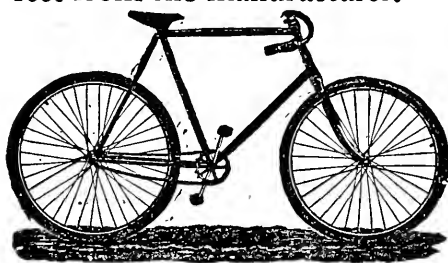

No better wheel made than the

## Acme Bicycle

Built in our own factory by  
skilled workmen, using the best  
material and the most improved  
machinery. *We have no agents*  
Sold direct from factory to the  
rider, fully warranted. Shipped  
anywhere for examination.

WRITE FOR

## Our Interesting Offer

Acme Cycle Co., Elkhart, Ind.

# Tribune Bicycles

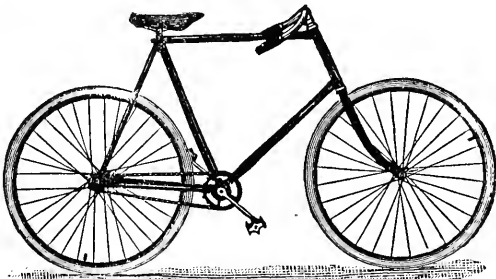

The Best in the World

Send for Catalogue

**THE BLACK MFG. CO.**  
ERIE, PA.

Mention RECREATION.

## 1897 High Grade Bicycles

for Men, Women, Girls & Boys. Complete line at lowest prices ever quoted.  
 \$100 'Oakwood' for \$45.00  
 \$85 'Arlington' " \$37.50  
 \$55 " " \$25.00  
 \$20 Bicycle " \$10.75  
 \$75 'Maywood' Simplest, Strongest Bicycle on Earth " \$32.00  
 Fully guaranteed. Shipped anywhere C.O.D. with privilege to examine. No money in advance. Buy direct from manufacturers, save agents and dealers profits. Large illustrated catalogue free. Address (in full).  
**Cash Buyers' Union, 162 W. Van Buren St. B 359 Chicago**

## 600 Second Hand BICYCLES

to close out. All makes, 600  
 AS NEW, \$5 to \$15. NEW,  
**HIGH GRADE '96 Models,**  
 fully guaranteed, \$16 to \$24.  
 '97 Models \$20 to \$30. Shipped  
 anywhere on approval.  
**Special Clearing Sale.**  
**EARN A BICYCLE**  
 by helping advertise us. We  
 will give one agent in each town FREE  
 USE of sample wheel to introduce them.  
 Write at once for our Special Offer.  
**D. P. MEAD & PRENTISS, CHICAGO, ILL.**



### WHO KILLED THE BUFFALO?

Jackson, Wyo.

Editor RECREATION: B. V. K. wrote that in 1891 the hide of a buffalo was brought into Jackson's Hole, which was killed on Crawford creek. The facts about that buffalo hide are these:

In the fall of 1891, Captain Anderson caused notices to be posted on trees, along the trail near Sargeant's ranch, at the head of Jackson's lake, stating the Park rules would be enforced in the timber reservation. That same fall 5 men built a cabin on the South side of Warm Spring creek, a few hundred yards below the trail, and wintered there; or at least while they were not camping in the Park. This cabin is about 8 miles inside the timber reserve, and about 3/8 of a mile from the Government station on Snake river. Is it possible Captain Anderson did not know they were there?

None of these men were residents of Jackson's Hole. The truth is the men killed 3 buffalo on Crawford creek, or near it. One of them was brought to the Hole and finally sold to a man in Rexburg, Idaho. The other 2 I suppose were taken out through the Park; one shipped to Prouty, in New York; the other sold in Montana.

The buffalo in the Park are practically gone. The real cause is that the syndicate and the soldiers have cut the winter feed of the buffalo and put it up for hay. The people of Jackson's Hole are unanimous in wishing the game protected, in the Park and in the timber reservation, as well as in Wyoming.

We estimate 28,000 elk wintered in Jackson's Hole; an increase of 5,000, due to partly restraining the Indians for 2 years. It cost us nearly a whole season's time, and got the army officers and a lot of Eastern people down on us. They ought to get the truth of both sides of the question before judging.  
 S. N. Leek.



**FOWLER CYCLE MFG. CO.**  
 CHICAGO,  
 NEW YORK, BOSTON, PROVIDENCE, LONDON.  
 DROP US A POSTAL FOR A '97 CATALOGUE

# Camping and Camp Outfits

A MANUAL OF INSTRUCTION FOR YOUNG  
AND OLD SPORTSMEN.

Edited by G. O. SHIELDS ("COQUINA")

Author of "CRUISING IN THE CASCADES," "RUSTLINGS IN THE ROCKIES," "HUNTING IN THE GREAT WEST," "THE BATTLE OF THE BIG HOLE," "THE BIG GAME OF NORTH AMERICA," "THE AMERICAN BOOK OF THE DOG," "AMERICAN GAME FISHES," ETC.

---

12mo. 200 Pages. 30 Illustrations. Cloth, \$1.25.

---

**T**HIS book contains practical points on how to dress for Hunting, Fishing, or other Camping Trips; what to carry in the way of extra Clothing, Bedding, Provisions, Cooking Utensils, and all classes of Camp Equipage; how to select Camp Sites; how to make Camp Fires; how to build Temporary Shelters; what to do in case of Getting Lost, etc. It contains check lists of articles constituting Complete Camping Outfits; a list of the names and addresses of Guides, in various hunting and fishing countries, and much other information of value to Campers, and which has never before been given to the public.

The instructions given are based on an experience of twenty-five years in Camping, and in the study of Camp Lore, Woodcraft, etc., and it is believed that the work will prove of great value to thousands of men and boys, who have not had such favorable opportunities for study.

The book also contains a Chapter by

**DR. CHARLES GILBERT DAVIS, on CAMP HYGIENE, MEDICINE AND SURGERY**

ONE BY

**COL. J. FRY LAWRENCE, on CAMP COOKERY,**

AND ONE BY

**FRANK F. FRISBIE on THE DIAMOND HITCH, or HOW TO LOAD A PACK HORSE**

---

This book should be in the library of every Sportsman, and will be sent, post-paid, on receipt of price, by the Author,

*G. O. Shields, 19 W. 24th St., New York.*

---

*Given as a Premium for Four Subscriptions to Recreation*



W. S. WATSON.

He: Why does Miss Ann Teek wear her bicycle gown all the time?

Miss Young: So people will call her a new woman, instead of an old one.

#### TREED IN THE LAKE.

Uncle Hi is always a ready listener to our hunting stories. He was a great sportsman in his day; nor has he forgotten how to swing a rifle and shot gun. The last shooting I saw him do was knocking the stems off pumpkins, at 75 yards, with a rifle; and shooting kingbirds from his beehives.

Last fall, when I returned from a trip in the Adirondacks, at Plumadore pond, I told him about watching for deer, at the East shore, behind some rocks.

"That is where I saw a wildcat, about 20 years ago," he said. Uncle Hi had been watching the pond, for deer to take to the water when they should be pressed by the hounds. Hearing a noise behind him, he had turned.

"I saw the biggest wildcat," he said, "man ever saw, not 4 rods away, standing

with his fore feet on a log, looking at me. It seemed as if he was about three-quarters eyes. While I looked, the brute mounted the log. Then my hair began to come up. I had only a single barreled rifle, and not being well acquainted with wildcats, I was afraid if I didn't kill him instantly I might stand a chance of getting my coat torn.

"Much as I wished to get his hide, I determined if that cat would let me alone, I would him. Knowing cats have an aversion to getting their feet wet, I backed around the rocks, with the water up to my waist, keeping my eyes on the cat, and waded half an hour before I dared approach the shore. When out of sight of the animal I worked my way to the bank, and ran for camp.

"I didn't tell the boys how I got wet; thought it wasn't necessary for them to know everything."

M. P. E., Clarenceville, P. Q.

# Williams' Shaving Soap.



Off upon an outing,  
 Time you wish to save,  
 Then, without alighting,  
 You can have a shave;  
 Though it looks so risky,  
 You have learned, we hope,  
 You can always safely,  
 Shave with Williams' Soap.

Rich and creamy lather,  
 And it never dries,  
 Though through wind and sunshine,  
 Fast the rider flies;  
 Travel with this treasure,  
 And you'll learn to like,  
 An unusual pleasure,  
 "Shaving on a bike."

### THE STRONG POINTS

of Williams' Shaving Soaps—the points in which for half a century they have excelled all others, are . . . . .  
 Never-drying Qualities—  
 Big Thick Creamy Lather—  
 Peculiar Softening Action upon the Beard—  
 Soothing-Healing-Refreshing effect upon the Face—  
 Absolute Purity and Safety.

"SHAVING ON A BIKE."

**WILLIAMS' SHAVING SOAPS**—in forms best adapted to different tastes and uses. Sold everywhere. Sent by mail on receipt of price, if your dealer does not supply you.



**Williams' Shaving Stick. 25c**

Especially adapted for the use of wheelmen, yachtsmen, and all tourists.  
 Strong, compact, handsome metal-lined case.



**"Genuine Yankee" Soap, 10 cents.**

Oldest and most famous cake of shaving soap in the world.



**Williams' Luxury Tablet 25c.**

Round—"just fits the cup"  
 Perfume refreshing and delicate. The very height of luxury.

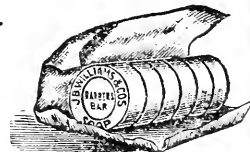

**Williams' Shaving Soap. (Barbers')**



This is the kind your barber should use.  
 Exquisite also for Toilet and Bath used in thousands of the best families.  
 Sure cure for "chapped hands." 6 cakes in a package—40 cents.  
 Trial sample for a 2 cent stamp.

**The J. B. Williams Co., Glastonbury Ct., U. S. A.**  
 LONDON: 64 Great Russell St., N. W. SYDNEY: 161 Clarence St.

**Williams' Exquisite "Jersey Cream" Toilet Soap, 15 cents.**

Long Branch and Back, 50cts.  
Asbury Park and Back, 80cts.



  
**“Mary Patten”**  
**“Elberon”**  

  
**“Pleasure Bay”**

Steamers

....FOR....

Highland Beach, Seabright, Pleasure Bay, Long Branch, Asbury Park and Ocean Grove

“Down the Bay”

“Thro’ the Narrows”

“Up the Picturesque Shrewsbury”

ONLY Boats to Highland Beach

ONLY Boats to New Pleasure Bay Park

ONLY Boats Connecting with Trolley to Asbury Park and Ocean Grove

Baggage Free. For time table see daily papers

## Amateur Photographers

WILL FIND THAT THE

**WEST-SHORE  
RAILROAD**

PRESENTS most delightful and varied Scenery for PHOTOGRAPHING AND SKETCHING. Its Mountains, Woodlands, Streams, Lakes, and Valleys, provide subjects for an

Infinite Variety of Pictorial Gems . . . .

THE HUDSON RIVER

THE CATSKILL MOUNTAINS

THE MOHAWK VALLEY

THE NIAGARA FALLS

All contribute to make this the most desirable route for persons of artistic temperament.

Five elegant Fast Trains with through Sleeping Cars to Kingston, Albany, Utica, Syracuse, Rochester, Niagara Falls, Toronto, Cleveland, Detroit, Chicago, and St. Louis.

**DIRECT ROUTE** to the Adirondacks, making close connections with railways, steamers, and stages for all the choice hunting and fishing grounds of that delightful region.

FOR INFORMATION, ADDRESS

H. B. JAGOE, G.E. Pass. Agt. J. WOLFE, Gen. Agt.  
363 Broadway, New York Albany, N. Y.

C. E. LAMBERT, Gen. Pass. Agent  
5 Vanderbilt Avenue, New York

### KICKER'S LOGIC.

A man entered the City Clerk's office, in Tacoma, a few days since, to take out a dog license and in the course of the transaction had many and varied complaints to make about the injustice of such a tax. However, after paying his dollar he remarked that the aforesaid dog was a female, was inoffensive, etc., whereupon the clerk said the ordinance provided that the license for female dogs was \$2 instead of one, and demanded another dollar. After another seance at high kicking the man paid the additional dollar.

As he turned to go a sudden thought seemed to strike him and he said, "I guess I had better take out a bicycle license, while I'm here. How much is it?"

The clerk said "\$1 please."

"But this is a lady's bicycle. Is it not \$2?"

The clerk fainted and was carried into the vault, to cool off.—Tacoma "Ledger."

You will do your friends a good turn by sending me their names and addresses, in order that I may acquaint them with the nature of RECREATION.

Mr. Bradley returned from Newberry, and brought me the dear little Davenport gun which you awarded me as a premium for 15 subscribers. We all admire it greatly. Mrs. E. E. Bradley, Deer Park, Mich.

## THE . . .

# ADIRONDACK . . .

# MOUNTAINS Called in Old Times

“THE GREAT NORTH WOODS.”

A marvelous wilderness, abounding in beautiful lakes, rivers and brooks, filled with the greatest variety of fish.

An immense extent of primeval forest, where game of all kinds is to be found.

This wonderful region—located in Northern New York—is reached from Chicago by all lines, in connection with the New York Central; from St. Louis by all lines in connection with the New York Central; from Cincinnati by all lines in connection with the New York Central; from Montreal by the New York Central; from Boston by a through car over the Boston & Albany, in connection with the New York Central; from New York by the through car lines of the New York Central; from Buffalo and Niagara Falls by the New York Central.

A 32-page folder and map entitled "The Adirondack Mountains and How to Reach Them" sent free, post-paid, to any address, on receipt of a 1-cent stamp by George H. Daniels, General Passenger Agent, New York Central & Hudson River Railroad, Grand Central Station, New York.

# The Press Button Knife

Can be Opened Instantly with One Hand by Slightly Pressing the Button ::::

FOR  
Hunting, Fishing and Camping

Our 4-inch or 5-inch jack-knife is invaluable in emergencies when you need a strong knife quickly. Press button and blade is open for use.

Four-inch Blade, Stag Handle, . . . . \$1.00  
Five-inch Blade, Stag Handle, . . . . 1.25

SENT POSTPAID

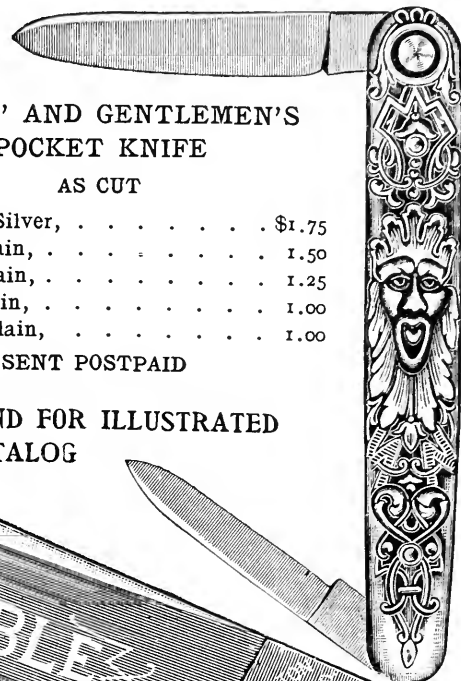

LADIES' AND GENTLEMEN'S  
POCKET KNIFE

AS CUT

In Sterling Silver, . . . . . \$1.75  
In Pearl, Plain, . . . . . 1.50  
In Ivory, Plain, . . . . . 1.25  
In Stag, Plain, . . . . . 1.00  
In Ebony, Plain, . . . . . 1.00

SENT POSTPAID

LOTT  
&  
SCHMITT

112-114 Walker Street  
NEW YORK

SEND FOR ILLUSTRATED  
CATALOG

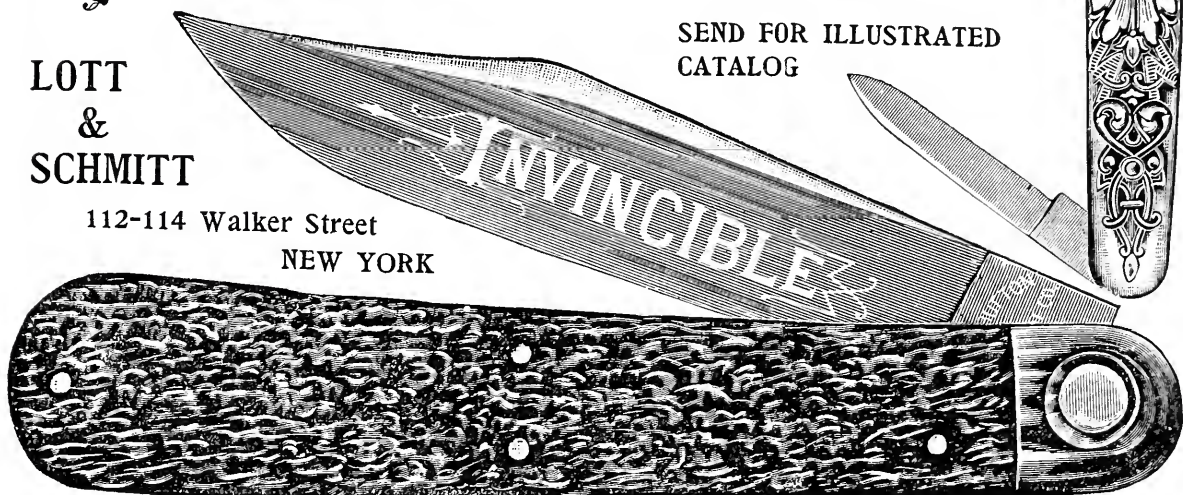

"Any rules and regulations out at that mountain hotel where you were, Lamp-ton?"

"Well—just one:—'Guests who get up to see the sun rise are not allowed to pull the blankets off the guests who don't.'"

"Do you bathe your children yourself, Mrs. Flutterby?"

"No—Mr. Flutterby always bathes the children, and I wash my dogs."

"Gracious—is that a procession coming down the pier?"

"No; Mrs. Tiffington is going to Europe, and her entire family had to come to the vessel with her—to carry the bundles she forgot to put in her trunk."

"Pop had to rent a tandem yesterday."

"What for?"

"To move cook over to our new house, she weighs 200."

A Trial will Convince You that  
**GOLDEN SCEPTRE**  
SMOKING TOBACCO  
Is Almost Perfection. We will send on receipt of 10c. a sample to any address. Prices of Golden Sceptre, 1 lb., \$1.30; ¼ lb., 40 cts., postage paid.  
— CATALOGUE FREE. —  
**SURBRUG, 159 Fulton Street, New York City.**

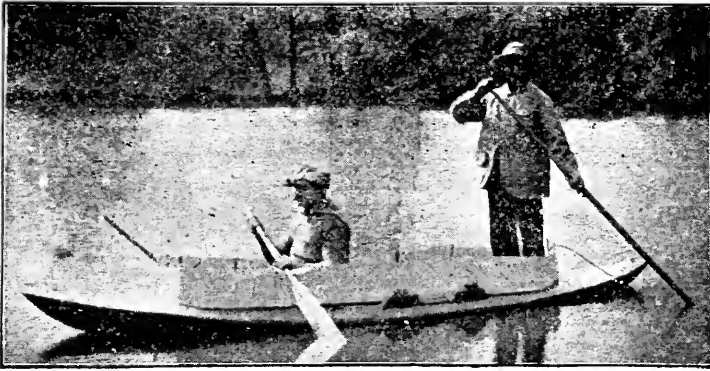

# MULLINS' "GET THERE" SAFETY DUCKING BOAT

Made in Galvanized Steel, Manganized Bronze and Aluminum, with Standart's Extension Air Chambers and Canvas Gunwale, for use in very rough water. The staunchest and most seaworthy boat on the market. An ideal craft for sportsmen. Will last a lifetime. Needs no repairs. Send for catalogue with full description.

W. H. MULLINS, 226 Depot Street, SALEM, OHIO

I have read every number of RECREATION for 2 years, and am very much pleased with your articles on "Guns and Ammunition," also with your game notes.

Roswell C. Beecroft, Pelham Manor, N. Y.

RECREATION is a daisy. If it keeps on improving for the rest of the year, as it has for the past 4 months, what will it be then?

P. E. Clock, Oneida, N. Y.

May number of RECREATION is the best and most artistic number yet printed. Success to you.

J. Chas. Hahne, Warren, O.

RECREATION is the best periodical I have ever read. Just the thing for sportsmen.

W. H. Eppehimer, Pottstown, Pa.

The May number of RECREATION at hand, better, more charming, than ever.

W. H. Nelson, Forest Glen, Md.

RECREATION is right up to snuff.

T. B. Parker, So. New Berlin, N. Y.

RECREATION is a charm to me, and to all members of our family. I can hardly wait till it comes again. I don't see how you can get up such a charming sportsmen's magazine for \$1.

L. BOETTGER, Callicoon, N. Y.

I enclose \$1, for renewal subscription for RECREATION. I regard it one of the best publications in its line, and take pleasure in recommending it to all of my friends.

Frank A. Johnson, Chicago, Ill.

RECREATION is the best sportsman's magazine published, and I must have it regularly.

C. A. Lodge, Bement, Ill.

RECREATION is one of the best journals of its kind published.

Carl F. White, Cleveland, O.

I think RECREATION the best sportsman's periodical published.

L. M. Taylor, New York.

RECREATION is the best magazine I ever read.

H. N. Treworgy, East Surry, Me.

Sectional View

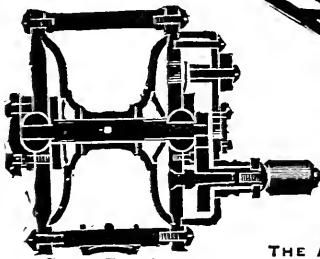

Globe Bearing.



Don't believe imitators of "HENDRYX" standard goods when they say their Fishing Reels "are **NOW** as good as HENDRYX". The fact that they imitate proves the "HENDRYX" is the **recognized standard line** of Fishing Reels. Ask your dealer for them.

THE ANDREW B. HENDRYX CO., NEW HAVEN, CONN., U. S. A.



I can't do without RECREATION. It is the next best thing to being out on the hunt oneself, and in many of the articles, I live over again my Western experiences, without the trials and hardships incident to a winter's campaign.

Dr. J. S. Kennedy, Chambersburg, Pa.

You make the best magazine ever published, relating to the rod and gun, to say nothing of other sports.

H. E. Ward, Milford, Mass.

I am pleased with your magazine. Like it better every month. Many of the sportsmen here take it and all like it.

Herbert Warner, Middletown, N. Y.

Your magazine is the best book of its kind I have ever come across.

A. A. Haney, Fort Worth, Tex.

RECREATION is all right. Give it to the game and fish bristle backs.

Ray C. Longbothum, Mansfield, Pa.

RECREATION is good.

A. G. Carpenter, Plainfield, N. J.

## J. B. CROOK & CO. Established 1837

1180 Broadway, Cor. 28th Street

Manufacturers and Importers of NEW YORK CITY, U. S. A.

HIGHEST GRADE FISHING TACKLE HIGHEST GRADE

SPECIALTIES FOR 1897

Featherweight Rods, Aluminum Reels Trout and Salmon Flies

The only Waterproof Fly Lines: The London Black or Trout, Salmon, and Black Bass. Send 7 cents for catalogue. Mention RECREATION.



**WE HAVE TESTED THEM.**

"We use them ourselves and RECOMMEND THEM to others."

|                   |                   |
|-------------------|-------------------|
| DuPont Powder Co. | Kings Powder Co.  |
| Hazard            | Walsrode          |
| E. C.             | U.S. Smokeless P. |

**"IDEAL" Loading Machine, \$7.**

Universal Powder Measure, \$2.50. High Grade Clover, \$2.50.

Ask your dealer for them or send cash to

**IDEAL MANUFACT'G CO., NEW HAVEN, CONN., U. S. A.**

"Ideal Hand-Book of Useful Information to Sportsmen." 100 pages. Send stamps for it to above address. Please mention RECREATION.

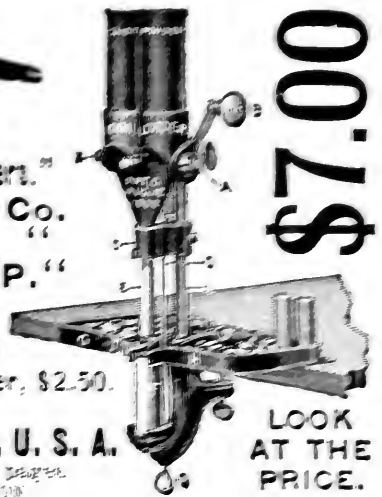

**\$7.00**  
**LOOK AT THE PRICE.**

#### TWO PLUCKY GIRLS AND A BEAR.

Mr. and Mrs. R.— as fatherly and motherly protectors, had taken under their wings a number of young ladies and gentlemen, including a charming girl, a Miss V— V—. The party was on its camping trip, on the East slope of the Blue mountains. Mrs. R— and Miss V— V— finding themselves alone in camp, on a beautiful sunny afternoon, betook themselves to a berry patch, not far away, and were filling their pails with luscious blue huckleberries, when suddenly looking up they saw a big black bear, busily engaged in the same occupation.

Not knowing whether to faint or to have the bear chew them up they held a "pow-wow" and concluded to give their friends a surprise. Then the ladies slipped back to camp, got rifles and courage and proceeded on their killing expedition. Finding the bear in the same position they opened fire on him. Two of the bullets entered on the right side and went clear through. One of these ranged upward and broke the bear's back bone. Then the ladies finished him with a shot in the head.

This story had been told many times before I heard it, and when I asked to see the skin it had so shrunk that to my unprejudiced eye it was merely the pelt of a poor little innocent pine squirrel!

E. C. G., Portland, Ore.

#### THE OTHER SIDE OF IT.

Mammoth Hot Springs, Wyo.

Editor RECREATION: An article in RECREATION last October, by S. N. Leek, said the officials here were giving certain parties permission to hunt on the timber reserve. Mr. Leek makes a misstatement. Captain Anderson showed no partiality to

any one going through the Park. Captain Anderson has done more to protect the game in the Park than any other superintendent. Since Felix Boggett left the Park, as soon as it has been a hard matter to get a man to fill his place.

Mr. Leek also said no resident of Jackson's Hole ever took part in the killing of buffalo, but I know 2 men, personally, who took some heads out that way, and they are residents of Jackson's Hole. A Mr. Crawford took out \$2,700 worth of furs.

Mr. Leek does Captain Anderson a great injustice when he says a few were given permission to hunt on the timber reserve.

C. G. W.

The case of Nate Drummond, arrested for illegally killing elk, was to have been tried before Justice Colver, of Gardiner, Montana, but at that time, on motion of attorney for defendant, a change of venue was taken. The case was transferred to Justice Berg's court at Aldridge, where it was tried by jury, and the defendant acquitted.

This seems a flagrant case of inability to secure conviction in one part of the West, for the killing of game out of season. It appears that Drummond killed 40 elk, taking only the hind quarters, which he sold in a coal-mining town. The trial by jury was in that town, and the sympathy of the eaters of the meat, naturally went with the killer of the elk.

As a restful contrast, may be cited the case of George B. Scott, whose trial occurred not far from the other scene of "justice." Scott was caught in the act of packing the carcasses of several elk from the Yellowstone Park. He was tried before Commissioner Mildrum and promptly convicted; his sentence being 6 months in the guard-house at Fort Yellowstone, and a fine of \$200.

## WHAT THEY SAY OF IT.

I am more than pleased with your magazine. Your reproductions of photographs, of game and sporting scenes, are elegant, and are worth more than double the price of the magazine.

Enclosed find 25 cents, from this far Northwest, for the fresh air fund of your magazine, from 2 well wishers, who like to "read your pictures" and who want to help some of those poor children. My little girls, Hazel and Gladys, send this with their sympathy, and hope one or two other children may be made happy, even if only for a day.

Thos. Boyd, Winnipeg, Can.

I have never taken any publication (and I take many) that gave me more real pleasure than RECREATION does. My mind goes back to the mountains, and for a while business cares are laid aside. I am again among the deer, bear, elk and other wild animals I was so intimately associated with in my early manhood.

Dr. R. Boyd Cabell, DeWitt, Mo.

You certainly deserve credit for the way you have handled RECREATION, and I wish you the splendid success you deserve. I have hunted all over the West—Wyoming, Colorado, Montana—and was a cowboy in Montana. Your Western stories interest me deeply. I read RECREATION every month, and only wish it were a weekly instead of a monthly magazine. A. P. deFuniak, Birmingham, Ala.

I will do all I can for RECREATION. It is the best book of its kind I ever read. I have gotten some valuable information from it. One day I came across it at the news stand, took it home and read it from cover to cover. I went back and tried to get old numbers, willing to pay any price, but soon found the dealers always sold them all.

G. U. Waltman, Spokane, Wash.

RECREATION is becoming very popular in this city, among many of my acquaintances, and it is a question of only a short time, when a great many more of the people here will know a good thing when they see it. Sportsmen who cannot interest themselves in RECREATION should not be classed as such, in any sense of the word.

E. N. Young, Minneapolis, Minn.

I want to compliment you on RECREATION. It is the best sportsmen's magazine published. I could not get along without it. I will send you a club of new subscribers, later, as several have asked me to send in their names, having seen RECREATION in my office, and without any solicitation from me.

Dr. W. L. McNamara, Kenton, O.

Long live RECREATION. We have 4 sportsmen's publications in the house, but RECREATION leads them all. Shall always have a good word for it as long as it stays by the principles it now advocates.

E. W. Phillips, Missoula, Mont.

Will try and interest my friends in RECREATION (and indeed it does not require much trying). They lose a great deal by not subscribing to such a feast of anecdote and information as is contained therein.

Jas. Thornton, Brooklyn, N. Y.

I enclose herewith my check for \$1 for another year's subscription. RECREATION is getting grander every issue. The May number is a beauty. I have every number, from No. 1 to the present. Jno. G. Messner, Pittsburgh, Pa.

RECREATION fills a field to itself. It is impartial in its treatment of outdoor sports. It is plain, straightforward and appeals to the men who do the real work afield.

F. C. Reihl, Alton, Ill.

RECREATION is the best sportsmen's magazine in this country, or any other, and you may rely on my being a subscriber as long as it is published.

P. K. Rossiter, Ithaca, N. Y.

I am greatly pleased at the way you roast those fellows who boast of their great strings of fish. We know some of the men and have a good deal of fun with them about it.

S. S. Holmes, Baldwin, Wis.

RECREATION is charming.

J. D. McLeod, Milwaukee, Wis.

RECREATION is the brightest and most interesting magazine published, and I heartily commend you for the way in which you call down the "Game Hogs."

Theron Hill, Rochester, N. Y.

Enclosed find \$1 for RECREATION. Accept my thanks for the fine reading and the information there is in it. It is the best sportsmen's magazine in existence, and I wouldn't be without it.

John Hepner, Marion, Wis.

Inclosed find \$1 to renew my subscription. RECREATION is the best periodical I ever saw, and improves each month. My wife looks for it as eagerly as I do.

D. M. Hazleton, Corning, N. Y.

I have taken RECREATION for 2 years, and always look forward to the next number, as I know I shall have a treat.

James Atkins, Springfield, Mass.

I have read RECREATION 2 years, and it is the best magazine of the kind published.

C. L. Stevens, Niagara Falls, N. Y.

I like your magazine better than ever, and so long as I can find the dollar you can count on me as a subscriber.

G. A. Ross, Ft. Wayne, Ind.

I buy your magazine at a book store, and it is great. I can scarcely wait a month for it.

Fred C. Owen, Elmira, N. Y.

RECREATION is the best magazine published, and it has come to stay as long as I have the subscription price.

H. A. Buell, Maywood, Ill.

I cannot do without RECREATION as long as I can find one minute to read it.

Frank N. Wise, Mt. Holly Springs, Pa.

I read RECREATION every month, and enjoy every page. It is my ideal of a sportsman's magazine.

A. C. Bryant, Cochrane, Mass.

RECREATION is out of sight. I will get you some subscriptions for it soon. He has since sent in 54.

T. H. Wade, Livingston, Mont.  
EDITOR.

My husband and I are great lovers of RECREATION, and now the baby seems to enjoy it quite as much, especially the pictures.

Mrs. M. H. Littell, Dallas, Tex.

I find RECREATION a very satisfactory magazine. It is the sportsman's ideal publication.

Fred W. Haynes, Roseburg, Ore.

RECREATION stands at the head of sportsmen's literature. It contains the most valuable information to sportsmen.

Wallace J. Bundy, Colerain, O.

I have only one thing against RECREATION: it don't come often enough.

Chas. McClellan, Dallas, Tex.

RECREATION is at the head of the list of sportsmen's journals.

B. C. Packer, Lock Haven, Pa.

RECREATION is splendid—in fact the best of the kind I ever read.

R. G. Goldy, Williamsport, Pa.

RECREATION is the best magazine of its kind I ever read.

C. W. McDonell, Kensal, N. D.

RECREATION is the best magazine I have ever read.

John Schade, Albany, N. Y.

RECREATION is a splendid magazine. Everyone is delighted with it.

Robt. D. Knapp, Danbury, Conn.

I could not keep house without RECREATION.

F. A. Rice, Avoca, N. Y.

RECREATION is decidedly the best magazine in its line I ever read.

Ed. Prather, Dallas, Tex.

# The Wing

✿ ✿ STYLE 7

# Piano



You do not have to pay an extravagant price for a first-class piano



In justice to yourself write for prices of the Wing Piano before you buy



## The Instrumental Attachment

imitates perfectly the tone of the Mandolin, Guitar, Harp, Zither and Banjo, giving the effect of an entire orchestra of these instruments playing in concert with the piano

**SENT ON TRIAL** We will send this piano, or your choice of four other styles, to any part of the United States *On Trial* (all freights paid by us), allow ample time for a thorough examination and trial in the home, and, if the instrument is at all unsatisfactory, we will take it back at our own expense. No conditions are attached to this trial. We ask no advance payment; no deposit. We pay all freights in advance.

### OLD INSTRUMENTS EXCHANGED EASY PAYMENTS

OUR BOOK should be in the hands of every one who intends to buy a piano. It contains many valuable hints and instructions, and tells a great many things every buyer ought to know. We will send it free with our catalogue to any one who writes us.

**WING & SON,** 443 and 445 West 13th St., N. Y. City  
ESTABLISHED 1868

### WHAT THEY SAY OF THE PREMIUMS.

I am now prepared to speak in enthusiastic terms of the Forehand gun received from you, as a premium, last fall. I am exceedingly well pleased with it, and the good work it does, and do not cease to congratulate myself that I had the good fortune to become acquainted with you and with RECREATION.

H. O. Watrous, Carbondale, Pa.

The Hollenbeck gun you sent me, for 35 subscribers, shoots as good and as hard as any high grade gun I ever shot. Both barrels will make a pattern of 75 per cent., 40 yards, 30 inch circle, No. 7 chilled shot. Any one wanting a good gun should get up a club for RECREATION.

C. Hoppenstedt, Newburgh, N. Y.

The Bristol steel rod I received from you, as premium for 10 subscribers, is all I could desire. Have caught quite a number of black bass, and a jack salmon, that gave the rod as severe a test as one could ask; and it does not show the least sign of the strain.

John F. Dunckel, Springfield, Mo.

My Bristol steel rod arrived all right, and I am delighted with it. It is nicely balanced and exceeds my expectations in every way. All the boys say it is a fine rod. No man who loves to fish should be without a Bristol rod.

Fred Libbey, Concord, N. H.

Please accept my sincere thanks for the Bristol steel rod you sent me, for 10 subscriptions. In every particular it is exactly as advertised. It is just what I want for good hard service.

Harry H. Beaver, Cadillac, Mich.

My son received the 4x5 Premo D. Camera yesterday, from the Rochester Optical Co. He is very much delighted with it and of course appreciates your and their prompt attention.

John B. Hutchings, Louisville, Ky.

I received my Bristol steel rod promptly, and it is a hummer. I believe it the coming rod for expert anglers. I am very thankful to RECREATION for the liberal premium. Long may the magazine live.

E. N. Hudson, Reedsburg, Wis.

I have received from the Rochester Optical Co. a beautiful Premo B. camera, for the club I sent you, for which please accept my sincere thanks. My friends all admire it, and I am sure it is a good one.

Wm. B. Haynes, Akron, O.

I have received the Marlin repeating rifle you sent me, as a premium for 20 subscriptions, and it is a beauty. I could not wish a better premium for the little work I did. I got all my subscribers in 4 days.

Albert K. Mueller, Cleveland, O.

I received the Premo camera, sent me as a premium, and am highly pleased with it. I have developed some negatives and the work is much better than I had expected.

W. B. Davis, Union, Ore.

I have received the Bristol steel fishing rod and it is a beauty. It is the best rod I own. I am very proud of it, and am greatly obliged to you.

Frank Malloy, Freeland, Pa.

I received the camera and the carrying case, from the Blair Camera Co. O.K. It is a fine looking camera, and I thank you for your promptness in sending it.

A. S. Bailey, Cobalt, Conn.

I received the Bristol steel rod, which is just what I want. I have 2 other old-fashioned rods, of split bamboo, but consider the Bristol the best all-round rod made.

R. A. Walker, Meriden, Conn.

The camera which you sent me works splendidly. I didn't know a thing about taking pictures before I got it, but I can make a fairly good one now.

Frank Clarkson, Worcester, Mass.

I received the Marlin rifle, for the 25 subscriptions, promptly, and if pleasure was a combustible, I would be a millionaire by embarking in the fuel business.

Lloyd Ashlock, Carrollton, Ill.

The Premo A. camera you sent me, as a premium for 25 subscriptions, came to-day, and I am more than pleased with it. This is certainly an easy way of getting a good camera cheap.

F. W. Kutz, Easton, Pa.

The elegant Premo D. camera arrived O. K. and I assure you I was glad to get it, as it enabled me to secure several mementoes of my first experience in camp.

Al. Helborg, Chicago, Ill.

I received the Yawman & Erbe automatic reel, for 10 subscriptions, and it is highly satisfactory.

John Wm. Judson, Lawrence, Mass.

I have received the Marlin revolver, for 10 subscribers, and it is a beautiful piece of mechanism.

J. M. Kerr, Milltown, N. B., Can.

## The Muskoka and Midland Lakes Resorts

Reached only by the

### Grand Trunk Railway System

Is the Paradise for not only hunters, fishermen, and canoeists, but also those in search of health, where comfort and pleasure can be obtained economically.

The woodland and lake scenery would satisfy the most critical tourist.

Camping outfits can be purchased cheaply, or guides, thoroughly acquainted with this region, fully equipped for camping, can be secured readily.

Parties can be furnished with names of guides, and by communicating with them, make all necessary arrangements in advance.

The following fish and game, in season, are to be found in abundance, the variety of which is not surpassed by any other sporting region in the world:

**Fish.**—Bass, pickerel, brook trout, lake trout, whitefish, perch, sunfish, salmon, trout, sturgeon, catfish, herring, and muskalonge.

**Game.**—Deer, partridge, rabbits, pigeons, ducks, geese, plover, bear, woodcock, snipe, grouse, and moose.

**A few of the other Principal Resorts.**—Andros-coggin Lakes, the White Mountains, the salmon resorts of Quebec, New Brunswick, and Nova Scotia, Lake St. John region, the River St. Lawrence, the Thousand Islands.

For descriptive book showing routes and rates, apply to M. C. DICKSON, D.P.A., Toronto, Ont.; D. O. PEASE, D.P.A., Montreal, P.Q.; L. R. MORROW, C.P.A., Chicago, Ill.; R. McC. SMITH, S.P.A., Cincinnati, O.

CHAS. M. HAYS, General Manager, Montreal, P. Q.  
GEO. B. REEVE, Gen. Traffic Manager, Montreal, P. Q.  
W. E. DAVIS, G. P. & T. A., Montreal, P. Q.  
FRANK P. DWYER, E. P. Agent, 273 Broadway, New York.

## A New Lake and New Trout

Rear Admiral Beardslee, of the Pacific Coast Squadron, U. S. N., about a year ago brought to the attention of tourists and anglers a beautiful lake in Northwestern Washington, that contains new varieties of monstrous trout.

President Jordan, of Stanford University, California, an authority on fishes, pronounced them entirely new to science. They are very large, weighing from 10 to 13 pounds and ranging from 10 to 30 inches in length. They are caught by trolling, at a distance of 30 feet or more below the lake's surface, and are the gamiest sort of trout, full of fight. Already, anglers have gone from the far east to Lake Crescent to enjoy the rare sport found there.

A long chapter on this beautiful lake and its finny inhabitants, located in the heart of the Olympic Mountains, is found in the Northern Pacific New Tourist Book, Wonderful '97. Send six cents for it to

CHAS. S. FEE

General Passenger Agent  
St. Paul, Minn.

...To "the" Pleasure Resorts of...  
**Texas and Gulf of Mexico**

TAKE



Via CHICAGO, KANSAS CITY, or  
ST. LOUIS

WAGNER BUFFET SLEEPERS  
FREE "KATY" CHAIR CARS

For further information, address

W. S. ST. GEORGE, Gen. East. Agt.  
409 Broadway, New York

## UNEQUALED ATTRACTIONS

ON THE LINE OF THE

# Union Pacific

FOR TOURISTS

It traverses the Grandest Scenery of the Rocky Mountains, and reaches all the Health and Pleasure Resorts of the Mid-Continent.

**Sportsmen** will find in scores of localities along this line game worthy of their skill, such as Bear, Mountain Lion, Coyotes, Elk, Deer, Antelope, Mountain Sheep, Feathered Game of all kinds. And everywhere are Beautiful Streams well stocked with Trout.

For Gun Club Rules, Game Laws, and any information relative to localities for Hunting, or for information in regard to the UNION PACIFIC SYSTEM, call on or address any General or Traveling Agent of this Company.

R. TENBROECK, Gen'l Eastern Agent,  
287 Broadway, New York City

E. DICKINSON, Gen'l Manager, Omaha, Neb.  
E. L. LOMAX, Gen'l Pass. & Tkt. Agt., Omaha, Neb.

# The St. Denis

Broadway and Eleventh St.  
Opposite Grace Church  
NEW YORK...



## EUROPEAN PLAN



"THERE is an atmosphere of home comfort and hospitable treatment, at the St. Denis, which is rarely met with in a public house, and which insensibly draws you there as often as you turn your face toward New York."

# 20 BOOKS ❀ ❀

ON 20 DIFFERENT SUBJECTS,  
BUT ALL RELATING TO SOME  
DELIGHTFUL PHASE OF  
AMERICAN TRAVEL, VIA  
"AMERICA'S GREATEST RAIL-  
ROAD."



ILLUSTRATED CATALOGUE SENT  
FREE, POST-PAID, ON RECEIPT  
OF A 1-CENT STAMP BY GEORGE  
H. DANIELS, GENERAL PASSENGER  
AGENT, NEW YORK CENTRAL &  
HUDSON RIVER RAILROAD, GRAND  
CENTRAL STATION, NEW YORK.

# NEW MODEL REVOLVER

Has important advantages over all other makes. Rebounding Lock, which obviates all liability of accidental discharge when closing, after discharging cylinder. Simple and superior method of holding cylinder to barrel. Can be removed instantly by pressing a catch in front of the cylinder.

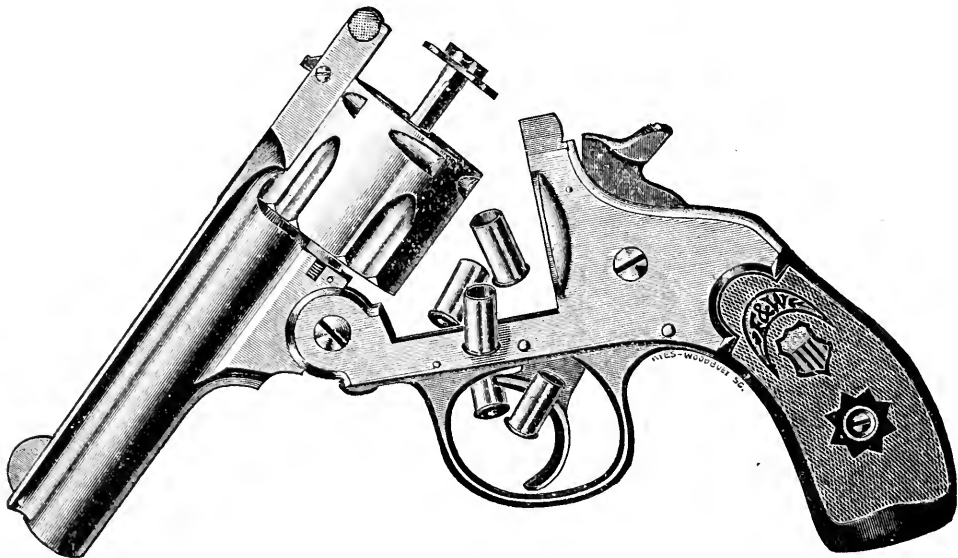

Workmanship unexcelled. All parts interchangeable, and made from drop forgings. Frame is made of cast steel. No malleable iron about it.

SEND FOR CATALOGUE  
Mention RECREATION

FOREHAND ARMS GO., Worcester, Mass.

# ASHLAND HOUSE

FOURTH AVE.  
and 24th ST.  
Two blocks from  
Madison Sq. Garden

...HEADQUARTERS FOR SPORTSMEN

American and  
European Plan

### RATES:

|                       |                |             |          |
|-----------------------|----------------|-------------|----------|
| Rooms, with board,    | \$2.00, \$2.50 | and \$3.00  | per day  |
| Rooms, without board, | \$1.00         | and upwards |          |
| Breakfast,            |                |             | 75 cents |
| Lunch,                |                |             | 50 "     |
| Table d' Hote Dinner, |                |             | 75 "     |

## A RARE OPPORTUNITY

A Willsie Pocket Camera, Valued at \$5.00

As a premium for 5 yearly subscriptions to RECREATION. This Camera makes a picture 2½x2½ inches, and can be loaded with 24 cut films. You can get the 5 subscriptions in one hour.

Write This Office for Camera Catalogue.

Cycle Touring in England at small expense. All about it, for 25c.  
Arthur Munson, Stamford, Ct.

# HYPNOTISM TAUGHT BY MAIL.



**Not Difficult. Spare Moments Sufficient.**  
Not a natural gift; anyone can use it. Latent powers developed and the otherwise impossible accomplished. Ours the most reliable secrets of the art, making all susceptible to this strange influence. Induced by contact, or at a distance by mail or telegraph. Controlled ones and save them from error. Habits, weaknesses and diseases cured. Nothing aids all classes of every age, sex and condition, in business and social life more than this knowledge. Everything private. Established twenty years. Most advanced and reliable methods. Valuable information upon request. Address, **Prof. L. H. ANDERSON, R. C. 67, Masonic Temple, Chicago, Ill. U.S.A.**

# Wyoming...

For Antelope, Bear, Cougar, Deer, Elk, Fish, Goat, Moose, Sheep, Grouse, Duck, and Sage Chicken Shooting,

ADDRESS **H. D. DEKALB, BIG PINEY, WYO.**

# RUPTURE ABSOLUTELY CURED . . . . .

without truss, operation or confinement, on strictly scientific professional principles, based on an experience of many years.

My method of treatment is known only to myself, and I object to long letters explanatory thereof. An interview is positively necessary for those requiring information.

Complete cure effected in 6 to 8 weeks; one treatment each week, with no detention whatever from business.

# SACREDO

Care F. C. PRESTON, 98 Hudson Street, New York

## GOLD MEDAL CAMP FURNITURE MANUFACTURING CO., RACINE, WIS. U. S. A.

Manufacturers of the celebrated Gold Medal Camp and Folding Furniture, and Folding Portable Bath-tubs.



Look for our GOLD MEDAL CAMP BED in this space next month.

Price \$10.00

**GOLD MEDAL FOLDING BATH-TUB**

AGENTS WANTED. Mention RECREATION. Write for Discounts.

None so Portable, none so Thoroughly Good and none so Comfortable.

This cut represents our Gold Medal Folding Bath-tub. These have been in use a year and have proved entirely satisfactory. The frame is constructed with our patent metal joints, in such a way that it folds in an exceedingly small space. The cover is made of very heavy, closely woven duck, coated with pure, thoroughly refined rubber, cured in such a way that it is tough and elastic. The duck is specially rubbered for us and we warrant it not to crack. This tub is made with no separate parts and is so arranged that it can be picked up and carried even when it contains water for the bath; and empties by simply raising one end, the other forming a trough through which the water is poured into a pail. It is in every way a practical bath-tub, strong enough to hold the heaviest person, and will last a generation. Folds 5 ft. by 5 in. square.

Send for free Catalogue of Camp and Folding Furniture and Bath-tubs.



This is a picture of Sewell Newhouse, inventor of the celebrated  
**NEWHOUSE STEEL TRAPS**  
 known the world over as the best traps made for catching fur-bearing animals. Send to

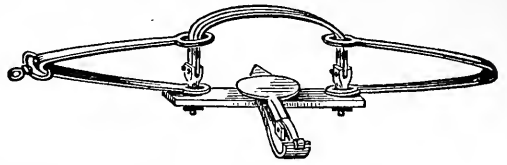

**ONEIDA COMMUNITY, Ltd., Kenwood, N. Y.**  
 for catalogs, prices and discounts.

**FOSTER & CO.** 

Dealers in

*Natural History Specimens*

Animal Heads and Horns, Bird Skins and Eggs, Dead Game Panels, Indian Relics and Photos, Modern Indian Goods of Utility, Minerals, Fossils and Shells, Bicycles and Sundries, Natural History Supplies and Publications, Sporting Goods, Curios, etc. High-Class Taxidermy, Group Work.

**ANN ARBOR, MICH.**

I am a lover of all that pertains to sportsmanship, and an ardent admirer of RECREATION. Have read it from Vol. I, and we are old friends. I admire your course; ever upholding the right, and decrying and holding up to exposure and ridicule, the wrong.

Dr. A. H. Fulton, Knoxville, Ia.

I am heartily in sympathy with your ideas, as expressed in RECREATION, and you have my sincere wishes for your success.

B. W. Abbey, Barre, Vt.

I am a young taxidermist, and find your photographs of animals and birds, as well as your general information, of great value.

W. C. R., Waterford, Me.

May RECREATION be the best yet. I do not know how you are going to improve on it.

A. C. Dennison, Milltown, Me.

**Taxidermists' Supplies**

WHEN you get a good specimen of bird, fish, mammal etc., that you would like to get mounted, send it to us. We will do it right and also make the price right.

Send five cents for new Taxidermists' Catalogue.

**FRED. KAEMPFER,**  
 Taxidermist,  
 217 Madison St., Chicago.

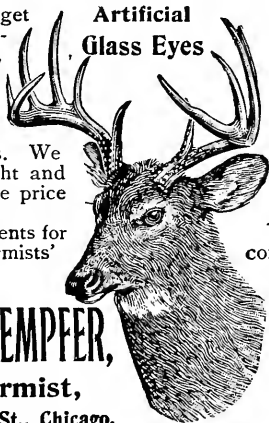

Artificial Glass Eyes

WE prepare and mount all specimens of natural history true to nature, in the best style of the Taxidermist's art, at reasonable prices.

We also keep a complete line of

**Oologists' and Entomologists' Supplies**

Chicago pastors claim they are not afraid of bicycles. That may be explained on the ground that they never have tried to cross a boulevard, on a pleasant Sunday afternoon.—Chicago Post.



Ernest L. Brown  
**The Minnesota Taxidermist**

Does true and artistic work at reasonable figures.

**WARREN, MINN.**

**A QUIET, RESTFUL, IDEAL RESORT**

for sportsmen, tourists, and their wives, with comfortable beds, nice table, good fishing and hunting in their season, is

**The Crow's Nest, Sandy Bay, Moosehead Lake**

Rates reasonable, and only four miles from the railroad terminus. For particulars, write

**BIGNEY & ROWE, Proprietors, GREENVILLE, ME.**

THE  BEST  
 OF  ALL

**AMMUNITION**

Try .22 Peters' Short Smokeless and New Victor Shells, Loaded with King's Smokeless

FOR ACCURACY, VELOCITY, STRENGTH, PENETRATION AND CLEANLINESS.



INSIST ON YOUR DEALER SUPPLYING YOU  
**THE PETERS CARTRIDGE CO.**  
**CINCINNATI, O.**

FOR SALE EVERYWHERE



## SOME GOOD GUIDES.

Following is a list of names and addresses of guides who have been recommended to me, by men who have employed them; together with data as to the species of game and fish which these guides undertake to find for sportsmen.

If anyone who may employ one of these guides finds him incompetent or unsatisfactory, I will be grateful if he will report the fact to me.

## ALASKA.

William York, Juneau, moose, bear, deer, sheep, goats and small game.

## CALIFORNIA.

Chris. Ringsin, Avalon, Santa Catalina Island, goats, water-fowl, and salt water fishing.

John Broder, Visalia, trout, deer, bear, grouse, and quails.

S. L. N. Ellis, Visalia. ditto

## COLORADO.

J. M. Campbell, Buford, elk, bear, deer, antelope, trout and grouse.

Chas. Smith, Buford, ditto

Frank Allen, Dotsero, Eagle Co., ditto

Charles Allen, Dotsero, Eagle Co., ditto

John Meier, Sweetwater Lake, Dotsero P. O., ditto

Eagle Co., ditto

Wells and Patterson, Meeker, ditto

R. W. McGee, Debeque, ditto

Lem Crandall, Debeque, ditto

Sam. T. Himes, New Castle, ditto

Luke Wheeler, Pinkhampton, ditto

Nathan Fisher, Gunnison, ditto

W. H. Hubbard, Glenwood Springs, ditto

W. L. Pattison, Buford, ditto

J. E. Borah, Glenwood Springs, ditto

Ed. L. Stockton, 527 11th St., Greeley, ditto

## FLORIDA.

C. L. Farnham, Avon Park, bear, deer, turkeys, quails, ducks, black bass, etc.

Oliver Tinny, Ozona, Hillsboro Co., deer, bear, turkeys, quails, ducks and salt-water fishing.

E. M. Reynolds, Fort Myers, ditto

Wm. Webb, Osprey, Manatee Co., ditto

Frank Guptill, Osprey, Manatee Co., ditto

W. J. Meyer, Tarpon Springs, ditto

Robt. E. Hammond, Key West, ditto

Frank Carson, Ft. Meyers, ditto

E. T. Robinson, Keuka, ditto

Carson Bros., Frostproof, ditto

J. L. Sandlin, Punta Gorda, ditto

Oliver Archer, Clearwater, ditto

L. W. Scroggins, Homeland, ditto

Capt. Jas. Argo, Oviedo, ditto

F. J. Adams, Sanford, ditto

C. B. Bailey, Winter Haven, ditto

W. H. Steacy, Pt. Tampa City, ditto

Wm. J. Lyon, Interlacken, ditto

L. L. Sutton, Sutherland, ditto

M. B. Carson, Frost Proof, Polk Co., ditto

W. D. Isler, Eagle Lake, ditto

George W. Hawthorn, Hawthorn, ditto

C. H. Hill, Maitland, ditto

J. E. Bowen, Laughman, ditto

Margan Bass, Kissimmee, ditto

B. C. Lanier, Leesburg, ditto

John Hunter, Winter Park, ditto

H. Shipman, Haskell, ditto

Robert James, Emporia, ditto

Alex. Brown, Martin, ditto

W. J. McCullough, Boardman, ditto

Frank Smith, St. James City, ditto

Jinks McCreary, Higly, ditto

Baldwin Cassady, Lisbon, ditto

W. H. Howell, Centre Hill, ditto

Ed. Brown, Dunedin, ditto

G. B. Lawson, Lake Maitland, ditto

J. H. Maddox, Wauchula, ditto

Will Montgomery, Arcadia, ditto

T. E. Fielder, Calvinia, ditto

W. F. Hays, Webster, ditto

## IDAHO.

W. L. Winegar, Egin, Fremont Co., elk, bear, deer, antelope, mountain sheep, trout and grouse.

Geo. Winegar, St. Anthony, Fremont Co., ditto

R. W. Rock, Lake, Fremont Co., ditto

Ed. Stailey, Lake, Fremont Co., ditto

J. S. Sadorus, Sarilda, Fremont Co., ditto

Geo. W. Rea, Orange, Fremont Co., ditto

Wm. Fraser, Beaver Canyon, ditto

## IOWA.

Geo. Jenkins, Spirit Lake, ducks, prairie chickens, black bass, etc.

Wilbur Clark, Spirit Springs, ditto

## MAINE.

Wm. S. Emery, Blakesley Camps, Eustis, moose, caribou, deer, trout, grouse.

Algie Spearin, Moro, ditto

Charley Condon, Moro, ditto

Wm. Atkins, Oxbow, ditto

Miles D. Arbow, Oxbow, ditto

Frank Cram, Oxbow, ditto

Nathan B. Moore, Bingham, ditto

Charley Powers, Medway, ditto

Charley Hale, Medway, ditto

Walter Dacey, Medway, ditto

Elliott Rich, Bethel, ditto

John C. Lamb, Kineo, ditto

John H. Quilty, Kineo, ditto

Winn McKenney, Patten, ditto

Mitchell Francis, Patten, ditto

Royal E. Paine, Stratton, ditto

Charles Hathaway, Medway, ditto

Victor Scott, Millinockett, ditto

C. O. Norton, Dover, ditto

Benjamin J. Woodaid, Dover, ditto

Benjamin Woodard, Dover, ditto

Col. N. D. Brown, Roach River House, ditto

Alonzo Davenport, Shesuncook, ditto

Ichabod Smith, Greenville, ditto

Ernest Ham, Guilford, ditto

Charlee Capen, Capens, ditto

Ed. Masterman, Moosehead, ditto

Marsh Carlton, Rangely, ditto

Freeman Tibbetts, Rangely, ditto

Fred Reed, Medway, ditto

Dan Hale, Medway, ditto

Will Meyer, Eustis, ditto

Charles Haley, Eustis, ditto

H. R. Horton, Eustis, ditto

Abner McPhiters, Norcross, ditto

Albert McPhiters, Norcross, ditto

Horace B. Cushman, Norcross, ditto

Irving Hunt, Norcross, ditto

Wm. O. Shaw, Dobsy Lake, Washington Co., ditto

Ran. Day, Princeton, Washington Co., ditto

Geo. C. Jones, Carritunk, ditto

Geo. Douglass, Eustis, ditto

David Quint, Eustis, ditto

Davis Moody, Stratton, ditto

Gus Jones, Stratton, ditto

Fred Viles, Stratton, ditto

John Darling, Lowell, ditto

Joe Francis, Old Town, ditto

Sebat Shay, Old Town, ditto

Louis Ketcham, Old Town, ditto

Granville M. Grey, Old Town, ditto

L. A. Orcutt, Ashland, ditto

## MASSACHUSETTS.

Recommended by Dr. Hitchcock, Cliftondall, grouse, squirrels, salt water fishing.

## MICHIGAN.

Bony Markelty, Negaunee, deer, bear, grouse, trout, black bass, and muskalonge.

Thos. Starr, Alpena, ditto

## MINNESOTA.

C. L. Porter, Glenwood, ducks, geese, prairie chickens, and black bass.

E. L. Brown, Warren, ditto

Jack Baldwin, Jackson, ditto

SOME GOOD GUIDES (Continued).

MONTANA.

M. P. Dunham, Woodworth, elk, bear, deer, antelope, mountain sheep, trout and grouse.  
 G. H. Heywood, Red Lodge, ditto  
 W. H. Ryther, Columbia Falls, "  
 Quincy Myers, Columbia Falls, "  
 Theodore Christiansen, Columbia Falls, "  
 Mr. William Jackson, Browning, Montana, "  
 W. A. Hague, Fridley, "  
 E. E. Van Dyke, Red Lodge, "  
 Vic. Smith, Anaconda, "  
 James Blair, Magdalen, "  
 George Whitaker, Gardiner, "  
 Richard Randall, Gardiner, "

NEW HAMPSHIRE.

P. Marden, Wolfboro Falls, black bass, grouse and quails.  
 Frank Britton, Wolfboro Falls, ditto  
 Blake Abbott, Wolfboro Falls, "  
 Ned Norton, Colebrook, moose, caribou and deer.  
 John Bresette, Diamond Pond, ditto  
 Henry Bresette, Diamond Pond, "  
 Lafayette S. Covell, Connecticut Lakes, caribou, deer, etc.

NEW JERSEY.

Billy Throckmorton, Mannahawkin, ducks, geese, brant, shore birds, grouse, salt-water fishing.  
 Dory Hulse, Mannokoking, Ocean Co., ditto  
 Ernest Worth, Bayville, Ocean Co., "  
 James Emmans, Jr., Swartwood Lake, Swartwood, black bass, pickerel, quails and rabbits.  
 Mr. Riker, Culver's Lake, Branchville, perch, black bass and pickerel.

NEW YORK.

Cal. Blanchard, Upper Jay, deer, grouse, rabbits, squirrels and trout.  
 Abe Rundle, Eldred, Sullivan Co., ditto  
 Eugene Scrafford, Eighth Lake, Old Forge, "  
 Ceylon Clarke, Piseco, Hamilton Co., "  
 Joe White, Horseshoe Pond, Tupper Lake, Franklin Co., "  
 Edson Brown, Spring Cove, Franklin Co., "  
 William Boyea, Owl's Head, Franklin Co., "  
 Will Simonds, Franklin Fall, Franklin Co., "  
 Harry Freeman, Axton, Franklin Co., "  
 F. A. Young, Big Moose, "  
 Danforth Ainswarth, Big Moose, "  
 Chris Wagner, Beaver, "  
 Chester Elliot, Beaver, "  
 Edw. Ball, Old Forge, "  
 Garrie Riggs, Old Forge, "  
 Eugene M. House, Glendale, "  
 Geo. P. Finnegan, Smithville Flats, Chenango Co., "  
 L. C. Pendell, Athol, "  
 Geo. Goodsell, Old Forge, "  
 Joe Ward, C. & A. branch, R. N. & O., Oswegatchie, "  
 Martin Humes, Harrisville, "  
 Raymond Norton, Glendale, Lewis Co., "  
 Frank Perkins, Greg, Lewis Co., "  
 Chris. Wagner, Beaver River, "  
 Chas. McKaffery, Saranac Inn, "  
 C. I. Stanton, Blue Mountain Lake, "  
 George W. Fuller, Blue Mountain Lake, "  
 Lawrence Sweeney, Lake Clear, "  
 Leonard Bunting, Greenfield, Ulster Co., grouse, woodcock and trout.  
 Thomas Flake, Cape Vincent, pickerel, muskalonge, black bass.  
 Wilfred Dodge, Cape Vincent, ditto  
 Ren Dodge, Cape Vincent, "  
 Warren Aldrich, Greenwood Lake, black bass, trout, grouse, squirrels, rabbits, etc.  
 Charles Lane, Good Ground, L. I., ducks, geese, snipe, plover and salt-water fishing.  
 Harry Rogers, Eastport, L. I., ditto  
 Geo. Rolston, Lake Ronkonkoma, L. I., "  
 Willett Ellison, Freeport, L. I., "  
 W. C. Raynor, Freeport, L. I., "  
 W. N. Ackerley, Patchogue, L. I., ducks, baybirds, salt-water fishing.  
 H. Smith, Moriches, L. I., quails, woodcock and grouse.  
 Dan Havens, Centre Moriches, L. I., ditto  
 Hugh Smith, East Moriches, L. I., "

NORTH DAKOTA.

Geo. Carl, Sanborn, ducks, geese, prairie chickens, snipe, black bass and pike.

NORTH CAROLINA.

Fenner S. Jarvis, Haslin P. O., deer, bear, turkeys and quails.  
 Robert Waterfield, Knotts Island, ditto  
 Jas. Tooly, Belleport, "  
 W. C. Halsted, Currituck C. H., deer, turkeys, quails, ducks, salt-water fishing.  
 Fred. Latham, Haslin, ditto

OREGON.

Wm. Ascher, West Fork, Douglas Co., deer, bear, elk, trout, grouse, ducks and geese.  
 E. L. Howe, Creswell, Lane Co., ditto

PENNSYLVANIA.

Leonard Champion, Prop'r Lehigh Valley Hotel, Mahogany, Wyoming Co., bass, pickerel, salmon.

VERMONT.

E. Ward, Fair Haven, woodcock, grouse, black bass and trout.

VIRGINIA.

M. Corbel, Virginia Beach, geese, brant, ducks, shore birds, quails, salt-water fishing.  
 Captain R. E. Miles, Machipongo, ditto  
 C. A. Spencer, Buckingham, "  
 M. A. Barner, Clarksville, "

WASHINGTON.

John S. Wood, Morton Lewis Co., deer, grouse, trout, etc.

WISCONSIN.

T. R. Page, Bruce, deer, grouse, trout, black bass and muskalonge.  
 Charles Johnson, care Williams, Salsich & Co., Star Lake, Vilas Co., ditto  
 L. L. Thomas, State Line, "  
 John Thomas, State Line, "  
 Chas. French, Three Lakes, "  
 M. E. Monsell, Star Lake, Vilas Co., "  
 H. E. Soule, South Range, "  
 Judd Blaisdell, Camp Franklin, Woodruff, "  
 Alexander Gillies, Camp Franklin, Woodruff, "  
 C. J. Coon, Camp Franklin, Woodruff, "

WYOMING.

Mark H. Warner, Ten Sleep, elk, bear, deer, mountain sheep, antelope, grouse and trout.  
 Milo Burke, Ten Sleep, ditto  
 James Fullerton, Ten Sleep, "  
 Nelson Yarnall, Dubois, "  
 Geo. Y. Hayes, Dubois, "  
 S. A. Lawson, Laramie, "  
 R. C. Tregoning, Laramie, "  
 A. Pache, Laramie, "  
 N. E. Brown, Marquette, "  
 H. D. DeKalb, Big Piney, "  
 Ira Dodge, Cora, "  
 S. N. Leek, Jackson, "  
 W. P. Redmond, Jackson, "  
 Frank L. Peterson, Jackson, "  
 O. F. Bike, Jackson, "  
 F. E. White, Jackson, "  
 W. A. Hague, Pleasant Valley Hotel, via Mammoth Hot Springs, "

CANADA.

Christopher Bowers, Shelburne, Nova Scotia, moose, bear, grouse, black bass and trout.  
 E. Thompson, Hammond Plain, Nova Scotia, ditto  
 John Bowers, Shelburne, Nova Scotia, "  
 Billy McCoy, " "  
 Frank Komondo, Desert or Maniwaki, P. Q., "  
 Philamon Gashon, Three Lakes, P. Q., "  
 Robert Elliott, Kennebec Road, Armstrong, County Beauce, P. Q., "  
 Geo. Gillard, Little Bay, Notre Dame Bay, Newfoundland, caribou, bear, ptarmigan, ducks and geese.  
 W. Kelly McKay, Upper Clyde, Shelburne Co., N. S., moose, bear, lynx, fox, partridge, rabbit, trout.  
 James H. Bower, Upper Clyde, ditto  
 Thomas Davis, Upper Clyde, "  
 Purney Davis, Upper Clyde, "  
 Christian Ryer, Middle Clyde, "  
 Daniel McKay, Middle Clyde, "  
 Parker K. Freeman, Milton, Queens Co., N. S., moose, bear, lynx, fox, partridge, rabbit, trout, salmon.  
 John Jeremy, Milton, ditto  
 Stephen Glode, Milton, "  
 Alick Michel, Milton, "  
 Enoch Freeman, Greenfield, "  
 Boardman Hunt, Greenfield, "

## WHAT THEY SAY OF IT.

RECREATION is a splendid magazine, and will continue to find its way into many homes by reason of its truthfulness and its attitude toward the game hogs, that roam through the woods shooting game out of season. Let all honest sportsmen unite in bringing these disreputable swine to justice.

I would prefer the acquaintance of a genuine 4-legged hog to that of such men.  
L. D. Wright, Toledo, O.

We have been readers of RECREATION since Feb. '97, and think it the best of its class. We have named our new boat RECREATION, and when we camp out this summer (as we do every summer), we shall call the camp RECREATION. We shoot both rifle and shot gun, and are very much pleased in reading the different opinions about guns and loading.  
H. M. Brown, & Henry S. Brown, Gaylordsville, Conn.

RECREATION for May is by long odds ahead of any previous numbers. The phenomenal growth of this magazine must be the result of your untiring labors. I trust your success has but just begun. Enclosed find 10 cents for RECREATION's fresh air fund. Should think all subscribers would promptly respond to this request.  
J. H. Ramsay, Seaboard, N. C.

About 2 weeks ago I sent you a check for \$1.10—\$1 for renewal of my subscription to "RECREATION," and 10 cents for the fresh air fund. Up to date I have not received a receipt for same, and, worse than all, my copy of the magazine has not come to hand. You can keep the receipt, but for Heaven's sake send the magazine. Can't keep house without it.  
T. C. Todd, Baltimore, Md.

I thoroughly appreciate your efforts to please me in the matter of premiums, and thank you, gratefully, for the interest you have taken in my behalf. Accept my best wishes for RECREATION, the best magazine published, and for its big hearted editor and manager.  
H. O. Matter, Harrisburg, Pa.

Mr. H. O. Motter, 1933 No. Seventh St., says: "RECREATION supplies a long felt want."

Mr. Jacob Keough, 1501 No. Sixth St., says: "Of all the magazines published, in the interest of sportsmen, RECREATION is the best."  
C. Middaugh, Harrisburg, Pa.

I am a crank on rifles and life in the woods, and spend a good deal of time with you for my companion, in the shape of your delightful magazine, for which I thank you, and the good soul, whoever he was, who gave you my name.  
W. H. Nelson, Forest Glen, Md.

We take great pleasure in reading RECREATION, as we are office slaves here, and can get but little time for play. We draw what comfort we can from reading of the exploits of others.  
Joseph Bowman, Wichita, Kan.

Your magazine is the best I have seen yet. All my subscribers are well pleased with it. We are all waiting patiently for the next issue, as each number excels the one past.  
H. Patterson, Wellsville, O.

RECREATION is growing in popularity. Those whom I have sent subscriptions for are much pleased with it, and are eager for the 1st of the month, so they can get RECREATION.  
A. L. Atkins, North Yakima, Wash.

I am very much pleased with the magazine, and compliment you on the improvement shown in each succeeding number. Its influence in behalf of game protection is sure to be felt.  
J. O. Paddock, Rock Island, Ill.

RECREATION is the best magazine, for sportsmen, I have ever seen. The illustrations in it are worth a great deal more than the money paid.  
A. S. Marshall, Cora, Wyo.

I enclose \$4 and the names of 4 subscribers for RECREATION. Everyone is delighted with your beautiful magazine, and there is no trouble in getting subscribers.  
Rev. G. D. Bayne, Pembroke, Ont.

I am a constant reader of RECREATION, and enjoy it very much. It is truly a sterling publication.  
Dr. F. B. Morrill, Los Angeles, Cal.

I never undertook so easy a job as getting up a club for RECREATION. I thought I might get 10 names, but I now have 43. Our sportsmen are delighted with the magazine.  
Rev. G. D. Bayne, Pembroke, Ont.

I find RECREATION improving with age. I admire the stand you take, in regard to the game hogs, and the protection of all kinds of game. May success crown your efforts.  
A. L. Guthrie, Winchester, Ind.

Nearly every sportsman, when shown a copy of RECREATION, says "Yes, put my name down. Here's a dollar." I find it is no work at all to get the subscribers.  
Thomas Perry, Jr., Middletown, N. Y.

RECREATION is by far the best sportsman's magazine I ever read. I wish it were published weekly, instead of monthly. It is filling a long felt want.  
R. C. Fisk, Helena, Mont.

Your magazine grows more interesting, from month to month. Roast the butchers.  
L. D. von Iffland, Cowansville, P. Q.

Take the world but give me RECREATION. All other joys are but a sham compared with this magazine.  
Clarence Soule, Marengo, Mich.

Scarcely a day passes but that I hear some one put in a good word for RECREATION.  
Lloyd Jones, Marshfield, Wis.

Enclosed find \$1 to renew my subscription. Can't do without RECREATION. Best book out.  
B. E. Campbell, Chicopee Falls, Mass.

I like RECREATION, very much, and appreciate the courteous treatment I have received from the publisher.  
L. H. Dodge, Cape Vincent, N. Y.

Of all sportsmen's magazines I have ever seen, RECREATION is the handsomest, most interesting, and instructive.  
Oran R. Akers, Sherman, Tex.

RECREATION the best sportsman's journal published. I read several sportsmen's papers, but find none so interesting as RECREATION.  
H. C. Kurtasch, North Hudson, Wis.

I am delighted with RECREATION, for it fills the bill. Anyone who would wish more for \$1 must be classified with the game hogs.  
Ferdinand Beck, Virginia City, Nev.

I could not take a vacation that I would enjoy more, or one that would cost less, than to peruse each issue of RECREATION.  
J. G. Tobey, Portsmouth, N. H.

My father takes other sportsmen's papers but always wants to see mine first. He thinks RECREATION the best.  
C. H. Smith, N. Y. City.

I like your magazine better than any of the 25 cent ones.  
Alan H. Stevens, Detroit, Mich.

RECREATION is the brightest and cleanest thing of its kind I know of.  
E. F. McLean, Newburyport, Mass.

RECREATION is the best magazine of its kind I have seen.  
Horatio F. Nichols, Boston, Mass.

All who see and read RECREATION are delighted with it.  
L. C. Trout, Staunton, Ind.

RECREATION is the best magazine out, at any price.  
Lester Martin, Lewiston, Idaho.

You publish the most interesting magazine of its class.  
C. H. Calkins, Daisy, Tenn.

RECREATION the best magazine on earth.  
J. E. Meeker, Chanute, Kan.

RECREATION is a peach.  
G. Morton, Augusta, Me.

**A Practical Common Sense Camp Stove.**

In 6 Sizes. Patent applied for.

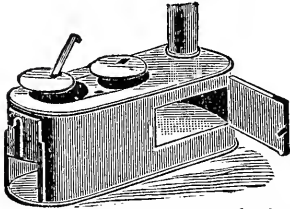

The lightest, most compact, practical camp stove made; either with or without oven. Won't get out of shape, combination cast and sheet steel top, smooth body, heavy lining, telescopic pipe carried inside the stove.

Burns largest wood, keeps fire longest of any stove made. For full particulars address

D. W. CREE, Manufacturer, Griggsville, Ill.

**Dixon's Graphitoleo**

Lubricates not only the chain and sprockets, but also the pins in the links of the chain, which stick Graphite cannot do and is not intended to do. For gun locks, for copying presses, and for office chairs it is unequalled. If your dealer does not keep it, mention RECREATION, and send 15 cents for sample.

JOS. DIXON CRUCIBLE CO., Jersey City, N. J.

WANTED.—LIVE ELK, MOOSE, CARIBOU, BLACK-tail deer, wild turkey, European roebucks, fallow deer, etc., for Litchfield Park, Adirondacks. Address, with particulars, EDWARD H. LITCHFIELD, 59 Wall Street, New York.

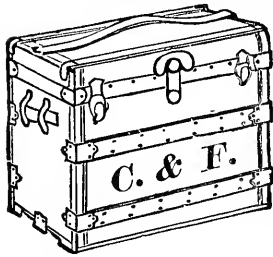

**If You Carry a Gun**

**CROUCH & FITZGERALD, NEW YORK**  
Make Reliable Work Only

161 Broadway

723 6th Avenue

688 Broadway

**Gall & Sembke**  
OPTICIANS.

21 Union Square, N. Y.

The Telescopes furnished by you to the Signal Corps, National Guard, State of New York, I find remarkable for definition and clearness of objects at long distances. Yours, etc.,

HOMER W. HEDGE,  
1st Lieut. and  
Ass't Signal Officer.

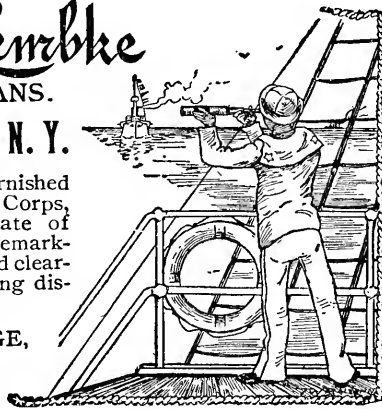

IN ANSWERING ADS, IF YOU WILL KINDLY MENTION RECREATION YOU WILL GREATLY OBLIGE THE EDITOR.

**G. CRAMER**  
**DRY PLATE**  
**WORKS**

ST. LOUIS, MO.

Full descriptive catalogue mailed to any address on application

CHESTNUTS.

"Wheel riding, they say, impairs dancing ability."

"That's not so; I got a bicycle, and it has kept me hopping to pay for it."

"Highgear and his wife are to remarry."

"What brought them together again?"

"They met accidentally, somewhere, and discovered that they rode the same make of wheel."

"Elizabeth seems to have gone heart and soul into this bird-protective movement."

"Yes; and now she is getting up an organization to oppose the slaughtering of those cunning little billy-goats, to make our kid gloves."

"New York has its own theory about the air ship."

"What is it?"

"They say that bright light is some last year's Philadelphia sunsets just getting in."

"Play helps work," the savant writes—

'Tis a false tip he indites:

If we do not work—I say—

How get cash to pay for play?

"Did you read about that man who traded his wife for a shot gun?"

"Yes—lots of men do that; but you don't see many items about men trading their shot guns for wives."

"Jimmy, what is a planked shad?"

"I dunno; mebber they has ter hit 'em with a plank to ketch 'em."

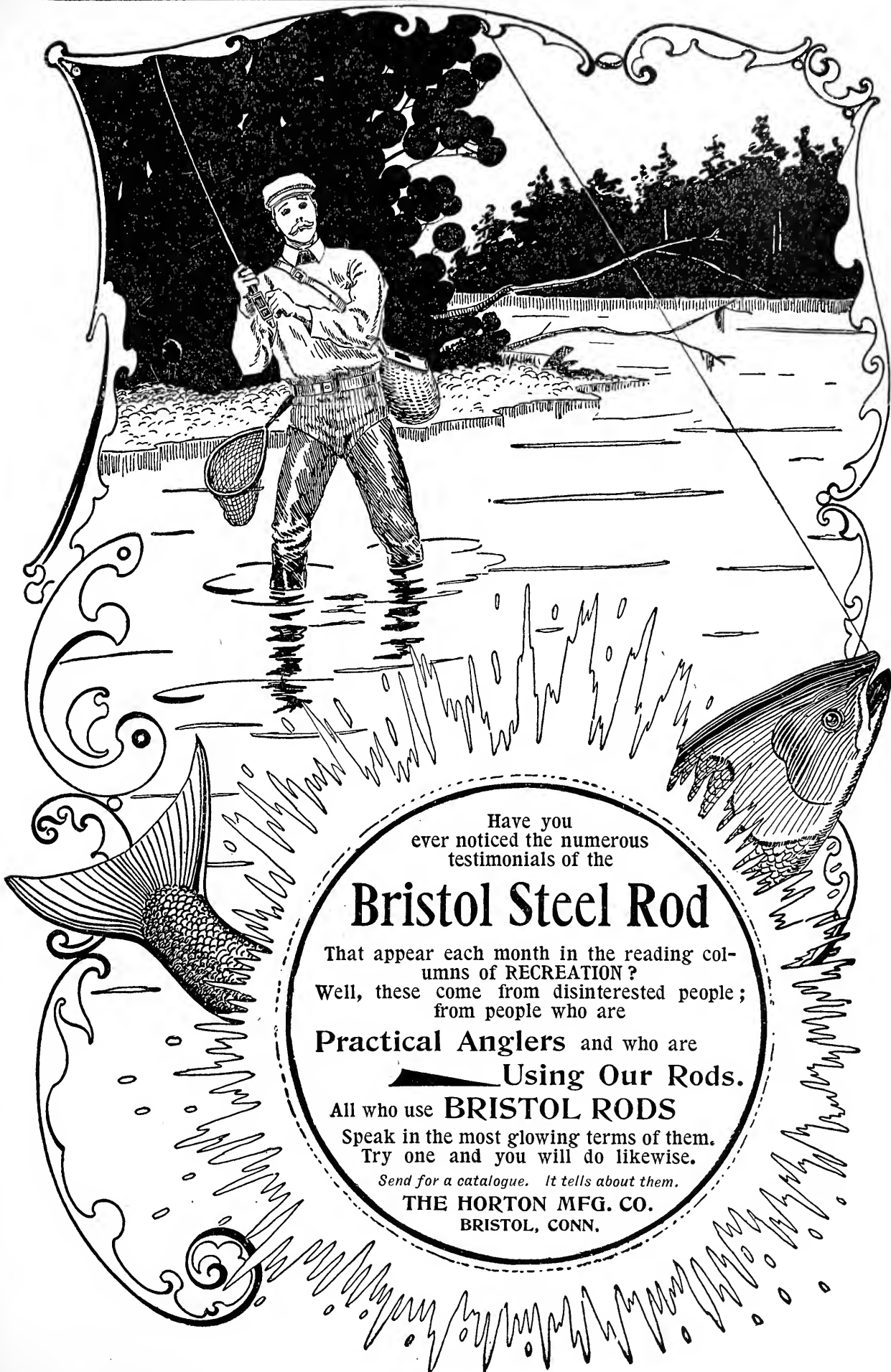

Have you  
 ever noticed the numerous  
 testimonials of the

## Bristol Steel Rod

That appear each month in the reading col-  
 umns of RECREATION ?  
 Well, these come from disinterested people ;  
 from people who are

**Practical Anglers** and who are  
**Using Our Rods.**

All who use **BRISTOL RODS**  
 Speak in the most glowing terms of them.  
 Try one and you will do likewise.

*Send for a catalogue. It tells about them.*

**THE HORTON MFG. CO.**  
**BRISTOL, CONN.**

# Savage Rifles for Savage Game



.303 Carbine

## One Savage Rifle



BIG GAME HUNTING



SCHUETZEN TARGET RANGES



LONG RANGE TARGETS

takes all these different cartridges without any change or adjustment



BLACK POWDER RANGES



SMALL GAME HUNTING



SHORT RANGE USE

CATALOGUE ON APPLICATION

HOME OFFICE

SAVAGE REPEATING ARMS CO.

Utica, N. Y.

PACIFIC COAST AGENCY

BAKER & HAMILTON

San Francisco, Cal.

# New Ithaca Guns

Self compensating, taking up wear at every point

Bored FOR BLACK AND NITRO POWDERS

Close and Hard Shooting Guns at long range a specialty

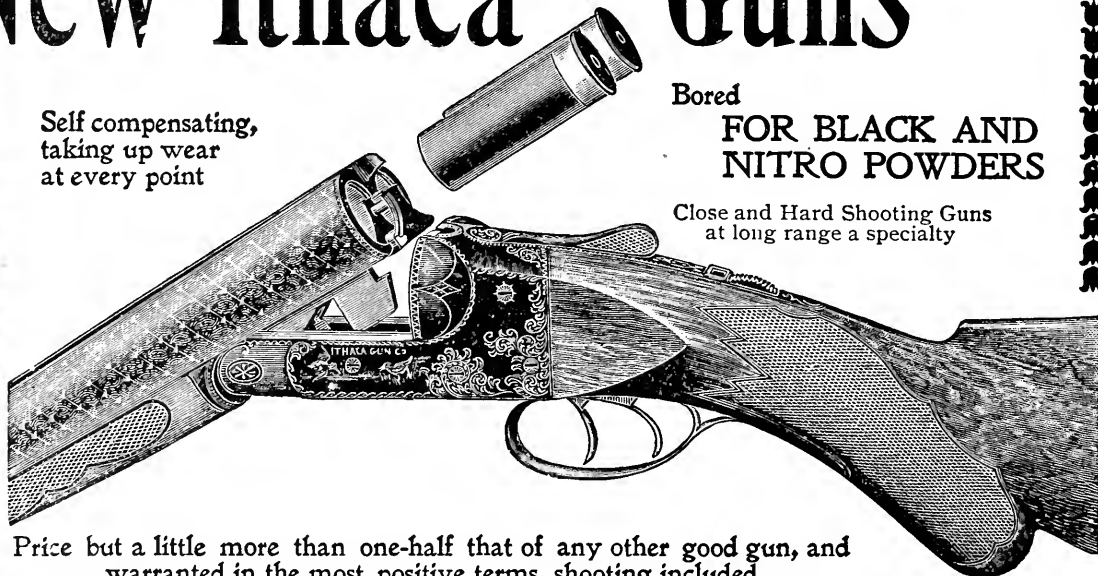

Price but a little more than one-half that of any other good gun, and warranted in the most positive terms, shooting included

## ITHACA GUN COMPANY, ITHACA, N. Y.

Send for circular  
Mention RECREATION

Manufacturers of fine Hammer and Hammerless Guns

For nearly 50 Years the name

**"Davenport"**

has been identified with  
the manufacture of

**Guns....**

**and Rifles**  
+++++

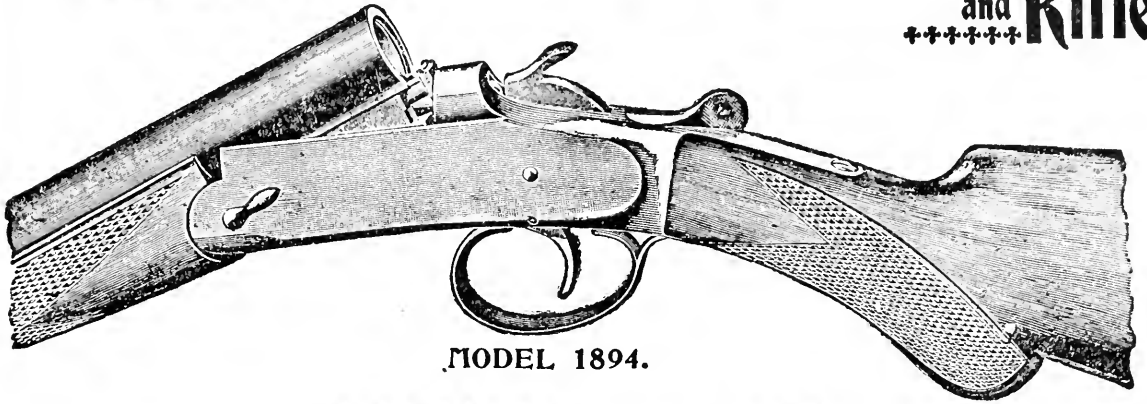

MODEL 1894.

**AUTOMATIC EJECTOR**

Our present line is complete and varied and shows the result of years of experience.

For catalogues and information address

**THE W. H. DAVENPORT FIRE ARMS CO.**

**NORWICH, CONN., U. S. A.**

Mention "RECREATION"

*Ejector Guns  
no longer a  
luxury*

**Good News for Sportsmen**

Lefever Automatic Ejector Guns at a price  
within the reach of every sportsman.

OUR NEW EJECTOR MOVEMENT

*Has only two pieces: One in the  
Hammer, One in  
the Frame.*

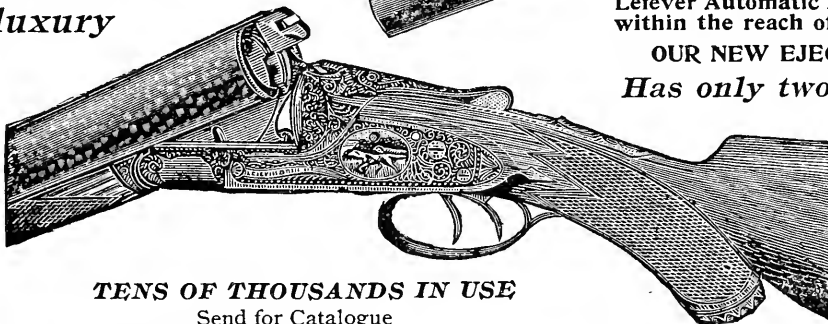

**TENS OF THOUSANDS IN USE**

Send for Catalogue

We have decided to meet  
the demand for *medium*  
price Ejectors, and are now  
prepared to accept orders  
for all grades of our ham-  
merless guns fitted with  
Ejectors.

**LEFEVER ARMS CO. - - Syracuse, N. Y.**

(Mention RECREATION.)

Date,.....1897.

G. O. SHIELDS,

Editor and Manager of RECREATION, 19 West 24th St., New York:  
Herewith find One Dollar, for which please send me RECREATION  
for one year beginning with..... number.

Name,.....

Remit by P. O. or Express Money Order, or New York Draft.

DETACH THIS, FILL OUT, AND SEND IN.

# A FINE PERFORMANCE GRAND AMERICAN HANDICAP, 1897

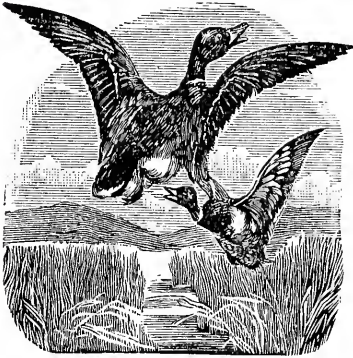

1st—Hon. T. A. MARSHALL,  
Keithsburg, Ill., 25 kills straight.

2d—Dr. W. F. CARVER, Chicago,  
24 straight, and 25th killed but  
carried out of bounds by wind.

2d—Dr. J. L. WILLIAMSON, 24  
ex. 25.

All  
Using  
Cashmore  
Guns

FIRST AND TWO SECONDS OUT OF 136 COMPETITORS





## TRAP GUN BUILDING A SPECIALTY

NEW LIST FREE

Address, WM. CASHMORE, Gunmaker

Telegram, "Extractor, Birmingham"

BIRMINGHAM, ENG.



|                                                                                                                                                                        |                                                                                                                   |   |                                     |                                                                                                                                                                             |
|------------------------------------------------------------------------------------------------------------------------------------------------------------------------|-------------------------------------------------------------------------------------------------------------------|---|-------------------------------------|-----------------------------------------------------------------------------------------------------------------------------------------------------------------------------|
|   | <p>FOR FIELD OR FOR TRAP,<br/>FOR POT HUNTING OR FUN,<br/>NO SPORTSMAN IS EQUIPPED<br/>WITHOUT A SYRACUSE GUN</p> | } | <p>"MORE TRUTH<br/>THAN POETRY"</p> |   |
|------------------------------------------------------------------------------------------------------------------------------------------------------------------------|-------------------------------------------------------------------------------------------------------------------|---|-------------------------------------|-----------------------------------------------------------------------------------------------------------------------------------------------------------------------------|

We do not say that SYRACUSE HAMMERLESS GUNS

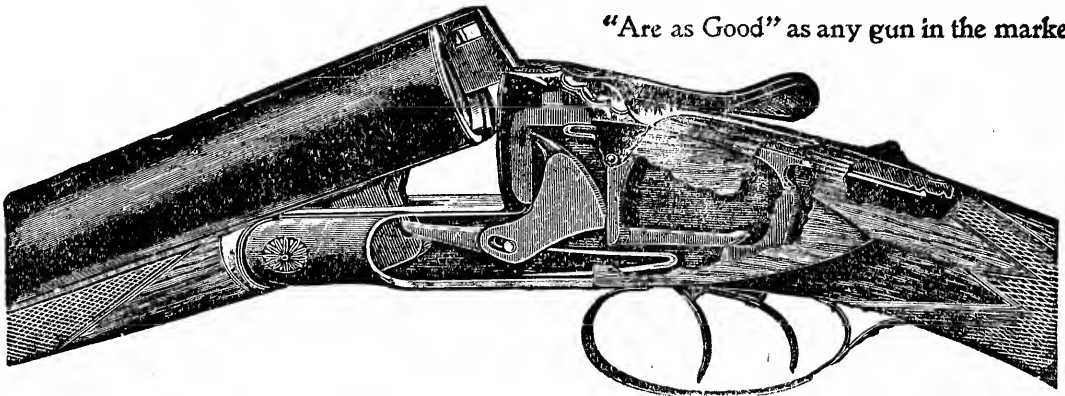
"Are as Good" as any gun in the market.



Their simplicity of construction and superiority of finish stamp them "BETTER" for practical all-round work than any gun in the market. The "old, old story" but, nevertheless, substantiated by every man who ever drew a Syracuse to his shoulder.

|                                                                                    |                                                     |                                                                                       |
|------------------------------------------------------------------------------------|-----------------------------------------------------|---------------------------------------------------------------------------------------|
|  | <p>SYRACUSE ARMS CO., SYRACUSE, N. Y., U. S. A.</p> |  |
|------------------------------------------------------------------------------------|-----------------------------------------------------|---------------------------------------------------------------------------------------|



# Forehand Arms Co.'s

EJECTOR AND NON-EJECTOR  
HAMMERLESS DOUBLE GUN

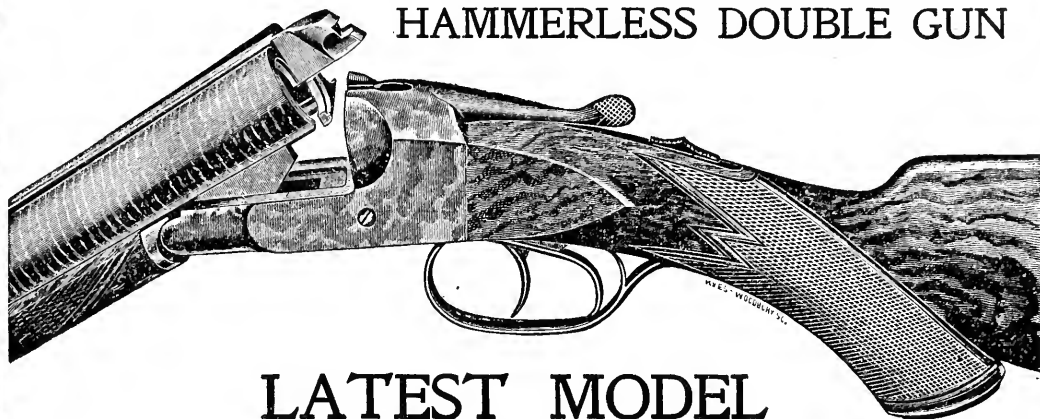

LATEST MODEL

WARREN, ILL.

**READ WHAT MEN  
SAY OF THE  
FOREHAND, WHO  
ARE USING IT.**

The Forehand Hammerless Gun you sent me, for 35 subscriptions, has arrived. I am delighted with it, and shall recommend it highly. It is a good, close-shooting gun, simple in action, and of fine workmanship. I made two long shots with it yesterday at grouse in heavy brush, killing both birds at distances of forty to forty-five yards. I would not wish for a better gun than the Forehand for trap shooting.

DR. A. C. CZIBULKA.

MOLINE, ILL.

I have received from the Forehand Arms Co., of Worcester, Mass., the double-barreled, hammerless, breech-loading shot-gun as a premium for 35 subscriptions, and it is a beauty. It is light, strong, handsome, and shoots as well as any gun I know of. Got four squirrels and a rabbit yesterday—all the game I saw—and one shot at each was enough. I compared my gun with an \$85.00 gun today, of another make, and mine gained in value greatly, in my estimation.

W. B. KENT.

**WE GET THOUSANDS  
OF SUCH  
TESTIMONIALS—  
ALL UNSOLICITED**

**"WHAT EVERYONE SAYS MUST BE SO"**

*We challenge competition in Beauty, Workmanship, Simplicity of Mechanism, Shooting Qualities and Price. We target all our guns with nitro powder. For Catalogue, address*

**FOREHAND ARMS CO., WORCESTER, MASS.**

PERFECTION AT LAST!

SPRATT'S PATENT  
**CAT** FOOD

SAMPLE PACKAGE, 5 CENTS

|                  |        |
|------------------|--------|
| IN BAGS, 12 LBS. | \$1.50 |
| 25 LBS.          | 2.50   |
| 50 LBS.          | 4.50   |
| 100 LBS.         | 8 00   |

DOG AND POULTRY  
SUPPLIES

Order through your Dealer and send for catalogue to  
SPRATT'S PATENT LIMITED  
245 EAST 56TH STREET, NEW YORK CITY

SAN FRANCISCO BRANCH, 1320 VALENCIA STREET

*THE OLD  
RELIABLE*

# Parker Gun

*HAS  
NO EQUAL*

*Has stood the test  
of over 30 years.*

*"Built on Honor"*

*Simplicity and dura-  
bility combined with  
handsome finish and  
perfect shooting  
qualities*



*Experience and ability have placed "The Parker" in an enviable and well deserved position as the best gun in the world. Made by the oldest shot gun manufacturers in America. Nearly 100,000 in use.*

SEND FOR CATALOGUE

New York Salesrooms  
96 Chambers Street

**PARKER BROS., Meriden, Conn.**

# MARLIN DOUBLE ACTION REVOLVERS



All Parts of   
DROP FORGED STEEL

Perfect in Finish

Unsurpassed  
in Accuracy

MADE IN 32 AND 38 CALIBRES, WITH 3¼ INCH BARREL  
Blued or Nickel Finish

Send for  
Catalogue

The Marlin Fire Arms Co., New Haven, Conn.

## HOW IT HAPPENED.

La Fayette, Ind.

Editor RECREATION: In a recent number of RECREATION "Tamarack" told about 2 of his party getting lost. We deny it. It is true we got mixed on distance and did some extra walking; but we had no trouble in finding the place we started from.

There is no question as to the number of trout Tamarack and his partners caught; but their methods were questionable. On leaving camp that morning they were resolved to bring in more fish than we. After leaving us, they started down stream.

Separating, they fished, with fair luck. An hour later, Tamarack, working his way down the middle of the stream, was almost paralyzed by an unearthly scream, followed by a crashing of timber. Before he could recover, Chickaree rushed up to the bank, his hat off, coat torn, rod gone.

"Climb a tree, quick," he could just stammer out. "The biggest bear I ever saw is after me," he panted.

With one bound Tamarack was on the bank; an instant later he was looking down from a safe retreat in the fork of a birch tree. Chickaree was only a second behind him; but where was the cook? Chickaree was sure the bear had him; but Tamarack

thought the fellow too tough for an ordinary bear.

When the branches of the birch began to grow tiresome to the fishermen, they thought to inquire into the fate of the cook. A few war-whoops were answered from the distance, followed by the cook, who was surprised to see them up a tree. When asked what they were doing, they said they climbed the tree to look for him.

After finding Chickaree's hat and rod, still being timid about bears, one of them asked the cook if he had seen any. No bear, he assured them, but he did see a mighty big porcupine. Tamarack looked at Chickaree and Chick looked at Tam. Then they bound the cook to everlasting silence; but it leaked out.

How they caught more fish than we, is the question. It was only what might be expected of them. They whipped the stream unsuccessfully, for a time, finishing their efforts at a pool fairly alive with trout, but not one could they coax out of the wet. So the bold fishermen bound together brush and twigs, making a seine that reached across the pool. With this fiendish machine they hauled in everything, picked out what they wanted and threw the rest back. Then Tam and Chick smiled at each other, as they said, "We have them."

Loon.

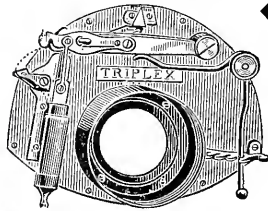

PATENTED.

# THE TRIPLEX

## Photographic Shutter

is the stand-by of the practical amateur and professional. On the market over eleven years, and its popularity increases.

### ADVANTAGES

**FIRST**—Its construction is simplicity itself; it keeps in repair.

**SECOND**—Optically, it gives full value of lens, no reducing illumination by nearly half, like an iris diaphragm shutter.

**THIRD**—It does time work, ordinary fast work, and rapid work to  $\frac{1}{50}$  of a second. Few other shutters have more than one-third this range of speed.

**PRICES:** 4 x 5, USUALLY \$14.00      5 x 7, USUALLY \$15.50

See Circular about \_\_\_\_\_

Athlete Shutter and Storage Flash Lamps

PROSCH MFG. CO., 389 Broome Street, New York

# BE

## Solid Trains TO all Points WEST

### Always Bright!



FOR '97

## WILL NOT JAR OUT

ALL RIDERS  
SAY  
IT IS  
The Best.

For Sale Everywhere.

BRIDGEPORT BRASS CO.,  
BRIDGEPORT, Conn.

Send for Circular.

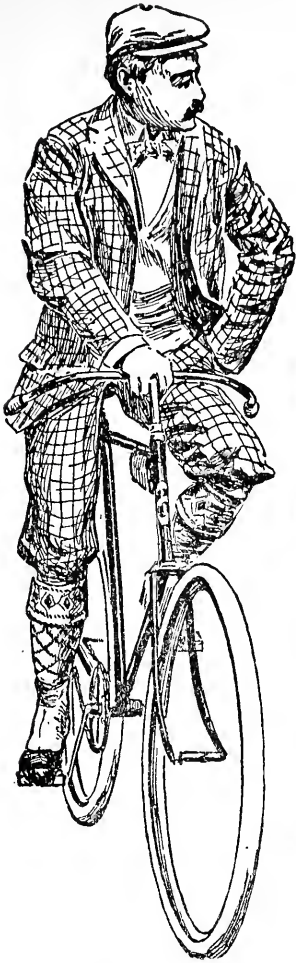

# What's the Use

of walking when you  
can get a first-class, high-  
grade bicycle for nothing?

## How?

By getting 75 subscriptions for  
**Recreation**

If you live in a town of 3,000  
or more, and if you are a hustler  
you can get these in 2 days.

I can give you the names of 20  
people who did this in 1896, and  
who now have their wheels.

Write for particulars.

## RECREATION

19 West 24th Street  
New York



Two of the best revolvers made in the United States, are advertised in this issue of RECREATION. There are 2 other concerns in the country, both of which claim to make "the best" revolvers, but they refuse to recognize the readers of RECREATION as being capable of appreciating their kind of "best" goods. Men who approve the course of this magazine and who desire to see it grow in usefulness, will serve their own interests by patronizing the houses that advertise in RECREATION.

Fishing is good here. There is a party at the hotel, on the carry, and another at the Seloomoc Cottage. They are getting all the fish they want. I am traveling most of the time. I hunt bear until some time in June, each year, and do not engage in the spring fishing.

I see lots of game, on my tramps. Saw 5 moose, recently, and deer are abundant. John H. Quilty, Moosehead Lake, Me.

Isaac Gage, of Hawleyton, N. Y., boasts of having killed over 300 ruffed grouse, last fall, in that vicinity and Brackneyville, Pa., which is near Hawleyton. Why not give him a roast?

E. W. F., Binghamton, N. Y.

I hope Mr. Satan will attend to that, when Mr. Gage quits this earth.

EDITOR.

## BOOKS BY G. O. SHIELDS (COQUINA)

### THE BIG GAME OF NORTH AMERICA

Its Habits, Habitat, Haunts and Characteristics. How, When and Where to Hunt it. 8vo, 600 pages, 80 illustrations. Cloth, \$3.50; Half Morocco, \$5.00; Full Morocco, \$6.50.

### CRUISING IN THE CASCADES

A Narrative of Travel, Exploration, Amateur Photography, Hunting and Fishing, with Special Chapters on Hunting the Grizzly Bear, the Buffalo, Elk, Antelope, Rocky Mountain Goat, and Deer; also on Troutling in the Rocky Mountains; on a Montana Roundup; Life Among the Cowboys, etc. 12mo, 300 pages, 75 illustrations. Cloth, \$2; Half Morocco, \$3.

### AMERICAN GAME FISHES

How, When and Where to Angle for them. 8vo, 400 pages, 50 illustrations. Cloth, \$2.50; Half Morocco, \$4.

### HUNTING IN THE GREAT WEST

(Rustlings in the Rockies)

Hunting and Fishing Sketches by Mountain and Stream. 12mo, cloth. Over 300 pages. Illustrated. Price, 75 cents.

### THE AMERICAN BOOK OF THE DOG

The Origin, Development, Special Characteristics, Utility, Breeding, Training, Diseases and Kennel Management of all Breeds of Dogs. 8vo, 650 pages, 100 illustrations. Cloth, \$3.50; Half Morocco, \$5; Full Morocco, \$6.50.

### CAMPING AND CAMP OUTFITS

A Manual of Instruction for Young and Old Sportsmen. 12mo, 200 pages, 30 illustrations. Cloth, \$1.25.

### THE BATTLE OF THE BIG HOLE

History of General Gibbon's Engagement with the Nez Perce Indians in the Big Hole Basin, Montana, August 9, 1877. 12mo, 150 pages. Profusely illustrated. Cloth, \$1.

These books will be mailed, post-paid, on receipt of price, by the author.

G. O. SHIELDS

19 West 24th St., New York

# Some Rare Oppor- tunities

These goods are all new, and will be shipped direct from factory. Prices named are those at which manufacturers and dealers usually sell. Here is a good chance to get

A BOOK  
A GUN  
A CAMERA  
A TYPEWRITER  
A BICYCLE

FREE OF COST

Subscriptions need not all be sent at once. They can be sent in installments as taken and credit will be given on account. When the required number is obtained the premium earned will be shipped.

“Recreation”

19 West 24th Street  
New York

## To any person sending me

- ✦ TWO yearly subscriptions to RECREATION at \$1 each, I will send a copy of *Hunting in the Great West*, paper.
- ✦ THREE subscriptions at \$1 each, a copy of *The Battle of the Big Hole*, cloth.
- ✦ FOUR subscriptions at \$1 each, a copy of *Camping and Camping Outfits*, cloth.
- ✦ FIVE subscriptions at \$1 each, a copy of *Cruising in the Cascades*, cloth; or a Willsie Pocket Camera, valued at \$5. It makes a picture 2½x2⅝ inches and can be loaded with 24 cut films.
- ✦ SIX subscriptions at \$1 each, a copy of *American Game Fishes*, cloth.
- ✦ SEVEN subscriptions at \$1 each, a copy of *The Big Game of North America*, or of *The American Book of the Dog*, cloth.
- ✦ EIGHT subscriptions at \$1 each, a Pocket Kodak, made by the Eastman Kodak Co., and valued at \$5.
- ✦ TEN subscriptions at \$1 each, a single-shot Davenport Rifle; or a Bristol Steel Fishing rod, or a Yawman and Erbe Automatic Reel, worth \$9; or a Kenwood Sleeping Bag, worth \$10; or a No. 10 Gramophone, worth \$10.
- ✦ TWELVE subscriptions at \$1 each, a Manhattan Improved Hand Camera, made by the Manhattan Optical Co., and valued at \$12.
- ✦ FIFTEEN subscriptions at \$1 each, a Davenport Single-barrel, breech-loading Shotgun, worth \$15; or a Premo D Camera, worth \$6 to \$10; or a Kenwood Sleeping Bag, complete with canvas cover, worth \$16; or a No. 2 Bullet Camera, loaded, worth \$10.
- ✦ TWENTY subscriptions at \$1 each, a 14-karat Gold Hunting-case Watch, with Elgin Movement, worth \$20; or a Marlin Repeating Rifle, listed at \$20; or an Improved Night-hawk Hand Camera, made by the Manhattan Optical Co., and valued at \$25; or a No. 4 Bullseye Camera, made by the Eastman Kodak Co., and worth \$12; or a Premo B Camera, worth \$16.
- ✦ TWENTY-FIVE subscriptions at \$1 each, a No. 4 Bullet Camera, made by the Eastman Kodak Co., and worth \$18; or a Gramophone, valued at \$25.
- ✦ THIRTY-FIVE subscriptions at \$1 each, a Forehand or a Syracuse Double-barrel Hammerless Breech-loading Shotgun, worth \$35; or a Premo A Camera, worth \$25.
- ✦ FORTY subscriptions at \$1 each, a Premo Sr. Camera, worth \$30.
- ✦ FIFTY subscriptions at \$1 each, a Marlin Rifle, with fancy curled walnut stock, pistol grip, checkered four-end, handsomely engraved, half octagon, half magazine, with take down, listed at \$50.
- ✦ SEVENTY-FIVE subscriptions at \$1 each, a Safety Bicycle, worth \$85 to \$100; or a Bo-peep Camera, for 5x7 plates, made by the Manhattan Optical Co., and valued at \$90.
- ✦ EIGHTY subscriptions at \$1 each, a Premo Sr. Camera, worth \$65.
- ✦ ONE HUNDRED subscriptions at \$1 each, a fine Lefever Hammerless Gun, worth \$85; or a Bo-peep Camera, for 6½x8½ plates, made by the Manhattan Optical Co., and valued at \$120.

# “THE LITTLE FINGER DOES IT”

The Fisherman's Automatic Reel

## THE AUTOMATIC REEL

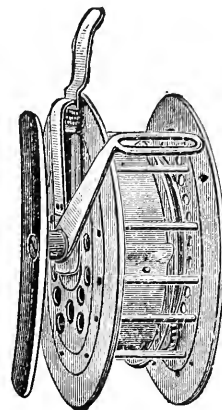

Manufactured by  
**YAWMAN & ERBE**  
344 No. St. PAUL Street,  
ROCHESTER, N. Y. U. S. A.



### What we claim for the Automatic Reel

**First**—It will wind up the line a hundred times as fast as any other reel in the world.

**Second**—It will wind up the line slowly if the angler chooses.

**Third**—No fish can ever get slack line with it.

**Fourth**—It will save more fish than any other reel.

**Fifth**—It will prevent tips, lines, and snells from being broken by large fish.

**Sixth**—The reel is manipulated entirely by the hand that holds the rod.

**Seventh**—It enables the angler and makes it desirable to use lighter tips.

SEND FOR CATALOGUE

# The Big Game

## OF North America

ITS HABITS, HABITAT, HAUNTS, AND CHARACTERISTICS

HOW, WHEN, AND WHERE TO HUNT IT

A Book for the Sportsman and the Naturalist

EDITED BY

G. O. SHIELDS ("COQUINA")

AUTHOR OF "CRUISING IN THE CASCADES," "RUSTLINGS IN THE ROCKIES," "HUNTING IN THE GREAT WEST," "THE BATTLE OF THE BIG HOLE," "CAMPING AND CAMP OUTFITS," ETC.

8vo, 600 Pages, 80 Illustrations.

Cloth, \$3.50; Half Calf, \$5.00; Full Morocco, \$6.50.

### CONTENTS

- |                                                                                                                                                                                                                                                                                                                                                                                                                                                                                                                                                                                                                                                                                                                                                                                                                                                                                                                                                                                                                                 |                                                                                                                                                                                                                                                                                                                                                                                                                                                                                                                                                                                                                                                                                                                                                                                                                                                                    |
|---------------------------------------------------------------------------------------------------------------------------------------------------------------------------------------------------------------------------------------------------------------------------------------------------------------------------------------------------------------------------------------------------------------------------------------------------------------------------------------------------------------------------------------------------------------------------------------------------------------------------------------------------------------------------------------------------------------------------------------------------------------------------------------------------------------------------------------------------------------------------------------------------------------------------------------------------------------------------------------------------------------------------------|--------------------------------------------------------------------------------------------------------------------------------------------------------------------------------------------------------------------------------------------------------------------------------------------------------------------------------------------------------------------------------------------------------------------------------------------------------------------------------------------------------------------------------------------------------------------------------------------------------------------------------------------------------------------------------------------------------------------------------------------------------------------------------------------------------------------------------------------------------------------|
| <p>Introduction. By the Honorable John Deau Caton, author of "The Antelope and Deer of America," etc.</p> <p>Moose Hunting in the Rocky Mountains. Newton Hibbs ("Roxey Newton").</p> <p>Elk Hunting in the Olympic Mountains. W. A. Perry ("Sillalicum").</p> <p>The Wapiti (Poem). By "Wah-bah-mi-mi."</p> <p>The Caribou. By William P. Lett ("Algonquin") and Dr. R. B. Cantrell.</p> <p>The Mule Deer. Rev. Joshua Cooke ("Boone").</p> <p>The Mule Deer of Southern California. T. S. Van Dyke, author of "The Still Hunter," etc.</p> <p>The Columbia Black-tail Deer. Thomas G. Farrell.</p> <p>The Virginia Deer. Walter M. Wolfe ("Shoshone").</p> <p>A Deer Hunt (Poem). "Wah-bah-mi-mi."</p> <p>Hunting the Grizzly Bear. Rev. Dr. W. S. Rainsford.</p> <p>The Polar Bear. Sergt. Francis Long, of the Greely Arctic Expedition, and George S. McTavish, of the Hudson Bay Company.</p> <p>A Polar Bear Hunt.</p> <p>The Black Bear. Col. Geo. D. Alexander.</p> <p>The Buffalo. Orin Belknap ("Uncle Fuller").</p> | <p>The Musk Ox. "Sergt. H. Bierdebick, of the Greely Arctic Expedition.</p> <p>Still-hunting the Antelope. Arthur W. du Bray ("Gaucho").</p> <p>Coursing the Antelope. M. E. Allison.</p> <p>The Death of Venus (Poem). Wm. P. Lett.</p> <p>The Rocky Mountain Goat. John Fannin.</p> <p>The Rocky Mountain Sheep. G. O. Shields ("Coquina").</p> <p>The Peccary. A. G. Requa.</p> <p>The Cougar, or Mountain Lion. W. A. Perry ("Sillalicum").</p> <p>The Lynx. J. C. Natrass.</p> <p>The Wild Cat. Daniel Arrowsmith ("Sangamon").</p> <p>The Wolf. Wm. P. Lett.</p> <p>The Wolverine. C. A. Cooper ("Sibyllene").</p> <p>Coon Hunting in Southern Illinois. Daniel Arrowsmith ("Sangamon").</p> <p>Fox Hunting in Virginia. Dr. M. G. Ellzey.</p> <p>Alligator Shooting in Florida. Cyrus W. Butler.</p> <p>The Ethics of Field Sports. Wm. B. Leffingwell.</p> |
|---------------------------------------------------------------------------------------------------------------------------------------------------------------------------------------------------------------------------------------------------------------------------------------------------------------------------------------------------------------------------------------------------------------------------------------------------------------------------------------------------------------------------------------------------------------------------------------------------------------------------------------------------------------------------------------------------------------------------------------------------------------------------------------------------------------------------------------------------------------------------------------------------------------------------------------------------------------------------------------------------------------------------------|--------------------------------------------------------------------------------------------------------------------------------------------------------------------------------------------------------------------------------------------------------------------------------------------------------------------------------------------------------------------------------------------------------------------------------------------------------------------------------------------------------------------------------------------------------------------------------------------------------------------------------------------------------------------------------------------------------------------------------------------------------------------------------------------------------------------------------------------------------------------|

The Hon. John Deau Caton, the eminent naturalist and jurist, author of "The Antelope and Deer of America," etc., says of this work:

"Altogether, there is given here such a study of the natural history of our game quadrupeds, and of the thrilling incidents encountered in hunting them, as has never before been offered to the reading world. Each chapter in this book is in itself a complete work, and the book, as a whole, is a most valuable library.

"Any one of the names on Mr. Shields' list of contributors should insure the sale of an entire edition of his book, and when we multiply this possibility by twenty-six, the whole number of names on his title-page, the result obtained indicates the magnitude of the success that should, and that we hope will, crown his labors and those of his collaborateurs."

"This sumptuous volume, profusely and elegantly illustrated, written by a score or more of sportsmen, is a very captivating book. No single writer could have had all the experiences here narrated. The descriptions and incidents cover every variety of large game on the continent. \* \* \* \* \* The stories are as excellent in their variety as in their quality. There are no dull chapters in the book. In fact, it may be said it is the finest collection of hunting stories ever published."—*Chicago Inter-Ocean*.

"This is one of the best and most valuable of the books as yet written or edited by Mr. Shields. It comprises a collection of intelligently written monographs on all the various kinds of big game to be found in North America, from the grizzly to the polar bear, and from the Virginia deer to the Rocky Mountain goat. Each writer speaks from his own experience, tells what he has done and seen, and recounts the often thrilling incidents he has met with in hunting. All the contributors to the volume are well-known writers on field sports and hunting, and each one writes of a species of game he has studied for years in the field, on the mountain, or in the forest."

"The paper on the Rocky Mountain sheep is by the Editor, and is a fine account of the wildest, wariest, and most difficult animal to hunt on the continent. Mr. Shields is a most enthusiastic sportsman, and moreover, wields the pen of a ready writer, as indeed all these sportsmen do, so that one follows him in his adventures with almost breathless interest.

"From beginning to end and in every chapter this book is positively fascinating."—*Chicago Herald*.

*This book will be mailed, post-paid, on receipt of price by the editor.*

G. O. SHIELDS, 19 West 24th Street, New York

Also given as a Premium for 7 Subscriptions to Recreation



# ANOTHER WINNER

Made by Mr. Walter Winans, at the North London Rifle Club, London, England, 9 shots at 30 yards, target actual size, Smith & Wesson 45 calibre revolver and U. M. C. cartridges. The best 9-shot 30-yard revolver score as to string measurements for England.

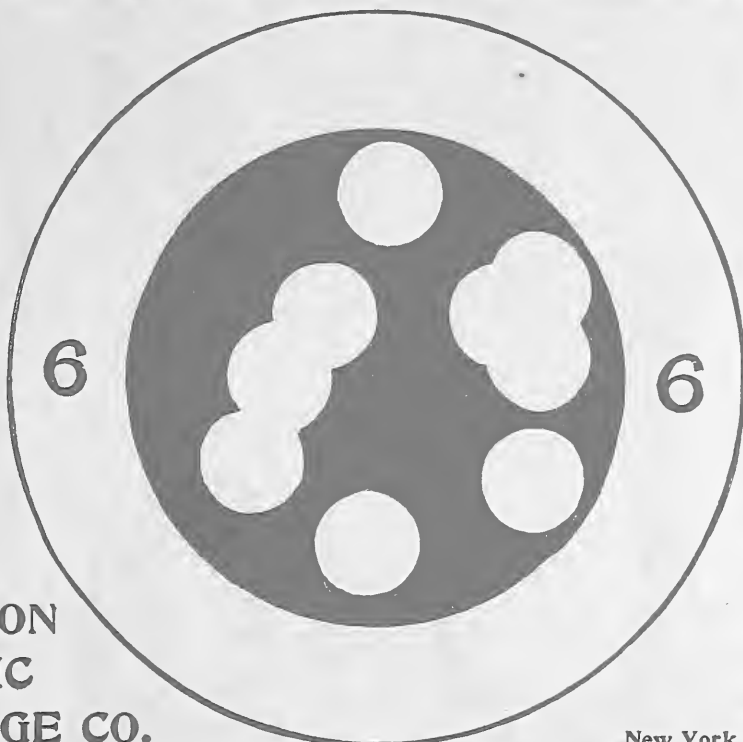

**THE UNION  
METALLIC  
CARTRIDGE CO.**

**FACTORY:**  
Bridgeport, Conn.  
**AGENCIES:**  
New York and San Francisco

**SCORE**

# Remington

## HAMMERLESS DOUBLE BARREL SHOT GUNS

Grade A.  
Price, \$45.00

Grade A.  
Price, \$45.00

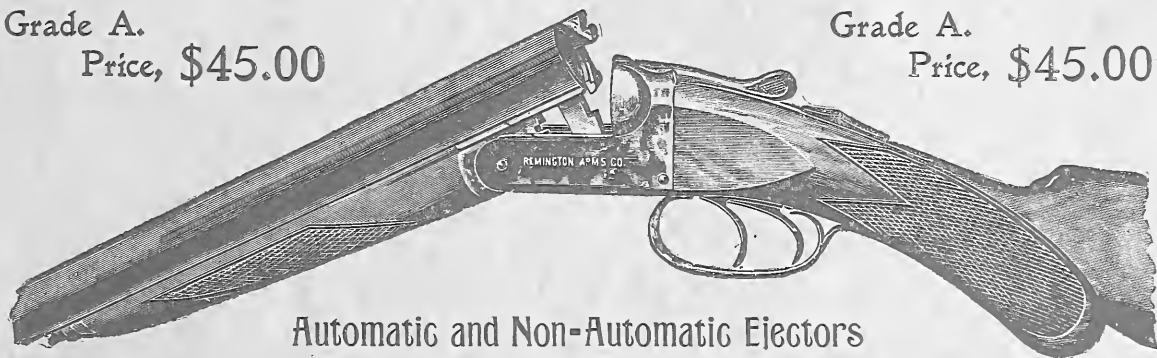

Automatic and Non-Automatic Ejectors

Guaranteed for Nitro Powders and free from all imperfections. Twelve different Grades, from \$45.00 up to \$230.00. All grades have Damascus Barrels, English Walnut Stock, Case Hardened Frame, Automatic Safety, Purdy Fore-end Snap, Triple Bolt, Top Snap Extension Rib with Bite, Flat Matted Rib.

**REMINGTONS**  
ARE SOLD BY ALL DEALERS

Send for Illustrated Catalogue

**THE REMINGTON ARMS CO.**

New York Office, 313-315 Broadway

ALBANY, N. Y.

IT WILL GO IN YOUR TRUNK

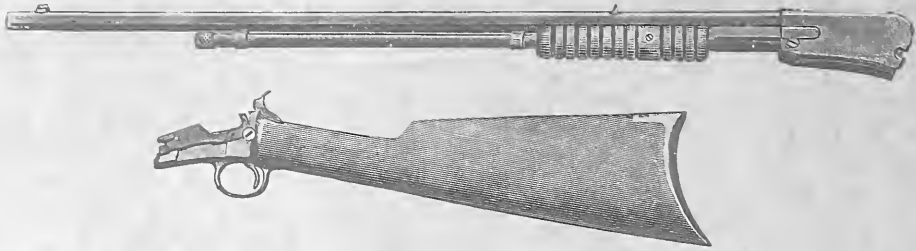

## A Winchester. 22 Caliber Repeater

JUST THE GUN TO TAKE INTO THE COUNTRY

The Winchester Model '90 is made for 22 Short, 22 Long, and 22 Winchester Rim Fire Cartridges. It can be taken apart and put together again in an instant, without any tools. Weight, 5½ lbs. List price, \$16.00. It is

ACCURATE — LIGHT — HANDY

**FREE** Send your name and address on a postal card and we will send you, free, our new 136-page illustrated catalogue, describing all the guns and ammunition manufactured by the

WINGHESTER REPEATING ARMS GO., New Haven, Conn.

STORES—312 Broadway, New York 418-420 Market Street, San Francisco, Cal.

## FIGURING UP.



Feb. 15th. Mr. A. buys from the "agent" a "Reputation" bicycle, listed at \$100.00. He pays cash and gets it at \$85.00, "good value, good wheel."

June 15th. Mr. B., an "influential" rider, buys same make from factory "for his own use," pays cash, and gets it at \$65.00; better value, same wheel.

Mr. B. has profited at the expense of the agent and Mr. A. The factory averages a profit. The average cash price on "Reputation" wheel was \$75.00. Why not put that price on, and sell at one price the entire season, treat all alike, and sell an

honest bicycle at an honest price?

## NEW CLIPPERS

are sold at the same price July 15th as January 15th. We make no excuses. Our goods

## ARE THE BEST

we can make with nearly 10 years' experience. We do not discriminate. One buyer's money is as good as another's. Our net prices are honest; our

## WHEELS

cost as much to make as those with "advertised reputations." The equal of a Clipper is not sold at the price of a Clipper.

MADE BY

**THE CLIPPER PEOPLE,**

GRAND RAPIDS, MICHIGAN.

# "Fenton"

## BIKES

are an education in the development of cycle construction. They have improvements not found on any other make.

Send for Catalogue

**Fenton Metallic Mfg. Co.**  
Jamestown, N. Y.



NEW YORK AGENTS

C. M. MOSEMAN & BRO.  
126-128 CHAMBERS ST.

# RECREATION



AMATEUR PHOTO BY J. W. ROWLEY  
KING OF GAME BIRDS

PUBLISHED BY G. O. SHIELDS (COQUINA)  
19 WEST 24TH ST. NEW YORK



*By permission of A. P. Yates, Syracuse, N. Y.*

A RAYFILTERGRAPH

The above reproduction of a picture made with . . . .

## BAUSCH & LOMB OPTICAL CO.'S BICHROMATE RAY FILTER.

is a specimen illustration from their brochure "Rayfiltergraphs," which not only contains much valuable information for photographers, and numerous fine rayfiltergraphs, but is mailed FREE by addressing "Dept. O" of above Company, ROCHESTER, N. Y.

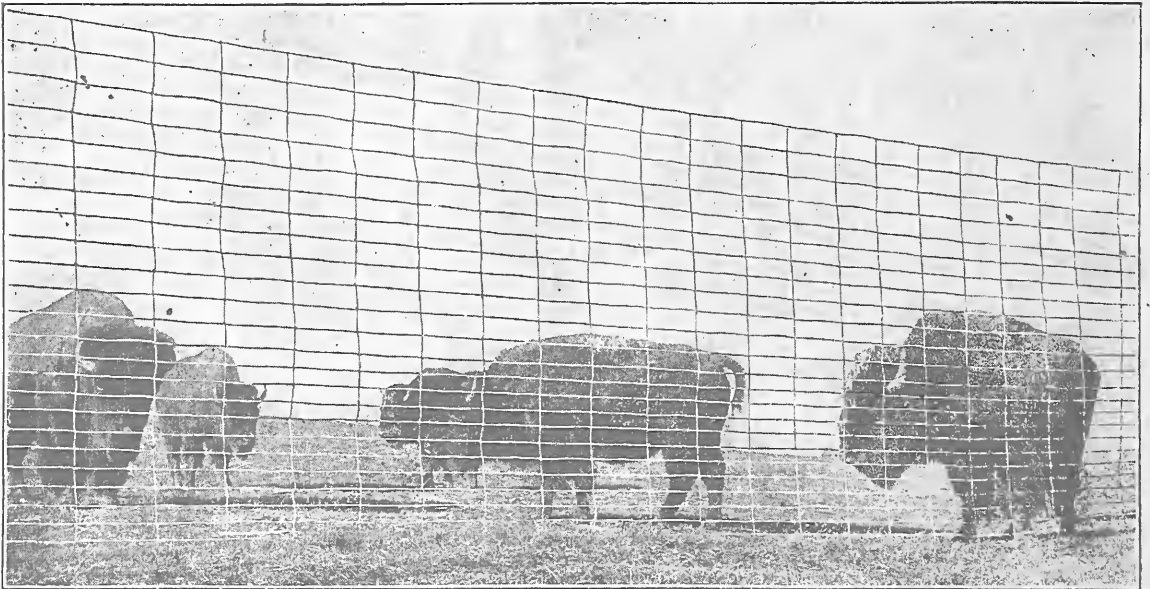

**STOP THE GAME!!! KILL THE UMPIRE?**

**NO!** Simply build a PAGE FENCE around the premises and you've got 'em. No obstruction to the view. Holds Buffalo, Deer, Elk, anything.

Write for Particulars . . . .

**PAGE WOVEN WIRE FENCE CO.**

ADRIAN, MICH.

# RECREATION

Copyright, December, 1896, by G. O. Shields

A Monthly Magazine Devoted to Everything the Name Implies

\$1.00 A YEAR.  
10 CENTS A COPY.

G. O. SHIELDS (COQUINA),  
Editor and Manager.

19 WEST 24TH STREET,  
NEW YORK.

## CONTENTS OF THIS NUMBER

|                                                                              | PAGE                                               |
|------------------------------------------------------------------------------|----------------------------------------------------|
| "Therefore I Jumped it."—Frontispiece .....                                  | BERT CASSIDY                                       |
| How They Didn't Hit Him in the Eye .....                                     | J. B. JENNETT 171                                  |
| "When Diana Gets Her Gun." (Poem) Illustrated.....                           | STERN RAKOFF 174                                   |
| Work of the Swine. Illustrated.....                                          | J. D. P. 175                                       |
| An Autumn Horseback Trip. Illustrated.....                                   | J. F. GORDON 176                                   |
| The Opening of the Season.....                                               | R. B. BUCKHAM 179                                  |
| A Cycle Race, with a Sequel.....                                             | Miss C. H. THAYER 182                              |
| The Music of the Woods. (Poem).....                                          | J. D. CRAWFORD, JR. 183                            |
| Echoes in the Moonlight. (Poem).....                                         | MARGUERITE TRACY 185                               |
| A Yale-Princeton Football Game.....                                          | COURTLAND NIXON 186                                |
| Ruffed Grouse and Woodcock.....                                              | U. B. 189                                          |
| Our Alaskan Exploring Expedition. Canoeing on the Stickeen. Illustrated..... | A. J. STONE 190                                    |
| Catching a Tartar .....                                                      | CAPT. J. G. LEEFE, U.S.A. 192                      |
| A Canoe Trip to Rainy Lake .....                                             | HARRY SILVER 195                                   |
| The King of the Gaulies.....                                                 | MARK T. LEONARD 197                                |
| Elkland. Illustrated.....                                                    | ERNEST SETON THOMPSON 199                          |
| The Bear, the Belle, and the Blackberries.....                               | FRANCES WEBSTER 202                                |
| A Boating Song. (Poem).....                                                  | E. W. MASON 204                                    |
| How We Photographed the Wild Cat.....                                        | COYOTE BILL 205                                    |
| The Wolf Question .....                                                      | R. M. ALLEN, R. ASHWORTH, and Dr. FRANK DUNHAM 207 |
| The Broadway Cable Sings. (Poem).....                                        | MARGUERITE TRACY 210                               |
| My Recreation. (Poem).....                                                   | HON. S. B. McMANUS 232                             |
| From the Game Fields.....                                                    | 211   <b>Bicycling</b> ..... 241                   |
| Fish and Fishing.....                                                        | 224   <b>Game Notes</b> ..... 245                  |
| Guns and Ammunition.....                                                     | 229   <b>Amateur Photography</b> ..... 247         |
| Natural History.....                                                         | 233   <b>Publisher's Department</b> ..... 250      |
| Editor's Corner.....                                                         | 238                                                |

Entered as Second-Class Matter at New York Post-Office, Oct. 17, 1894.

HR 1857 HR 1897 HR NEW YORK HR LONDON HR 1857 HR 1897 HR



YOU have confidence in things which  
 have stood a real test of years?  
 Then you must have faith in

Sozodont

With our grandparents it was the favorite family dentifrice. To-day it is no less a favorite. Back of this there must be reasons. What they are you can best determine by a trial of this famous dentifrice.

A sample for three cents (postage) if you mention this publication. Address the Proprietors of SOZODONT, Messrs. HALL & RUCKEL, NEW YORK.

HR 1857 HR 1897 HR NEW YORK HR LONDON HR 1857 HR 1897 HR

Ride a Monarch and keep in front.

MONARCH

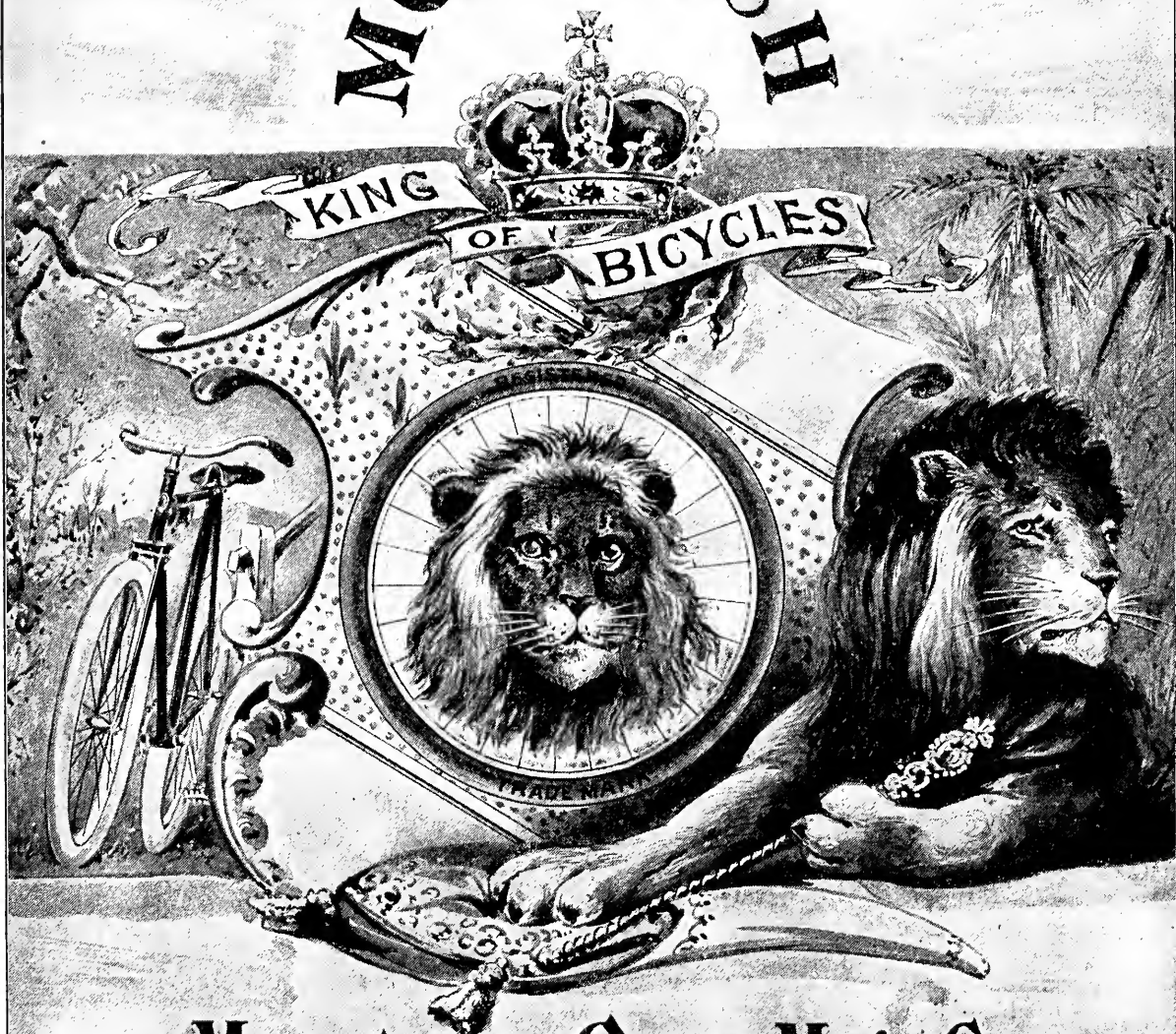

MONARCH CYCLE MF'G CO.  
CHICAGO.

CHICAGO.

NEW YORK.

LONDON.

SEND FOR 40 PAGE ART CATALOGUE



## The "Bristol" Lectures

Every angler knows what "backbone" means—as applied to a fishing rod—the power to withstand a severe strain, **and recover from it.** It is safe to assert there was never a wooden rod made that would not take a "set"—making it an eyesore, and rendering it entirely unfit for casting.

### THE BRISTOL STEEL FISHING RODS

are equal to any strain, and always return to the same straight form as when new. The "Bristol" is made in 17 different styles and sizes—weighing  $6\frac{1}{2}$  to  $11\frac{1}{2}$  oz.—and the reduction in prices for '97 (owing to improved facilities) brings the "Bristol" within the grasp of any man who knows what a rod should be.

*Send for Catalogue "R" to*

**The Horton Manufacturing Company**

**BRISTOL, CONN.**

THE REPEATER WITH THE SOLID TOP

# The Marlin Model 1897



IS A



22 CALIBRE

TAKE DOWN

Model 1897 Rifle Apart

This uses in one rifle the 22 short, 22 long and 22 long rifle cartridges, black and smokeless



We have endeavored to make this the best 22 calibre rifle ever made, and it is.



Weight only 5 1-2 pounds



Action finely finished inside and outside

The Receiver is made of our "Special Smokeless Steel," same as used in our Smokeless Rifles.

The working parts are of tool steel. This insures a perfect working rifle and a permanent adjustment.

Barrel gracefully tapered, with elevating rear, and German silver for sights.

Easy to clean. No single shot can be more conveniently cleaned.

Simplest to take apart.

Send · for · Catalogue

## THE MARLIN FIRE ARMS CO.

New Haven, Conn.



# The Model 1893

is the rifle using the 30-30 Smokeless Cartridge. This cartridge as made for our rifle is loaded with 32 grains of Military Smokeless Powder, giving a velocity of 2,000 feet per second, a full 2,000, not 100 or so less. This, with our flat pointed bullet, makes as accurate a 30 calibre cartridge as can be loaded, and also one without a superior for hunting purposes.

## THESE ARE THE FACTORY CARTRIDGES



Full Metal Cased Bullet  
(For Target Purposes)

Soft Pointed Bullet  
(For Hunting Use)



Six grains of  
smokeless powder  
100-grain  
bullet



For Short Ranges

The Barrel and Action of this rifle are made of our

## Special Smokeless Steel

guaranteed to stand the highest pressure. We also use this steel in all the rest of our Model 1893 Rifles, viz., 25-36 Smokeless, 32-40 and 38-55, and also in the Model 1895 taking the 38-56, 40 and 45 calibre cartridges. We are determined to have our rifles just as strong and safe as good material can make an arm.

Our new catalogue is a veritable encyclopaedia of information regarding rifles, ammunition, etc. Free for the asking, but stamps will help pay postage.

## THE MARLIN FIRE ARMS CO.

New Haven, Conn.

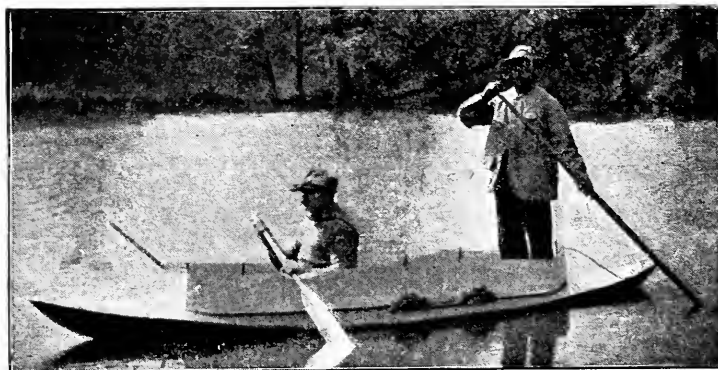

# Mullins' "Get There" Safety Ducking Boat

Fitted with grass blinds, making the most practical, durable, and seaworthy boat you can buy.

## LOW IN COST...

Always ready for use.

After a trial trip you will use no other.

Send for Catalogue

W. H. MULLINS, 228 Depot Street  
SALEM, OHIO

# The Megaphone



A NOVEL DEVICE  
FOR TALKING  
AT A DISTANCE

Will carry the voice distinctly two miles. Is used with great success by announcers at Athletic Meets, Fairs, etc. Is of great value at seashore and mountains. It is strongly made and there's nothing to get out of order.

PRICES AS FOLLOWS

48 in. \$5.00

36 in. \$4.00

30 in. \$3.50

Sent C. O. D. or on receipt of price

HARVEY & LEWIS, Opticians, Hartford, Conn.

## YOU CANNOT BRAG

about your cycling achievements unless a . . .

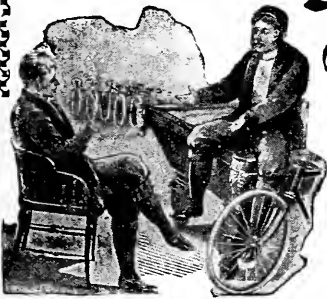

## Veeder CYCLOMETER

is on your  
Wheel.....



The Veeder has banished all other forms of Cyclometer, and its success has aroused imitations that resemble it only in appearance. Be sure your purchase bears the name that assures perfection—**VEEDER.**



Actual  
Size.

PRICE \$1.50.  
Weight, 1 oz.

VEEDER MFG. CO., Hartford, Conn

DUST-PROOF.  
WATER-PROOF.  
POSITIVELY  
ACCURATE.

AT ALL DEALERS.  
Booklet Free.

## A GREAT OFFER BY GERMANIA WINE CELLARS

HAMMONDSPORT and  
RHEIMS, N. Y.

In order to introduce our goods we make the following offer, good for the next thirty days only. Upon receipt of \$5.00 we will send to any sportsman or reader of RECREATION one case of our goods containing eleven bottles of wine and one bottle of our extra fine double-distilled Grape Brandy, all first class and put up in elegant style, assorted, as follows:

- 1 Quart Bottle Grand Imperial Sec Champagne
- 1 Quart Bottle Delaware
- 1 " " Riesling
- 1 " " Tokay
- 1 " " Sweet Catawba
- 1 " " Sherry
- 1 " " Elvira
- 1 " " Niagara
- 1 " " Angelica
- 1 " " Port
- 1 " " Sweet Isabella
- 1 " " Imperial Grape Brandy

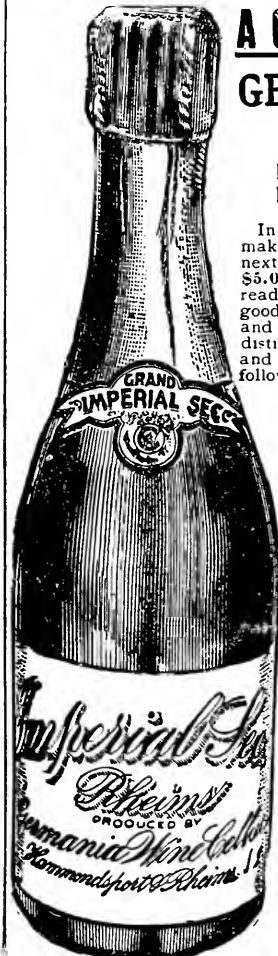

This offer is made mainly to introduce our Grand Imperial Sec Champagne and our fine double-distilled Grape Brandy, without which no Sportsman or Hunter should start on an expedition, as it is very necessary where such exercise is taken. This case of goods is offered at about one-half its actual cost and it will please us if our friends and patrons will take advantage of this and help us introduce our goods.



#### RECREATION'S GRIZZLY BEAR COMPETITION.

1st. The bear walked slowly by, at 25 yards. He was unconscious of my presence. I fired; he ran 50 yards and fell dead.

Where did I hit him?

2d. He walked slowly by, at 25 yards. I fired and he fell dead in his tracks.

Where did I hit him?

3d. He walked rapidly by, at 25 yards. I fired hurriedly, as he disappeared behind a rock. I took up the trail and found blood at every jump. I followed him 2 miles, but the blood finally ceased to flow. I lost the trail and never saw him again.

Where did I hit him?

These 3 shots are recorded on a copy of the above drawing, on file in this office, the location of each being shown by a black spot indicating the place where the ball entered. A yearly subscription to RECREATION will be given each person who will locate each of the 3 shots correctly.

Cut out the drawing, mark each shot by an X, followed by the number of shot, as X 1, X 2, X 3. Write your name and address on margin, and send in.

A number of the best solutions will be published, in November or December RECREATION together with the office drawing, showing the shots as already located.

Note 1.—Each bullet went through the bear, passing out exactly opposite the point at which it entered.

Note 2.—The rulings of the editor, and the location of the supposed shots must be, in a measure, arbitrary; yet they are based on a wide range of experience and on anatomical science.

# ROOT'S

## Camel Hair Underwear



Soft and velvety to the most sensitive skin  
 The best safeguard to health in our climate  
 For Men, Women and Children  
 The perfected result of years of experience

*Write for illustrated booklet.*

**ROOT MFG. CO., 1 Greene St., NEW YORK**

# ROOT'S

## Natural Wool Underwear

ROOT'S  
TIVOLI  
STANDARD  
UNDERWEAR  
TRADE MARK

RECREATION is the best magazine I ever read.  
 William Dasker, Robinsonburg, Quebec, Can.

RECREATION takes no steps backward.  
 James M. Graves, Potsdam, N. Y.

# GAS ENGINE & POWER CO.

and CHARLES L. SEABURY & CO., Builders of

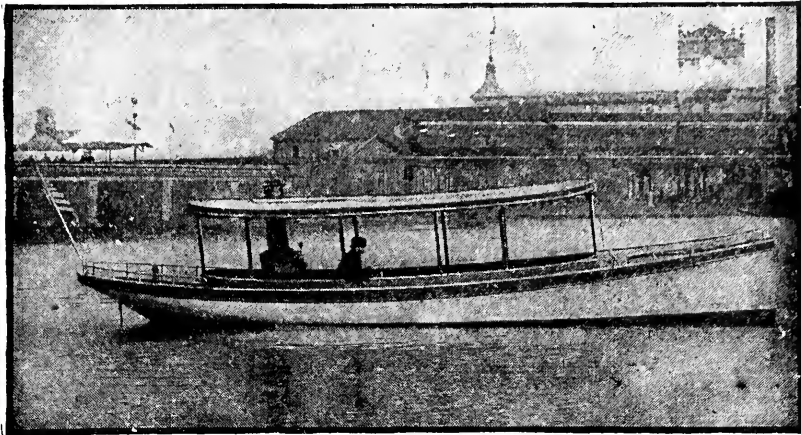

# The Only Naphtha ...Launch...

High-class Steam Yachts, Sail Yachts, Electric Launches, Dinghys, Gigs and Yacht Tenders, Seabury's Water Tube Boilers, Marine Engines

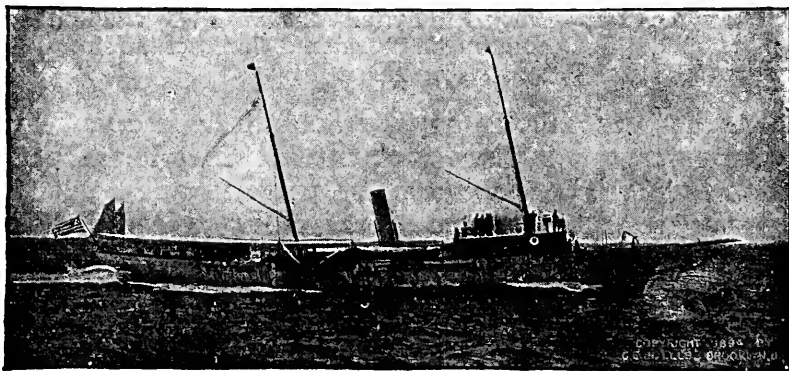

Storage Basin and Ship's ways. Overhauling of all kinds promptly done. Charters and Insurance. Boats bought and sold on commission . . . . .

CORRESPONDENCE SOLICITED . . . . .

Send ten cents in stamps for catalogues, to downtown office, 50 BROADWAY, or to factory at

MORRIS HEIGHTS, New York City

"One of the hits of the season."  
—*New York Commercial Advertiser*

"A rattling good story."  
—*Boston Herald*

"Delightful, without any mental reservations."  
—*New York Home Journal*



# THE MAN WHO BECAME A SAVAGE

A Story of Our Own Times, Our Own Country, and Borneo

BY WILLIAM T. HORNADAY

Author of  
"Two Years in the Jungle," "Taxidermy and Zoological Collecting," etc.

With 16 Half-Tone Illustrations by Chas. B. Hudson

A handsome crown octavo volume, 413 pp. beautifully printed, bound in full cloth with attractive side-stamp, in olive, gold and brown. Price, postpaid, \$1.50



This book will please readers of RECREATION because it is a story of action, of thrilling adventures, of forest life; because it is a good, clean story. Every woman likes this book because it demands justice for women—to whom justice is often denied.

"Mr. Hornaday's book can be described only as delightful, without any mental reservations. It bubbles over with amusing speeches and situations, and from the pretty dedication to his daughter, on through its more than four hundred pages, there is not a platitude or a monotonous line. No man with this handsome volume on his table can have any justification for moodiness, while those 'addicted to hysteria and weak tea' will find themselves lifted out of their gloom by the wonderful charm of the story-telling faculty here displayed."—*New York Home Journal*.

Mr. Hornaday, the author of this book, is a frequent contributor to RECREATION and a warm supporter of the doctrines it teaches. Thus far his life work has been that of a zoologist, traveler, and business man. For five years he traveled through the West Indies, South America, Europe, India, Ceylon, and Borneo, as a collecting naturalist, studying man and nature. For eight years he was connected with the United States National Museum, and National Zoological Park, at Washington. Five years were spent in business in Buffalo. He is now director of the great Zoological Park, which is being established in New York. His published writings include four books, many papers on zoological subjects, and stories and sketches in periodicals of many kinds.

"The Man Who Became a Savage," is a book of 413 pages. It is published at \$1.50, but I have bought a large edition of it, and can furnish it to new subscribers for RECREATION, or to those who renew their subscriptions within the next few months, at fifty cents a copy, postage paid. This is an opportunity rarely offered, and I hope many readers will take advantage of it.

"Recreation" One Year, and This Book, for \$1.50

If you get the IMPROVED

# GRAM-O-PHONE

You have an instrument which by actual test has completely filled the New York Metropolitan Opera House and which has been distinctly heard with a good volume, in the open air, for nearly half a mile.

Berliner's great invention itself was scarcely more marvelous in its inception than are the improvements to which it has been subjected during the past three months—improvements making it 1,000 per cent. better than ever before, and placing it in a class entirely alone. The GRAMOPHONE not only

## “TALKS TALK”

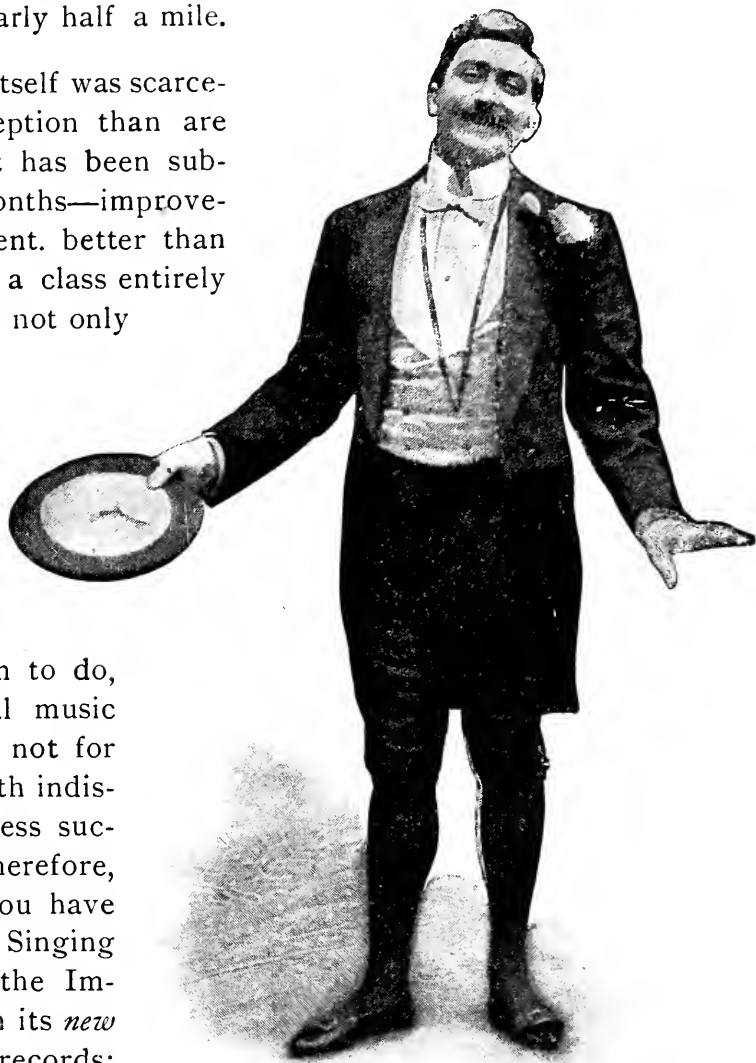

as no other machine ever began to do, but its songs and instrumental music are now genuine *reproductions*, not for a moment to be confounded with indistinct and feeble *imitations* by less successful methods. Do not, therefore, make the mistake of thinking you have ever heard a *real* Talking or Singing Machine till you have heard the Improved GRAMOPHONE, with its *new* sound-box, *new* motor, and *new* records; it is positively and pre-eminently without a rival.

MAURICE FORKOA  
Singing the French Laughing Song for the Gramophone.

This No. 25 Spring Motor Machine, which runs by clockwork, we send, express prepaid, with complete outfit for \$25.

PERFECT SATISFACTION GUARANTEED, or machine may be returned immediately. Money refunded, less express charges.

Other styles for \$10 and \$15. SEND FOR CATALOGUE.

FIRST-CLASS AGENTS WANTED

NATIONAL GRAMOPHONE COMPANY, 874 Broadway, New York

## Ask to hear the machine that “TALKS TALK”

# Genuine Siberian Moose Hunting, Golf or Walking Shoes

ABSOLUTELY WATER-PROOF TO THE TOP.

NOTHING SO GOOD EVER PRODUCED BEFORE AT ANY PRICE.

This is a **special** line of Boots and Shoes in every way. Special water-proof leather, special anhydrous soles, special lasts of new design, special stitching, special lining, in fact, every point of shoe worth has been studied to give each special value.

The result is a shoe as strong as steel, yet, pliable and soft as kid, graceful to the eye and easy on the foot, and will outwear any two ordinary shoes.

**The leather** is the famous Siberian Moose. Costs more than any other, and guaranteed water-proof.

**The color** is a dark Russia tan, so much in vogue.

**The soles** are of the best anhydrous oak stock, made water-proof by patented process.

**The stitching** will not rip. The bottoms are hand-sewed with Barbour's extra heavy water-proof flax. The uppers are stitched and then double-stitched with pure silk.

**Bellows tongues** of the best Moose stock are used, making the shoes water-proof to the top.

**The linings** are of finest russet calfskin, adding warmth and strength.

**English Backstays, extra heavy eyelets, "Bull Dog" toes, Pratt Fasteners, etc., etc.** Every approved shoe point will be found in them. **Price to all alike, \$7.50 net.**

**We also make** a short boot, 12 inches high, at **\$8.50**; a knee boot, "Hunter's Style," lacing up the front, at **\$10.00**, and a "Cavalry Style" boot at **\$12.00**, all with the same good points as the shoes.

Henry G.  
Squires & Son  
20 Cortlandt St.  
N. Y.



**\$7.50**  
net

The cut is a photograph of our tan walking shoe after having been worn two months.





# THE "ONEITA"

PAT. APL, 25<sup>TH</sup> 1893.

## Elastic Ribbed UNION SUITS

are complete undergarments, covering the entire body like an additional skin. Perfectly elastic, fitting like a glove, but softly and without pressure. No buttons down the front. Made for Men, Women, and Young People. Most convenient to put on or off, being entered at the top and drawn on like trousers. With no other kind of underwear can ladies obtain such perfect fit for dresses or wear comfortably so small a corset.



**ONEITA KNITTING MILLS,**

Send for illustrated booklet.  
ADDRESS DEPT. L

**Office: No. 1 Greene St., N. Y.**



**FOWLER CYCLE MFG. CO.**  
CHICAGO.

NEW YORK, BOSTON, PROVIDENCE, LONDON

Drop us a Postal for a '97 Catalogue.

**RED STAR BRAND.**

*Patented*

# Harderfold WONT Hygienic SHRINK Underwear

The Only Truly Hygienic Underwear Made.

**PHYSICIANS**

have accorded the most unanimous endorsement to the **HARDERFOLD UNDERWEAR**, and the theory upon which it is constructed, that any article of clothing has ever received. Over eleven hundred physicians, representing every state and territory in the Union, have united in testifying to the sanitary excellence of the HARDERFOLD system of underclothing. Two or more thin fabrics are lighter, warmer, and in every way better than heavy single fabrics.

**HARDERFOLD FABRIC CO., Troy, N. Y.**

*Send for Illustrated Pamphlet.*

# MENNEN'S

## BORATED TALCUM



TOILET  
POWDER  
AFTER  
BATHING

## MENNEN'S

BORATED TALCUM

# Toilet Powder

Approved by **Highest Medical Authorities and Nurses** as a perfect Sanitary Toilet preparation for infants and adults.

**WRITE FOR FREE SAMPLE**  
(Name RECREATION.)

Get **MENNEN'S** (the only genuine)

REFUSE ALL OTHER POWDERS, WHICH ARE LIABLE TO DO HARM.

Positively relieves Prickly Heat, Perspiration, Nettle Rash, Chapped Skin, Sunburn, etc., etc. Banishes all odor. Removes Blotches, Pimples, and Tan. Makes the skin smooth and healthy. Delightful after shaving. Sold by druggists or mailed for **25 cents**, to any address.

**GERHARD MENNEN CO., 500 Broad Street  
NEWARK, N. J.**



WAGSTAFF & CO. N.Y.

# WOODBURY'S FACIAL SOAP, FACIAL CREAM FACIAL POWDER and DENTAL CREAM

## THE GRANDEST TOILET COMBINATION KNOWN FOR THE SKIN, SCALP, COMPLEXION, and TEETH

Manufactured by Dermatologist John H. Woodbury, who has had twenty-six years' experience curing skin diseases and facial blemishes. The daily use of Woodbury's Facial Soap and Facial Cream will eradicate all oiliness and other imperfections of the skin, and render the complexion clear, soft, and beautiful. They are sold everywhere.

DOCTORS recommend Woodbury's Facial Soap for washing infants, and for ladies' all-around use it is matchless.

WOODBURY'S FACIAL SOAP is antiseptic.

AS WE NEVER KNOW when germs are around, the safe way is to use WOODBURY'S FACIAL SOAP whenever any washing is done.

It is HARD, and one cake will outlast two ordinary cakes of soap. WOODBURY'S FACIAL SOAP is cleansing, healing, and refreshing.

THEATRICAL PEOPLE find it excellent for washing off grease paint and make-up.

JOHN H. WOODBURY has had over 26 years' practical experience treating the complexion.

IF ANYBODY knows what is good for the skin, JOHN H. WOODBURY does.

FACIAL SOAP is an ideal shampoo.

AFTER A BATH with Facial Soap, nothing is so soothing, softening, healing, and cooling to the skin as an application of WOODBURY'S FACIAL CREAM.

WOODBURY'S FACIAL CREAM contains no gum, oil, or grease of any kind whatever.

THE HANDS can be gloved immediately after applying FACIAL CREAM; it is not in the least gummy or sticky.

WOODBURY'S FACIAL CREAM will keep fresh and sweet indefinitely.

WOODBURY'S FACIAL CREAM is a blossoming softer, healer, and beautifier.

WOODBURY'S FACIAL CREAM is unequalled for freckles, sunburn, eczema, and all mild cutaneous affections.

Woodbury's Dental Cream is endorsed by the dental profession, is fragrant, contains no grit to scratch the enamel off the teeth, and is put up in tubes, which makes it convenient to use at home or when travelling. Each tube will last from three to four months, is sold by all druggists and fancy goods dealers, or mailed on receipt of 25 cents.



FACIAL CREAM CAN BE freely used on the face and will absolutely not cause superfluous growth of hair.

NOTHING so quickly removes freckles, tan, or sunburn as an application of WOODBURY'S FACIAL CREAM.

THE HANDS, face, and mouth should be washed with WOODBURY'S FACIAL SOAP after exposure.

For inflamed eyelids rub in a little WOODBURY'S FACIAL CREAM. It gives immediate relief.

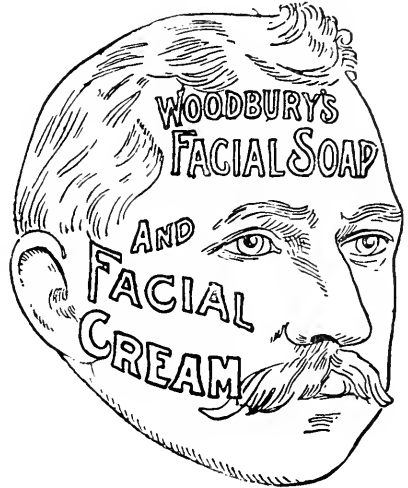

THE USE OF WOODBURY'S FACIAL CREAM will not only relieve the inflammation, but, if rubbed around the eyes, rub out the wrinkles.

To sum all up, WOODBURY'S FACIAL SOAP and FACIAL CREAM are the grandest combination on earth. PURE, ANTI-SEPTIC, MEDICINAL, they cleanse, purify, beautify, refresh, and preserve the Skin and Complexion of all humanity from the cradle up.

The John H. Woodbury Dermatological Institute was established twenty-six years ago, and is the largest establishment in the world for the treatment of skin diseases, facial blemishes, and featural deformities.

Twenty-three skilled physicians are constantly employed. Each is a specialist. Eczema, pimples, moles, and warts are successfully cured. Superfluous hair, freckles, and all blemishes removed permanently.

Rheumatism, neuralgia, sciatica, gout, and nervous diseases treated by Static Electricity without shock.

Woodbury's Facial Powder is harmless, contains nothing to irritate the skin, when used is invisible and will not cause blackheads, makes the skin transparent, is recommended by the theatrical profession, and sold by all dealers in toilet preparations, or mailed on receipt of 25 cents.

For 10 cents we will mail you a sample of either Woodbury's Facial Soap or Woodbury's Facial Cream, with 132-page illustrated book on beauty, containing many valuable toilet hints and treatment for the skin, scalp, and complexion.

For 20 cents we will send you by mail a trial package of each of Woodbury's Facial Soap, Facial Cream, Facial Powder, and Dental Cream, with illustrated book on beauty and how to improve the complexion.

## John H. Woodbury Dermatological Institute

Offices for the cure of Skin and Nervous Diseases, the removal of Facial blemishes, and correction of any Irregularities of the Ears, Nose, Mouth, or Eyes.

NEW YORK, 133 West 42d Street  
PHILADELPHIA, 1306 Walnut Street

BOSTON, 11 Winter Street  
CHICAGO, State cor. Monroe Streets

ADDRESS ALL CORRESPONDENCE TO 133 WEST 42D STREET, NEW YORK

Send for Catalog of.....

# VICTOR FOOTBALL GOODS

They are leaders for quality of material, fine workmanship, and improvements



## The Victor Intercollegiate Football

Is used and recommended by leading college players

(Examine our new model, pointed end ball, the latest shape)

The New Victor Face Mask and Head Protector  
has many advantages over the old style



We manufacture our own Football Shoes  
and can quote lowest prices

Special prices for team outfits furnished on application

## OVERMAN WHEEL CO.

Makers of Victor Bicycles

New York  
Denver

Boston  
San Francisco

Chicago  
Portland, Ore.

Detroit



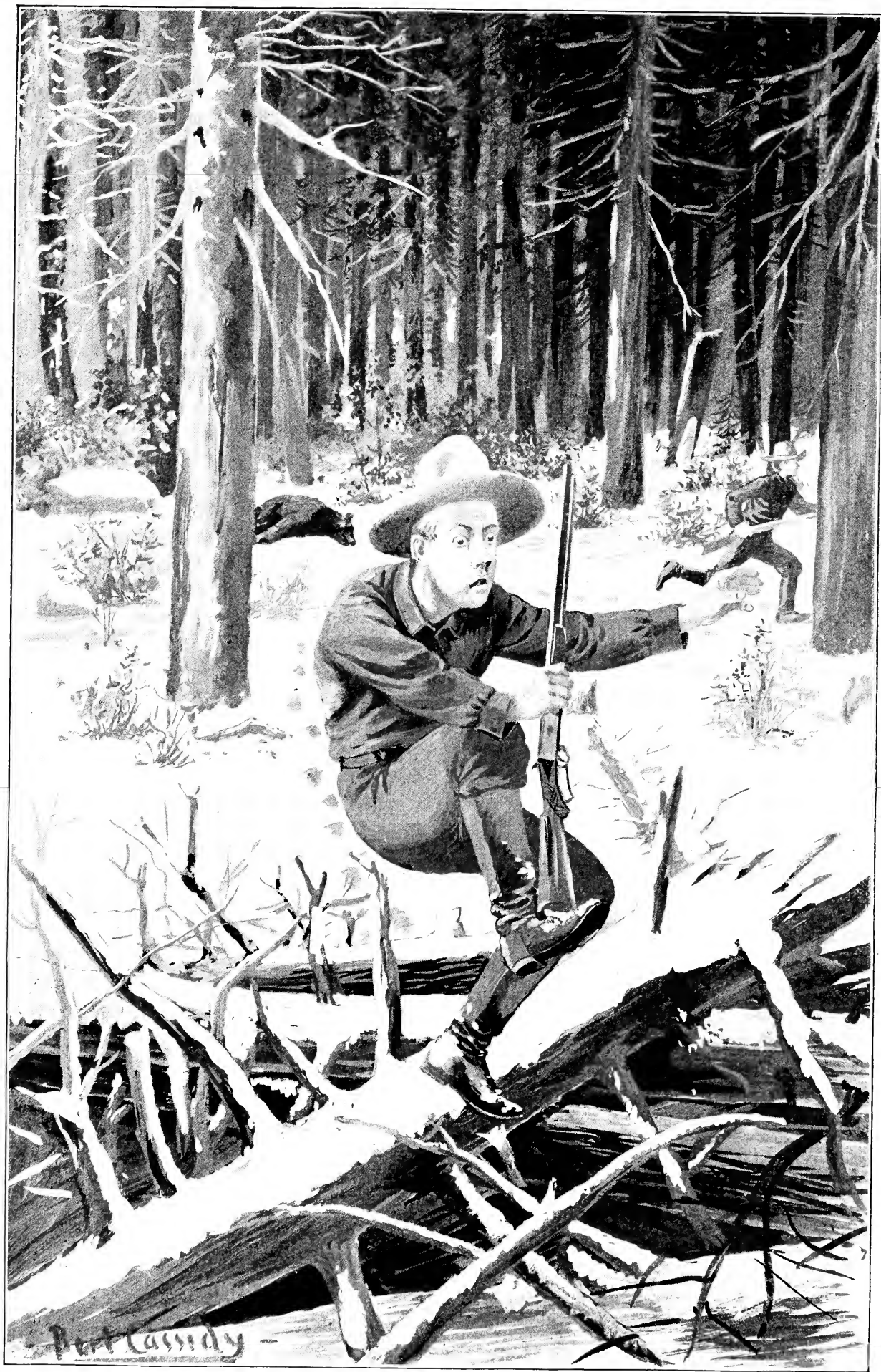

"THEREFORE I JUMPED IT."

# RECREATION.

Volume VII.

SEPTEMBER, 1897.

Number 3.

G. O. SHIELDS (COQUINA), Editor and Manager.

---

## HOW THEY DIDN'T HIT HIM IN THE EYE.

J. B. JENNETT (OLD SILVER TIP).

What vivid recollections will at times roll in upon us—even of the days (or nights) when we used to steal our neighbors' apples!

To-night there appears before my eyes the vision of my first bear. It seems as if the tragedy might have happened but yesterday, instead of many years ago.

I was up in the Northwest territory, and winter was close at hand. I had a little money and formed the acquaintance of 2 men who had none. They were AI bear hunters, while I was a tenderfoot; so of course I had to be initiated.

They told me all kinds of stories, some of which fairly set me wild. The result was I put in my money and we went into the Rockies, in British Columbia, to hunt bear. When we got to the trapping ground we put up our shack and then proceeded to build dead-falls for the next spring. By doing this in the fall, the men said that by the time spring came all the scent of our bodies would be gone; so it would be far easier to catch His Royal Highness than if the dead-falls were fresh made.

The talk of each evening was, of course, about bear, and what we would do when we met one. The "old hunters" told me, many times over, that they could hit a bear in the eye, when he was on the charge.

Our battery consisted of 2 45-75-350 Winchester rifles, belonging to

the "old hunters" while I had a 44-40-200 Winchester. This they called the "pop-gun"; but it made them pop in a way they did not like, one day.

Down below where we were camped, about 4 miles, there was an old bear hunter by the name of Aleck. His other name I never knew, for he would never tell it. He was either English or Scotch, and was a gentleman. I often thought that at some time he must have handled considerable money; that he had lost it and had then taken up a hunter's life. One thing certain: he knew what he was about when face to face with "Old Ephraim." Nearly every night, just before going to bed, I was cautioned that if we ever saw a bear I must not shoot at him with that "pop-gun." I had asked Old Aleck's opinion of the 44; but he would never give it. My mind was made up that, come what would, if I ever saw a bear, no matter what part—if only the tail—I was going to have the first shot. I looked at it in this light; that if the other 2 could hit a bear in the eye while charging, they were in no danger.

One morning we were going out to build a dead-fall. It had snowed about 2 inches during the night and we struck the fresh trail of Old Ephraim. I asked the other men what we should do. After a little talk we decided to follow it up. As we went along my faith was a little shaken in my pard.

If they were bear hunters why did they want to discuss a subject that we came into the woods to do—*i.e.* kill bears. Why not start on the trail as soon as found? That's what I kept thinking to myself, as we went along.

The bear led us a fine chase, up the side of a steep hill. Suddenly my pards stopped. We had found the bear. He was standing across the trail, right side to us, head turned toward us, nose slightly up in the air as if smelling us. I looked at my pards, and they were as white as the snow around us. There and then it went through my mind that they knew nearly as much about Old Ephraim as I did.

As for myself, well, I felt queer. My flesh seemed full of pins and needles. My blood ran cold. My heart seemed to stop beating. Of one thing I am certain. If I had not shut my mouth, like a No. 6 Newhouse steel trap, my heart would sure have jumped out; but as I kept my face closed my heart tried to beat its way out, by way of my ribs.

Of course you all know how quick a thought flies. On sizing up my pards up went the pop-gun and "pop" she went. So did I. I fired a snap shot for Old Ephraim's eye and never waited to see the result. I knew I could outrun either of the other men; and if not, what difference? They could hit him in the eye, while charging.

When I started on my 2 mile a minute gait, I heard the sound of hasty footsteps behind me, accompanied by a terrible string of oaths. Something sounded like "Hold on there!" But it made no difference in my gait. I was playing "Home, Sweet Home" with my feet. How true that old song seemed just then—"There's no place like home."

In the space of but a few seconds there was no sound to be heard, save the fall of my feet, as I chased them down the hill side, and the thumping of my heart against my ribs as if saying, "Run Joe, Run."

On reaching the shack I went in, without knocking, sat down on the lower bunk and then sized up the window opposite, and the large chimney on my right, with its smoking black log, to be sure which way would make the best back door if Old Ephraim came in at the front door. Suddenly I heard the fall of feet, outside, and in came the door, hinges and all, my pards tumbling over each other, to get in first. Scared as I was it made me smile.

Well, after a bit things quieted down. I wanted the men to come down to Old Aleck's with me, but they would not do it; so I went alone. As soon as I told the old man he put on a well worn belt, filled with 45-70-405 cartridges, and reaching up took down a 45 Sharp's rifle. His every action meant business. He never spoke a word but we started for our shack.

On reaching there it was too late to go up the hill that day, so Old Aleck listened to the tale of the bear hunt, at the end of which, if he didn't give my pards fits—oh no! Then I give it up. The next morning we followed my trail up the hill. At one place we found a pile of dead-falls as high as my breast. My trail showed I had not gone around or climbed over, as the soft snow on the top had not been touched. Therefore I had jumped it.

I don't remember much about the down trip. Of course I was not scared. I was only in a hurry to get home, for fear the bread might spoil. Then, to cap it all, on reaching the spot there was Old Ephraim. He had never followed us one step. The bullet had hit him square in the eye. Old Aleck looked at me and said,

"My boy, take my advice, and in future always see where your bullet goes, before you run."

And I have ever since followed his advice. It would be good advice for some other "hunters" to follow, too.

After getting the meat and hide home, I divided the grub with my pards, took up my residence with Old Aleck, and we got several bear, the following spring.





AMATEUR PHOTO BY F. E. MATTHEWSON.

**THE CAPTAIN OF THE LIBBIE.**

Awarded Fifteenth Prize in RECREATION'S Second Annual Photo Competition.

# WHEN DIANA GETS HER GUN.

By  
Stern Rakoff

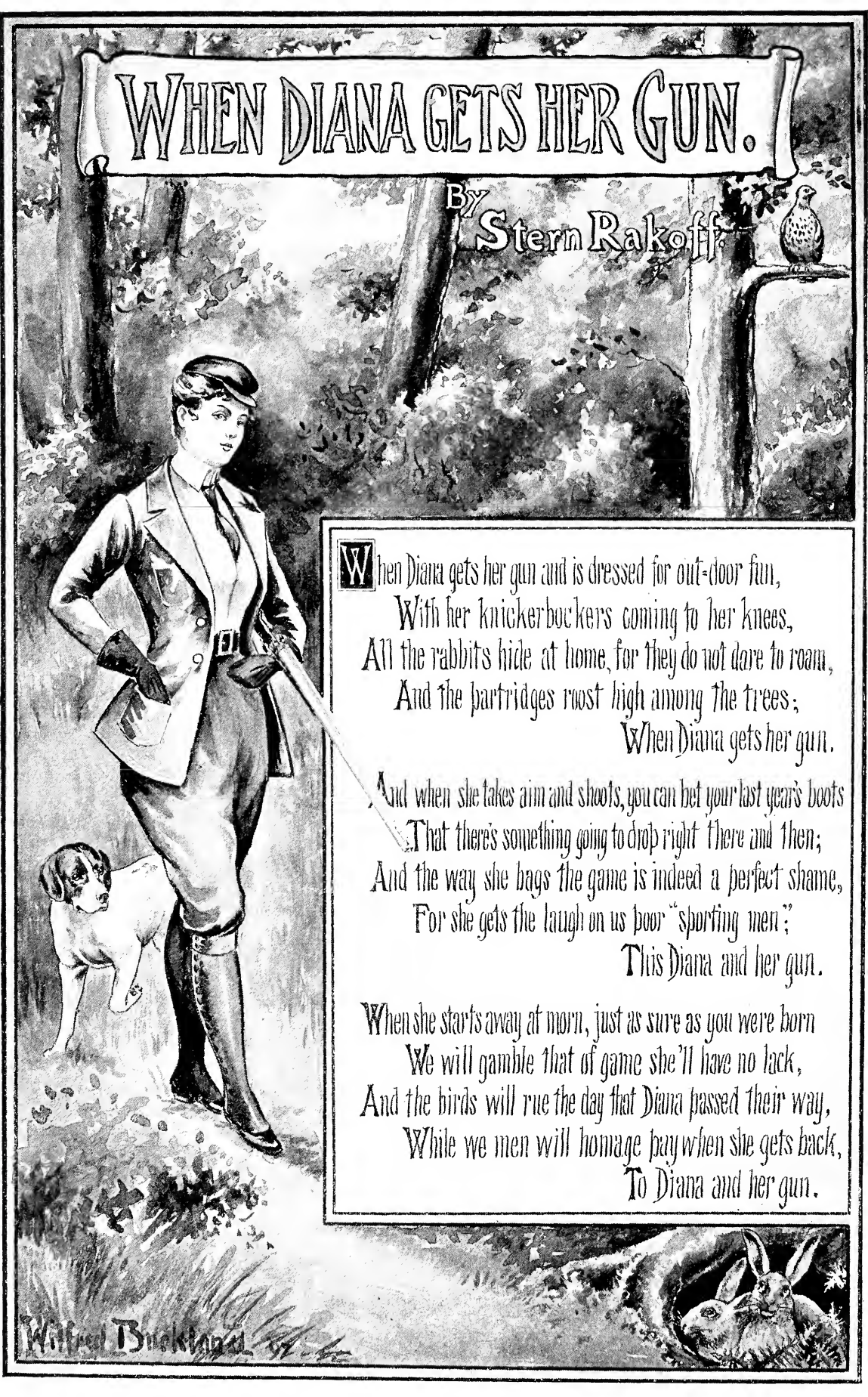

**W**hen Diana gets her gun and is dressed for out-door fun,  
With her knickerbockers coming to her knees,  
All the rabbits hide at home, for they do not dare to roam,  
And the partridges roost high among the trees;  
When Diana gets her gun.

And when she takes aim and shoots, you can bet your last year's boots  
That there's something going to drop right there and then;  
And the way she bags the game is indeed a perfect shame,  
For she gets the laugh on us poor "sporting men";  
This Diana and her gun.

When she starts away at morn, just as sure as you were born  
We will gamble that of game she'll have no lack,  
And the birds will rue the day that Diana passed their way,  
While we men will homage pay when she gets back,  
To Diana and her gun.

W. B. Buckland





## WORK OF THE SWINE.

Editor RECREATION: You are after hogs. So am I, when such a picture as this comes before me. One hundred and thirty-three king fish, arranged for their post mortem photograph, in such a delicate, feminine manner! The fellow in the fore-ground, with no chin, whose bullet head is covered by a yachtsman's cap, I will wager suggested the unsportsmanlike arrangement of the fish. He looks to be that kind. Note the "smiling josey," with spraddled legs, near the port main shrouds—the only other man wearing a cap. Is he a sportsman? Well I guess "nit!" A sportsman was never known to go fishing and bring home his pants with the crease down the front still intact!

The old gentleman who finds it necessary to steady himself by the main halliards, is all right. He doesn't pretend to be a sportsman and doesn't know any of the unwritten laws of sportsmanship. He is a jolly good fellow and undoubtedly furnished first class beer, for this trip, and got away with his full share. The belted gentleman, in white flannels and straw hat, looks as if he should know better, and I believe he does; but has made up his mind to brazen it out for the benefit of the no chinned chap beside him, to whom he probably owes a poker debt.

The one man who knows he has run into a bum crowd, and is heartily ashamed of them and of himself, but is honorable enough to take his share of the blame in a sportsmanlike manner, with the mental reservation that it shall never happen again, is the honest old soul to the right of the smiling josey. Shame is sticking out all over him; and the boys who run the boat are none too proud of their party.

Let me suggest to these men that if they will separately take a small boat, with an oarsman, arm themselves with a pair of light grains, each, and row over the king fish grounds endeavoring to spear or, technically, strike the king fish, they will get about 1,800 per cent. more fun out of the day's sport, kill fewer fish and will be thought of a great deal more kindly by their friends. There are a lot of people in this world to whom success means quantity, not quality.

I am familiar with this fish, and with all kinds of Florida fishing, and it sickens me to see such a brazen exposure, of such damnably hoggish waste of time and of good fish. You have my permission to refer to me any one desiring to take exception to my language.

J. D. P.  
Omaha, Neb.

## AN AUTUMN HORSEBACK TRIP.

J. F. GORDON.

After much planning to get away from business, we, Al., Rex., Harry and I, finally decided on a date for a horse-back trip from M——, N. Y., to Lackawaxen, up the Delaware river. We started late in the afternoon, going through Otisville and over the mountain, from which a good view of the Erie R.R.'s stone crusher, and a little farther down the road, a grand view of the surrounding mountains and valleys is obtained. This bit of scenery, as viewed from the window of a rapidly moving passenger coach, although fine, is but a taste as com-

150 feet below; and above, for almost the same distance, tons upon tons of rock overhang. The canal is so directly beneath that a hat could be tossed into it, and Harry cast a stone far out into the river. We were afterward told that when the road was first proposed, a great many people doubted whether it could be built and whether, in the springtime, it would not slide down the mountain; but the road is still there.

The game preserve of the McKenzie estate is near here. On reaching it we dis-



EN ROUTE.

pared with that obtained from the saddle, with time to stop and enjoy it fully. Continuing we wound down the mountain, through Cuddebackville. What a road for bicyclists! For miles it is as hard and smooth as a floor, with no "hills as are hills."

Passing the Standard Oil Co.'s pumping station, from which oil is forced over the mountain, we pushed on to Port Jervis, where we arrived just at dusk.

Early next morning we were off by way of the Hawk's-nest road which, in its way, is extremely interesting. It is built on the side of the mountain, which, at the highest point, is perpendicular. The road overlooks a narrow valley in which are the Erie R.R., the river and the D. & H. canal. The river and canal are, we judged, about

mounted and, looking through the fence, counted 17 elk—2 of which were bulls, with massive antlers. Either pair would be fine to have around, not only as an ornament, but useful for cherry picking or as a fire escape.

In another part was a species of foreign deer which none of us could identify, and there was no one about to tell us. They were entirely different from the American deer and were very beautiful.

After a dinner at Barryville, which is just across the river from the well known resort, Shohola Glen, we made for the Minisink battle ground. Our route took us through the woods over one of those delightful roads full of rocks, stumps, overhanging branches, etc. Here we flushed a pair of ruffed grouse, which, by the way, were the

only wild game we saw on the trip. Obtaining our final directions from 2 quarrymen working nearby, we rode through a pasture lot, up through the woods and on to the battle ground.

The spot, on which the last and most bloody part of the struggle occurred is the top of the mountain, quite level, about an acre in extent and commands a beautiful view of the surrounding country. We found Hospital Rock and traces of the old fortification.

Down the mountain from here is a dam in the river, the water thus stored being used to feed the canal. Here, too, the canal crosses the river, and, taking the tow-path, we crossed over into Lackawaxen. Al. receiving an expected telegram, we resumed the tow-path for Barryville where we spent the night.

On entering the village we overtook a fine, sleek pair of tow-mules. They had heard our clatter in the rear and, not being able to see us (having closed bridles) they took fright and one of them prepared to defend himself. Rex. and Al. were in the lead and got by all right, but at that

instant a pair of hoofs and a whistle-tree shot out and Harry and I had business right where we were. Here I could lie a little, but speaking with due regard for the truth, I counted 27 mule feet in the air at one time, all operated by the same mule, to say nothing of double trees, whistle-trees, chains, ropes, tug straps, etc. Concluding we were stalled indefinitely, Rex and Al. bade us good night; but noticing that the tow line lay on the ground we waited an opening and shot over between the canal and the other mule. The last we saw of his kicklets he was still "fanning space."

Early next morning we were on the tow-path again for home. We found the boatmen very good natured and obliging and exchanged a great deal of good natured chaff with them. Passing was sometimes quite difficult, but at such times they would cheerfully stop the teams to let us by. Our trip ended all too soon, and reaching M—— we separated, all wishing we were just starting instead of returning. In the 2 days we travelled 90 miles and hope to travel many more together.



AMATEUR PHOTO BY MRS. MYRA A. WIGGINS.

THE HUNTER'S PAUSE.

Joint Winner of First Prize in RECREATION'S Second Annual Photo Competition.



## WHITE AND YELLOW PERCH.

In this plate are shown 2 species of fishes which are not only of interest to the commercial fishermen, but to the angler as well. The Yellow Perch (*Perca flavescens*), often called the Ring Perch, from the dark bars crossing the body, is one of the most abundant and best known of the smaller food fishes. It is found in fresh water lakes and streams throughout the Eastern United States, from Nova Scotia and the Great Lakes Southward to North Carolina and Iowa and the Ohio. It is particularly abundant in the coastwise streams and the Great Lakes, also in the small lakes of many of the Northern States. In those of Northern Indiana, and Northwestern Iowa, it is very numerous. It reaches a length of a foot and a weight of over a pound. While it cannot rank as one of the great game fishes it is none the less popular on that account. It is always a source of delight to the children, and to ladies learning to fish, and even with many men. Many an expert angler does not refuse to fill his creel with yellow perch when better fish fail him. The yellow perch is a vigorous biter and fights well, for a little while. Moreover it is a most delicious pan fish, if you know how to prepare it.

The other species is the White Perch (*Morone americana*), a fish found abundantly along our Atlantic coast, from New England to Florida, ascending all coastwise streams. This fish reaches a length of a foot or less, and is easily caught on the hook, with any kind of bait. It is most abundant in the tidewater portions of the rivers and always bites best on the flood tide. It is a good food fish, but its chief

value lies in that it can always be caught, whether other fishes bite or not.

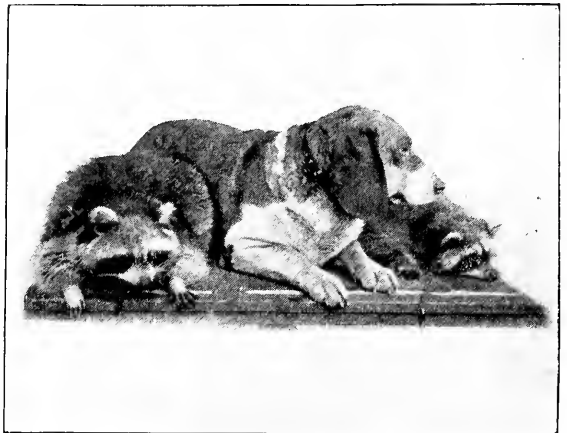

AMATEUR PHOTO BY SAM'L RANDALL.

## TWO COONS AND THE DOG THAT TREED THEM.

Highly Commended in RECREATION'S Second Annual Photo Competition.

You can get a gun, a fishing rod, a reel, a camera, a sleeping bag, a watch or a bicycle for nothing. Full particulars on page xlvi. of this issue.

A North Carolina newspaper has this local item:—

“As Colonel Williams was driving home yesterday, lightning struck his wagon and completely demolished a 4 gallon demijohn of fine whiskey. The Colonel has the sympathy of the community.”—Atlanta Constitution.

## THE OPENING OF THE SEASON.

R. B. BUCKHAM.

"She paints with white and red the moors,  
To draw the nations out of doors."

—EMERSON.

In autumn it seems as if Nature had designed that man should be constrained to go to the fields or the woods. Certain it is at this season she bedecks herself in her most attractive garb—royal purple, scarlet and gold; and indifferent indeed is he who can withstand her charms. Earth and sky are mellow with ripeness; the very air sparkles; while tree and bush and shrub seem striving to outdo each other in showering down their golden harvest. Simply to be abroad at such a time is a pleasure indeed; but to the sportsman this time brings other joys as well. It is then the ruffed grouse, king of game birds, throws down the gauntlet to the gunner, challenging him, with startling whirl of wing, to a trial of skill and endurance; to a test of woodcraft.

To outwit the wily bird is not always an easy task. The ruffed grouse, or partridge, as he is often called, is strong and swift of wing. In spite of his pinions being comparatively small, he is a marvellously rapid flyer; and the whirlwind of leaves where he is flushed, bears testimony that no lack of energy is back of his beating wings.

On rising from the ground, the flight of the grouse is generally straight for the tree-tops. Through and among them, after having gained sufficient headway, he goes, sailing and twisting, tipping and tilting, in an astonishing manner, until at length, his fright in a measure abating, he settles into some thick evergreen, or on the earth again. During this first upward rush is, in my opinion, the time to shoot. To be sure, there is the startling roar of wings to unnerve one, but this nervousness is overcome in time, and only adds to the zest of the moment.

Another peculiarity in the flight of this bird is observed later in the season, when the first snow is at hand, and when, from having been hunted, he is wild and suspicious. At such times he will often perch high in some lofty evergreen, at the head of a ravine, and on the approach of the hunter, will launch forth from his watchtower with a long, downward dive, thus almost instantly acquiring an enormous velocity. It is not, however, the vagaries of flight alone that make the grouse so difficult to shoot; for his favorite haunts are in the densest and most inaccessible woods, and though naturally somewhat stupid, on acquaintance with man he becomes shy and suspicious.

The nature and habitat of this bird are a

study worth the attention of every sportsman. In fact, he must, if he would meet with success, apply himself to the close observation of his ways, preserving in memory each incident remarked, no matter of what seeming insignificance. In this way the huntsman will become familiar with his habits, and his cunning will be easy to master. From many a covert that would yield naught but disappointment to the tyro, the observant gunner will gather a good bag.

The time of the white and red moors of the poet is now at hand. Anxiously has the sportsman been awaiting its coming. Long has he watched for the forest to again float on the breeze its gaudy-colored ensign. May his patience be rewarded! May he fare as well as I did, some years ago! That hunt is still fresh in my memory.

For a month or more, my brother Joel and I had been uneasily waiting for cool weather and the opening of the season, to try our luck once more with the grouse. In every conceivable way we had been whiling the time—polishing our guns again and again, until they fairly shone; schooling and encouraging our dog, a black cocker spaniel; and discussing the haunts and the peculiarities of our favorite bird. Our plan was to open the campaign back among the mountains, where, we had heard, the grouse were unusually plentiful. The day came at last, and in the early morning we were far on our way and well up in the thick evergreen forests.

Anyone whose knowledge of the woods has been gained solely from suburban woodlands, can hardly conceive of the grandeur of primitive forests. Beneath one's feet is the brown woodland carpet—leaves of evergreens that have fallen year after year, interwoven with mosses and lichens—softer and thicker than any of man's devising, and much less noisy. Above are the giant firs and spruces. The solemn, peaceful stillness makes it seem like consecrated ground.

This is the stronghold of the grouse, and with feelings akin to awe we reached the depth of the woods. Hardly a sound was heard, save the ceaseless sighing of the wind in the treetops. "Not a vestige of life is here," one would have said. Our dog, however, was of a contrary mind. The silence was quickly broken by the ring of his cheery bark and the boom and whirl of wings.

If there is anyone who is unable to comprehend what pleasure the gunner gets from his sport; if any man fails to see how genuine amusement can be gained from

tangle and thicket, let him place himself in such a position. His scepticism will vanish and he will become an enthusiast on the spot; possibly, dashing about in senseless frenzy of excitement. At least, such has again and again been the fate of the scoffer.

The woods rang with the reports of our guns, and with hearty shouts of triumph at some exceptional success. Even the grim and gnarled trees seemed to join in our sport, echoing and re-echoing to one another, as if in encouraging applause. On we followed, in the wake of the dog, accepting without question his course; nor did we have reason to complain. Though he led through swamps and thickets, it was

to bring us always to the hiding places of the birds.

While the sun rose high and sank again, our hunt continued. Grouse were on every side; not singly or by 2's and 3's, but in coveys, leading us on with barely time to stop or to rest. At length the sinking sun admonished us to stop. Not until then did we sit down to count our spoils.

What a day we had! What a bag we made! Such gala days have seldom fallen to my lot. Truly, the first of the season is the best; and well it is the opening day should long be cherished as a just reward to the conscientious sportsman, for his faithful waiting through the close season.



AMATEUR PHOTO BY B. J. WARREN.

AN EARLY BREAKFAST.

Awarded Twenty-fourth Prize in RECREATION'S Second Annual Photo Competition.

Teacher—Why did Delilah cut all the hair from Samson's head before she proceeded to his undoing?

Tommy—So she could snatch him bald-headed better.—Richmond Dispatch.





AMATEUR PHOTO BY W. L. RATHBONE.

IN TROUBLE.

Awarded Twenty-third Prize in RECREATION'S Second Annual Photo Competition.

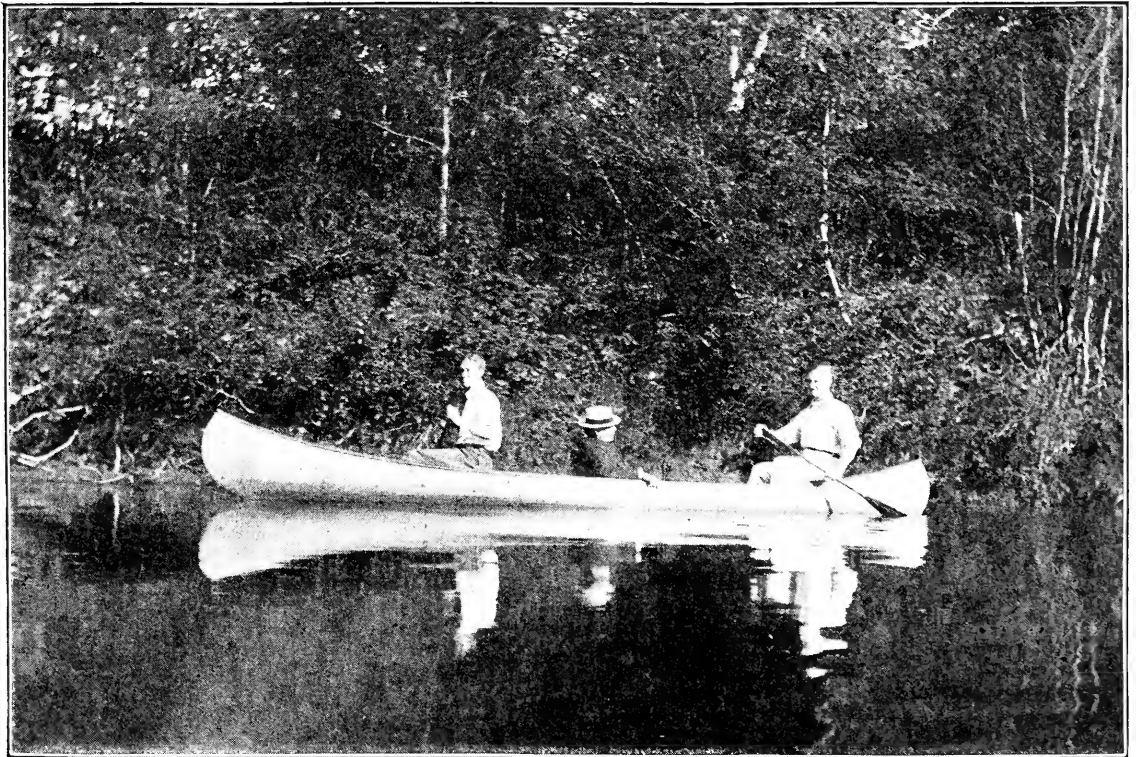

AMATEUR PHOTO BY E. V. R. THAYER.

A JUNE AFTERNOON.

Awarded Twenty-seventh Prize in RECREATION'S Second Annual Photo Competition.

## A CYCLE RACE, WITH A SEQUEL.

MISS C. H. THAYER.

If we do not live in Chicago, New York or Boston, there is just as much wheeling enthusiasm to the square inch in our little town as in any of those cities; and there are any number of bright girls who can beat at golf and tennis, or do a century without wilting like frosted flowers. Although we can boast no fine parks, there are good roads, and high hills that one may descend like an avalanche, with the exhilarating risk of breaking one's neck before reaching the bottom.

Nearly all the girls have wheels, and ride them, gracefully or awkwardly, according to the girl. What a difference there is! Some ride as if trying to hit their chins with their knees, at every revolution of the crank, while others glide along with scarcely any apparent pedal motion. Awkwardness does not seem to detract from the enjoyment; so what matter?

Now, we wanted to have a race, but not a public one. "Where can we go?" was asked and discussed, as only a score of girls' tongues can discuss an interesting question.

"If Mr. Canning would only let us use his beautiful drive," said one, "how lovely it would be!"

"Propose a trip to the moon," suggested a sarcastic listener.

"Or a road built by ourselves," proposed another.

"Well, girls," I interposed, "why not ask Mr. Canning? He's not an ogre."

"Very near it," cried a laughing girl. "He's a crusty old bachelor."

"He has that reputation, because he pays no attention to ladies; but he may be diffident."

"Diffident! A millionaire diffident!"

"Well," I persisted, "it's the only place for a race, and we shall have to give up the scheme altogether, or ask Mr. Canning. Who will do it?"

"Not I!" resounded emphatically from all sides.

"Then I shall, myself," I declared.

"Olive Dawes!" exclaimed one; "you won't dare to beard that old bachelor in his den!"

"No, but I dare beard him in his handsome house; and be delighted to get inside of it, too. Besides, he is not so terribly old—not more than 40, and some men are just lovely at that age."

Mr. Canning is the wealthiest man of our town, and his residence is elegance itself, with a charming shaded drive all around it. On that charming shaded drive we wanted to have our race; but of course the owner's permission must be asked. It did require some confidence and self-assurance to ask

it; but I put on a bold face, and said I would go if one of the other girls would go, too.

"I'll do it," was the prompt reply, from Patty Armstrong.

"Very well," I replied, not greatly delighted; for we thought Patty an insignificant little thing, who had reason to feel flattered with any notice we took of her. She had a deprecating air, as if apologizing for the liberty of existing.

However, that very afternoon, arrayed in our best and gayest, we called on Mr. Canning. We were shown into a room, the richness of which surpassed even my expectations. I looked at Patty, supposing she would be completely overcome by such magnificence; but she appeared as cool and calm as if she had been used to such things all her life.

Mr. Canning was gallantry itself. I felt a little nervous when he came in, but he was so polite I made my request without any hesitation. He granted it so cordially and pleasantly, I exclaimed, gushingly: "I think you are splendid!"

He looked amused, and thanked me. Then he said he would give the winner of the race a prize and a banquet, in his large dining-hall.

"Shall you both be contestants?" he inquired.

"I'll not," I replied.

"I will," Patty said, to my amazement. The idea of that little washed-out creature trying to beat 20 wide-awake girls!

Mr. Canning regarded her in the most benign manner. "I wish you success, Miss Armstrong," he said, with unnecessary emphasis, it seemed to me; "and if I professed to judge faces, I would predict you will win the race." He evidently meant it, too.

After this the girls were in a constant state of excitement; practising on their bicycles, and riding at break-neck speed—all except Patty, who did not ride much oftener than usual.

"Why don't you practise fast riding?" I asked.

"I don't want to waste all my strength beforehand," she replied.

"She's wise," one of the girls scoffingly remarked. "She'll need all the strength she has to win the race."

The eventful day came, and oh, how excited we all were! There were 20 riders, all but poor Patty dressed in new bicycle suits that were gay and becoming. I always thought a horse race a splendid sight, but this was prettier. Such bright, expectant faces and flashing eyes; such animated gestures and laughing threats!

At the signal, off they started, flushed

and eager; well together, with Patty decidedly in the rear.

"The silly little thing!" some one near me exclaimed. "What did she ride for?"

"She may win yet," answered another voice. "Patty Armstrong is not the fool you think her."

We all laughed. Now they had nearly finished the course. Suddenly, little Miss Armstrong threw herself forward, in genuine racing style, made a grand spurt and, shooting ahead of them all, reached the goal, breathless, but eager.

"Hurrah! hurrah! splendid! splendid!" arose the cheers from the little group of spectators. Poor, insignificant Patty was queen of the day. As for Mr.

Canning, he acted like an overgrown boy; shouting, clapping his hands, and tossing up his hat in wild enthusiasm. Then he sprang forward to the triumphant girl, offered her his arm and led her to the house, into the banquet-hall. He seated her in the victor's chair—a bower of roses.

Patty did not have a deprecating expression then. Her eyes shone and her cheeks outrivalled the roses she crushed at every movement. Now it was different. We no longer felt we were condescending to notice her, but were glad of her attention. That day Patty Armstrong won not only the race, but our most distinguished citizen as well.



COPYRIGHT, 1897, BY WRIGHT & CARLIN.

'ANOTHER OF MY POSES.'

See page 89, August RECREATION.

## THE MUSIC OF THE WOODS.

J. D. CRAWFORD, JR.

There's something in the wild wind, sweeping o'er the hill,

Or in a coyote's medley, to make one's whole soul thrill;

Or at your camp in autumn, comes a feeling that is strange.

When you hear a bull elk's bugle notes, far up the mountain range.

There's something in the swish of the water flowing by

That makes a sportsman wish he wasn't born to die.

This something's in all Nature if we may only hear,

'Tis music sweet, 'tis music grand, who'll lend a listening ear?

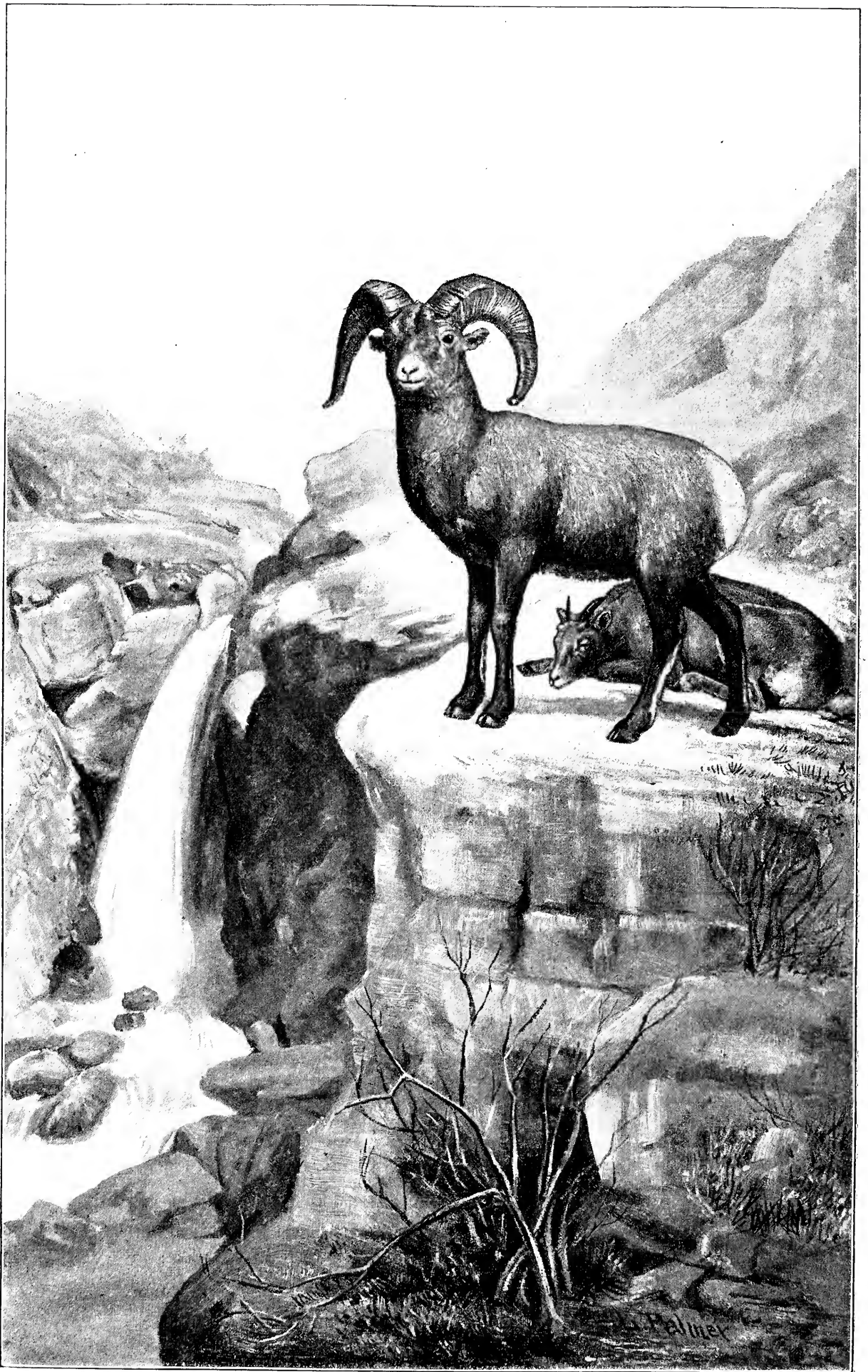

MOUNTAIN SHEEP (*OVIS MONTANA*).

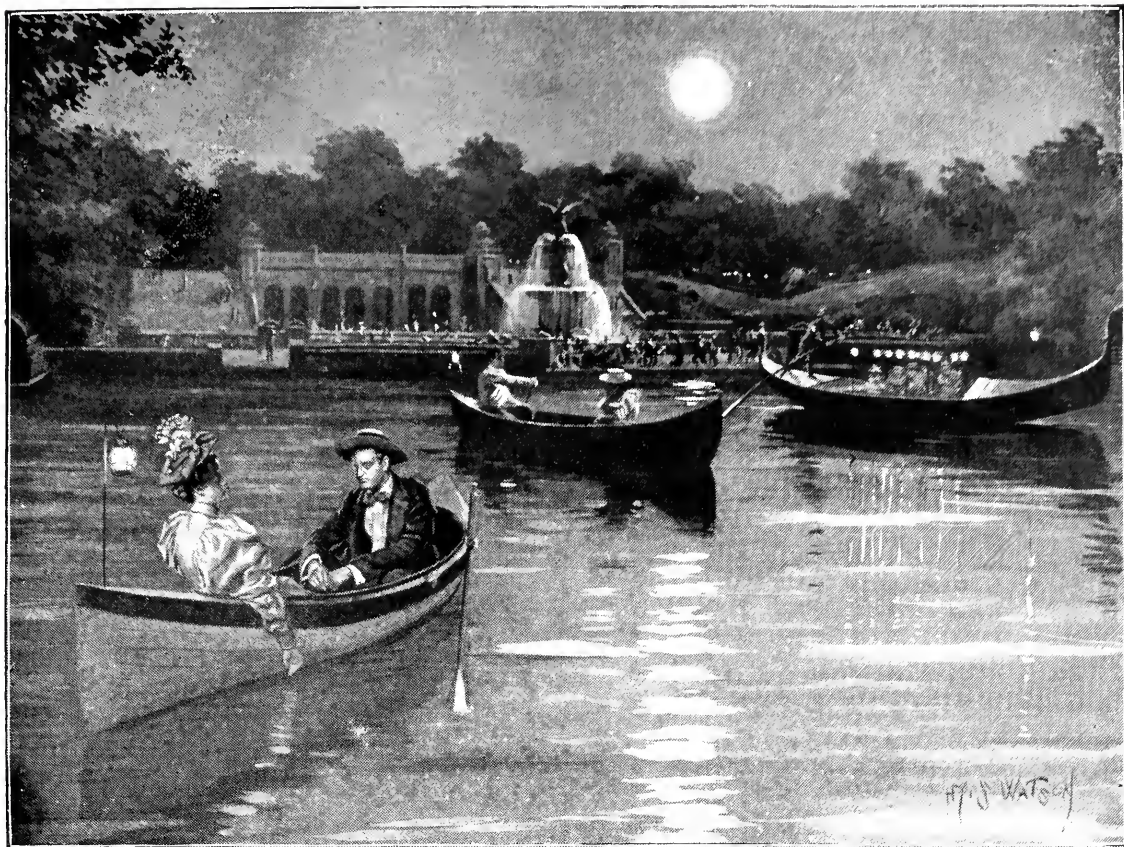

## ECHOES IN THE MOONLIGHT.

MARGUERITE TRACY.

The growing light of the harvest moon  
Follows the lingering twilight soon,  
Merrily over the waters blue  
Soundeth a yodle la—la—e—hoo!

Laughing and calling a merry clan,  
Laughing and calling as light hearts can,  
Gathers together the whole dear crew  
Summoned by la—e—la la—e—la la—e—hoo!

Out through the dusk where letters hide,  
Stealing the fairest of all, they glide:  
Is there a straggler? Call her—do—,  
Soft and low—la—la—e—hoo!

Back to the fountain's rippling light,  
Lingering there till the dusky night  
Scatters them home thro' the falling dew,  
Calling and answering la—e—hoo!

Over the water's glistening play,  
Over the shadowy, darkening way,  
Floateth and echoeth faint but true,  
La—e—la la—e—la—e—hoo!

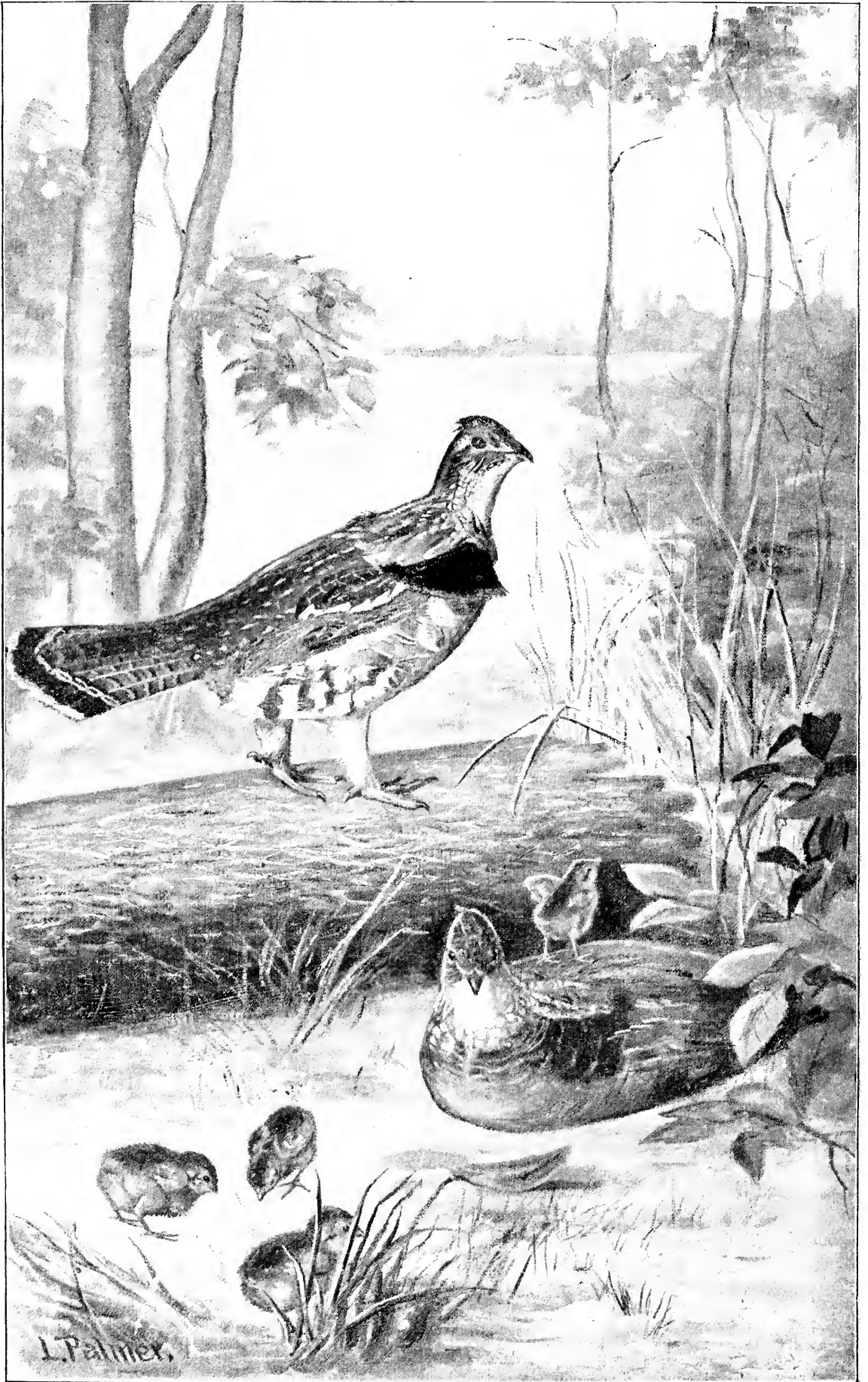

RUFFED GROUSE (*BONASA UMBELLUS*).

## RUFFED GROUSE AND WOODCOCK.

U. B.

Toward the close of last August, a friend and I decided on a day after woodcock. The place we fixed on is known as Weaver's swamp, in the Southern part of Columbia county, New York. We had selected this locality because the dry weather had driven the birds from the smaller marshes. Here were springs and streams.

The day of our hunt was hot; such a day as fairly curls one's gun barrels, and gives high pressure indeed to the powder. Our guns were Bakers; mine a 12 gauge, a trifle over 7 pounds in weight. Poor Jim took a heavy 10 gauge duck gun. Hurriedly picking up the case in the dark, he did not discover his mistake until the hunting grounds were reached. His shells, he said, were loaded with  $5\frac{1}{2}$  drams of powder and  $1\frac{3}{4}$  ounces of shot. After hearing the 1st discharge, I took it he meant pounds instead of drams and ounces.

We arrived at the swamp just as it was light enough to tell the rich black mud from the heaps of decayed leaves. After putting the horse in a neighboring barn, we started to hunt, but as it was too dark to make out anything in the bushes, we sat down. That is, we intended to sit on a log, but it proved to be only a dark shadow over a streak of the softest mud I ever sat down in. We then got out of the bushes and held down a rail fence until sunrise.

A walk of 15 minutes in the alders brought us to solid ground. As we had been wading in muck up to our knees, our faces and hands covered with mosquitoes, this was some relief. The brush was almost impassable, but we worked around and sent the dog through. Following his movements among the bushes, we soon saw him crouch. At the command, "Go on," he took a step, and away went a bird. I let go an ounce of 10's, propelled by  $2\frac{3}{4}$  drams of nitro, while Jim turned his duck gun loose. The result was what might have been expected. The dog brought in a mouthful of feathers with a few fragments of skin and bones clinging to them.

"Robin," I murmured.

"Holy smoke, no! I'm sure it *was* a woodcock," said Jim. There the argument ended, for it couldn't be proven either way.

The dog again stopped a short distance ahead, by an old log on a knoll covered with ferns. We advanced, and 2 birds flushed. As is usually the case, we fired at the same one, the 2d getting away; then followed a wade through mud knee deep for half an hour, with a result of 7 more woodcock.

We were now at the North side of the

alders, near a huckleberry field. Of all things that tempt ruffed grouse, a huckleberry field stands first. Before we were over the fence, the dog came to a stand. The click of safeties, or the sharp "go on," started a dozen birds, which scattered in all directions. I missed my 1st, but redeemed myself by grassing 2 with my left. Jim brought down 2, the 2d with a broken wing. This one started toward the swamp, he in hot pursuit with an empty gun.

As I expected, he had not gone a dozen steps when up started 3 grouse with a fluttering of wings that brought him to his senses. It was amusing to see him try to shoot with an empty gun, and then to hear him cuss because it would not go off. He joined in the laugh, remarking it was a mighty lucky thing for the birds.

The dog having laid the dead grouse at my feet, I took no further notice of him while talking to Jim. When we were ready to move on, he was not in sight. A hasty search failing to reveal him, we walked on toward the alders, in the direction the wounded bird had gone. We found the dog a few rods away, crouching in the rank growth; but a walk all around him failed to show what he was pointing. A closer search revealed a small hole almost under the dog's nose. Jim, in rather a reckless way, reached in his hand, and drew out the lost grouse, dead.

The next move was to look up the rest of the covey. Several had swung around toward a knoll dotted with bushes. Here the dog pointed. We advanced slowly and had almost reached the pointing dog, when, with a great flutter, a single grouse rose—an old bird. He twisted and dodged in a way that showed he was familiar with what was coming. "Boom—bom," then 2 spiteful "cracks" from the nitro powder, but they served only to hasten his departure.

The setter started ahead at the reports, utterly disregarding my "come in, sir."

At his second jump, up rose a whole covey of young grouse. The old bird certainly had a head on him that would have done credit to a larger body. Many seasons devoted to the art of escaping shot guns, served his family well. How nicely he had calculated! Every young bird was safe in the thick alders before fresh shells were in our guns. There we stood trying to force cartridges into the chambers base first, or, jamming them, concluded they were swollen, and tried others.

Who has not been there? Do not smile, old veteran. This was not the first covey of grouse James and I ever pointed a gun at. On the contrary, we have hunted these

sly birds under almost all conditions; but this was our first hunt for nearly a year. Then, too, a big covey of ruffed grouse creates a little excitement in almost any one's system.

It was now 11 o'clock, and so hot our clothing was wet through with perspiration. Seeking the shade of a spreading hickory, we rested and ate our lunch. After an hour or so, the hunter's instinct began to assert itself again. This feeling was increased by the sound of muffled drumming, coming from the edge of the field under the alders. When within 40 yards of the swamp, a young cock strutted up and down the fence that separated the field and marsh. The dog was sent ahead. As we expected, the bird flew directly upward. Jim sent a load of 8's into the air, doing no damage, and as the bird was nearly out of range, I dropped him.

This was where the covey of young birds had been flushed. The dog got up 2 more

in retrieving my bird, which shows how grouse will return to a certain spot.

We now tried the marsh again, wading about for some hours. Several woodcocks were flushed, and a fair number of them killed. As we came out into the field, where our horse had been left, the lengthening shadows told that our day's sport was at an end. When the wagon was reached, our coat pockets were examined. The count showed 13 grouse and 9 woodcock. Not much of a bag, perhaps, if one judges by numbers, but we were well satisfied. We had had a day of royal sport, and the birds that were left have furnished us many a good time since.

Give me a good companion, a fair number of birds, and a well-broken dog, and my mind is at peace with the world. I can then, for the time being, forgive the man whose bull chased me out of a field wherein lived 40 woodchucks, with such haste that in climbing the fence I broke my rifle.

---

## OUR ALASKAN EXPLORING EXPEDITION.—CANOEING ON THE STICKEEN.

A. J. STONE.

As I have heretofore referred but briefly to the difficulties of navigating the Stickeen, I will here describe one of our experiences, in our first attempt to get up that river.

There were 4 of us in the party, Ed, a white settler, with his Indian wife, and I. Our boat was a flat bottomed, sharp pointed scow, well built, but too heavily laden for the strength of the oarsmen. We had been working very hard to make an average of 7 miles a day. The lower Stickeen is very wide, and, in many places, divided into numerous currents and separate streams by long, narrow, wooded islands. As we had no pilot who knew the stream, we often took the wrong route and attempted channels that were simply impassable.

We fought our way up until we gained a point almost opposite the Great glacier. Here we encountered a strip of water that flowed over a sand bar about 3 miles long, and that was so shallow we found we could wade it. Giant trees that had fallen and been brought down from above, were stranded here and there on this bar and gave us no end of trouble.

We must either travel through this stretch or go a long way back and around; and the latter we declined to do. The water was so rapid we could neither row nor

pole our boats through it; so 2 of us waded it the entire length of the bar. We were compelled to use the greatest precaution in order to keep moving, the swift current often proving almost too much for us.

After using up the greater part of the afternoon at this work we finally landed at the head of a little island, piled high with drift wood, at its upper end. In a little eddy, behind a large drift, we halted for rest, about 100 yards from the mainland.

To our left was the main body of the river, while just ahead of us a heavy body of water left the main stream and poured over and down a side stream, through jagged rifts of lodged timbers. The current was simply frightful. There was no way around it. The river, to our left, was wide and rapid enough to prevent our crossing. Where the side stream separated from the main one, there seemed a ridge or crest which we thought might be passable. We tried it, but after a desperate effort, lost control of our boat and after being turned 2 or 3 times and driven back with fearful force, managed to regain the eddy.

The river was rising rapidly and night coming on. Something must be done. The island was low, and liable to be submerged before morning, so we could not think of





“WE AGAIN STARTED FOR THE MAINLAND.”

camping there. Stacking about half our supplies on top of the drift wood, so as to lighten our boat, we again started for the mainland, with a rush, and were again driven back. Then we unloaded more of our freight, and a third attempt proved successful, only after the most determined effort. Several times I thought we would fail, and several times it seemed we would sink in the boat, exhausted. When we finally landed we could barely crawl up the low, grass covered bank.

But what about our supplies—our cameras, plates, guns, and provisions—back on the drift wood?

The man we had with us, a brave man and a good canoeman, saw I was perplexed. We had over 300 feet of rope with us and he suggested that, after unloading the boat, he and I coil in the rope, make fast one end to the shore, let ourselves back to the island and leave Ed and the Indian woman to tow us in.

We undertook this and down we went like a shot. We managed to make the proper landing, but by the time our stuff was loaded our rope had fouled under some drift wood, about half way, and could not be recovered. Taking my position in the bow I took in rope, hand over hand, until near where it was fast, when we were sud-

denly thrown from our course by the current; and had the rope not been cut, instantly, we would have capsized.

When the rope parted we were driven violently down the side current but managed to land about a quarter of a mile below, on the mainland. Towing and brushing were then in order, to reach camp, which was accomplished at 3 o'clock the following morning.

All this time the mosquitoes fairly drove us crazy; and we were so fatigued we could not think of cooking a meal. There were some cold boiled beans in the kettle and we managed to make some tea. These comprised our repast after 14 hours' exertion and excitement, and we went to sleep on the ground, with our heads under pieces of muslin to keep off mosquitoes.

The next day we rested, fought mosquitoes, and watched the drift wood disappear, at the point where our supplies had been stacked the evening before.

I could relate many other incidents of the trip, equally hazardous, but will only say that to navigate the Stickeen requires the best of canoemen, and at least one who knows the river. It was after discovering these facts that I turned back to Fort Wrangle and secured a complete Indian crew, who knew the stream, to take us up.

## CATCHING A TARTAR.

CAPT. J. G. LEEFE, U. S. A.

When Yellow Jack made his biennial entry into New Orleans, the garrison of Jackson barracks retreated, in good order, and took up a position on Ship island. This was in 1870. The island is simply a bar, belonging to Mississippi; but, unlike other bars to which her faithful sons thirst for admittance, this one is entirely surrounded by water. It is about 12 miles off Biloxi; laved on the South shore by the emerald waters of the Gulf of Mexico, but only half washed by the muddy surge of Mississippi sound on the North.

Here we arrived at midnight, and were welcomed by half the entire male population, to wit: the light-house keeper, who shone resplendent in a new wooden leg, the gift of a grateful country. The other half, a high-toned goat, deferred his part of the ceremony until the next morning. Then he appeared before the commanding officer, bowed gravely, and butted him off the plank walk leading across the sand. His goatship at once retired, with dignified slowness, to his fastness at the other end of the island, and stayed there.

Incited by the Doctor, who had been there before, we brought with us lots of hooks and lines and other things with which to lure the wary fish. There was little chance for angling on the South shore, but the surf was fine. So tempting was it, Lieutenant O'Bog declared he would "be ather lavin' meself in it for a bit ov a shwim." However, when a swift and shining shark rolled over on its side, and, with a bland smile, showed 6 rows of gleaming teeth, the Celt took water and swore he would "batc the likes of that naygur wid a hook."

There was fishing to spare on the North shore, and the long pier jutting thence  $\frac{1}{4}$  of a mile, until it met clear water, was the daily resort of idle men in blue, eager for bites. Many a polished rod swung to shore the shining perch. There were lots of sheepshead, green trout, silverfish, and others that shall be nameless, because I do not know what they were. Sometimes we hooked a pompano, the *pontifex maximus* of all flat fish. Now and then a shoal of redfish huddling shoreward, leaping and fleeing in terror from a pursuing porpoise, "would the multitudinous seas incarnadine."

Sharks of every species pervaded the deep at times; and so the smaller fry did not fare so well. One scorching, nibbleless day, Mr. O'Bog's "naygur" was inquisitive, regarding 6 pounds of salt pork, and was hauled ashore, to be despatched by the irate Celt. Then some one else became an object of envious interest by land-

ing another kind of shark (one of the no name series), small, black and glossy, with upper part of snout corrugated, like the sole of a tennis shoe.

The *pièce de résistance* of our feast of fishing came to the surface on a fine September day, when the wind was lively from the Northeast and the waves were turbulent. Not so rough, however, as to disturb numerous albatrosses that rode the waves like old caravels at anchor. The Doctor came up smiling, prophesying devil-fish. Suddenly the albatrosses took to themselves wings; the already storm-tossed waters grew unduly vexed; while a line The O'Bog had set for shark tautened—a splash, a snap, and back flew a part of the line against the pile to which it was attached. Close to the pier, careening swiftly by on the top of the waves, we saw a monstrously hideous thing!

Before the Doctor could find breath enough to gasp, "th- th- that's one of 'em," the thing disappeared. It was flat, diamond-shaped, like the mortar-board hats worn by students, and appeared 12 feet across. Its glistening back was dark, but as it swayed from side to side, like an overhand swimmer, its belly flashed white through the pale green waves. In front of its hideous head, moving back and forth and laterally, was a pair of feelers, or tentacles, each about 4 yards long, resembling serpents. Close about its beaked mouth writhed and twisted a mass of smaller claws. Its huge round eyes, like a pair of gig-lamps, shone with glassy fierceness.

There was no more fishing. Discussions were in order. At the mess that evening, when cigars had been lighted, the Doctor, with his usual air of having "been there before," shied his castor into the arena.

"You are of course aware gentlemen," he began, "we have to-day seen one of the great family of *Mollusca*, of the class *cephalopoda*, mis-called by the mariners of these waters, 'devil-fish.'" The Doctor's fine courtesy in assuming we knew what he was talking about, won from us a spontaneous burst of silence.

"If I may ask you," he continued, "to remember the oyster, which has formed a not unimportant part of this repast, and then to pass to the contemplation of the proportions of the monster that made away with Mr. O'Bog's hook and line, you may form some idea of the extreme range in this class of animals. They are mentioned by Aristotle, and, if I am not mistaken, by the elder Pliny. Mr. Gosling, who is fresh from his books, will kindly correct me, if I misstate (subdued snore from Mr. G.). The specimen that appeared

to you to-day was a cuttle-fish, of the order *decapod*, or having 10 arms." ("Bedad!" muttered The O'Bog, who stood in awe of the Doctor, "now I know fy thim things is called tin tackles.")

The Doctor, loftily ignoring the Celt's existence, continued: "The octopod has, as you well know, but 8 short arms, branching from the margin of its mouth, and is destitute of the longer tentacles you observed in the *decapod*. The latter is frequently seen in the waters of the Caribbean sea and the Mexican gulf. Some of the early Norse writers gave astonishing accounts of the colossal *cephalopoda*. You need not refer to the books. You have actually seen what they attempted to describe. I am led to assure you, if the day is fair to-morrow, you may again see, over by Cat island, more than one of these huge creatures, sleeping on the water, as is their custom after a storm. Er-may I trouble you for a light?"

The next morning every one was earnestly looking Westward toward Cat island. On the surface of the water, now smooth and glassy, here bright with golden light, there darkened by the shadows of fleeting clouds, not the faintest sign of any living object could be seen. So those who had not yet breakfasted went back to their quarters, while others who had already had a bite threw out their lines and awaited nibbles.

All of us thought unutterable things of the Doctor. There were no fish in the sea, apparently; but Antonio, skipper of the little felucca that brought us a semi-weekly mail, a Sicilian, explained, with a smile, "No leetle feesh-a. Alla same diablo feesh-a bime-bye."

This he accompanied with a graceful wave of a thin brown hand to the West; so we looked again. A soldier named Elliott, a quiet man with a marksman's gray eye, said, in a calm voice, he could see some of them. Sure enough, not  $\frac{1}{2}$  a mile off, dark objects were floating on the water. We counted 13 huge creatures, like little islands.

In a moment a boat was manned and put off, Elliott in the bow with a harpoon. Antonio sprang to his craft and hoisted sail. Other enthusiastic fishermen leaped from the pier into the vessel, tumbling over each other as they reached the deck. The breeze was so faint the canvas hung flat, and the craft made little headway. By this time the pier was crowded and the shore was lined with excited spectators. The small boat with Elliott in its prow had such a start, and the oarsmen pulled so well, the felucca could not overtake it; but we came close enough to see Elliott standing with one foot resting on the gunwale, harpoon

poised. The monsters still seemed to enjoy the sleep of the just. The little boat headed for the nearest and largest. When it appeared as if the dory would surely run against the creature, Elliott drove his weapon with mighty force into its back.

For perhaps 5 seconds, the sea was lashed as if by a miniature tempest. The little craft was whirled and tossed like a chip. Now the felucca approached and made fast. The fury of the water gradually subsided; bubbles and eddies marked the surface; the harpoon line paid out across the gunwale with a whiz; and it was apparent the monster had sought the depths. The others had also disappeared. We began to move through the water at a rapid rate, Cat island to our right as we sped by. Our course was Southerly, and in front stretched the broad expanse whose limit was the Southern shore of the Caribbean sea.

Both vessels labored and plunged. The felucca was "down by the head" and listed toward the side on which the dory was lashed; while the dory's stern stood up a little as her nose bent down. The harpoon-line was vertical and taut. This told us our submerged friend was striving to drag us under water. As he had already shown his ability to tow the felucca and her little consort, in spite of our efforts to put about, the possibility that he might corral us all in the coral halls of Davy Jones, was more exciting than agreeable. Then, too, the chance that he would reappear on the surface and woo us with his enveloping tentacles did not heighten our pleasure.

To make matters worse, Antonio told us there was nothing to eat on board; and at the same time he plaintively pleaded the presence of certain provisions in his mail-contract, a violation of which would deprive his "cabinettos" of their needed loaves and fishes. So, with much reluctance and a little hatchet, the bond of our attachment was cut. At once our headway diminished as if an air-brake had been applied. Then the felucca, the dory now in tow, put about and stood for Ship island, far away to the Northeast, its white sands shimmering in the light of the descending sun.

When we stepped ashore, one of the first to greet us was the Doctor, who volunteered to go with us next time to show us how to land a devil-fish.

To which The O'Bog, who had been with us and had done lots of work while remaining strangely silent, said: "Ould Aisculaypious wud talk the tin tackles aff av the dekkypod and lave the divil harrumless an' widout a leg to shtand on in the middle av the say; but he'll not have the likes av me in the anjience afther the game he gev us lasht night."



THE BATHERS.

AMATEUR PHOTO BY G. E. MOULTHROP.

Awarded Eighteenth Prize in RECREATION'S Second Annual Photo Competition.



COPYRIGHT BY WRIGHT & CARLIN.

ANTELOPE ON THEIR NATIVE HEATH.

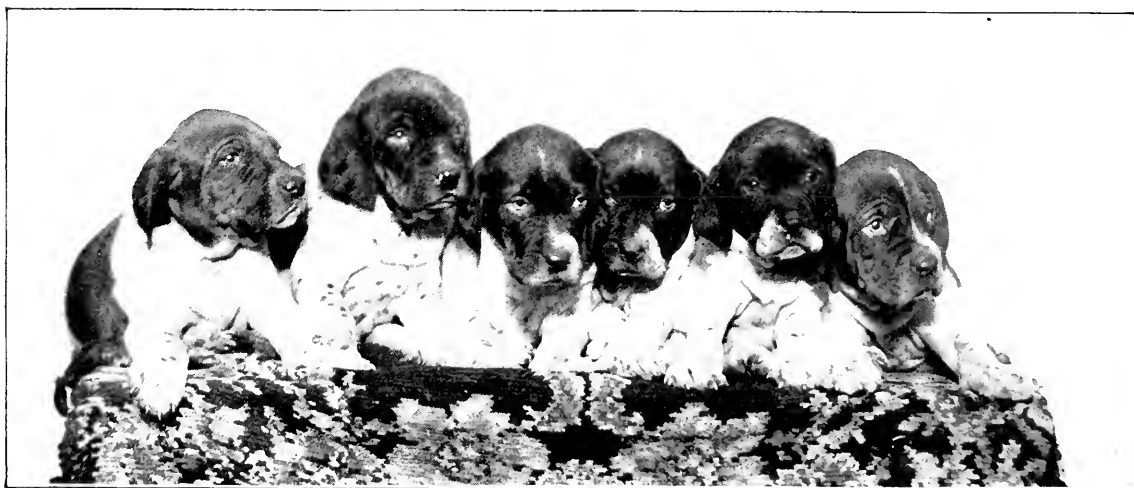

AMATEUR FLASHLIGHT PHOTO BY J. H. JONES.

ALL AT HOME.

Highly Commended by Judges in RECREATION'S Second Annual Photo Competition.

## A CANOE TRIP TO RAINY LAKE.

HARRY SILVER.

Gold-bearing quartz was discovered in Northern Minnesota in the summer of 1893, though it was really known to a few hunters 20 years earlier. It was never fully investigated, owing to the lack of railway facilities, and to the country being broken by lakes and water-courses, so that getting in and out was accomplished with difficulty. Notwithstanding these drawbacks, many a hardy prospector traveled through the region North of Rainy lake, and washed "colors" from pounded rock.

The last discoveries were on the shore of Rainy lake and along Rainy Lake river, the Northern boundary of Minnesota. The only way to this new Eldorado was by a land-and-water route from Duluth, or a water route from the Lake of the Woods, up the Rainy river. As both ways were roundabout we decided, when the trip was planned, to make our way across from Fosston, Minnesota, to Rainy Lake city, and add the exploring of an undeveloped region to the pleasures of an outing.

Early in the spring of '94, W. J. Hilligoss, a veteran cruiser of Northern Minnesota, Fred Ayers and I, left Fosston by team for Red lake, 65 miles distant. Red Lake Agency was reached the next day, just in time to get the Captain of the steamer to delay starting until we could arrange for canoes, guides, etc. With the assistance of the merchant at the Agency, who spoke Chippewa, we engaged 2 Indians to show us an old trail and portage from the head waters of the Tamarac to the Sturgeon. We bought a birch-bark canoe and some supplies, and loaded all on the steamer.

A ride of 40 miles to the Northeast end of the lake brought us near the mouth of Tamarac river, where we were landed about midnight. We at once turned in and slept till sunrise.

Our canoes were soon loaded for the long voyage. The canoe of the guides was made to carry all that could be put into it. They watched the loads, and as the pile in theirs grew larger, and the pile on shore diminished, they showed such signs of displeasure we had to let them go; though when we came to load our canoe, and 3 of us got into it, we found it too heavily laden.

The bank where we embarked sloped abruptly into 15 or 20 feet of water, so it was with shaky feeling that we pushed off. No accident happened, however. We paddled steadily until about 3 p. m., when we stopped for lunch. Hungry enough we were. For 3 hours we had been looking for the dry landing place our guides kept telling us was just ahead, but finally getting disgusted with their idea of distance, we

pushed our canoe to the dryest looking shore we could see. It may have been dry at one time, but now 2 feet of water covered it while dry grass, matted above, gave it the appearance of land. By hanging the tea-pot on a limb, and building a fire of grass and twigs, we soon had tea, which, with our cold meats and baker's bread, made us forget we had had an unusually hard half-day's work.

The journey was continued until sundown. Then, for want of a better place, we camped in a tamarac swamp and swung our hammocks to the trees.

The next day at noon we reached the portage. Here our supplies were done up into packs, suitable for carrying on the back. We made one for each of the Indians, who were under agreement to do all the packing. They sat by and watched us. When all was ready to make the start at the portage, they got up and walked back to their canoes and took the homeward route. The work before them was too much. We saw no more of them; but as they were to be paid when we reached the Sturgeon, we were not out anything. Their departure was not regretted, although we were at the beginning of a portage we knew nothing about.

We began packing along the trail, over trees and stumps, through dense undergrowth, and swampy places in which we sank to the knees at every step. Six trips were made, before sunset, to a point about a quarter of a mile from the starting place. Here also we were obliged to swing our hammocks, as water stood all about. This being the second experience in fastening our hammocks, we missed some of the excitement of the night before, when Hilligoss had stood up in his hammock, balancing himself on one leg while pulling the boot off the other. You can imagine the result; no bucking broncho ever landed his rider in better style.

The hard work of this part of the portage started the veteran out early next morning, along the trail, to find how far it was across to the Sturgeon, and in what condition the trail might be. In the meantime, the rest of us moved the supplies another notch along the route. About noon our friend returned with the information that it was  $4\frac{1}{2}$  miles to the river, and that he had met some acquaintances, land hunters, who would help us.

With 3 hardy fellows added to our party, we made good headway. Camp was pitched that night in 2 feet of water; dry land could not be found. By cutting a large number of small jack pines, we built a crib above

the water. Covering this with pine boughs, we made a comfortable resting place. The night was warm and the mosquitoes were out in force; so we slept with screens over our heads.

Breakfast was prepared with the stove placed on a pile of moss, while the cook waded knee-deep in water.

The trail for the next mile was open, and the water deep enough to pull the canoe along with all the supplies.

In this way we dragged our load, taking frequent rests and alternately helping each other out of a hole. Sometimes one would go waist-deep into the soft moss and water, which in places seemingly had no bottom. Only by grabbing a tree could one extricate himself. Many laughable scenes were witnessed, and in spite of the disagreeable features, we appreciated all accidents. About 4 o'clock we landed at the Sturgeon. I doubt if any weary band of explorers ever hailed more heartily a long looked for water-course than we did that small stream, scarcely 15 feet across. We now had a down-stream ride the rest of the way, and we turned in early, well satisfied with the day's work.

Camp was aroused a little later by some of our hunters attempting to get sight of a moose that splashed through the water close by, but the night was too dark.

By 10 o'clock next day we had said goodbye to the men who helped us in making the portage. Soon after we were afloat. The banks of the stream showed signs of moose all along, and of course we were on the lookout, for we wanted a good shot for our camera. Indian signs of moose-killing were seen. A pole sticking up in the bank, with a bone or piece of rawhide fastened to it, or a meat-drying rack, were the usual methods of marking the spot. Their hunting is done at all seasons, and large numbers of these noble animals are slain. The Indians are not restricted on or off their reservations, and although they are subject to the same laws as the white man, these laws are not enforced.

The river broadened as we left the tamarac swamp, and rapids were frequent, helping us a little faster on our way and making the ride pleasant and interesting. On we went, through a forest of oak, birch, poplar and pine, growing to the water's edge, inhabited by moose, caribou, deer and smaller game, but enjoyed by only shiftless Indians, who have never appreciated its possession.

Lunch was had afloat, for we wanted to get to the Big Fork river that evening. Night overtook us about 3 miles above, where we camped. The Big Fork was reached next morning about 9 o'clock. Here we stayed long enough to exchange a few words with an old settler, who had made his home at the forks of the rivers, thinking the water-power at the rapids

above would make his land valuable for mill and townsite purposes. He now lived by fishing; sturgeon being his principal catch, the bladders of which he dried and sold.

The Big Fork, down which we paddled 5 or 6 miles an hour, is a broad, rapid stream, having its source near Lake Winnebegoshish, and winding its way through a country of great possibilities. The vast amount of timber to be cut and marketed; the almost endless extent of land, which when cleared and cultivated, will be rich and productive, the many opportunities for water-power; and the fact that iron and coal exist there, will one day make this portion of Minnesota resound with the hum of trade and industry.

The day's trip was one to delight the heart of any lover of canoeing. Taking things easy, we moved along, enjoying the fine scenery and fresh warmth of the June day. Straggling crews of loggers were passed, and an occasional batteau-driver, as he poled his heavily-loaded boat along the shore.

The high, dry banks were pleasing after being so many nights in the swamps. We selected a good camping-spot in a pine grove and stopped early. Hilligoss, being an expert at making balsam-bough beds, was assigned this work; while the others straightened out the baggage and prepared supper.

The ride to Rainy Lake river was without incident. We reached the North side of the Rainy about dark, and camped on the bank near the landing-place of the steamer. The next morning we boarded her, bound for Fort Francis.

The boat went down stream a short distance to unload some merchandise marked for Hannaford, which we found on a map to be the destined metropolis of Northern Minnesota, but which at that time was a clearing of about 5 acres, covered with stumps, and not a building in sight.

Forty miles up the Rainy river, from the mouth of the Big Fork, brought us to Fort Francis; a small Canadian village, so slow and easy-going that when a mail arrived, the inhabitants were told of it by a flag on a mast in front of the post-office. The attraction here was the falls, which we photographed from several directions.

We took passage on a small steamboat that ran daily to Rainy Lake City, and were soon in the midst of a country of islands and water, which continued until the Gold City was reached.

This mushroom town, scarcely 4 months old, looked prosperous; having 30 or 40 buildings, ranging from the bachelor's cabin to substantial story-and-a-half frame houses. Most of the inhabitants were busy making boats, and preparing for prospecting among the surrounding islands.

We sailed over to the island on which the Little American mine is located; then re-

turned to the city and were soon on our way back to Fort Francis. We were obliged to wait 48 hours for the steamer, bound for the Lake of the Woods and Rat Portage.

The trip by boat from Rainy lake down

the Rainy river, and across Lake of the Woods, will some day become a favorite one for pleasure seekers.

Rainy lake may not rival the Thousand Islands, but for natural scenery it is all one can wish.

## THE KING OF THE GAULIES.

MARK T. LEONARD.

Many of the sportsmen of Western Pennsylvania, West Virginia and Maryland will recognize, in the above cut, "The King of Gaulie Mountains" whom so many have



THE KING OF THE GAULIES.

followed through the wilds of West Virginia, in the region about the head waters of the Elk and the Gaulie rivers.

Harmer Sharp is one of the best known hunters and guides in that state. His services will not soon be forgotten by those who have been with him through the Gaulie, South, Middle, and Leather-bark mountains.

His training, from youth, in the science of woodcraft in these remote regions, has made him a most skilled, cautious and valuable aid to hunters going into these vast, unbroken forests.

It is not generally known that such wild, uninhabited regions still exist, within the boundary of the old colonial states, as is this domain of the Gaulie King.

Mr. Sharp lives at the foot of the Gaulie mountains, near the junction of Slaty fork and Elk rivers, where he owns a comfortable little home and 1,000 acres of land, on the Northern edge of this mountain wilderness.

During the hunting season he guides hunters to and from the mountains, where many deer and bear are killed each year. He is an expert marksman; and when his old 45 Winchester sends the echoes ringing from hill to hill it generally means one more antlered monarch down. "Crockett" speaks of him as being one of the best shots in the state of West Virginia.

It was Mr. D. C. Braden, the champion one-armed wing shot of the world, who crowned and dubbed Sharp "King of the Gaulies"; and by this name he has since become familiarly known among sportsmen who visit this district.

Uniontown, Pa.

"Where can I get good country board?"  
 "Well, I should say in the oil regions.  
 That's the best bored country I know of."



TURTLE LAKE CLUB HOUSE.  
Turtle Lake Rod and Gun Club, Canada.

### TURTLE LAKE.

Turtle lake is about 360 miles Northwest of Montreal. Its nearest railroad point is North bay, on the Eastern extremity of Lake Nipissing, and is the Northern terminal of the Grand Trunk Railway, 227 miles north of Toronto.

In the fall of 1895, The Turtle Lake Rod and Gun Club was organized, and during the summer of 1896, the Club built a new house, which is shown in the cut.

North Bay is reached via Buffalo and Toronto, 24 hours from New York. Fare, for round trip, \$27.00. Turtle lake is 5 miles long, and varies from  $\frac{1}{4}$  of a mile to 2 miles in width. It is one of a series of 3 lakes, Trout, Turtle and Lake Salmon, which form the headwaters of the Mattewan river. It is North of all civilization, in the unbroken wilderness of Canada. The cabin is on an island, about 3 miles from the head of the lake.

The fishing is excellent; small mouth bass abound, varying from 1 to 5 pounds. Brook trout are plentiful within a distance of a few miles; muskalonge are to be had in Turtle and Trout lakes. In 1892 Mr. W. B. Capen, a member of the Club, caught one weighing 32 pounds. In May and October salmon trout fishing is good in Trout lake. Pike and pickerel are abundant, and weigh as high as 8 pounds. Moose, deer, bear, foxes, and smaller game are found in the adjacent woods. Ducks and ruffed grouse can be had after the middle of August. The average temperature is 65° F., for August. There are no mosquitoes nor black flies after July 20th.

October and November are the best months for hunting.



I send you a picture of a high bred cocker spaniel, owned by Mrs. A. J. Perham, Wakefield, Mass. He is a very intelligent dog and besides being a fine hunter can do a number of interesting tricks. He is a favorite with everyone, on account of his kind disposition and his great intelligence. He is now 8 years old.

Percy J. Bowker, Bryant Pond, Me.



# ELKLAND.

ERNEST SETON THOMPSON.

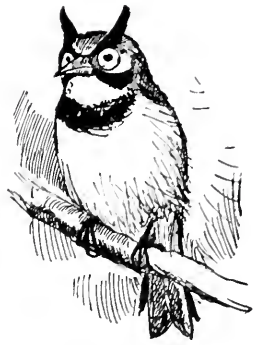

Any man who would describe a trip from New York out to the West must be either a Shakespeare or a fool. I do not claim to be either.

As we left Minneapolis, in the glow of a red sunset, we had the first truly Western thrill. We had crossed the Mississippi, but now, for the first time, I really felt myself back in the West. A prairie meadowlark sang the dear, old strain so familiar and so long unheard and his song awakened many pleasant memories.

As we went on we continued to look for news of the formidable Indian rising that the papers were then full of. At New York it was a terrible and bloody outbreak. At Chicago it was widespread and dangerous. At St. Paul it was very threatening. At Bismarck the authorities were said to be taking precautions. At Miles City, few seemed to know anything about it, but one man remembered that the sheriff had arrested an Indian for being drunk and impolite.

While I am correcting popular error, let me give you a quiet hint about that badger business. There's nothing in it. I mean the report that an enterprising Yankee, at Bismarck, has a lot of tame badgers trained to dig postholes, and that he is making a fortune by their hitherto wasted energies. At the Mandan Railway station is an interesting display of curios, among which



"ABOUT THAT BADGER BUSINESS."

is a shorelark, mounted as the taxidermist thought it should be. The man is a discoverer as well as an artist, and having satisfied himself that the shorelark belongs to the owl family he improved on all previous attempts, and produced something like this. If he meant it for a joke, it is a good one. If he didn't it's better.

It is well known that a sensible person always conforms to the custom of the coun-

try he is in. And we, determined to be like the natives, outfitted at Chicago, with broad sombreros and complete cowboy (and cow girl) togs. Of course, we felt a little strange among the Easterners; but we knew that once over the river, we should be merged in the mass. As we went Westward, we could see a faint infusion of broad brims, but still our sombreros were away West of the West.

We continued to hope we should not be peculiar when we were really in it; and at last, on arriving at the Yellowstone Park, we encountered the first genuine cowboy, in up to date togs. He wore a hat like our own and we felt that at last we were *en règle*. We were; and all would have been well, but alas! alas! we soon learned that he was a dude, fresh from New York, and out West for the first time in his life.



"WE OUTFITTED AT CHICAGO."

Twice in one day, during our trip across the prairie, did I see the dry grass set on fire by sparks from our own engine, when the use of the exhaust sent showers of burning coals from the smoke stack. These fires were of course attributed, by the settlers, to marauding Indians.

About noon of June 8th, we entered the paradise called the badlands. They presented the most bewilderingly beautiful and fantastic formations, and exquisite tints, I ever saw. The journey through them was like a succession of unspeakable sunsets. I now realized, for the first time, what was meant by the color vulgarization of many of our well known artists, who have flattered themselves they could show the world, on canvas, what the badlands are like. As soon as possible, I shall attempt my own vulgarizing of their delicate hues.

At Livingston we entered the mountains. Now, between ourselves, I have never had much love for mountains. They always seem to me aggressive, overpowering, inaccessible and brutal; and they always seem posing for admiration. They give one a shut-in feeling, and make things seem close and stuffy. I am a prairie bird, you see, and whenever I see a large moun-

tain, I always think what a grand prairie it would make if it were taken away, altogether.

However, mountains are charmingly inconstant in color, which they cannot help, for the prairie sun shines on them; so they may prove interesting. I shall reserve judgment. This is my first introduction, and it may be that, like ancestral Limburger, one may learn to like mountains by perseverance.

The other passengers uttered a lot of expressions that were quite new to me; such as,

"Look at those mountains; aren't they grand?"

"Oh, how I do love mountains," etc., etc.

Of course, I made a sketch. That's what I came for.

In the Park we saw the mamm— but no! I won't. I didn't want to see the—. Honest I didn't. But we "was druv," and forced to it. The only satisfaction I got was by pretending to know more about them than the guide did. And before long, the drove, then the guide, and finally I, myself, began to believe it was really so.

We promptly made the acquaintance of Captain Anderson, the monarch regent of the National park, and of General Young, the heir apparent. Captain Anderson has made a successful and accessible preserve of this place; and while he is personally one of the most popular men ever branded U. S. he seems to love the hate of bad men; and there is no lack of free and independent citizens hungering for his scalp. Men who know what he has done for the Park will be delighted to learn that at Gardiner, the other day, a lawless tough was overheard telling another,

"Damned if I don't believe Young is going to turn out meaner and cusseder, even, than Anderson."

As we hadn't come on a poaching expedition, and as moreover we were backed by RECREATION, we found the military despotism of the Park the reverse of irksome. It was the dread despot himself who showed us around, and helped us to the best guide, and the inside track, whenever there was one; who assisted in getting together an outfit; who gave us letters of safe conduct (so to speak); who uncorked his finest O. K. W.; who admonished "all whom it might concern" that we were backed; who convoyed us to our first camp, and who looked us up, periodically, to see that we lacked nothing. We found it difficult to reconcile our experience with the current account of the inhuman monster who reigned over the Park.

This is Elkland. Way back in the forties, according to Dodge, and other authorities, it was common to see bands of 10,000 to 15,000 elk, on the Yellowstone. To-day they say bands of 2,000 to 3,000 are

not rare, in the autumn. Wherever one goes, one finds elk horns. They litter the hills, and obstruct the little streams. One is never out of sight of at least 2 or 3. The other day I counted 8, within 100 yards. The photographer at the Springs has made a garden fence of some 120 shed antlers, picked up in the neighborhood, and the whole country, high and low, is pebbled over with elk signs. We are living on Elk creek. Yet we have not seen a single elk.

The reason is said to be that they are all up in the mountains, at their summer resorts, in 3 social grades. Lowest, in the wooded pasture lands, are the does, with the fawns. Next grade, higher up, are the yearlings; and away up near the snow line are the bucks, devoting their every moment and energy to growing their immense antlers and getting fat for the social life and lively doings of the fall—and for the annual winter famine.

From time to time, on our travels, we come to a scene like this; and when we remember there were 6 feet of snow last winter, and that the saplings in the valleys have the bark gnawed off, for many feet up, it is not necessary to call in the aid of a poacher to account for the downfall of the antler-bearer.

When I say we have not seen an elk, that means we did not during the first week. We saw plenty of antelope; and one evening a pair of blacktail deer strolled up to our cabin door, and blew their noses at us. Nearly everyone we questioned replied,

"Why, yes; I saw 60 or 70 elk a mile from here." Or

"Yes, I saw about 100, back of the ridge," etc.

At length we girded our loins and our horses, and said

"Here goes for Elkland. This cabin isn't much more than a mile higher than



AMATEUR PHOTO BY MRS. E. S. THOMPSON.

FALLEN.

New York; so we'll head for the high life summer resorts."

My wife and I, accompanied by Dave Roberts, an experienced hand, set out together. First we rode up to a favorite watering place, the "Nymph Spring." No!



AT 40 YARDS.

not high enough. We tried Calcite Springs and Lohe. No! another 1,000 feet needed. And we took the elevator once more, coming to a high, upland plateau over Tower creek. Then, looking around, we saw 3 antelope. It was like a jeer. They seemed to say,

"You ain't high at all. You are away down on the plains, among the antelope."

So we kept on, and at last struck a great multiplex track. This led us into a wood, and we came, finally, on a band of cow elk—the lowest of the 3 social grades.

They were lying down, and I had time

to make a few sketches, at 40 yards. And here let me remark that my sketches are not photos. They are impressions; and with the help of a little imagination (you have one, I suppose) they will suggest pictures—maybe.

Well, I sketched away at the elk, and made notes that were useful—to me at least—when suddenly the wind changed. They must have smelt us, for they ran. The dozen we had seen became scores. The alarm spread, and away they went, leaping, and crashing through the woods, till the sound was like that of a tornado; and they passed from our sight.

This was the first time either of us had seen a wild elk. It was also one of the times when we had no camera; but we shall soon go elking again, and shall go fully armed. Don't mention this to the



AT 50 YARDS.

Park authorities, and you shall have some of the results, whether or no.

Here are some elk signs, for an appropriate tail piece.

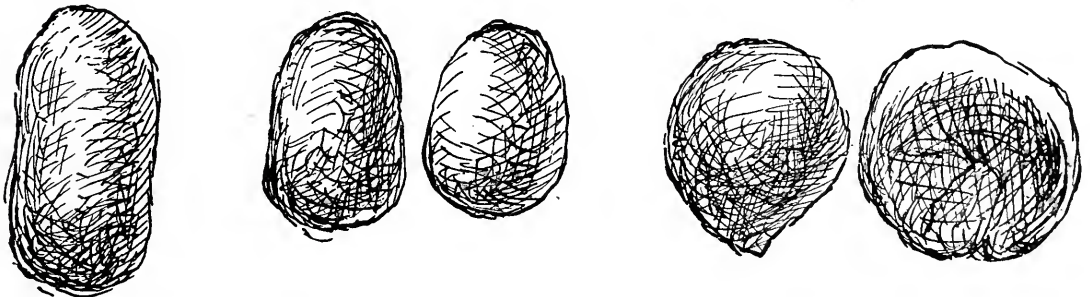

ELK DROPPINGS.

1. Winter; chiefly of bark.

2 and 3. Spring; bark and grass mixed.

5. Summer; wholly grass.

4. Summer; chiefly grass.

## THE BEAR, THE BELLE, AND THE BLACKBERRIES.

FRANCES WEBSTER.

If any apology is needed for the secondary position of the Belle, in the title, it will be found in the state of the young lady's mind when she met the bear. At that moment, he was the more important.

Isabel Reed had the good fortune to be pleasing in appearance; so some of her admirers, with no great effort of wit, called her "the belle." All one winter Miss Reed burned the candle at both ends, and attended strictly to the occupation of amusing herself all summer. By autumn, she was thin, nervous and cross. In consequence, she was banished to the country to recover her lost health and temper, and to furnish a subject for this story.

She found a quiet home in a country village, with a relative, where she rested for a short time. Then she turned her attention to the people about her. The country girls and their beaux, as her aunt called them, interested her. There were more girls than young men at East Saugus; consequently much competition.

Miss Belle stepped daintily into the arena, taking in the situation with wide open eyes of experience. She resolved to establish peace in the ranks, for a time, by conquering the whole company at once. The native belles did not recognize the temper of their foeman's steel. They hardly thought the thin, pale stranger dangerous. They had to learn the value of her tact and social experience.

It soon came about that when she walked, Madge Earle's quondam admirer carried her umbrella; when she sailed, it was May Lewis' beau who managed the boat. She talked and rode with escorts innumerable. At the parties given in her honor, she was surrounded by attentive young men. She sang, and they all listened; she smiled, and the other girls were forgotten. To make matters worse, she was so charming to the discomfited maidens, they themselves could not but admire her. Belle did not flirt, as they understood the matter. No young man monopolized her, none made love to her.

Let it not be thought she sanctioned neglect of other girls. She somehow made it known to the young men that courtesy to all is duty. She raised the standard of company behavior. In her bright presence no girl frowned or pouted, but they learned to smile, at suitable times, and say pleasant things always. In this way, unconsciously, Belle brought to East Saugus the spell of social observance.

Miss Reed was used to marked attention, but she had never reigned before. It required diplomacy to keep the train intact,

letting no one advance or retreat. She enjoyed herself immensely, as did the least favored of the village girls, who had no beau to lose. Belle, on the rare occasions when her conscience pricked her, made them, together with her short stay—and Richard Lane, her excuse.

He and Belle had long been friends, but had quarrelled. If any trifling heartache had arisen from this affair, she may have hoped to get rid of it by distributing it among the other girls. With much surprise, she saw Lane arrive, with the morning mail, 2 weeks after her own arrival. Before she met him, this was all hidden. She smiled sweetly, and coolly gave him a chair on the piazza.

"How do you amuse yourself here?" he asked, after some formalities.

"I am not in search of amusement. I came here to rest; it is very quiet."

"Would you not like to go for a ride? Perhaps I can get a rig."

"Thank you," she smiled, "I am going this afternoon—with a young man here, a Mr. Rogers."

"Ah, then how about a stroll, or a row this evening," he persisted.

"I am so sorry, but I told Mr. Moore I would walk with him this evening; and possibly there will be a boating party. If I had known you were coming——"

"Yes, I see," he interrupted, "Well, I will leave you to your friends. If at any time you have an hour for me, you can send word. Good morning."

Belle looked after him as he went down the street. "He needs a lesson," she said under her breath. "Yes, I will send word—when I forget myself."

She went on with her rides and other amusements. At every turn she met Lane, smiling and happy, surrounded by a group of beaming girls. How he had managed to meet them, Belle did not know. The girls revelled in the situation. They turned the tables with all their might. Parties, picnics and all possible diversions rapidly succeeded each other. When the 2 strangers met, they were indifferently civil. The astonished young men found the girls able to talk of nothing but Mr. Lane's attractions.

For a final festival, before Belle's departure, and as a last resort of inventiveness, a blackberry-picking excursion was arranged, by May Lewis.

"You see," she said, to George Moore, "it will make a nice, long ride, for we will go to Burnt mountain and take our luncheon. We can pick berries or not, as we please. It is lovely there; so wild. Mr. Lane will enjoy it."

"Perhaps Miss Reed may not care to go."

"Perhaps not;" very sweetly; "it may be too rough for her. Still, Mr. Lane wishes it, and we will arrange it somehow."

Early the next morning, about 20 young people left Saugus, in one large wagon. Belle occupied the front seat with the driver. Her tin pail was as big as anybody's; her face wore its brightest smiles. Her's was the clearest voice in all the song and laughter.

For a mile the road wound through the forest; then came a clearing. The side of the mountain for acres was covered with stumps and blackberry bushes. The horses and wagon were left at a house by the road, and the gay party started out, laden with empty pails and lunch baskets. With the tact that kept her place pre-eminent, Belle chose 2 little brothers for her escort. They were the first to reach the berries. Belle was the life of the party all that day. Her smiles and pleasant words were distributed as plentifully as the blackberries, and were just about as impersonal.

The merry crowd picked and ate, and picked to fill the pails, which soon grew heavy; ate more berries, and then lunch. The girls got lost, and were found again. They tumbled from stumps and slippery logs. They found treasures of goldenrod and autumn leaves; more than the most gallant of the boys could or would carry; but never for a moment did they forget to entertain Richard Lane. As for him, if his head was not turned, it was because he understood the situation.

When it was yet early, all the berries they could carry had been gathered. So the pails were grouped in an open space while the pickers rested. Belle looked at the spoils with pride.

"My berries are really the finest," she said.

"Let's exchange," suggested some one, in a whisper.

"Ah—no," said Belle, with energy, "I'll hide mine." With a little effort, she lifted her pail and carried it some distance along the path, around a clump of bushes, out of sight of the party. She quickly came back, flushed and laughing, to join the others, who were climbing to some rocks higher up the hill, where, warm and tired, they all rested.

"Would you really have cared," asked May Lewis, "if any one had exchanged berries with you?"

"Indeed I would. They are not blackberries alone, but also sentiments. To-morrow Aunt and I will put sugar with them, cook them and put them into jars. Later I will pack them into my trunk. Next winter I shall eat them all—yes—all. I will devour my memories of East Saugus; my moonlight rows, the delightful drives, the dance in Mr. Moore's new barn—"

"And what of us," interrupted Moore; "Are we, also, to be devoured?"

"I think you have been," whispered Madge Earle.

Young Moore was a handsome fellow. As he lay against the gray rocks, looking up into Belle's face, Lane noticed, and interrupted.

"There is a well defined path," he said, "across this field. Is there another house in here?"

"That's a bear trail," calmly explained one of the little brothers.

"Ah's!" "Oh my's!" and various cries arose in chorus from the girls. Over the group had come disquietude; a decided tendency to peer closely into the bushes; to start at sounds.

"As Mr. Lane's geographical thirst seems to have spoiled our good time," Belle said, rising; "let us go."

She led the way down the hill, to the spot where the berries were stored. The other girls picked up the baskets and started toward the house. The young men, led by Moore and Belle, went to get the berries. He offered to carry hers for her.

"Yes, but I must find them and carry them a little way. I intend to eat them all, and as I did not pick them all, I wish to do something to cement my ownership."

The boys picked up the pails and started to follow the girls, Richard well in advance.

Moore and the little brothers dallied, waiting for Belle and her berries. At that moment a cry startled them. It was not loud, but alarming. It thrilled one heart, Richard's, for it was his name, and the voice was Belle's. The young men sprang with him to the nook where she had placed her precious berries against a stump.

She stood with head thrown back and hands raised, facing a great black bear! It had risen on its haunches and was holding up its paws as if to imitate the girl. Near it, half emptied, lay the pail, while the red juice of the berries dripped from bruin's jaws.

Lane was the first to act. He sprang forward and would have made some foolish attempt to rescue Belle, but Moore quickly grasped him by the arm.

"Hush," Moore said. "All draw back. Belle, come here, slowly; keep your eyes on the bear."

With rare presence of mind, she obeyed! As she retreated, the bear settled down to his interrupted feast. Belle clung to Richard's arm with all her might. She did not realize yet her complete capitulation. All now retreated in good order, though most of the party felt a strong desire to run.

Belle was petted, consoled and made much of. She was too excited to realize her adventure. She lost her self control and laughed and cried a little, like any girl, and the girls liked her better for it—and for one other reason.

All of the party were at the station the next day, to say good-by to Belle, and to Richard, for he went with her. They took no jam with them; but the next autumn they received several jars, together with more expensive presents.

At East Saugus, people still relate won-

derful tales, until they become traditions, of the charming city girl, a real belle, who reigned among them for a space, and who was the heroine of an interesting, though not fully understood, love story, and of her real, indisputable meeting with a bear, on Burnt mountain.

## A BOATING SONG.

E. W. MASON.

Lazily dip our quiet oars  
As we steal away from the silent shores  
That erst have rung with notes of glee,  
And re-echoed our heart-felt revelry.  
Slumbers the wave, but wherever the blade  
Reluctant a lingering plunge has made,  
Its path is with flashes of pearl-foam dight,  
And the sleeping billow springs into light.

E'en thus from the slumbering past, of thee  
Arises a gleam of memory;  
And the meanest sights have power to bring  
Thy form to my nightly imagining:  
Sittest thou now—'tis the hour of love—  
On the rock-worked couch in the orange  
grove,

Where from shrub to shrub, with their tiny  
light  
The fire flies flit through the perfumed  
night.

O then, when drifts the moon's pale beam  
Through trellised boughs on yon murmur-  
ing stream  
And calmly white the effulgence rests  
On the black rough stones, midst the flash-  
ing crests,  
Think but of me, as away we glide  
And skim the green sea's quiet tide,  
And swiftly dip our sparkling oars  
As we dart from the shade of the silent  
shores!

## DEAD BROKE.

Break, break, break  
On thy white-shelled beach, O sea!  
But you'll never be half so broke (no joke!)  
As the hotel bill made me!

O well for the bathing suit boy  
That he shouts when the waves are at  
play!

O well for the sailor lad,  
For he has no hotels to pay!

And the stately ships go down  
To the haven under the hill;  
But O for a check on a river bank  
That could settle a hotel bill!

—Atlanta Constitution.

## HOW WE PHOTOGRAPHED THE WILD CAT.

COYOTE BILL.

We called him "Old Kodunk." His maiden name, that he brought to Colorado with him, was "Big Kate"; but when he got struck by lightning we christened him "Old Fireworks." Then when he insisted on calling my kodak a "kodunk" we branded him over again. Just what his sure enough name was I never learned. He was so modest he never seemed to care to talk about himself, and his past life, and I never urged him.

But as I was going to say, when Old Kodunk got mad about the coyote photographing contest, I had to round up a new partner, in the trapping business. He was a tenderfoot, just out from the East, but he seemed about the right calibre, and had a look in his eye that said he would hang to danger till the rope broke, and then go chase it. So I told him I guessed he'd do. We set our traps in a wild little canyon, where I had caught wild cats the season before. I furnished the traps and horses and he rode out every morning to look after the traps, and was to bring me word if we caught anything worth photographing.

I knew there were lots of skunks in the canyon, as well as wild cats; but I did not let him know it. I reckoned he would find it out for himself. And he did, you bet, for he caught one or 2 skunks every morning, for about a week, and buried a suit of clothes every day, till he had nothing left of his wardrobe but a pair of boxing gloves.

So one morning, when he failed to show up at the store, I guessed something was wrong and slid around to his house to see what the trouble was. I found him sitting out in the back yard, with nothing on but a pair of old overalls and a gunny sack.

He looked sad and disgusted, like, and didn't wear his accustomed smile. Guess he had buried it with his last suit of clothes. When I got around on the off side of him, away from the wind, I inquired the cause of his seeming sadness; but he didn't seem inclined to talk much and, fearing he might get mad and quit, I didn't urge him. I merely reminded him that "faint heart never won fair lady"; that "virtue was its own reward" and a few other quotations, of similar nature, that I had read in Shakespeare and in RECREATION.

Then I loaned him an old suit of corduroys and turned him loose again on the cat track. It was not long after this till I met him, one morning, coming up the street, with a big smile playing on his countenance, like a flock of buzzards around a dead steer, and I knew he had caught something more than a skunk this time.

"Hurry up! Fox in one trap, wild cat in the other. I killed the fox, but the cat's alive and all right for a picture. Saddle your camera and bring your horse, and be quick about it." He got things mixed a bit; but I knew what he meant, and was not slow in getting my snapshot outfit in shape for the trip.

We had made our brags that if we got a wild cat we would first take its picture and then bring it in alive. I knew the eyes of the amateurs of the country were upon us, and that the RECREATION prize was at stake. I also knew it was no easy job to take a Rocky mountain wild cat out of a steel trap and bring him in alive. I wished I had Old Kodunk back again, for he never missed fire on such occasions; so I sent him a cipher dispatch, by a kid, on horse back:

"Bring lariat. Wild cat alive in trap. Take our old trail by Convict Wilson's cabin.  
Coyote Bill."

It fetched him, you bet, and he was there on time. I thought while we were having a picnic with the wild cat we might as well stir up the other animals too; so we got one of the cow boys to start the report that we had a mountain lion, and were going to fetch him in alive.

We got a big crowd in no time and directed them to take the right hand trail beyond the Soda Point; but while they were off after horses and saddles we slid out in a hurry, on the left hand trail a mile this side, and were soon paying our compliments to the wild cat.

He didn't seem much pleased to meet us and kicked up an awful dust when he saw the kodak. Then we let him have one end of the lariat, across his back, and he squared around as if he were ready for business; opened his mouth wide and cussed us, in cat language, in great shape.

I got in 2 good shots with the camera, but they didn't suit me. Light was not quite right. So we dusted him off again, with the lariat, and coaxed him up a little cedar tree where he sat, looking out between 2 limbs as natural as could be; just as the sun peeps out over old Pike's peak.

Such a chance for a snap shot a fellow doesn't often get; and I improved the opportunity. I took 2 turns at him with the kodak. Then we got the lariat around his East end, and a smaller rope around his West end, and strung him out. I took another snap just as he was helping himself to a bite of Old Kodunk's whiskers. Then, after a good deal of cussing from Old Kodunk, and words of exhortation from the

"skunk killer," we got the cat in the sack, all right, and hit the trail for home.

We had plenty of fun with the wild cat, but it was more fun watching the suckers on the hills, a mile beyond. "The woods were full of 'em"—men and boys on horseback, looking for the mountain lion we had told them of.

We hurried on so as to get out of sight before they saw us. Old Kodunk was in the lead, pushing his horse along as fast as he dared, down the steep trail, when all at once, just as we reached the bottom, we saw something on the trail, just ahead, coming our way.

"What is it?" I asked.

"Wonder if it's branded," said Kodunk. The skunk killer laughed and looked kind of surprised, but seemed to know what "it" was as soon as he saw it.

From what he told me afterward I judged they were quite common where he came from. Don't think they even took the trouble to brand 'em. "It" proved to be a young professor, fresh from Oberlin College. He was out here for his health; growing a new lining on the inside of his breathing box. He was one of your high toned young ducks, and wore a silk hat, a white neck tie and gold rim eye glasses—one of the kind that sleeps on a dictionary and covers himself with a grammar. He fired a whole charge of proper language into us, before we had a chance to pull a gun or get under cover.

"Pardon me gentlemen; I am informed you have been fortunate enough to procure a catamount, alive, and if it would not inconvenience you too much it would afford me great pleasure to be allowed to inspect the specimen."

Kodunk looked at "it," as if he felt sorry for it. Then he fired back,

"Well! Young feller, I don't know nothin' 'bout 'procurin' cat-ermounts' but if you want to see a big Rocky mountain bob cat just shed your goggles a bit and peep into this here sack when I tie 'er loose."

The professor flushed up a little, but I think he wanted to see the cat pretty bad; for he didn't get mad. He only said something about "being able to retain perfect vision through his lenses" and "wishing to write little episodes of Western life to his friends East," and some other such guff, I didn't just catch on to; but I reck-

oned he'd get his fill of "episode" before he got through with Kody and the wild cat. So I draws off to one side and waits for the circus to begin. Then Old Kodunk lets up on the rope and the professor stoops over and peeps into the sack.

Then there was an instantaneous exposure, for about the one-hundredth part of a second. A big paw hit the air and we saw a silk hat playing tag with a pair of gold rim eye glasses, in the sunbeams above our heads. Then Old Kodunk pulled the sack together again.

I wanted to laugh, but out of respect to the stranger from the East I kept still, while Old Kodunk draws himself up, looking sober as a judge, and says, by way of apology:

"I forgot to tell you, stranger, that bob cats is kind of suddent like."

We left the professor sitting on a rock, wiping the dust from his "lenses," and I guess he's there yet, for we haven't seen him around town since.

Old Kodunk and the skunk killer took charge of the cat, while I went to the store to develop my pictures.

I rocked the tray gently back and forth, according to directions, and waited. Then I rocked some more, and waited again; but nothing appeared on the plates. Then another rock and I began to think hard things about photography; but I kept on rocking till I was satisfied something was out of gear. I got mad and fired the whole outfit in the trash barrel. Then I went out of my dark room, into the store, and made some impolite remarks, not necessarily for publication but as an evidence of good faith. These remarks were addressed to the boys who mixed the developer for me. Or rather they hadn't mixed it; for investigation proved they had left out the sulphite of soda! Had I been a photographer, instead of an amateur, as soon as I found something wrong I should have covered my plates, mixed new developer, gone to work anew, and got my negative all right; but unfortunately I was only an amateur, learning by experience, and that experience cost me my picture—and the RECREATION prize.

Moral (for amateurs and college professors only): Mix your own developer, and don't look in the sack just because Old Kodunk tells you to. He's a tricky old cuss.

---

"The pitch of that roof," said the architect friend,

"Is not enough by a foot or more."

But the sun came out, and the pitch on the roof

Dropped onto his neck, and the architect swore.

—Cincinnati Tribune.



## THE WOLF QUESTION.

FROM WYOMING AND MONTANA.

Ames, Neb.

Editor RECREATION: Replying to the questions propounded by Mr. E. S. Thompson on page 45 of July RECREATION I have this to say:

Wolves have caused enormous losses to cattle men, in Eastern Montana and Wyoming, and Western Dakota. No one can estimate the amount of such loss, for the last 8 or 10 years. Some people reckon it greater than the average losses from winter exposure, and without any doubt the wolves have destroyed many millions of dollars' worth of stock, within this time.

For the last 2 or 3 years, in Wyoming, we had persuaded ourselves that the number of wolves was sensibly diminished, through our efforts; but this year the entire Northeastern quarter of Wyoming is suffering greatly from their ravages. Our own cattle company, with 2 hunters operating in Montana and 2 in Wyoming, has killed 250 wolves in the last 3 months, principally puppies.

It is extremely difficult to catch or destroy grown wolves, and so far as I know no one has ever yet been able, by any means, to kill enough grown wolves to effect any valuable decrease in their numbers. A good many are killed by poison, but I do not believe that in a score of years the number of wolves can be greatly lessened by the use of poison, by as many hunters as choose to use it. After a short time the wolves refuse entirely to take baits, and they are not under the least compulsion to do so as there is always an abundance of food in the shape of calves, cattle and foals, all over the range.

I have known a small ranchman, having in a pasture 11 head of mares, with 11 foals, to have all the foals and one mare killed by wolves, within a short time. I heard, this year, of a ranchman with a small bunch of cattle, having lost one of his calves every night until all were gone. The depredations of these hungry brutes are not confined to calves. They attack and kill all classes of cattle; but naturally more calves than older animals. On the spring roundups, recently finished in Wyoming, there has been everywhere evidence of great numbers of wolves, and many cattle are found, in every drive, wounded and bitten.

Our range in Wyoming, where our breeding cattle are, is in Crook county, the Northeast county, and as I have said, wolves are very troublesome in that country; also in the entire country on either side, East in Dakota, South and West in Wyoming and North in Montana. They have been particularly troublesome in Converse, Natrona and Johnson counties, Wy-

oming. I do not know that they destroy many sheep, as these are always penned at night, and are in charge of a herder in the day time; but they destroy vast numbers of calves and cattle, and are particularly fond of foals.

As I have said it is impossible to estimate the amount of damage, but I should judge it to be \$50,000 a year, in our own county, and \$500,000 for the entire State of Wyoming, which is twice the cost of running the state government.

I have never known of a grey wolf injuring or even threatening a man, on the plains. Sometimes they are very bold, and finding that a person approaching them is not armed make no effort to get out of the way. I have heard of perhaps 2 fairly authenticated cases of wolves being really menacing or dangerous, to men; but nothing of the kind has come within my own observation. The reason for this is that there is always an abundance of food present, and the wolves never suffer from hunger. Their food is so abundant that at times of the year the old wolves get very fat. They are then so short-winded they are easily overtaken and roped, by cowboys.

We believe we have had some valuable effect in decreasing or holding down the numbers of wolves, on our own immediate range, by our efforts, for a number of years. Since the spring of '95 we have killed about 500 grey wolves, on our range in Wyoming; and for the few years preceding '95 had killed a considerable number, but not so many. Last spring they appeared as numerous, or more so, than ever for a while; but as the roundups progressed and our cowboys made reports of other ranges, we find our efforts have not been without effect, and that there are fewer wolves in our immediate country than on neighboring ranges.

Considering the Northeastern quarter of the State of Wyoming there are probably now as many wolves as there have ever been; and including the much larger territory mentioned before, the same is probably true. No one can definitely answer the question as to whether there are more wolves than 5 years ago; as accounts conflict greatly. There must, however, be as many, and perhaps more. Having abundance of food and being protected from cold, by living in holes in the ground, there is no reason why they are not increasing in numbers. They are very prolific, and the females have litters of anywhere from 4 to 12 or 13 each year.

I never heard any one mention such a thing as wolves making signals to each other, and do not believe they do. In Wyoming the hunting is so good, everywhere,

that it is not necessary for them to inform each other.

I do not know the size of the largest dog wolves that are found; but think some specimens have been found that were about 8 feet from tip of nose to tip of tail. The largest of them are certainly very fierce and formidable animals.

I think coyotes are more than a nuisance; and by many people they are supposed to kill almost as many calves as grey wolves, although they cannot kill the larger animals.

The proper way of dealing with the wolf question would be for the state authorities, of a number of neighboring states, to agree on a large bounty; the rate to be increased as the number of wolves diminished. I have made strong efforts to secure such united action; but it is impossible to do it. The majority of the members of the legislatures, of North and South Dakota, come from the agricultural districts, in the Eastern portions of those states, and they will not consent to such a measure. Nor can a sufficient bounty be secured, either in Wyoming or Montana. To day Montana pays a bounty of \$3 on wolves, or coyotes, pups and all. Wyoming pays \$4 a head for grown wolves, and 75 cents for pups. I believe the only way to exterminate wolves would be for a general and sufficient bounty to be paid, in cash, at convenient points; and to prevent fraud the pelts should be taken up, on payment of the bounty.

In Montana we pay 2 hunters a private bounty of \$2 apiece for grown wolves and \$1 on pups, in addition to the state bounty. In Wyoming we pay the 2 hunters \$25 a month each, with subsistence, in addition to which they get the state bounty.

I am doubtful if any means can be found to improve greatly the situation as it exists to-day, unless the general government could be induced to take hold of the matter, which I suppose is doubtful.

When representatives of the larger cattle companies have attempted to bring forward any bill, in the state legislatures, for the payment of large bounties of \$8 or \$10, the cry has immediately gone up that the corporations were trying to get money out of the state treasury for their own benefit. The mere suggestion that any corporation can get any benefit from any proposed law is enough to condemn it, in the eyes of many voters of these states; and it is always an effective war-cry for the cheap politician, who finds plenty of hearers.

For these reasons I do not think a law that would really be effective in exterminating wolves can be passed, in a number of neighboring states, and if it is not passed in all such states the wolves would be taken across the line into any state which does pay any large bounty.

For the last 3 seasons my own plan has

been to keep up continuous hunting, on our own range, in an effort to induce the wolves to migrate to other places. I admit this is not liberal, or public-spirited; but on the other hand, it is not intelligent or progressive for the voters of these states to fail to bring up proper legislation. A large bounty is the only effective thing, because that makes hunters of a great many people; and it puts into the field a large number of hunters who will exterminate the wolves.

In our own experience we have not been able, in hunting with dogs, to catch or destroy an appreciable number of grown wolves. They are too strong and well fed, and have too much endurance, to be taken and killed by dogs, without the greatest difficulty. The only thing we can do, that cuts much of a figure, is to trace the bitches to their dens and secure the pups.

Poison has been extensively used over the entire country, and I have lost many good dogs—deerhounds, foxhounds and bloodhounds—from poison. The baits that the wolves will not take keep for years, in this climate, the strychnine remaining in the hollow of a bone, perhaps, that a dog is likely at any time to pick up and gnaw, and thus to kill himself.

The reasons for the extreme difficulty in killing wolves in the chase, either with deerhounds or foxhounds, are the elevation of the country, the aridity of the atmosphere and the scarcity of water, so that the dogs suffer extremely from thirst. Much of the country, where the chase takes place, is extremely rough and the deerhounds and greyhounds, at the end of a 2 mile stretch, give out completely; while the wolf has still bottom enough to last him a long distance.

Our men have made a continuous chase as long as 15 miles, the wolf making a circuit to get back to the starting point; but the wolf was enabled to do this, and finally got away, while men and dogs were nearly on and close to him.

Foxhounds do not dare to fight wolves. Sometimes the wolves kill them with the greatest ease. Then again, when the wolf and the dogs become completely exhausted, the wolf sits down, with the dogs about him; but they dare not touch him. When sufficiently rested the wolf runs again and the chase is resumed. In fact we have not an animal in the shape of a dog that is strong enough, fierce enough, swift enough and that has enough endurance to run down and kill grown dog wolves. Our best dogs are only occasionally successful.

Some wolves are trapped, some are shot, some are roped by cowboys, and a number killed by poison, but still there are plenty left.

R. M. Allen, Mgr. Ames Cattle Co.

## FROM THE WIND RIVER COUNTRY.

Editor RECREATION: I see by your July number that you are agitating the wolf question—a question which has been and is now of serious importance to all cattle, sheep and horse owners in the Western States. In the section of country where I live, and where I have run cattle for over 15 years, the wolf pest has been and is a source of incalculable loss to all stock owners; so much so, that it almost calls for action on the part of the general government to protect its settlers and stock owners from the depredations committed by these blood-thirsty varmints.

Very few of the counties in the states mentioned in your article are in such financial circumstances as to enable them to afford a large bounty on wolf scalps, and the consequence is that unless some other steps are soon taken to rid the ranges of these terrible pests, they will increase to such an extent as to jeopardize the whole stock industry of the arid region.

Where I live we formed an association among ourselves, and paid \$25 a head, for each wolf killed in our county. Several hundred were paid for, but owing to various causes the association disbanded; and now one hears and sees, on all sides, evidences of the havoc played by these fierce denizens of the prairies.

Mr. Otto Franc, of Meeteetse, Wyoming, a large cattle owner, will be able to inform you of the exact number of wolves killed in this vicinity. He was secretary and treasurer of our association, and marked and tallied all hides and scalps presented for bounty; Mr. Franc has been one of the most energetic exterminators of wolves, and generally employs one or 2 men, during the winter, for the sole purpose of poisoning and killing wolves.

Mr. Jesse Frost, also of Meeteetse, who is an expert rifleman, has killed a large number of wolves and has had some long and exciting rides after them. In one instance I knew him to ride over 15 miles after a wolf, over as rough a country as it is possible to ride, and he killed the brute with a shot, as soon as he got close enough. I have known wolves, here, to kill 4 year old steers, and big, strong cows, and 2 years ago I saw where wolves had run down and killed a large bull elk. Their tracks were plainly visible and in a snowbank, nearby, you could see the marks where they had rubbed the blood from their mouths and paws.

I am glad to see you taking up this matter. The labor you devote to the cause will meet with its due reward, and you will not only give your readers a most excellent and interesting magazine, but you will become a benefactor to a large number of people who are living on what was so lately the frontier, and who, like all pioneers, are

patiently but steadfastly struggling, "to keep the wolf from the door."

I have pleasure in answering your questions in their order, and to the best of my ability.

1. Wise, Bighorn Co., Wyoming.

2. Yes.

3. All.

4. From \$8,000 to \$10,000.

5. I have authentic knowledge that a number of wolves have chased one person, but have never heard of any one's being killed or harmed.

6. Yes.

7. Am unable to say.

8.

9. I don't think coyotes do much injury to stock.

10. I think the federal government should offer a bounty on all wolves killed, the hide and scalp to be presented while fresh and green to the County Clerk of the county where killed, or to a justice of the peace, or a game warden; said hide to be retained by the officer to whom presented. For each full grown wolf a certain bounty should be paid, and for each wolf cub a smaller amount, about 25 per cent.

R. Ashworth, Wise, Wyo.

## FROM FREMONT CO., WYO.

Editor RECREATION: Here are Mr. Thompson's wolf questions, and my answers to them:

1. Where are you located?

Ans.: Lander, Fremont county, Wyo.

2. Are gray wolves troublesome in your region?

Ans.: Yes; more in the remote ranges than near the settlement.

3. What do they destroy? Horses? Cattle? Sheep?

All kinds of live stock, but more especially sheep and young cattle. I have seen a single gray wolf pull down and kill a 2 year old steer.

4. About what amount of damage should you estimate they do in a year, in your county or range?

Very hard to determine, but I should judge, from interviews with the cattlemen of this section, that the damage done by wolves and coyotes in this county would reach \$20,000 possibly \$25,000 a year.

5. Did you ever *know* of a gray wolf killing or harming a human being?

No.

6. Are wolves increasing in numbers?

Yes, rapidly in this part of the state.

7. Have you any reason to believe wolves can signal across country, and so tell each other what parts are dangerous or where the hunting is good?

Yes.

8. What is the average and the greatest weight and measure of a wolf, according to your certain knowledge?

Never saw one weighed but have measured some that were 7½ feet long and all one man could do to put in a low wagon.

9. Do you consider the coyote a nuisance; or do you consider the harm done in killing lambs, etc., more than balanced by the good they do in keeping down gophers, ground squirrels, etc.?

Yes a great nuisance, especially to the sheep industry.

10. What do you consider the best means—legislative and practical—of dealing with the wolf question?

State legislatures might offer a bounty of \$15 to \$25 on gray wolves, 50 per cent. of which tax could be met by the taxpayers of the state at large; the remainder to be paid by a stock tax, levied equally between the sheep and the cattle owners.

Frank Dunham, M.D., Lander, Wyo.

## THE BROADWAY CABLE SINGS.

(With a familiar refrain.)

MARGUERITE TRACY.

Step lively please! Step lively please!  
There're plenty of cars behind!

Step lively please! Step lively please!  
There's never a soul inclined

To wait until the next I bring,  
They're all so fond of me!

They're all so keen to crowd and cling  
And jostle merrily.

*Rattle their bones over the stones,  
Only some passengers nobody owns!*

I've got my fingers on the keel,  
I've got the car in tow;  
They trust themselves to me for weal,  
They'll trust to me for woe.

*Rattle their bones over the stones,  
Only some passengers nobody owns!*

I've got them on the Dead Man's Curve,—  
They can't get off this street—  
Just watch those wild ones swing and  
swerve!

I'll take them off their feet!  
*Rattle their bones over the stones,  
Only some passengers nobody owns!*

I'll make that tall proud girl fall down,  
I'll smash that stove-pipe hat;  
I'll make His Reverence play the clown,  
And what do you think of that?  
*Rattle their bones over the stones,  
Only some passengers nobody owns!*

I've got a death hold on the grip,  
I tow the Juggernaut.  
Now let that man who's crossing slip,  
Or let his heel get caught!  
*Grind up his bones over the stones,  
Only a passer that nobody owns!*

Step lively please! Step lively please!  
There're plenty of cars behind!

Step lively please! Step lively please!  
There's never a soul inclined

To wait until the next I bring,  
They're all so fond of me!

They're all so keen to crowd and cling  
And jostle merrily.

*Rattle their bones over the stones,  
Only some passengers nobody owns!*

There are still some unfortunate sports-  
men who are not readers of RECREATION.  
If you know any such send in their names,  
and greatly oblige them and

THE EDITOR.

## FROM THE GAME FIELDS.

IN FLORIDA GLADES.

G. E. K.

I have read, with much interest, the hunting and fishing adventures told in RECREATION and presume something from the wilds of Florida might be appreciated by its readers. I spent 4 enjoyable years in the land of flowers, and believe it unexcelled in furnishing enjoyment to the sportsman.

Two years ago, I took a party of my Ohio friends for a 10-days' hunt, in the Lake region of Polk county. There were 6 of us beside the guide and a cook; 2 of the party being ladies. With 3 light wagons we had a delightful trip through the piney woods, and among the many lakes, reaching a suitable camping ground on Lake Pierce, 20 miles from our starting point, about sundown. It took some lively work to get the tents up, and enough moss and palmetto leaves for our beds, before dark. There is little twilight in Florida; night falls quickly after the sun sets.

Every one was astir at an early hour, for the guide was anxious to go across the lake after game. We tramped the woods till noon, and although several deer were jumped, they were too far away for a successful shot. The hunters returned to dinner, weary and hungry; but full of hope and courage for the next day.

The guide went out for a little hunt of his own, in the afternoon, saying, as he left camp; "Didn't come out heah to eat salt meat; got to have some fresh meat in camp to-night." No one offered to accompany him, for every one was too tired for another long tramp that day.

To pass the time pleasantly, the vicinity of the camp was explored. On either side was a dense hummock of undergrowth—palmettos, cabbage-palms, and flowering jessamine. Not 100 yards from camp, there were fresh bear signs, showing where bruin had climbed a cabbage-palm, after the fruit. The ladies exacted a promise from us that at no time should they be left in camp without a protector.

The beauty of some of these wild spots is almost indescribable. Here the ax has made no inroads into the grandeur of the luxuriant vegetation; wild flowers abound among the graceful palms and bay trees; while here and there beautiful air plants and orchids may be seen gracing some giant cypress. The Spanish moss lends a wierdness to the scene, making it more beautiful and impressive.

Just at dusk the guide approached with something on his shoulders. To our surprise and delight he threw down 2 big gobblers. They weighed over 20 pounds each. The bronze plumage was beautiful, in the

light of the camp fire, and the birds were much admired.

At daybreak 3 of us took the boat and rowed across the corner of the lake, to what proved a hilly section, of barren brush and scrub palmetto, with occasionally a cactus. Here we met the guide who had ridden around. Soon the hounds struck a trail, and away we went through the brush and palmettos, only to have one of the hounds forge ahead and jump the deer fully a quarter of a mile off. All the consolation we had was the sight of its white flag disappearing among the trees.

About 10 o'clock a buck was started within shooting distance. We amateurs wasted some good powder and shot trying to stop him; while the guide sat on his pony, on an adjoining ridge, laughing.

The hounds were called back and put out again. Within 100 yards of where the first deer broke, another buck was jumped. This time we "pulled down on him," and he soon lay among the palmettoes, kicking his last. One man failed to see him fall, and kept on shooting. The guide almost rolled off his pony with laughter, yelling: "Don't shoot no moah, don't shoot no moah; you done kill him."

After the smoke cleared away, we found our friend had put a 38 Winchester bullet through the deer's heart; while several buckshot, from my Winchester shotgun, were scattered about in various parts of his anatomy. The shot made by the rifleman was a pretty one, and the verdict was in favor of the deer being his meat. I had to content myself with the consolation of having the only shot gun in the party that was fired, in the melee, and with knowing I had hit the deer.

The guide prepared our game for the trip to camp. It was a tired though happy party that gathered around the board that day.

We shot 5 more turkeys and one spike buck, during the 10-days' sojourn. Then we went back to civilization, with renewed health and vigor, but glad to sleep on a "sure-enough" bed, and ready to resume our vocations.

---

### SHOOTING ON THE WING

J. A. MACKENZIE.

How to become a good wing shot is even more puzzling than what gun to select. I am not a good shot, and frequently miss; but then we poor shots, when we do hit, get more pleasure from it than the gunner who chooses his bird and kills it with certainty.

These few suggestions to the beginner, will, I hope, bring out more practical information from the older sportsmen. First, learn to handle the gun quickly. Fifteen minutes' practice every day, in your room, snapping the gun at objects on the walls, will be of benefit. Empty shells in the chambers will save the hammers from striking the breech. Having decided what to aim at, fix the eyes on it and bring up the gun with an easy motion. When the aim is correct, or nearly so, press the trigger. Never try to better the aim but pull the trigger the instant the mark is seen fairly over the muzzle. Hand and eye should work in unison.

Keeping both eyes open increases the range of vision and enables a much quicker aim to be taken. Should the left eye be the stronger, close it and shoot with one eye; or grasp the barrels with the left hand so as to obscure the view of the left eye. However, practice with the left closed will generally result in the right gaining sufficiently in strength to align the gun, when both are open.

Practice snapping until the gun comes up truly aligned on the mark. The beginner should commence with shells loaded with  $1\frac{1}{2}$  drs. of powder, 1 felt wad and  $\frac{1}{2}$  oz. of fine shot. Practice with these at stationary marks, 15 or 20 paces away; high, low, to the right and left. When these can be hit 9 times out of 10, it is time to try moving objects.

Now, another difficulty arises. At birds flying straight away, or toward the shooter, the manner of aiming is the same as at stationary marks; but at crossing, rising, and descending birds, an allowance must be made.

An ounce of No. 6 shot has a velocity of about 840 feet a second, for the first 40 yards; therefore it takes  $\frac{1}{24}$ , or  $\frac{1}{4}$  second for it to go that distance. A bird flying at the rate of 40 miles an hour, an ordinary flight, would go about 8 feet in that time. Taking into consideration the time required to pull the trigger, which varies with different men, it would fly from 9 to 12 feet before the shot could overtake it, if at 40 yards from the gun.

Allowance for this is made in 2 ways: by holding ahead, and by swinging the gun past the bird. In the first method, many beginners make the mistake of not allowing for the time it takes to bring the gun up. This must be determined from experience, for it varies with different shooters.

The second method, which I think is the better, is less likely to develop into "snapping" at everything. Swing the gun in the direction of the flight, and as it passes the bird press the trigger without diminishing the lateral movement. By the time the shot leave the barrel, the gun has gained sufficiently on the bird to make allowance

for its flight. Some men move the gun far enough ahead of the game to make the allowance, but this is apt to make one a "poking" shot. Aim above rising birds and below descending.

Good practice can be had at sparrows. Use light loads of No. 10 shot and 2 drs. of powder. One will be surprised at the effectiveness and at the sport furnished by these little robbers, as they dart from stack to barn or rise singly from the fence.

The novice generally shoots behind and under game. Not because he does not know where he should hold, but he fails to put his knowledge into practice. He is, in common with many old shooters, likely to get into the habit of snap-shooting at everything. This is due to nervousness, and is difficult to overcome. It is a good thing to be able to make a snap-shot in cover, but in open the snap-shot is not in it with the deliberate shooter.

Several times last fall, I missed with the right barrel, at short range, and, cooling down a little, made a clean kill with the left. In deliberate shooting, the sportsman sees the bird over the gun, or follows its flight before he shoots. In every case, however, one should shoot at the first sight, if nearly correct. The nervous snap-shot frequently shoots even though he is aware the aim is not within several feet of the bird.

Some writers recommend target practice with a rifle, as likely to help the beginner in wing shooting. Has any reader of RECREATION tried it?

I will repeat, "Practice." Do not be easily discouraged. One cannot become a good field-shot with 1 or 2 seasons' work. The first fall I tried bird shooting, my bag was 2 woodcocks, one quail, and 3 ruffed grouse. The second season, after going through such a course of practice, as here outlined, I got 5 woodcocks, 21 quails, 10 ruffed grouse and 10 rabbits, besides several hawks and other birds. All these birds were killed on the wing. Twenty-five ruffed grouse are enough for any man in one season; and, to my notion, will furnish more sport than 2 moose or half a dozen deer.

---

#### WISCONSIN DEER LICKS.

Jamestown, N. Y.

Editor RECREATION: It may interest the readers of RECREATION, who never watched or saw a deer lick, to know how and what they look like. Last spring, from the 10th of April to the 19th of May, I was in Sawyer county, Wisconsin, propagating muskallonge. It is a wild, desolate place, 21 miles from a post office, between the Omaha railroad and the headwaters of the Chipewa river. Three years ago this country was traversed by forest fires, which swept

away the underbrush, leaving nothing but blackened trunks of trees and fallen logs, for many miles. So, if you are accustomed to seeing deer in their haunts, it is no trick to discover one in this locality.

I had been at Lost lake nearly 3 weeks, and had seen, in my travels around the lakes, numerous fresh deer tracks, but could not get sight of a deer, although, coming on my back track one day, I saw where one had stepped in one of my footprints.

I told our guide about it and he said I would see plenty of them if I knew how to look for them. I did not care to kill one, but simply wanted to see one.

One day, while exploring around the outlet of Wilson's lake, a small lake West of Lost lake, I discovered a natural lick, and it looked as if a herd of sheep had visited it, so thick were the tracks. It was about 4 o'clock in the afternoon, so I climbed a tree and watched the lick till nearly sundown. At that time I was rewarded by seeing a young buck suddenly come in sight, as if he had risen from the ground. He came leisurely toward the lick, till within 10 rods of it, when a puff of wind came up and he stopped. He had scented me and stood a few moments when another puff of wind came. This satisfied him and he gave that whistle so familiar to hunters. Up went his flag, and about the same time, to my right, was another signal and there went as large a buck as ever I saw. The way those 2 bucks sailed over fallen logs was interesting.

In about half an hour 2 does came right under me, went up to the lick and stayed there till I got tired of watching them when I moved a foot and disturbed the branches. This put them to flight in an instant. They looked thin, as if they had passed a hard winter. I came down from the tree, well paid for my trouble. If this had been in season I should probably not have seen a blamed deer.

This lick was at the base of some rocks, and a spring was close by that tasted strong of iron. I saw an artificial lick, near a lumber camp, that had been made by pouring brine on the roots of a large stump. Near by was a tree, with a ladder reaching up into the branches, where a seat was placed among the limbs. There the hunter seats himself, and when the unsuspecting deer come underneath he shoots them. Hundreds of deer are killed in and out of season, in this Northern country, during the year; yet you can hardly blame the settlers for killing what deer they want.

During the summer the deer have plenty of feed; in winter they have poor picking.

After I saw the first deer, among this dead timber, I had no trouble seeing them every day, during my stay at Lost lake.

The deer, up here in Wisconsin, are very large. They are light gray, while over in Minnesota they are smaller and darker and you will find among them some black tails.

The guide and cook we had was Frank Griffin, of Hayward, Wis.

Frank W. Cheney.

FIVE DEER IN 50 SECONDS.

Olympia, Wash.

Editor RECREATION: I noticed in the May number of RECREATION a communication from F. H. Knowlton, about killing 2 deer in half a minute. I can discount that record. Last fall I was in Clallam county, Wash., and hunted with a young man who had never seen a live wild deer, in his life. One night we camped at the foot of old Mount Constance; taking an early start in the morning to climb to the summit.

As we cautiously slipped along the crest of a ridge, I spied 2 deer, about 150 yards below. They heard us and were looking our way. I told my companion to get ready, for I intended to shoot the larger one. At the crack of my rifle they started, my deer tumbling backward at the second jump. As the other one reached the summit of the ridge, it stopped just long enough to get a bullet behind the shoulder. The killing of both took about 15 seconds.

The next morning we again started for the summit. Along in the afternoon, we saw a bunch of 6 deer, 60 yards away.

I got in one shot before they started to run. The buck I shot took a jump and turned up his toes. The others scattered, a big doe taking the lead, right up the canyon; and the biggest buck of the band was only one jump behind her. I let him have it through the hip. He went on, as though nothing had happened. Being determined to get him, even if all the others got away, I pumped another bullet into his body, this time close to the fore leg. At the second jump, he keeled over, just as I let another buck have it. The last one was hit in the rear—a shot that was a settler for him.

By this time the old doe was nearly out of range, so I let her go, turning my attention to a spike buck that stopped to look back, and a big doe taking a short cut over the ridge. I halted the doe with a bullet in the flank. The little buck had his neck broken by a bullet.

I now turned to my companion, and saw him standing still, with a look of surprise stealing over his features, evidently having forgotten he had a gun. I had killed 5 deer out of 6, and they lay kicking, within a space not larger than a square acre. I am sure the time of the shooting was not more than 50 seconds.

We had started to go over the range, but with so much meat on our hands, we went back to get help to bring it out. Every pound was consumed by the settlers.

Allen Weir.

This does not justify you in such a wholesale killing. One or 2 deer is enough for any man to kill, at one time. EDITOR.

## ANTELOPE ON THE HORSE RANGE.

Lander, Wyo.

Editor RECREATION: When I was 14 years old I hired out to a Mr. Hall to herd horses, about 75 miles from here, on Lander creek. Big game was plentiful, such as elk, deer and antelope, although when I arrived there, most of the elk and deer were farther back in the mountains.

I had a 44 Winchester rifle and a 45 revolver, and of course was anxious to kill something. My first shot was at 2 elk. I was riding a young horse, and had only my revolver.

I was riding down a narrow hog-back, looking for a stray bunch of horses, when I noticed, down to my left, in a bunch of quaking asp, what I took to be 2 cows, lying down. They must have been asleep, for I rode up to within 50 yards of them, before they jumped up, when I saw they were elk. I slid off my horse while they stood there wondering what kind of an animal I was. I put my arm through the bridle rein, took as careful an aim as I could, and pulled.

The next thing I knew I was on my back, in the rocks, and that measly cayuse was yanking me around to suit himself, in his efforts to leave me afoot, 10 miles from camp. He finally quieted down, when I got up and looked around for my dead elk.

The 2 cows were about a mile away, going South. The one I shot at finally died—from old age.

For a month after that I was shooting at antelope every day, but could not hit them. Finally one morning, I saddled up my gentlest horse, took my Winchester, and started out, with blood in my eye. I had determined to get meat or die trying.

I was riding along in the foot hills, when I saw a bunch of antelope, about a mile away, in the head of a gulch. I rode up on the opposite side of the hill from them, until I thought I was near them; tied my horse, and crawled up to the top of the hill. As I raised up to locate the game they saw me and ran up the hill, on the other side, about 75 yards away, where they stopped. I got down on one knee, took good aim at a fine buck and fired. He fell in his tracks and did not even kick. On examination I found I had shot him through the heart. I loaded him on my horse and rode into camp, the proudest boy West of the Mississippi river.

W. G. B.

## A STRANGE KNOCKOUT.

Clover, Wash.

Editor RECREATION: Few hunters ever have such an experience as being run over by a deer; but that was my luck while camping on the Teacaway. I started out

hunting, one morning, with one companion, Pat Flood. We made our way up a mountain near camp, through the quaking aspen. Just the place for deer, Pat said. Of this I was soon assured by seeing tracks of a bunch of 5 or 6.

Pat started down the slope, while I followed the tracks, which led to a steep hill covered with mountain-ash and hazel so thick I had to creep carefully not to frighten the game before I could see it. The deer were scattered and feeding. I felt sure they were not 200 yards away, for in front lay a deep gulch; on the other side of this there was a steep bluff. I was certain they were between me and the bluff.

I was in brush almost too thick to crawl through, and about as high as my head. Suddenly I heard the crash of a deer, on the hill-side, just above and within a few feet of me. Rising from a kneeling position, I saw a deer's head and breast outlined against the sky. Pushing my rifle forward, it met him half way. At the instant it was discharged, I received the full force of the bounding deer, and was knocked headlong down the hill, through the tangled brush.

Picking myself up, some seconds later, nose bleeding, my eyes full of mud, hat and gun gone, I was brought to my senses by hearing Pat's rifle making music not far below me. Looking around, as best I could, I saw 5 deer bounding up the gulch. Though a long way off, I opened fire, and after several shots succeeded in getting one.

Making my way down to Pat, I saw a buck which he had killed, and I at once claimed it, for the animal was marked with my brand on the shoulder, where my rifle had burned the hair off. The bullet had just grazed the hide. J. B. Liptrap.

## TRAILING FOXES.

J. T. M.

"Let's go bag a fox or 2, in the morning." Such a proposal from my friend and hunting companion, Billy, was always sure of a hearty approval. Seven o'clock the next morning found me at Billy's house, fully equipped for business. In 10 minutes we were on our way to the woods. Notwithstanding the stinging cold, we enjoyed our walk of 2 miles as only enthusiastic sportsmen can.

Our way of killing foxes is to track them in the snow and to shoot them while they are lying down or, as more often is the case, on the run. We use new Baker guns, and load with No. 2 shot. This combination is perfection, for extreme ranges; but I am digressing.

"Here is a good track, Tom; and here is another, both going the same way," said Billy. Noting one track was large and the other small, we concluded we were after a male and a female, and would find them together.



Following the tracks a short distance, they showed that the foxes had been looking for a place to sleep. Now we moved forward cautiously, watching to the right and left, more than to the front; knowing a fox always doubles on his track before lying down.

The tracks approached a deep gully, thickly grown up with trees and brush; a likely place for a fox, on a cold, windy day. Having the wind in our favor, we walked to the edge and looked in. Yes, there they were; 2 round, red balls, just behind an old worm fence.

Bang—bang—bang. They were both down; but the big one was 80 yards away before he dropped to the last shot. Pshaw, that was too easy!

It was then only 9:30. So, quickly skinning the pair, we tucked the pelts into our hunting coats and began looking for more tracks. After going about half a mile we struck another. Mile after mile we followed, until 5 miles from home. Here it circled back again.

All the way the fox had been hunting. Here and there, as we tramped along, we read the signs of tragedy. The trail followed a creek for 100 yards, where the bank hung over; a favorite roosting place for small birds. Several long leaps, a spot in the snow thickly padded with tracks, a few feathers, and the tale is told. The tracks crossed a meadow. Here 2 long leaps to the right, a hole in the snow, a dead mouse. I wondered by what one of the 5 senses the fox located that mouse. Farther along he caught a rabbit, after a straight run of 100 yards. After eating half, and burying the rest in the snow, he started off toward an old slashing. We congratulated ourselves, for the chase would soon be over; but the woods were hardly entered when, 200 yards ahead, we saw him sneaking away. The wind was against us. A fox places great reliance on his nose.

After him again, for we know he will not go far before lying down. Presently we see him, or think so, 200 yards away, lying by a tree. Billy stays here while I make a detour, get the wind in my favor and trying to get close enough for a shot. Imagine my feelings, after 15 minutes of crawling and creeping, to find the supposed fox only a bunch of leaves.

Motioning to Billy, we moved on again. Now we find where the fox left the woods and started across the fields. Ten minutes more and we see him lying under a thorn-apple bush. One, 2, 3! and the right barrels crack together. He was hard hit, but tried to run. The left barrels roared and he dropped dead.

Three o'clock; ample time to get home before dark. Seldom indeed do we bag more than one fox in a day; and feel well repaid for our day's tramp if we do that.

## A TEST OF NERVE.

J. C. B.

The latter part of March, along in the early '80's, my hunting partner and I were camped near the mouth of the canyon at the junction of the North and South forks of the Little Bighorn river. Our camp was in Wyoming, but for 80 miles to the North the Crow reservation extended to the Yellowstone river.

Shut in on all sides by high bluffs and towering mountains, the little basin was always free from rough winds. A wagon-sheet stretched over a pole was ample protection from the early spring snows and rains.

We had been in camp several days, but as there was no snow we could not expect to do much on bear. As we sat before the fire one evening, it began to snow. Our spirits rose immediately, and a hunt was planned for the morning. We always hunted separately.

Before daylight we saddled our horses and pulled out. I crossed the main Little Horn, below camp, and began to climb the hill on the North side. After going about 3 miles, I crossed a large bear trail. I got down and examined it and saw it was fresh. From its enormous size, I judged it to have been made by a grandpa bear; so I left my horse and followed it. I became disgusted by noon, and concluded not to go any farther, so sat down to rest, before starting to climb out of the canyon.

After cooling off, I felt better, and thought I would not give up just yet. Another hour's walking, sliding, and falling, and I came to the brink of a jumping off place; almost perpendicular and 150 feet to the bottom. The bear had gone down all right, as the piled up snow on either side of the trail showed. Apparently he sat down, pulled off brakes and slid to the bottom. I felt sure I could slide down where a bear could, but was not so sure of being able to slide up again. However, I took the chances, and slid. It was pretty rough tobogganing, I thought, as I pulled up at the bottom. After trying my legs and finding they would work all right, I again took up the trail. Within 400 yards I found where the bear had wintered. Then I knew he would lay up for the day near by, as this was his first trip out of winter quarters.

The slope of the mountain side was steep and uneven; so I climbed up about 30 feet and started parallel with the trail. Taking a step, I would stop and look sharply in every direction for the bear, also locating trees having limbs close to the ground, convenient for climbing. I felt as if I might have use for one presently. I moved in this way for about 150 yards, when suddenly I saw the bear rise on his fore feet, in his bed. His head was toward me and

he sat watching me, like a great dog. I could have shot him in the breast or neck, for the distance was only 31 paces, I found later, but I dared not risk the shot. I wanted to kill him instantly, for if wounded, even so he could go but 6 feet, he would roll and slide hundreds of feet down into the canyon.

When the bear was discovered I was carrying my gun in both hands, waist high and cocked, but for several seconds I did not move a muscle, realizing that getting a good shot depended on making no hasty movement. Two feet in front of me and on a line with my left side and the bear, was a tree. If I could get my gun against this for a rest, without alarming the bear, I had him sure. Slowly the rifle was raised to my shoulder and to the tree. It seemed an age before it was in position. The bear looked steadily, but seemed unable to make out what I was. My nerves were strung to their highest tension, and I felt sure of putting the bullet exactly where I wanted it. Taking deliberate aim, just over the right eye, I pressed the trigger. At the crack of the 45-75 Winchester, the bear wilted in his tracks, scarcely moving afterward.

Going up near where he lay, I looked at the great mass, realized it was all over and that I had killed my first bear. Then my nerves relaxed and I shook as badly as when I killed my first deer, in Wisconsin, more than 20 years before.

The bear had a magnificent hide, and was fat, considering the season. I will not venture to estimate his weight, but he was by no means a common grizzly. I have killed many since, but none so large as this.

---

#### A TRIP ON THE MISSISSIPPI.

There is no place where one can find more varied sport than on the great Father of Waters. The time to leave, for a trip on this great stream, varies with the season. As soon as the ice passes out is a good time to start, and you will meet geese and ducks, by the thousands, on their way North.

Don't fail to take with you a good supply of decoys and calls. Both geese and ducks have a tantalizing way of swimming just out of gun range, from the shores, and when you start to them, in boats, they wait until you are almost in range and then fly. As to a boat, take some small craft, all on lower deck and propelled by steam, with a good supply of regular river skiffs. When properly made the river skiff is broad, and steady, and can be run out over the thousands of acres of swamp lands, along the river, where the geese and ducks collect in immense numbers, to feed, and where the mud is so deep it is impossible to wade, even with the tallest boots.

On February 15, 1897, a party of us left St. Louis, for a trip through all the hunting region as far South as Helena, Ark., and while we had much rare sport we lost a lot of valuable time by not having the right kind of a boat.

If you want some grand shooting, next season, start at St. Louis or Cairo, Ill., and go down the Mississippi. Watch the flight of ducks and geese, and when you see many flocks flying over the timber, in one direction, you may rest assured it is not far to some lake, where you will find all the sport you wish. There are hardly 5 miles in any one stretch, but on one side or the other, a short distance back, is a pond or lake where the birds gather by thousands to feed.

But before you start on this journey test your boat, and its motive power, thoroughly. Be sure it works perfectly and that it is reliable under all conditions; for there is nothing more exasperating than to have your engine give out, when you are 10 miles from even a blacksmith shop.

H. C. Mead.

---

#### TEXAS DOVE SHOOTING.

Quanah, Tex.

Editor RECREATION: A friend and I drove out about a mile from town one evening, to a field grown up with sunflowers, for a little dove shooting, and before we got through the wire fence, the doves began to flush. On the first rise I killed one bird, not shooting my second barrel, while my companion killed one.

As we walked on, 2 to 10 doves would flush at every 20 or 30 steps, and the shooting was lively, of course. This was kept up until both ran out of shells. Ed., my friend, had started with 30, I with 25. When we got back to the buggy and counted our birds, it was found that Ed. had 13 birds, while I had killed 11.

After resting a few minutes we started again, my companion with 30 shells, I with 25. This time we each managed to bring down 2 doubles, though frequently we had to use the 2d barrel on the first bird. Sometimes, too, a dove would escape both barrels.

It took only about 30 or 40 minutes to run the birds all out of the field. On again returning to the buggy and counting up, Ed. had 16 killed for 26 shots, and I 13 to show for 23 empty shells. This gave us a total of 53 doves for 104 shots.

We are members of the Quanah Gun Club, and on telling some of the other members of our fine sport, one of them asked what our score was. On learning our average, he said he could beat that—could average 70 per cent. During the argument that followed, I told him we would shoot together, and he could have my birds,

if he came up to his mark; if not, I would take all he should kill.

He agreed to this, and one afternoon, a few days later, we, with Ed., started for the sunflower field. With 25 shells each in our pockets we invaded the place. My opponent was given the right side, Ed. the centre, while I took the left. It was "bang—bang—bang"; and so close together came the shots that one could not tell what the other shooters were doing.

After 5 or 6 reports from the right side of the field, I heard my opponent say that he did not want any doves anyway. On returning to the buggy, it looked very much that way. Ed. had 13 birds, I 12 and our friend only 4—and all of his shells were gone! Ed. and I were generous with him, however, and gave him enough birds to make a presentable looking bag.

B. F. Williams.

#### WASHINGTON GAME NOTES.

##### Lake Cushman, Wash.

Editor RECREATION: Another warm, open winter, with little hunting and no slaughter of game, either furred or feathered, gives us great promise of fine shooting during the summer and fall, while an unusually full berry crop makes a large bear supply a certainty. There are more broods of ruffed grouse, and blue or dusky grouse, than ever before known; while all signs indicate a prolific year for deer and elk. A herd of the latter, numbering between 20 and 30, have "sprung" within 5 miles of here. Judging from the signs they are all cows and calves.

Our populistic solons, in Olympia, have drawn up and passed an excellent game law, with one proviso which will render the whole inoperative. They prevent the killing of large game, except during September, and prohibit all killing of quail and Mongolian pheasants until 1900. A final clause, however, provides that ranchers and prospectors may kill at any time, for their own use, and as anyone, by stretching the truth a little, can be a rancher or a prospector, I fear there will be general killing all the year around. Sportsmen, and those who kill game for legitimate use save far more game, by helping to exterminate wolves, cougars and wildcats, than they destroy in hunting.

We all believe a law prohibiting the killing of any female deer, at any time of the year, and an entire prohibition of the sale of game, at any season, would do more to protect our game than anything else could; and we hope you will join us in an effort to bring about the enactment of such a law. It is the market and hide hunters who do the mischief—not the sportsmen nor the ranchers.

F. J. Church.

I am heartily in favor of the enactment of laws, in all the states, prohibiting the sale of game at all times. I announced this proposition 20 years ago and have urged it ever since. I also favor the enactment of laws forbidding the killing of female animals, at all times.

EDITOR.

#### AMONG THE OZARKS.

##### Galena, Mo.

Editor RECREATION: Among the drooping cedars, and stately oaks, in the somewhat isolated district of Stone county, Mo., can be found one sportsman who will at any time "jine ye" for a day or so, to hunt the wary buck or to cast for the gamy bass. Having spent the greater part of my life in the cities of the West, with only an occasional day to call my own, I resolved to settle where game and fish were abundant, and where, without limit, I could put in the time at my own sweet will. So among the beautiful hills and rugged Ozarks I established my camp.

To the South, 20 miles away, winds the beautiful White river, famous for its fish. At our very door ripples the clear and limpid James fork of the White, noted for jack salmon, speckled bass and big-mouthed bass.

The great "White bluff," near us, rises perpendicularly 400 feet from the water's edge; while the "Virgin bluff," 12 miles South, rears its rocky crown 700 feet above the river, overhanging so that, in passing in boats, the top cannot be seen.

In September let a party take canoes, at Galina, on the James, and, with rod and spoon, float 100 miles to the mouth of the stream. The scenery is grand the entire distance, but as the rapid current carries you on, do not forget to cast your spoon into the shadow of some old bowlder, for there lie the gamiest of bass, and they will fight you to a finish, too.

It will take at least 4 days to make the trip to the mouth of the James. Then, entering White river, take a run of 2 days, landing, at supper-time the second day, at the home of Hon. H. C. Thomas, who is one of the boys.

After this 6-day run, you will be only 18 miles from the point of starting. Be loaded now for a hunt back. The national birds (according to RECREATION for May), turkeys, are plentiful and at this season are full grown. Then again, if birds are too small, you can find deer frolicking in the cedar woods, adjacent to the streams.

This country, not many years ago, was full of deer. A man told me, a short time since, he had seen 75 skins of deer, killed by one man, and the hide of the first killed was hardly dry. Think of such destruction simply for the hides! No law can be too severe on such men; but, thanks to the last Mis-

souri assembly, we now have better laws for the protection of game and fish.

This part of our state, for a few years, has been overrun with a lot of unscrupulous hunters who kill and drive with hounds, everything before them. In the fall they fire the woods, which destroys the mast upon which the few remaining deer might live. In future our game will not only be protected by law but also by an alliance of our best citizens, who will endeavor to prosecute all offenders. Many thanks to RECREATION for the stand taken to protect game. May it not be long until, through its influence, stringent game and fish laws will be made and enforced in every state.

O. W. Bett.

A CHEAP TRAP.

Cincinnati, O.

Editor RECREATION: I saw in your highly esteemed magazine some points as to how to shoot on the wing, also a description of a glass ball trap. Enclosed find drawing of a pigeon trap, which a friend and I invented, and which we have found successful as well as economical.

A is a stake  $1\frac{1}{2}$  by  $1\frac{1}{2}$  inches and about 10 inches long. B is the bird, which may

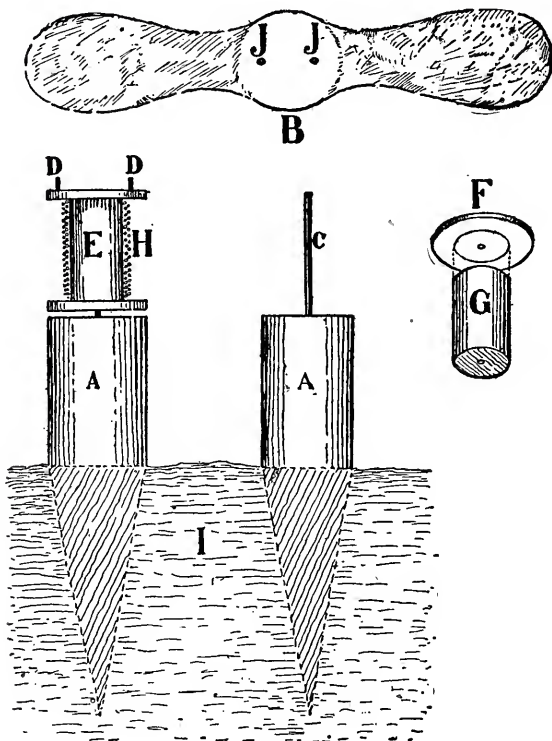

be made of old tin cans or of scraps of thin copper or brass. C is a long wire nail, driven in stake (A). D and D' are wire nails driven in spool (E) with heads cut off and projecting about  $\frac{1}{2}$  inch. E is a spool  $1\frac{1}{2}$  inches in diameter and 2 inches long; made by taking a block one inch

thick by 2 long, cutting it in the form of G and fitting a collar (F) at each end, made of  $\frac{1}{2}$  inch wood,  $1\frac{1}{2}$  inches in diameter. H is the cord wrapped around spool. I is the ground and J, J' are holes in pigeon, to fit nails D and D'.

To set up trap drive stake in ground; place the spool or nail as at E. Wrap cord around spool as in H; place pigeon on nails D and D'. Bending the wings, one a

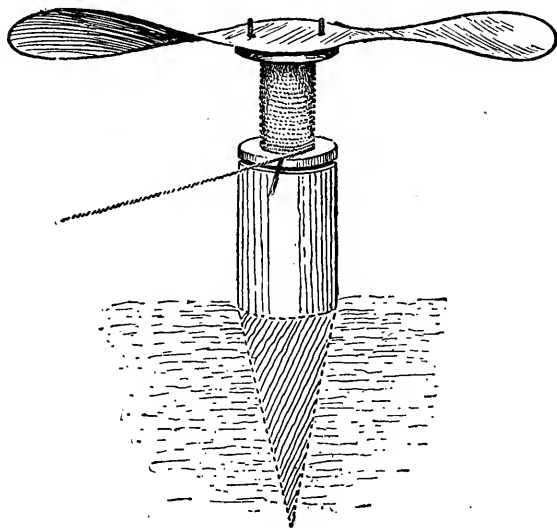

little up and the other a little down, at their margin.

By pulling cord, which is wrapped around spool, and which leads to a person back of shooter, the spool revolves rapidly and pigeon is sent on its flight.

If pigeon will not sail at first, bend wings until it does, and then keep same for model and make others like it.

I am now experimenting on a small motor, to take place of cord. It is too much like work to wind the cord each time. If it is successful I will send you plan of same.

One good thing about this trap is that the bird never goes twice alike. It will go first to the right and then to the left, or straight up or away from you, at a 2.40 clip, and I dare say it will take any young shooter some time to get the knack of breaking the pigeons.

H. Willaner Lowe.

HUNTING IN MAINE.

Editor RECREATION: It was a jolly party of hunters that started for the Maine forests, the last of September, 1896. There were E. M. Goodall, F. A. Allen, W. J., C. A. and Stillman Bodwill, all of Sanford, Me.; Dr. F. A. Bragden, Springvale, and Dr. Ferguson, of Cambridge, Mass. Our 4 guides, Uncle Nathan, his son and grandson, and George Spaulding, were awaiting us at Bingham.

On the evening of the third day, permanent camp was reached. Small game was

scarce, but big game was plentiful. We would have had no difficulty in killing all we wanted, had it not been for the rain, which fell almost incessantly. In fact, we had but 5 hours of sunshine during the entire 10 days in the woods. Every time there was a lull in the rain, some of us would go out, but we were certain to return drenched to the skin.

The guides were, to some extent, at sea; for the gates of Moxie pond had been closed, for the benefit of the lumbermen; and this, with the heavy rains, caused the water to rise, and large game was obliged to seek new feeding grounds.

Our accommodations were good and, notwithstanding the rain, we managed to pass the time pleasantly. Hackett, at whose camp we stayed one night, had promised to send us a shoulder of caribou. On Saturday it arrived. I saw at once, that, instead of caribou, he had sent veal. Whenever we saw anyone from Hackett's neighborhood, after that, he would invariably ask how we liked our caribou. At every opportunity, we sent Hackett word to give us some more veal, like the last. He thought he had played us a good joke, but some of our party had been in the Maine woods before.

Bragdon and Allen were obliged to leave at the end of the first week. Allen, by means of a persuasive tongue and the wherewithal, managed to get a buck, to take back with him.

On breaking camp, we tried to follow a blazed trail, to a "tote-road," which would take us to Chamberlain hill, where we were to spend a few days, at a farm-house. We followed the trail until we reached a clearing; there we lost it completely. This was at 11 o'clock, and it was nearing dusk when we finally found a wood-road that led to Chamberlain hill.

In the morning, in the field near the farm house, we saw the footprints of several deer and plans were laid for that night.

In the evening we selected positions and waited. When tired and disgusted, we retreated to the house and went to bed. The next morning there was not a track of a deer in the field. It seemed we were destined to meet with disappointment, as far as big game was concerned, so we gave it up and went back to Bingham.

Will and I, taking a stroll along the principal street, saw an old trapper who had just brought in a black bear that he had killed. He knew the animal was worth \$25, and so did we; but he finally agreed to part with it for \$20.

The day we left Bingham, the game on the train consisted of 7 deer, 2 black bear, 2 caribou and a moose, all killed at the fork of the Dead and Kennebec rivers.

F. M. G.

#### COONS IN THE WATER.

Last spring, 3 of us, Barney, Dan and I, went to Lake Addie, near our town, for a duck hunt. It was so foggy objects could be seen only a few rods away, and the wind blew so hard there was no flight of ducks.

After a time the sun came through the fog; then, looking out on the water, Dan noticed 3 small objects moving toward us. Thinking they were muskrats, we opened fire, but could not hit them.

On they came, and when they were within 2 rods of shore I saw they were 'coons. We had been shooting at their tails, for nothing else but their noses showed above the water.

On seeing us, the 'coons turned and started back across the lake. We kept shooting until they were out of range, then Dan got a boat that was near by, and pushed off in pursuit, using a fence-rail for a paddle. He left his gun, but took our 2 dogs.

The 'coons were nearly across the lake when Dan caught up with them. The dogs jumped into the water, half filling the boat as they did so. Dan used the rail on the 'coons, but it took him nearly 30 minutes to kill the first.

The dogs were after the other 'coons, but whenever a dog approached near enough, the 'coon would reach out with a front paw and hit a canine nose so hard its owner would swim away again.

Dan began on another 'coon as soon as he secured his first. While he was pounding it, the third swam ashore and got away. Dan's second victim was finally hauled in. The 'coons weighed 18 and 21 pounds, respectively.

For game, in this vicinity, we have nearly all of the different kinds of ducks, geese, prairie chickens, snipe, jack-rabbits and cottontails; also red foxes, badgers and woodchucks. For the angler, there are pickerel, black bass, rock bass, perch, sun-fish, suckers and buffalo fish.

Louis A. Ahlbrecht, Brownnton, Minn.

---

#### GOOD AND BAD GUIDES.

St. Anthony, Fremont Co., Idaho.

Editor RECREATION: I had a small advertisement in the June number of RECREATION, and received a number of letters dated prior to June 2; the writers saying they saw my advertisement in RECREATION. I have been asked how to get a good guide. In answering I will tell how not to get a poor one.

One man who claims to be a guide had a party out last summer, in the Jackson Hole country. After he had taken his party to the railroad, I asked him if he had had

good luck on his trip. He replied that the hunters did not kill any big game, and he did not care. As he was not getting big wages, he did not take them where the game could be found. They saw a few antelope, caught some trout and killed a number of sage-hens. The guide put in all the time he could, and that was all he cared for.

Another party started at the same time and killed 6 bear, 14 elk and 2 deer. These hunters were not out so long as the others, but paid their guide good wages, and he tried to satisfy them.

I know several men who have come here expecting a good time, but who have gone away dissatisfied, because they were fooled in the man who took them out. To any one contemplating a trip, I would say, get a good guide and pay him good wages. You will be better satisfied at the end of your trip than if you had a cheap man, who put in lots of time, but did not find the game.

There are good guides in Jackson's Hole, and there are good guides who do not live here, but who know every foot of the country, where the best fishing and hunting can be had.

A man in New York wrote asking what wages a good man would expect. I do not think the right kind of a guide can be had, in this country, for less than \$5 a day and board. He would furnish his own saddle-horse, but the rest of the outfit would be extra. Some men would not go for \$5.

A good guide will want the party engaging him ahead to send a small deposit, as a guarantee of good faith. I have known of parties engaging men here, keeping them waiting until too late to go with anyone else, and then they did not come. I have also known guides who contracted to take certain parties, but some one else coming along would offer the guides bigger wages, and the first hunters would arrive to find their man had deserted them.

The best way, when engaging a guide, is to put up a forfeit and then have the agreement in writing. I have lived in the Rocky mountains all my life, and have seen a good many parties of hunters, and many guides too, fooled. As a rule a guide can be depended on to stick to his word.

Recently I had a letter from a man in Colorado, saying he could get a guide in this part of the country, who would take him, in 2 days' travel from the railroad, where he could find elk, moose, bear and mountain sheep, and where he could catch all the fish he wanted, without moving camp.

There is no such place in this or any other country. A hunter may go up in the mountains as far as water can be found, and then it will take him a full day to get to the sheep. There are some moose in Idaho, but few in Wyoming. There are

still some mountain sheep here, but the hunter cannot find them and get back to camp the same day. For trout fishing, Idaho and Wyoming beat the world.

George Winegar.

---

NOTES.

Toledo, O.

Editor RECREATION: I saw a statement, in a recent number of RECREATION, from L. D. W. to the effect that he had borrowed a well broken pointer and had gone after some birds, which he found but which he did not get. If I borrowed a dog I should not condemn him because I did not get as many birds as my partner. That is discourteous to the dog and to his owner.

Last Thanksgiving morning L. D. W., Chas. Eastwood, C. Wright, T. Hoover, D. McBride, and I went about 8 or 10 miles West of this city, to a place called The Openings. Mr. Hoover, who was not feeling well at the time, had his throat tied up with a flannel, and wanted to be careful not to get his feet wet. In crossing a creek, on a pole, he slipped and fell. In order to keep his gun dry, he thought he could strike his elbows on the opposite bank; but fell short about 2 feet. About the time he was emptying the water out of his gun-barrels, and hip-boots, the air was rather blue around there.

McBride, who is not much of a wing shot, but who is noted for being a great coon and fox hunter, and for knowing the woods from one end to the other, got twisted and spent part of the afternoon climbing trees to find his way out. He nearly wore out a pair of corduroy trousers; but we finally all got out and had a good day's sport. We found game enough to make it interesting, and killed 11 ruffed grouse, 2 quails, 2 gray squirrels and 2 rabbits. We have plenty of birds left over—more than usual. O. O. H.

---

I saw in one of the sportsmen's papers an article stating that deer only chew lily pads, to spit them out. That statement is amusing to me. I have seen a lot of deer in my time; have opened the stomachs of many of them and have found them full of lily pads. Have also opened many caribou. In September they wade the ponds the same as deer, and live on the pads.

As I am writing, 7 A.M., there are 9 deer within a stone's throw of this house. They are with the cows, in the pasture, and it's a regular thing for them to come out. There are 2 bucks, 2 or 3 does and some yearlings.

One cow does not like them to come in and eat up the grass. She shakes her head and runs at them. Then they make a bolt for the woods, but soon return.

I have been in the woods about one month, building a hunter's camp. Have but 8 miles of canoeing, from this place, over on the West branch of the Penobscot river. Have seen as many as 20 deer in a day, and never less than 2 or 3. All this without going out of my way. They seldom run off; but stand and look at you as you go by; then go to feeding again.

Have seen several moose tracks. No moose were killed just in this part, last fall, but that does not prove anything. They do a lot of roaming.

Fishing never was better, on the West branch, at this time of year. We look for a large crowd of sportsmen this season. I see no reason why they may not be amply repaid for coming here, as the game is more plentiful than ever before.

John J. Kelley, Northwest Carry, Me.

#### Burnet, Texas.

Editor RECREATION: The sportsmen of Texas are rejoicing over getting our game bill through the Legislature. I think we have a fairly good bill. It protects antelope and Mongolian or Chinese, and English pheasants for 5 years. Pheasants are being introduced into the state, and I hope, in 5 years, we can have fine sport with them.

The shipment of game from the state is prohibited. The netting of partridges or quails is prohibited at all seasons. It is unlawful to kill ducks and geese by any other means than ordinary guns, capable of being shot from the shoulder. It is unlawful to kill pheasants from February 1st to August 1st; antelope January 1st to September 1st; deer January 1st to September 1st; prairie chickens February 1st to August 1st; quails or partridges, March 15th to October 1st.

It is unlawful at any time to hunt deer, or any other game, by the aid of a hunting lamp, or lantern, or any other light used for the purpose of hunting at night. The possession of game during the close season "shall be prima facie evidence of the guilt of the person in possession thereof." The penalties are from \$10 to \$200.

T. A. Harrison.

I have been a reader of RECREATION for 2 years. It is the best of its kind, and I think it becomes better every issue. All lovers of out-door sport should be readers of it.

Small game, such as rabbits, quails, and squirrels, are plentiful here. This is also a good section for fishing, owing to the numerous lakes and streams; but the laws have been violated so much, of late, the fishing is not so good as formerly.

Our last legislature passed some good game and fish laws. Already some violators have been prosecuted. This will tend

to put a stop to such work, and permit our fish and game to increase again.

I was fishing recently, with an old angler, and we caught 92 fish, averaging about  $\frac{1}{2}$  pound each, which was all we could use. Our fish are bass, rock-bass, sunfish, perch, catfish, and pike, with suckers, and some others in the streams.

I am a lover of fishing and hunting, and am down on hogs and violators of game and fish laws. I heartily endorse the tone of RECREATION, in its scoring all such, and only wish we had more men to talk and act in the same way. J. I. F., Akron, Ind.

Michigan people know a thing or two about protecting fish and game. Here are some records that are good for sore eyes:

May, 1897, broke the record for arrests, in the state game and fish warden's department. There were 109 prosecutions and 96 convictions, growing out of 149 complaints, which were all investigated. Of the 109 cases there were only 6 acquittals. Two cases are still pending, and 5 were dismissed. There were only 3 arrests for violating the game laws, all the others being for fish law violations.

In April, 1896, there were 105 arrests, and in May, 1896, 99 arrests. As many violators are sometimes prosecuted in a single month, now, as were arrested in an entire year, when the department was first created, which indicates, in some degree, the growth of its efficiency. State Warden Osborn says Deputy Warden L. W. Watkins, of Manchester, was especially active and zealous during May.

If every state, and every county, could have such officers as these there would be game and fish for every one, for a thousand years.

A woman was appointed county game and fish warden, in Grand Traverse county, Mich., on the solicitation of herself and friends. She is Mrs. Warren Neal, and handles a gun and boat expertly, in addition to being a practical woodswoman. She is probably the only feminine game and fish warden in the world.

Chris Horandt, the silk manufacturer, paid \$123 for a woodcock dinner, this morning, and didn't get the dinner either. It appears Horandt ordered the birds from Charles Conklin, of Midvale, through Charles Coursen, a juror now in attendance on the county courts. Conklin says the written order said "Get the birds, and never mind the law." Conklin got a half dozen birds and collected \$3. Then Game Warden McLean arrested both men. They were arraigned before Justice John Keys and Horandt paid a fine of \$120. Conklin went to jail for 90 days. Coursen will step up to see the justice, later in the week.

James Stasso, who was arrested by Game Warden McLean, was fined \$80 for having 4 robins in his possession.—Paterson (N. J.) News.

This is mighty good medicine for law-breakers, and if game laws were administered as vigorously, everywhere, as they are in New Jersey there would be plenty of game in every state.—EDITOR.

Gabriella, Orange Co., Fla.

I have been a reader of RECREATION about one year, and cannot get along without it.

I have hunted and fished in almost every state in the Union, and have employed guides in numerous localities, but meeting with heavy losses in the North, and last in Florida, I am compelled to offer myself as a guide. I have been in Florida 12 years, am well informed as to the fishing and hunting grounds and think I could give satisfaction. I can give good Florida and Pennsylvania references as to my standing and reliability. We have 13 lakes within  $\frac{1}{2}$  mile to  $1\frac{1}{2}$  miles from the house and good quail shooting. Deer and turkey ground is from 8 to 10 miles away. John Beidler.

West Superior, Wis.

Editor RECREATION: Last September we had good chicken shooting about 100 miles from here. Before the Hinckley fire, 3 years ago, there were no chickens within that distance, but now, anywhere within 10 miles of Hinckley they are abundant. Quails are also getting a good start about there, thanks to Minnesota's 3 years of protection.

Last winter we had an unusually heavy fall of snow, and the pot hunters had a snap, shooting deer all winter. One man was arrested and sentenced to a year in jail, but that is the only case of any one being interfered with. One of our game wardens refused to seize 40 carcasses of deer, on the track, consigned to Chicago parties; because, he said, there was no money in it for him.

Trout fishing is not so good as it was 3 or 4 years ago; although an angler can still get a good catch, early in the season, on the Brule river, 35 miles from here.

On the Nepigon river, last August, some friends of mine had great sport, and brought home one trout that weighed 5 pounds. B. J. S.

Warren, Minn., is the best place for sportsmen, on the Great Northern Railway. It is 330 miles North of St. Paul. April is a good month for geese, but October is better.

A man makes a mistake who uses an 8 gauge gun, over decoys. A 10 gauge gun, with No. 2 shot, for geese, every time. I got in my pit at daylight, one frosty morning last October, with an 8 gauge, and had lively shooting for an hour. Twelve flocks of geese came to the decoys. I emptied 24 shells and only dropped 12 geese. With a lighter gun a man could have had at least 20 birds. The field was handy for a sneak and was covered with geese at evening. The farmer wanted me to crawl up and kill 20 at a shot, but I did not disturb

them, knowing they would come to feed in the morning, and the fun of seeing 12 geese fall beats a pot shot any time. It usually counts more birds too. My gun was only built for one bird at a time, and the reason I missed so many was because I did not have a crack shot in the pit with me, and I was able to count every miss. I will send you a photo of my next string of geese. E. Blee, Warren, Minn.

One morning in June I saddled up to ride a circle in search of a strayed horse. I did not count the antelope I saw, but I was not out of sight of them, for more than half an hour, at any time during the forenoon. Sometimes I saw 2 or 3 small bunches at one time. They were in the scattering timber, small parks, and pot-hole country. I could have had a number of easy shots; but as this was in the close season, I did no shooting.

I also saw 3 elk and one moose. The latter was crossing a strip of park near my camp. I urged my horse along, which caused the moose to change his course and to pass within less than 50 yards of my tent, which it did not appear to notice.

I judged from the number of trout I saw in Jenny's lake, at the foot of the Grand Teton, some one will have good sport this fall. O. F. Bike, Jackson, Wyo.

Great Falls, Mont.

Editor RECREATION: Last fall our party camped on Beaver lake, in Flathead county. The weather was perfect, with about 8 inches of fresh snow on the ground. Here the deer were not wild. We started out early one morning and after several hours' hard walking, through ravines and over ridges, with no success, we came to where 2 ridges met. There being 4 of us, we each took a side of a ridge, and continued farther up the mountain.

I was about discouraged, when I ran across fresh deer tracks. I started on the trail and soon came to a warm bed, from which a deer had started.

I continued to trail and on going over one ridge, saw the deer on another, about 100 yards ahead. I took a snap-shot, and the deer fell.

I hastened forward, but, when within a few yards, it jumped up and went over the ridge. I got another shot, making a clean miss.

Soon after, a shot came from over the ridge. I hastened forward and found one of my friends standing over the deer.

We hunted 2 days longer, going home with 14 deer. O. E. T.

I have closed out my interest at Marvin Lodge, and have moved up here into Northwestern Wyoming, to live. I have



as partners W. F. Hill and Hermann Rich, both well known guides, and we shall put up a first class sportsmen's camp, here on the head of Green river. There are 7 of us in the party, with 70 horses and 21 dogs, and the bear and mountain lions are going to run up against a new deal. This is certainly a great game and fish country, and the people here are strongly in favor of protecting the game and fish. If only Uncle Sam would keep his pets at home all would be well; but that is not to be hoped for. It seems a pity that a lot of armed beggars should be allowed to defy the laws of a state and be backed up by the United States in doing it.

I hope to have some good stories for RECREATION when we get the hounds at work, next fall. We all want to see what they will do when they run up against a wolverine.

Wm. Wells, Cora, Wyo.

Can the editor, or any reader of RECREATION, tell me who is the game warden of this state? I have asked local sportsmen, but none of them seems to know.

A few days since, I heard a young fellow invite another to "come out some Sunday, and I'll show you some squirrel hunting." The game in this section of the country, while it consists mostly of rabbits, squirrels, and quails, will be more plentiful this fall than for several years previous. Still, the law breaker is among us, and it is not owing to any rigid enforcement of the game laws that the game will be less scarce than formerly. Down with the hog!

P. D. Q., Salem, O.

I have not the name and address of the game warden of your state, but if you will write the Secretary of State, Columbus, O., he will give you this information.—EDITOR.

There are a good many sportsmen in Wisconsin, but also a large number of game butchers. The game wardens do all they can, but there are not enough of them to enforce the law. Deer are unmercifully slaughtered, in the Northern part of the state, by lumbermen. The way jobbers and contractors use deer is shameful. Some supply their lumber camps with venison all winter regardless of the season, in place of beef or pork. They find it cheaper and more convenient.

Sam Crofoot, Fond du Lac, Wis.

I saw a letter from H. O. W. in a late issue of RECREATION, where you and he gave the trap shooters a roasting for slaughtering ducks, in Texas. I was there at the

time and wrote one of the weekly sportsmen's papers about it, but my letter was not published and the whole matter was hushed up.

J. C. French, M.D., Quebec, Can.

That's where RECREATION differs from some of the other alleged sportsmen's journals. It roasts game hogs, and fish hogs, wherever it finds them, no matter how many subscribers it may lose.—EDITOR.

Last Monday evening 2 deer came into town, with some cows. They came from the South and went through the main business street, a distance of 6 or 7 blocks, stopping several times on the way. The men on the street tried to surround and capture the deer, but they got away and went out at the North end of town. It would have made a grand picture; but, unfortunately, as it is not an every day occurrence, they took us unawares.

J. D. Jones, Kinneo, Me.

Geo. Cornell, Mt. Upton, N. Y., writes that the best grouse, squirrel and woodcock shooting to be found in the state, may be had in his vicinity, and that he will be glad to show visiting sportsmen where the game is. Mt. Upton is reached by the N. Y., O. & W. Ry. and is about 100 miles from New York. It would be well for sportsmen who wish to get a day or 2 of good shooting, within easy distance of the city, to communicate with Mr. Cornell.

My time lately has been put in between here and McDonald, and the only game I have seen was 3 black bear, on a snowslide, near Stony creek bridge.

Ed. G. W., Bevelstoke, B. C.

There will be plenty of water in the Horican marsh next fall, and that means good shooting.

B. W. H., Waupun, Wis.

All sorts of game are plenty. My brother and I caught some fine trout at Scott's Station, near here.

L. McC., Little Rock, Ark.

There are wild ducks, partridges, squirrels, rabbits, etc., here.

E. D. N., Hudson, N. Y.

We have deer and antelope in this section, but no bear.

W. P. R., Gillette, Wyo.

## FISH AND FISHING.

### IS THE OUANANICHE A FRAUD?

Quebec, Can.

Editor RECREATION: I have just come down from Lake St. John, the home of the ouananiche. I read about that chap 15 years ago, and now that I have had him on deck, and had it out with him, I am going to tell the truth (paradoxical as it may seem, in a fisherman) about him.

First, it costs \$7 a day to fish for him. Second he does not rise to the fly. Let any man deny that if he can. No jump-clean out-turn over-and come down again-knock it with his tail-or get it any way, about him. He just opens his mouth and sucks it down. You never see him grab the fly; and after the reputation of rod smashing, jumping, wild horse tactics, he has, he was a sore disappointment to me.

I got 2, several times, and got them in swift water; fish that weighed 2 pounds apiece—not guess weight but actual weight. I had them both in the net and never lost one, in 3½ minutes by the watch, using a 7½ ounce rod.

Out of 20 fish only one jumped out of water. Gentle friends of the angle, it's my humble opinion, and that of the 4 friends who fished with me, that this chap is a bit overrated. One of these friends is an American who has fished the Nepigon and many other famous waters. Another is a Scotchman who owns waters and who fishes for salmon and trout, in this country and in Europe. So you see they are competent judges.

I am no sore-head. I have been fishing and hunting most of my time for 12 years; and you catch more ouananiche trolling your fly than by casting it. His food is *in* the swift water, not on it. He won't and can't "Jomp quinze fit hagh!" as the fat-pork-and-sundown French guides say he can.

Four pounds is a big ouananiche; and when you spend the time, and money (and it takes lots of both), you will think of the story of Hank White's beans, i.e., "He didn't git so many beans on that piece of land as he expected to, and he didn't expect he should when he planted 'em."

There are, as nearly as I can learn and see, about 5 or 6 miles of the Grand Discharge, and not one-fourth of that can be fished, because it is too rapid. The water was leased by Mr. Beanwar, of the Roberval hotel, the upper part I mean—and the lower by a trusted employee, Mr. Scott. Now there is friction and the water the hotel has is small in quantity and, in my opinion, sadly overfished. Railroad and steamboat connections are nil, before the

summer trains are put on, and 7 *simolions* per diem rather stiff when 6 men do not break a tip, lose a leader, nor catch a fish weighing over 4 pounds; when one and all declare the fish do not rise like a trout, or a salmon, and that they are not so good to eat, by any manner of means.

Had I been alone I might have swallowed some of the yarns about 6 pounders, later; but when I heard Mr. Cox's story I was certain Ananias's seed was not extinct. Six meant 2 and 4 meant 1½.

Mr. Cox is here and I am going to ask him some questions, when he comes to lunch. There are 4 others behind him and he was high line while there. More than that another Johnny has just gone up and is going to fish the best water. I will collar him when he comes down; for to take the hotel people at their word the fishing, this year, should be at its prime right now.

The foregoing is matter of opinion and I claim a right to mine. I have been there. True, I did not stay long; neither did any one else I saw, and I had a chance to see the catches of others, and to get their version of things in general. I believe the thing overdrawn. Having fished in many waters I carry a large bag of salt, and find it comes handy.

Mr. Cox has just come in and I asked him how he caught his ouananiche.

"All by trolling; none on the cast. My big basket was 19 fish, weight 30½ pounds. Largest fish 3 pounds. The guides said that would be the largest taken, as there were but one or 2 better last year. I believe them, and not the record book in the hotel.

"All my fish took the fly below water. Same thing in Metabetchuan, where I fished 3½ days and did not see a fish take the fly above water; nor did I see any one who did see it. The largest fish I saw up there weighed 4 pounds."

Now, there you are, just as we saw it. Use these letters as you please, so you get in the facts.

J. C. French, M.D.

### KING AND BARTLETT LAKE.

W. D. GRUET.

Leaving Hartford on June 20, 1896, I spent the night at Portland, Me. The next morning the journey was resumed, and at Dead river station the stage was taken, for Eustis. About 3 miles from the station I saw my first wild deer. He was grazing, across the river, not over 150 yards from the road.

At 10 o'clock in the evening we were at Eustis. The next day's programme was a buckboard ride of 15 miles, to King and

Bartlett, where I arrived in the afternoon. This camp is about 50 yards from the shore of King and Bartlett lake, and consists of about 2 dozen log cabins.

The fishing at King and Bartlett is excellent. I took about 10 trout a day, averaging  $1\frac{1}{2}$  pounds. One day I caught 20, the lot weighing 27 pounds. I spent a day on Spencer stream, and though the trout were not biting freely I caught 100, weighing from 2 to 12 ounces each, and returned them all to the water except enough for dinner. Under favorable conditions one can take 100 trout an hour, from this stream, often 2 and even 3 at a cast.

The usual programme is a day at Spencer stream, a few days at Big Spencer lake, where togue or lake trout are abundant; then, taking the trail to Parker pond, where one can see deer galore; thence to Horse Shoe and Little King and Bartlett ponds; and back to the main camp, with several side trips.

I was fortunate in having Douglas E. Bloomfield as guide. He was efficient, and a very pleasant companion. I saw 14 deer, one fox, a loon, and several ruffed grouse, with their broods. The grouse were so tame one might have shot their heads off with a rifle. To my regret it was the close season; for I would have enjoyed this kind of target work. I also saw several moose tracks, but did not get a glimpse of the animals.

Near Gerard's camp, at the head of Big Spencer lake, I had a 75-yard snap-shot at a buck, with my 4x5 Premo, getting an excellent negative. This being my first photograph of a wild animal, in his native haunts, it is a souvenir I highly prize.

Three young men of Hartford were sojourners at the camp. They are very enthusiastic over this region, preferring it to the Adirondacks, where they have passed several vacations. They saw 23 deer at Parker pond, in about one hour. The day before leaving they caught 5 trout, that weighed 10 pounds, off the wharf. These they took home with which to silence sceptics. One of the boys caught 3 trout weighing 4 pounds, at one cast.

After having experienced the excitement of battling with gamy trout, and the romance of roaming through grand old forests, breathing aromatic odors of fir, spruce and pine, I returned to my work with renewed zest. The good health I have since enjoyed proves a trip to King and Bartlett is a "bracer" that will keep one "braced."

---

#### AFTER TARPON IN TEXAS.

Galveston, Texas.

Editor RECREATION: Tarpon were never so plentiful in these waters as during last summer. Late in the evening they would bite well on cut bait. The first day our

party was at San Luis pass, we lost 18 hooks and any amount of line, while fishing for mackerel. We were using light tackle and live bait, so the tarpon had a regular picnic, at our expense. When the mackerel stopped biting, Stanley got out his tarpon rig, and inside of 10 minutes had a tarpon hooked. After playing him about 45 minutes he succeeded in getting the fish into shallow water, where I went out and speared him.

The next morning I waded into the pass, to my waist, made one or 2 unsuccessful casts, and was about to give it up, when I had a hard strike. At the time my left hand was clasped over the rod and line. Before I could put the brake on with my right hand, the fish rushed about 115 yards, and the line burnt holes in my fingers. This was all done in about 3 seconds.

Finally I turned the tarpon and started for shore, to gain more slack. At this he made another turn and began to leap. He would leap about every 2 minutes, but I did not give him an inch of line. When he came my way I reeled in slack and worked toward shore. When he started out, I shut down on him and followed him to deep water. Several times I followed, up to my shoulders; but always turned the fish, until once, when out as deep as I could go, I had to give a little line. He had to fight for every inch he got. The line was nearly all gone, so I decided to break loose rather than lose it. I shut down on it and fortunately turned him. He made a rush toward shore, and I could not reel fast enough to take in the slack. Had he made another outward run I should have lost him. After nearly 2 hours of hard work I landed my fish, with the help of one of the boys and a gig. That was the hardest work I ever did in 2 hours. My left arm ached and the fingers on my left hand still show scars, from the burn.

Our party was composed of Stanley Sinclair, George Anderson, Victor Pichard, Chas. Holt and me. During our stay we caught, in the day-time, all the trout and mackerel we could eat, and went floundering at night. Each of the boys caught a tarpon and they could have caught more if they had played them. Then the angler would put on a new hook and make another cast for trout or mackerel. The largest mackerel taken was 32 inches in length and weighed over 4 pounds, dressed.

Any Northern sportsman wishing to catch tarpon, pompario, trout, mackerel, jack-fish, alligator-gars, sting-rays or green turtles, should come to the Gulf coast during May, June, July or August; he can then catch all he wants.

I would like to exchange game pictures, unmounted, with some other reader of RECREATION.

We have a shell road running 16 miles down the island, and we do all of our snipe

and plover hunting on bicycles. I mean we use a bicycle instead of a horse, but I have shot plover from my wheel.

Charis Rogers.

L. C. Flynt, wife and son, and A. D. Norcross and wife, of Monson, Mass., with F. G. Nelson and wife, of New York, made an enjoyable trip through Nova Scotia during the first 2 weeks of June.

Their route was from Boston to Yarmouth, by steamer; thence by stage to Tusket and return; thence by steamer along the beautiful South shore, touching at Barrington, Shelburne, Lockport, Liverpool, Lunenburg and Halifax, and returning by rail, through the Evangeline country, Annapolis and Digby to Yarmouth, and thence by steamer to Boston. At Tusket they had 1½ days of fishing, on the North branch of the river, taking 65 fair sized rainbow trout and brook trout, on small, dark-colored flies. From Shelburne the party drove 16 miles to Upper Clyde, where the product of 4 days of fishing was 172 brook trout, averaging nearly ¾ of a pound. Large flies, Montreal, Brown Hackle, Parmachene Belle and Silver Doctor, on No. 4 hooks, were the most successful. From Liverpool the anglers drove 3 miles to Milton, where 2 salmon, weighing respectively 8¼ and 8½ pounds, were taken, on a Silver Doctor and trout tackle.

Editor RECREATION: Will you kindly inform me as to whether there is such a fish as a strawberry bass; and whether or not it is a true bass. We sometimes catch them here and I have had the fact disputed.

D. Thompson, Troy, N. Y.

There is such a fish as the strawberry bass. It is also called calico bass, grass bass, barfish, and sometimes crappie, though it is not the true crappie. The strawberry bass is known in the books as *Pomoxis sparoides* while the true crappie is *Pomoxis annularis*. They both belong to the same family as the large-mouthed black bass, the small-mouthed black bass, and all the sunfishes.

The strawberry bass has 7 or 8 sharp spines in its dorsal or back fin, while the crappie has but 5 or 6. The anal fin in the crappie is plain, while in the other it is strongly reticulated with darker. The strawberry bass reaches a length of a foot or more, is a splendid pan fish, and is found from the Great Lakes and upper Mississippi valley South to Texas. It prefers clear, running streams, while the crappie is most abundant in lakes and bayous.

Everyone who travels over the O. & W. R. R. knows big hearted, jovial, honest Bill Keener, who keeps the hotel at Rockland, Sullivan county, N. Y.

No slicker fly fisherman ever cast a fly on the Beaverkill, which runs by the rear of his pleasant hostelry. Bill recently had the good fortune to pick out a 4½ pound trout, on a No. 8 Reuben Wood fly. The fish was a beauty, and up to date there is no record of a larger one being caught, on a fly, in the Beaverkill.

It would do you good to hear Bill tell how he caught him. Every plunge, every run, he made, is explained by this expert with the keenest delight.

Bill presented the fish to Mr. Star Church, the popular O. & W. conductor. If you ever go to Sullivan county get Bill to go out with you, and you will have the company of a true angler and will return with a well filled creel.

L. Roth, Middletown, N. Y.

I consider RECREATION the loveliest and best sportsmen's magazine published. Every sportsman should read it.

In perusing a recent number an article entitled, "Rangeley Trout Lore" attracted my attention. I have had the pleasure of visiting the Rangeley lakes several times, and of spending a few delightful months on their picturesque borders. One cannot appreciate them, however much he may read of them, until he has taken, at least, a short sojourn there; when their magnificent scenery, salubrious climate, fine hunting and fishing, all will conduce to make him declare them a veritable sportsmen's paradise.

I have camped from Umbagog to Parmachenee; have hunted the deer, trapped the mink and sable, caught the trout and the salmon, and now I am firmly convinced that a place better adapted to sportsmen does not exist. To all who wish a good time, and one they will never forget, I say go to the Rangeleys.

Walter H. Bond, Freeport, L. I.

Mr. C. B. Barton, superintendent of the Electro-Chemical Works, of this place, went to Garland pond a short time ago and had some good trout fishing. He has a trick of getting trout when others fail. In this case he used a 6 foot leader, with a bait on the tip and 2 flies trailing. On one occasion he filled the leader beautifully. Putting a 4½ pounder on the tip, Mr. Barton began playing him when a 1½ pounder struck the second fly and a one pounder took the third. Mr. Barton carefully coaxed them up to the boat in order that the guide might take a part in the play. After a time the net was placed under the largest fish and the leader was severed with a knife. The 4½ pounder being taken in out of the wet, the others soon followed.

Mr. Barton said these trout showed a decided lack of "team training"—not work-

ing together at all, but that they made up in muscle what they lacked in skill.

C. B. H., Rumford Falls, Me.

The season just past was an unusually good one for deep sea fishing near Avalon, Santa Catalina island. May was a particularly good month. Launches and yachts were kept busy taking the visiting anglers to the fishing-grounds. C. F. Holder, well known to the readers of RECREATION, was among the men who captured big fish on light tackle. On a 10-ounce rod he took, one week in May, a 44-pound sea-bass, a 30-pound albicore, and a yellow-tail of 17 pounds.

Trolling from yachts, for barracuda, is a favorite sport. A party of 5 anglers, in one afternoon, in this way took 194 of these fish. During one hour, using only 5 lines, 160 were landed. Previous to this, the largest catch, for the season, was 154 barracuda, which were landed in 2 hours. One catch of 20 fish was made in 30 minutes.\*

Mackerel began running about June 1st, off Redondo, Cal. July, August, and September, however, are the best months for mackerel, both at Redonda and Catalina.

B. C. H., Los Angeles, Cal.

I send you this clipping to let you see what we are doing for fish protection, in this part of the state. The 4 men were each fined \$25.

Have also, in the last few weeks, pulled a number of illegal nets.

Frank A. Hackleman,  
Deputy Fish Commissioner.

The clipping reads as follows:

For some time it has been known that men have been seining the streams, and using dynamite. Deputy Fish Commissioner, Frank Hackleman, heard of this and has been watching for the offenders.

Recently he went to Dublin and had warrants issued for the arrest of David and Oliver Chrisman and Charles and Oliver Ostheimer. They were charged with violating the fish laws, by using a seine. Constables Green and Smith, of Dublin, and Reese, of this city, served the warrants. Prosecutor Metzger, of Wayne county, has the case in hand and the matter will be pushed to the end. The fine attached to each offence, like this, is not less than \$5 nor more than \$200. There are some 20 witnesses in this case.

I am always glad to learn of convictions, for violations of fish or game laws; and would be glad if my readers would report all such as they may hear of. Commissioner Hackleman deserves great credit for his prompt and energetic action in this case.—EDITOR.

The Camp Comfort Club, composed of Massachusetts and Rhode Island men, is having great luck fishing at Moosehead

\* Here are some men who are sadly in need of the civilizing influence of RECREATION, and if B. C. H. will send me their names and addresses I will gladly send them copies of this issue, with this paragraph marked.—EDITOR.

lake. On one day, 83 square tailed trout and 34 lakers were caught, a total of 117 fish. The largest trout weighed 3½ pounds, and the largest laker 14¼ pounds. The next day the total catch was 142 fish; the largest trout 4½ pounds and the largest laker 15¼ pounds.

The club record was broken by Milton Payne, who caught a laker weighing 17½ pounds and measuring 3 feet in length. Mr. Payne was an hour and 20 minutes landing his fish. The club has so far caught over 20 trout that would weigh over 3 pounds each. G. M. H., Bangor, Me.

L. E. K., West Fairview, hits the nail on the head when he asks for something for the beginner. Will some one please tell us how to cast the first fly?

I have as good an outfit as there is in the market, yet I cannot get my fly more than 20 feet away. Please give me my first lesson, or tell me where I can get it.

Fish Crank, Salina, Utah.

Will some fly caster please respond? There are several books that give these rudimentary lessons but I should be glad to print some original instructions, in RECREATION, if some of my friends will kindly furnish them.—EDITOR.

I send you to-day, a brown trout weighing 4 pounds 2 ounces, which was taken by Bill Keener, of Rockland, N. Y., under the railroad bridge over the Beaverkill.

This makes Keener's third big fellow this season. His first was taken in the same place, and weighed 4 pounds 10 ounces; and the second 5 pounds 2 ounces.

Please report this in RECREATION.

J. M. T., Williamsport, N. Y.

I measured this trout and he was exactly 20 inches long. He was a handsome, robust specimen, and Mr. Keener is to be congratulated on his rare good luck.—EDITOR.

Dr. Edward Hamm and C. A. Walker, of Chelsea, Mass., with the Hon. David Smith of Washington, D. C., enjoyed a successful fishing trip to Nova Scotia last spring. They crossed over from Boston to Yarmouth, via Yarmouth S. S. Co., and went into the woods from Hectanooga, a station on the D. & A. Ry., 21 miles North of Yarmouth. Striking the headwaters of the North Branch of the Tusket river they spent the last 2 weeks of May fishing the river and its tributaries, down to Tusket. They caught all the trout they could use, beside a supply for their friends. In consequence of unusually high water they used large, light colored flies, salmon sizes being the most successful.

## SULLIVAN COUNTY NOTES.

The Trout fishing in Sullivan County, N. Y., is better this year than for several seasons past. The following items are a few, only, of the many that could have been gathered from local newspapers:

William Keener, of the Roscoe House, caught, at the forks of the Beaverkill and Willowemoc, 2 trout which weighed, together, 6 pounds 6 ounces. The largest weighed  $4\frac{1}{2}$  pounds and measured 22 inches in length. The smaller one weighed 2 pounds, lacking 2 ounces. Both of these trout were caught at nearly the same place and within a few minutes of each other, on a No. 8 fly hook.

General Superintendent Edward Canfield, of the O. & W., was presented with a trout, Saturday, which weighed  $2\frac{1}{2}$  pounds and measured 17 inches. It was caught on a fly, by Walter Peak, at Trout Brook. He had one of the prettiest fights in his fishing career, in landing it.

"Ding" Darling and Charles Smith visited the West Branch of the Neversink, near Claraville, and brought home over 300 trout.

T. E. Hayes and W. L. Millspaugh caught 21 trout, in the Willowemoc, which weighed 20 pounds.

Howard Fredenburgh caught a California trout, under Sherwood's mill dam, at Livingston Manor, which was  $19\frac{1}{2}$  inches long and weighed  $3\frac{1}{2}$  pounds. He caught a second one, a little later, which weighed about  $1\frac{1}{2}$  pounds.

Gus Kaiser and Jack Morris, of New York, spent 2 weeks at D. Murdock's, near Parksville, on a trout fishing excursion. They report the fishing excellent, having caught 59 the first 2 days. Mr. Kaiser caught a trout 19 inches long, in the Little Beaverkill.

O. H. Brown, of Middletown, caught 37 trout in the Willowemoc, Thursday.

Emery Keene of Emmonsville, near Livingston Manor, caught a lake trout, weighing 4 pounds, in Forest lake, and Israel Winner caught a brook trout there which was 16 inches long.

F. G., New York City.

We have good fishing here. A friend and I caught, in  $2\frac{1}{2}$  hours, in Lake Underhill, a mile from Orlando, 29 black bass, weighing  $\frac{3}{4}$  of a pound to 3 pounds each; one weighed 12 pounds. I fished, while my companion managed the boat. I used a No. 12 Bristol steel rod—the best rod made for the money—and a No. 2 spoon. This I consider the most killing bait on the market.

A. M. N., Orlando, Fla.

I think RECREATION the brightest and best sportsmen's journal published.

Fishing in local streams, Big and Little Miami, last spring was not good. Too much rain; still, some nice strings were caught. Jas. Hickman (Kingfisher), caught 12 fish, averaging a pound each; and I caught 8, about the same size, in one day's fishing.

T. L. S., Cincinnati, Ohio.

The game laws are not enforced as they should be, in this section. Still, there is better fishing in Seneca river than for some time past. It is easy to get a good string almost any day; pickerel, mostly, being the catch now. One man, in one afternoon, got 32, of 2 to 8 pounds each. Whipping with pole and spoonhook, is the best way to catch them.

J. O. B., Savannah, N. Y.

Fishing is good in the Yellowstone, and smaller streams. An angler caught a rainbow trout, recently, weighing 6 pounds 6 ounces. The Park line is here, and the streams are teeming with all the trout species—salmon, rainbow, brown, brook, and Loch Leven. We also have good grayling fishing, on the Madison.

J. W. H., Crevasse, Mont.

I have been propagating muskalonge, on Lost lake, in Northern Wisconsin. This is at the head of the Chippewa river, in one of the wildest places in America, where the waters are alive with fish, and the forests full of game. Lost lake is one of a chain of 4 lakes, in Sawyer county, 45 miles from Lake Superior.

F. W. Cheney, Jamestown, N. Y.

A party of 4, of whom Irving Totten was one and I another, started to fish at 9.30, one morning, and stopped at 3 p.m. A count showed almost 300 smelt and about a dozen perch. We divided and went home.

D. G. McR., Washington, D. C.

Expect to start soon for the Kedgwick river, in New Brunswick. This is a branch of the Restigouche, and has been leased by a few of us, for the term of 5 years.

H. O. W., Philadelphia, Pa.

Have just returned from my annual visit to Lake Winnipeg, for trout. Had a very enjoyable trip, catching 19 lake trout, weighing 84 pounds.

J. H. S., Haverhill, Mass.

The fishing season started in very favorably at Catalina island. Many yellow-tail, sea bass, etc., are taken daily.

B. C. H., Los Angeles, Cal.

Would like to see an article on pickerel fishing, in South Jersey ponds.

E. J. McM., Philadelphia, Pa.

There was some great fishing at Greenboro, Vt., last season.

A. W. S., Morrisville, Vt.

We have good trout fishing here.

J. E. B., Dingman's Ferry, Pa.

## GUNS AND AMMUNITION.

### TWO GOOD GUNS.

Des Moines, Ia.

Editor RECREATION.—We read a great deal in the sportsmen's press, from owners of guns, each writer commending the gun of his choice and advising brother shooters to buy guns of that make, regardless of the fact that what suits one shooter, to perfection, may not fill the bill for another man who may use his gun for a different purpose, and who handles and cares for it differently.

I do not wish to pose as an authority on the subject of guns and shooting. What I have learned has been learned in that best of all schools, practical experience. I have expended many a good dollar in guns, and have owned or shot all the better makes of American guns, carefully noting what I considered the good points and the weak points in all.

I finally concluded to order an imported gun, for trap use; and after looking over cuts of the several makes of good London and Birmingham guns I finally decided to buy either a Greener or a Cashmore. I had used a Greener and liked the shooting qualities and the durability of them. I should, in all probability, have sent in my order for that make of gun, had it not happened that about that time our fellow townsman, C. W. Budd, shot 2 matches here, with Dr. W. F. Carver, and that I had an opportunity to examine and note the deadly execution of the Cashmore, in the hands of this well known expert shot. That settled the matter. What is good enough for a shooter such as Carver is good enough for an amateur of average shooting ability. Mr. Cashmore received my order and, in due time, built me a gun of which I am proud every time I put it to my shoulder. He charged me a reasonable price and is a gentleman to deal with. My only regret is that the gun is too finely finished to hunt with.

Not wishing to wait the length of time it would require to order a second gun, from Birmingham, I concluded to buy an American gun, of cheap grade, for hunting purposes.

I ordered a Hollenbeck, or Syracuse, gun, on condition that I should give it a thorough trial, for a reasonable length of time, and if it did not prove satisfactory I was to return it and get my money back.

I did not return the gun. It answers the purpose admirably. Indeed it would be hard to find a more durable or a better shooting gun than this little 7½ pound No. O grade Syracuse.

Sportsmen you pay your money and take

your choice. I do not wish to dictate to anyone what gun he shall buy; but for a high grade, hand made gun the Cashmore is a lot of gun for the money. For a machine made gun the Syracuse is excellent value. Amateur.

### HOW TO LOAD.

Editor RECREATION: I should like to explain to G. E. S. and 11 Gauge, who replied to G. E. S.'s inquiry, my method for using 11 gauge wads in 12 gauge paper shells; not with the idea, however, of improving on 11 Gauge's device, but to give G. E. S., or any other fellow sportsman, a simpler and cheaper method.

I take an ordinary brass, or nickel loader, into the base of which I fit a circular band of copper or heavy tin sheeting; when properly fitted, so that it just fits the calibre of the loader, push it up until it rests between the barrel of the loader and the shell protectors, so that the end of the shell just comes against it. Your loader is now ready for use and will either load new shells, or will reload those that have been used without swelling the shell.

A little experimenting will show you the proper thickness of copper, or tin, of which to make the circular band. I use copper  $\frac{1}{30}$  of an inch in thickness, and could use a little thicker.

This contrivance is original with me, and if any lover of the gun, who wishes to try this method and does not clearly understand, or fails to succeed, will send me his address I will gladly explain further. I am using this device and will fill an empty nitro 12 gauge shell, which has been fired, with 11 gauge wads  $\frac{1}{4}$  inch, and send it for inspection; also a new shell filled in same way.

I do not think this superior to 11 Gauge's device, but it is simpler, cheaper, and can be used to reload as well as for new shells.

Dr. F. S., Clarksville, N. Y.

The shells are well loaded and the device seems a good one.—EDITOR.

### A WORD FOR THE SAVAGE.

I see there have been some inquiries in RECREATION about the Savage rifle, and I want to say a word in its favor. I think it is one of the best smokeless rifles on the market.

First,—it is simple of construction, durable and finely finished.

Second,—it has a circular magazine, thereby obviating the danger of exploding shells in it.

Third,—you can load it easily and rapidly, when used to it.

Fourth,—you can also use short range loads, in the regular shell made for the rifle.

Fifth,—it has a positive safety, making an accidental discharge impossible, when the safety is on.

Sixth,—it is the easiest to manipulate of any lever gun on the market.

Seventh,—the extractor is positive and powerful, ejecting the shell to the right with great force.

Eighth,—the gun is handsome, well balanced and weighs but  $7\frac{1}{2}$  pounds.

I have used the short range cartridges and find them accurate at 30 yards, shooting at same elevation as the regular charge, at that distance. Have never shot them at long range.

I have not had an opportunity to use a Savage on game, but from the way the soft nosed bullets tear holes in targets I made, by setting up dry spruce boards, an inch apart, I should think they had as much stopping power as a 50 express, without the weight, smoke or recoil of the 50.

Percy J. Bowker, Wakefield, Mass.

#### ABOUT LYMAN SIGHTS.

Portersville, O.

Editor RECREATION: I notice some of your readers are making inquiries as to the Lyman sights, on rifles. In my opinion a Lyman combination rear, and ivory bead front sight, on any rifle, doubles its value, for either hunting or target work. More accurate shooting can be done, under all weather conditions, and in all conditions of light, than with any kind of open sights.

With a Marlin 32-20 rifle, and Lyman sights, I have placed shot after shot in very small targets, at distances of 20 to 50 yards, after it was so dark I could not have seen through a crotch sight. If I could not get another set I would not sell mine and use open sights again, for the price of a new rifle.

One of my friends has a 25-20 Marlin and was using open sights, but after using my rifle one day he was thoroughly convinced of the superiority of Lyman sights, and at once ordered a set. The ivory bead is much superior to the hunting sight, for the front in my estimation.

Now a word as to choice of rifle. For an all round small game and target rifle, the 32-20 Marlin can not be improved on. Such a rifle will give the user more satisfaction than any of the new models lately brought out. It is more easily cleaned and it is easier to clean and reload the shells than it is the extreme bottle necked shells.

By doing your own loading you can shoot a 32-20 about as cheap as a 22. With the 32, small game is generally killed if only grazed; while with the 22 it takes a centre shot to kill game dead. But whatever cartridge you choose, you can not make a mistake in buying a Marlin.

J. T. Maris.

#### AMMUNITION.

Having carefully tested both my guns with the different nitros, I find the Cashmore makes the best pattern with  $3\frac{1}{2}$  drams of nitro,  $1\frac{1}{4}$  ounces of chilled 7s, in smokeless or leader shells. The Syracuse does the better with 3 drams nitro and  $1\frac{1}{8}$  ounces 6 shot. It also makes a fine pattern with  $3\frac{1}{2}$  drams of F. F. F. G. black powder, which load I use in my second barrel, in duck shooting.

I should like some brother shooter, who has used the new semi-smokeless, made by the King Powder Co., to give us the results. The advance in price of Shultz & E. C., makes trap shooting expensive sport, and it would be good policy for us to find some cheaper load until the price of nitros comes down.

Your correspondent "11 Gauge" sends cut of what I consider a dangerous loading block. No doubt it will seat the wads without swelling the shell: but if a shell should, by any chance, explode in the block it may do more. It may also kill the operator. I once knew of a shell exploding in a wooden block without doing much damage, beyond making kindling wood of the block. Suppose it had been a steel block. The charge would then have come out like a charge from a gun, at short range. Life is too short to take such chances, or to bother with loading one shell at a time when a good 50 hole block can be bought for a few cents. An 11 gauge wad can be loaded in a wooden block, without swelling the shell, if care be taken.

You need not use 11 gauge wads in modern guns, bored for nitro powders, and will get but indifferent results even if you use 11 gauge wads in the old style American guns which were not bored for the new powders.

Amateur, Des Moines, Ia.

#### LYMAN SIGHTS AND REPEATING SHOT GUNS.

Los Angeles, Cal.

Editor RECREATION: I wish to say, in answer to P. J. M., as to Lyman sights, that I consider them the best in the market, and I have used nearly all the others. The Lyman sights undoubtedly facilitate shooting, both in the woods and in the open, and strain the eye as little as possible, if any at all. The game is readily seen, through and



over these sights, and the strain on the eye is reduced to a minimum.

The ivory bead for the muzzle, and the triangle of ivory, set in a rectangular leaf of steel, which lies flush with the barrel when not in use, for the breech, make the finest open sights; and with the Lyman combination rear sight, for long range, which is placed on the stock just back of the trigger, a man must be hard to please if these do not fill the bill.

The placing of a sight as far back as the latter is of great advantage for accurate shooting, inasmuch as the greater the distance between the 2 sights the more readily is any deflection in the aim appreciated.

---

#### NOTES AND QUERIES.

I am a great admirer of RECREATION and am specially interested in "Guns and Ammunition"; but I think some of your correspondents must be inspired when they tell about killing game at 127 yards, with a shot gun, using  $3\frac{1}{4}$  drams powder and  $1\frac{1}{8}$  ounces No. 8 shot.

I do not believe any shot gun will throw No. 8 shot hard enough to kill game at 127 yards. I should like to ask Mr. Pinkham if he would be willing to make an oath that he shot 127 yards and killed game, with the charge as above stated; also what the game was.

I own a Forehand gun, that I think shoots about as close as any of them, though I do not claim it is the closest shooting gun in this world; but if I ever see any game at 127 yards, the game will be perfectly safe, whether I have No. 8 shot or No. 1 shot in my shells. I shall not waste any good powder at that distance.

Now brother sportsmen, give us the truth, the whole truth and nothing but the truth.

E. I. Latham, Hinsdale, N. H.

---

After testing the new semi-smokeless powder, the latest product of the King Powder Co., I have nothing but praise for it. When shot from a rifle, it is as accurate as black powder; a little stronger, bulk for bulk, than ordinary f.f.g., while it burns remarkably moist and clean in the barrel.

It is loaded the same as common black powder and strong primers are not necessary. It possesses all the good qualities of the best nitro compounds, but is sold at half their cost. I have no interest whatever in the sale of this or any other powder. I only wish to call the attention of brother sportsmen to a good thing.

J. P.

---

In the June number of RECREATION, "Moody" says he is looking for a repeater

that will shoot the 22 calibre cartridge as good as a certain little single shot. I would recommend the Marlin 22 calibre as a rifle of the most extreme accuracy. A friend of mine owns one, and from the trials I have made with it, I know it will shoot as well as any rifle can be made to shoot.

G. H. Swift, Harbor Springs, Mich.

---

Will some reader of RECREATION kindly give me his opinion of the Remington rifle, No. 2, for wing shooting.

I prefer the .22 calibre rifle, of that make, but am willing to yield to wiser heads if they think the .32 is better.

Would also like the advice of some reader as to the kind, model and calibre of rifle which could be used to best advantage for the game in the Adirondack mountains.

M. A. Lewis, Long Branch, N. J.

---

Will some of the readers of RECREATION tell me how heavy a pull they consider best for a hunting rifle, on which it is impossible to put a set trigger?

I read RECREATION with great interest, and find but one fault. It does not come often enough.

J. S. Barron, M.D., New York City.

---

I should like to hear from some of the shooters who have used the 25-20 Winchester repeater, model 1892, the 25-35 Winchester repeater, model 1894, or the 25-36 Marlin repeater, model 1893.

I can't see how anybody who likes to shoot or fish can do without RECREATION.

J. M. M., Beloit, Wis.

---

I would like to hear from some of the shooters who have used a 25-36 Marlin repeater.

Can black, or low pressure nitro powders, with lead bullets, be used in this arm, with any degree of success? RECREATION is the king of sportsmen's magazines.

J. M. Miller, Verdery, S. C.

---

I will esteem it a personal favor if you will send me the names and addresses of all the sportsmen you know, who are not yet readers of RECREATION.

---

Study the anatomy of the grizzly on page viii. Mark the 3 shots, as you think they were planted, and send in the result.

---

Where would you aim at a grizzly, if he were walking slowly by, at 50 yards? This is a mighty serious question, when you come to sit down and think of it. Take 3 shots at the one on page viii, and send in your score,

## MY "RECREATION."

HON. S. B. MCMANUS.

Dedicated with hale and hearty regards, to the readers of this magazine.

With wooing easy chair drawn close beside  
the fire,  
Whose warmth and light just strike the  
happy mien,  
In comfort quite complete—with little to  
desire,  
My pipe fresh filled with brave old "nico-  
tine,"  
I open up my book, that care-kill book of  
mine  
And yield myself to thought that comes  
near to divine.

No more of anxious care (why must one  
care and fret,  
Till life seems but an irony at best?)  
With mind and heart unchained—no tram-  
mel, but to let  
Them wander as they list in happy, joyous  
zest,  
O work begone, and care and fret good-  
by;  
I'm once again beneath God's clean and  
clear blue sky!

I breathe the scent of trees—the balsam-  
laden air,  
And catch the whispered gossip of the  
leaves,  
And see the birds enplumed in garments  
rich and fair—  
And lo! I hear a song as in and out it  
weaves  
Its happy way in scores of dainty lore,  
While bush and branches wave a hearty,  
hale encore.

I note the splash of trout within the moun-  
tain stream—  
I see the lake, betrayed, yield up its choic-  
est gift,  
I hear the thrilling click and catch the flash  
and gleam  
Of reel, and see the rod its brave game up-  
ward lift.  
A thousand lakes I see and rivers like a  
strand  
Of quivering, laughing light illumining the  
land.

Anon, I see the flash (or is it lightning's  
play?)  
Of gun and hear the peal (or is it thunder's  
crash?)  
Of rifle, as it speeds the bullet on its way;  
And see the game through brake and tangle  
lash.  
That strange thrill fills my soul—so hard  
in words to tell—  
The joy of prizes won—the sorrow that  
they fell!

The camp fire, too, I see—that beacon of  
the wood,  
And round it with boon comrades do I sit;  
And feel that glowing sense of freedom  
rare and good—  
While incense-like come perfumes from  
the spit  
Of broiling steak or fish—a feast fit for a  
god,  
The trophies of the chase, the harvest of the  
rod.

And thus I think and think and dreaming,  
smoke and smoke,  
And con the smiling pages one by one,—  
And inward bless the man whose spell can  
thus invoke  
By print so great a joy; a task is sure well  
done  
O RECREATION, where one pain is turned to  
bliss,  
And yours a thousand turns, my brave  
young alchemist.

## NATURAL HISTORY.

### COYOTES ALSO DOPE.

Railroad Creek Lake, Chelan, Wash.

Editor RECREATION: I notice Mr. E. S. Thompson's query regarding the habit wolves have of rolling in decomposing animal matter, and Mr. T. seeks further enlightenment on this subject. This habit is not confined to wolves alone, but most, if not all, members of the canine race are more or less addicted to it. I have shot and trapped a number of coyotes in Montana, and have observed many little points that were of interest to me. Among them was the practice alluded to.

The coyote rolls in carrion and apparently enjoys the sensation. I have seen one in the act of doing so. He was dopping in the entrails of a dead horse. This coyote had been feeding on the carcass, but selected the meat on the under side of the loin for its meal, and then rolled its head, neck, shoulders, and breast in the offal, exactly as a dog will disport itself on the grass, after having a bath. What its object was I never could guess, but always supposed the odor was pleasing to the coyote.

Dogs do the same. When with a party of English sportsmen, in the Belt mountains, we had a large English retriever, which was very intelligent and companionable. One evening he came in in the most vile condition imaginable. His black curly coat was covered with filth and showed too clearly, even if the soul stirring odor had not convinced us, where he had been. He was not allowed in or near the house for a week. Even small, carefully kept pet dogs indulge in this luxury when they have the chance; but opportunities are not so plentiful in a town, or in a thickly inhabited country. On the stock ranges, dead animals are plentiful.

This retriever I have mentioned had no special need to disguise his scent. How then, can his actions be accounted for? I am of the opinion dogs and wolves enjoy the smell of putrid meat and we all know how dogs bury bones and meat until they get "high" and tender. Coyotes do this too, for I found where one had buried a dead lamb. It bore the regular coyote mark—a bite across the neck.

While writing these items I am wondering whether a fox will indulge in this practice. They were very scarce in the section of Montana I lived in, and opportunities for observing their ways were correspondingly so. There is one other animal that does roll in filth, and that is the otter.

With me now is a hunter and trapper, of 25 years' experience. He has trapped fur bearing animals of all kinds, in the Idaho mountains. He tells me an otter

will go some distance from the rivers it haunts, if there is a dead and decomposing animal to be found, and will roll and disport itself among the entrails, although it will not eat a morsel unless hard pressed with hunger. This man caught a number of otters, in the Salmon river country and, whenever possible, would place rotten meat near the river to attract them.

Chas. Greenwood.

I should like to say to Ernest Seton Thompson, in reply to his inquiry in June RECREATION, as to the habit of animals rolling in carrion, that I have a Gordon setter which always does this when any carrion is found that is too filthy to eat.

I first noticed it last winter, when a decayed fish was found in the snow. After smelling it the dog rolled on it; and for several days thereafter she would go out of her way to roll where the fish lay, under the snow. Again last spring I found her rolling on the decayed body of a hen. At other times I have discovered traces of filth on her back, which proved that this is a habit with her, and that the habit is not confined entirely to wolves.

I should like to hear an explanation, and to learn a way to stop the dog of thus polluting herself. G. H. R., Necedah, Wis.

I notice in this month's RECREATION, Mr. Ernest Seton Thompson's query as to whether any of the readers of RECREATION have noticed the habit wolves have of rolling in carrion that they would not deign to eat. This trait of the wolf never came under my observation; but I have owned several English and Irish setters that had adopted that manner of perfuming themselves, whenever they could find the perfumery. The reason for such action never occurred to me until I ran across Mr. Thompson's article. I have owned dogs of various other breeds, but have never seen any of them scent themselves in this obnoxious fashion. I would be pleased to hear from others, through the columns of RECREATION, in regard to this peculiarity.

K. H. Cressman, Leech, Minn.

I notice in your June number an inquiry by Mr. Thompson as to the reason for wolves rolling in carrion. His suggestion that wolves do this to overcome the odor natural to them, in order to make it easier to avoid causing fear to other animals, seems rather far-fetched. It is undoubtedly a habit belonging to the dog tribe, as dogs almost invariably roll in the carcass of a dead animal. I cannot say they use all dead animals thus, as I have observed it only in the case of cattle, whose carcasses are common in the cattle region, and are

large enough to give the dogs opportunity to roll completely. In all probability dogs do this to drive away fleas—at least I can think of no other good reason. Dogs frequently roll on the ground or floor, apparently to produce a reaction of the skin, and to get relief from fleas, and in my opinion they roll in carcasses for the same purpose.

R. M. Allen, Ames, Neb.

Noting Mr. E. S. Thompson's inquiry as to whether or not others had noticed the habit which wolves have of scenting themselves, by rolling in carrion: I have not had the opportunity to observe the habits of wolves in this respect; but it is common to nearly or quite all dogs, whether of high or low degree.

I have also observed the same habit in cats; but in only a few instances. From the action of the animal while engaged in rolling in the carrion I believe the motive is one of personal gratification, as they seem to enjoy the odor and exhibit every sign of pleasure during the action.

F. C. Koons, Louisville, Ky.

#### THOSE DROOPING HORNS.

San Diego, Cal.

Editor RECREATION: It is of record in Holy Writ that "The Preacher" in Ecclesiastes, commonly held to be Solomon, the wise son of David (on both of whom be peace), maintained that "The thing that hath been, is that which shall be; and that which is done is that which shall be done; and there is no new thing under the sun." It is the purpose of this screed to put in evidence an odd instance of the accuracy of this solemn dictum of the aforesaid Solomon, wisest of mortals, youngest son of David and Bathsheba, and remote progenitor of Christ, according to Matthew, but not according to Luke (on all of whom be peace).

In June RECREATION there is a picture of a lophorned antelope. A note accompanying the illustration states that, previous to his reduction to the last common denominator of the deer family, viz. venison, the former and original proprietor of the head had the strange habit of walking backward while feeding; being compelled to do so by his long, drooping horns.

To refresh my memory in the matter of antelope horns, I have before me the heads of 2 antelope bucks. These animals I assassinated on the high mesa at the head of the Arroyo Grande, some 400 miles Southeast of San Diego, in the Mexican Territory of Baja California, 4 or 5 years ago.

Now it seems to me these head ornaments constitute Nature's most successful attempt to set up, in horn, an interrogation point. There is a snag half way up, as if the maker of the horn had been af-

flicted with a hiccough, in the middle of his job; but all the same the horns are right good marks of inquiry. Nor could any other shape be half so appropriate; for probably no creature that wears horns is so incurably addicted to idle curiosity. So, on its ever inquisitive noddle it carries its points of interrogation. But the above-mentioned freak, in Laramie, is just the opposite of all this. He appears to have lost his curiosity before his horns started. Possibly he sneezed when they were freshly put on, and still warm.

And to think this unique beast was under compulsion to do all his feeding, as the Parthians were said to do most of their fighting, "on the retreat." Remarkable? Very! Something entirely new? Well—hardly—if we hold opinion with Solomon.

It is true Solomon is a back number. Nearly 27 centuries have flitted since he inflicted grief, or at least mourning, upon his thousand widows, by passing over to that New Jerusalem whose single portal is the grave.

But Herodotus, the clear-headed old Greek, has something to say that substantiates Solomon's proposition. Herodotus is also a "has been"; but not so far back among the dead yesterdays as Solomon, by more than 5 centuries. This is what the venerable "Father of History" says in Book IV. (Melpomene); paragraph 183, while speaking of the Lotophagi: "Among them the kine that feed backward are met with; they feed backward for this reason: they have horns that are bent forward, therefore they draw back as they feed; for they are unable to go forward, because their horns would stick in the ground." The genial old story teller joined the innumerable silent majority 424 years before the birth of Christ. May the clods rest lightly on his dust, for he deserved well of his kind. The reading of his quaint pages will afford instruction and delight to myriads yet unborn.

R. J. Gregg.

#### RECORD BUFFALO HEADS.

Bozeman, Mont.

Editor RECREATION: In the interest of science, and for the benefit of sportsmen, I herewith enclose the certified and sworn measurements of 3 buffalo bull heads, to be placed on record. All of them exceed Mr. Sheard's record-breaker, in point of circumference of horn. The largest is 17 $\frac{3}{4}$  inches and the greatest length of horn 22 inches.

The measurements were made by J. M. Robertson, a civil engineer and surveyor, and at present under sheriff of Gallatin county, Mont., in the presence of several witnesses. He used a new tape line, which had been carefully tested and found correct. These measurements were taken

from mounted heads, and so far are the largest on record.

Bozeman, Mont., July 10, 1897.

HORN MEASUREMENTS OF 3 FULL-GROWN BISON HEADS.

|                                              | No. 1.             | 2.                 | 3.                 |
|----------------------------------------------|--------------------|--------------------|--------------------|
| Circumference of left horn at base . . .     | 16 $\frac{3}{4}$ " | 15 $\frac{1}{2}$ " | 17 $\frac{3}{4}$ " |
| Circumference of left horn above base . . .  | 14 $\frac{3}{4}$ " | 14 $\frac{3}{8}$ " | 14 $\frac{1}{2}$ " |
| Circumference of right horn at base . . .    | 16 $\frac{3}{4}$ " | 15 $\frac{1}{4}$ " | 17 $\frac{3}{4}$ " |
| Circumference of right horn above base . . . | 14 $\frac{1}{2}$ " | 14 $\frac{1}{4}$ " | 13 $\frac{3}{8}$ " |
| Length of left horn—base to tip . . . . .    | 22"                | 20"                | 19 $\frac{3}{8}$ " |
| Length of right horn—base to tip . . . . .   | 21 $\frac{1}{2}$ " | 20 $\frac{1}{8}$ " | 19"                |
| Spread of horns—from tip to tip . . . . .    | 27 $\frac{1}{4}$ " | 27"                | 19 $\frac{1}{2}$ " |
| Spread of horns—at widest part . . . . .     | 35"                | 33"                | 30"                |

We, the undersigned, who measured the 3 bison bull heads in Bozeman, Mont., do hereby certify, that the above measurements are correct.

James M. Robertson,  
Aug. Gottschalck.

I hereby certify that on this 10th day of July, A.D. 1897, personally appeared before me James M. Robertson and Aug. Gottschalck, who being first duly sworn say that the above and foregoing statement is true and correct in every particular.

A. D. McPherson,  
Notary Public.

I also enclose photos of 2 unmounted buffalo bull heads, which outmeasure the noted "J. G.," Middletown, N. Y. head. The measurements are as follows:

|                                                  | No. 4.             | 5.                 |
|--------------------------------------------------|--------------------|--------------------|
| Circumference of left horn at base . . . . .     | 14 $\frac{3}{4}$ " | 13 $\frac{3}{4}$ " |
| Circumference of left horn above base . . . . .  | 14 $\frac{1}{4}$ " | 13"                |
| Circumference of right horn at base . . . . .    | 14 $\frac{1}{2}$ " | 14"                |
| Circumference of right horn above base . . . . . | 14"                | 13 $\frac{1}{2}$ " |
| Length of left horn . . . . .                    | 19 $\frac{1}{2}$ " | 19 $\frac{1}{2}$ " |
| Length of right horn . . . . .                   | 20 $\frac{1}{8}$ " | 19 $\frac{1}{8}$ " |

August Gottschalck.

Photographs received but are not reproduced because the heads shown therein are not materially different from others recently illustrated in RECREATION, except as to size. The photographs show tape line tacked on horns, and the reading of the lines shows above measurements to be correct.—EDITOR.

AN HEGIRA OF HAWKS.

Wichita, Kans.

Editor RECREATION: An unusual sight, and one which it is the privilege of but few men to witness, was seen on the military reserve surrounding Fort Reno, Oklahoma, in October, 1896. Only the few who happened to be passing across the reservation at that time saw the occurrence, and it was a great source of wonderment to all. Some of them were old time

hunters and plainsmen, but had never seen the like before.

We were driving North, and on reaching the top of a hill, a long, dark streak could be seen, to the West, about a mile distant. It extended to the Northward about  $\frac{3}{4}$  of a mile, and stretched away to the South more than a mile.

At first it seemed only the shadow of a cloud, but the sky was perfectly clear, and the real cause was then a mystery. Driving faster we soon found the long, dark streak was a gigantic convention of hawks, of various species.

The road lay directly through the line, and we hesitated before driving near them, as we expected them to fly when we approached, but not one of them stirred. We drove in among them, and they paid no attention to us, except that those in the road leisurely walked out of the way and stopped.

All the species of hawks I ever saw were there, except the little sparrow hawk. Some were as black as ravens, and there were a few goshawks—which are seldom found so far West. There were many of the common chicken hawks, a few pure white,\* some red shouldered, and other varieties, with which we were unacquainted.

Some of the birds remained so near that our driver struck at them with his whip; but even these only ran out of reach and did not take wing.

The birds all faced North, and not one of them even looked around at us, save those who were compelled to get out of our way. They seemed very tired, yet every eye was open.

We passed through this great throng, for a distance of  $\frac{3}{4}$  of a mile. The birds stood 3 to 8 feet apart. It was a very strange and interesting spectacle. They were evidently bent on some long migration, and had simply stopped here to rest.

After we had left them about  $\frac{1}{4}$  of a mile behind, those at the Northern end of the flock first arose, and flying just far enough Northward to gain their balance, swung off to the left and turned South; the others getting up and following in order as their turns came. It looked like an immense scroll, as the birds arose in perfect order, and gracefully swinging around to the left, followed the head of the column. The noise made by the wings was distinctly audible when the nearest birds were 200 yards away; and the movement of the air, as the first half mile of them passed over us, was sufficient to disturb the loose ends of the handkerchiefs about our necks.

Franklin L. Paine.

GAZING INTO THE GATES OF HELL.

It would indeed be difficult to decide as to which is the most wonderful feature

\* There is no species of pure white hawks in America, and these must have been Albinos.—EDITOR.

embraced within the Yellowstone National Park. After taking into consideration the peculiar features of the paint pots, with their fine tints of cream, pink, drab, and delicate blue, all bubbling up and forming beautiful flowers of every color embraced in a rainbow—and all of mud; after standing in awe and silence a thousand times, meditating over the wonderful geysers, throwing out their boiling streams 150 feet into the air; after meditating over the wonders of the fiery region of Hell's-Half-Acre, with its prismatic pools and diamond sparkling bottoms; after taking into consideration all the great wonders to be found along the Fire Hole river, which certainly must be the pathway to Hades; after pondering over the countless geysers which pour forth their clouds of steam and water, the one most horribly grand sight, in my opinion, is the mud geyser. The rumblings of this strange freak can be heard long before one reaches its immediate vicinity. As it is approached one becomes aware of a sickening odor, of something which cannot be described. Away down in the side of a mountain is a tremendous open mouth, and from it is belched forth a seething mass of boiling mud, accompanied at all times with the awful rumblings of a vomiting world. To look down into the open jaws of this huge monster, one imagines he can gaze into the very gates of hell.

L. M. Earl, Salt Lake City, Utah.

#### AN EXHIBITION OF ANIMAL PAINTINGS.

About June 1 the executive officers of the Zoological Society began a systematic effort to increase the membership of the organization. A *News Bulletin* was published, containing "A Call for Friends and Funds," and the friends of the Society and the Zoological Park were invited to hold up their hands and be counted.

At once applications for membership began to come in, from persons desiring to become patrons (\$1,000), life members (\$200), and annual members (\$10 a year). Since June 1 the Executive Committee has held 2 meetings for the election of new members, and the membership of the Society was increased by the addition of 2 patrons, 18 life members and 151 annual members. On July 20 the total membership consisted of 3 founders, 10 patrons, 64 life members and 313 annual members, with new applications coming in daily.

The result of the campaign, thus far, has been very gratifying to the officers and members of the Society: for it shows the public is in hearty sympathy with the work undertaken. The first result of this practical manifestation of sympathy and good will was the decision of the Executive Committee to at once take steps to carry out its long-cherished plan to make a systematic effort to encourage and promote the paint-

ing of American wild animals. The Society has therefore decided to hold, next February, a general and competitive exhibition of oil paintings (in colors) of American quadrupeds, birds and reptiles, and to offer, for the best work, a series of cash prizes and medals. The details of the plan are now being perfected and an announcement, to American animal painters, will soon be made—possibly before this issue of RECREATION shall have gone to press. I am assured, however, that every effort will be made to stimulate not only the production of high-class paintings of our animals, but also the purchase of them, by our art galleries and art patrons. It is the deliberate intention of the Society to make the New York Zoological Park the centre of the world for animal painting and sculpture; and the exhibition proposed will be only the first of an annual series.

The readers of RECREATION need not be told that the editor of this magazine regards this important step of the Zoological Society with intense satisfaction. As a lover of wild animals, I am naturally interested in the production of good pictures of them, in the preservation of their beautiful forms, on canvas and in bronze, as well as in museums and zoological gardens. The long series of animal pictures which RECREATION has been placing before its readers, ever since it began to be a magazine (and the best pictures to be had for money!) fully attest my own love for such works of art, and my belief that other people also love them.

The results of the Zoological Society's movement, in behalf of our animal painters and sculptors, will be far reaching, and of great importance. Its benefits will be shared by millions of people who thus far have not even heard of the Society. To our shame be it said that at present there is not, so far as I can learn, a single high-class painting of an American wild animal to be found in any public art gallery in the United States! And this in a country which has the finest big-game fauna of any temperate region in the world!

I hope that before the expiration of this year, enough more persons will have joined the Zoological Society to bring the total membership up to 1,000. And to that end I shall labor. Send me your check for \$10 and I will present your application for membership.

#### THE DEATH LOCK.

Chicago, Ill.

Editor RECREATION: The accompanying photo of the heads of 2 deer, with horns interlocked, is, in some respects, the most remarkable ever secured, one of the deer having been alive when found in their desperate plight.

In November, 1895, Mr. F. F. Strong, a

well known Chicago business man, and an ardent sportsman, was, with a small party of friends, hunting near Indian river, in Schoolcraft county, Michigan. One day, when the party was out, ravens were noticed hovering noisily over a certain spot, and, attracted by curiosity, the hunters sought the cause. Emerging into a comparatively open space, in the wood, they made a discovery. For the space of nearly an acre the ground was torn and furrowed by the hoofs of 2 bucks, and near the centre of the open space lay the bucks themselves, with their horns inextricably locked.

One of the deer was dead and the hungry ravens had already eaten both his eyes, though deterred from further feasting by the occasional spasmodic movements of the surviving combatant, whose eyes were already glazing.

The hunters put the live deer out of his misery, cut off the 2 heads and photographed them, as here shown. The heads were subsequently mounted and are now owned in Grand Rapids, Michigan.

Mr. Strong, who was of the party, is the father of H. M. Strong, game warden of New Mexico, who is doing efficient work in preserving the game of that territory. Reports of some of his rides, after violators of law, would astonish the wardens of some of our older states. Stanley Waterloo.

#### GOATS ON THE SNOW.

One of our lucky mining men here, Mr. J. H. Holden, was telling me of a curious habit he observed in the mountain goat, last summer. He was prospecting, far up a tributary of Railroad creek, and one day stopped to eat his lunch near some snow banks. His climb had been a long, hard one, and fatigue caused him to fall asleep. On awakening, there were goats all around him. He counted 34. Then he lay there, quietly, and watched them. One would make a bed in the snow and lie there, rubbing itself a little while. Then it would get up, go a short distance, make another bed, and repeat the process, continually. The prospector thinks the reason for these antics was that wood ticks were troubling the goats, and the rubbing in the snow was to cool the irritation thus produced. It was in June too, and their winter coats were shedding.

We often find goat wool (it is always called wool here, for, excepting the long outer hair, it certainly resembles it) adhering to trees and rocks. The Indian women spin it into a kind of yarn and make it into socks. The Puget sound Kloooh-men also weave it into blankets.

One of the men killed a large lynx, with a 22 calibre rifle, a few days ago. Its fur was in good order, notwithstanding the lateness of the season, for it had lived at a great altitude. Charles Greenwood.

I have always taken great pleasure in reading your magazine carefully. In your May number I notice a controversy regarding buffalo heads. I send you by mail a photograph of a buffalo bull head that I own. You will notice the 2 fore feet are mounted with the head, on an escutcheon which is 4½ feet high. This bull was killed in December, 1890. The hide weighed 96 pounds when taken off, and I had it mounted as a rug, for my library floor. The head is in perfect condition and if you desire special measurements I shall be glad to send them; although the size of the escutcheon, as stated above, will give you an idea of the size of the head.

A number of sportsmen, hunters and taxidermists have examined this specimen and pronounced it the finest they have ever seen. I do not know of any buffalo feet in the country, excepting the hind feet from this bull, which I gave to a friend in the West. I also have about 30 pairs of first class buffalo horns.

H. H. Meday, Detroit, Mich.

Two cars containing 12 buffaloes, 20 antelope and 20 male deer have been received by former Secretary of the Navy W. C. Whitney, at his beautiful country place in Lenox, on October mountain.

The shipment came from B. R. Adams, of Wyoming. Last year 33 head of elk were received from his ranch.

A special enclosure of some 500 acres has been built for the buffaloes, and a 12 foot wire fence, of tested strength, built by the Page Woven Wire Fence Co., Ann Arbor, Mich., will keep the animals within bounds. The park is being rapidly stocked, and the animals show great care in selection.

I have lately received, from South America, the largest jaguar skin I have ever seen. It measures, from tip of nose to tip of tail, over 7 feet, and across the hind legs 5 feet. Who knows of a larger one?

RECREATION is the best sportsmen's magazine ever printed.

R. Marron, Taxidermist,  
Jersey City, N. J.

Colonel R. Dale Benson, of Philadelphia, killed a coot, last spring, at Bengies point, which is regarded as a great curiosity. Its back plumage is bright red, instead of the usual dark color.

As to Mr. E. S. Thompson's note about wolves rolling in carrion: Dogs and otters do the same; and I can see no reason why an otter should try to hide his odor, for he captures his food under the water.

F. E. White, Jackson, Wyo.

## EDITOR'S CORNER.

### WHY I USE FIGURES.

I have frequently been criticised for using figures to express numbers. The following correspondence explains why I do so.

"I enjoy RECREATION very much, and would enjoy it more if you would only drop your present fad of printing numerals of all kinds in figures. It is a pity to spoil the appearance of an otherwise well-written article by dotting it all over with figures, many of which are put in the place of real words—adjectives!

"In these 2 ways it is claimed, etc.' How absurd! How silly!"

Geo. A. Kellogg, Eureka, Cal.

Dear Sir: I note, that at the end of one of your sentences, you place a small round dot. I assume this is meant for a period. If so, why not say so? Why use a sign when there is a word in the language that would express your meaning, more fully and elegantly?

You speak of my printing numerals of all kinds in "figures," and this word is underscored. I assume the wavy line, underneath, means this word is to be specially emphasized in reading your letter. If so, why not say so, in words? Why deface your letter with a sign like this, when the English language is capable of expressing your meaning at greater length? Of course, the words would take up more room in the letter, and it would take longer for you to express yourself in that way; but if your criticism on my printing numerals in figures is just, then you are sadly at fault in not carrying out your own theory, when writing letters.

After the word "adjectives" you place a vertical dash, with a dot under it. I assume this means that you wish to express astonishment. If so, why not express it in words, instead of in a sign? Of course, the sign is much more brief; and brevity is said to be the soul of wit. Beside, most people are busy nowadays, and they like to economize in time and in space; yet it is just as rude and impolite for you to use these signs in your letter, as it is for me to use the figures 14 to express the idea that would be conveyed by printing out the word "fourteen."

Your letter is dated April 7, 1897. Why do you use figures to express these dates? Why not write out "April Seventh, One thousand Eight hundred and Ninety-seven"? It is a pity to mutilate a letter, that would otherwise be intelligible and interesting, by the use of such abbreviations. How absurd! How silly! EDITOR.

### TO ANOTHER CRITIC.

My dear Mr. Nelson:

The fact that other publishers have been spelling out words, for a hundred years, when figures would have expressed their ideas much more energetically and tersely, is no reason why RECREATION should do so. Neither does it prove that these same publishers will always continue in this antiquated style. Our forefathers used to write out, in words, the date "One Thousand Seven Hundred and Seventy-six," for instance; and the public printer at Washington still does so, in all legal documents. Even the great magazines, however, have improved on this stilted form, and write this year of our Lord—"1897." I am well aware that many people object to my use of figures, but people object to every reform that is instituted, and when all the other great magazines adopt figures, instead of words, I shall have the satisfaction of pointing to my bound volumes and saying, "I told you so."

When any man can give me a better reason than tradition for printing "seventeen" instead of "17," then I shall be glad to consider his suggestion; but this is too busy an age for people to live on tradition. Our great grandfathers used to wear brass buttons on their dress coats. Our grandfathers followed suit, and even some of our *fathers* did so. But we of the present generation, have found we can be just as comfortable with cloth covered buttons on our coats. These old forefathers—or rather 3 fathers—also wore white beaver hats, with long nap and broad brims. Would we not look rather grotesque if we still followed their style? If we can improve on the methods of our ancestors in some ways, why not in others? Yours truly,

THE EDITOR.

### A SAD BREAKING OF CAMP.

My old friend, M. W. Miner, who is well known to readers of RECREATION, writes me, under date of June 27th, of the loss of his partner and hunting companion, A. B. Lyons. They were camped on the middle fork of Salmon river, where they were prospecting. Lyons had an attack of grip and became delirious. The 2 men were alone and Miner watched and cared for his friend, day and night for nearly a week. Having been 4 nights without sleep, Miner finally got his patient quieted and lay down, at 3 o'clock on Friday morning, to get some rest. When he awoke, Lyons was gone. He had gotten up quietly, put on his rubber boots and gloves, had taken a 6 shooter, a wagon sheet and a walking



stick and had quietly left camp, in the darkness. As soon as Miner awakened, he called to his aid 2 trappers, who were camped about half a mile away, and the 3 men searched the country, thoroughly. The only trace they could get of the missing man was the wagon sheet, which they found hanging on a bush near the creek, and the walking stick, which lay near the water's edge. They also found a few foot marks.

They dragged the creek and the river, industriously, for long distances, but failed to find the man, or any further trace of him.

Mr. Miner thinks Lyons undertook to cross the creek, was drowned and washed down into the Salmon river. Miner at once went to Banner, Idaho, and reported the case to the authorities. A further search is being made, and ranchmen and miners, living along the river, have been notified.

All the friends of the missing man, and of Mr. Miner, will be deeply grieved at this sad intelligence. Lyons was a big hearted, genial, good natured man; an enthusiastic hunter and was liked by every one with whom he came in contact.

---

THE FRESH AIR FUND.

New York, July 13, 1897.

Treasurer, St. John's Guild,  
501 Fifth Ave., City.

Dear Sir: I hand you herewith my check for \$60, being amount contributed by readers of RECREATION for the Sick Children's Fresh Air Fund. I hoped to have had a much larger sum for you by this time, but it seems my readers, generally speaking, have so much fresh air they cannot understand how any one else can be in need of it.

Yours truly,  
G. O. Shields, Edr. and Mgr.

ANSWER.

ST. JOHN'S GUILD,  
Office, No. 1 Madison Ave., New York.  
July 14th, 1897.

Mr. G. O. Shields,  
Edr. and Mgr. RECREATION,

Dear Sir: Your valued favor of the 13th inst., enclosing check for \$60.00, has been received, and I return you, herewith, the Treasurer's receipt for the amount.

On behalf of the Board of Trustees, I beg to thank you cordially for your interest in the work of the Society, and the very material aid that the contribution of the readers of your magazine has given.

In the name of the many small sufferers, who will be benefited by the contribution sent, I also thank you, and through you, the readers of RECREATION, most sincerely.

Yours very respectfully,  
Duff G. Maynard, General Agent.

Several of my readers have contributed \$1 each, so that the number who have sent 10 cents each, instead of reaching into the thousands, as I had hoped, is less than 500. I am sadly disappointed at this result; yet I most earnestly thank the good people who have responded.

---

RECREATION now has a circulation of 40,000 copies a month. I want to increase this to 50,000 by the first day of November. If 10,000 of my present subscribers will each send in one additional subscription, this will put the edition up to the 50,000 mark; and it would be a simple matter for many thousands of my readers to do this. Will you be one of the number?

In fact it would be easy for many readers to pick up 4 or 5, or 10 subscriptions each. There are hundreds of thousands of sportsmen in the U. S. who do not yet read this magazine, and who would be only too glad to pay \$1 a year for it, if it were brought to their notice. There is ample opportunity for all who are kindly disposed toward the magazine, to do it material service in this way.

As soon as my circulation reaches the 50,000 limit, I shall increase my advertising rates, and this will enable me to further improve the magazine. Thus it is to the interest of every reader to aid in this good work. I shall feel deeply grateful to each and every person who will send me one or more subscriptions, with this end in view.

---

OFF FOR ALASKA.

Mr. A. J. Stone, who is in charge of RECREATION'S Alaskan Exploring and Collecting Expedition, left his home in Missoula, Mont., July 1st, en route for the field of his future labors. He will go up the Stickeen river to its head; cross the Rocky mountains to Dease lake; then proceed down the Dease river to the Mackenzie; down this to its mouth; across the Rockies again to the head of the Porcupine—which is one of the tributaries of the Yukon—down this to its mouth, and gradually work his way back to Fort Wrangle. This trip, and the work Mr. Stone will do en route, will occupy 3 years.

He is completely outfitted with everything necessary to the successful prosecution of his work, and, barring accidents, will send out and bring out a large and valuable collection of the natural history specimens of the country, and many interesting and beautiful photographs. The record of his work will be published, from time to time, in RECREATION, during the coming years.

---

With this issue is begun the publication of a symposium on the wolf question, which will prove of deep interest to all cattlemen,

farmers, and, in fact, to thousands of business men West of the Missouri river. The articles to be published during the next few months, on this subject, are being written by stockmen, business men, naturalists, hunters, and trappers, and contain a great fund of valuable information that has never before been made public. I should like to reach, with this series of articles, all the cattlemen in the West, and you will confer a personal favor on me by giving me the names and addresses of all such whom you may know, in order that I may send them sample copies.

October RECREATION will contain, among other things, "A Story of the Comanches," by Capt. C. J. Crane, U. S. A.; "On Croatan," a goose shooting story, by E. J. Myers; "Shooting Sea Lions," by E. W. Wilde; "Mistakes in Fish Distribution," by Col. W. T. Dennis; "The Salmon's Rival," by C. F. Holder; another valuable chapter of the symposium on "The Wolf Question;" several interesting articles on RECREATION'S Grizzly Bear Competition; important information from the Game Fields; on Fish and Fishing, Natural History, Bicycling, Amateur Photography, etc.

#### BUSINESS NOTICES.

The General Passenger Department of the Northern Pacific Railway has issued a beautiful little book entitled "Above the Clouds on Rainier, King of Mountains." The outing which this little book advertises affords an unusual opportunity for climbing the grandest peak in the United States. A company of choice spirits can have an outing entirely original and useful. The Mazamas, an Alpine club of Portland, Oregon, will climb this mountain in August and would be glad to have any number of good people join them. The book tells all about the trip and is beautifully illustrated. Chas. S. Fee, G. P. & T. A., St. Paul, Minn., will send you a copy for 4 cents, if you mention RECREATION.

Visitors to Lincoln park, in Chicago, will be delighted with the souvenir book of this beautiful spot now being distributed by the Chicago, Milwaukee & St. Paul Railway Company. It is a magnificent publication of 96 pages, full to overflowing with delicious half tone pictures of one of creation's most charming places of resort for citizens of the Great Republic.

No stranger visiting Chicago should be without a copy of the "Souvenir of Lincoln Park." It can only be procured by enclosing twenty-five (25) cents, in coin or postage stamps, to Geo. H. Heafford, general passenger agent, 410 Old Colony Building, Chicago, Ill. Mention RECREATION.

"The Red Man's Greeting," Pokagon's birch bark book, is having a large sale. It was written by the old chief—a full blood Pottawattamie Indian—and contains many beautiful legends of his tribe. The leaves are of various shades of crimson, white and golden colors, just as he cut them from the birch trees. The Booklet is often termed "The Indian Book of Lamentation" and Pokagon is called the "Red Bard," "The Longfellow of his race," etc.

The price of the book is 50 cts. Address C. H. Engle, Publisher, Hartford, Mich.

Here are figures showing my subscription receipts for the 3 dullest months in the year:

|           | 1895  | 1896  | 1897    |
|-----------|-------|-------|---------|
| May.....  | \$292 | \$902 | \$1,596 |
| June..... | 307   | 770   | 1,402   |
| July..... | 345   | 563   | 1,101   |

You will note the increase is 100 to 300 per cent., each year, over the corresponding month of the preceding year. Shrewd advertisers always like to be represented in periodicals that are growing rapidly.

If you have sent in a club of subscriptions to RECREATION, and have gotten your premium, and if it be satisfactory, please tell all your friends about it and advise them to do likewise.

Please send me the names and addresses of all the sportsmen of your acquaintance, in order that I may send them sample copies of RECREATION.

Take 3 shots at the grizzly bear, on page viii. of this issue, and send in your score. You will find it interesting.

The enterprising Yankee who recently flooded the market with artificial hen's eggs, which would hatch but which produced chicks without feathers, has now come out with a rubber angle worm. It is cheap, seductive, and wears for seasons. It wriggles admirably and is easily adjusted.

This man has also invested it with a little vocal organ, which emits a piercing scream of agony when the worm is put on the hook. This last addition is considered a drawing card, with anglers. The invention has turned out more useful than even the inventor expected; for these rubber worms are found a very satisfying food for canaries and other cage birds.

This inventor comes of a famous old Hartford family. It was his grandfather who invented the wooden nutmeg, and his brother who claimed to have succeeded in crossing a honey-bee with a fire-fly, and to have produced a bee that could work all night.

## BICYCLING.

### A ROAD MAP STUDY.

I spend many winter evenings in studying road maps and planning trips awheel, to be taken in summer. A critical study of the ordinary road map gives a great deal of information which aids in planning such trips; and it is information which is generally overlooked. This can be illustrated no better than by describing a day's trip, taken early in the season.

The map shows part of the day's run. The macadam roads are in double lines and the ordinary country roads in dotted lines. The map also shows the water courses, which is an important feature.

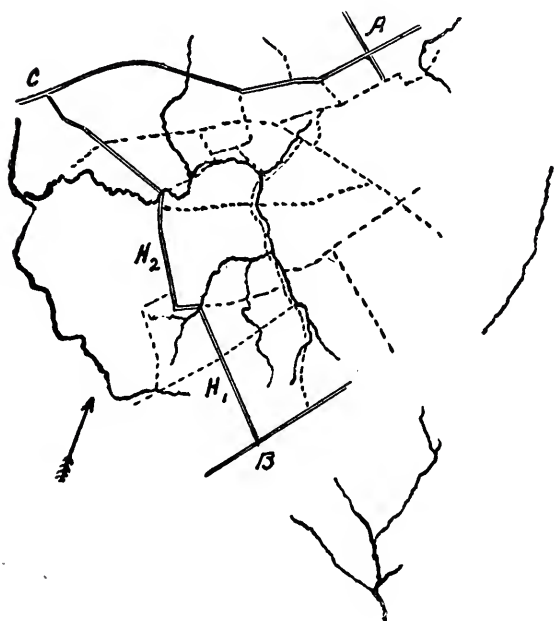

We were going from B to A and we took the macadam road to C, which is the only road used by cyclists. There was a strong wind—in fact almost a gale—blowing in the direction of the arrow. After leaving B we had a steep climb up hill H. Then before we got to C there was one more small hill to climb; but the grade was mostly in our favor, so we coasted nearly all the way. The wind at our backs made this a wonderfully exhilarating run. From C to A the grades were easy, and the road superb.

We had dinner at A, but my peace was disturbed by haunting thoughts of the return trip. The wind was still blowing hard, bringing vividly to mind the great clouds of dust we would have to face as we worked our way up the long grade, from C to B. Incidentally it may be remarked that there is no dust quite so disagreeable as the dust from a macadam road.

I took out the road map to see if there was any comfort to be derived from that. First I noticed that there was an ordinary country road, leading almost directly from A to B, which would be much shorter than the macadam by which we had come. Second the country road followed a water course, which would indicate no hill to climb. Also as the road ran up the valley the chances seemed to be that we would not be so much exposed to the force of the head wind as we would on the macadam road, which was on high, open ground.

All this seemed so convincing that I went to interview the stable man. He strongly advised against the short cut, as it was an old and little used road, and so sandy as to be almost unridable. Such information, coming from such a source, would seem conclusive; but still I was not satisfied. After we had started for home, on the macadam, I told my companion of my ideas and suggested we return by the country road, taking our chances as to results. Tow-headed girls are generally willing to take any chances that are suggested; and this one proved no exception. So we turned to the left, at the first cross road we came to, and started on our journey into the unknown.

I had memorized, by counting on my fingers, the turns in the road—left—right—left—right—left, and then to follow the brook. We had no trouble in keeping our course, and for half the way the wheeling was good. The last half of the road was so sandy as to be unridable, but my companion was a skilful enough cyclist to thoroughly enjoy the side path. As anticipated we had no hills to climb and, almost too good to be believed, we were entirely protected from the wind all the way, as the road wound up the valley through dense woods.

In planning trips awheel, from road maps, the water courses should be noted; as they give a knowledge of the topography of the country which is of great value. For level riding follow the water course. When the route leads across a water course it generally means a hill to climb.

### HUMILIATED.

The redskins ripped the welkin with their war whoop till the air

Seemed to curdle with the terror of its spell,

Then their faces blanched, and, paralyzed, they scattered everywhere—

A tourist had let out a college yell.

—Richmond Dispatch.

## THE BABY'S PLAINT.

Editor RECREATION:

Papa and mamma and all have wheels  
And you don't know how forlorn I feels,  
With Nurse left all alone.

She's good to me  
As she can be,  
But I'd like to ride  
At mamma's side,—

If only I was grown!

If only some one knew baby talk,  
The speech of babies before they walk,  
He'd find a plan, I know

So babies could be  
At their mothers' knee  
And so could sail  
In the family trail,

Wherever the rest might go.

I'm only what bruvver Bob calls a "kid,"  
A fat little thing in the bed-clothes hid,  
And as short as I can be.

But I'd like to go  
With the family so,  
That I thought I'd write to you,  
To see what you can do,

As soon as you can, for me,  
The Baby.

## SHORT GRIPS.

Many riders delay getting out on the road, these summer days, until the coolest and best part of the day is gone; instead of starting at 4 or 5 A.M., and being able to ride as comfortably as they could in October. If you ride till say, 9 A.M., on a warm day, then loiter in the shade somewhere until about 5 P.M., taking a nap after dinner, and then ride till dark, or even by lamplight, you may make long tours, in hot weather, with little or no discomfort.

Then, when you do ride, don't go mile hunting. Drift along in a way that will not take more life out of you than is necessary. By having a good wheel and a supply of good judgment, one may revel in cycle outings, even in August days, in New England, where much of the land is set up edgewise and the flow of milk and honey is not continuous.

Cycling has become so general that we naturally expect to find at every house a foot pump, or any repair material that may be needed. Thousands of passers dismount at "Brookhouse," every week, ask for the loan of a pump, and after sampling the clearest and coldest of spring water, journey on again.

A pretty cyclistine, from Jersey, says the story of a man having mistaken a mosquito for an airship, over there, is a base fabrication. She stands up, valiantly, for her native state and its good roads. You

should have seen the curl of her red lip when she refuted the slander.

If in touring you would secure the utmost pleasure and profit, do not carry a load strapped on your back a la pack peddler. Secure all you need on your wheel. This is easy with the aid of the various carriers, in the market, and you will be free from a pack horse's weariness.

Do not ride to pile up miles. Let the scorchers do that, and shorten their days, if they like. You should ride slow enough, and stop often enough, to enjoy the charms Nature ever spreads out in every land.

It is better to ride alone than to have with you one who is constantly hurrying you along; or who, on the other hand, is so slow that earth's green carpet verily grows under his tires.

Ride a good and reliable wheel, of American make, whether you tour at home or abroad, if you would avoid delay and annoyance on the road; for the constant attention and numerous repairs that are required by the average foreign wheel, not to mention the bargain counter mounts, at \$28.88, that have come to deface American highways, will sadly detract from the solid comfort you should secure on such a trip.

It is well to carry, on a long tour, a few extra small parts, chain links, nuts, bolts, etc., the weight of which would count as nothing in case of an accident which would cause them to be needed. This is important because the parts from some other make of wheel may not fit yours; and you would dislike to wait a few days for the arrival of parts.

Stamford, Ct., has a recently organized cycle club, of about 60 members, many of whom are among our solid men. "Jack" Robinson is one of the pushers in it. I am honored by being an honorary member.

Good oil and good judgment make a wheel run smoothly.

Stamson.

Bicycles are cheaper  
Than ever this year,  
But the bicycle girl  
Remains just as dear.  
—Washington Capital.

Wheeler—Whew! Isn't this day a scorcher?

Walker—It is a disagreeable, exasperating, muggy, infernally hot day, but I wouldn't call it so mean a name as that.—Indianapolis Journal.

## CAUTION TO MIDDLE-AGED BICYCLISTS.

Any form of exercise or sport which makes serious demands on the attention, on quickness of eye and hand, and on endurance, ought not to be taken up by people who have reached middle life, and who are engaged in sedentary occupations, unless with great circumspection. The lesson has been learned by Alpine climbers, through many bitter experiences. It is generally held, by them, that most of the fatal accidents in mountain climbing occur through the failure, at the critical moment, of some man who has taken to mountaineering too late in life, and who is, perhaps, also out of condition. An old dog cannot be taught new tricks, according to the proverb; and though it is disagreeable to have to realize that we have passed the age when we can excel in a new pastime, requiring special skill, to avoid accidents, and youthful adaptability and elasticity to avoid overstrain, it is the part of wisdom to accept the inevitable.

There is no reason why middle-aged men, and even those who have passed middle age, should not take to cycling; but it should be with a frank recognition of the limitations which age imposes. Great speed, long distances, and hill climbing put a strain on the constitution, and will find out the weak places, the parts of the system which are aging faster, perhaps, than the rest—the heart, it may be, or the vessels of the brain. So, also, in regard to riding a bicycle in crowded thoroughfares; the strain on the attention is considerable and the risk not small, if a man has lost the quickness of youth.—British Medical Journal.

Tommy—Pa, I want a pony.

Pa—Why, my son, I gave you your choice between a pony and a bicycle. Why is it you want a pony, now?

Tommy—'Cause I've got a bicycle.

## MY WHEEL AND I.

E. N. D.

My wheel and I have merry times  
As o'er smooth roads we fly  
Mile upon mile, without a care  
Between the earth and sky.

And should we meet a bloomer girl  
Spinning along, ah well,  
And should we flirt a little bit  
Who is there that would tell?

A case that will interest all wheelmen, and particularly those who occasionally ride on the cable slot, is that of W. F. McCarthy, a member of the L. A. W. against the Metropolitan Street Railway Company. McCarthy, through George E. Miner,

counsel for the League, brought suit against the company for \$2,000 as damages sustained while riding the slot of the Broadway line, some weeks ago. McCarthy rides a wheel with tires of the usual width, 1¼ inches, and therefore felt safe in riding the slot in Broadway.

On the day in question, while going at a fair rate of speed, he alleges the front wheel of his bicycle slipped into the slot, nearly to the hub, and stopped short. McCarthy was thrown over the handlebars with great force and sustained serious injuries about the legs and knees.

Mr. Miner contends that the section of the slot where the accident occurred must have been wider than the law allows, which is ⅝ of an inch. Wheelmen, he says, have a perfect right to ride on the cable slots, and under the law the traction companies must keep the openings within the legal limit of width.

Governor—Jimmy, you look red hot. You haven't been cycling this hot day, have you?

"No, I've been following some newspaper directions for keeping cool."—Louisville Courier-Journal.

The Park Commissioners of this city have recently promulgated some rules for the regulation of cyclists which it will be well for all to observe.

Park policemen are instructed to promptly arrest cyclists who ride faster than 8 miles an hour; who fail to show white lights 30 minutes after sunset; who coast, or ride without using the handle bars, or who dismount in the middle of the road; who fail to sound their bells when passing carriages or who ride more than 3 abreast; who indulge in trick riding or who make nuisances of themselves by carrying great gongs, instead of bells of ordinary size.

"Earth is the only one of the 4 elements that never shows unkindness to man."

"Say, you've never fallen off a wheel, have you?"—Chicago Record.

The Associated Cycling Clubs of New York are protesting against the proposed city ordinance which requires brakes on all bicycles, to be ridden in this city.

"What's new in bicycle suits?"

"Well, the scorcher continues to be about the freshest thing."—Chicago Journal.

James Quinlan, a carpenter, was recently sentenced to 9 years' imprisonment in Sing Sing, by Judge Aspinall, in the County Court in Brooklyn, for stealing 2 bicycles.

## RECREATION IS AHEAD.

Mr. F. C. Wilson is a Chicago advertiser who uses *Outing*. Mr. L. S. Abbott is the Chicago representative of *RECREATION*. He called on Mr. Wilson and advised him to also use *RECREATION*; stating, as one of the reasons why he should use it, the well known fact that *RECREATION* has a larger circulation than *Outing* has. Mr. Wilson is not well informed as to these 2 journals, and so disagreed with Mr. Abbott. A discussion followed, the outcome of which is best told in the following correspondence:

Chicago, July 3, 1897.

Mr. G. O. Shields,

Editor and Manager *RECREATION*,

Dear Sir: I called on F. C. Wilson yesterday and made a statement about our circulation which he disputed, and said he would bet \$100, if I dared to take him up, that we could not prove as large a circulation as *Outing* has. If you want to take this bet, and if you are ready to prove this circulation, you can make \$100. Do you not think it would be well to accept his challenge?

Awaiting your reply I am yours truly,  
Lynn S. Abbott.

ANSWER.

New York, July 6, 1897.

Mr. F. C. Wilson,  
Chicago, Ill.

Dear Sir: Our Mr. Abbott writes me you question my claim to having more circulation than *Outing* has, and that you offer to bet \$100 I cannot prove this claim. I accept your challenge and enclose herewith my certified check for \$100, which is to be placed in the hands of Mr. Raymond, of the J. Walter Thompson Agency, of your city, as stake holder. Please deposit with him a like amount.

The conditions of this proposition are that I, and the publisher of *Outing*, are each to make affidavits as to the number of copies of each magazine printed, for each of the months of January to July inclusive, 1897. Furthermore, each publisher is to furnish affidavits, from his printer and his binder, as to the number of copies printed and bound in each of these months. Furthermore, each publisher is to furnish an affidavit, made by an officer of the American News Co. as to the number of copies of each of these magazines bought by that company, for each of the months as above enumerated, and as to the number of copies of each magazine returned during these 7 months.

Furthermore each publisher is to furnish post-office receipts, signed by the postmaster of New York City, or one of his assistants, for postage paid in the months of May, June and July, on said magazines.

If you cover this bet, I will appoint one man, you are to appoint one and these 2 are to select a third to act as judges, and to pass upon the affidavits and proofs to be submitted; to decide whether or not such testimony is competent, and to pay over the stakes to you or to me as the judges may determine.

I submit this proposition through our Chicago office, and invite you to go with our Mr. Abbott and see that the check is properly deposited in the hands of Mr. Raymond. Yours truly,

G. O. Shields, Edr. and Mgr.

MR. WILSON WRITES HIS CHECK.

Chicago, July 14, 1897.

Mr. G. O. Shields, N. Y.

Your favor enclosing certified check for \$100, and the bet proposition, received. I compliment you on your promptness in this matter. It is exceedingly gratifying that you should be willing to put up your money on such a challenge as this.

Mr. Wilson read your letter several times, drew his check, after some little discussion about various things contained in the proposition you made, and agreed to meet me at the Thompson office this afternoon at 4 o'clock, sharp, to make his deposit.

Yours truly,  
Lynn S. Abbott.

MR. WILSON FAILS TO KEEP HIS APPOINTMENT, OR TO DEPOSIT HIS CHECK.

Chicago, July 14, 1897, 5 p. m.

Dear Mr. Shields: I have just returned from Thompson's office, where I went at 4 p. m. to meet Mr. Wilson. He was not there but telephoned me he would not put the money up unless the publishers of *Outing* would agree to show their hand. He said he had telegraphed them and they replied by referring him to Rowell's directory. I told him this was no proof, and he would have to furnish proof according to our offer. He replied that he had written them, explaining the matter, and that if they would show their hand he would bet. I have an appointment to see him again on Monday, July 19th. Yours, truly,

Lynn S. Abbott.

ANOTHER PROPOSITION.

New York, July 17, 1897.

Mr. F. C. Wilson,  
Chicago, Ill.

Dear Sir: I understand *Outing* declines to furnish proof of circulation. I, therefore, amend my proposition and will bet you \$100 that *RECREATION* has more than TWICE as much actual paid circulation as *Outing* has. Same conditions, as to proofs, are to govern in this wager as stated in my letter to you of July 8th.

My certified check will remain in the hands of Mr. Raymond for a reasonable time, awaiting your deposit of an equal amount. Yours truly,  
G. O. Shields, Edr. and Mgr.

OUTING PEREMPTORILY DECLINES TO MAKE PROOF.

Chicago, Ill., July 20, '97.

Dear Mr. Shields: I have again called at Mr. Raymond's office, where I learned that Mr. Wilson has decided not to put up his money, because Outing writes him they will not stand by him, and will not furnish proof of circulation, even on your second proposition. Mr. Raymond will therefore return your check. Yours truly,  
Lynn S. Abbott.

AND MR. RAYMOND DOES SO.

OFFICE OF

J. WALTER THOMPSON CO.

NEWSPAPER AND MAGAZINE ADVERTISING,

452 ROOKERY.

Chicago, July 20, '97.

Mr. G. O. Shields,  
19 West 24th St., New York.

My Dear Sir: Enclosed I return your certified check of \$100, which your Mr. Lynn S. Abbott deposited with me, on a bet as to Outing's circulation.

Mr. F. C. Wilson, who first proposed to make this bet, failed to put up his money.

Please acknowledge receipt of this check, and greatly oblige,

Yours very truly,  
H. M. Raymond.

FINALE.

And thus ends this remarkable incident. The publisher of Outing has recently printed a full page ad in Rowell's Newspaper Directory, and a quarter page ad in "The Fourth Estate," in both of which he claims a circulation of 83,000. Yet he declines to stand by an assertion, made by one of his advertisers, that Outing has more circulation than RECREATION has; and RECREATION claims only 40,000. Then he declines to stand by this advertiser on a proposition that RECREATION has *twice* as much circulation as Outing has; and still RECREATION claims only 40,000.

The Outing man had a chance to win \$100 on either proposition, and to *prove* his claim to this 83,000; but he declines to show up.

Why? Because he dare not.

My offer to bet \$100 on this latter proposition still holds good, and will during the remainder of this year. Any man may accept, no matter who, or where he lives.

Advertisers will draw their own inferences.

G. O. Shields,  
Edr. and Mgr. RECREATION.

GAME NOTES.

I caught one small black bear, awhile ago, and got part of a foot of a monster silver tip—the one who used to kill cattle, last summer. Now I will never get him in the same place. Those old monsters are very shy about a bait. He either twisted the most of his foot off, or ate it off. The bones of his foot were fast in the jaws of the trap, but what was on the under side of the jaws of the trap was gone, claws and all. I know he twisted some of the upper part off because he had the trap chain twisted till the trap was fast, and he hit the head of the bait and knocked it 10 or 12 feet away from the body. He had knocked and hit every thing within reach, before he wound himself up close. I have 12 feet of light log chain to each trap. Where I missed it was when I only had one bait. I should have put down both traps. Then when he was flying around he would have got another foot in.

I have had bear with a forefoot in one trap and a hind foot in another; but it was 5 miles from the ranch, where I was trapping, and of course when I went both ways it doubled the distance. The traps are 42 pound Newhouse. Ralph Anderson.

I send you an extract from a letter received from my brother, who lives on the Similikameen river, at the foot of Mt. Chopaca. He writes:

"You should come up and bring your gun. Game is very plentiful and some of it getting extremely handy. This morning, when I went into the old cabin we use as a kitchen, I was confronted by a big wild cat. When he saw me he began to scamper over tables and stoves, upsetting tinware, tearing old clothes off the wall and making fire fly from everything his claws touched. I got a revolver, and after a short battle finished the cat.

"I see mountain sheep every day, on the mountain above the house. White-tail deer are numerous in the brush, along the river. Prairie chickens by the thousand and lots of ducks. You should bring your camera too." J. B. L., Clover, Wash.

While in Maine, in the summer of '93, I visited a place called Brooklin. It is near Mt. Desert Island, and is in the midst of a game region. I saw deer, red foxes and some bears, within 10 days, and we were barely out of the village. To get there you take steamer from Boston to Rockland; from there by small steamboat to Brooklin, passing all the islands along the coast. L. M. Taylor, N. Y. City.

Please send me the names and addresses of all your friends who are sportsmen, in order that I may send them sample copies of RECREATION.

Eastman's No. 2 Eureka Camera is a simple instrument for use with glass plates. Makes pictures  $3\frac{1}{2} \times 3\frac{1}{2}$  inches, and has space in back for three double plate holders.

Fitted with fixed focus achromatic lens, which is carefully tested by our own expert. Safety shutter for time or instantaneous exposures, set of three stops, view finder and socket for tripod screw. Covered with fine leather and made with that careful attention to detail which characterizes all of the Eastman Products. Without trappy attachments or clumsy attempt at a "magazine"—no changing bag, no complicated mechanism.

|                                                                                    |   |   |   |   |        |
|------------------------------------------------------------------------------------|---|---|---|---|--------|
| Price No. 2 Eureka Camera, with one double plate holder,                           | - | - | - | - | \$4.00 |
| “ Extra Double Plate Holders, each,                                                | - | - | - | - | .75    |
| “ Eastman's Extra Rapid Dry Plates, $3\frac{1}{2} \times 3\frac{1}{2}$ , per doz., | - | - | - | - | .35    |

*For sale by all dealers. Booklet of Eureka's and Bicycle Kodaks free at agencies or by mail.*

**EASTMAN KODAK  
COMPANY,**

Rochester, N. Y.



## AMATEUR PHOTOGRAPHY.

### CHINESE PHOTOGRAPHY.

The "Chicago Record" tells this story: "On one occasion, while he was prosecuting attorney, Luther Laffin Mills came on an indictment returned against a Chinese laundryman, on the charge of having assaulted an Irish policeman, with intent to kill. Mills thought this a curious case, and on examining the prosecuting witness, and others, he threw out the indictment as being wholly absurd. The compatriots of the Chinaman were grateful, and, in pigeon English, assured Mr. Mills that they would not forget his kindness.

"Five or 6 years after this the affair was recalled to Mr. Mills' attention by 2 carriages rolling up to his house carrying a delegation of Chinamen, attired in native costumes. One, who was attired in silks, addressed Mr. Mills and recalled the affair of his persecuted countryman. 'I have just returned from China,' said he, 'and have brought with me certain articles which I crave permission to present to your family as evidences of my appreciation of your kindness to one of my countrymen when in trouble.'

"The delegation was ushered into the house, bearing numerous packages of teas, fans, silks, etc., which were distributed among the several members of the family. Before taking his departure the spokesman asked Mr. Mills to let him have a cabinet photograph he saw on the mantel. This was a picture of the Mills children, prettily grouped. Mr. Mills thought the request a strange one, but under the circumstances could hardly deny it.

"'By and by you will know why I want it,' said the Chinese gentleman.

"Recently, there arrived a parcel from Hong Kong containing an enlarged water color reproduction of the photograph, giving the details of expression and color with startling fidelity.

"'This is our present to you,' said the Chinaman.

"'But how was it possible for the artist on the other side of the globe to know what shade of color to give to the hair and eyes of these children, whom he never saw?' asked Mr. Mills.

"The Chinaman replied that the art of photography was so thoroughly understood in China that it was easy to determine, from the revelations of the magnifying glass, just what color, what shade and what tint were represented by such and such impressions as the photograph retained and exhibited. Among the many beautiful works of art in which the Mills mansion abounds there is none more exquisite than this example of Chinese skill,

and, naturally enough, with all the associations which its history involves, it is Mr. Mills' most precious possession."

---

### THE NIAGARA FALLS AS A PHOTOGRAPHIC SUBJECT.

F. H. Z.

Travel where you will North, South, East or West and you will not succeed in discovering a spot so much visited by photographers, amateurs and professionals alike, as is Niagara Falls. It is indeed the photographic Mecca of the world, for at all seasons of the year, and at times when it is utterly impossible to obtain a good negative, you may see photographers hurrying along, with cameras in their hands, eager to obtain a shot at the mighty cataract.

On arriving at Prospect Park, usually the first point visited by the average fiend, he leans over the stone wall, takes one admiring glance and, as the beauty of the scene adds to his eagerness to make the picture, he hurriedly sets up his camera, focusses, adjusts the stop and shutter, presses the bulb and imagines the deed is done.

These same tactics are repeated at all the different points of interest and, on his return home, when developing the plates, disappointment may be read all over his countenance. The hopes he had built on the fine negatives, which were to result from his day's work at Niagara, are dissipated and the reasons for his failure began to dawn on him.

To begin with, the day was not so clear and bright as it must necessarily be to get a good instantaneous negative. He made the exposures too early, or too late in the day; and good, strong high-lights are missing. He did not observe that the wind was blowing the spray, in gusts, in front of the falls; so that a clear negative was impossible. These, with many other minor points, escaped his notice and, as a result, he must try again.

The local professionals, of Niagara Falls, are among the few who have strictly first-class negatives of the falls. It is indeed a deep subject, and one must needs be posted on the time of year, the hour of the day and the kind of a day for making the exposure, on different subjects. During the early summer, about the middle of June, and after a thunder shower, when the atmosphere is clear and when there is little or no wind blowing, you are always sure to see these men, between 12 and 2 o'clock, at some of the different points. Seldom, if ever, do

they take more than one subject on any one day. Experience has taught them that this can not be done successfully; as each subject is governed by conditions that do not affect any two points alike; and it is by carefully observing these conditions that the good results are obtained.

One of these men said to me last summer, when showing me a negative he had just made of the falls: "There, isn't that a beauty? Notice all the detail and how 'wet' the water looks. I have made many exposures on the falls, but this is the first one that comes up to my idea of what a first class negative should be."

It was indeed a prize, and a rich reward for the untiring efforts he had made.

---

#### DONT'S FOR AMATEURS.

Don't tone too warm, if using a combined toning and fixing bath. Keep it at about 55 degrees, by using ice. Prints tone slower thus, but are more permanent.

Don't fail to use the extra fixing bath in connection with the combined toning bath; as it insures more permanent prints.

Don't use an old hypo bath, for plates or paper. It is bound to stain. Make fresh each time. Hypo is cheap.

Don't tone more prints at one time than you can handle and examine, frequently.

Don't try to tone several dozen 4x5s in 8 ounces combined toning solution. It won't work. Use plenty of solution and figure in this manner—viz.: 8 ounces contain about 1 grain of gold, which should tone not more than 18 4x5 prints.

Don't—if you make your own developer—use too much alkali. It makes the deoxidizing agent too energetic and clogs up the shadows too soon.

Don't forget that sulphite of soda is added to the developer to regulate the color of the negative, which would be very yellow without it.

Don't forget that hypo is the most likely cause of prints yellowing, and it should therefore be thoroughly eliminated by frequent changes of fresh water. Or, you can keep them 1½ hours in running water; keeping the prints well separated, or they will settle to the bottom of the tray and the water will flow over them.

Don't—unless you want yellow prints—wash over night.

Don't dip your hands in the hypo and then in the toning dish. The ingredients don't combine.

Don't hurry your work and expect superior results. He who makes haste slowly gets the best results, as a general rule. Everything takes time and work should not be rushed through, just to see how it looks.

G. A. C.

#### A NOVEL WASHING BATH.

A novel and, at the same time, a perfect method of washing prints, is to take an ordinary wash basin, or better still a dish pan about 14 inches in diameter; punch a hole in the side, ¼ inch from the bottom; then through the hole and bent to conform with the inside of the dish, insert a piece of tube, which has been closed up at the end, and drilled full of holes the size of a darning needle. Solder this tube on the outside, making a water tight joint. Now punch a row of holes, 1 inch from the top and ½ inch in diameter. These holes should be punched from the inside, leaving a smooth surface; the burr being on the outside. The idea is to give a circular motion to the prints. When finished fasten a piece of rubber tubing to the end of the tube passing in at the bottom, and connect with a spigot. Turn on the water and when the dish is full put in the prints to be washed. The water flows in below and out above through the holes in the side; thus avoiding the trouble of watching the dish. No prints can float out because the dish never gets full.

Don't turn on too great a stream; just enough to keep the prints in motion.

By having the dish deep enough, and by making a metal rack, plates may be placed in it and washed, thoroughly, in half an hour. The whole outfit should not cost more than 50 cents; is easily made and if painted with asphaltum, occasionally, will last a lifetime.

C.

---

Enclosed find photo taken by lamp light, according to directions given in a previous issue of RECREATION. I want to say right here that I have gotten more actual money value from RECREATION than from any other paper I ever read.

This picture was made with a pocket kodak. I used 2 lamps—one above and one below and to right of camera. Time of exposure 8 minutes.

There is one thing to be made a special note of, in this picture, one which any woman will do well to remember, when sitting for a photo. The lady kept her mouth shut for 8 consecutive minutes, and was not asleep either.

R. P. Schermerhorn.

The picture is good, considering the conditions under which it was made, but is not good enough to reproduce.—EDITOR.

---

Getting subscriptions for RECREATION is easy. The magazine does its own talking. Turn to the premium list, on page xlvi., and see what you can get by sending in a club.

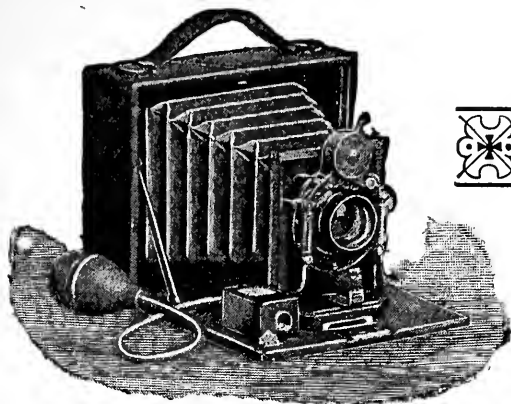

**P**REMIOS  
PRODUCE  
PERFECT  
PICTURES

# Premo Cameras

Have achieved an enviable reputation the world over. Their PERFECT construction and ease of manipulation, combined with grace, beauty, and superb finish, have placed them in the front rank, and they are to-day the Favorite Camera with the foremost Amateur and Professional Photographers.

MADE IN

**20**

DIFFERENT STYLES  
AND SIZES

Special Designs for the Sportsman and Tourist

CATALOGUE MAILED FREE

Rochester Optical Co., Rochester, N. Y.

## PUBLISHER'S DEPARTMENT.

### TO REPRINT VOLUMES I AND II.

For the past 2 years, I have been having frequent calls for the early numbers of RECREATION, nearly all of which went out of print within a few months of the dates of issue. In order to supply this demand, I have decided to reprint Vols. I. and II.—October '94 to June '95 inclusive—in book form. This will include 9 issues of the magazine, in which were published some of the best articles that have ever appeared in any sportsman's periodical. Here are the titles of a few of them:

How the Trout Came to California (illustrated), Dr. David Starr Jordan, President Stanford University, Author of "Science Sketches," "Manual of the Vertebrate Animals," "Synopsis of Fishes of North America," etc.; Ethelinda (poem), Stanley Waterloo; A Winter with the Cheyennes (illustrated), Capt. H. H. Bellas, U. S. A.; Elk Hunting in the Shoshones (illustrated), W. A. Valentine, M.D., Surgeon 7th Regiment, N. Y. N. G.; A Race for Life, Capt. Henry Romeyn, U. S. A.; Wild Turkey Shooting by Moonlight, Capt. C. J. Crane, U. S. A.; Summer—An Aquarium Story—(illustrated), Mark Samuel, Author of "The Aquarium Guide"; Alaska (illustrated), Gen. John Gibbon, U. S. A.; A Paper Chase in the West Indies, Mrs. Julian Hawthorne; Winter in the Kettle River Country (illustrated), Charles Greenwood; Blue Grouse Shooting in Idaho, M. W. Miner; Photographing Big Game (illustrated), A. G. Wallihan; Coon-Tail's Mishap, Capt. H. Romeyn, U. S. A.; The Mink (illustrated), Stanley Waterloo; Autumn Days (poem, illustrated), Dr. W. H. Drummond; Taps (illustrated), Mary Gordon Bailey; Winter in the Kettle River Country (illustrated), Charles Greenwood; Black Bass Fishing in Indiana (illustrated), Col. W. T. Dennis; A Perilous Sleigh-ride (illustrated), Capt. D. Robinson, U. S. A.; Moose Hunting in Canada (illustrated), L. C. Ivory; A Buffalo Drive, Gen. F. W. Benteen, U. S. A.; Canvasback Shooting on Puget Sound, J. C. Natrass; Troutling on the Nepigon (illustrated), John Bowman; A Coon Hunt in Ye Olden Time, Judge Hinman; Wing Shots at Sea, C. F. Holder; Goose Shooting on Lake Champlain (illustrated), Frank S. Ballard; Saurian Shooters, J. Mortimer Murphy; A Story of the Modoc War, Lieut. C. B. Hardin, U. S. A.; The Giant Wolf of Bonaplace, President Bates; A Woman's First Mallard, Katharine M. Baxter; A Cycling Romance, Miss C. H. Thayer; Troutling in Alaska (illustrated), Maj. John Brooke, U. S. A.; A Bear in Camp (illustrated), Prof. F. V. Yeager; The Vulnerable Spot (illustrated), J. N. Hall, M.D.; A Frontier

Funeral, Howard Eaton; Two Red-Letter Days (illustrated), H. C. Wilcox; Hunting Jack Rabbits Awheel, J. H. Jones; My Fiancée (poem), C. E. Nettleton; The Kettle River Wilderness (illustrated), Prof. L. L. Dyche, author of "Camp Fires of a Naturalist"; Big Foot Wallace (illustrated), Hon. B. B. Brooks; The House Warming (illustrated), Zelle Emmons; The Pointer, Past and Present (illustrated), Hon. John S. Wise; A Night on the Seneca (illustrated), Capt. H. P. Bigelow; Mystery (illustrated), Hamilton Vreeland, M.D.; Crossing the Rockies in '61 (illustrated), Maj. W. H. Schieffelin; Our National Bird (illustrated), Arthur F. Rice; Three Thousand Elk, Nelson Yarnall; Mallard Shooting in the Rockies, G. M. Dillard.

This will be a very expensive book to print, and in order to justify the outlay I must have at least 400 advance orders. I shall probably not print more than 1,000 copies, and if you want one it will be necessary to remit in advance.

This means RECREATION from the initial number to June '95. Do you want it? If so send me \$2.50 at once. I have now in stock bound volumes, July '95 to this date, and the reprinting of these first 9 issues will enable any reader to complete his files.

### FISHING ON THE SUSQUEHANNA.

The Passenger Department of the Lehigh Valley Railroad has issued a pamphlet giving location of points on the Susquehanna river, in Pennsylvania, where good fishing may be had; also among the lakes of Western New York State. This booklet contains information of considerable value to lovers of piscatorial sport.

Anyone can get a copy of the book by sending a 2 cent stamp to Chas. S. Lee, General Passenger Agent, Philadelphia.

Summer tourists en route to Watch Hill, Block Island and all Long Island Sound Shore Resorts, also the White Mountains and points in Maine, will find the Norwich Line, from New York City, a delightful route. Steamers leave Pier 40, North river, 6 p. m., every weekday, connecting at New London, the following morning, with steamers for Watch Hill and Block Island and with trains for the North and East.

The service on the steamers is excellent, and tourists taking this route break the long rail journey, which is otherwise necessary, and are able to obtain a good night's rest on the splendid steamers of the line.

For time tables and full information address W. R. Babcock, G. P. A., Boston, Mass.

The Adams & Westlake Co., Chicago, have a national reputation for their lamps. It is claimed they are the best authority on the various kinds of lanterns used, and they have fully lived up to their reputation, in the production of their X ray bicycle lamp. This lamp is built of aluminum, which makes it exceedingly light and admits of

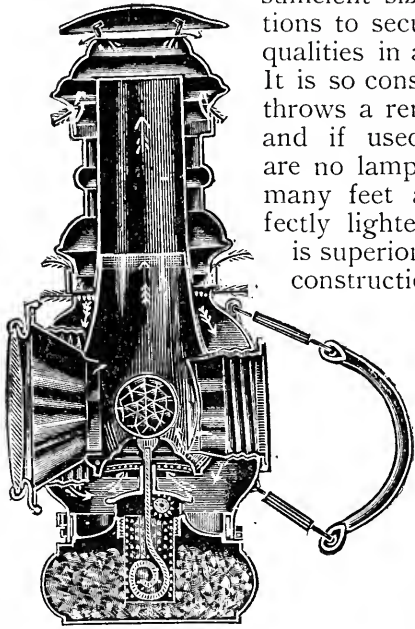

sufficient size and proportions to secure the desired qualities in a bicycle lamp. It is so constructed that it throws a remarkable light, and if used where there are no lamps the road, for many feet ahead, is perfectly lighted. The draft is superior, owing to the construction of the chimney, and for ordinary riding the lamp will not jar out.

Every attention has been given to avoid all the objections known to the average lamp, and as a result the

Adams & Westlake people have produced a very satisfactory article.

Should any reader wish to know more about this lamp, a postal card addressed to 110 Ontario Street, Chicago, and mentioning RECREATION, will secure the desired information.

#### TRAVELING IN PRIVATE CARS.

Traveling in a private car is a luxury that may now be enjoyed by any one. Any person desiring to rent a private car, for any special trip this season to the Pacific Coast, or any of the Eastern or Northern resorts, can do so by applying to any agent of the C., H. & D. railway, or by letter to the undersigned. These cars are fitted with every convenience, drawing rooms, sleeping rooms, dining rooms, and carry a full crew of waiters and cooks. Where a party of 10 or more get together, the arrangement is as economical as first-class hotel accommodations.

Parties desiring to go to Chicago via the C., H. & D., can enjoy all the convenience of a private car by simply paying for their railway ticket, at the usual rate, and \$2.00 a berth for sleeping car. The compartment sleeping cars on the C., H. & D. are arranged in separate rooms, each room containing 2 beds, a wash stand, drinking water and every appliance for the toilet. If desired, one, 2, or even 5 of these rooms

can be opened into each other en-suite, but secluded from the rest of the car. The luxury of these cars can only be appreciated by personal experience. D. G. Edwards, Passenger Traffic Manager, Cincinnati, Hamilton and Dayton Railway, Cincinnati, O.

The W. H. Mullins metal boat is a great invention. One of its good points is that whenever the paint gets rubbed off you can wipe it dry and paint it. You don't have to wait for it to dry. You can paint it every day, if necessary. Another good feature is that it never dries up and opens at the seams. It may lie in the sun a month but will never leak a drop.

Write Mr. Mullins, at Salem, Ohio, for an illustrated circular, mentioning RECREATION.

The Fenton Metallic Manufacturing Co., Jamestown, N. Y., announces that the list price on Fenton bicycles, for 1897, will remain unchanged. They realize there is a large class of riders with whom quality counts and who demand something more than mere assertions. These look to the Fenton and know that therein they will find the quality they require. The company says, "It is too soon for us to set forth our plans or views for the season of 1898, but our friends may depend that quality and good value will be our motto, in the future as it has been in the past."

The Winchester Repeating Arms Co. has lately put on the market a new model repeating shot gun which is sure to prove popular with a large class of shooters. A circular is being sent out that gives cuts and a minute description of the arm, and of all its parts. Send for it. You will find it deeply interesting if you shoot at trap or in the field. Mention RECREATION.

The Savage Arms Co., Utica, N. Y., has issued its '97 catalogue, which contains a lot of information that will interest all rifle-men. It has cuts of all the Savage rifles—military and sporting—with prices attached, as well as valuable data about cartridges, parts, Savage rifle powder, etc. In sending for this catalogue please mention RECREATION.

Have you located your happy hunting ground for next fall? If not, I will agree to take you to moose, elk, deer, bear, plenty of mountain goats, fish and grouse galore, providing you wish my services as guide. Only 40 miles from the R. R. to the hunting grounds. Good pack outfits, tents, etc. Horses good and gentle. Terms reasonable. Best of references; 18 years' experience as guide.

Vic Smith, Anaconda, Mont.



(Taken on a Carbutt Orthochromatic Plate.)  
By ALOIS BEER, Photographer to Emperor of Austria.

## To Obtain Artistic Results

as much care must be used in the selection of the Plates or films as the Camera.

### CARBUTT'S PLATES AND FILMS

(STANDARD FOR 20 YEARS)

Give Universal Satisfaction

Also J. C. DEVELOPING TABLOIDS, put up in 3 sizes, price 25c., 40c., 75c.

If you intend competing for prizes let us assist you in winning by the aid of our Plates, Films, and Developer. For sale by all dealers. Catalogue free.

JOHN CARBUTT, <sup>WAYNE</sup>JUNCTION Philadelphia, Pa.

## The MARLBOROUGH CAMERA

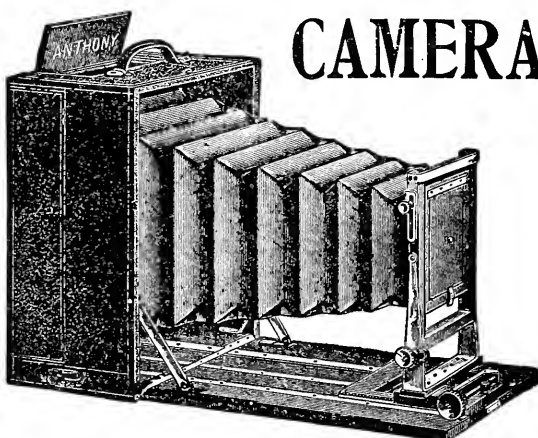

### REVERSIBLE SWING BACK RISING AND SWING FRONT

- 5x7, fitted with Rapid Rectilinear Lens, B. & L. Shutter, and two Double Holders, \$60 *Send for Free Illustrated Booklet*
- 8x10, without lens and shutter, . . . . . 50
- 6½x8½, . . . . . 45
- 5x7 . . . . . 35

Send for Free Pamphlet of \$5 and \$8 Cameras

Catalogue of all kinds of Cameras and all requisites for photography mailed on application. **Free**

We recommend to amateurs **CLIMAY DRY PLATES** They are quick and reliable

The INTERNATIONAL ANNUAL, Vol. IX., 100 illustrations, 80 practical articles on photography, now ready. Price, 75 cents; postage, 15 cents.

**E. & H. T. ANTHONY & CO.**  
591 Broadway, New York

If you are in need of  
**A Camera that will produce a Perfect Picture,**

obtain

## The HAWK-EYE, Jr.

which will be found

**a faithful friend at all times.**

The simplicity of its working parts enables the novice to obtain results that will astonish old photographers. Size, 4¾ x 4¾ x 6½ in. Photo, 3½ x 3½ in. Weight, 20 oz.

**LOADS IN DAYLIGHT, USES EITHER ROLL FILM OR GLASS PLATES.**

Send for Catalogue, giving description of all kinds of Cameras and Supplies.

**PRICE, \$8.00**

**THE BLAIR CAMERA CO., 471 Tremont St., Boston, Mass.**

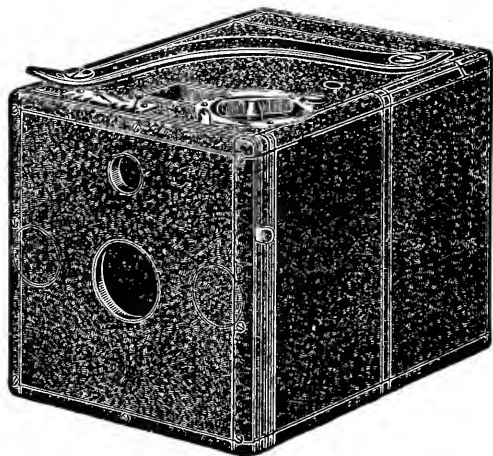

# The Baby Wizard Camera

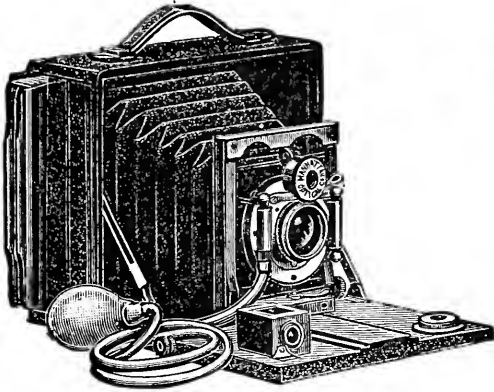

Only  $2\frac{3}{8} \times 5\frac{5}{8} \times 6\frac{3}{8}$  inches ]

*Is the  
Ideal Camera*

FOR TOURISTS, WHEELMEN  
OR SPORTSMEN GENERALLY

*Fitted with our Extra Rapid  
Rectilinear Lens (unequaled in  
this country), and the Bausch  
and Lomb Optical Company's  
Iris Diaphragm Shutter.*

Complete with Carrying Case

**\$25.00**

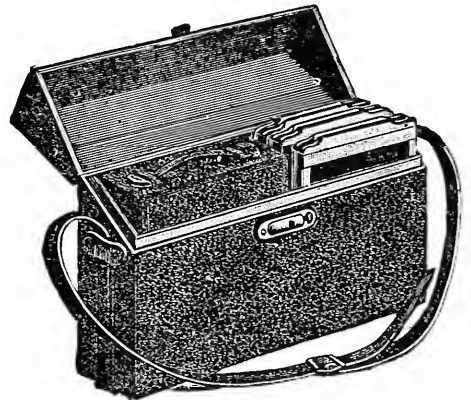

Same without rack and pinion, for focussing, and swing back

**\$20.00**

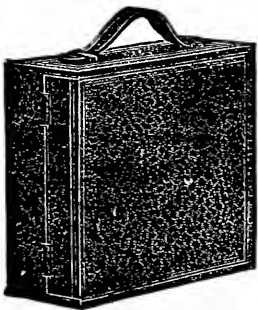

SEND FOR CATALOGUE

Manhattan Optical Co., Cresskill, N. J.

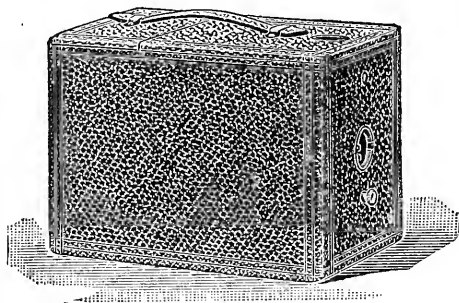

# Ray Cameras

Are now ready in **FOUR** sizes and **EIGHT** different styles

They are the simplest **Cameras** on the market to manipulate and one can learn to make photographs **quicker** with the **Ray** and at **less expense** than with any other **Camera** ever offered to the **amateur**.

**Seeing is believing.** Ask your nearest dealer in photographic supplies to show you the **Ray** and a glance will convince you.

**Remember**, there is no **Key** to be used to turn your plates into position, neither do you have to put your hand in a "Coat" **Sleeve** or other trappy appliance to get your plate in position before making an exposure.

**Every movement** that is necessary in making an exposure with the **Ray** is in full view of the operator.

**Rays** are the only **Cameras** in the **World** that use our New Patent Plate Holders which are the **lightest**, most **compact**, and **cheapest** on the **market**.

**Every Camera** is thoroughly tested before leaving the factory. **Satisfaction guaranteed.** We manufacture everything in the **amateur line**.

Send us a postal for our new catalogue just out

**MUTSCHLER, ROBERTSON & CO.**

177 West Main Street, Rochester, N. Y.

## GHOST PICTURES.

There are men who always make large bags, and who catch veritable whales, while away from home; but who, when they return from their outings have nothing to show for it.

Not so with the ghost picture. You can "see ghosts," to your heart's content, and can prove them by your camera. It is done in this way:

Take some person (a stranger is best, if you intend to see ghosts); put a sheet around him, place him in a room where the light is fair, and, having put him in a suitable attitude near the wall, make an interior exposure of about 1/2 correct time. Then cap your lens and let your man step to one side while you take a picture of the room without the ghost. The second exposure should be, like the first, 1/2 correct time.

The resulting negative will be interesting. You see your man, and yet see right through him, to the wall beyond.

Of course care must be taken that the camera is not moved between the 2 exposures.

E. C. Brown,

Fern Hill, Burlington, Vt.

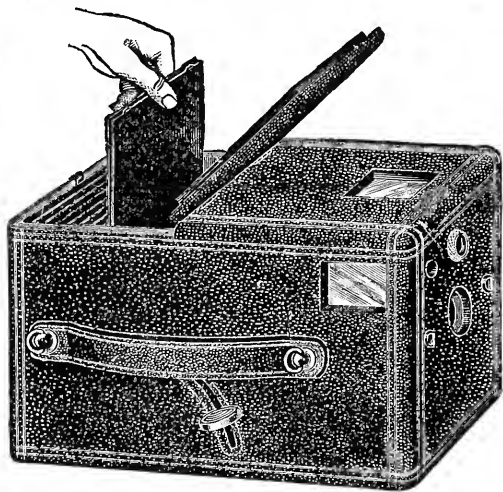

# Do you Know about The New Camera?

The first one with which Amateurs can do Professional work. Results equal the work of \$25 cameras. No failures. No mistakes, No light-struck plates. You can't help doing expert work with it.

# The Adlake Camera

COMPLETE WITH TWELVE METAL LIGHT - TIGHT PLATE HOLDERS, } \$12.00  
Prepaid to any part of the United States }

Takes 12 pictures on glass plates at one loading. Takes a standard size plate 4x5 inches and cuts a sharp, clear picture to the extreme edge. Is fitted with an expensive, extra rapid achromatic lens, specially ground.

THE Adlake Shutter has no projecting levers, nothing to break off, give out or get lost, and the diaphragm has three stops. Camera has finders for horizontal and perpendicular pictures and two tripod sockets. Handsomely covered with seal grain leather.

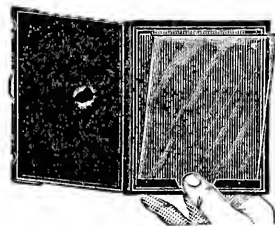

Made to open in **BROAD DAYLIGHT** For loading and adjustment. Each camera fitted with **12** single metal plate holders, light proof and dust proof. No "extras" needed. Get your plates anywhere.

Our "Adlake Camera Book" tells all about it. Free for the asking. Sample mounted photograph sets in stamps.

The Adams & Westlake Company, 122 Ontario Street, Chicago.



WHAT THE PULLMAN CAR IS  
TO THE RAILWAY TRAVELER,  
THE NEW ZEALAND MOS-  
QUITO TENT IS TO THE CAMPER

# New Zealand Mosquito Tent

"Fresh, pure air, and plenty of it, is the surest and most natural remedy for more than half the ills man is heir to."

## Our Special Affair

is to make **Tent Life** a luxury instead of the misery it has too often proved on trial.

Twenty-six years "roughing it," in all kinds of weather, from 110 degrees of heat to six feet of snow, is the experience from which the New Zealand Mosquito Tent has been evolved.

It is, in point of comfort, as far ahead of old style tents as the Pullman car is ahead of the western "Prairie Schooner," or as the modern "Atlantic Greyhound" is ahead of the old time "Columbian" sloop, or the "Mayflower."

T. W. HICKSON

23 William Street  
New York City

ASK FOR CIRCULAR  
MENTION RECREATION

INSECT  
REPTILE  
AND  
VERMIN  
PROOF



AIRY  
COSY  
LIGHT  
BRIGHT  
WATERPROOF  
DURABLE  
VENTILATION  
PERFECT  
EASILY  
SET  
UP



PATENT  
APPLIED  
FOR

'97



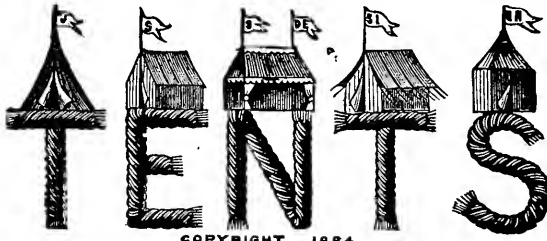

AND **CAMP  
OUTFITS**

We manufacture the largest and most complete line of tents in the country, and our goods are celebrated for their wearing and waterproof qualities.

Send 4 cents in stamps for our new 40-page illustrated catalogue showing all styles of Tents and Camp furniture.

**GEO. B. CARPENTER & CO.**

202 to 210 S. Water Street, CHICAGO

Established 1840.

**"Fenton"**  
BICYCLES

outgrade the so-called high grade. They have distinctive qualities of their own. Riders use them once and then always.

Send for Catalogue

**Fenton Metallic Mfg. Co.**  
Jamestown, N. Y.



NEW YORK AGENTS  
C. M. MOSEMAN & BRO.  
126-128 CHAMBERS ST.

**THE CYCLE LIGHT  
FOR 1897 IS**

**THE BANNER**

We did not get out our '96 lamp until late in the season, but we could not make them fast enough. Our '97 is greatly improved and will more than please its purchasers.

Throws a powerful, broad light, and illuminates ground to perfection. Extremely handsome in appearance. Your dealer should have them; until he has will send, carriage paid, for \$2.50, to any part of the United States.

Absolutely Wind Proof.  
Will Not Jolt Out.  
No Solder to Melt.  
All Parts Removable.  
Fills on Outside Oil Fount.  
Solid Brass, Heavily Nickered.  
Easy to Take Apart.  
Easy to Put Together.  
A Perfect Road Illuminant.  
Has a Positive Wick Lock.

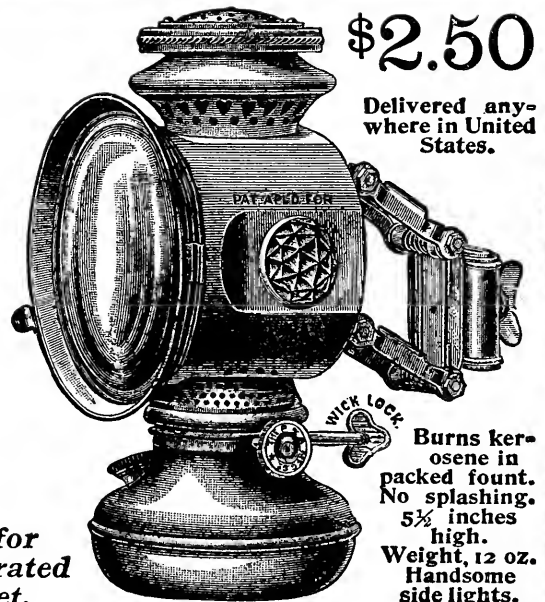

Send for Illustrated Booklet.

**PLUME & ATWOOD MANUFACTURING CO.**

NEW YORK.

BOSTON.

CHICAGO.

Factories: Waterbury and Thomaston, Conn.

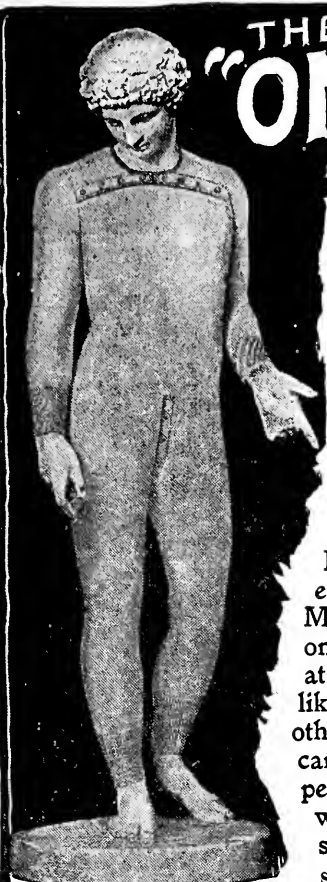

**THE "ONEITA"**  
PAT. APL 257<sup>th</sup> 1893.

**Elastic Ribbed Union Suits**

are complete undergarments, covering the entire body like an additional skin. Perfectly elastic, fitting like a glove, but softly and without pressure. No buttons down the front. Made for Men, Women, and Young People. Most convenient to put on or off, being entered at top and drawn on like trousers. With no other kind of underwear can ladies obtain such perfect fit, for dresses, or wear comfortably so small a corset.

Send for illustrated booklet

**ONEITA KNITTING MILLS** Office: 1 Greene St. New York

## Hose and —

I want every reader of RECREATION to buy something from me. I am offering some things very low as an inducement. This month I have the following to offer:—

A black or tan sock, imported, 60 gauge, retail price anywhere, **35 cents**. My price, **25 cents**, six pairs, **\$1.35**.

For duck hunters and fishermen, long wool hose; comes over the knee; very heavy; 2x2 rib black, **\$1.00**, similar goods, not so heavy, blue, **50 cents**. Can't do better on these.

For ladies: lisle hose, black, three pairs in a box, **\$1.00**. Good cotton hose, black or tan, **25 cents** a pair, imported Hermsdorf black.

Ladies' cotton fleeced underwear for fall, a beauty in silver gray, **70 cents** a suit, good value at **\$1.00**; three suits, **\$2.00**. Same in Egyptian, **90 cents** a suit, three suits, **\$2.50**; vests alone, half price; sizes 3, 4 and 5.

I sell sweaters too. Have a beauty, hand-knit, honeycomb stitch, best lustre worsted; maroon, navy, white, olive green or black, **\$3.50**, leggings to match, **\$1.50**; good sweaters at **\$2.00** and **\$2.50**. I guarantee all goods to give perfect satisfaction and pay express charges to any address.

**GEO. F. WEBBER, Detroit, Mich.**

## FISH NOTES.

One of the finest specimens of the Tycce salmon ever caught in the vicinity of Tacoma, by hook and line, was landed near Point Defiance recently by R. P. Hughes. The big fellow weighed  $38\frac{1}{2}$  pounds, was 3 feet  $1\frac{3}{4}$  inches from tip to tip and  $28\frac{1}{4}$  inches about the girth.

The fish was landed with line, attached to rod and reel. The lucky angler was one hour in landing the salmon. He thought at first he had hooked a seal, and it was 10 minutes before the fish appeared at the surface. He leaped into the air and made a gamey resistance against capture. Two lines were tied together, with which to play the fish.

M. S. Hill, Tacoma, Wash.

A subscriber asks the names of the different bass flies, and the time of year when they should be used. An expert answers:

"For fly casting, for bass, the best time is the early part of June, although some anglers have good success in early July. Flies for casting are dressed on No. 2 and No. 4 hooks, and the best known varieties are Royal Coachman, Scarlet Ibis, Professor, Montreal, Red Hackle, Reuben Wood, Governor Alvord, Lake George, Silver Doctor, and Seth Green.

"July and August are the best months for trolling. Flies for trolling are dressed on No. 1 and 1-0 hooks."

O. C. Baker, Noblesville, Ind., requests information as to the best bait for sturgeon, in July and August. The U. S. Fish Commission replies that it has no information that can apply to these 2 particular months, in the region mentioned. Crayfish, otherwise known as "crabs" among the fishermen, are found in the stomachs of sturgeon taken during the summer months.

These "crabs" are often used by fishermen, on their set lines, and sturgeon are secured with this bait when all other kinds of bait fail to attract them. Fresh water snails and mussels might also be tried.

Would like to ask through RECREATION, what flies are best for brook trout in the streams of this State.

J. B. H., Glens Falls, N. Y.

Will some reader please answer?

EDITOR.

A telegram from Three Lakes, Wis., dated June 7th, says J. S. Vilas, A. C. Boscard, and W. C. Drake, all of Kaukauna, Wis., fished at Three Lakes, on the 6th, and caught 105 black bass and pickerel.

Thomas Richards, of the Fleming house, prides himself on having made the largest trout catch of the season. One day last week he caught 10 pounds between 9 A.M. and 3 P.M.

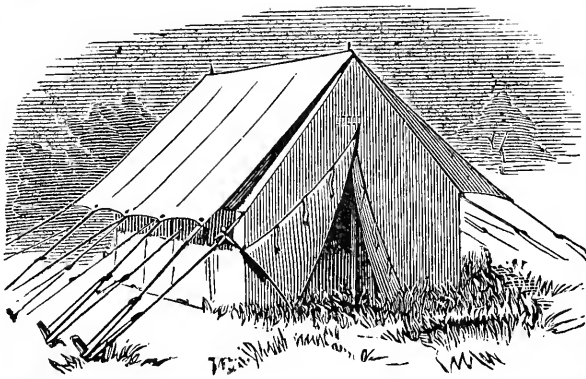

Every  
Sportsman  
Should  
Have a

# WATER-PROOF TENT

A camper knows the advantages of a tent that is an absolute protection against rain and dampness. We secure this advantage by **OUR** water-proof **PROCESS** and avoid the extra bulk and weight of a fly.

We make tents of all sizes, shapes and materials, suited to the needs of hunters, campers, travellers, canoeists; also

## Water-Proof Sleeping Bags

**CANVAS BUCKETS, AMMUNITION, PROVISION,  
CLOTHING AND SADDLE BAGS, POUCHES,  
PACKS, BICYCLE COVERS, FLOOR CLOTHS,  
and many other Canvas Specialties**

**Our Sleeping Bag** is unique, excellent in pattern and finish, and has been highly approved.

SEND FOR CIRCULAR R, SAMPLES OF MATERIALS AND PRICE-LIST TO

# DERBY, ABERCROMBIE & CO.

36 South Street, New York

The Only Practical  
**Camping Bag**

IS THE . . .

# Kenwood



Enthusiastically endorsed by campers everywhere—not an experiment. Now made with improvements suggested by usage under all conditions—as, for instance, the outside waterproof canvas cover, the middle bag and the soft, warm, light inner bag—to be used separately or combined, thus giving perfect protection from cold, rain or sudden climatic changes. Strong, durable and useful, as a hold all.

A perfect  
 shelter.  
 Tents  
 unnecessary.



No stiffened muscles. No uncovering.  
 The Prices

**\$6.00 to \$16.00**

are a revelation to buyers of the old, heavy and unsatisfactory square blankets.



## The Kenwood Hunting Cape

meets every requirement of the sportsman "waiting for a shot," whether at a deer, ducks or pigeons. Better than coats. Carefully made to combine all desirable features. Excellent as a Driving Cape.

Price

**\$15.00**

## The Kenwood Storm Hood

for use with the Bags, or for anyone exposed to severe weather, will be found very serviceable and a comfort in cold or windy weather.

*Every Camper, Hunter, Angler, Prospector or Military Man should send for our FREE illustrated circular, about these goods and camping information*

**THE KENWOOD MILLS, Albany, N. Y.**

(N. Y., 3318. Ed. 3—25,000.)

# MEMORANDUM OF WEIGHT.

DATE OF MAILING.

| DAY.         | A. M.     | P. M.        |
|--------------|-----------|--------------|
| <i>Apr 2</i> |           | <i>5 30</i>  |
|              | <i>to</i> |              |
| <i>" 30</i>  |           | <i>10 25</i> |

ORIGINAL.

New York Post Office,  
*5-4<sup>th</sup>* 189*7*

Received from

*Recreation*

IN WEIGHT, AS FOLLOWS:

|                               | TARE. | GROSS WEIGHT.   |
|-------------------------------|-------|-----------------|
| <i>247</i> No. 1 Sack, 3 lbs. |       | <i>13554</i>    |
| No. 2 Sack, 2 lbs. 5 oz.      |       | <i>732</i>      |
| Net weight,                   |       | <i>12822</i>    |
| Rate per pound,               |       | <i>.01</i>      |
| Amount of postage,            |       | <i>\$128.22</i> |

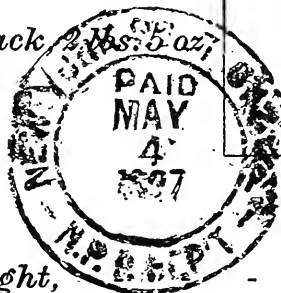

Per *A. M. Lamb* Receiving Clerk. Postmaster.

NOTE.—It is important that this receipt be compared with its duplicate, signed by the Postmaster, and issued at the close of each month.

Post-office receipt for May number of RECREATION. Other receipts cheerfully shown on application.

A copy of RECREATION weighs 1/2 lb. and the postage is 1 cent a pound. This means a subscription list of 25,600 copies a month. Figure it and see. Then call for further proof.

Address RECREATION, 19 West 24th Street, New York

(N. Y., 3316. Ed. 5—25,000.)

MEMORANDUM OF WEIGHT.

DATE OF MAILING.

| DAY.   | A. M. | P. M. |
|--------|-------|-------|
| May 25 |       |       |
| to     |       |       |
| June 2 |       |       |

New York Post Office,

6-2-1897

Received from

*Recreation*

IN WEIGHT, AS FOLLOWS:

|                          | TARE. | GROSS WEIGHT. |
|--------------------------|-------|---------------|
| 185 No. 1 Sack, 3 lbs.   |       | 16718         |
| No. 2 Sack, 2 lbs. 5 oz. |       | 555           |
| Net Weight, - -          |       | 16163         |
|                          |       | .01           |
| Rate per pound, - -      |       |               |
| Amount of postage, -     |       | \$161.63      |

Per *AML* Postmaster.  
 Receiving Clerk.

2-1-96

Post-office receipt for June number of RECREATION. The postmaster does not stuff the returns for any publisher.

This is for subscriptions only. The News Co.'s trade of 11,000 a month is not included. Total circulation, 40,000 a month.

If interested call for further proof.

Address RECREATION, 19 West 24th Street, New York

(N. Y., 3316. Ed. 5—25,000.)

# MEMORANDUM OF WEIGHT.

DATE OF MAILING.

| DAY.   | A. M. | P. M. |
|--------|-------|-------|
| June 2 |       | 9-    |
|        |       |       |
| July 2 | 1115  |       |

New York Post Office,  
 7-7-1897  
 Received from.

*Recreation*

IN WEIGHT, AS FOLLOWS:

|                          | TARE. | GROSS WEIGHT. |
|--------------------------|-------|---------------|
| 140 No. 1 Sack, 3 lbs.   |       | 13125         |
| No. 2 Sack, 2 lbs. 5 oz. |       |               |
|                          |       | 420           |
| Net Weight, - - -        |       | 12705         |
| Rate per pound, - - -    |       | .01           |
| Amount of postage, - - - |       | \$127.05      |

C. VAN COTT, P. M.

Per *AW Laub* Postmaster.  
 Receiving Clerk

2-1-96

Here is a third, receipt, and all these 3 are for the 3 dullest months in the year



**To Sportsmen and Tourists:** I am located in Northwestern Colorado, in a paradise for sportsmen. Large game abundant and trout fishing unexcelled. Gentle saddle horses, pack outfits, etc. Everything first class. Correspondence solicited.

J. M. Campbell, Hunter and Guide,  
Buford, Colorado.

**The Hermitage:** Is on the bank of Henry's Lake, at the foot of the Grand Tetons. Fine trout fishing in the lake and adjacent streams. Elk, moose, deer, bear, mountain sheep, goats, and antelope are found in the neighboring hills. Superb scenery, fine climate, good, comfortable boats, and plenty of substantial food, well cooked. What more could a sportsman want? Address

BURTON HARRIS, Jackson, Wyo.

**Information Wanted:** I desire to spend 2 weeks, in September, baybird shooting and striped bass fishing, and will be greatly obliged to any reader of RECREATION who can recommend a good place for that combination of sport, anywhere from Montauk Point to Nova Scotia. Address

J., P. O. Box 1798, N. Y. City.

**For Sale:** Wild celery seed. Will receive orders till September 15th.

J. K. Terrell, Oshkosh, Wis.

**Jas. L. McLaughlin:**—Experienced Guide. Best references furnished. Elk, moose, deer, mountain sheep, antelope, lions, bear, sage hens and grouse. Best trout fishing in the country, within 10 minutes' walk of my ranch. Would take a few boarders. Tourist outfits furnished on short notice. Address,

Ishawood, Big Horn Co., Wyoming.

### ANY PARTY

wanting to see the National Park, or to hunt in the Teton or Jackson's Hole countries, should write me.

These are the best big game ranges in the United States. Moose, elk, deer, bear, mountain sheep, mountain lions, and all kinds of small game abundant; also the best of trout fishing in the West.

Have put in 16 years hunting, trapping, and guiding in Wyoming, Idaho, and Montana, and know where to go for any kind of game you want. Write me and I will give you full particulars.

GEORGE WINEGAR, St. Anthony, Fremont Co., Idaho

**Wanted:** To Exchange, an Eastman Pocket Kodak, with leather carrying case, complete printing outfit, and 1½ dozen dry plates, for a 22 Marlin Repeater, or a Field Glass, with leather case and shoulder strap.

Dr. W. C. Duncan, Clay City, Ind.

**For Sale:** Two red cedar row boats, each 15 feet long and 36 inches wide; made of 1 inch strips, nailed every 2 inches and sewed with copper wire. Weight about 70 pounds each. Address

Wm. Dicer, Albion, Mich.

**Eggs and Curiosities:** All boys or men, interested in Eggs and Curiosities, having either to sell or exchange, should write me. I have specimens from the Copper mines to sell or exchange.

M. A. Baker, Hancock, Mich.

## KAREZZA ETHICS OF MARRIAGE,

A bold, brave book teaching ideal marriage, rights of the unborn child, a designed and controlled maternity.

**Union Signal:** Thousands of women have blessed Dr. Stockham for Tokology, thousands of men and women will bless her for Karezza.

**Arena:** Karezza is worth its weight in gold.

Sample pages free. **Agents Wanted.** Prepaid \$1.00.

**ALICE B. STOCKHAM & CO., 277 MADISON ST., CHICAGO.**

**Information Wanted:** A competent taxidermist wants to settle in a thriving town, in the midst of a good game country. Will some brother sportsman, who knows of such an opportunity, please write me?

B. C. DeLand, Lebanon, N. H.

**Adirondack Lands FOR SALE** in Various Parts of that Region; Suitable for Grand Parks, Game Preserves, Cottage Sites. Forest Land Co., Syracuse, N. Y.



## File Your Business

papers, accurately and systematically by using the

**Globe Filing Cabinet.**

Illustrated Catalogue—free.

**The Globe Co., Cincinnati,**

Cor. Fulton & Pearl Sts., N. Y.,

111 Madison St., Chicago.

## Blair's Pills

Great English Remedy for  
**GOUT and RHEUMATISM.**

SAFE, SURE, EFFECTIVE.

Druggists, or 224 William St., New York.



Henry L. Armstrong and Henry P. Dain recently went trout fishing, in a brook not far from Peekskill, and caught 11 trout.

William Mabie.

# THE AMERICAN BOOK OF THE DOG

THE ORIGIN, DEVELOPMENT, SPECIAL CHARACTERISTICS,  
UTILITY, BREEDING, TRAINING, DISEASES, AND KENNEL  
MANAGEMENT OF ALL IMPORTANT BREEDS OF DOGS

*A Book for Dog Fanciers and Dog Owners*

EDITED BY G. O. SHIELDS ("COQUINA")

AUTHOR OF "CRUISINGS IN THE CASCADES," "RUSTLINGS IN THE ROCKIES," "HUNTING IN THE GREAT WEST," "THE BATTLE OF THE BIG HOLE," "THE BIG GAME OF NORTH AMERICA,"  
"CAMPING AND CAMP OUTFITS," ETC.

8vo, 700 Pages, 85 Illustrations. Cloth, \$5.00; Half Morocco, gilt top, \$6.50;  
Full Morocco, gilt edges, \$8.00

## CONTENTS

- |                                                                                                                                            |                                                                                                                                       |
|--------------------------------------------------------------------------------------------------------------------------------------------|---------------------------------------------------------------------------------------------------------------------------------------|
| The English Setter. Bernard Waters, Kennel Editor<br>The American Field, and author of "Modern Training, Handling, and Kennel Management." | The Yorkshire Terrier. P. H. Coombs.                                                                                                  |
| The Irish Setter. Max Wenzel, Secretary The Irish Setter Club of America, and B. F. Seitner, Vice-President The Pointer Club of America.   | The Chesapeake Bay Dog. George W. Kierstead.                                                                                          |
| The Gordon Setter. Harry Malcolm, President The American Gordon Setter Club.                                                               | The Bedlington Terrier. W. H. Russell.                                                                                                |
| The Pointer. Charles K. Westbrook, A. M.                                                                                                   | The Irish Terrier. Dr. J. S. Niven.                                                                                                   |
| The Greyhound. Col. Roger D. Williams, President The Iroquois Hunting and Riding Club.                                                     | The Bull Terrier. Frank F. Dole.                                                                                                      |
| The Deerhound. Dr. O. Van Hummell.                                                                                                         | The White English Terrier. E. F. Burns.                                                                                               |
| The Foxhound. Dr. M. G. Ellzey, Associate Editor The National Economist.                                                                   | The Airedale Terrier. F. H. F. Mercer.                                                                                                |
| The Bassethound. Lawrence Timpson.                                                                                                         | The Scottish Terrier. John H. Naylor.                                                                                                 |
| The Dachshund. William Loeffler.                                                                                                           | The Dandie Dinmont Terrier. John H. Naylor.                                                                                           |
| The Bloodhound. J. L. Winchell.                                                                                                            | The Skye Terrier. Lawrence Timpson.                                                                                                   |
| The Russian Wolfhound. William Wade.                                                                                                       | The Black and Tan Terrier. Dr. H. T. Foote.                                                                                           |
| The Beagle. H. F. Schellhass, President The American-English Beagle Club.                                                                  | The Maltese Terrier. Miss A. H. Whitney.                                                                                              |
| The Irish Water Spaniel. P. T. Madison, Secretary The Indiana Kennel Club.                                                                 | The Collie. Henry Jarrett and J. E. Dougherty.                                                                                        |
| The English Water Spaniel. William A. Bruette.                                                                                             | The Old English Sheep Dog. William Wade.                                                                                              |
| The Clumber Spaniel. F. H. F. Mercer, Kennel Editor Sports Afield.                                                                         | The Great Dane (German Dogge). Prof. J. H. H. Maenner.                                                                                |
| The Sussex Spaniel. A. Clinton Wilmerding, President The American Spaniel Club.                                                            | The St. Bernard. F. E. Lamb.                                                                                                          |
| The Field Spaniel. J. F. Kirk.                                                                                                             | The Mastiff. William Wade.                                                                                                            |
| The Cocker Spaniel. J. Otis Fellows.                                                                                                       | The Newfoundland. L. F. Whitman.                                                                                                      |
| The Fox Terrier. August Belmont, Jr., President The American Kennel Club, and The American Fox Terrier Club.                               | The Bulldog. John E. Thayer.                                                                                                          |
|                                                                                                                                            | The Dalmatian Coach Dog. Maj. T. J. Woodcock.                                                                                         |
|                                                                                                                                            | The Poodle. W. R. Furness.                                                                                                            |
|                                                                                                                                            | The Italian Greyhound. Dr. G. Irwin Royce.                                                                                            |
|                                                                                                                                            | The Pug. G. W. Fisher.                                                                                                                |
|                                                                                                                                            | The Mexican Hairless Dog. Mrs. Elroy Foote.                                                                                           |
|                                                                                                                                            | The Toy Spaniels. Miss Marion E. Bannister, Secretary The New York Pet Dog Club.                                                      |
|                                                                                                                                            | The Schipperke. E. R. Spalding.                                                                                                       |
|                                                                                                                                            | Diseases of the Dog, and their Remedies. Dr. J. Frank Perry ("Ashmont"), author of "Dogs; Their Management and Treatment in Disease." |
|                                                                                                                                            | Spaniel Training. F. H. F. Mercer.                                                                                                    |

The Hon. John S. Wise, the eminent statesman and lawyer, President of the Pointer Club of America, and one of the most distinguished sportsmen and dog fanciers in the country, says of this book:

"In selecting contributors to this work Mr. Shields has displayed rare good judgment. His list of writers embraces the names of many gentlemen who are recognized as leading authorities on the subjects of which they write. While those articles may, in some cases, be more or less tinged by the peculiar views of their authors, the book, thus drawn from many different minds, is not only very eclectic in character, but, in my judgment, much more correct and valuable, as a whole, than it could be were it the production of an individual.

"The book is exceedingly interesting. It is free, too, from the sameness of expression and treatment so often found in books of this character, written by one man. It is, moreover, a very instructive book, and of practical value, in many features, to the owners and breeders of dogs.

"A valuable feature of this book is the illustrations. Many of these are artistic and beautiful in a high degree. The portraits of several dogs of world wide reputation are shown, and those of many other typical specimens, less widely known, add to the interest and attractiveness of the work. Nearly every breed is illustrated, and of some breeds several good specimens are pictured."

This book will be mailed, post-paid, on receipt of price, by

G. O. SHIELDS, 19 West 24th Street, New York

Or given as a Premium for 7 Subscriptions to Recreation

## You Get the Profits

Of Dealers, Agents, Jobbers  
and Middlemen by buying di-  
rect from the manufacturer.

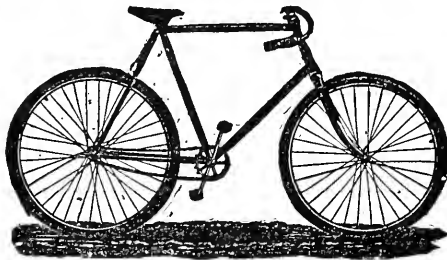

No better wheel made than the

## Acme Bicycle

Built in our own factory by  
skilled workmen, using the best  
material and the most improved  
machinery. *We have no agents*  
Sold direct from factory to the  
rider, fully warranted. Shipped  
anywhere for examination.

WRITE FOR

## Our Interesting Offer

Acme Cycle Co., Elkhart, Ind.

# Tribune Bicycles

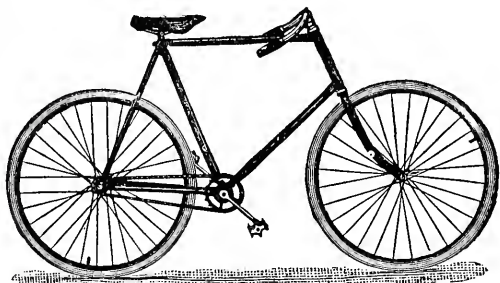

The Best in the World

Send for Catalogue

THE BLACK MFG. CO.  
ERIE, PA.

Mention RECREATION.

## Some Rare Opportunities

...YOU CAN GET...

- A \$75 Bicycle for 75 yearly subscriptions to *Recreation*.
- A \$35 Hammerless Breech-Loading Shot Gun for 35 yearly subscriptions.
- A \$40 Camera for 25 subscriptions.
- A \$20 Gold Watch for 20 subscriptions.
- A \$20 Repeating Rifle for 20 subscriptions.
- A Good Single Barrel Shot Gun for 15 subscriptions.
- A Single Shot Rifle, or
- A Bristol Steel Fishing Rod, or
- An Automatic Reel, or
- A Kenwood Sleeping Bag For 10 subscriptions.

WHY DON'T YOU GET THEM?

Write for premium list and sample copies of RECREATION

### 1897 High Grade Bicycles



for Men, Women, Girls & Boys. Complete line at lowest prices ever quoted.  
\$100 'Oakwood' for \$45.00  
\$85 'Arlington' " \$37.50  
\$55 " " \$25.00  
\$20 Bicycle " \$10.75

\$75 'Maywood' Simplest, Strongest Bicycle on Earth " \$32.00  
Fully guaranteed. Shipped anywhere C.O.D. with privilege to examine. No money in advance. Buy direct from manufacturers, save agents and dealers profits. Large illustrated catalogue free. Address (in full).  
CashBuyers' Union, 162W. VanBurenSt. B359Chicago

### 600 Second Hand BICYCLES

to close out. All makes, GOOD AS NEW, \$5 to \$15. NEW, HIGH GRADE '96 Models, fully guaranteed, \$16 to \$24. '97 Models \$20 to \$30. Shipped anywhere on approval. Special Clearing Sale.

EARN A BICYCLE by helping advertise us. We will give one agent in each town FREE USE of a sample wheel to introduce them.

Write at once for our Special Offer.  
D. P. MEAD & PRENTISS, CHICAGO, ILL.



#### THE NEW EXCELSIOR.

One morning at the break of day  
A languid stroller made his way,  
And at each turn he paused to say:—  
"Is't hot enough for you?"

As on he pressed with weary trot,  
A maiden cried:—"Why leave this spot?"  
"For me," he said, "it's much too hot—  
"Is't hot enough for you?"

"Oh, stay," the old man said, "and quaff  
A glass or two of 'alf an' 'alf.  
The youth replied with bitter laugh:  
"Is't hot enough for you?"

At eventide they found the wight  
Prone on the highway, cold and tight,  
He lay and snored the question trite:  
"Iz zotty 'nuff f'r yoo-o-o?"  
—Cleveland Plain Dealer.

#### IN A CIRCLE.

"Dere's no good of it anyhow!" exclaimed Meandering Mike, after a long silence.

"Of what?" inquired Plodding Pete.  
"Thinkin'. Ye think an' think, an' de first t'ing ye knows ye've got right back ter where ye started from!"

"What's agitatin' ye?"  
"Anarchists. I wus reflectin' on de way dem fellers labors for nuttin', studyin' up on explosives. It takes an anarchist ter make a good bomb. An' purty soon I worked aroun' ter de fact dat it takes a bum ter make a good anarchist, an' den I says ter myself, Wot's der use? I'm goin' ter sleep."—Washington Star.

Game in this county (Blair) was not as plentiful as usual last fall, but rabbits, pheasants, and squirrels were killed in fair numbers. Few trout have been taken this season considering the number of anglers who have been out.  
D. Duncan, Holidaysburg Pa.

# Camping and Camp Outfits

A MANUAL OF INSTRUCTION FOR YOUNG  
AND OLD SPORTSMEN.

Edited by G. O. SHIELDS ("COQUINA")

Author of "CRUISINGS IN THE CASCADES," "RUSTLINGS IN THE ROCKIES," "HUNTING IN THE GREAT WEST," "THE BATTLE OF THE BIG HOLE," "THE BIG GAME OF NORTH AMERICA," "THE AMERICAN BOOK OF THE DOG," "AMERICAN GAME FISHES," ETC.

---

12mo. 200 Pages. 30 Illustrations. Cloth, \$1.25.

---

**C**HIS book contains practical points on how to dress for Hunting, Fishing, or other Camping Trips; what to carry in the way of extra Clothing, Bedding, Provisions, Cooking Utensils, and all classes of Camp Equipage; how to select Camp Sites; how to make Camp Fires; how to build Temporary Shelters; what to do in case of Getting Lost, etc. It contains check lists of articles constituting Complete Camping Outfits; a list of the names and addresses of Guides, in various hunting and fishing countries, and much other information of value to Campers, and which has never before been given to the public.

The instructions given are based on an experience of twenty-five years in Camping, and in the study of Camp Lore, Woodcraft, etc., and it is believed that the work will prove of great value to thousands of men and boys, who have not had such favorable opportunities for study.

The book also contains a Chapter by

**DR. CHARLES GILBERT DAVIS, on CAMP HYGIENE, MEDICINE AND SURGERY**

ONE BY

**COL. J. FRY LAWRENCE, on CAMP COOKERY,**

AND ONE BY

**FRANK F. FRISBIE on THE DIAMOND HITCH, or HOW TO LOAD A PACK HORSE**

---

This book should be in the library of every Sportsman, and will be sent, post-paid, on receipt of price, by the Author,

*G. O. Shields, 19 W. 24th St., New York.*

---

*Given as a Premium for Four Subscriptions to Recreation*

## ON THE E-KON-LOCK-HATCH-EE.

JOHN BEIDLER.

Gabiella, Fla.

Editor RECREATION: Starting from what is known as the "Big Cypress Swamp," a stream finds a devious course through the Eastern part of Orange county, Florida, to the waters of the St. Johns, which it enters near Lake Harney. From its many and sharp curves the Indians gave it the title of E-kon-lock-hatch-ee, signifying crooked river. This name has been retained by the white settlers, though it is also known as the "Big creek." During autumn, winter, and spring, the stream has an average width of about 40 feet; but during the summer or rainy season, it "spreads itself" to a large extent, in some places reaching a mile in width and becoming a rapid river. It is, however, during its normal state that angling is best.

The stream, for nearly its entire length, is shaded by numerous tall trees—huge, gray, old oaks, gnarled and twisted and aspiring to heaven; some of them spreading their vast arms over the lower tribes of vegetation, and clothed with heavy draperies of innumerable parasitic plants, which creep from tree to tree or fling their long tendrils a hundred feet from the ground. Tall cypress, ash, sweet gum, cabbage palmetto and many other species of wood crowd together in a dense thicket, which completely shuts in the stream. Willows trail their branches in the clear brown water, their leaves often stirred by the movement of an unseen fin below.

Game is abundant in the jungle which borders the stream. Deer, wildcats, otters, raccoons, squirrels, and wild turkeys hide there, as do also moccasins and rattlesnakes; while in the more open country quails abound.

The channel of the stream is difficult to navigate, even with a small boat, on account of the logs and dead tree-tops often found lying across it. These, with roots and cypress knees, sometimes block the passage, which necessitates dragging the boat over or around the obstruction. The water, in many places, is deep, and large alligators are often found basking in a streak of sunshine or silently watching for food. In such places, too, the pike has its haunts, and bass, bream, and large cat-fish are there.

Pike fishing, in this stream, is excellent; but on account of many logs and roots there is not much room for fancy work. You must yank them out as soon as you can lift them. You must, however, be exceedingly careful not to put your tackle's strength against the strength of the fish until he is quite exhausted in his efforts to break free, or your tackle is sure to be broken. These pike often grow to a weight

of 4 and 5 pounds, and, as every fisherman knows; a 5 pound pike is not the easiest fish to handle.

The Florida bass are all of the large mouth variety, and, like the small mouth, are voracious feeders, and very gamey. They are abundant in this stream, and I have heard of 20 pounders being caught, although I have never taken any of over 14 pounds in weight. A 14 pounder has sufficient strength and activity to give your tackle a good test, and yourself some show of displaying your skill as an angler.

The live bait most in vogue here are small sun-fish, and shiners, about 6 inches in length. The latter is a small fish, somewhat similar to a young shad, and makes an attractive bait; but one not always obtainable. A shiner 5 or 6 inches long, and lively, will almost invariably tempt a large bass to bite.

It is an exciting moment when you hook one of those big fellows. The rod bends almost double as the terrified fish dives and plunges madly about, lashing the water furiously in his wild struggles for freedom. Often rising to the surface, he bounds many feet in the air; then back again with a powerful plunge and a rapid dart for some log or root. It is then that you must show your skill or you will lose your fish.

The average size of the bass caught, when you have good bait, is from 3 to 8 pounds, and often half a dozen may be taken from one pool not over 20 feet across. Cat-fish weighing 5 to 30 pounds will sometimes annoy you, but as they are usually too slow for the bass and pike, you will only catch them when the bass and other fish are not biting freely. Soft shell turtles also are numerous, and can be caught without much effort.

One of the great pleasures to be enjoyed, while fishing in the E-kon-lock-hatch-ee, is the scenery. It is grand, impressive, strange, tropical—now gloomy and awe-inspiring; now fairy-like and charming, and again weird and wild. The great trees are interlocked with a perfect network of vines and are loaded with great clusters of mosses. The stream being narrow, often for quite a distance, the branches of the large trees interlock across the channel, forming vast, arched avenues, paved with a floor of intensely dark water, roofed with dense, dark foliage, decorated with great fringes of Spanish moss. These covered passages are solemn and impressive at any time; but in the night, when lighted up by the blaze of a brilliant camp fire, the scene is indescribable. The inky water, the lights and shadows of the foliage, the disturbed birds as they wheel gracefully out of sight, all leave an impression never to be forgotten.

The E-kon-lock-hatch-ee is one of the best fishing streams in the State, and has

good game ranges along its banks. Ducks, wild turkeys, deer, squirrels, and quails are still plentiful, and independent of the creek we have 23 lakes well stocked with fish. Anyone wishing to spend a few months, or the winter here can find good accommodations, with Northern families, at reasonable rates, and good guides can be had by addressing me. I shall be glad to answer any questions pertaining to these matters.

## THE BULLHEAD.

DR. H. S. MILLER.

It has long been a reproach to call a person "a bullhead." Now, in defense of the bullhead, or catfish proper, I will give the result of some observations of these fish.

I was fly-fishing in a stream one bright, hot day. As I walked along the bank, eagerly peering into the water, I suddenly saw, darting from close to shore, a bullhead, of about a pound in weight. The water was not more than 4 inches deep, with a mud bottom. The fish raised a cloud of mud with tail and fins, about 3 feet in diameter and so dense that nothing could be seen through it. I remained to determine what it all meant. After waiting 15 or 20 minutes, the mud partially settled. There on the bottom, was a solid mass of little bullheads, about  $\frac{3}{8}$  of an inch long.

As I am deeply interested in all forms of nature (indeed, it is the thing that adds zest to our hunting and fishing trips), I decided to remain quietly on the bank and watch the dénouement. The sun was hot, and with my high rubber boots on, I found it very uncomfortable; but I stood without a motion, patiently waiting the return of mother bullhead.

I was repaid by seeing her come stealing, slowly and with the utmost caution, from a different direction from that in which she made her exit. She approached her little flock with every evidence of affection. She nestled among them, and in a moment was invisible, her flock all about her; a picture of happiness and contentment.

I still remained, for I was deeply interested, though scorched almost to a blister. In a few minutes a sunfish approached, carelessly threading its way through the weeds. Like a flash of light, the old lady darted out from the cloud of little folks and plunged after the sunfish, which "did not stay on the order of his going, but went at once." The mother returned to the bosom of her family, though she seemed to have both eyes free to watch for the approach of enemies.

I kept perfectly still, not desiring to embarrass the old lady. Evidently she finally considered me nothing more than a stump, and indeed I began to feel that way myself.

After a time, pater familias put in an appearance; slowly wiggling his way through the weeds until he came within about 6 feet of the little cloud. Then out with a rush, the madam went, plunging toward the old man, who, evidently knowing what was coming, stopped. As she approached and discovered who it was, I could, in imagination, hear her remarks: "Oh! it's only you, eh? I feared some fiend was after my babies." After caressing each other a moment, by rubbing noses and sides, she returned to her family.

By this time, being stiff and uncomfortable from my long pose, I started to leave. The mother fish at once became scared and rushed toward deep water. Before her return, the little fellows thought to have a frolic, and began darting around, finally getting down the stream about 6 feet. When the madam returned and found the little ones gone, she was greatly excited and rushed about in every direction. So much was she exercised that my presence or motions did not alarm her in the least. She finally found her little flock; but I did not notice that she used her slipper on any of them.

Knowing this fish better, I think it should be considered a compliment to be called a bullhead. I have closely observed black bass, and other varieties of fish watching their nests. As long as the ova are unhatched, the female only (I think) guards; but when the fish appear and begin to swim, the mother forsakes them, while the male devours them on sight.

I was deeply interested in the article, in RECREATION, describing Mr. Thompson's work with the brush, and the engravings given especially appealed to me. His life in the Canadian Northwest and the illustration of the sod roofed cabin wrapped in a blizzard, awoke sundry slumbering memories, for I spent nearly 2 years on those same Assiniboia plains, near the Qu'Appelle Valley. I am familiar with the country from Winnipeg nearly to Edmonton; also with the whole Saskatchewan river. Would I could make a long trip up there again, for it is a splendid country for one who enjoys the finest small game shooting in North America. The lover of the small bore rifle—say a Lyman sighted 25-20—would there have the grandest shooting imaginable. Every kind of aquatic bird, from a sandpiper to a swan, is found there; and ruffed grouse, prairie chickens and rabbits innumerable, besides big game in the wilder and heavily timbered sections.

Chas. Greenwood, Chelan, Wash.

Please send me the names and addresses of all the sportsmen of your acquaintance, in order that I may send them sample copies of RECREATION.



## OSTERMOOR PATENT Elastic Felt Mattress \$15

The Best \$50.00 Hair Mattress made is not its equal in cleanliness, durability or comfort. We pay all transportation charges (east of the Rocky Mountains), and sell on the distinct agreement that you may return it and get your money back (if not completely satisfactory) at the end of

### 30 DAYS' FREE TRIAL

If you are skeptical about its merits or don't need one now, send for our handsome pamphlets, "Test of Time or Cushions," mailed free for the asking. It gives full particulars.

We refer to over twenty-five thousand churches we have Cushioned with Felt Filling.

Patent Elastic Felt consists of airy, interlacing, fibrous sheets, of snowy whiteness and great elasticity, closed in the tick by hand, and never mats, loses shape or gets lumpy. It is perfectly dry, non-absorbent, and is guaranteed absolutely vermin proof. Tick may be removed for washing without trouble. Softer and purer than hair *can be*; no re-picking or re-stuffing necessary.

314 Clinton Street, Brooklyn, N. Y., Feb. 7, 1894.

DEAR SIR:—I have used your Mattresses for over twenty years, and state they are equal, and in many respects superior, to those made from the best quality of curled horse hair. Your Felt extracts heat from the body without absorbing moisture, and has therefore a special advantage in certain rheumatic instances.

Very respectfully,  
JOHN BYRNE, M. D.

3525 Lucas Ave., St. Louis, Mo., Feb. 11, 1896.

DEAR SIR:—Your Patent Elastic Felt Mattresses have been in use in my house since 1877. During this time, nineteen years, they have constantly grown in favor, remaining always the same, requiring no remaking. They make the most comfortable, the cleanest, and the most wholesome beds.

Yours truly,  
E. H. GREGORY, M. D.

*How to Order.*—State exact size mattress desired (size 6 ft. x 4 ft. 6 in. will be sent unless otherwise specified), and give address plainly. Remit by check, money order, express order, or New York draft, and mattress will be shipped same day. Not for sale at stores. *References:* Bradstreet or Dun's Commercial Agencies, or the Publisher of Recreation.

OSTERMOOR & CO., 115 Elizabeth St., New York

## Amateur Photographers

WILL FIND THAT THE

## WEST-SHORE RAILROAD

PRESENTS most delightful and varied Scenery for PHOTOGRAPHING AND SKETCHING. Its Mountains, Woodlands, Streams, Lakes, and Valleys, provide subjects for an

Infinite Variety of Pictorial Gems . . . .

THE HUDSON RIVER

THE CATSKILL MOUNTAINS

THE MOHAWK VALLEY

THE NIAGARA FALLS

All contribute to make this the most desirable route for persons of artistic temperament.

Five elegant Fast Trains with through Sleeping Cars to Kingston, Albany, Utica, Syracuse, Rochester, Niagara Falls, Toronto, Cleveland, Detroit, Chicago, and St. Louis.

**DIRECT ROUTE** to the Adirondacks, making close connections with railways, steamers, and stages for all the choice hunting and fishing grounds of that delightful region.

FOR INFORMATION, ADDRESS

H. B. JAGOE, G. E. Pass. Agt. J. WOLFE, Gen. Agt.  
363 Broadway, New York Albany, N. Y.

C. E. LAMBERT, Gen. Pass. Agent  
5 Vanderbilt Avenue, New York

THE . . .

## ADIRONDACK . . .

MOUNTAINS Called in  
Old Times

"THE GREAT NORTH WOODS."

A marvelous wilderness, abounding in beautiful lakes, rivers and brooks, filled with the greatest variety of fish.

An immense extent of primeval forest, where game of all kinds is to be found.

This wonderful region—located in Northern New York—is reached from Chicago by all lines, in connection with the New York Central; from St. Louis by all lines in connection with the New York Central; from Cincinnati by all lines in connection with the New York Central; from Montreal by the New York Central; from Boston by a through car over the Boston & Albany, in connection with the New York Central; from New York by the through car lines of the New York Central; from Buffalo and Niagara Falls by the New York Central.

A 32-page folder and map entitled "The Adirondack Mountains and How to Reach Them" sent free, post-paid, to any address, on receipt of a 1-cent stamp by George H. Daniels, General Passenger Agent, New York Central & Hudson River Railroad, Grand Central Station, New York.



# The Press Button Knife

Can be Opened Instantly with One Hand by Slightly Pressing the Button ::::

FOR

## Hunting, Fishing and Camping

Our 4-inch or 5-inch jack-knife is invaluable in emergencies when you need a strong knife quickly. Press button and blade is open for use.

- Four-inch Blade, Stag Handle. . . . . \$1.00
- Five-inch Blade, Stag Handle, . . . . . 1.25

SENT POSTPAID

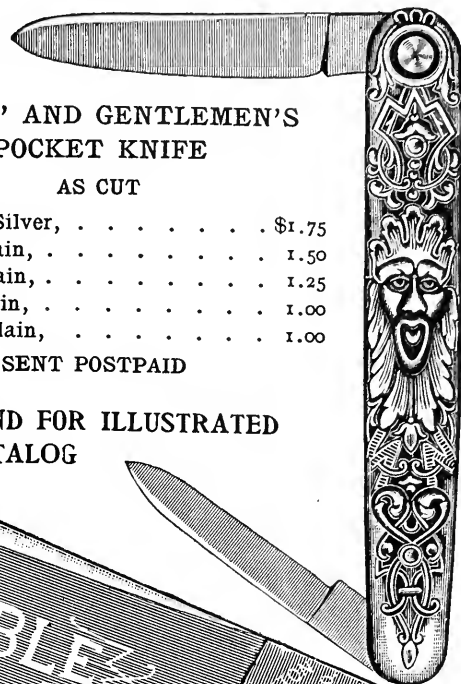

### LADIES' AND GENTLEMEN'S POCKET KNIFE

AS CUT

- In Sterling Silver, . . . . . \$1.75
- In Pearl, Plain, . . . . . 1.50
- In Ivory, Plain, . . . . . 1.25
- In Stag, Plain, . . . . . 1.00
- In Ebony, Plain, . . . . . 1.00

SENT POSTPAID

SEND FOR ILLUSTRATED CATALOG

**LOTT & SCHMITT**

112-114 Walker Street  
NEW YORK

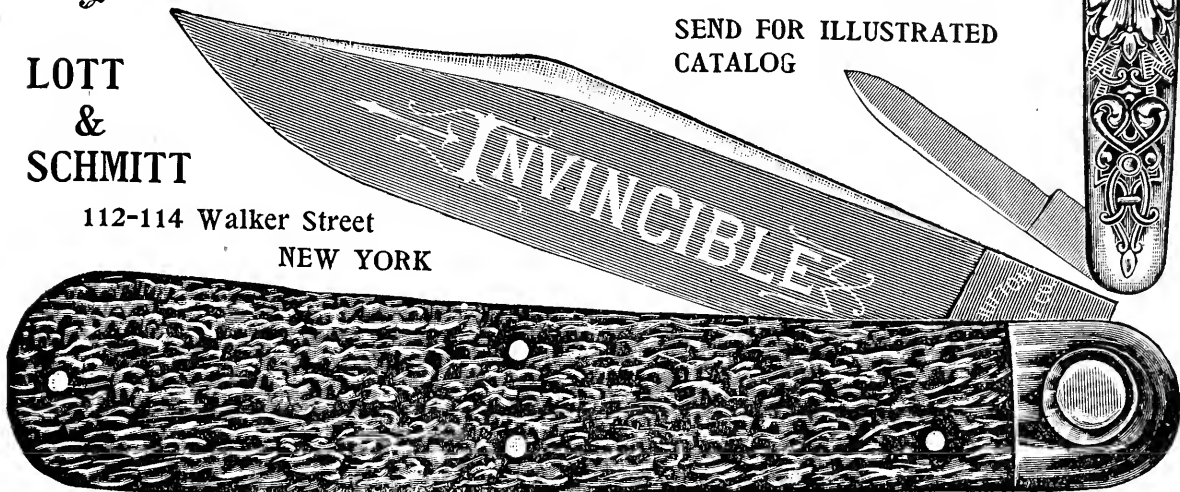

I have heard of a wholesale slaughter of elk, near Gardiner, Mont., just outside the Yellowstone National Park, in March last, and should like to know the facts. I have camped in that section, and last fall was in the Bear Tooth mountains, of Montana.

W. F. W., Providence, R. I.

See Wm. Van Buskirk's letter, in this issue. EDITOR.

I like RECREATION better than any magazine I have ever read.

In the winter we have lots of fun coursing with greyhounds. We go out about once in 2 or 3 weeks, and it is seldom a jack gets away. We also go out coyote hunting, to a place 30 miles from Denver, and if the dogs get any sort of start they generally pull down the fighting animal.

L. P. B., Denver, Col.

A Trial will Convince You that

## GOLDEN SCEPTRE

### SMOKING TOBACCO

Is Almost Perfection. We will send on receipt of 10c. a sample to any address. Prices of Golden Sceptre, 1 lb., \$1.30; ¼ lb., 40cts., postage paid.

— CATALOGUE FREE.—

**SURBRUG, 159 Fulton Street, New York City.**

## WHAT THEY SAY OF IT.

RECREATION has many warm friends here, and deserves everyone's praise. Good sportsmen's literature has been rare. RECREATION is setting the proper pace and will no doubt find many imitators. I am glad to have such a magazine at hand, to silence the old-fogy cry of horror, at the mere mention of the word "sport." It demonstrates that true manly and womanly exercise, recreation or sport, is not a hindrance to a pure heart and mind; but rather a stimulus.

Don D. Connell, Knoxville, Ia.

RECREATION is just the thing with which to remember my friends in the forest and on the plains. They will very near eat it, advertisements and all. Here are 2 of their names, and \$2, to start with.

Jesse Roberts, Chestnut Hill, Phila.

I remit \$1; please place the name of Carl Erickson, Dotsero, Eagle Co., Colo., on your list for one year. This came unsolicited, after a 5 minutes perusal of RECREATION. It recommends itself more effectively than any agent could.

L. D. Gilmore, Dotsero, Colo.

The only thing I have against your book is that I can sit down and read it, but can't take up my rifle, and go out and have some of that sport; but of course, that is not your fault.

Samuel Williams, East Akron, O.

I find RECREATION all you claim for it. It keeps the blood of a true sportsman in motion, same as the sight of a big buck, on a frosty morning.

Geo. C. Edgeter, Dayton, O.

I must again compliment you on your splendid magazine. Each number is better than the preceding one. I read it all, from cover to cover, advertisements and all.

S. M. Eaton, Watertown, Wis.

Enclosed herewith find my renewal. Could not do without RECREATION if it cost double the price. I read it from "Kiver to Kiver," quoting from Opie Reed. Success to RECREATION.

Geo. H. Reynolds, Necedah, Wis.

Your magazine keeps growing better and better. I can hardly wait for it to come. Those pictures of the game hogs and fish hogs are good.

J. F. Gardella, 3 Varnum St., Haverhill, Mass.

I have been a reader of your magazine for about 3 years, and find it very interesting and entertaining. It is brimful of good, wholesome reading matter.

P. J. Blount, Atlanta, Ga.

I have been buying RECREATION ever since the first number was issued, and believe it the best magazine published, in the sportsmen's line.

W. C. Dierks, Butte, Mont.

I like RECREATION very much. Have no trouble at all to get the sportsmen to subscribe for it.

N. Peterson, Haywards, Calif.

I am greatly pleased with RECREATION. It is the best magazine in America.

Chas. E. Starrett, 59 N. Market St., Boston.

I enjoy RECREATION so much that I would not do without it for any reasonable amount.

S. Bradbury, Germantown, Pa.

RECREATION is the best magazine published.

Harry L. Burns, Brooklyn, N. Y.

I started out on Monday morning, and by Tuesday night had 20 subscriptions.

Samuel Williams, East Akron, O.

RECREATION is truly the best thing that ever happened.

Wyatt B. Hathaway, Chicopee Falls, Mass.

It is with pleasure I send you the remaining subscriptions to complete the club of 28 I have been working for. It was a very easy matter to show the samples to a friend, and the magazine did the rest. Those who have received RECREATION think it the finest thing out.

W. P. Springer, Gouldsville, N. H.

Received April number of RECREATION, and must say it beats all in its class. I saw your exhibit at the Sportsmen's Exposition, and it was as interesting as ever. I was especially pleased with the exhibition of the mountain goats and sheep, the first I had ever seen.

L. M. Taylor, New York.

I am just recovering from a severe attack of pleuropneumonia. The first day I was able to sit up RECREATION came to hand. It was the silver lining to the dark clouds that had been lowering, or like the golden pane the setting sun does just emblaze.

D. C. Norman, Roseville, O.

I take 5 different sportsmen's publications, and RECREATION is the best, most newsy and brilliant of them all. Success to your wish for 50,000 subscribers this year. Will help all I can.

Grant W. Humes, Harrisville, N. Y.

I want to tell you how much I like RECREATION. Mr. Haney has been buying it from the news dealers, and we both like it so much we have to pull straws to see which shall read it first.

Mrs. A. A. Haney, Ft. Worth, Tex.

Your magazine is the best sportsman's book I ever read. When I get it I soon read it through, and only wish it would come daily instead of monthly.

Ezra L. Roberts, Staunton, Mass.

Having read RECREATION 18 months, I consider it the most energetic and growing sporting magazine I know of.

F. C. Merry, Pelham Manor, N. Y.

RECREATION grows better and better every month. It is the best magazine I ever saw. No sportsman should be without it.

F. Edgar Brown, Brimfield, Mass.

Your magazine is all that could be desired—and a little more. It comes like a breath of fresh air in a city office.

Eugene A. Boylan, Lockport, Ill.

I like RECREATION so well I thought I would get a few subscriptions for you, so I started out this morning and got 10.

F. C. Clark, Valley City, N. D.

RECREATION is without doubt the best publication of the kind out. It improves with every issue.

Dr. Chas. Young, Dewittville, N. Y.

RECREATION stands at the head of sportsmen's magazines. It is par excellence.

Wm. H. Rice, Boston, Mass.

I receive RECREATION regularly and enjoy it immensely, but wish it came oftener.

B. W. Rosenstine, Moline, Ill.

RECREATION leaves all other sportsmen's papers in the shade.

B. Vreeland, New York City.

Everybody in this city is pleased with RECREATION.

C. L. Amos, Syracuse, N. Y.

We consider your magazine the best one we take.

W. G. Solomon, Macon, Ga.

RECREATION is the best of its class of literature.

Dr. D. D. Cornell, Knoxville, Ia.

I cannot get along without RECREATION.

W. E. Briggs, Parkman, Me.



"We use them ourselves and RECOMMEND THEM to others."  
**DuPont Powder Co.** | **Kings Powder Co.**  
**Hazard** " " | **Walsrode** " "  
**E. C.** " " | **U.S. Smokeless P.** "

**"IDEAL" Loading Machine, \$7.**

Universal Powder Measure, \$2.50. High Grade Closer, \$2.50.

Ask your dealer for them or send cash to  
**IDEAL MANUFACT'G CO., NEW HAVEN, CONN., U. S. A.**

"Ideal Hand-Book of Useful Information to Shooters," 100 pages.  
 Send stamps for it to above address. Please mention RECREATION

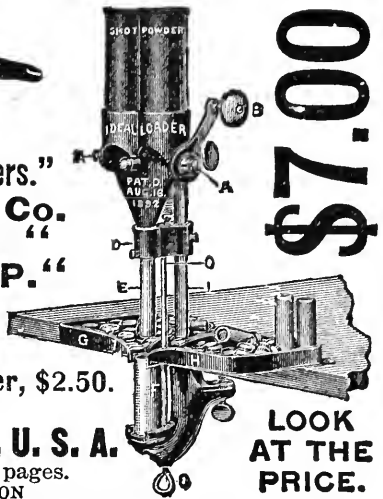

Sectional View

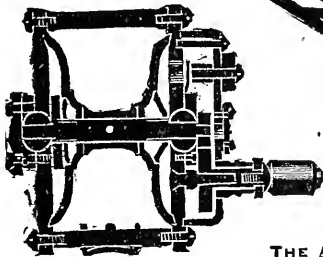

Globe Bearing.



Don't believe imitators of "**HENDRYX**" standard goods when they say their Fishing Reels "are **NOW** as good as **HENDRYX**". The fact that they imitate proves the "**HENDRYX**" is the recognized standard line of Fishing Reels. Ask your dealer for them.

THE ANDREW B. HENDRYX CO., NEW HAVEN, CONN., U. S. A.



**J. B. CROOK & CO. Established 1837**

1180 Broadway, Cor. 28th Street

Manufacturers and Importers of **NEW YORK CITY, U. S. A.**

HIGHEST GRADE **FISHING TACKLE** HIGHEST GRADE

SPECIALTIES FOR 1897

**Featherweight Rods, Aluminum Reels Trout and Salmon Flies**

The only Waterproof Fly Lines: The London Black or Trout, and Black Bass.  
 Send 7 cents for catalogue. Mention RECREATION.

**L. L. BALES**

...Wholesale and Retail Dealer in...

**FISH, FURS, AND RAW SKINS**

Full information given brother sportsmen as to good hunting, trapping, and fishing grounds in Washington, British Columbia, and Alaska.

Am well acquainted with the haunts of the elk, deer, bear, mountain sheep, mountain goat, moose, and caribou; also with the whereabouts of all fur-bearing animals in this region.

Correspondence promptly and cheerfully answered **Everett, Wash.**

**Moosehide Moccasins & Slippers**

METZ & SCHLOERB, Oshkosh, Wis.

PRICE: MEN'S - - - - \$2.75  
 LADIES' AND BOYS' 2.25

Sent, prepaid, on receipt of price.

Write for our illustrated circular and price-list of hand made hunting shoes and moccasins of every description.

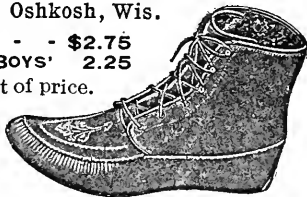

RECREATION is the best magazine I have ever read, and I hope your circulation will be greatly increased by the end of '97. You certainly deserve it.

A. B. Bauman, Chicago, Ill.

They sat in silence for some time. "Of what are you thinking?" he finally asked.

She blushed and fidgeted uneasily in her chair, for a minute.

"Never mind," she said sharply. "It's your business to propose, not mine."—Chicago Post.

I have heard that ranchers are killing elk, in Jackson's Hole, to keep them from destroying the hay. They say there are hundreds of elk there, and most of them starving to death. W. L. W., Egin, Idaho.

## WHAT THEY SAY OF IT.

I am much pleased with RECREATION, and wish it the greatest measure of success. The first copy I read caused me to become a subscriber, and therein lies its success. It is so bright, that to be seen by a member of the craft, causes a desire to possess it that is irresistible.

J. C. Smith, Kansas City, Kan.

Have been taking RECREATION 2 years. It is O. K., and in fact do not see how I could get along without it. This is not much of a game country, although we have good grouse and quail shooting, in the fall, and lots of sport fox hunting during the winter months.

M. E. Fahey, Pinckney, Mich.

RECREATION is the best magazine of its class, and all other publications can get pointers from it. Its half tone cuts are simply marvelous, for a magazine selling at the small sum of \$1 a year. It is, in my estimation, far ahead of some others that sell at \$3 a year.

Alfred M. Bailey, Lynn, Mass.

I have been on the sick list, and RECREATION was the best book I could get hold of, though we have 500 to 600 others in our library. As for myself and my subscribers, we find it the most interesting book we can get.

W. S. Mead, Woodstock, N. Y.

Herewith I enclose you a list of 8 subscribers for your valued magazine, also N. Y. Exchange for \$8. I watch and wait, impatiently each month, for the coming of RECREATION. Long may you live and prosper.

E. V. Williams, Springfield, Mo.

We thought RECREATION was good before; but the last number is far ahead. It is making great strides. Every sportsman here, who is not a subscriber, buys it at the news stand.

C. F. Waterhouse, Aitkinson, N. H.

I am more than pleased with the way in which RECREATION is pitching into law breakers and game hogs, both through its correspondents and through the editorial department. Keep it up.

H. C. Gardiner, Buffalo, N. Y.

Please continue sending me RECREATION another year, for which I enclose herewith \$1.

This reply is belated, but better late than never. I must have RECREATION, hard times or good times.

W. C. Daly, Muncie, Ind.

Like Saul of old, RECREATION stands head and shoulders above all the rest. There are others; but no one would return to the tallow dip who has once used the electric light.

C. A. Miles, Philadelphia, Pa.

I have Vols. I, II, III, IV and V bound, and shall bind Vol. VI of RECREATION. If I could not get any other RECREATIONS I would not take \$100 for those I have now.

A. H. Chandler, Cumberland Mills, Me.

Do not stop RECREATION now nor at any time. Don't think of it for a minute. I will give you notice when it is a good time to stop. Best magazine I ever read.

B. L. Smith, So. Newbury, O.

RECREATION is the best sportsmen's magazine in the world, bar none. All my subscribers say there is only one fault with it, and that is it don't come often enough.

H. H. Cook, Meriden, Conn.

Long live RECREATION, which is the best sporting magazine I ever read. Cannot praise it too highly. Always glad when it comes, and read every word in it.

Eldon Williams, Deavertown, O.

A physician's spare moments are few and far between, but a few minutes of RECREATION reading is as good as a whole day in the woods.

Dr. J. N. Storey, Hill, N. H.

Your monthly is the very finest of its class, and each succeeding month brings forth fresh novelties, which must be heartily enjoyed by all readers.

J. Forsyth, Middletown, N. Y.

RECREATION stands first in my ideal of what a sportsman's journal should be. The articles are A1 and the cuts are very fine indeed.

W. Gibson, London, Ont.

I am a constant admirer of the stories and principles of RECREATION. It is the magazine for sportsmen, and is always well loaded.

G. H. Wright, Elmira, N. Y.

It is a great pleasure to me to see RECREATION so much enlarged. I cannot get enough of it to satisfy my appetite in that line.

A. D. Andrews, D.D.S., Schaller, Ia.

RECREATION is the finest sportsmen's magazine I have ever read, it fills a long felt want, and I most heartily wish you success.

F. S. Van Keuren, St. Paul, Minn.

RECREATION is a peach, and I could not do without it. Hope you will soon reach the 50,000 mark.

Clarence D. Robinson, St. John, N. B.

RECREATION is all its name implies. It is the newsiest, brightest, and best of them all. Long may it live and prosper.

E. W. Phillips, Missoula, Mont.

I read your magazine every month, and it is the best of its kind published. I enjoy your puzzle column very much.

Edward Hamilton, Law, Mass.

All who have subscribed, here, are well pleased with your magazine, and say they never saw a better one of its class.

Geo. Kalmbach, Shreveport, Ia.

May number of RECREATION just received—an exceptionally fine one—better than ever, if that be possible.

L. D. Gilmore, Dotsero, Colo.

RECREATION is worth twice what it costs. Game is scarce around here, and so we have no game hogs.

Wm. Hecline, Moline, Ill.

RECREATION is the best of its kind, and I take several publications devoted to field sports.

Ed. W. Anderson, Pittsburg, Kan.

I have taken many sportsmen's papers, but never found one as good as RECREATION.

Dr. C. E. Mudgett, Fairfax, Vt.

Your magazine is the best in the field to-day, and I wish you continued success.

Geo. D. Hart, Chicago Lawn, Ill.

The women of my family think RECREATION is the only sportsmen's magazine.

C. E. Wilson, Bolton Landing, N. Y.

Could not do without RECREATION now, so long as I have \$1 left.

Jas. S. McCain, Washington, N. J.

RECREATION should be issued semi-monthly at \$2.50 a year.

Jacob Schwab, Pueblo, Colo.

Your magazine is the best thing of its kind I have ever yet seen.

Ralph Totten, Nashville, Tenn.

We could not think of doing without RECREATION. It grows better and better.

D. T. Tuthill, Orient Point, N. Y.

RECREATION is the best sportsmen's magazine published.

C. Fred Smith, Kennett Sq., Pa.

RECREATION cannot be beaten as a sportsman's journal.

Ralph E. Loy, Geneva, N. Y.

RECREATION is the best sportsmen's magazine in America.

S. L. N. Ellis, Visalia, Calif.

RECREATION can't be beaten.

Harry Jones, Bowie, Tex.

# The Wing

✿ ✿ STYLE 7

# Piano



You do not have to pay an extravagant price for a first-class piano



In justice to yourself write for prices of the Wing Piano before you buy



## The Instrumental Attachment

imitates perfectly the tone of the Mandolin, Guitar, Harp, Zither and Banjo, giving the effect of an entire orchestra of these instruments playing in concert with the piano

**SENT ON TRIAL** We will send this piano, or your choice of four other styles, to any part of the United States *On Trial* (all freights paid by us), allow ample time for a thorough examination and trial in the home, and, if the instrument is at all unsatisfactory, we will take it back at our own expense. No conditions are attached to this trial. We ask no advance payment; no deposit. We pay all freights in advance.

### OLD INSTRUMENTS EXCHANGED EASY PAYMENTS

OUR BOOK should be in the hands of every one who intends to buy a piano. It contains many valuable hints and instructions, and tells a great many things every buyer ought to know. We will send it free with our catalogue to any one who writes us.

**WING & SON,** 443 and 445 West 13th St., N. Y. City  
ESTABLISHED 1868

### WHAT THEY SAY OF THE PREMIUMS.

I have delayed acknowledging receipt of the Ithaca hammerless gun, which you so generously sent me, as a premium for 35 subscribers to RECREATION, until I could thoroughly test its shooting qualities. I now have to advise that it is one of the best shooting guns I ever saw. I will take my chances in the field against any of the higher priced guns, either for accurate or long range shooting, providing of course I am in company of my class. Many thanks for the gun. Everybody is pleased with RECREATION and I think I can send you many more subscriptions.

H. H. Packard, Cherokee, Ia.

The Premo Sr. camera, sent me for a club of subscribers to RECREATION, was received in good shape. All my friends pronounce it the slickest camera out.

Dr. Kutnewsky, Redfield, S. Dak.

I am much gratified with the way you answered my last letter, in which I asked for information about your book, "American Game Fishes." It is hardly necessary to say I had no sooner had a look at the book, than I saw what a good thing I had. I now call it my "Fish-Bible," a book whose precepts are to be followed for the good of one's soul. It is the best book of the kind I have ever seen. As soon as I can get time, I intend to color the plates, with water colors, and thus make the only possible addition I can think of to make it the book to swear by.

Dr. Franklin, Philadelphia, Pa.

The Bo-peep camera, made by the Manhattan Optical Co., and sent me as a premium, arrived on the 18th, and I am very much pleased with it.

J. R. Peterson, Portland, Me.

This town is being pretty well canvassed for RECREATION, judging by what I hear. Would like to get a start of the rest of the lads, if possible. Mr. M. E. Sweeney received a handsome Marlin from you yesterday, as a premium for 25 subscriptions. He is a staid old bachelor, but looked 20 years younger, with his broad smile, when he remarked "I got the gun all right, boys."

P. F. R., Marion, O.

I have received the Marlin rifle which you sent me as a premium for 21 subscribers to your fine, up-to-date magazine. The gun is a beauty, and is a much nicer one than I expected. It corresponds exactly with the description given in the catalogue.

C. R. Montgomery, South Bend, Ind.

The Premo B camera, sent me for 20 subscriptions to RECREATION, arrived in due time. I am very much pleased with it. Several friends who have seen it each expect to get one like it. You have my sincere thanks.

W. N. Johnson, Richmond, Ind.

Having been a reader of RECREATION since its first issue, I congratulate you on the success you have made of it, and greatly admire the courageous stand you have taken against the game and fish hogs.

H. E. Swezey, Chicago, Ill.

The Yawman & Erbe automatic reel you sent me, for 10 subscribers to RECREATION, received 2 weeks ago and I am more than pleased with it. It is something I have been wanting for several years, and now I get it by simply asking 14 persons to subscribe for RECREATION. The 3 or 4 who did not subscribe at once have promised to do so later. I will here say to all who want the best automatic fishing reel ever made that this is the easiest way I know of to get it. Get up a club of 10 subscribers to RECREATION, get the reel and you will always be proud of it.

B. F. Williams, Quanah, Tex.

I am just in receipt of the Bristol steel fishing rod, sent me as a premium for 10 subscribers to your valuable magazine. The rod is a beauty and I found it more pleasure than work to get the subscriptions. I will begin at once to get subscribers for the automatic reel.

P. Christianson, Spokane, Wash.

By reason of your generosity, I am the owner of a fine double barrel hammerless shot gun, received a few days ago from the Forehand Arms Co., and sent me as a premium for 35 subscriptions. Have been out with it 2 or 3 times and am perfectly satisfied with its shooting qualities. It shoots strong and makes a good pattern. It is greatly admired by all the sportsmen here, and they wonder how you can give such liberal premiums with so good a magazine as RECREATION.

F. C. Doane, Knoxville, Pa.

The Premo B camera, fitted with the lens which I desired, was received promptly, and I am delighted. It is a beautiful instrument and had I paid \$21 in cash for it, it could not have been any better. I consider myself fully paid for my trouble in securing the subscriptions, and feel under obligations to do everything in my power to help on your publication to success. You will probably receive some camping pictures, made with my camera, as my husband and I go camping every season.

Mrs. Geo. Nichols, Chicago, Ill.

# The Muskoka and Midland Lakes Resorts

Reached only by the

## Grand Trunk Railway System

Is the Paradise for not only hunters, fishermen, and canoeists, but also those in search of health, where comfort and pleasure can be obtained economically.

The woodland and lake scenery would satisfy the most critical tourist.

Camping outfits can be purchased cheaply, or guides, thoroughly acquainted with this region, fully equipped for camping, can be secured readily.

Parties can be furnished with names of guides, and by communicating with them, make all necessary arrangements in advance.

The following fish and game, in season, are to be found in abundance, the variety of which is not surpassed by any other sporting region in the world:

**Fish.**—Bass, pickerel, brook trout, lake trout, whitefish, perch, sunfish, salmon, trout, sturgeon, catfish, herring, and muskalouge.

**Game.**—Deer, partridge, rabbits, pigeons, ducks, geese, plover, bear, woodcock, snipe, grouse, and moose.

**A few of the other Principal Resorts.**—Androscoggin Lakes, the White Mountains, the salmon resorts of Quebec, New Brunswick, and Nova Scotia, Lake St. John region, the River St. Lawrence, the Thousand Islands.

For descriptive book showing routes and rates, apply to M. C. DICKSON, D.F.A., Toronto, Ont.; D. O. PEASE, D.P.A., Montreal, P.Q.; L. R. MORROW, C.P.A., Chicago, Ill.; R. MCC. SMITH, S.P.A., Cincinnati, O.

CHAS. M. HAYS, GEO. B. REEVE, W. E. DAVIS,  
General Manager, Gen. Traffic Manager, G. P. & T. A.,  
Montreal, P. Q. Montreal, P. Q. Montreal, P. Q.

FRANK P. DWYER, E. P. Agent, 273 Broadway, New York.

## ...to "the" Pleasure Resorts of... Texas and Gulf of Mexico

TAKE



Via CHICAGO, KANSAS CITY, or  
ST. LOUIS

WAGNER BUFFET SLEEPERS  
FREE "KATY" CHAIR CARS

For further information, address

W. S. ST. GEORGE, Gen. East. Agt.  
409 Broadway, New York

ON OUR LINE

IF  
YOU  
EXPECT  
EVER  
TO  
SEE

Yellow=  
stone  
Park

easily and conveniently,  
YOU MUST TAKE

The Northern Pacific

NO OTHER LINE

reaches the Park.

Season Closes October 1st

SEND SIX CENTS

for that NEW BOOK of ours, and read  
of what a glorious treat you can have.

CHAS. S. FEE, Gen. Pass. Agent  
ST. PAUL, MINN.

UNEQUALED  
ATTRACTIONS

ON THE LINE OF THE

Union Pacific

FOR TOURISTS

It traverses the Grandest Scenery of  
the Rocky Mountains, and reaches all  
the Health and Pleasure Resorts of  
the Mid-Continent.

Sportsmen

will find in scores of localities along this line game worthy of their skill, such as Bear, Mountain Lion, Coyotes, Elk, Deer, Antelope, Mountain Sheep, Feathered Game of all kinds. And everywhere are Beautiful Streams well stocked with Trout.

For Gun Club Rules, Game Laws, and any information relative to localities for Hunting, or for information in regard to the UNION PACIFIC SYSTEM, call on or address any General or Traveling Agent of this Company.

R. TENBROECK, Gen'l Eastern Agent,  
287 Broadway, New York City

E. DICKINSON, Gen'l Manager, E. L. LOMAX,  
Gen'l Pass. & Tkt. Agt.,  
Omaha, Neb.

The recent heated term and consequent dulness in business has afforded a large number of New York trout anglers an opportunity to make trips to the Eastern and Western fringes of the Adirondacks; and the North bound trains of the New York Central Railroad have been well filled, every day, with healthy looking men, in rough clothes, carrying their favorite fly rods. Those going to Essex county change at Albany, and Troy, to the Delaware and Hudson cars.

The sport has averaged good, for the New York State Fisheries Commission has been doing good work in stocking all the trout waters in the state. In this it has been generously aided by the railway companies who furnish free transportation for trout and other fish fry.

I am a constant reader of RECREATION. It fills a long felt want, and brings true happiness to the hearts of the friends of field and gun.

J. G. Patterson, Des Moines, Ia.

I read your magazine with great delight, and the man who has not, has something good before him.

Thomas F. Otley, Chicago, Ill.

## 20 BOOKS ❁ ❁

**ON 20 DIFFERENT SUBJECTS,  
BUT ALL RELATING TO SOME  
DELIGHTFUL PHASE OF  
AMERICAN TRAVEL, VIA  
"AMERICA'S GREATEST RAIL-  
ROAD."**



ILLUSTRATED CATALOGUE SENT  
FREE, POST-PAID, ON RECEIPT  
OF A 1-CENT STAMP BY GEORGE  
H. DANIELS, GENERAL PASSENGER  
AGENT, NEW YORK CENTRAL &  
HUDSON RIVER RAILROAD, GRAND  
CENTRAL STATION, NEW YORK.

## NEW MODEL REVOLVER

Has important advantages over all other makes. Rebounding Lock, which obviates all liability of accidental discharge when closing, after discharging cylinder. Simple and superior method of holding cylinder to barrel. Can be removed instantly by pressing a catch in front of the cylinder.

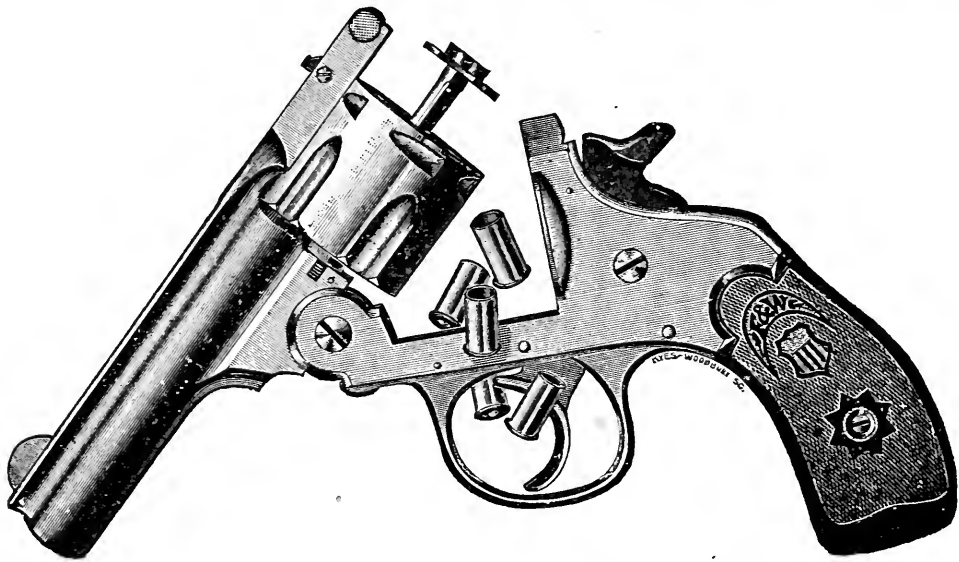

Workmanship unexcelled. All parts interchangeable, and made from drop forgings. Frame is made of cast steel. No malleable iron about it.

SEND FOR CATALOGUE  
Mention RECREATION

FOREHAND ARMS CO., Worcester, Mass.

Given as a Premium for 10 Yearly Subscriptions to Recreation



# ASHLAND HOUSE

FOURTH AVE.  
and 24th ST.

Two blocks from  
Madison Sq. Garden

...HEADQUARTERS FOR SPORTSMEN

American and  
European Plan

### RATES:

|                       |                |            |             |
|-----------------------|----------------|------------|-------------|
| Rooms, with board,    | \$2.00, \$2.50 | and \$3.00 | per day     |
| Rooms, without board, | -              | \$1.00     | and upwards |
| Breakfast,            | -              | -          | 75 cents    |
| Lunch,                | -              | -          | 50 "        |
| Table d' Hote Dinner, | -              | -          | 75 "        |

## A RARE OPPORTUNITY

A Willie Pocket Camera, Valued at \$5.00

As a premium for 5 yearly subscriptions to RECREATION. This Camera makes a picture 2½x2¾ inches, and can be loaded with 24 cut films. You can get the 5 subscriptions in one hour.

Write This Office for Camera Catalogue.

Cycle Touring in England at small expense. All about it, for 25c.

Arthur Munson, Stamford, Ct.

# HYPNOTISM TAUGHT BY MAIL.



Not Difficult. Spare Moments Sufficient.

Not a natural gift; anyone can use it. Latent powers developed and the otherwise impossible accomplished.

Ours the most reliable secrets of the art, making all susceptible to this strange influence. Induced by contact, or at a distance by mail or telegraph. Control loved ones and save them from

error. Habits, weaknesses and diseases cured. Nothing aids all classes of every age, sex and condition, in business and social life more than this knowledge. Everything private. Established twenty years. Most advanced and reliable methods. Valuable information upon request. Address, Prof. L. H. ANDERSON, R. C. 67, Masonic Temple, Chicago, Ill. U. S. A.

## Wyoming...

For Antelope, Bear, Cougar, Deer, Elk, Fish, Goat, Moose, Sheep, Grouse, Duck, and Sage Chicken Shooting,

ADDRESS H. D. DEKALB, BIG PINEY, WYO.

# RUPTURE ABSOLUTELY CURED . . . . .

without truss, operation or confinement, on strictly scientific professional principles, based on an experience of many years.

My method of treatment is known only to myself, and I object to long letters explanatory thereof. An interview is positively necessary for those requiring information.

Complete cure effected in 6 to 8 weeks; one treatment each week, with no detention whatever from business.

## SACREDO

Care F. C. PRESTON, 98 Hudson Street, New York

## Captain Jack Crawford

“ THE POET SCOUT ”

Late Chief of Scouts, United States Army  
In His Unique Frontier Medley

“ THE CAMP FIRE AND THE TRAIL ”

Irresistible Humor, Touching Pathos, Thrilling Recitals, Graphic Word Pictures of the Romantic Borderland, Exciting and Humorous Experiences beyond the Line of Civilization. “Pony Bill’s” Quaint Cowboy Sermons. Songs of the Plains and Mountains. A Wonderful Temperance Story.

TWO HOURS OF RARE ENJOYMENT

Persons or societies who may engage him will not be disappointed. He refers, by permission, to the editor of RECREATION.

555 Fulton Street, Brooklyn, N. Y.

Your magazine is the best of its kind and we could not get along without it, in our family.

Geo. Bauman, Chicago, Ill.

I think more of RECREATION than of all the other magazines I read.

Fred. E. Baldwin, Stronghurst, Ill.

RECREATION is a splendid magazine, and I recommend it to all my friends.

P. H. Fitzpatrick, Rochester, N. Y.



This is a picture of Sewell Newhouse, inventor of the celebrated  
**NEWHOUSE STEEL TRAPS**  
 known the world over as the best traps made for catching fur-bearing animals. Send to

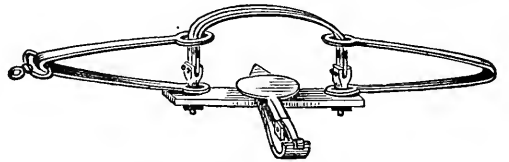

**ONEIDA COMMUNITY, Ltd., Kenwood, N. Y.**  
 for catalogs, prices and discounts.

**FOSTER & CO.** 

Dealers in

*Natural History Specimens*

Animal Heads and Horns, Bird Skins and Eggs, Dead Game Panels, Indian Relics and Photos, Modern Indian Goods of Utility, Minerals, Fossils and Shells, Bicycles and Sundries, Natural History Supplies and Publications, Sporting Goods, Curios, etc. High-Class Taxidermy, Group Work.

**ANN ARBOR, MICH.**

My most valuable prize, the Marlin repeating rifle, is certainly a peach. It is really more than I expected. It shoots to perfection. I never had much experience in rifle shooting, but when I hold this gun to the mark it does the rest. I can never thank you enough, but will do more work for you and for RECREATION. Will get you more subscriptions in the near future and feel I am paid double for my work.

Ezra K. Brenner, Millersville, Pa.

**Taxidermists' Supplies**

WHEN you get a good specimen of bird, fish, mammal etc., that you would like to get mounted, send it to us. We will do it right and also make the price right.

Send five cents for new Taxidermists' Catalogue.

**Artificial Glass Eyes**

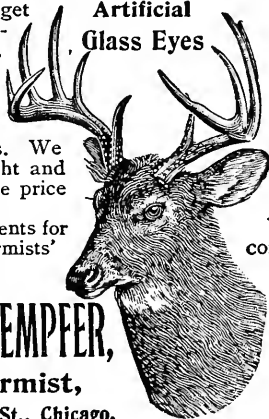

WE prepare and mount all specimens of natural history true to nature, in the best style of the Taxidermist's art, at reasonable prices.

We also keep a complete line of

**Oologists' and Entomologists' Supplies**

**FRED. KEMPFER,**  
 Taxidermist,  
 217 Madison St., Chicago.

I have received the Davenport shot gun you sent me for 15 subscriptions and like it very much. I thank you for the gun, and will send you more subscriptions soon. I am delighted with RECREATION and shall take it as long as I live.

Waldo Hallett, Worcester Academy,  
 Worcester, Mass.



Ernest L. Brown  
**The Minnesota Taxidermist**

Does true and artistic work at reasonable figures.

**WARREN, MINN.**

**GEO. CORNELL, Mt. Upton, N. Y.**

Offers his services as Guide for Visiting Sportsmen. The best ruffed grouse, squirrel and woodcock shooting in the State. Terms reasonable. All inquiries promptly answered. Good reference given.



**AMMUNITION**

Try **.22 Peters' Short Smokeless and New Victor Shells, Loaded with King's Smokeless**

FOR ACCURACY, VELOCITY, STRENGTH, PENETRATION AND CLEANLINESS.



INSIST ON YOUR DEALER SUPPLYING YOU  
**THE PETERS CARTRIDGE CO.**  
 CINCINNATI, O.

FOR SALE EVERYWHERE

## SOME GOOD GUIDES.

Following is a list of names and addresses of guides who have been recommended to me, by men who have employed them; together with data as to the species of game and fish which these guides undertake to find for sportsmen.

If anyone who may employ one of these guides finds him incompetent or unsatisfactory, I will be grateful if he will report the fact to me.

## ALASKA.

William York, Juneau, moose, bear, deer, sheep, goats and small game.

## CALIFORNIA.

Chris. Ringsin, Avalon, Santa Catalina Island, goats, water-fowl, and salt-water fishing.  
John Broder, Visalia, trout, deer, bear, grouse, and quails.  
S. L. N. Ellis, Visalia. ditto

## COLORADO.

J. M. Campbell, Buford, elk, bear, deer, antelope, trout and grouse.  
Chas. Smith, Buford, ditto  
Frank Allen, Dotsero, Eagle Co., "  
Charles Allen, Dotsero, Eagle Co., "  
John Meier, Sweetwater Lake, Dotsero P. O., Eagle Co., "  
R. W. McGee, Debeque, "  
Lem Crandall, Debeque, "  
Sam. T. Himes, New Castle, "  
Luke Wheeler, Pinkhampton, "  
Nathan Fisher, Gunnison, "  
W. H. Hubbard, Glenwood Springs, "  
W. L. Pattison, Buford, "  
J. E. Borah, Glenwood Springs, "  
Ed. L. Stockton, 527 11th St., Greeley, "

## FLORIDA.

C. L. Farnham, Avon Park, bear, deer, turkeys, quails, ducks, black bass, etc.  
Oliver Tinny, Ozona, Hillsboro Co., deer, bear, turkeys, quails, ducks and salt-water fishing.  
E. M. Reynolds, Fort Myers, ditto  
Wm. Webb, Osprey, Manatee Co., "  
Frank Guptill, Osprey, Manatee Co., "  
W. J. Meyer, Tarpon Springs, "  
Robt. E. Hammond, Key West, "  
Frank Carson, Ft. Meyers, "  
E. T. Robinson, Keuka, "  
Carson Bros., Frostproof, "  
J. L. Sandlin, Punta Gorda, "  
Oliver Archer, Clearwater, "  
L. W. Scroggins, Homeland, "  
Capt. Jas. Argo, Oviedo, "  
F. J. Adams, Sanford, "  
C. B. Bailey, Winter Haven, "  
W. H. Steacy, Pt. Tampa City, "  
Wm. J. Lyon, Interlacken, "  
L. L. Sutton, Sutherland, "  
M. B. Carson, Frost Proof, Polk Co., "  
W. D. Isler, Eagle Lake, "  
George W. Hawthorn, Hawthorn, "  
C. H. Hill, Maitland, "  
J. E. Bowen, Laughman, "  
Margan Bass, Kissimmee, "  
B. C. Lanier, Leesburg, "  
John Hunter, Winter Park, "  
H. Shipman, Haskell, "  
Robert James, Emporia, "  
Alex. Brown, Martin, "  
W. J. McCullough, Boardman, "  
Frank Smith, St. James City, "  
Jinks McCreary, Higly, "  
Baldwin Cassady, Lisbon, "  
W. H. Howell, Centre Hill, "  
Ed. Brown, Dunedin, "  
G. B. Lawson, Lake Maitland, "  
J. H. Maddox, Wauchula, "  
Will Montgomery, Arcadia, "  
T. E. Fielder, Calvinia, "  
W. F. Hays, Webster, "

## IDAHO.

W. L. Winegar, Egin, Fremont Co., elk, bear, deer, antelope, mountain sheep, trout and grouse.  
Geo. Winegar, St. Anthony, Fremont Co., ditto  
R. W. Rock, Lake, Fremont Co., "  
Ed. Stailey, Lake, Fremont Co., "  
J. S. Sadorus, Sarilda, Fremont Co., "  
Geo. W. Rea, Orange, Fremont Co., "  
Wm. Fraser, Beaver Canyon, "

## IOWA.

Geo. Jenkins, Spirit Lake, ducks, prairie chickens, black bass, etc.  
Wilbur Clark, Spirit Springs, ditto

## MAINE.

Wm. S. Emery, Blakesley Camps, Eustis, moose, caribou, deer, trout, grouse.  
Algie Spearin, Moro, ditto  
Charley Condon, Moro, "  
Wm. Atkins, Oxbow, "  
Miles D. Arbow, Oxbow, "  
Nathan B. Moore, Bingham, "  
Charley Hale, Medway, "  
Walter Dacey, Medway, "  
Elliott Rich, Bethel, "  
John C. Lamb, Kineo, "  
Winn McKenney, Patten, "  
Mitchell Francis, Patten, "  
Royal E. Paine, Stratton, "  
Charles Hathaway, Medway, "  
Victor Scott, Millinockett, "  
C. O. Norton, Dover, "  
Benjamin J. Woodaid, Dover, "  
Benjamin Woodard, Dover, "  
Col. N. D. Brown, Roach River House, "  
Alonzo Davenport, Shesuncook, "  
Ichabod Smith, Greenville, "  
Ernest Ham, Guilford, "  
Charlee Capen, Capens, "  
Ed. Masterman, Moosehead, "  
Marsh Carlton, Rangely, "  
Freeman Tibbetts, Rangely, "  
Fred Reed, Medway, "  
Dan Hale, Medway, "  
Will Meyer, Eustis, "  
Charles Haley, Eustis, "  
H. R. Horton, Eustis, "  
P. E. Young, Sherman Mills, "  
Abner McPhiters, Norcross, "  
Albert McPhiters, Norcross, "  
Horace B. Cushman, Norcross, "  
Irving Hunt, Norcross, "  
Wm. O. Shaw, Dobsy Lake, Washington Co., "  
Ran. Day, Princeton, Washington Co., "  
Geo. C. Jones, Carritunk, "  
Geo. W. Spaulding, Carritunk, "  
Geo. Douglass, Eustis, "  
David Quint, Eustis, "  
Davis Moody, Stratton, "  
Gus Jones, Stratton, "  
Fred Viles, Stratton, "  
John Darling, Lowell, "  
Joe Francis, Old Town, "  
Sebat Shay, Old Town, "  
Louis Ketcham, Old Town, "  
Granville M. Grey, Old Town, "  
Thomas Benham, Jay, "  
L. A. Orcutt, Ashland, "

## MASSACHUSETTS.

Recommended by Dr. Hitchcock, Cliftondall, grouse, squirrels, salt water fishing.

## MICHIGAN.

Bony Markelty, Negaunee, deer, bear, grouse, trout, black bass, and muskalonge.  
Thos. Starr, Alpena, ditto

## MINNESOTA.

C. L. Porter, Glenwood, ducks, geese, prairie chickens, and black bass.  
E. L. Brown, Warren, ditto  
Jack Baldwin, Jackson, "

SOME GOOD GUIDES (Continued).

MONTANA.

M. P. Dunham, Woodworth, elk, bear, deer, antelope, mountain sheep, trout and grouse.  
 G. H. Heywood, Red Lodge, ditto  
 W. H. Ryther, Columbia Falls, "  
 Quincy Myers, Columbia Falls, "  
 Theodore Christiansen, Columbia Falls, "  
 Mr. William Jackson, Browning, Montana, "  
 W. A. Hague, Fridley, "  
 E. E. Van Dyke, Red Lodge, "  
 Vic. Smith, Anaconda, "  
 James Blair, Magdalen, "  
 George Whitaker, Gardiner, "  
 Richard Randall, Gardiner, "

NEW HAMPSHIRE.

P. Marden, Wolfboro Falls, black bass, grouse and quails.  
 Frank Britton, Wolfboro Falls, ditto  
 J. Walter Akers, Errol, "  
 Ned Norton, Colebrook, moose, caribou and deer.  
 John Bresette, Diamond Pond, ditto  
 Henry Bresette, Diamond Pond, "  
 Lafayette S. Covell, Connecticut Lakes, caribou, deer, etc.

NEW JERSEY.

Billy Throckmorton, Mannahawkin, ducks, geese, brant, shore birds, grouse, salt-water fishing.  
 Dory Hulse, Mannokoking, Ocean Co., ditto  
 Ernest Worth, Bayville, Ocean Co., "  
 James Emmans, Jr., Swartswood Lake, Swartswood, black bass, pickerel, quails and rabbits.  
 Mr. Riker, Culver's Lake, Branchville, perch, black bass and pickerel.

NEW YORK.

Cal. Blanchard, Upper Jay, deer, grouse, rabbits, squirrels and trout.  
 Abe Rundle, Eldred, Sullivan Co., ditto  
 Eugene Scrafford, Eighth Lake, Old Forge, "  
 Edson Brown, Spring Cove, Franklin Co., "  
 William Boyea, Owl's Head, Franklin Co., "  
 Will Simonds, Franklin Fall, Franklin Co., "  
 Harry Freeman, Axton, Franklin Co., "  
 F. A. Young, Big Moose, "  
 Danforth Ainsworth, Big Moose, "  
 Chris Wagner, Beaver, "  
 Chester Elliot, Beaver, "  
 Edw. Ball, Old Forge, "  
 Garrie Riggs, Old Forge, "  
 Eugene M. House, Glendale, "  
 Geo. P. Finnegan, Smithville Flats, Chenango Co., "  
 L. C. Pendell, Athol, "  
 Geo. Goodsell, Old Forge, "  
 Joe Ward, C. & A. branch, R. N. & O., Oswegatchie, "  
 Martin Humes, Harrisville, "  
 Raymond Norton, Glendale, Lewis Co., "  
 Frank Perkins, Greg, Lewis Co., "  
 Chris. Wagner, Beaver River, "  
 Chas. McKaffery, Saranac Inn, "  
 C. I. Stanton, Blue Mountain Lake, "  
 George W. Fuller, Blue Mountain Lake, "  
 Lawrence Sweeney, Lake Clear, "  
 Leonard Bunting, Greenfield, Ulster Co., grouse, woodcock and trout.  
 Thomas Flake, Cape Vincent, pickerel, muskalonge, black bass.  
 Wilfred Dodge, Cape Vincent, ditto  
 Ren Dodge, Cape Vincent, "  
 Warren Aldrich, Greenwood Lake, black bass, trout, grouse, squirrels, rabbits, etc.  
 Charles Lane, Good Ground, L. I., ducks, geese, snipe, plover and salt-water fishing.  
 Harry Rogers, Eastport, L. I., ditto  
 Geo. Rolston, Lake Ronkonkoma, L. I., "  
 Willett Ellison, Freeport, L. I., "  
 W. C. Raynor, Freeport, L. I., "  
 W. N. Ackerley, Patchogue, L. I., ducks, baybirds, salt-water fishing.  
 H. Smith, Moriches, L. I., quails, woodcock and grouse.  
 Dan Havens, Centre Moriches, L. I., ditto  
 Hugh Smith, East Moriches, L. I., "

NORTH CAROLINA.

Fenner S. Jarvis, Haslin P. O., deer, bear, turkeys and quails.  
 Robert Waterfield, Knotts Island, ditto  
 Jas. Tooly, Belleport, "  
 W. C. Halsted, Currituck C. H., deer, turkeys, quails, ducks, salt-water fishing.  
 Fred. Latham, Haslin, ditto

NORTH DAKOTA.

Geo. Carl, Sanborn, ducks, geese, prairie chickens, snipe, black bass and pike.

OREGON.

Wm. Ascher, West Fork, Douglass Co., deer, bear, elk, trout, grouse, ducks and geese.  
 E. L. Howe, Creswell, Lane Co., ditto

PENNSYLVANIA.

Leonard Champion, Prop'r Lehigh Valley Hotel, Mahopany, Wyoming Co., bass, pickerel, salmon.

VERMONT.

E. Ward, Fair Haven, woodcock, grouse, black bass and trout.

VIRGINIA.

M. Corbel, Virginia Beach, geese, brant, ducks, shore birds, quails, salt-water fishing.  
 Captain R. E. Miles, Machipongo, ditto  
 C. A. Spencer, Buckingham, "  
 M. A. Barner, Clarksville, "

WASHINGTON.

John S. Wood, Morton Lewis Co., deer, grouse, trout, etc.

WISCONSIN.

T. R. Page, Bruce, deer, grouse, trout, black bass and muskalonge.  
 Charles Johnson, care Williams, Salsich & Co., Star Lake, Vilas Co., ditto  
 L. L. Thomas, State Line, "  
 John Thomas, State Line, "  
 Chas. French, Three Lakes, "  
 M. E. Monsell, Star Lake, Vilas Co., "  
 H. E. Soule, South Range, "  
 Judd Blaisdell, Camp Franklin, Woodruff, "  
 Alexander Gillies, Camp Franklin, Woodruff, "  
 C. J. Coon, Camp Franklin, Woodruff, "

WYOMING.

Mark H. Warner, Ten Sleep, elk, bear, deer, mountain sheep, antelope, grouse and trout.  
 Milo Burke, Ten Sleep, ditto  
 James Fullerton, Ten Sleep, "  
 Nelson Yarnall, Dubois, "  
 Geo. Y. Hayes, Dubois, "  
 S. A. Lawson, Laramie, "  
 R. C. Tregoning, Laramie, "  
 A. Pache, Laramie, "  
 N. E. Brown, Marquette, "  
 H. D. DeKalb, Big Piney, "  
 Ira Dodge, Cora, "  
 S. N. Leek, Jackson, "  
 Jack Hurst, Ishawood, "  
 W. A. Kepford, Ishawood "  
 Wm. Wells, Cora, "  
 Frank L. Peterson, Jackson, "  
 O. F. Bike, Jackson, "  
 F. E. White, Jackson, "  
 W. A. Hague, Pleasant Valley Hotel, via Mammoth Hot Springs, "

CANADA.

Christopher Bowers, Shelburne, Nova Scotia, moose, bear, grouse, black bass and trout.  
 E. Thompson, Hammond Plain, Nova Scotia, ditto  
 John Bowers, Shelburne, Nova Scotia, "  
 Frank Komondo, Desert or Maniwaki, P. Q., "  
 Philamon Gashon, Three Lakes, P. Q., "  
 Robert Elliott, Kennebec Road, Armstrong, "  
 County Beauce, P. Q., "  
 Geo. Gillard, Little Bay, Notre Dame Bay, Newfoundland, caribou, bear, ptarmigan, ducks and geese.  
 W. Kelly McKay, Upper Clyde, Shelburne Co., N. S., moose, bear, lynx, fox, partridge, rabbit, trout.  
 James H. Bower, Upper Clyde, ditto  
 Thomas Davis, Upper Clyde, "  
 Purney Davis, Upper Clyde, "  
 Christian Ryer, Middle Clyde, "  
 Daniel McKay, Middle Clyde, "  
 Parker K. Freeman, Milton, Queens Co., N. S., moose, bear, lynx, fox, partridge, rabbit, trout, salmon.  
 John Jeremy, Milton, ditto  
 Stephen Glode, Milton, "  
 Alick Michel, Milton, "  
 Enoch Freeman, Greenfield, "  
 Boardman Hunt, Greenfield, "  
 Capt. Jesse Milliken, St. George, N. B. "  
 Henry I. Millar, River Desert, "

## WHAT THEY SAY OF IT.

I am just in receipt of April RECREATION and must send you a word of appreciation of the hard, clean work you are doing. One has only to make a comparison of your issue this month, with that of April, 1896, to be convinced that the magazine is a success and will remain a success, only more so. You deserve the support of every sportsman in the country and I hope you may get it. I shall certainly aid you all I can. Fred. W. Kriedler, Miles City, Mont.

RECREATION has a large following in this district. All my sportsmen friends take it. I also see it for sale in the principal book stores, and when on the road, through different parts of the Province RECREATION meets one at every turn. This shows it has a large circulation in Nova Scotia, and it must be a first class magazine for advertisers, reaching, as it does, all those interested in matters of sport.

H. Austen, Halifax, N. S.

RECREATION is a most charming and useful sportsmen's paper. I get 2 copies every month in order to cut out the pictures and paste them in an album. The pictures are often on the back of one another so I could not take one without losing the other. C. Rachmiel, New York City.

RECREATION is the finest magazine published in the United States. I read it from cover to cover. Am glad to see the subscription receipts swelling with such rapidity. Hope to see RECREATION at the 50,000 mark very soon.

R. H. Phillips, Milltown, Me.

RECREATION is the best magazine I have ever seen, and if it keeps on increasing in the future, as it has in the past, a sportsman cannot give it praise enough. In fact I can't see how anybody can do without it.

Jos. M. Miller, Verdery, S. C.

Reading RECREATION is like taking a long walk over fields, through woods, and by singing, flashing brooks, on a bright, crisp, breezy morning, when all the air is full of sunshine, and bird songs.

Mrs. M. Lilebron, Esperance, N. Y.

I would not be without RECREATION by any means. I will send you some new subscribers as soon as I can get to see them. All who read the book once always ask for it when they come again.

J. E. Bercaw, Dingmans Ferry, Pa.

I have been a subscriber to your magazine 2 years and now cannot and will not do without it. It is the best sportsmen's magazine published, and wish you every success.

A. W. Woodhill, Sydney, Cape Breton.

RECREATION is "hot stuff." I have been taking it a year, without missing a copy, and it is a corker. The only fault I find with it is it doesn't come every week.

Robt. Acker, Mauch Chunk, Pa.

I am very much pleased with RECREATION, and shall continue to take it as long as I am able. Shall recommend it to my friends every chance I get.

Jas. C. Farthing, St. Stephen, N. B., Can.

My father has taken RECREATION for some years and it is one of the best magazines published. I take as much interest in it as my father does.

Alice C. Sweet, Williamsport, Pa.

I am a reader of the most complete magazine ever published. Its name is RECREATION. I read it every month, from cover to cover.

Geo. Jory, Calumet, Mich.

I have been a reader of RECREATION for a long time. One more voice added to the shout of praise for RECREATION.

E. H. Butler, Tacoma, Wash.

Have got 10 names since morning. Less than 2 hours' work altogether. The magazine sells itself.

H. D. Stebbins, Boston, Mass.

RECREATION is the best sportsmen's journal published. I read several, but find none so interesting as this.

H. C. Kurrasch, N. Hudson, Wis.

RECREATION is a good thing, and should be pushed along, which I am anxious to do. I do not see how it could fail to please anyone who has a spark of nature in him.

W. Porter, Worcester, Mass.

April number of RECREATION is just splendid, better and better all the time. A more interesting sportsmen's magazine I never read.

Frank E. Mills, Middletown, N. Y.

I am greatly pleased with RECREATION. It is the best sportsman's magazine out. I regret I did not take it before.

A. C. Santana, Paterson, N. J.

RECREATION is very popular here, and is longed for each month eagerly by the entire household.

Walter I. Shay, Marysville, Mont.

All the boys like RECREATION very much, and I can hardly wait for it to come, from one month to another.

Fred Libbey, Concord, N. H.

I think RECREATION is the best magazine in print, and intend to take it as long as I live.

Russell Allen Smith, Graniteville, Mo.

My father takes other sportsmen's papers but always wants to see mine, as he thinks it is best. RECREATION is

C. H. Smith, New York City.

I read most of the ads in your magazine and I have gotten some valuable information from them.

R. P. Schermerhorn, Wilton, N. Y.

I have only words of praise for your bright, up-to-date, little monthly, and its enterprising publisher.

Al Macnab, Fort Meade, S. D.

RECREATION is the best sportsman's magazine published. I recommend it to all lovers of sport.

Wm. B. Stanley, Little Falls, N. J.

Advocate legitimate sport and protection and your magazine will continue to be a success.

Frank McGuire, 656 Lexington Ave., N. Y.

Am very much pleased with RECREATION. It is the best magazine, for the money, I ever saw.

W. E. Bartlett, Mt. Sterling, Ill.

Am delighted with RECREATION. I often wish it was printed weekly instead of monthly.

H. P. Camp, Hartford, Conn.

Here are 10 subscriptions for RECREATION, and it did not take me 2 hours to get them.

Harry A. Beaver, Cadillac, Mich.

I have just heard from some of the people whose names I sent you, who say RECREATION is out of sight.

H. D. Stebbins, Boston, Mass.

RECREATION is a dandy. It is worth more than all the others. I can hardly wait for it.

J. J. Whalen, Haverhill, Mass.

We are very much pleased with your magazine. The illustrations are fine.

W. J. Bush, Lockport, N. Y.

Of all the sportsmen's magazines I have read, RECREATION is the best.

H. Penniman, Cromwell, Conn.

I am stuck on RECREATION. It is the best magazine of the kind printed.

Harry Hibbs, Trenton, N. J.

RECREATION is all you claim for it, and a good deal more.

Duncan Ross, Middletown, N. Y.

RECREATION is the best sportsmen's magazine going.

C. A. Lodge, Berment, Ill.

I like RECREATION better every month.

W. J. Kirkman, St. Paul, Minn.

**A Practical Common Sense Camp Stove.**

In 6 Sizes. Patent applied for.

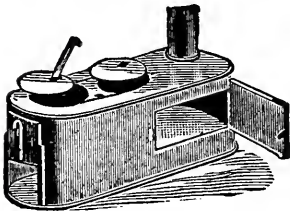

The lightest, most compact, practical camp stove made; either with or without oven. Won't get out of shape, combination cast and sheet steel top, smooth body, heavy lining, telescopic pipe carried inside the stove.

Burns largest wood, keeps fire longest of any stove made. For full particulars address

D. W. CREE, Manufacturer, Griggsville, Ill.

**Dixon's Graphitoleo**

Lubricates not only the chain and sprockets, but also the pins in the links of the chain, which stick Graphite cannot do and is not intended to do. For gun locks, for copying presses, and for office chairs it is unequalled. If your dealer does not keep it, mention RECREATION, and send 15 cents for sample.

JOS. DIXON CRUCIBLE CO., Jersey City, N. J.

**WANTED.**—LIVE ELK, MOOSE, CARIBOU, BLACK-tail deer, wild turkey, European roebucks, fallow deer, etc., for Litchfield Park, Adirondacks. Address, with particulars, EDWARD H. LITCHFIELD, 59 Wall Street, New York.

Do you hunt big game?  
 Do you sail a yacht?  
 Do you travel on railway trains or steamers?  
 If so, you need a ... **Field Glass**  
**GALL & LEMBKE**  
 21 Union Square, New York  
 sell the best ever made. Ten per cent. discount, from regular prices, to all readers of RECREATION  
 Mention this when you write us.

I received the Forehand gun, in good condition and am much pleased with it in every particular. It is exactly as I requested. Have killed ducks with it which my companions said were out of reach of any shotgun. The subscribers all like RECREATION, which is not strange, by any means.  
 Fred. D. Jones, Port Townsend, Wash.

IN ANSWERING ADS, IF YOU WILL KINDLY MENTION RECREATION YOU WILL GREATLY OBLIGE THE EDITOR.

**G. CRAMER**  
**DRY PLATE WORKS**  
 ST. LOUIS, MO.  
 Full descriptive catalogue mailed to any address on application

The Forehand hammerless gun received and it far surpasses my expectations. The critics had their laugh, while I was getting the subscriptions; now it is my turn. Three of my subscribers have started out to get clubs in order to get similar guns. I will keep the ball rolling for RECREATION. I have one subscriber 84 years old and he takes more pleasure in reading RECREATION than in the news of the day.  
 A. V. Voorhees, 123 Varick St., N. Y.

The Ithaca gun you sent me, for 35 subscriptions, is far above my expectations. It is a hard shooting gun and one that any sportsman may well feel proud of.  
 Chas. E. Stone, Newburyport, Mass.

Permit me to thank you for the Bristol steel rod, sent me as a premium for 10 subscriptions. It is the first time anything of value ever came my way, for nothing. It is no trouble to sell RECREATION to a sportsman. The rod is a beauty and feels as though it would do good work.  
 Avery L. Foote, Newark, N. Y.

Yesterday I flushed a band of about 60 mallards, from the Sangamon swamps, near here.  
 A covey of 18 Bob Whites came to my corn crib every day, last winter, for their rations. They were fine, plump little fellows. Recently a Mr. Chas. Rider, while chopping on an old basswood tree, scared 2 fox squirrels out of a hole, in the top of the tree. He went to a house near by, got a gun and shot both of them. Then he felled the tree, went to a large hole near the top, and there lay an old raccoon. Of course he killed him, and began to think the woods were full of game. "Sangamon," Ellsworth, Ill.

She: What makes you think Sommers does not like Asbury Park?  
 He: I notice that whenever he goes out, he has a bored walk.

# A CHANCE TO BE TAKEN QUICKLY

FOR

## \$2.00

DOWN

We will send to any reader of

RECREATION,

as long as they last, a complete set of the best history of our own country,

# Scribner's History of the U.S.

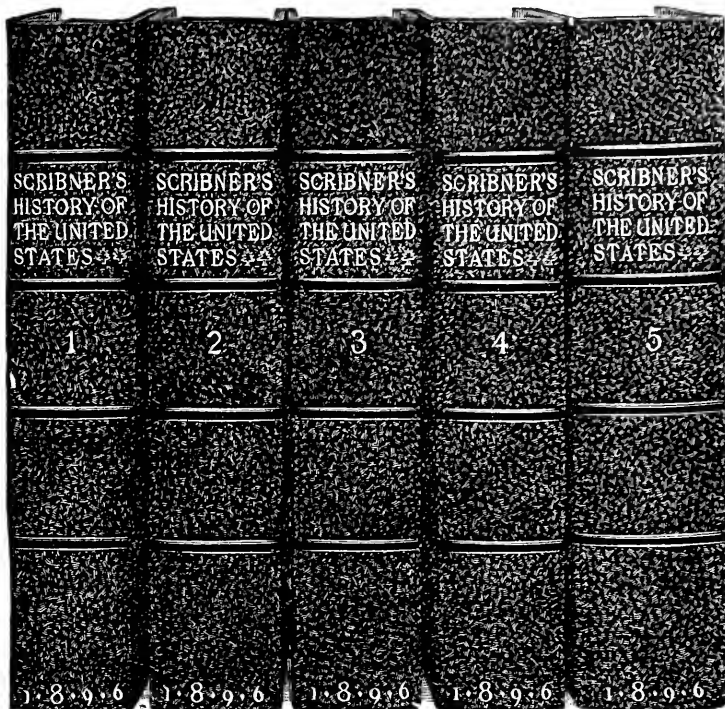

A superb Work. 5 Royal Octavo Volumes. 3,500 pages. Weight, 25 lbs. 1,600 Illustrations which cost over \$100,000. Index of 12,000 References. The only popular, adequate history of the country published. This is **THE BEST** edition issued by Charles Scribner's Sons.

The New York Tribune has secured the entire first edition, the chief part of which has been sold to its own readers, but it offers the same discount of 1-3 off—as long as the copies in hand last—to readers of RECREATION, as follows:

**THE PROPOSITION:** The complete set in 5 volumes will be sent, express paid, on receipt of \$2.00 and the agreement to pay \$2.00 a month for nine months and \$1.00 on the tenth month—\$20.00 in all for cloth style (Regular price, \$30.00). Half leather, \$1.00 a month more.

### WHAT GOOD AUTHORITIES SAY:

**Ex-President Benjamin Harrison:**

I commenced the scheme of the work and the execution of it in those parts that I have been able to examine. A good acquaintance with our national history is really essential to good citizenship, and I hope this history may have a wide distribution.

**Thomas L. James.**

I find Scribner's History of the United States to be a clear, crisp, and comprehensive story of the rise and progress of the Republic, in art, in science, in literature, in mechanics, and in agriculture, plainly and concisely told.

**Dr. Lyman Abbott:**

The Standard History of the United States for the household and the general readers.

**Charles Dudley Warner:**

Here the story of our national life from the beginning is set forth with conscientiousness, so that it is a safe guide and a most entertaining history for general reading.

**Justice Stephen J. Field, Washington:**

The work is admirably prepared, and possess greater merits than any other history of the United States with which I am acquainted. It deserves a place in the library of every student.

If the history, which we make no attempt to describe in this small space, is not to your satisfaction, return at our expense and money will be refunded—and no quibbling about it. We only ask you to see the work. The opinions of 100 prominent buyers sent on request. Address

**The New York Tribune, 154 Nassau Street, New York**

# Savage Rifles for Savage Game



.303 Carbine

## One Savage Rifle

takes all these different cartridges without any change or adjustment

CATALOGUE ON APPLICATION



BIG GAME HUNTING



BLACK POWDER RANGES



SCHUETZEN TARGET RANGES



SMALL GAME HUNTING



LONG RANGE TARGETS



SHORT RANGE USE

HOME OFFICE  
SAVAGE REPEATING ARMS CO.  
Utica, N. Y.

PACIFIC COAST AGENCY  
BAKER & HAMILTON  
San Francisco, Cal.

# New Ithaca Guns

Self compensating,  
taking up wear  
at every point

Bored  
FOR BLACK AND  
NITRO POWDERS

Close and Hard Shooting Guns  
at long range a specialty

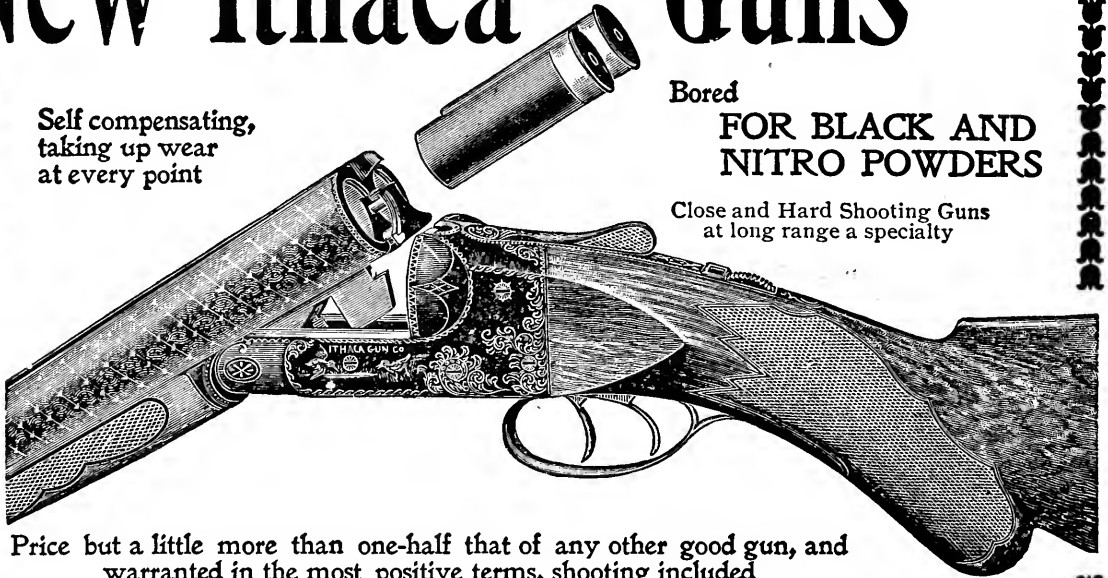

Price but a little more than one-half that of any other good gun, and warranted in the most positive terms, shooting included

ITHACA GUN COMPANY, ITHACA, N. Y.

Send for circular  
Mention RECREATION

Manufacturers of fine Hammer  
and Hammerless Guns



For nearly 50 Years the name

**“Davenport”**



has been identified with the manufacture of

**Guns....**

**and Rifles**  
+++++

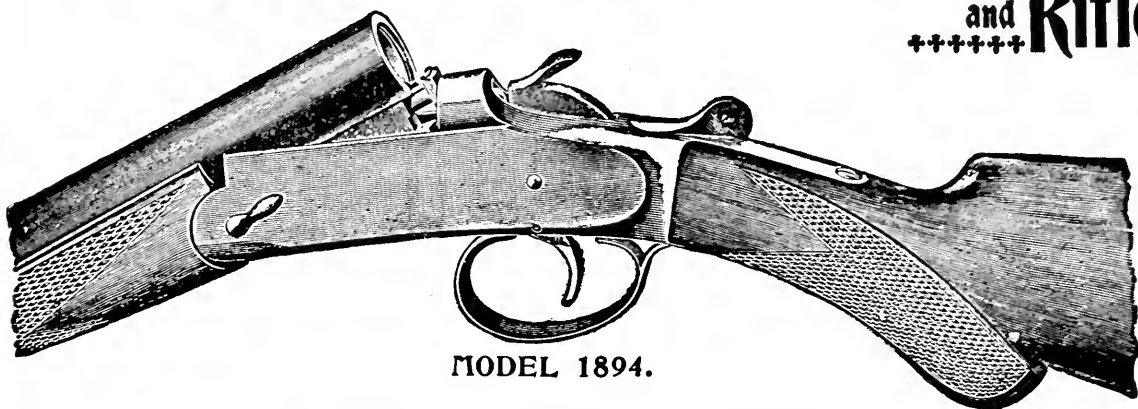

MODEL 1894.

**AUTOMATIC EJECTOR**

Our present line is complete and varied and shows the result of years of experience.

For catalogues and information address

**THE W. H. DAVENPORT FIRE ARMS CO.**

**NORWICH, CONN., U. S. A.**

Mention "RECREATION"

*Ejector Guns  
no longer a  
luxury*

**Good News for Sportsmen**

Lefever Automatic Ejector Guns at a price within the reach of every sportsman.

OUR NEW EJECTOR MOVEMENT

*Has only two pieces: One in the Hammer, One in the Frame.*

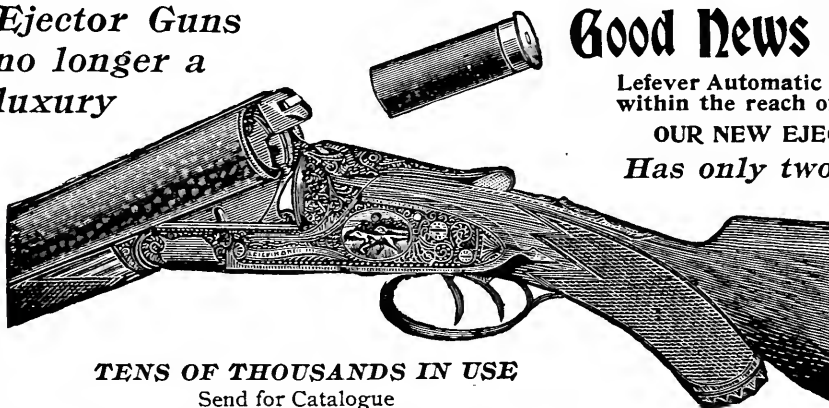

We have decided to meet the demand for *medium* price Ejectors, and are now prepared to accept orders for all grades of our hammerless guns fitted with Ejectors.

**TENS OF THOUSANDS IN USE**

Send for Catalogue

**LEFEVER ARMS CO. - - Syracuse, N. Y.**

(Mention RECREATION.)

Date,.....1897.

G. O. SHIELDS,

Editor and Manager of RECREATION, 19 West 24th St., New York:  
Herewith find One Dollar, for which please send me RECREATION  
for one year beginning with..... number.

Name,.....

Remit by P. O. or Express Money Order, or New York Draft.

DETACH THIS, FILL OUT, AND SEND IN.

# A FINE PERFORMANCE GRAND AMERICAN HANDICAP, 1897



1st—Hon. T. A. MARSHALL,  
Keithsburg, Ill., 25 kills straight.

2d—Dr. W. F. CARVER, Chicago,  
24 straight, and 25th killed but  
carried out of bounds by wind.

2d—Dr. J. L. WILLIAMSON, 24  
ex. 25.

All  
Using  
Cashmore  
Guns

## FIRST AND TWO SECONDS OUT OF 136 COMPETITORS

### TRAP GUN BUILDING A SPECIALTY

NEW LIST FREE

Address, WM. CASHMORE, Gunmaker

Telegram, "Extractor, Birmingham"

BIRMINGHAM, ENG.



FOR FIELD OR FOR TRAP,  
FOR POT HUNTING OR FUN,  
NO SPORTSMAN IS EQUIPPED  
WITHOUT A SYRACUSE GUN

“MORE TRUTH  
THAN POETRY”

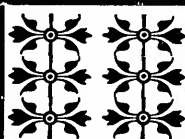

We do not say that SYRACUSE HAMMERLESS GUNS

“Are as Good” as any gun in the market.

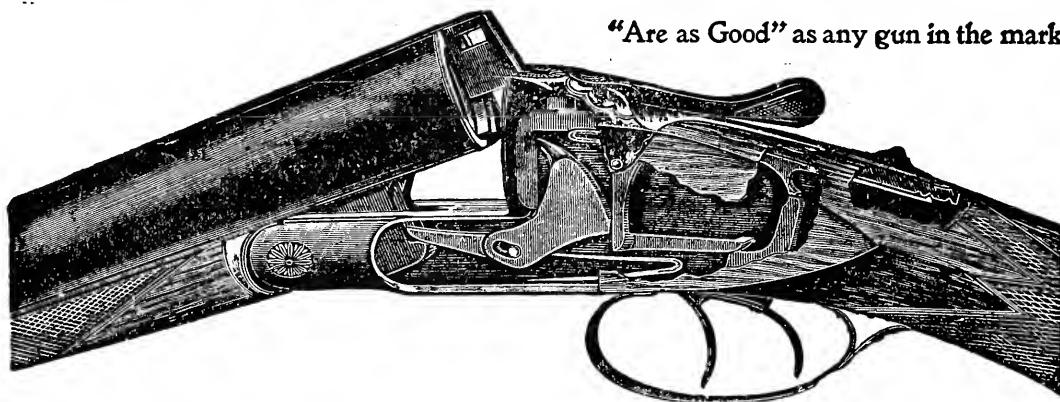

Their simplicity of construction and superiority of finish stamp them “BETTER” for practical all-round work than any gun in the market. The “old, old story” but, nevertheless, substantiated by every man who ever drew a Syracuse to his shoulder.



SYRACUSE ARMS CO., SYRACUSE, N. Y., U. S. A.



Sole Agents, HERMANN BOKER & CO., 101 Duane Street, New York City

# Forehand Arms Co.'s

EJECTOR AND NON-EJECTOR  
HAMMERLESS DOUBLE GUN

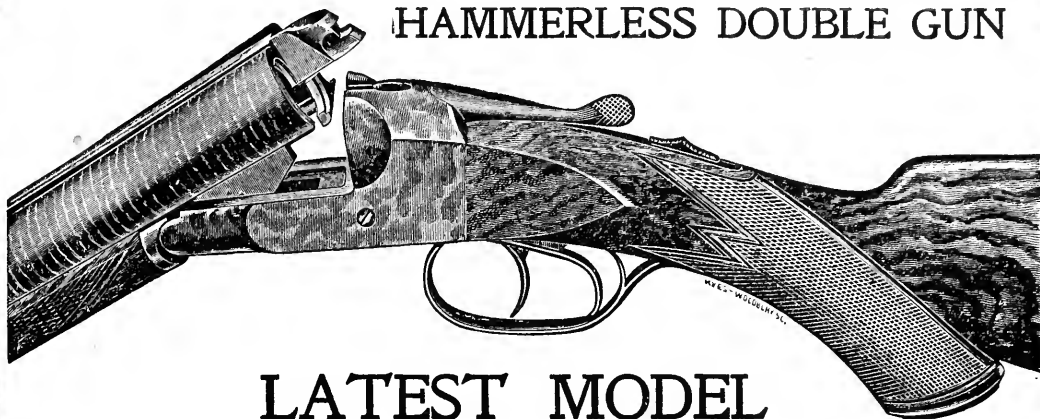

LATEST MODEL

53 Lansdowne Ave., Toronto, July 16, 1897.

Forehand Arms Co., Worcester, Mass.

Gentlemen: The twelve gauge gun, No. 2299, which I got from you in February last, has been given a thorough trial during the past five months, and in justice to you, as makers, I must express my appreciation of your work. The gun has been used with all sorts of charges, in the collecting of ornithological specimens, and in none of them has it failed to give the greatest satisfaction. The beauty of its lines, and the general excellence of the workmanship throughout has been a source of pleasure to myself and all my friends. I know you receive many of these commendations, but I cannot let the opportunity pass of adding to the pile.

Yours sincerely,  
JNO. BOYD.

**Read what men  
say of the  
Forehand, who  
are using it**

MISSOURI, KANSAS & TEXAS RAILWAY CO.,

New Franklin, March 7, 1896.

Forehand Arms Co., Worcester, Mass.

Dear Sirs: The 16 gauge ejector received in due time, and since shooting it I am satisfied I made a wise selection in getting a 16. The gun is a beauty, and an excellent shooter, and I am more than pleased with it. My friends congratulate me on getting such a fine gun. All who see it say it's the neatest and most perfect balanced and finished gun they ever saw, in a 16. After we get started on our trap shooting will let you hear again how she works on targets. Hoping the gun may be the means of securing you some orders, and thanking you for the nice and prompt work on it, I remain,

Yours truly,

L. STAIGER.

**We get Thousands  
of such  
Testimonials—  
all Unsolicited**

**"WHAT EVERYONE SAYS MUST BE SO"**

*We challenge competition in Beauty, Workmanship, Simplicity of Mechanism, Shooting Qualities and Price. We target all our guns with nitro powder. For Catalogue, address*

**FOREHAND ARMS CO., WORCESTER, MASS.**

"COMMON SENSE OF **DOG** DOCTORING"  
 A CONCISE AND UP-TO-DATE POPULAR TREATISE  
 PRICE (MAIL FREE), 25 CENTS

DOG AND POULTRY  
 SUPPLIES

Order through your Dealer and send for catalogue to  
**SPRATTS PATENT LIMITED**  
 245 EAST 56TH STREET, NEW YORK CITY  
 SAN FRANCISCO BRANCH  
 1320 VALENCIA STREET

THE OLD  
 RELIABLE

Parker Gun

HAS  
 NO EQUAL

*Has stood the test  
 of over 30 years*

*"Built on Honor"*

*Simplicity and dura-  
 bility combined with  
 handsome finish and  
 perfect shooting  
 qualities*



*Experience and ability have placed "The Parker" in an  
 enviable and well deserved position as the best gun in the  
 world. Made by the oldest shot gun manufacturers in America.  
 Nearly 100,000 in use.*

SEND FOR CATALOGUE

New York Salesrooms  
 96 Chambers Street

**PARKER BROS., Meriden, Conn.**

# MARLIN DOUBLE ACTION REVOLVERS



All Parts of  DROP FORGED STEEL

Perfect in Finish

Unsurpassed in Accuracy

MADE IN 32 AND 38 CALIBRES, WITH 3¼ INCH BARREL  
Blued or Nickel Finish

Send for Catalogue **The Marlin Fire Arms Co.,** New Haven, Conn.  
Given as a Premium for 10 Subscriptions to Recreation

## Hon. Thomas Marshall

Mayor of Keithsburg, Ill.

25

STRAIGHT



WINNER OF

### Grand American Handicap

March 24, 1897

Used DU PONT SMOKELESS POWDER

E. I. Du Pont De Nemours & Co., WILMINGTON, DEL.

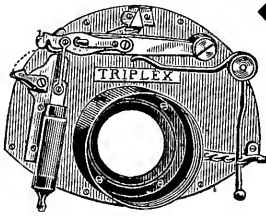

PATENTED.

# THE TRIPLEX

## Photographic Shutter

is the stand-by of the practical amateur and professional. On the market over eleven years, and its popularity increases.

### ADVANTAGES

**FIRST**—Its construction is simplicity itself; it keeps in repair.

**SECOND**—Optically, it gives full value of lens, no reducing illumination by nearly half, like an iris diaphragm shutter.

**THIRD**—It does time work, ordinary fast work, and rapid work to  $\frac{1}{150}$  of a second. Few other shutters have more than one-third this range of speed.

**PRICES:** 4 x 5, USUALLY \$14.00 5 x 7, USUALLY \$15.50

See Circular about \_\_\_\_\_

Athlete Shutter and Storage Flash Lamps

PROSCH MFG. CO., 389 Broome Street, New York

**B&O**  
**BEST LINE**  
 TO  
 Pittsburg  
 Cincinnati  
 St Louis  
 Chicago  
 Indianapolis  
 Toledo

Always Bright!



FOR '97

**WILL  
 NOT  
 JAR  
 OUT**

ALL RIDERS  
 SAY  
 IT IS  
 The Best.

For Sale Everywhere.

BRIDGEPORT BRASS CO.,

BRIDGEPORT, Conn.

Send for Circular.



## What's the Use

of walking when you  
can get a first-class, high-  
grade bicycle for nothing?

## How?

By getting 75 subscriptions for

## Recreation

If you live in a town of 3,000  
or more, and if you are a hustler  
you can get these in 2 days.

I can give you the names of 20  
people who did this in 1896, and  
who now have their wheels.

Write for particulars.

## RECREATION

19 West 24th Street  
New York



I wonder how many of your readers have ever hunted "gators"? Now that the deer, turkeys and quails are resting, and building, we of the South land take a bull's eye lantern, a boat and a rifle and shoot alligators. I have killed about a dozen in one small pond, during the summer and spring, all sizes. We shine their eyes while in a boat, shoot them and then with a gator hook, drag them ashore.

Fishing has been rather slow. Two of us had one fine morning's sport. Fished 2 hours, about sunrise, and caught 24 good bass. The string weighed 27 pounds; largest fish, 6 $\frac{1}{8}$  pounds. I landed him with a 2 ounce bamboo rod and a small line. Am expecting lots of sport next winter, among larger game.

D. Burson, Seffner, Fla.

I don't think there are 150 elk left in the Big Horn mountains; but they are cornered about Ten Sleep lakes, among rocky peaks, where they make a lot of tracks in a small area. I saw most of them, after snow fall, and there were no scattering tracks. It is too bad to see the elk wiped out. Nothing can save them.

Game has wintered fairly well; only old cow and bull elk are dying off. No bear signs anywhere this spring; very few antelope, but a good sprinkling of deer.

B. H., Jackson, Wyo.

## BOOKS BY G. O. SHIELDS

(COQUINA)

### THE BIG GAME OF NORTH AMERICA

Its Habits, Habitat, Haunts and Characteristics. How, When and Where to Hunt it. 8vo, 600 pages, 80 illustrations. Cloth, \$3.50; Half Morocco, \$5.00; Full Morocco, \$6.50.

### CRUISING IN THE CASCADES

A Narrative of Travel, Exploration, Amateur Photography, Hunting and Fishing, with Special Chapters on Hunting the Grizzly Bear, the Buffalo, Elk, Antelope, Rocky Mountain Goat, and Deer; also on Trout in the Rocky Mountains; on a Montana Roundup; Life Among the Cowboys, etc. 12mo, 300 pages, 75 illustrations. Cloth, \$2; Half Morocco, \$3.

### AMERICAN GAME FISHES

How, When and Where to Angle for them. 8vo, 400 pages, 50 illustrations. Cloth, \$2.50; Half Morocco, \$4.

### HUNTING IN THE GREAT WEST

(*Rustlings in the Rockies*)  
Hunting and Fishing Sketches by Mountain and Stream. 12mo, cloth. Over 300 pages. Illustrated. Price, 75 cents.

### THE AMERICAN BOOK OF THE DOG

The Origin, Development, Special Characteristics, Utility, Breeding, Training, Diseases and Kennel Management of all Breeds of Dogs. 8vo, 650 pages, 100 illustrations. Cloth, \$3.50; Half Morocco, \$5; Full Morocco, \$6.50.

### CAMPING AND CAMP OUTFITS

A Manual of Instruction for Young and Old Sportsmen. 12mo, 200 pages, 30 illustrations. Cloth, \$1.25.

### THE BATTLE OF THE BIG HOLE

History of General Gibbon's Engagement with the Nez Perce Indians in the Big Hole Basin, Montana, August 9, 1877. 12mo, 150 pages. Profusely illustrated. Cloth, \$1.

*These books will be mailed, post-paid, on receipt of price, by the author.*

G. O. SHIELDS

19 West 24th St., New York

# Some Rare Oppor- tunities

These goods are all new, and will be shipped direct from factory. Prices named are those at which manufacturers and dealers usually sell. Here is a good chance to get

A BOOK  
A GUN  
A CAMERA  
A TYPEWRITER  
A BICYCLE

FREE OF COST.\*\*\*

Subscriptions need not all be sent at once. They can be sent in installments as taken and credit will be given on account. When the required number is obtained the premium earned will be shipped.

“Recreation”

19 West 24th Street  
New York

## To any person sending me

- TWO yearly subscriptions to RECREATION at \$1 each, I will send a copy of *Hunting in the Great West*, paper; or a Czar Camera, listed at \$1.
- THREE subscriptions at \$1 each, a copy of *The Battle of the Big Hole*, cloth.
- FOUR subscriptions at \$1 each, a copy of *Camping and Camping Outfits*, cloth.
- FIVE subscriptions at \$1 each, a copy of *Cruising in the Cascades*, cloth; or a Will-sie Pocket Camera, valued at \$5. It makes a picture  $2\frac{1}{8} \times 2\frac{3}{8}$  inches and can be loaded with 24 cut films.
- SIX subscriptions at \$1 each, a copy of *American Game Fishes*, cloth; or a Baby Hawkeye Camera, listed at \$6.
- SEVEN subscriptions at \$1 each, a copy of *The Big Game of North America*, or of *The American Book of the Dog*, cloth; or a Cyclone Camera, listed at \$10.
- EIGHT subscriptions at \$1 each, a Pocket Kodak, made by the Eastman Kodak Co., and valued at \$5.
- TEN subscriptions at \$1 each, a single-shot Davenport Rifle; or a Fishing rod, or a Yawman and Erbe Automatic Reel, worth \$9; or a Kenwood Sleeping Bag, worth \$10; or a No. 10 Gramophone, worth \$10.
- TWELVE subscriptions at \$1 each, a Manhattan Improved Hand Camera, made by the Manhattan Optical Co., and valued at \$12.
- FIFTEEN subscriptions at \$1 each, a Davenport Single-barrel, breech-loading Shotgun, worth \$15; or a Camera, worth \$6 to \$10; or a Kenwood Sleeping Bag, complete with canvas cover, worth \$16; or a No. 2 Bullet Camera, loaded, worth \$10.
- TWENTY subscriptions at \$1 each, a 14-karat Gold Hunting-case Watch, with Elgin Movement, worth \$20; or a Marlin Repeating Rifle, listed at \$20; or an Improved Night-hawk Hand Camera, made by the Manhattan Optical Co., and valued at \$25; or a No. 4 Bullseye Camera, made by the Eastman Kodak Co., and worth \$12.
- TWENTY-FIVE subscriptions at \$1 each, a No. 4 Bullet Camera, made by the Eastman Kodak Co., and worth \$18; or a Gramophone, valued at \$25; or an Australian Mosquito Tent valued at \$25.
- THIRTY-FIVE subscriptions at \$1 each, a Forehand or a Syracuse Double-barrel Hammerless Breech-loading Shotgun, worth \$35; or a Camera, worth \$25.
- FORTY subscriptions at \$1 each, a Camera, worth \$30.
- FIFTY subscriptions at \$1 each, a Marlin Rifle, with fancy curled walnut stock, pistol grip, checkered four-end, handsomely engraved, half octagon, half magazine, with take down, listed at \$50.
- SEVENTY-FIVE subscriptions at \$1 each, a Safety Bicycle, worth \$85 to \$100; or a Bo-peep Camera, for 5x7 plates, made by the Manhattan Optical Co., and valued at \$90.
- ONE HUNDRED subscriptions at \$1 each, a fine Lefever Hammerless Gun, worth \$85; or a Bo-peep Camera, for  $6\frac{1}{2} \times 8\frac{1}{2}$  plates, made by the Manhattan Optical Co., and valued at \$120.



# "THE LITTLE FINGER DOES IT"

The Fisherman's Automatic Reel



## THE AUTOMATIC



## REEL

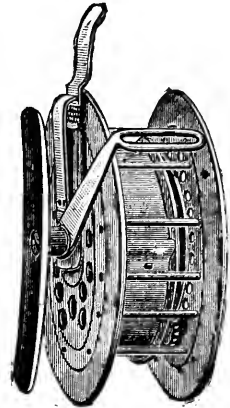

Manufactured by  
**YAWMAN & ERBE**  
344 No. ST. PAUL Street,  
ROCHESTER, N. Y. U. S. A.



SEND FOR CATALOGUE

### What we claim for the Automatic Reel

**First**—It will wind up the line a hundred times as fast as any other reel in the world.

**Second**—It will wind up the line slowly if the angler chooses.

**Third**—No fish can ever get slack line with it.

**Fourth**—It will save more fish than any other reel.

**Fifth**—It will prevent tips, lines, and snells from being broken by large fish.

**Sixth**—The reel is manipulated entirely by the hand that holds the rod.

**Seventh**—It enables the angler and makes it desirable to use lighter tips.

# The Big Game

## OF North America

ITS HABITS, HABITAT, HAUNTS, AND CHARACTERISTICS  
HOW, WHEN, AND WHERE TO HUNT IT

A Book for the Sportsman and the Naturalist

EDITED BY

G. O. SHIELDS ("COQUINA")

AUTHOR OF "CRUISING IN THE CASCADES," "RUSTLINGS IN THE ROCKIES," "HUNTING IN THE GREAT WEST," "THE BATTLE OF THE BIG HOLE," "CAMPING AND CAMP OUTFITS," ETC.

8vo, 600 Pages, 80 Illustrations.

Cloth, \$3.50; Half Calf, \$5.00; Full Morocco, \$6.50.

### CONTENTS

- |                                                                                                                                                                                                                                                                                                                                                                                                                                                                                                                                                                                                                                                                                                                                                                                                                                                                                                                                                                                                                                 |                                                                                                                                                                                                                                                                                                                                                                                                                                                                                                                                                                                                                                                                                                                                                                                                                                                                   |
|---------------------------------------------------------------------------------------------------------------------------------------------------------------------------------------------------------------------------------------------------------------------------------------------------------------------------------------------------------------------------------------------------------------------------------------------------------------------------------------------------------------------------------------------------------------------------------------------------------------------------------------------------------------------------------------------------------------------------------------------------------------------------------------------------------------------------------------------------------------------------------------------------------------------------------------------------------------------------------------------------------------------------------|-------------------------------------------------------------------------------------------------------------------------------------------------------------------------------------------------------------------------------------------------------------------------------------------------------------------------------------------------------------------------------------------------------------------------------------------------------------------------------------------------------------------------------------------------------------------------------------------------------------------------------------------------------------------------------------------------------------------------------------------------------------------------------------------------------------------------------------------------------------------|
| <p>Introduction. By the Honorable John Dean Caton, author of "The Antelope and Deer of America," etc.</p> <p>Moose Hunting in the Rocky Mountains. Newton Hibbs ("Roxey Newton").</p> <p>Elk Hunting in the Olympic Mountains. W. A. Perry ("Sillalicum").</p> <p>The Wapiti (Poem). By "Wah-bah-mi-mi."</p> <p>The Caribou. By William P. Lett ("Algonquin") and Dr. R. B. Cantrell.</p> <p>The Mule Deer. Rev. Joshua Cooke ("Boone").</p> <p>The Mule Deer of Southern California. T. S. Van Dyke, author of "The Still Hunter," etc.</p> <p>The Columbia Black-tail Deer. Thomas G. Farrell.</p> <p>The Virginia Deer. Walter M. Wolfe ("Shoshone").</p> <p>A Deer Hunt (Poem). "Wah-bah-mi-mi."</p> <p>Hunting the Grizzly Bear. Rev. Dr. W. S. Rainsford.</p> <p>The Polar Bear. Sergt. Francis Long, of the Greely Arctic Expedition, and George S. McTavish, of the Hudson Bay Company.</p> <p>A Polar Bear Hunt.</p> <p>The Black Bear. Col. Geo. D. Alexander.</p> <p>The Buffalo. Orin Belknap ("Uncle Fuller").</p> | <p>The Musk Ox. Sergt. H. Bierdebick, of the Greely Arctic Expedition.</p> <p>Still-hunting the Antelope. Arthur W. du Bray ("Gaucho").</p> <p>Coursing the Antelope. M. E. Allison.</p> <p>The Death of Venus (Poem). Wm. P. Lett.</p> <p>The Rocky Mountain Goat. John Fannin.</p> <p>The Rocky Mountain Sheep. G. O. Shields ("Coquina").</p> <p>The Peccary. A. G. Requa.</p> <p>The Cougar, or Mountain Lion. W. A. Perry ("Sillalicum").</p> <p>The Lynx. J. C. Natrass.</p> <p>The Wild Cat. Daniel Arrowsmith ("Sangamon").</p> <p>The Wolf. Wm. P. Lett.</p> <p>The Wolverine. C. A. Cooper ("Sibyllene").</p> <p>Coon Hunting in Southern Illinois. Daniel Arrowsmith ("Sangamon").</p> <p>Fox Hunting in Virginia. Dr. M. G. Ellzey.</p> <p>Alligator Shooting in Florida. Cyrus W. Butler.</p> <p>The Ethics of Field Sports. Wm. B. Leffingwell.</p> |
|---------------------------------------------------------------------------------------------------------------------------------------------------------------------------------------------------------------------------------------------------------------------------------------------------------------------------------------------------------------------------------------------------------------------------------------------------------------------------------------------------------------------------------------------------------------------------------------------------------------------------------------------------------------------------------------------------------------------------------------------------------------------------------------------------------------------------------------------------------------------------------------------------------------------------------------------------------------------------------------------------------------------------------|-------------------------------------------------------------------------------------------------------------------------------------------------------------------------------------------------------------------------------------------------------------------------------------------------------------------------------------------------------------------------------------------------------------------------------------------------------------------------------------------------------------------------------------------------------------------------------------------------------------------------------------------------------------------------------------------------------------------------------------------------------------------------------------------------------------------------------------------------------------------|

The Hon. John Dean Caton, the eminent naturalist and jurist, author of "The Antelope and Deer of America," etc., says of this work:

"Altogether, there is given here such a study of the natural history of our game quadrupeds, and of the thrilling incidents encountered in hunting them, as has never before been offered to the reading world. Each chapter in this book is in itself a complete work, and the book, as a whole, is a most valuable library.

"Any one of the names on Mr. Shields' list of contributors should insure the sale of an entire edition of his book, and when we multiply this possibility by twenty-six, the whole number of names on his title-page, the result obtained indicates the magnitude of the success that should, and that we hope will, crown his labors and those of his collaborateurs."

"This sumptuous volume, profusely and elegantly illustrated, written by a score or more of sportsmen, is a very captivating book. No single writer could have had all the experiences here narrated. The descriptions and incidents cover every variety of large game on the continent. \* \* \* \* \* The stories are as excellent in their variety as in their quality. There are no dull chapters in the book. In fact, it may be said it is the finest collection of hunting stories ever published."—*Chicago Inter-Ocean*.

"This is one of the best and most valuable of the books as yet written or edited by Mr. Shields. It comprises a collection of intelligently written monographs on all the various kinds of big game to be found in North America, from the grizzly to the polar bear, and from the Virginia deer to the Rocky Mountain goat. Each writer speaks from his own experience, tells what he has done and seen, and recounts the often thrilling incidents he has met with in hunting. All the contributors to the volume are well-known writers on field sports and hunting, and each one writes of a species of game he has studied for years in the field, on the mountain, or in the forest."

"The paper on the Rocky Mountain sheep is by the Editor, and is a fine account of the wildest, wariest, and most difficult animal to hunt on the continent. Mr. Shields is a most enthusiastic sportsman, and moreover, wields the pen of a ready writer, as indeed all these sportsmen do, so that one follows him in his adventures with almost breathless interest.

"From beginning to end and in every chapter this book is positively fascinating."—*Chicago Herald*.

*This book will be mailed, post-paid, on receipt of price by the editor.*

G. O. SHIELDS, 19 West 24th Street, New York

Also given as a Premium for 7 Subscriptions to Recreation

# The Same Old Story

AT THE  
PENNSYLVANIA STATE SHOOT  
HELD AT  
OIL CITY, PA.

WEEK OF JULY 21-26, 1897

The Winners of all the money in the Grand Live Bird Contest used

## U.M.C. Shells and Wads

UNION METALLIC CARTRIDGE CO.

BRIDGEPORT, CONN.



IT WILL GO IN YOUR TRUNK

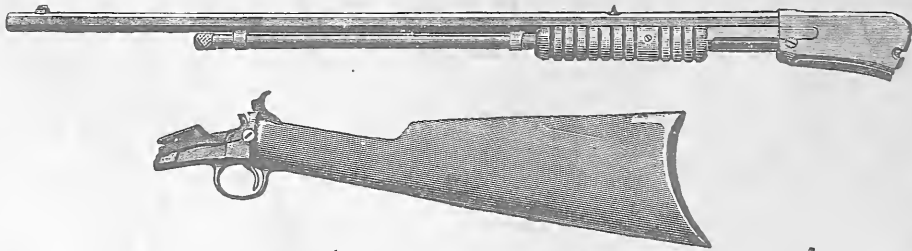

## A Winchester. 22 Caliber Repeater

JUST THE GUN TO TAKE INTO THE COUNTRY

The Winchester Model '90 is made for 22 Short, 22 Long, and 22 Winchester Rim Fire Cartridges. It can be taken apart and put together again in an instant, without any tools. Weight, 5½ lbs. List price, \$16.00. It is

**ACCURATE** ~~~~~ **LIGHT** ~~~~~ **HANDY**

**FREE** Send your name and address on a postal card and we will send you, free, our new 136-page illustrated catalogue, describing all the guns and ammunition manufactured by the

**WINGHESTER REPEATING ARMS CO., New Haven, Conn.**

STORES—312 Broadway, New York

418-420 Market Street, San Francisco, Cal.



## THERE IS NO BICYCLE

made of better material, with better labor, more experienced builders, or more careful, conservative makers, than the New Clipper. Every Clipper bicycle is made to stand up, to give satisfaction, to please its owner and producer.

## THE EQUAL OF A CLIPPER

may and can be produced in a factory of equal facilities, managed by men of equal experience and ability, with equal capital, coupled with a desire to produce nothing but the best, market it in the most economical manner, and give its trade the most possible for the money. Only about 2 per cent of the bicycle makers are doing this, but they are not selling a bicycle

## AT THE PRICE OF A CLIPPER.

MADE BY THE

**GRAND RAPIDS CYCLE CO., Grand Rapids, Mich.**

# RECREATION

OFFICIAL ORGAN OF THE AMERICAN CANOE ASSOCIATION



THREE NATIVE NEW MEXICANS  
The Central Figure is that of a Gray Wolf

PUBLISHED BY G. O. SHIELDS (COQUINA)  
19 WEST 24TH ST. NEW YORK

MAROLD BROWN

Actual Paid and Proven Circulation, 40,000 Copies a Month



**ROOT'S**  
Camel  
Hair  
Underwear



**ROOT'S**  
Camel  
Hair  
Underwear

Recommended by the highest medical authorities as the best safeguard of health in our climate. Recommended by those who have worn them as the best-fitting and most comfortable undergarments in the world.  
 Honest as old-fashioned homespun, and thoroughly tailor-made in workmanship.  
 Soft and agreeable to the most sensitive skin.  
 See that the trade-mark, "ROOT'S TIVOLI STANDARD UNDERWEAR" is on every garment before purchasing.  
 Illustrated booklet mailed free on application.  
**OFFICE. NO. 1 GREENE STREET, NEW YORK.**

**ROOT'S**  
Natural  
Wool  
Underwear



ROOT'S  
TIVOLI  
STANDARD  
UNDERWEAR  
TRADE MARK.

**ROOT'S**  
Natural  
Wool  
Underwear



ROOT'S  
TIVOLI  
STANDARD  
UNDERWEAR  
TRADE MARK.

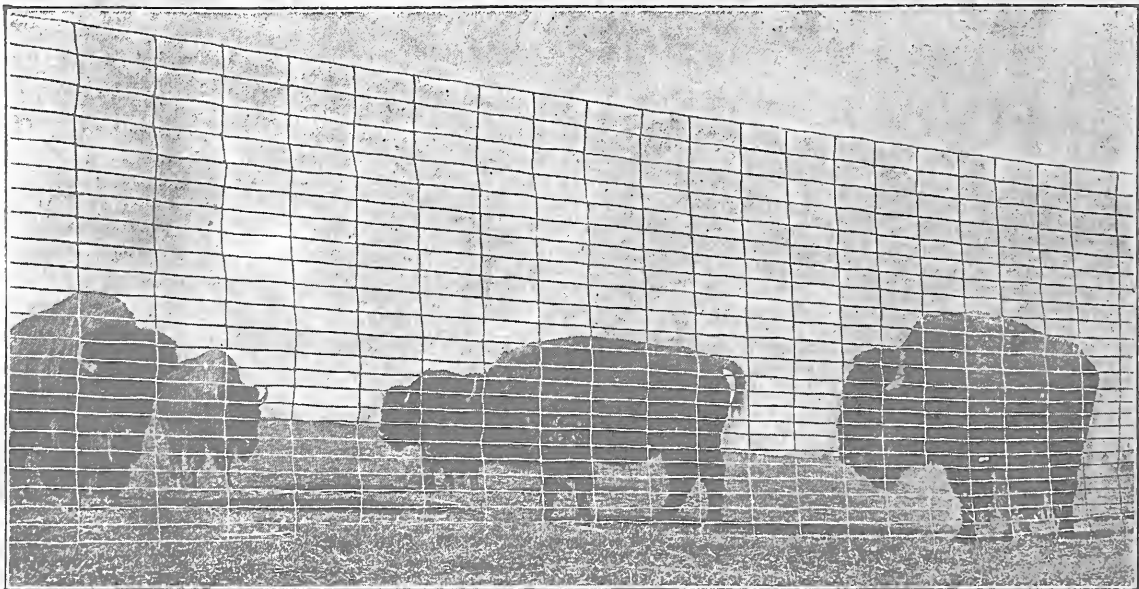

**STOP THE GAME!!! KILL THE UMPIRE?**

**NO!** Simply build a PAGE FENCE around the premises and you've got 'em. No obstruction to the view. Holds Buffalo, Deer, Elk, anything.

Write for Particulars....

**PAGE WOVEN WIRE FENCE CO.**

ADRIAN, MICH.

# RECREATION

Copyright, December, 1896, by G. O. Shields

A Monthly Magazine Devoted to Everything the Name Implies

\$1.00 A YEAR.  
10 CENTS A COPY.

G. O. SHIELDS (COQUINA),  
Editor and Manager.

19 WEST 24TH STREET,  
NEW YORK.

## CONTENTS OF THIS NUMBER

|                                                                 | PAGE                                                                          |
|-----------------------------------------------------------------|-------------------------------------------------------------------------------|
| The New Sport. Bait-Casting for Fox-Terriers.—Frontispiece..... | WILMOT TOWNSEND 255                                                           |
| The Willet. Illustrated.....                                    | G. M. MILLER 258                                                              |
| The Mongolian Pheasant. Illustrated.....                        | C. F. HOLDER 260                                                              |
| The Salmon's Rival.....                                         | J. RODEMEYER, JR. 263                                                         |
| A Day in the Adirondacks.....                                   | C. P. 265                                                                     |
| An Ideal Camp. (Poem).....                                      | RALPH D. LYDECKER 266                                                         |
| A League of American Sportsmen.....                             | W. W. BLACKWELL 269                                                           |
| Biking for Bass.....                                            | H. C. CROCKER 271                                                             |
| A Bear Hunt in the Trinity Mountains.....                       | WILL SCRIBBLER 273                                                            |
| Unknown to the Jury.....                                        | WM. GERARD CHAPMAN, JR. 277                                                   |
| A Winter Day's Sport.....                                       | DR. E. B. DAVIS 278                                                           |
| A Dry Camp.....                                                 | CAPT. C. J. CRANE 279                                                         |
| A Comanche Liar.....                                            | E. J. MYERS 281                                                               |
| On Croatan.....                                                 | BETH DAY 285                                                                  |
| Recreation. (Poem).....                                         | ERNEST SETON THOMPSON 286                                                     |
| Elkland. (Illustrated).....                                     | MARGUERITE TRACY 290                                                          |
| The Little Breakwaters.....                                     | L. L. BALES 291                                                               |
| The Copper River Country.....                                   | EDW. L. MUNSON, L. A. HUFFMAN, VIC SMITH, GEO. B. MCCLELLAN, M. P. DUNHAM 293 |
| From the Game Fields.....                                       | 298                                                                           |
| Game Notes.....                                                 | 304                                                                           |
| Fish and Fishing.....                                           | 308                                                                           |
| Guns and Ammunition.....                                        | 313                                                                           |
| Natural History.....                                            | 317                                                                           |
| Editor's Corner.....                                            | 323                                                                           |
| Puzzle Corner.....                                              | 324                                                                           |
| Bicycling.....                                                  | 325                                                                           |
| Canoeing.....                                                   | 329                                                                           |
| Publisher's Department.....                                     | 332                                                                           |
| Amateur Photography.....                                        | 335                                                                           |
| Book Notices.....                                               | XXI                                                                           |

Entered as Second-Class Matter at New York Post-Office, Oct. 17, 1894.

Reproduced from an admirable article on "Teeth," published in the  
*Pall Mall Gazette* (London), July 22, 1897.

As regards the care we take of our teeth, a lady friend of mine  
lispingly suggested that we were divided into two main classes—"soz who  
do and sozodont." I wondered that she had the

*Envoy.*

You do or you don't. She didn't. The result:  
a deformity (she lisped), a regret, an admission.  
The highest praise of Sozodont is an admission  
like this. But it doesn't do to delay. The  
moral is plain.

A sample of liquid (antiseptic) Sozodont free for the postage, three cents, if you mention this magazine and  
address P. O. Box 247, New York. HALL & RUCKEL, Proprietors, New York and London.

# GAS ENGINE & POWER CO.

and CHARLES L. SEABURY & CO., Builders of

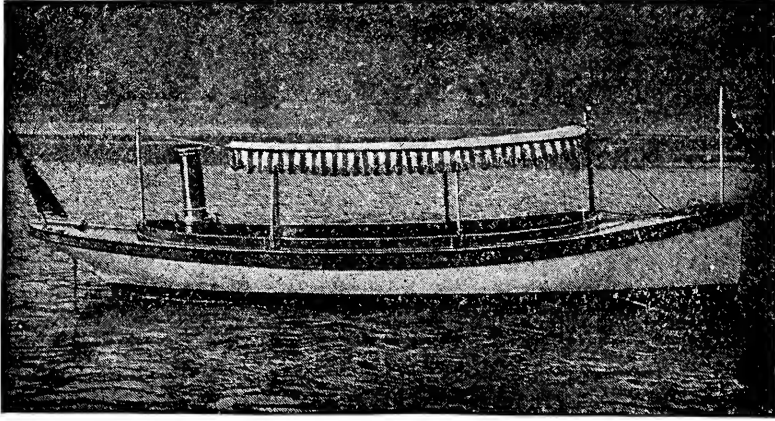

## The Only Naphtha ...Launch...

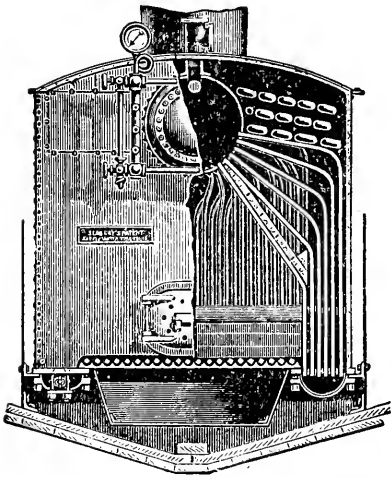

Our Patent Tubulous Boiler  
for Steam Yachts

High-class Steam Yachts  
Sail Yachts  
Electric Launches  
Dinghys  
Gigs and Yacht Tenders  
Seabury's Water Tube Boilers  
Marine Engines

Storage Basin and Ship's ways. Overhauling of  
all kinds promptly done. Charters and Insurance.  
Boats bought and sold on commission . . . .

CORRESPONDENCE  
SOLICITED . . . .

Send ten cents in stamps for catalogues to downtown office,  
50 BROADWAY, or to factory at

MORRIS HEIGHTS, New York City



# Savage Rifles for Savage Game

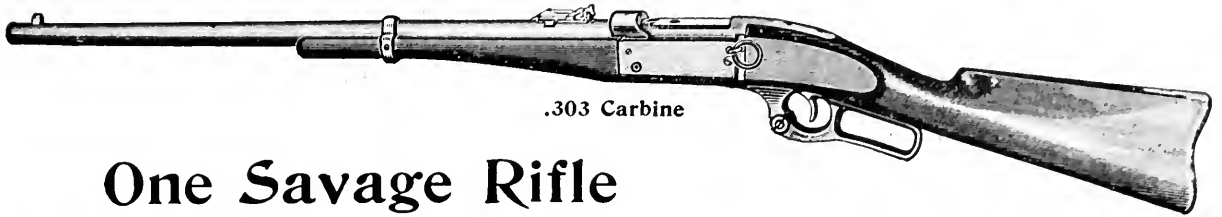

.303 Carbine

## One Savage Rifle

takes all these different cartridges without any change or adjustment

CATALOGUE ON APPLICATION



BIG GAME HUNTING



SCHUETZEN TARGET RANGES



LONG RANGE TARGETS



BLACK POWDER RANGES



SMALL GAME HUNTING



SHORT RANGE USE

HOME OFFICE  
SAVAGE REPEATING ARMS CO.  
Utica, N. Y.

PACIFIC COAST AGENCY  
BAKER & HAMILTON  
San Francisco, Cal.



## A GREAT OFFER BY GERMANIA WINE CELLARS

HAMMONDSPORT and  
RHEIMS, N. Y.

In order to introduce our goods we make the following offer, good for the next thirty days only. Upon receipt of \$5.00 we will send to any sportsman or reader of RECREATION one case of our goods containing eleven bottles of wine and one bottle of our extra fine double-distilled Grape Brandy, all first class and put up in elegant style, assorted, as follows:

- 1 Quart Bottle Grand Imperial Sec Champagne
- 1 Quart Bottle Delaware
- 1 " " Riesling
- 1 " " Tokay
- 1 " " Sweet Catawba
- 1 " " Sherry
- 1 " " Elvira
- 1 " " Niagara
- 1 " " Angellea
- 1 " " Port
- 1 " " Sweet Isabella
- 1 " " Imperial Grape Brandy

This offer is made mainly to introduce our Grand Imperial Sec Champagne and our fine double-distilled Grape Brandy, without which no Sportsman or Hunter should start on an expedition, as it is very necessary where such exercise is taken. This case of goods is offered at about one-half its actual cost and it will please us if our friends and patrons will take advantage of this and help us introduce our goods.

"Adds 50% to the relish of any meal of which it forms a part."



If your grocer cannot supply you, write us for priced catalog and souvenir, descriptive of our full line Canned Fruits, Vegetables, Meats, Preserves, Jams, Jellies, etc.

TAKE A.....

# Marlin Repeater

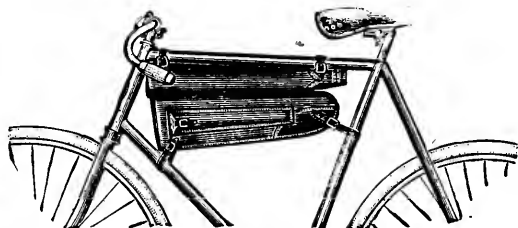

MODEL 1897

on your

## .... BICYCLE

We make it with 16-inch barrel, expressly to fit your diamond frame  
Weight only 5 lbs. We have the proper covers also.

This 22-  
Calibre  
Repeater



is  
Universally

Conceded

to  
be **THE BEST**  
**BECAUSE....**

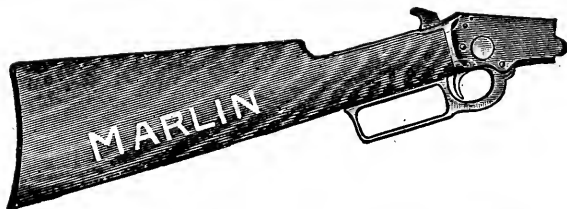

Cut Showing Rifle Apart



One rifle uses 22 short, 22 long, and 22 long rifle cartridges

The receiver is made of our "Special Smokeless Steel"

The working parts are all of crucible tool steel

The inside is finished and polished as well as the outside

The breech-bolt takes out so you can clean your barrel

The side ejection is a good thing. Ballard barrels

shoot straight

The rifling is to a rifle what choke is to a shot gun  
Good deep rifling is one reason why they shoot harder

EASY TO CLEAN

TAPER BARRELS

ADJUSTABLE SIGHTS

We will mail to any address, free, a 192-page book (just out) which is a veritable mine of information to a sportsman

Send stamps, to pay postage, to

## THE MARLIN FIRE ARMS CO.

Mention RECREATION.

New Haven, Conn.

# The Model 1893

is the rifle using the 30-30 Smokeless Cartridge. This cartridge as made for our rifle is loaded with 32 grains of Military Smokeless Powder, giving a velocity of 2,000 feet per second, a full 2,000, not 100 or so less. This, with our flat pointed bullet, makes as accurate a 30 calibre cartridge as can be loaded, and also one without a superior for hunting purposes.

## THESE ARE THE FACTORY CARTRIDGES



**Full Metal Cased Bullet**  
For Extreme Penetration

**Soft Pointed Bullet**  
(For Hunting Use)



Six grains of smokeless powder 100-grain bullet



For Short Ranges

The Barrel and Action of this rifle are made of our

## Special Smokeless Steel

guaranteed to stand the highest pressure. We also use this steel in all the rest of our Model 1893 Rifles, viz., 25-36 Smokeless, 32-40 and 38-55, and also in the Model 1895 taking the 38-56, 40 and 45 calibre cartridges. We are determined to have our rifles just as strong and safe as good material can make an arm.

Our new catalogue is a veritable encyclopaedia of information regarding rifles, ammunition, etc. Free for the asking, but stamps will help pay postage.

# THE MARLIN FIRE ARMS CO.

New Haven, Conn.

Mention RECREATION.

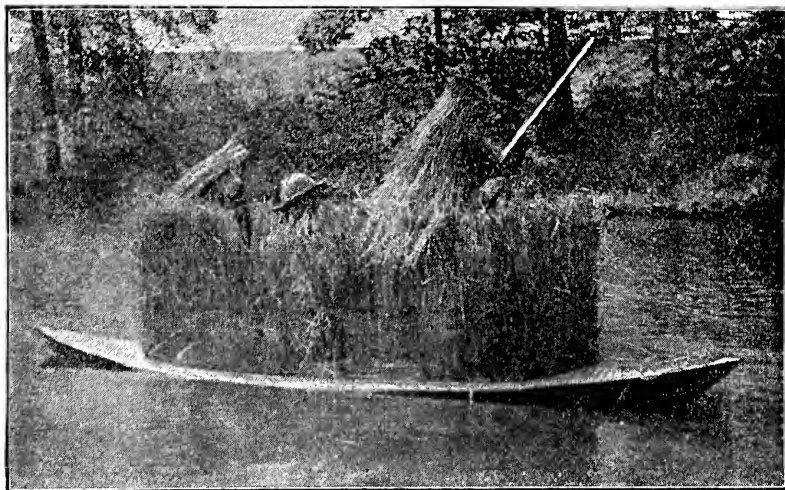

## For Your Shoot this Fall

...GET A...

# MULLINS' "GET THERE" SAFETY DUCKING BOAT

FITTED WITH GRASS BLINDS

The most complete hunting boat ever devised. We refer to any sportsman who uses same, and there are hundreds of them.

WE SHOW A FEW LETTERS  
RECEIVED, IN OUR CATALOGUE  
SEND FOR ONE...

W. H. MULLINS, 226 Depot Street  
SALEM, OHIO

# Dr. Jaeger's

Sanitary Underwear

**Fits Perfectly**

Made in all sizes, all weights, with finest possible finish.

## Women

This means for you the greatest comfort you have ever experienced, perfect freedom of limb, and the best fit possible for your dresses.

## Men

This means for you Warmth, **Comfort**, Health.

## Boys and Girls

For you it means the delicious enjoyment of out-door sports, without the fear of taking cold.

## Babies

This means for them freedom from colic and cold, and assures happiness to the mother.

Send for Illustrated Catalogue.

MAIN RETAIL STORE

16 W. 23d St.  
New York

Branches

166 Broadway  
248 West 125th St.



# DR. RAUB'S EGG WHITE SOAP

MADE WITH THE WHITES OF  
EGGS AND SWEET CREAM

## Nothing Else Like It

Soothing to face and hands; makes the skin like velvet, the ingredients being the sweetest and purest obtainable, and selected under the direction of a noted skin specialist.

Leaves a sweet, refined odor, best French perfumes being used; and, owing to its solidity, will outlast two cakes of ordinary soap.

Sold at the popular price of **10 cents** by dealers everywhere.

**FREE** sample cake to any one sending name and address and 2c. stamp for postage. Full-size cake sent on receipt of 10 cents. Send us your dealer's name, and we will see that he keeps it. Don't fail to try it.

**CHARLES F. MILLER,**  
Lancaster, Pa., U. S. A.

NEW YORK, 73 Murray St. BOSTON, 189 State St.  
PHILADELPHIA, 45 No. Front St.

A fine lot of full-winged English ring-neck

## PHEASANTS

FOR SALE

For this fall's shooting, or next year's breeders. Ready for immediate shipment for cash with order, at \$2.75 each; either sex; old or young; any number; in lots to suit.

**D. G. BLACK**  
26 Cortlandt Street  
NEW YORK

# WILLIAMS' SHAVING SOAPS

MAKE CLOUDS OF THICK CREAMY LATHER

THE ONLY KIND THAT WILL THOROUGHLY SOFTEN THE BEARD—SOOTHE AND REFRESH THE FACE—AND MAKE SHAVING A POSITIVE LUXURY.

WILLIAMS' SHAVING SOAPS—in forms best adapted to different tastes and uses, sold everywhere.



**Luxury Shaving Tablet**  
25 cents.

Round—"just fits the cup." Delicate perfume.



**"Genuine Yankee" Soap,**  
10 cents.

Oldest and most famous cake of shaving soap in the world.



**Williams' Shaving Stick**  
25 cents.



**Williams' Shaving Soap.**  
(Barbers')

This is the kind your barber should use. Exquisite also for Toilet and Bath, used in thousands of the best families. Sure cure for "chapped hands." 6 cakes in a package—40 cents. Trial sample for a 2 cent stamp.

NOTE—If your dealer fails to supply you—we mail these soaps to any address—prepaid—on receipt of price. Address

**The J. B. Williams Co., Glastonbury, Ct., U. S. A.**

LONDON: 64 GREAT RUSSELL ST., N. W., SYDNEY: 161 CLARENCE ST.

Williams' Exquisite "Jersey Cream" Toilet Soap, 15 cents.

# SCOTT'S EMULSION COD LIVER OIL



## FEED THE CHILDREN

The lean boy, the scrawny girl, may be growing like weeds, but they are thin, weak and awkward. The body cannot support the bright, active mind, and yet supply its own needs for the rapid growth.

### Scott's Emulsion of Cod-Liver Oil

with Hypophosphites of Lime and Soda gives flesh to the body, strength to the mind, and supplies the bones with just the material a growing child needs. Be sure you get SCOTT'S Emulsion.

50c. and \$1.00, all druggists.  
SCOTT & BOWNE, CHEMISTS,  
NEW YORK.



"One of the hits of the season."  
—*New York Commercial Advertiser*

"A rattling good story."  
—*Boston Herald*

"Delightful, without any mental reservations."  
—*New York Home Journal*



# THE MAN WHO BECAME A SAVAGE

A Story of Our Own Times, Our Own Country, and Borneo

BY WILLIAM T. HORNADAY

Author of

"Two Years in the Jungle," "Taxidermy and Zoological Collecting," etc.

With 16 Half-Tone Illustrations by Chas. B. Hudson

A handsome crown octavo volume, 413 pp. beautifully printed, bound in full cloth with attractive side-stamp, in olive, gold and brown. Price, postpaid, \$1.50

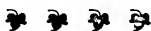

This book will please readers of RECREATION because it is a story of action, of thrilling adventures, of forest life; because it is a good, clean story. Every woman likes this book because it demands justice for women—to whom justice is often denied.

"Mr. Hornaday's book can be described only as delightful, without any mental reservations. It bubbles over with amusing speeches and situations, and from the pretty dedication to his daughter, on through its more than four hundred pages, there is not a platitude or a monotonous line. No man with this handsome volume on his table can have any justification for moodiness, while those 'addicted to hysteria and weak tea' will find themselves lifted out of their gloom by the wonderful charm of the story-telling faculty here displayed."—*New York Home Journal*.

Mr. Hornaday, the author of this book, is a frequent contributor to RECREATION and a warm supporter of the doctrines it teaches. Thus far his life work has been that of a zoologist, traveler, and business man. For five years he traveled through the West Indies, South America, Europe, India, Ceylon, and Borneo, as a collecting naturalist, studying man and nature. For eight years he was connected with the United States National Museum, and National Zoological Park, at Washington. Five years were spent in business in Buffalo. He is now director of the great Zoological Park, which is being established in New York. His published writings include four books, many papers on zoological subjects, and stories and sketches in periodicals of many kinds.

"The Man Who Became a Savage," is a book of 413 pages. It is published at \$1.50, but I have bought a large edition of it, and can furnish it to new subscribers for RECREATION, or to those who renew their subscriptions within the next few months, at fifty cents a copy, postage paid. This is an opportunity rarely offered, and I hope many readers will take advantage of it.

"Recreation" One Year, and This Book, for \$1.50



# PERMANENCE ARGUES EXCELLENCE

Established over half a century, always at the head of their craft in this country, and to-day leading the World in the extent and variety of their product, the **GORHAM COMPANY**, Silversmiths, may well point to their position as a guarantee of the **QUALITY** and **CHARACTER** of their wares.



**GORHAM M'F'G CO.**  
Silversmiths  
Broadway and 19th Street

# Genuine Siberian Moose Hunting, Golf or ABSOLUTELY WATER-PROOF TO THE TOP. Walking Shoes

**NOTHING SO GOOD EVER PRODUCED BEFORE AT ANY PRICE.**

This is a **special** line of Boots and Shoes in every way. Special water-proof leather, special anhydrous soles, special lasts of new design, special stitching, special lining, in fact, every point of shoe worth has been studied to give each special value.

The result is a shoe as strong as steel, yet, pliable and soft as kid, graceful to the eye and easy on the foot, and will outwear any two ordinary shoes.

**The leather** is the famous Siberian Moose. Costs more than any other, and guaranteed water-proof.

**The color** is a dark Russia tan, so much in vogue.

**The soles** are of the best anhydrous oak stock, made water-proof by patented process.

**The stitching** will not rip. The bottoms are hand-sewed with Barbour's extra heavy water-proof flax. The uppers are stitched and then double-stitched with pure silk.

**Bellows tongues** of the best Moose stock are used, making the shoes water-proof to the top.

**The linings** are of finest russet calfskin, adding warmth and strength.

**English Backstays, extra heavy eyelets, "Bull Dog" toes, Pratt Fasteners, etc., etc.** Every approved shoe point will be found in them. **Price to all alike, \$7.50 net.**

**We also make** a short boot, 12 inches high, at **\$8.50**; a knee boot, "Hunter's Style," lacing up the front, at **\$10.00**, and a "Cavalry Style" boot at **\$12.00**, all with the same good points as the shoes.

**Henry G.  
Squires & Son**  
20 Cortlandt St.  
N. Y.

**\$7.50**  
**net**

The cut is a photograph of our tan walking shoe after having been worn two months.

MR. G. O. SHIELDS, the editor of "Recreation," says he has some thousands of readers who *need a book* about birds, with large colored plates, and suggests that we offer to send a copy of *the only book which gives these large colored plates* to any reader **ON APPROVAL**.

We accept his suggestion, and will send a copy of "Bird Neighbors" to any reader of "Recreation" with the understanding that, if satisfactory, he is to remit us \$2.00; if not, he or she is to return the book at our expense.

# BIRD NEIGHBORS

AN INTRODUCTORY ACQUAINTANCE WITH ONE HUNDRED  
AND FIFTY BIRDS COMMONLY FOUND IN THE WOODS,  
FIELDS, AND GARDENS ABOUT OUR HOMES

By Neltje Blanchan, with an Introduction by John Burroughs  
And 50 Plates of Birds in Natural Colors



THIS BOOK MAKES THE IDENTIFICATION OF OUR  
BIRDS SIMPLE AND POSITIVE, EVEN TO THE UN-  
INITIATED THROUGH CERTAIN UNIQUE FEATURES

I. All the birds are grouped according to color, in the belief that a bird's coloring is the first and often the only characteristic noticed.

II. The descriptions are untechnical, clear, and vivid; and the fact that MR. JOHN BURROUGHS has read and annotated the book, vouches for their accuracy.

III. A supplementary chapter tells which groups of birds show preferences for certain localities, and where to look for others.

IV. A second supplementary chapter deals with family traits and characteristics.

V. By still another classification, the birds are grouped according to their season.

VI. All the popular names, by which a bird is known, are given in both the descriptions and the index.

The FIFTY colored plates are the most beautiful and accurate ever given in a moderate-priced and popular book.

What MR. BURROUGHS says of the book: "When I began the study of birds I had access to a copy of Audubon, which greatly stimulated my interest in the pursuit, but I did not have the opera glass, and I could not take Audubon with me on my walks, as the reader may this volume; and he will find these colored plates quite as helpful as those of Audubon or Wilson."

DOUBLEDAY & McCLURE CO., PUBLISHERS

141-155 East 25th Street, New York

Ride a Monarch and keep in front.

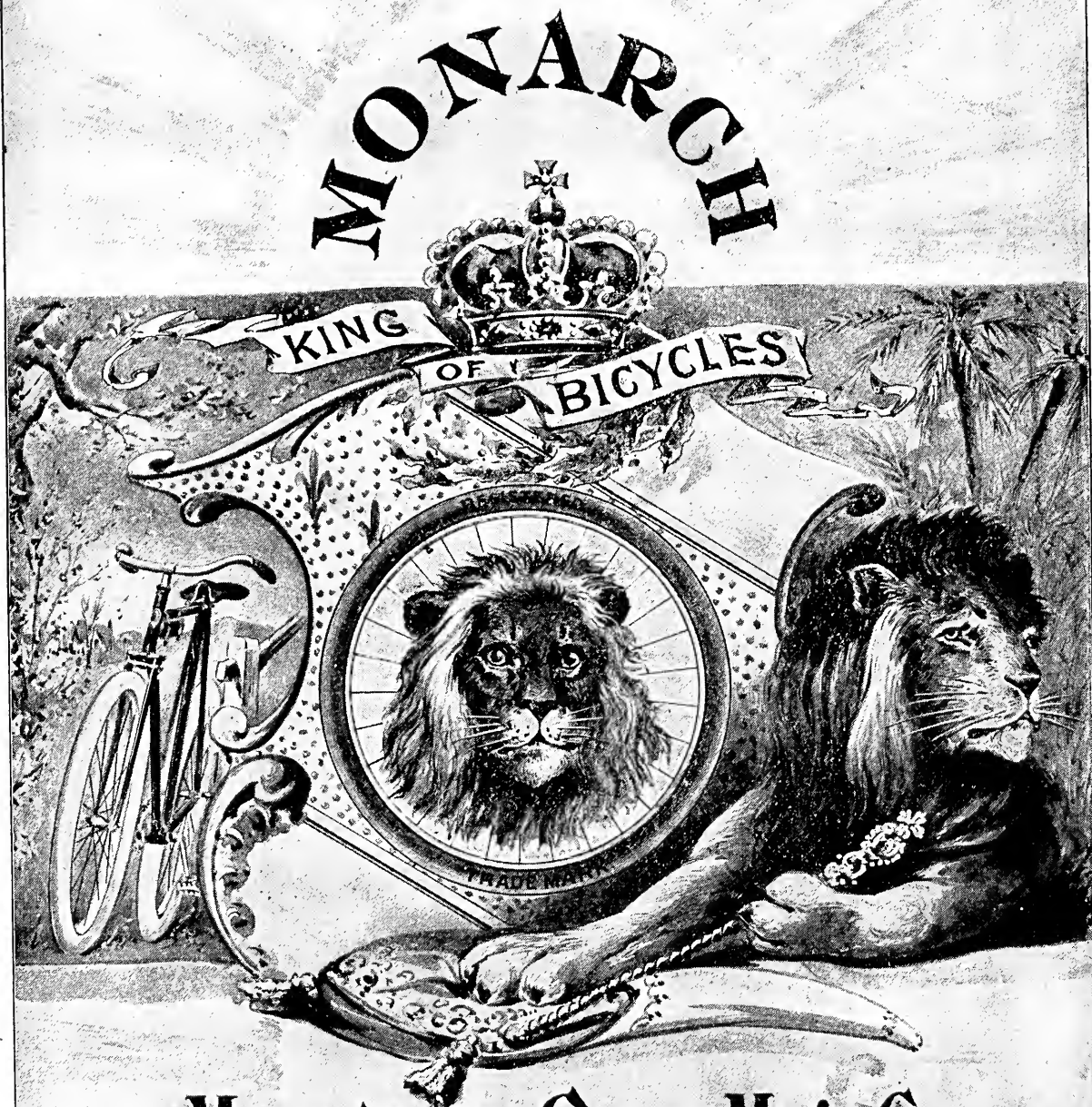

MONARCH CYCLE MFG CO.  
CHICAGO.

CHICAGO.

NEW YORK.

LONDON.

SEND FOR 40 PAGE ART CATALOGUE

# The Emerson

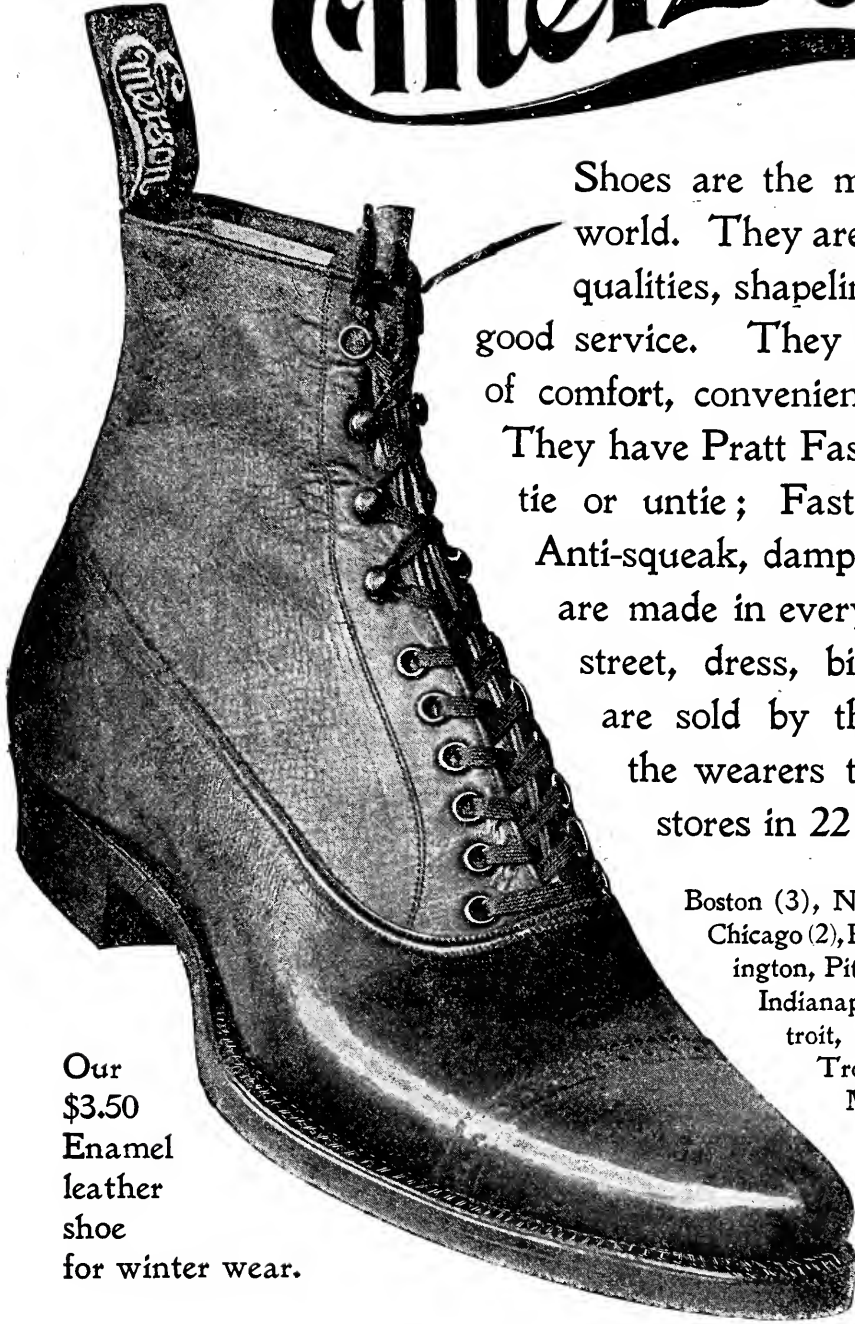

Our  
\$3.50  
Enamel  
leather  
shoe  
for winter wear.

Shoes are the most celebrated in the world. They are noted for fine fitting qualities, shapeliness, and thoroughly good service. They lead in every item of comfort, convenience, and appearance. They have Pratt Fasteners—no knots to tie or untie; Fast Color Eyelets and Anti-squeak, damp-proof soles. They are made in every style for every use, street, dress, bicycling, etc. They are sold by the makers direct to the wearers through 28 Emerson stores in 22 principal cities:

Boston (3), New York (3), Brooklyn (2), Chicago (2), Philadelphia, Baltimore, Washington, Pittsburg, Cincinnati, Louisville, Indianapolis, Cleveland, Toledo, Detroit, Buffalo, Rochester, Syracuse, Troy, Bridgeport, Conn.; Lynn, Mass.; Portland, Me.; and Providence, R. I.

The prices for Emerson shoes are, Black and Russia

Calf, \$3.00 up; Patent and Enamel leather, \$3.50 up.

If you cannot visit an Emerson store you can be supplied promptly and satisfactorily by our mail order department. Send for Catalogue R.

R. B. GROVER & CO., Makers, BROCKTON, MASS.

SEND FOR CATALOG OF

# VICTOR

## Football Goods

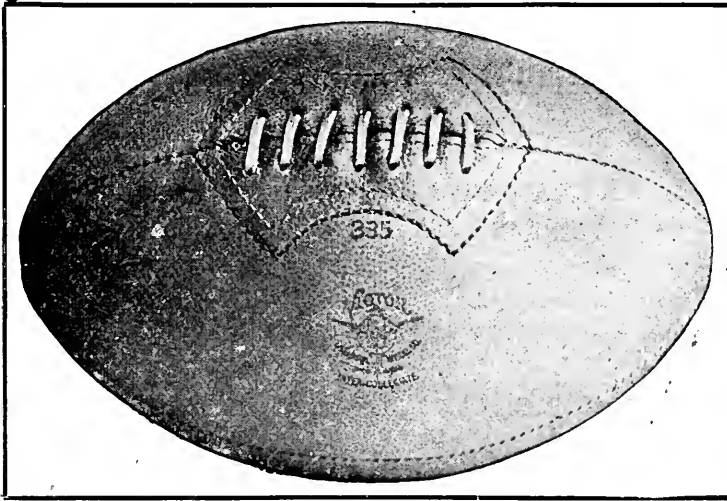

They are leaders for quality of material, fine workmanship, and improvements

We manufacture our own Football Shoes and can quote lowest prices.

## The Victor Intercollegiate Football

*Examine our new model, pointed end ball, the latest shape*

Is used and recommended by leading college players

The New Victor Face Mask and Head Protector . . . . has many advantages over the old style

Special prices for team outfits furnished on application

# Overman Wheel Co.

Makers of Victor Bicycles

New York Boston Chicago Detroit  
Denver San Francisco Portland, Ore.



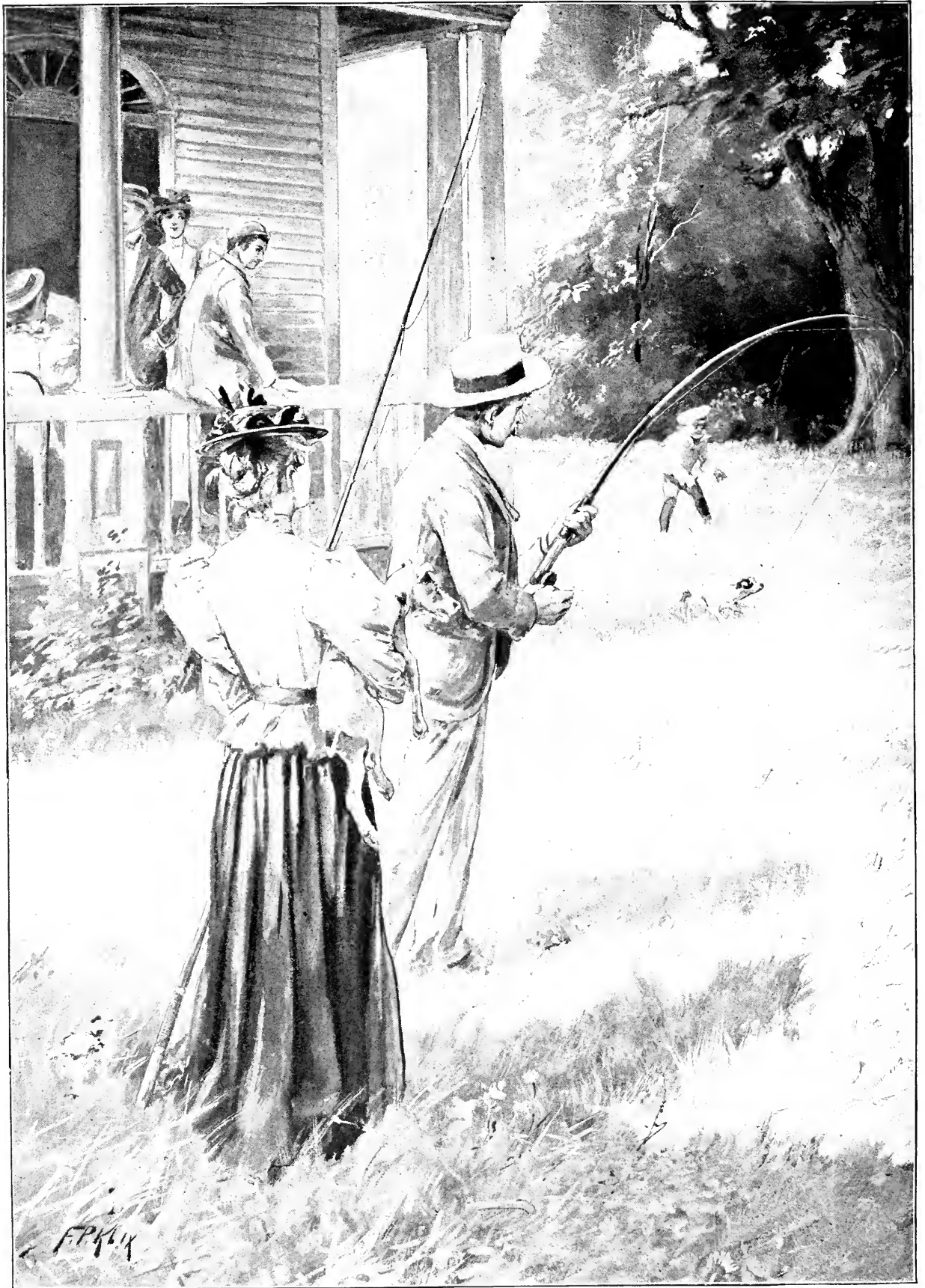

THE NEW SPORT; BAIT-CASTING FOR FOX TERRIERS.

Frontispiece.

*See page 324.*



# RECREATION.

Volume VII.

OCTOBER, 1897.

Number 4.

G. O. SHIELDS (COQUINA), Editor and Manager.

## THE WILLET (*SYMPHEMIA SEMIPALMATA*).

WILMOT TOWNSEND.

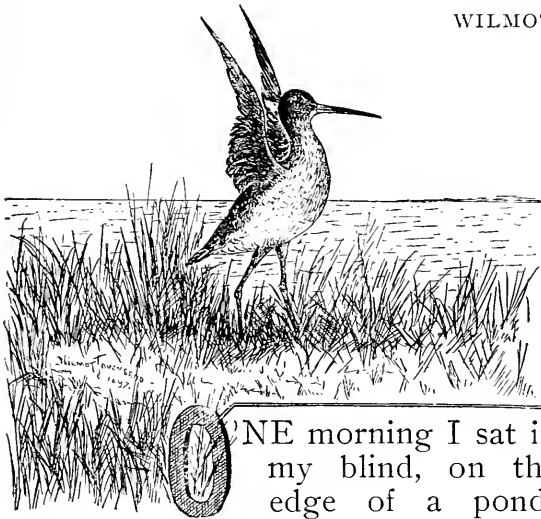

ONE morning I sat in my blind, on the edge of a pond-hole, in the salt meadows bordering the restless tides of the Virginia broadwaters.

The mellow sunlight of early spring spread its life-giving spirit in a flood of quiet beauty over the wide marsh. Here and there the tender blades of sprouting sedge-grass were already threading their way among the tangle of withered reeds and grasses, up to the balmy air and sunshine.

The heavy showers of the night had left their sparkling drops on every hand, to lend an additional freshness to the landscape. It was one of the mornings when sound travels a marvellous distance with distinctness. The voices of men and the rattle of a falling oar, on the oyster fleet, miles away, were heard with wonderful clearness. Over all spread the restful quiet of the springtide, intensified rather than disturbed by these echoes of far-away life.

The day grows, marsh life awakens to greater activity, curlews call and

sail off on the breeze toward their more Northern haunts.

Now and then the air becomes musical with the plaintive notes of dow-itch, while at intervals the free, wild, "phew-e-e" of the black-breast plover, with its peculiar inflections, rings down from the cloudless sky, with a clear, unexpected suddenness.

The birds are travelling, and soon—possibly in a day or 2—these meadows will be deserted by all save a few of the large migrants.

The meadowhen will remain, to gladden the heart of egg-hunting man, though after June 15 he must cease despoiling the nests. These birds are here in myriads, and their cackling cries fill the meadowland with noise, to an extent that must be heard to be appreciated.

Another voice strongly in evidence is that of the willet. There is a fearlessness about this fellow, at this season, charming to see. Protected from the ravages of man—his death being punished by a fine, the penalty applying also to the despoiling of his nest—he abandons himself with his whole soul to the delights of courtship and of housekeeping.

Flitting about over the dun-colored meadows, he shouts, as if in very excess of spirits, "Will-willet! will-willet! will-willet!" with a ringing emphasis on the first syllable, until the air seems to vibrate in response to his joyous mood.

He has a graceful habit of stretching

his long, pointed wings over his back as high as he can put them, directly after alighting. As there are hundreds of these birds, all about, constantly in motion it is a pretty sight to see the white-barred wings glinting over the meadow for an instant after the birds drop into the grass.

On the right of the pond-hole, where I sat, there was a short stretch of sandy beach. Directly back of this rose a tussock of tangled grass, and about this, for some distance, was scattered the flotsam of winter floods—bits of drift-wood, broken reeds and rubbish from the marsh.

On my arrival I startled a pair of willets from this spot, and after settling the blind to my notion, I investigated among the drift.

A short search revealed a tunnel among the sedge-stalks, and in this passageway was the nest—a slight depression in the ground. It contained 2 eggs, similar in marking to, but larger than, those of the meadowhen. The tunnel ran on to an exit on the farther side, under the mass of débris which formed its roof.

It was so damp, down there in the twilight among the reed stalks, I could but think of chills and fever, and wonder if the little willets, so soon to appear, would not be born with “that tired feeling” so characteristic of malarial affections.

Returning to the blind I awaited developments. Presently Mrs. W. appeared, flying low, almost brushing the grass as she circled silently about me. Twice, 3 times, she went round; but as she swung over the nest for the third time, she dropped, and vanished. Silently had she come, and as silently disappeared. It was actually “spookey,” the way she managed it!

How different the action of Will! Here he comes, sailing along, noisy as usual. Pitching on the little strip of sandy beach, he touches his wings

above his back, making a graceful bow with his head, as though in salute.

For a time he stood motionless, with head erect, and every sense on the alert. Then, evidently satisfied with himself and his surroundings, he strode, with much dignity, back and forth, as if doing sentinel duty.

Then began one of the prettiest little scenes of domestic bliss I have ever seen among my feathered friends.

After parading back and forth for several minutes, the little fellow turned his head toward the spot (not 10 feet away) where he knew his wife was brooding. He hesitated for an instant and then continued his walk up and down. Presently I heard a single note, so soft, so liquid and so tender, I could hardly believe him capable of voicing it: but yes! he halts, and again it floats on the air.

“Are you there, old lady?” it seemed to say. Whether she replied, I cannot say; but he evidently felt she heard him, for now he stands facing toward her, and in a series of musical notes, flutes his love messages to the little wife in the sedge. Like a good Moslem, he bowed toward his Mecca while he told his love.

\* \* \*

No, sir! I did not get a bird; and as I went back to the yacht, in the golden sunshine, I was happy beyond measure at having witnessed this pretty little love passage between the willets.

Later, as I sat on deck with my pipe, the cackle of the meadowhens filled the air; and once I heard the hoarse, salty laugh of a gulf gull, or skimmer, as he passed on noiseless wing, his dark form sweeping across the path of moonlight which silvered the water astern: but my thoughts were away yonder in the darkness of the marshland, and they wandered to the little nest among the sedge-grass. Then once again I seemed to hear Will say, “Are you there, old lady?”



AMATEUR PHOTO BY WALTER BLACKBURN.

A YOUNG ENTHUSIAST.

Scene on Esopus Creek, Shokan, Ulster Co., N. Y.  
This boy was fishing for what he called California trout—probably meaning rainbow trout.



THE RESULT OF TWO HOURS SHOOTING, LANE CO., OREGON.

### THE MONGOLIAN PHEASANT.

Eugene, Ore.

Editor RECREATION: This bird, introduced into Oregon about 20 years ago, from China, by Judge O. N. Denny, has multiplied until, in the prairie sections of western Oregon, it outnumbers any other game bird. The reason of the great increase probably lies in the fact that it hatches 2 broods, of 16 to 20, each season. When the chicks are about 3 weeks old the hen turns the family over to the care of the cock, she laying again. The cock is not a Mormon, in any sense of the word. He selects one hen, and "forsaking all others cleaves unto her." Hence, to breed these birds successfully it is essential that a cock be provided for each hen.

The Mongolian pheasant is a prairie bird and is seldom found in or about the timber. He likes the tall grass, ferns, wheat stubbles and low bushes, such as the wild rose and the buckbrush. After the young birds reach full growth, they do not congregate in large flocks, as do the prairie chickens, but are found alone, in pairs, or in small flocks of 5 or 6. They feed on grain, insects and green vegetables, such as red clover, cabbage, etc. These birds are great favorites with sportsmen. The magnificent

plumage of the cock almost rivals that of pea-fowl in beauty. His prevailing colors are gold and bronze, with touches of black. He also has a clear white ring about the neck. The head, and upper half of the neck, has a bluish green or changeable shade, similar to that of the mallard duck.

The pheasant gives out a stronger scent than the blue grouse or the prairie chicken, and lies better to the dog. During the open season, September 1st to December 1st, an hour's drive in any direction, from Eugene, will bring one into the shooting grounds. The law limits a shooter to 20 birds each day; but this number is often killed in a few hours. The accompanying picture shows the result of 2 hours' sport, within an hour's drive from Eugene.

With suitable enclosures and a reasonable amount of patience, these birds can be successfully propagated anywhere if the climate be not too severe. They cannot be tamed or domesticated. After months of captivity, they are as wild as when first taken. They are "game" first, last and all the time.

The flesh of the Mongolian pheasant is almost as white as that of the domestic chicken, and has a pronounced "gamey" flavor, much appreciated by all lovers of wild meat.

G. M. Miller.

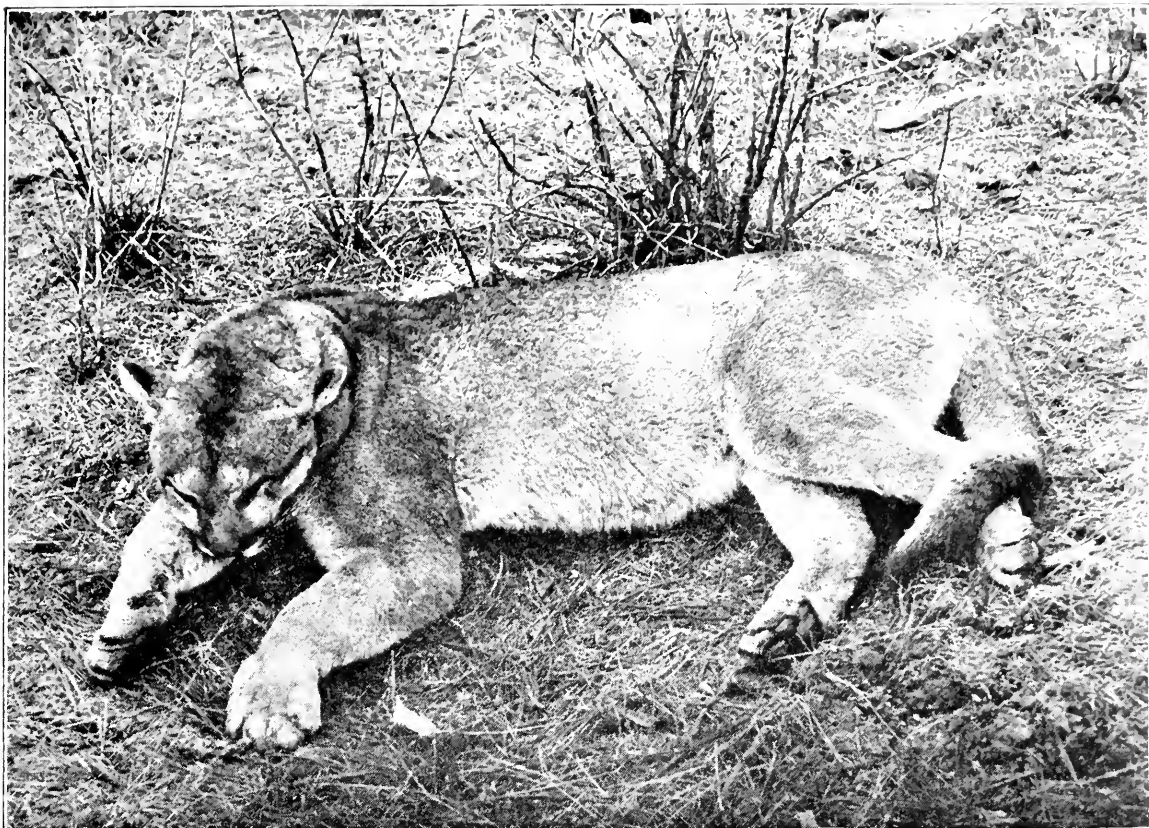

COPYRIGHT, 1897, BY WRIGHT & CARLIN.

COUGAR, KILLED WITH 25 CALIBRE RIFLE.

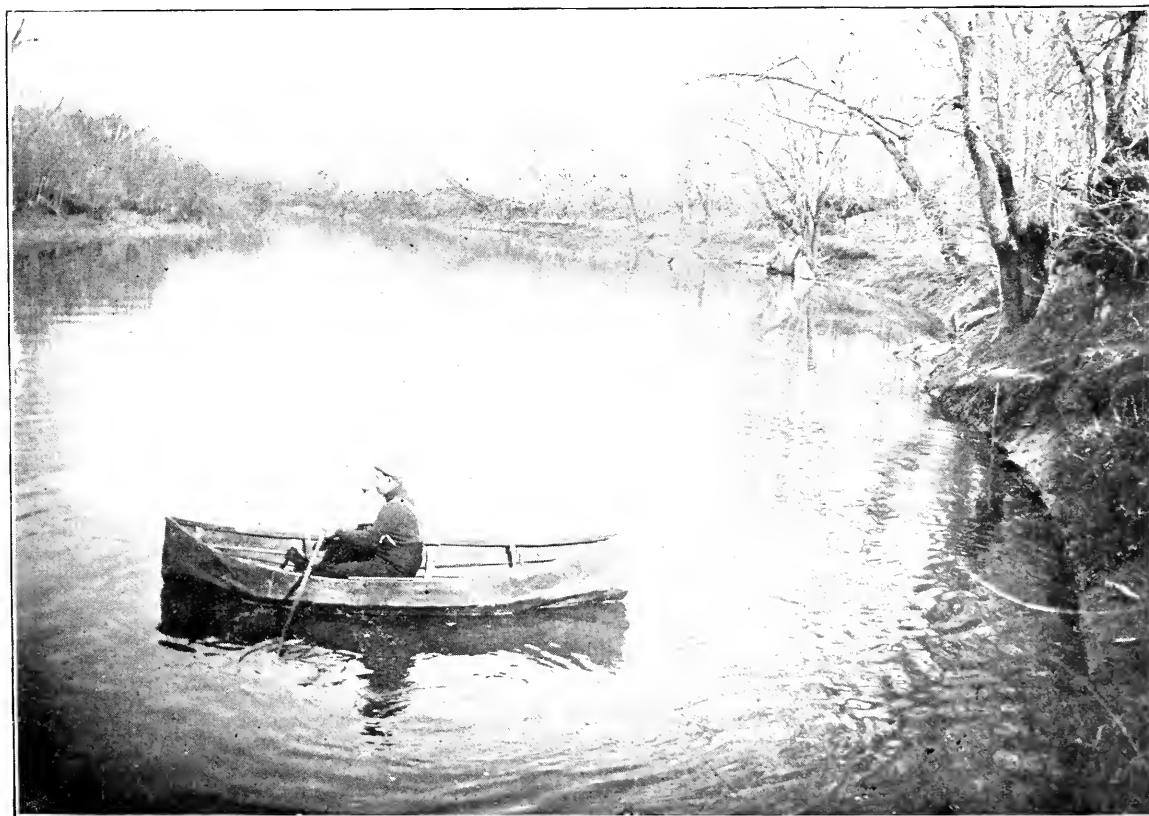

AMATEUR PHOTO BY FRANK. C. PEARRE.

SOLID COMFORT.

Awarded Nineteenth Prize in RECREATION'S Second Annual Photo Competition.

## THE SALMON'S RIVAL.

C. F. HOLDER.

It is singular that little is known in the East as to Southern California fishing; for here we have some fine game fish. In this paper I wish to present to the reader the amber fish, or white salmon;\* a fish quite up to the salmon as a fighter, and, by many anglers, preferred to it.

I first saw the fish at Santa Catalina island, 5 or 6 years ago, when, I believe, there was not a rod nor a reel on the island. I had heard of the amber fish, but had never caught one; though its cousin, the yellow-tail, of the Gulf of Mexico, I had often taken.

I was sitting on the hotel piazza one day, when suddenly the little bay, usually quiet, was disturbed as though a volcano was beneath it. Waves of foam appeared here and there, the water fairly boiling.

"Fish! amber-fish! white salmon! yellow-tail!" and other cries broke forth on the street, and the whole town went mad. Men rushed from stores, tents and houses; others looked out of the hotel windows for a moment, then ran down to the beach, shouting for lines and boats. In less than 10 minutes the wharf and shore were lined with fishermen; while 40 or 50 boats were being pushed off.

The amber-fish had "sot in," as an old boatman expressed it, and were feeding on small fry, chasing them in-shore and almost on to the sands. At the first alarm I ran to the beach, and, with a friend, pushed off.

We were equipped with hand-lines of about the thickness of a cod-line, or what I have used in the East, with Abby and Imbry hooks, with a piano wire attachment. Two lines were soon out, baited with 4-inch sardines. As I looked into the water I could see large fish, 3 to 4 feet long, that looked like salmon, darting here and there, as quickly as flashes of light. In a moment the hooks were taken, and the sport commenced. We soon landed a fish

---

\* "The 'Amber-fish' or 'White Salmon' of the waters about the Santa Barbara islands, is a *Carangoid* fish, belonging in the same family with the Pilot-fishes and the Pompano. In the books it is called *Seriola dorsalis*, Gill. It reaches a length of 4 to 5 feet and a weight of 30 to 40 pounds. Individuals of less than 15 pounds are seldom seen.

"It ranges from Cape San Lucas Northward, beyond the Santa Barbara islands, where it is found in great numbers during spawning season, from July to early fall. Perhaps about the middle of August is the height of its spawning.

"It feeds on squids and such small fish as the anchovy.  
"It is an excellent game fish, caught chiefly by trolling. As a fresh fish it takes high rank, although large ones are apt to be coarse and tough. When salted and dried it is inferior to no other fish on the California coast, even equalling the white-fish and the barracuda. About the Santa Barbara islands it is called 'Amber-fish,' 'White Salmon,' 'Yellow-tail,' and 'Cavasina.'"—Jordan & Evermann.

on each line. I do not intend to dwell on this fishing for it was too tame, but merely to say the boats roamed up and down the bay, the fishermen hauling in the magnificent fish, weighing 10 to 40 pounds, about as fast as they could work; while the people on the beach had their share of the sport too.

I had a good 16-ounce bass-rod, used in the East, and I determined to try it with these fish. The following year I took it with me to the island. Several other anglers had also taken their rods. Now no one but the station fishermen thinks of taking this fine fish with hand-lines.

Opinions differ as to rods, but the majority of anglers use a 16-ounce split-bamboo, a reel that will hold 500 or 600 feet of Nos. 15, 18 or 21 cuttyhunk, and a cod-hook with a long piano wire leader, with several swivels. For bait, a 4 or 5-inch sardine is used. I think the ideal equipment would be a split-bamboo, in weight a little heavier than a black-bass rod, with a silk salmon-line: the only trouble being that silk rots in salt water.

I recommend a tarpon reel, one to hold 500 or 600 feet of 21-strand line. It should be a multiplier and have a click or brake, and a leather brake as well, that can be pressed against the line. The angler also needs a leather belt with a butt-receiver, or cone, in which the rod can be secured. I would suggest gloves, or leather tips for the fingers.

With an equipment something like this, and a No. 18 line, I started out one day. The oarsman rowed along shore, in the deep shadows of the island. Here and there the water was colored with vast shoals of fish: yellow-tail, barracuda, white sea-bass—beauties, weighing 5 to 50 pounds; while off in deeper water the albicore and tuna were chasing flying-fish and playing havoc with small fry.

We had gone perhaps a mile when my line started out with a rush, and the reel screeched a sharp staccato note. I had out 100 feet of line, and 100 more went before I began to check the fish. It required great care to prevent a total wreck of rod, reel and line.

It was nearly 20 minutes before I could make any appreciable gain: the yellow-tail coming in faster than I could reel; darting out like an arrow; then sulking at the bottom, to dart again to the surface, as gamey a fish as ever took a bait.

In half an hour I had him alongside, within reach of the gaff, but even then he was so powerful and desperate that it required repeated attempts to gaff him. With a huge

splash he was jerked into the boat, 28 pounds of silver-and-gold, the finest fish and the best fighter I had ever caught. He was about 4 feet long; tail a light yellow, with a yellow stripe along the median line; the upper part a beautiful silvery-green; the belly, pure white.

The yellow-tail vary much in game qualities. The largest I ever saw weighed 45 pounds, but they range up to 60. The smaller, 25, 20 or 18 pounds, often make a more vigorous fight.

The white salmon or *Seriola dorsalis*, is now the fish at Santa Catalina. Almost every day during the season fine catches are brought in. However, as becomes a game fish, he is fickle. I have rowed over schools when the water was tinted by them for acres, and where thousands were swimming along in plain view, not 5 feet from the surface. Yet not one would take the

bait. On other days, numbers could be taken in a few hours. I have fished every day for a week without catching an amber-fish, while some one else, flushed with excitement and full of stories of rare battles, would come in with a good catch.

It has been my good fortune to catch nearly every kind of game fish of the country, but for real sport, commend me to a 25-pound amber-fish in fighting trim.

Some idea of the power of the fish can be had from the following incident: In trolling from a naphtha launch one day, I had a strike, and, though the launch was stopped almost instantly, 300 feet of line had been whirled off before I knew what was happening. Nothing could stop the fish; line and tip went by the board and a badly damaged reel told the story. When an amber-fish is struck, sport good and true, is sure to follow.



AMATEUR PHOTO BY A. C. WILMERDING.

AUTUMN FRUIT.



AT THE CARRY; AN INCIDENT OF THE MAINE WOODS.



## A DAY IN THE ADIRONDACKS.

J. RODEMEYER, JR.

On the morning of the 10th our party met at First Pond, about 3 miles from Baker's Mills, in the township of North Creek, in the Adirondacks. There were Dr. Ross, his brothers Ellsworth, Taylor, and David Ross, Charlie Baker and I.

I was in the mountains for rest and ozone, and had no intention of posing as a deer slayer. However the desire to participate in the sport, merely as an experience, came upon me through association with these enthusiastic Nimrods, and shortly before the hunt, Dr. Ross had taken me out behind the barn and had instructed me as to which end of the gun was the more dangerous. After a brief season of practice and a liberal expenditure of ammunition, I became sufficiently skillful to hit the barn almost every time, at 30 paces.

We had secured the services of 2 guides, Ike Davis and Frank Warren, both well learned in wood-craft, and unerring rifle shots. Ike carried a gun that might well figure in the waking scene of Rip Van Winkle—a dilapidated weapon, split, dented and twisted, and sadly in need of "a new stock, lock and barrel." But this gun always spoke to some purpose.

"It'll shewt an' b'gravy, that's all I want it to dew," said the philosophical Ike, fondling the old stock affectionately. As the game law gives a sportsman the privilege of shooting only 2 deer in a season, Ike, who never misses his aim, would have a chance to "shewt" his old gun only twice a year if his hunting were restricted to deer alone. Yet he has developed a faculty for finding dead deer in the mountains, after he has run the limit of his "shewting" license.

First Pond is something over a mile long and is nestled at the foot of a group of mountains. At the Northern extremity, and about 10 rods from the pond, is a smaller body of water called the "Pug-hole." There I was stationed "on watch," by Ellsworth, who instructed me thus:

"Sit perfectly still. You mustn't stir so as to make the slightest noise. Don't speak, don't sneeze, don't smoke, don't breathe if you can help it. Don't read; don't do anything but just sit and wait. If the dogs start a deer, it is liable to run down here and jump into the water, to lose its scent. If you hear the hounds baying, close at hand, steady yourself, in a firm position; cock both barrels of your gun (they had equipped me with a double-barreled shotgun, while the rest all had rifles), and hold it to your shoulder in readiness to blaze away. If you shoot a deer, just hoot and

the rest of us will come and help you get it in; but unless we hear from you, or you hear from us, stay here until about 4 o'clock, then come into camp where we will all meet."

It was then about 7 o'clock in the morning, and unless I shot a deer, I was expected to sit there "like patience on a monument, smiling at grief," and endure the sting of insects and the blazing glare of the sun for 9 mortal hours! It was not long before the situation began to grow dull; then tedious and finally well-nigh unendurable. I could hear, at intervals, the far off baying of hounds, and occasionally the faint report of a rifle shot; but in view of the fact that not a deer nor a dog came anywhere near the Pug-hole that day, I began to harbor the suspicion, which is not entirely allayed, even now, that I was purposely stationed there with malice aforethought, so that I might not damage the prospects of the party's success, and yet enjoy the fond delusion that I was experiencing the pleasure of a real deer hunt. I yearned for a smoke; but beyond chewing the mouth-piece of my pipe, I remained faithful to my instructions. I had the latest RECREATION in my pocket, but remembered my orders and refrained from reading. I pinched my nose to avoid sneezing, when the water mirrored the dazzling sunshine into my eyes.

I had been sitting there, on a stump, about 4 hours, and both legs were sound asleep and snoring, when suddenly I heard the baying of hounds, apparently close at hand and drawing nearer. In an instant I was on my feet, my gun to my shoulder, and had the most pronounced case of "buck fever" ever read of. My knees were knocking together with a vigor that threatened to throw them out of joint. My hair stood on end and my eyes bulged out so they could look into each other. My gun wobbled so that while I fully expected to shoot at a deer within the next minute, I realized I could not hit the side of a mountain. To my wrought up imagination the slightest movement of a bush or a twig would have given it the aspect of a deer and I would have blazed away at it.

While I was thus posing in trembling expectancy, the sound of the dogs' baying grew fainter and receded into the distance. Thus the deer was saved. As I was preparing to seat myself for another session of monotonous waiting, I heard a chuckle just behind me, and a voice inquired, with a mildly sarcastic inflection:

"What did you expect to do—shoot a deer without cocking your gun?" Ellsworth had stolen up to see how I was obey-



AMATEUR PHOTO BY C. G. WELLS.

#### MIRROR LAKE IN THE ADIRONDACKS.

ing his orders, and had noticed, what I had entirely overlooked in my excitement, that I had neglected to raise the hammers of my gun.

It was then nearly noon and I accompanied Ellsworth back to camp, to partake of a lunch and to gloat over a 200 pound buck that had been brought down by Taylor, and a big doe that had fallen before Baker's rifle. After a brief session of jubilation I was ordered back to my "watch," but secured a commutation of the sentence and was permitted to accompany Dr. Ross, whose station was on the West side of the lake. Here I sat on a log, while Doc seated himself in the bow of a row-boat that was partly concealed in the overhanging shrubbery. Spying the corner of RECREATION protruding from my pocket, Doc borrowed the magazine and proceeded to peruse its interesting pages. I remonstrated, quoting the instructions I had received at the Pug-hole, and argued that if he insisted on reading, I would load up my pipe, for I had been hankering all day for a smoke.

"Why don't you smoke then you ——?" was his reply. After that the time passed more pleasantly. A rattle of musketry at the South end of the lake told us another deer had been jumped and we afterward learned that Dave Ross had put 2 bullets through its neck. Our turn came a little

later, when we heard the dogs coming our way, and a crashing in the forest warned us a deer was heading directly toward us. The noise increased, drew nearer, and with a splash, a large doe sprang into the water not 3 rods from us, and started to swim across the lake in a direction that would bring her squarely in front of us and present a broadside view.

"Aim for her head and shoot both barrels when I give the word," whispered Doc, who had promised me a shot. I got ready, not forgetting this time to cock my gun. The deer was about 6 rods distant and I held both barrels steadily on her head when Doc gave the word, at the same time firing his rifle. Bang; bang; bang; went our 3 reports. My first barrel had kicked me backward over the log; the second had blown all the foliage from the branches over my head, and still the gun kept on kicking, even after I was through shooting. When I got up, Doc was rowing his boat out to where the deer was floundering in the water and dyeing it red with her blood. She was hauled ashore and I held a post mortem examination, in search of buck-shot.

It was easy to locate the track of the Doctor's rifle ball, which had gone straight through the animal's heart. The head, however, was not exactly riddled with buck

shot, as I had expected to find it, but after diligent search I succeeded in finding that the wound which had undoubtedly caused the animal's death was inflicted by a single

buck shot which had plowed a little furrow across the top of the tail—not deep enough to be painful, but just deep enough to be fatal.



AMATEUR PHOTO BY E. H. ASHCRAFT.

“CURSE THAT LIMB.”

Awarded Eighteenth Prize in RECREATION'S Second Annual Photo Competition.

## AN IDEAL CAMP.

C. P.

I have in mind a cabin  
Set among the forest trees,  
And upon a sloping hillside  
Where 'twould catch the freshest breeze;  
With a clear and gentle river,  
Flowing by the door,  
And not a single settler  
For twenty miles or more.

Where the flowers upon the hillside  
Would bloom the whole year through;  
Where the grass is always green,  
Where the sky is always blue;  
Where the game is always plenty  
And the streams are full of fish,  
With a good and trusty Marlin—  
What more could sportsman wish?

Yes, a pipe and good tobacco,  
As I lie upon the grass,  
Listening to the squirrels' chatter  
And the river flowing past;  
And a copy of RECREATION  
To pass the time away.  
Then would life be full of joy—  
Be one long summer day.

## A LEAGUE OF AMERICAN SPORTSMEN.

RALPH D. LYDECKER.

When RECREATION comes I begin at the front and read it straight through, advertisements and all, and I can say, with the many hundreds who have already written you, it is the best periodical of its class.

Enclosed find \$1 for a year's subscription, to begin with the September number, and I shall never again be without RECREATION.

I have been thinking very seriously for the past 3 weeks, of an important matter and have determined to write you about it, and ask you to give it your earnest consideration. If you think well of my proposition publish it in RECREATION, and in this way place it before the sportsmen all over the land.

Here it is. One night, while reading the letters "From Game Fields," in RECREATION, I noticed that many of the writers plead for better protection of our fish and game. One gentleman writes that a certain man killed over 300 squirrels in one season, and that 2 others killed 105 quails in 10 hours. Another says: Wadleigh and Wheaton (2 fish hogs) took 120 trout in one hour; and so on.

These reports disgusted me and I quit reading, for a time, and began thinking. "Is there not," I said to myself, "some way in which this wholesale slaughter can be stopped, and the killing of game limited to a fixed quantity for each man?" Then I happened to pick up a copy of the L. A. W. Bulletin, and the idea came to me: "Why not an L. A. S.?" The bicyclists have a L. A. W.; why can't the sportsmen of America form a League of American Sportsmen, the object to be the protection of game everywhere, and to provide for an increase of it.

The more I think of this plan the more certain I feel it is feasible. What we need at first is a few good, honest, honorable sportsmen to organize the League and start the work. These should be men who would use the money, placed in their hands, in the right way; men who are heart and soul in favor of game protection, and who would do all in their power to promote such a work.

What next? Call a meeting. Get together, organize and go to work. Follow the same general plan as the L. A. W. has. Draw up a constitution, and elect a president, one or 2 vice presidents, a secretary, a treasurer, etc.

Let RECREATION, with your consent, be the official organ of the L. A. S., as the L. A. W. Bulletin is the official organ of the L. A. W. Take in every State and Territory

in the U. S. and form them into divisions, such as the Maine division, the Montana division, the New York division, etc. Instead of a chief consul, for each State and Territory, as the L. A. W. has, we would provide a State Fish and Game Warden. Under this State Warden one man should be provided for each county, whose duty would be to look after the protection of game, and the punishment of game law violators.

For instance, New Jersey has 21 counties. Then the New Jersey division of the L. A. S. would have 22 wardens—a State warden at Trenton and 21 county wardens.

For State warden I would suggest a man living in the county the Capitol is in, so as to be near the legislature. Then he could work with this body in the interest of game laws.

All wardens, of course, must be L. A. S. members. What then? Suppose a man (L. A. S. member or not) is caught by a warden, or an L. A. S. member, or any other person, violating any of the game laws. His case is reported to the Warden of the county in which the deed was committed, and it is the duty of that officer to investigate. If the man be found guilty the Warden shall prosecute and have him fined or imprisoned, or both. His name shall then be published in the official magazine, with an account of the case. Should the culprit be a member of the L. A. S. he must be expelled.

Should we organize such a League we should need large sums of money. Where are we to get it? Again, do as the L. A. W. does—charge a membership fee of say \$2.00 a year. Issue a ticket to each member, these to be numbered consecutively, as applications are received.

From whence shall we get our members? From among sportsmen and farmers, all over the United States and Canada. No true sportsman would object to paying so small a sum, annually, if it would be the means of protecting our fish and game, and increasing the supply thereof. Many farmers would join, simply from a desire to see more quails, rabbits and other game about, instead of having nothing but English sparrows, as now. We could not hope for so large a membership as the L. A. W. has; yet we can have many thousands of names on our rolls within a year.

RECREATION has a circulation of 40,000. Each copy is read by at least 4 people. This means 160,000 readers. Nearly all these are sportsmen. We should get at least half of

these—say 80,000—the first year. That would mean \$160,000 for a working fund, the first year. The majority of these members would renew at the end of the year and should bring in many thousands of new members.

With such an amount of cash at our command a great work could be done. This money would be used in securing the passage of game and fish laws, in the payment of salaries and expenses of the game wardens, etc.

Any man who can afford to spend any money at all for guns, ammunition or fishing tackle, could certainly afford to become a member of the League; for the chances for good sport would be materially improved, everywhere, by reason of its work. If we can get but a few of the right kind of men together, to organize the League, and set it going, we can then get all live sportsmen in the country to join in the good work. Each man would tell his neighbor and ask him to join, and nearly all would respond.

I have thought of many other good things the League could do, but will not mention them now. Each member would suggest ways and means, and there is simply no

limit to the amount of good such an organization could do. If the L. A. W. can force municipalities to build good roads and can compel railway companies to carry their wheels as baggage, I see no reason why such an organization as I have outlined could not compel the passage of all needed game laws, or why it could not stop the work of the fish and game hogs.

I could make many other suggestions, on this line, Mr. Editor, but think I have said enough for the present. Let us ask others for their opinions before we go farther. I hope the readers of RECREATION will all become interested and that a League of American Sportsmen may soon be organized.

This is a most excellent suggestion and I should like to have a full expression of opinion on it, from my readers. As Mr. Lydecker says, there is no reason why a powerful organization of this kind could not be effected. There are several small organizations, in various States, having similar objects in view, which could no doubt be merged into this one at the start.

Shall we have a League of American Sportsmen? Let me hear from you all.—  
EDITOR.

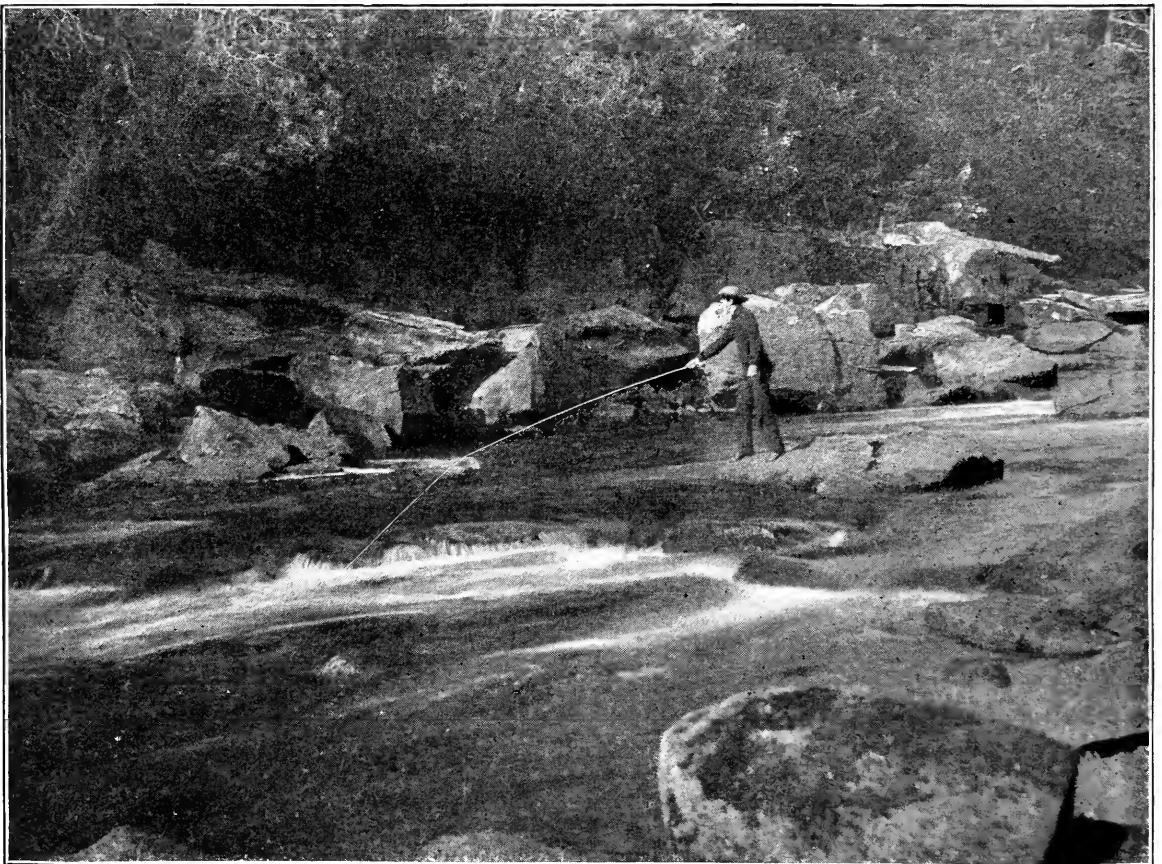

AMATEUR PHOTO BY H. L. CHRISTY.

A LATE CAST. LOWER MAGNETEWAN RIVER, ONTARIO, CANADA.  
Awarded Twenty-second Prize in RECREATION'S Second Annual Photo Competition.



### CENTRAL DIVISION, A. C. A. SAILING TROPHY

This is a new cup, lately donated by the Central Division, and cost \$250. It was made by the Gorham Company of this city, is 16½ inches high, is made of bronze, red copper, and silver. The first race, for this trophy, was sailed at the '97 meet, at Grand Stone Island, which was won by J. R. Stewart, of Rochester.

## BIKING FOR BASS.

W. W. BLACKWELL.

A short ride brought us to the Au Sable river, in Middlesex County, Michigan. Our first care was to search for a hiding place for our bicycles. A spot was found in a clump of haw trees, close to the river's edge.

We then unstrapped our rods, and discussed the subject of bait. The Major favored fly fishing, but Pete wanted to try grasshoppers and these were also my choice. A few minutes later I was interrupted, while catching grasshoppers, by Pete's voice.

"Major," he said, "give me a handful of 'hoppers. This reel won't work, and you chaps will be ready before I am." I listened for the reply, expecting to hear the Major offer some cheap advice about catching grasshoppers, but he did not.

"Well, I guess I can spare a few; hold your pocket ready."

As the Major is not noted for such disinterested generosity, I suspected a trick. He took a handful of the insects and moved as if to put them into Pete's pocket; but instead of doing so, dropped them between the belt and the sweater. Intense confusion followed, for however useful grasshoppers may be for fishing, they are not desirable to have inside one's bloomers.

When the excitement died away and the air had lost some of its azure tint, I brought my companions together and got them reconciled. Leaving them at the "swimming hole," I went on to where the weeds nearly met in the middle of the river. Here I made a careful cast and dropped the bait in the centre of the clear space. There was a ripple, then a tiny splash, a tightening of the line, and with a rush the fish darted into the weeds. Likewise a part of my line.

I was disappointed, but not discouraged. Another cast was tried. The bait skipped over the surface of the water in a fair imitation of the natural hopper. Soon there was a commotion among the weeds, and the line again tightened. A deft pressure on the rod, and the fish headed for open water. After a few minutes of careful playing, the landing-net encircled him. He was a small mouth and weighed 36 ounces. In 10 minutes 3 more were in my creel. As I landed the fourth, my companions came with a pike, a pickerel and 2 bass.

Pete told of a big hole, a quarter of a mile farther down, so deep he could not touch bottom with his rod. So we decided to investigate. It did look like a good place for pike and bass. An old log in the centre of the river, 2 feet below the surface, was a fine lurking place for big ones. I made a careful cast at the edge of the hole,

but without reward. Then I tried it again with no better result. I then put on a huge blue-bottle fly, but that was no better. In sheer desperation I put on a big butterfly and made another cast. A sudden swirl, a splash and whir-r-r went the reel. Off the fish went, 50 yards up stream, and I raised a blister by thumbing the reel. Then back he came, and I took in the slack. Now across the river, back again, and a frantic dash for the log. I turned the butt, and headed him off. Now to the bottom, then up for the surface, leaping 2 feet into the air, trying to shake the hook from his mouth. He doubled, twisted and darted in every direction, but could get no slack line. Gradually his struggles grew weaker, and after a few more dashes, he submitted to the landing-net. He weighed 5 pounds 7 ounces, and was the largest black bass I ever caught.

My companions now set about to capture his mate, which they believed was still in the hole. Having earned a rest, I became spectator and critic. Several kinds of bait were tried without success, until Pete used a live minnow. Scarcely had this touched the water when a big fish took it with a rush. The excitement was too much for Pete. He gave the rod a jerk and it snapped at the third joint. We recovered the broken piece, but the fish was gone.

The Major thought it had taken refuge under the log. Lying down, he peered earnestly into the water. Finally he declared he could see a fish's head protruding from under a root. He made a snare, attached this to a pole and lowered it into the water. A sudden jerk, and he shouted, "I've got him!" At the same time he hauled out a big snapping-turtle. Then the Major said it was too hot to fish; with which we agreed.

Returning to the pasture, we were within a short distance of our wheels, when an exclamation from Pete put us into a panic. A steer was running frantically across the field with a bicycle on his horns. Never did Zimmermann, in palmy days, take a wheel over a track so fast as that terrified brute took this one. His horns were through the rear wheel while the front wheel was pounding his forelegs.

The bike was only slightly injured, as yet; but just as the brute started up a hill, one of his forefeet went crashing through the other wheel. Both steer and bicycle came to the ground in a confused heap. All the accidents to which a wheel is prone happened to that one in a few seconds. By the time the animate and the inanimate were separated, we arrived on the scene. A

glance showed it was, or rather had been, Pete's wheel. I felt better, and the Major was really cheerful. He even attempted a vile pun. He said the wheel probably came over in the steerage, when it crossed the Atlantic, but it never took such a steerage trip as that before.

A withering glance from the victim checked his mirth, and when we returned

to where Pete had dropped his fish, and saw that a stray dog had lunched on his catch, the Major showed some sympathy for poor Pete.

The Major and I rode home on our wheels, but Pete had to hire a tiller of the soil to drive him, and the remains of his bike, to town. He will never again cache his silent steed in a cow pasture.



HEAD OF ELK KILLED IN OLYMPIC MOUNTAINS, WASH. SPREAD OF HORNS, 68 INCHES.  
From a photo kindly loaned by Mr. W. F. Sheard, Tacoma, Wash.

I hope you will continue to give it to the game hogs and fish hogs, good and strong. They are plentiful in this part of the country, as well as in other parts.

W. A. Baker, Hancock, Mich.



## A BEAR HUNT IN THE TRINITY MOUNTAINS.

H. C. CROCKER.

In the fall of '94 I was invited to visit my friend S—, who owns a ranch on Trinity river, high in the mountains. The ranch is in a picturesque location. The house is on the West side of the river, and faces the stream, which is bordered with beautiful meadow-land. Back of the house and on the opposite side of the river, the mountains rise abruptly and extend in every direction. Even from the highest ridges nothing but mountains can be seen. Big game is fairly abundant, in season, but I was late for deer, and had hunted hard, on the West side of the river, with little success. My friend proposed a place on the other side, one where we had camped before. This was a little flat, high on the divide between the Trinity and the Sacramento rivers.

We reached the camp late one afternoon. Unloading our packs and picketing the horses, we took a short trip up the ridge, looking for signs. Plenty of deer tracks were found, but they appeared old. Next day we hunted faithfully, but found nothing. Next morning we were out again, as soon as it was light enough to travel. Both returned to camp about 8 o'clock, without having seen fresh signs of game.

S— now proposed to break camp and return to the ranch. He would take the horses around by the trail, while I worked through to the river, on foot, following a steep, brushy canyon, down which the bear often travelled, when coming from the Sacramento river country. The canyon reaches the river about 5 miles below the ranch. Here my friend promised to meet me with a buckboard, on the opposite side of the river, toward evening.

When starting from the ranch, a pup, about 6 months old, which I thought had the "making of a good bear dog in him," followed me. As I struck out for the canyon, the pup took a notion to go with me. The descent was difficult and I had hardly started before my feet slipped and I slid on my back about 50 feet. By digging my heels into the ground and grasping the brush, I finally stopped.

For an hour I walked without seeing a track. Disgusted with my luck, I was about to work up out of the canyon to strike for the trail, when I discovered fresh bear tracks in the soft ground, on the steep slope. I followed the tracks as carefully as the ground would permit. They led through the thick brush, down toward the canyon, and the farther I went the fresher they became. There seemed to be several bears travelling together. One in particular made a very large track.

While getting through some thick brush,

I made considerable noise. Suddenly I saw a cinnamon bear climbing a pine tree, probably to see over the brush to find out what was coming. The bear, then 30 or 40 feet from the ground, saw me at once and commenced a hurried descent. It was not quick enough, however, to avoid a bullet from my 45-90 which tumbled it from the tree. The smoke prevented my getting a second shot, and when I reached the tree, I saw a pool of blood but no bear. I tracked it into a thicket, about 100 yards from the tree, and found it dead.

Although in an awkward position to skin, it was impossible to drag the bear out; so after much hard work, I got the hide off. While at work, I learned there was at least one more bear nosing around, trying to find out what was going on. Every time the second one approached, the pup growled savagely, and his hair stood up like bristles; thus giving me warning. I would then drop the knife and grab the rifle. At last the bear cleared out, without offering a shot.

The skin was loaded on my back, like a knapsack, and the legs tied together across my breast. After one of the roughest climbs I ever had, the mouth of the canyon was reached. My friend was on the opposite bank, with the buckboard, and I congratulated myself on my hard tramp being over; but the worst adventure of the day was to come.

The horse was unhitched and after taking the harness off, S— rode across the river. He led the animal alongside the rock, in the edge of the water. Then taking my rifle, he told me to get on first, and he would mount behind. Before getting on, I said, "How about this bear skin? The horse may object." He assured me she was as gentle as a kitten; that nothing would scare her.

I was not fairly on her back when she tore loose and went plunging and bucking into the river. About the 3d or 4th jump she threw me, apparently 110 feet into the air. I struck on my back in the water, my arms and legs extended gracefully heavenward. The water was about 3 feet deep, and the current swift. I did not touch bottom at all. I was carried down stream fully 20 yards before I could get a foothold; and as the bottom was a mass of slippery rocks, it was only to lose my footing and go down again. S— was badly scared, at first; for to him it looked as if I was under the horse's feet, while it was plunging frantically, trying to get away from the bearskin. When he knew I was unhurt, he laughed so I thought he would fall off the bank. I would not have shed tears if he had. It

was some minutes before he could recover his senses sufficiently to go after the horse.

The water was cold, and my teeth were chattering when I climbed out across the stream, where the buckboard was. S—— insisted on my riding, but I had had enough riding for one day, and intended to walk home, to avoid catching cold.

I told him to drive ahead and to have something warm for me on my arrival. He did have something warm; but he also had his wife and daughters, and every man on the ranch, ready to receive me. He had evidently not gotten over his laughing fit, either. The road was covered, several inches deep, with fine red dust, peculiar to some of the mountain roads in California. This dust had stuck all over my clothes, and I was a hard-looking object. The

bearskin was still in its original position, on my back, so well had it been fastened.

After a bath, a change of clothing and a good supper, I felt none the worse for my hard trip and my ducking.

My friend said he would willingly have given \$25 for an instantaneous photograph of my flight through the air, just before making that awful hole in the water. Whenever we meet now, he has something to say about "Washington crossing the Delaware not being in it with Cooley crossing the Trinity," or some such cheerful allusion to my mishap. Then he goes off into one of his laughing fits. He has not always had the laugh on me, though, and I may sometime tell about a trip when, as the Frenchman put it, "the leg was in the other boot."



AMATEUR PHOTO BY WILLIAM ALLEN.

A FEW MINUTES' REST.

Awarded Twenty-fifth Prize in RECREATION'S Second Annual Photo Competition.

I wish RECREATION came every week. I like the way you roast the game hogs, and am sorry to say there are a few in this part of the Adirondacks.

Floyd Vedder, Dolgeville, N. Y.

## UNKNOWN TO THE JURY.

WILL SCRIBBLER.

The bell in the courthouse tower aroused us at midnight, clanging a wild alarm of fire; and a glare in the South directed our hurrying footsteps toward the village outskirts where the cottage of a woman—old and poor and lone—a pensioner on the bounty of her friends for every having save life and the roof that gave shelter to her age—was wreathed in smoke and flame.

In desperate situations, requiring miracles of work and valor, men are giants; and an hour's effort at windlass and with buckets rescued the wooden walls and saved the blackened rafters.

"God be thanked!" exclaimed a man with reverend brow. "The damage is not beyond our willingness to repair. It would break old Sally's heart to lose her home."

"Where is Sally? Who has seen her?" some one asked, reminding us that in our eagerness to save the home the woman had been forgotten.

A failing search throughout the crowd was extended with dread into the house. A pitiable sight was there indeed. Life was extinct and the woman's nude and withered frame lay stretched on the floor.

"Asphyxiated?" questioned some one.

"No," said the doctor, "there is blood on her face; crushed by falling timbers perhaps." An instant later and his voice assumed a graver tone. "Gentlemen, here are wounds for which no accident is responsible. This is murder, and the cottage was fired to conceal the crime."

A groan of horror burst from the crowd, but was quickly changed to that most terrible thing—an angry roar for vengeance, when it appeared, on further examination, that outrage had preceded assault, and was the cause of all.

\* \* \*

In the gray of the dawn there was mounting of horses and the glad note of hounds in the street. There was game in the woods, to be chased, and huntsmen and dogs were keen for the cry.

A stranger at the village inn, aroused by the noise, came out as the crowd called by for his host.

"How easy you forget!" he exclaimed. "I thought from the anger evoked by the crime of last night you would leave the foxes at peace, at least for a day."

"So we will, so we will, an' we run them to earth," said the landlord, as he swung to the saddle.

In old Sallie's garden, strange place for a strike, the dogs were cast off—were driven and coaxed into the house and out in the yard, trodden to mire by the crowd of the night.

For an hour they sniffled about, per-

plexed by the maze of hundreds of footsteps; but at length there came from a grizzled old strike-dog a satisfied whine that soon changed to confident cries as he slowly untangled the trail and carried it out in the road and over the fence and into the fields. Here it lay with such strength that a dozen followers found voice to approve and proclaim.

"That will lead to his lair," said a huntsman; and there was looking to arms and tightening of girths. The chase had begun.

The breezes that blew from the South were laden with fragrance. The fields were ablaze with mystical color of millions of blossoms that, in summer, burst from the hedge rows and transform the plantations of cotton and corn into gardens of fragrance. The mocking birds sang in the thickets as brightly as though sorrow and wrong were unknown to the world.

These beauties were naught to the huntsmen who, silent and grim, followed the slow trailing hounds through the bright morning hours. Not once did their senses quicken or thrill, at sound or at sight, until long after noon-day, when something was caught in the cry of the dogs that declared the trail at each instant was more easy to follow.

An encouraging shout from the master of hounds and the horses, so long under curb, sprang forward rejoicing that at last the pack set a pace worthy to follow.

But what of the hunted? Not from fear of the pursuit, but driven by conscience his flight was begun. Many times, with regret that nothing could purge from his brain the horrible visions that rankled and seared, had he thought on the flames which had concealed his crime from the world.

Unheeded he heard the first faint cries of the hounds. He remembered that criminals are taken with dogs, and rejoiced that there could be no possible clue to his deed. Yet the chase was approaching. It drew rapidly near. "Perhaps, after all, some trace had been found." Fear lent speed to his footsteps. A wild beast indeed he plunged for shelter into the gloom of a swamp, forgetting that the suns of the summer had dried it up, and that dogs could find footing where no man can travel.

There was cheering behind him and the hounds had no voice. They were running by sight and were sure of their prey. Certainty brings madness, and madness despair. To surrender was—death! For an instant the fugitive faltered; preferring that fangs should rend him, piece-meal, rather than that, alive, he should fall into the hands of the huntsmen.

Life is sweet to the vilest; hope springs while it lasts. "Perhaps it was accident, only," that his trail had been struck in the hunting; and it was this that resolved him to heed a voice which said:

"To a tree, for your life! You'll be torn by the hounds!"

Quickly the howling pack was lashed into submission and quiet.

"Surrender, you scoundrel!" came the command, revealing that hope was a fable, mercy unknown, and transforming the trembling outcast into a stock that was sodden and senseless.

"To be fed to your dogs?" was the answer.

"Come down!" repeated the solemn command, disdainful of parley, but the wretch only tightened his grasp on the branches.

There was an ominous clicking of locks and a gleaming of steel in the sunlight.

"Mercy!" shrieked the craven; but the answer came from the guns. A thud, and a scrambling of dogs for the carcass.

"Gentlemen, justice is done; drive off the dogs. We have no wish to be butchers."

"But the wretch is not dead," said another, "a pity 'tis true, for now we are forced to hang him like Haman."

"Mercy, mercy!" again moaned the doomed. "Give me trial by law, for God's sake!"

"Mercy? Yes; the mercy you showed that defenseless old woman;" answered

the rocse-maker, adjusting the rope to the murderer's neck."

"Then, hold! This is not the place for the hanging. Take him back to the scene of his crime, there to fulfill the sternest measure of justice," demanded a voice that was heeded.

\* \* \*

After supper that night, as they were smoking together on the veranda, the stranger questioned his host concerning the chase of the morning.

"Poor sport," said the landlord; "but the doves in our dove-cotes shall not be molested!"

"Do you mean that your pigeons are troubled by foxes? But what is that light in the South? Another fire in your village? Let us go; and I hope not to find that the crime of last night is repeated."

"It were best to remain where you are," said the landlord, in accents that forbade further question and silenced reply.

\* \* \*

Where the ruins of old Sally's cottage were standing, at sun-down, there was naught but an ash-heap at day-break; and a body was found in the ruins, so blackened and charred as scarce to suggest that once it was human.

A coroner's jury viewed the remains. The verdict was simple:

"How he came to his death, at whose hands, and the name of the man are all unknown to the jury."



"CHARGE PADDY."

From a photo kindly loaned by Dr. F. D. Sanford.



AMATEUR PHOTO BY E. C. RIVERS.

#### THE TUG OF WAR.

"What's the matter with Blum? I hear that alarm clock of his go off half a dozen times between 10 at night and 10 in the morning?"

"He's troubled with insomnia, and every time the alarm sounds he can roll right over and go to sleep."—Detroit Free Press.

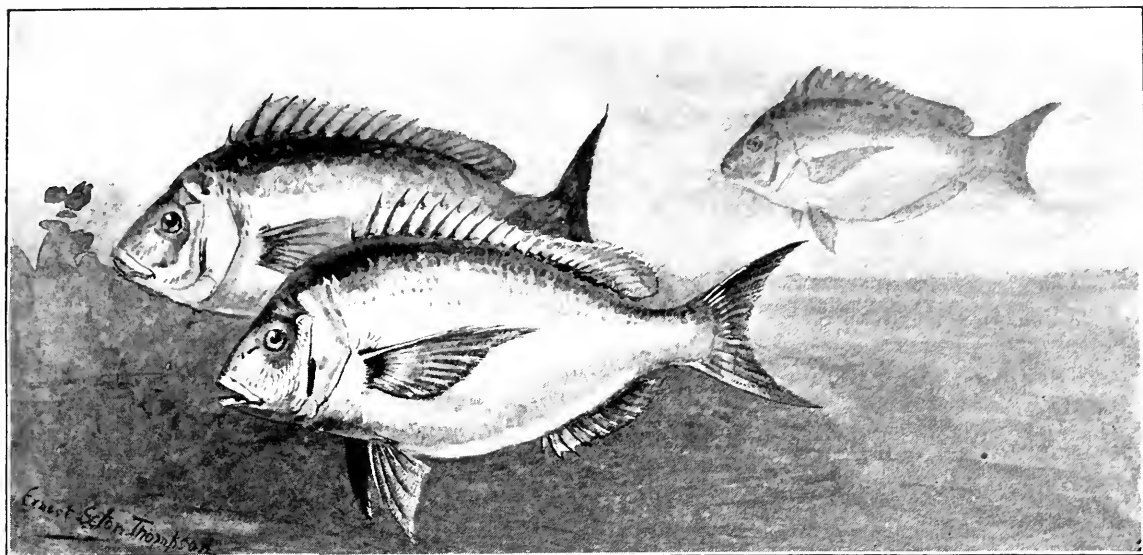

## THE SCUPPANG.

The common scup, scuppang or porgee (*Stenotomus chrysops*) is one of the Sparoid fishes and belongs in the same family with the sheepshead. It is a saltwater fish, found abundantly on our Atlantic coast, from Cape Cod to South Carolina. It attains a length of about a foot or 18 inches and a weight of 4 pounds, though the usual weight is less than 2 pounds.

This fish is somewhat erratic in its appearance on our coast. While it is usually quite abundant, it has, during some years, been excessively so; yet during other years it has appeared only in small numbers. It usually reaches the New England coast late in April or early in May, remaining throughout the summer and disappearing in October or November.

The scuppang is largely a bottom feeder, its principal food being the smaller mollusks. It will take the hook freely, and, although not regarded as a game fish, it easily occupies an important place as a delicious food fish.

The name "Scuppang" seems to be derived from "Mishcuppanog," which was the Indian name of this fish. Roger Williams speaks of it as the "mushcup, or bream," and says: "Of this fish there is abundance, which the natives dry in the sun, and smoke, and some English begin to salt. Both ways they keep all the year round, and it is hoped they may be as well accepted at the market as the cod, and better if once known."



AMATEUR PHOTO BY S. W. HOLM.

### THE FIRST LESSON.

Please send me the names and addresses of all the sportsmen of your acquaintance, in order that I may send them sample copies of RECREATION.

'Tis piping hot; but on the bough  
 The katy-did her lyre is plunkin';  
 And by that sign, six weeks from now  
 The frost will nip the golden punkin.



WAITING FOR A START.



PUT HIM OUT.



THERE HE GOES.

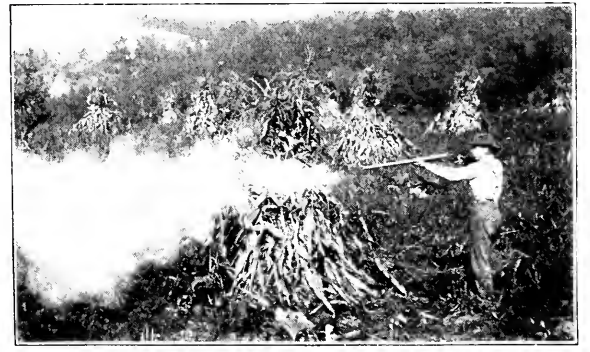

LUCKY?



GOOD DOG.

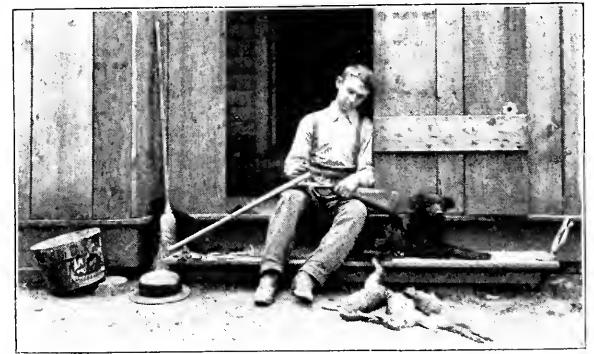

CONTENTMENT.

AMATEUR PHOTOS BY E. W. TERRASS.

I am glad to tell you that in this neighborhood, where we have not heard a Bob White for several years, they are whistling in our door yards, and a few days ago, while out botanizing, I could have caught a score of young woodcock, yet unable to fly far, and several young rabbits.

S. I. Chisholm, Salem, O.

## A WINTER DAY'S SPORT.

W. G. CHAPMAN, JR.

"I reckon there'll be a fall o' snow ter-night," said Seth, as he entered the kitchen and deposited 2 brimming pails of milk on the table. "It's kind o' still like an' warm outside; an' I saw a shootin' star drap in th' East, as I come in. It'll be a rippin' day fer rabbits termorrer, if th' snow hain't too deep," he continued as he removed his mittens, and held his hands over the stove, slowly chafing them in the grateful warmth. I knew what was coming, so I held my peace. When Seth had sufficiently warmed his hands he turned his back to the stove and spoke. "What d'yer say ter havin' a crack at 'em termorrer?"

"A crack at what?" said I, as if engrossed in something distant from rabbit shooting; though in truth my mind had been busy picturing the sport on the morrow, should the conditions be favorable.

"Why, at th' rabbits of course. Over in th' big woods there's a slew of 'em, an' in th' side-hill faller there ought ter be plenty. What d'yer say ter shootin' a few cotton-tails termorrer? Thet is, if it snows, of course."

"I'm in it," I replied. "Suppose we get our guns and ammunition ready." So Seth took from the pegs over the mantel, a long, "3-foot-in-th'-bar'l," single, muzzle-loading shotgun, a relic of antiquity; while I brought out a double-barreled hammerless, 12 gauge, which I snapped together. Getting the tools, etc., I commenced loading shells. Seth simply primed his gun anew, and after laying his flasks, caps and wads in a convenient place, drew up to the table to watch the interesting operation.

Early the next morning I anxiously drew the curtain of my window, and saw a mantle of snow covering the ground and draping the trees, the green of the firs beneath making a vivid contrast. I descended to the warm kitchen, and after Seth had completed his work, we started for the big woods, with expectant hearts.

How invigorating is a walk through the woods in the early morning! The silence was broken only by the chirping of snow-birds, the saucy chatter of defiant red squirrels, interrupted in their morning meal, and the "crunch, crunch," of our boots, as we walked along the old wood road. I appreciated the surroundings, but Seth's mind dwelt on the rabbits, for this early morning walk was an old story to him. Soon the big woods were reached. Seth being acquainted with the locality, took the leadership.

"You start in right here an' go straight till yer strike th' first gully yer come to," he ordered; "then foller thet down till yer come out of th' woods at th' South end. If

I haint there, wait fer me; fer I'm goin' ter go down along th' woods aways an' then strike in straight fer where you'll come out."

"All right," I answered; and Seth strode down along the edge of the woods, while I entered at once and walked to the gully, which was about half way across. Seth had generously given me the best ground, and I had not gone far when I came to several triangular tracks, which could not be mistaken.

Hop, hop, hop, away sailed a rabbit, as I passed a heap of brush. Flop, flop, flop, went his big ears, as he leaped over the snow toward shelter. My gun rang out and bunny rolled over and over, from the impetus of his rush. Thinking the brush-heap a likely place for more of his kind, I jumped on it once or twice, but he was the sole occupant. Another rabbit sprang away from a stump surrounded by bushes, but he did not go far before my gun bade him halt.

The gully was now right below. Knowing the bushes along the sides usually sheltered a few ruffed grouse, I held my gun in readiness. Carefully I made my way down the steep bank, until, stepping on a loose stone, I fell and slid, finally bringing up at the bottom, in the branches of a fallen tree. Two grouse started from the tree into which I slid, and swiftly flew over the opposite bank. Several more rose ahead.

Just as I had about given up all hopes of securing a grouse, 3 flushed almost under my feet. One flew straight down the gully, offering a splendid shot. Quickly the gun rose to my shoulder, and on the instant a glimpse of the bird was caught along the rib, I fired. Hurrying along, I found him under a bush, where he had fluttered; a cock grouse, full plumaged and glossy.

One more rabbit was gathered in before the increasing light in front told me the edge of the woods was at hand. Reaching the fence that bounds the clearing, I met Seth, who was awaiting me.

"What luck?" we each inquired. Seth produced 2 rabbits in answer, while I had 3 and a grouse.

"Gosh! thet's a nice patridge!" and Seth grinned in appreciation. "Now let's go over ter th' faller," and to the fallow we went.

Each now took a different course, and commenced to beat through the blackberry bushes. The fallow was thickly dotted with stumps, branches starting from their roots. Tracks criss-crossed every foot of snow and gave promise of game under the

leaves still clinging to the low bushes. The scent of wild thyme was on the air; and my mind dwelt more on the entertaining theory than on the object of my visit here.

Seth's gun startled me from my reverie. Again came the report. Looking over where the sound came from, I saw Seth holding up 2 rabbits. "Git ter work, over thar," he shouted. "Yer won't git nothin' standin' an' gazin' round like thet."

Down the hill I went, jumping 3 rabbits, and killing 2 of them. Then, following the stone wall that divided the fallow from the cultivated fields, I saw a fresh track leading into a hole among the stones. Kneeling down, I reached in and grasped the trembling occupant by the hind legs and drew him, kicking, from his retreat.

"Give 'im a fair chance!" Glancing up I saw Seth, an interested spectator.

"I intend to; here goes," and tossing the rabbit a few feet, I watched him speed away to the woods.

"Haven't we got enough game fer ter-day? Let's go hum; I'm a-gettin' hungry, haint you?" said Seth, almost with one breath.

"Yes, I'm ready to go; it's nearly 2 o'clock. How many rabbits did you shoot?"

"Five, sence I come from th' big woods; 7 altogether. How many hev you got?"

"Six, all told." Discussing the incidents of the day, we trudged homeward, across the white fields, laden with the spoils of a winter day's sport.

---

## A DRY CAMP.

DR. E. B. DAVIS.

About the middle of January last, I left Eagle camp, Catalina island, at 10 a.m., to go to Little Harbor, 6 miles distant. The trail led over high, bald ridges, and into deep canyons.

Arriving at the harbor at one o'clock, a rest of 2 hours was taken. Then began the return trip. Shortly after leaving the port my right knee began to fail—a trick it has—making walking slow and painful. The day was warm and the active exercise and profuse perspiration caused a severe thirst; and no water was to be found.

On the summits of these mountains the trails are obscure, often being crossed and re-crossed by other trails; so it requires careful watching to keep the right one. After passing over, as I thought, the last ridge, I took the plainest trail up the little valley; but the creek was dry, while that of Middle Ranch canyon had running water past Eagle camp.

I kept on for 2 hours after dark, following the trail by the faint moonlight, until it became evident I could not reach camp that night.

I was tired, wet with perspiration, and had an extremely painful knee. To add to my discomfort, a light rain began to fall, as if to mock at my intense thirst. Halting at last under 2 jack oaks, with branches reaching the ground, I soon had a fire burning, and ate the remainder of my lunch. I have a rule never to leave camp without a lunch in my pocket.

I then settled down to make a night of it. The nights are long in January, but at 6.30 it was light enough to take up the trail again. About 2 miles beyond my dry camp there was a little water in the creek. I had previously wet my parched tongue by dragging my handkerchief over the wet grass, and with one end between my teeth,

wringing out a little water. Now cup after cup was swallowed.

After going a mile farther, and still seeing no sign that the trail left the valley, while the mountains were higher and more precipitous, I resolved to take the back trail, down the creek again, even if I had to go to the Pacific ocean, to find where I had passed the cross trail. Keeping a sharp lookout, I followed down the bed of the creek, mile after mile. At 10.30 I was surprised to go plump into Eagle camp.

The letter Y will explain the cause of my dilemma. Placed thus  $\succ$ , the lower point is Eagle camp, the upper, Little Harbor. The regular trail cut across between these points. The trail I followed branched down to the stem of the Y and led to Avalon. I was none the worse for my experience.

Now I would add another rule for camp life: Never leave camp, in the West, without a canteen of water, unless you resolve to follow the banks of a river no smaller than the Missouri.

The climate of this island is perfection. The mid-winter air is soft and balmy, like our Northern June—too warm to exercise much in the sunshine. All verdure is green, including tenderfoot; flowers in full bloom, while the constant songs of mocking birds and other feathered songsters make the air melodious.

We had but 2 rainy days in 6 weeks, up to the middle of the rainy season.

Shooting and sea fishing are unexcelled; while for those who wish to camp, conveniences of water, fuel, and supplies are of the best. I would be delighted to see the thousands of over-worked business and professional men resting and recreating on this "Isle of Summer."



## A COMANCHE LIAR.

CAPT. C. J. CRANE, U. S. A.

From January 2, 1881, to June 3, 1888, I served most of the time at Fort Sill, in the country of the Kiowas and Comanches. Among other duties, I had charge of 10 Indian scouts—5 Kiowas and the same number of Comanches. I was assisted in managing them by the interpreter, Horace P. Jones. The best scout and the greatest liar among them was Comanche George, a man about 45 years old. During my stay at Sill there were usually 2 troops of cavalry there, and my scouts acted as their scouts and guides.

In 1886 1st Lieut. George A. Dodd, 3d Cavalry, commanded his troop on a scout along the Washita river, North of Sill, and Comanche George was with him. George was a hard rider, and, like most Indians, neglected his horse. On this trip he had only one pony, and his hard riding and neglect so reduced the strength of the animal that, in a fit of rage at not being able to get better work out of him, George shot the poor thing. Jones promptly told me about it.

George, on his return to the post, lost no time in making his appearance at the Adjutant's office, to give a good excuse for his

brutality, in order to escape punishment. This is his story, though not quite in his language.

"I was up Washita river with Lieutenant Dodd's white soldiers. One night I was sleeping and saw my father and mother (both dead many years). They were mighty hungry and poor; nothing to eat, no clothes, no pony, no blanket, nothing. They begged me to be a good son and send them a pony to ride. I told them I had only one horse and had to ride him on a long scout; but they said I could get others and they couldn't. They looked so poor and begged so hard, I promised to kill my pony next day and send him to them. I shot my good horse and gave him to my poor old father and mother."

George's story was told with all the earnestness that usually accompanies a lie. He knew I was aware of the Comanche custom of destroying property and killing domestic animals over a warrior's grave, in the superstitious belief that these things and animals go with him for his use in the hereafter. I credited the Comanche tribe with possibly another superstition, and George was not punished.



AMATEUR PHOTO BY W. C. MOTTERAM.

PUTTING THE SHOT.



A MAMMOTH PAIR OF ANTLERS.

From a photo kindly loaned by Albert Friedrich, San Antonio, Tex.

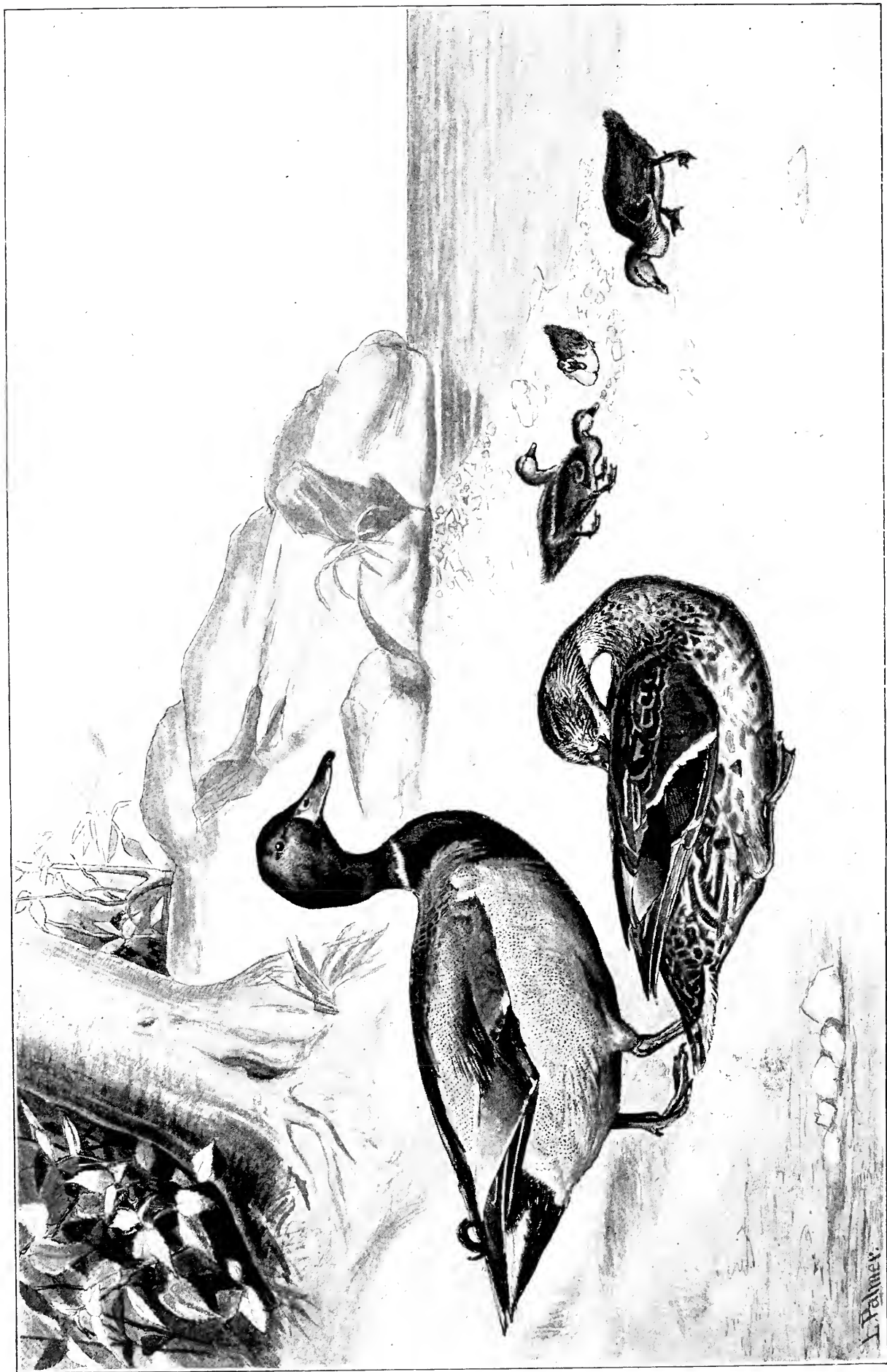

MALLARD DUCKS (*ANAS BOSCHAS*)

L. Palmer.

## ON CROATAN.

E. J. MYERS.

“Sleep—drowsy dreamers—sleep—  
Your watchfires fright away the beasts of chase ;  
All harmless round your midnight camp they pace.  
The breezes whisper and the running streams,  
All, all is well ; then peaceful be your dreams.”

The cold, damp contact—the indescribable chill of the brute muzzle—the dank point brushing my face, flashed across consciousness.

The sleeping bag held me like a trap, with my arms pinned to my sides, and it twisted around my neck clutching my throat. From my very lips downward the chill ran through my body.

On the other side of the tent the other man was sleeping; and the rifles lay on the far side; and even if it were of avail, not even a knife was handy. Would the other man hear me? Would he act without losing his head? Would that usually cool, and ready wit fail in this hour of need? In repressed but penetrating tones I called:

“Arnie! Don't move! Arnie! There is a bear in the tent. Softly. The gun is——”

“Time to get up, sah,” and Mose's voice, accompanied by a rude shake that thrust aside the curtains and let in the lamp light, awakened me and sent the shuddering scare into the illimitable.

“Yes, I'll take a cup of coffee while I dress.” Not even the familiar stateroom, the guns showing on the rack in the saloon, the glittering china on the breakfast table, wholly dissipated the creeping shudders and hideous chills of the dream as I jumped out of my berth.

Down the companionway came the call that all was ready; that it was time to be off; and breakfast, always a dispatchful meal when the day's hunt is waiting, was quickly through.

In the faint light of the lantern, I saw my way to the skiff, and jumping in, put the tiller hard down; and as the sail bellied to the wind, we shot off into the darkness—the water boiling in phosphorescent bubbles, whirls and eddies and running off into serpentine shapes, swept over the gunwales as the skiff fled before the wind.

From afar Bodie's Light, set on high like a huge Cyclopean eye, sent a stream of radiance into the darkness and the flitting, intermittent motes, breaking steady radiation, meant nothing more than the headlong flight of the wild water fowl, beating to death on the crystal prisms against whose merciless edges the birds crashed and fell headlong, a mangled bleeding mass.

Unto the ships that went up and down the waters and rounded the capes, the light was a beacon and a welcome warning;

unto the water fowl a bewitching radiance that lured them to cruel death.

Through the dim, shadowy mists that lay thick on the waters, the grays and duns were creeping in illusive forms. The boom of the surf on Hatteras' diamonds, and the shrill discordances of swan and geese on the keys, hastening laggard dawn, came up on the breeze.

Save now and then a clank of block, the straining of the mast, the splash of the waves on the cutwater, a word from the Captain as to laying the course, we sailed on; for the yacht must swing at anchor, far distant, if the shadowy clouds of red-heads, widgeons, broad-bills or brant were to flash over the battery, sweep down on the decoys or hurl themselves in the water before they discovered the deception practised on them.

In the wake the lights of the yacht had disappeared; first the green and then the red dying out; and ahead the glow of the pipes in the bow suggested faint ridiculous comparisons with the beacon flashing from Bodie's Light, dispelled by the rank odor of the smoke blown in our faces.

On and on into the darkness, the skiff sailed, until I drew my peajacket around my throat and chest to shut out the chill that ever comes with the break o' day; and to the order “Bring her up” I automatically responded as the man in the bow dropped the anchor. As the sail noisily slatted and flapped to the breeze—the angry tones of the Captain, “Reef that sail! Put out that light, you galoots! Do you know where the ducks are resting?”—made the men jump with a noisy clatter that provoked other and fresher expressions.

The blind was shoved overboard and weighted with the iron counterfeits, while all round the wooden ducks were hurled in apparently confused splashes that took rank and orderly file when the decoys, straining their anchors, began to bob up and down before the wind.

Up at the head of the battery, on a partially sunken strip, back of the gunner and out of danger, the live decoys were placed, so as to be out of range of shot, and the shells were stowed at the head of the narrow coffin-like box to be my pillow; while on either side was placed a double hammerless gun, one of 12 and the other of 10 gauge.

In the East the first faint reddish splashes and edgings were beginning to paint the margins of clouds. Yellowish chromes were building a pathway for the sun, and the world's rim was assuming form, with a great glow of pearl and red and blue.

Before the coming day, the gleaming light was fading and the white shaft on Bodie's island was betraying its existence in a gaunt grayish shape.

Noisier and shriller and echoing plaintively in the early hour were the cries of the swan, with the deeper calls of the geese forming an undertone; while the curious muffled rattle, hardly distinguishable, from the swash of the waves on the flaps of the blind and the sides of the skiff, caused Spence to sing out

"That's the red heads a-wing."

I stepped on the battery, and, with refraining good-byes, the skiff sailed away.

In the soft light between me and the East the beach was assuming form and showing the long barrier that shuts the placid waters of the sound from the turbulence of the ocean, while the gleaming stretches were the ponds and pools on the keys, reflecting the light where, later, I should shoot shore birds until the fancy shot, and not the bag, was the measure of sport.

On the other side, toward the setting sun, only the slender tapering masts of the Brant showed where the yacht swung at anchor. Afar I saw the blowy, smoky masses on the horizon's rim that at first suggested the cloud drift before a squall; but an uplifted hand, against which not even a zephyr blew its breath, told me the wind was coming from the Northwest and that the water fowl were already in motion, in the early breeze blowing out there.

When brr-brr-swrr sang around me and was gone, and while I had been standing there dreaming, the first flight of water fowl, allured by the decoys, had passed, and the first shot of the day was lost.

What is that murmur coming over the water? Now it is like the cooing of the cock-dove, or the strutful tones of the wood-pigeon, and now it is like the muffled drum of the ruffed grouse. Now it is the rush and murmur of the gale under the eaves, and around the gables; and now it is the fanning of countless wings of water fowl, beating the air, and it passes over the blind with a sough of the wind that takes a cool head, a steady hand and a quick eye to make both barrels bark in its midst, with splashes on the water rising over the roar of the gun, telling of arrested flights and hurtling plunges to death.

Now ready for another, and raising my head I saw 2 dim, hazy masses to the Southward which, in the clear atmosphere, looked like flying clouds; but they were moving against the wind, and which way would they pass—over me or far off? Not long either would it take to pass over the blind if they were moving my way. The guns were ready and I began to call the ducks with that curiously muffled rattle, made by the roll of the tongue against the roof of the mouth. Down the wind went

the sound, and on went the call. How low they were flying! I feared they would light; but onward they came, straight for the decoys, and behind me the renegade ducks were quacking and flapping their wings as if washing, and probably all knowing they were luring the flying mass to their doom.

Ready for the leap to my feet for a standing shot. The flock is coming against the wind. They will divide and rise fast—all too fast—when they see the battery. Now it is the other roll of the rattle, and "up and at 'em." Both barrels to the left, and now drop the one gun and up with the other. A quick wheel and both barrels to the right at the fleeing, frightened flock and they are gone in the distance. The right hand shot is always best saved for the right handed man. Two I certainly got; but who in that intense excitement can note how many fall, or what success follows the aim in the mental intoxication of the moment, when the glance sweeps down the barrel and the flash of the gun follows the rapid flight of the quarry fleeing from death.

Again and again, as I lay on my back, after the shot, with the glow of the sport running through me, in the soft warmth of the December sunshine, the balmy drowsiness of the Carolina noon, rocked by the motion of the waters, I forgot the quarry and the sport and let my mind drift whither it would, perversely to woodland and whence not.

From the satisfaction of repletion, backward to the hour of hunger and want, is all within the compass of an hour. The humor of both is akin. It is the sweep of thought backward to the start from New York, on the Roanoke. The old officers who were in charge of her as Patronym which, in the days of '60 had been seized by the Virginians and the name loyally changed to Patrick Henry, knew me as a boy. They also knew my forefathers. Hence they granted me the privileges of the pilot house where I got me at daylight. Then I saw the skyward flight of geese, on their way to Roanoke; and ducks and ducks and ducks—on every wave—passing over the pilot house; crossing the bows within gunshot, until it made me waver whether I were not journeying too far.

The steward served a French *déjeuner* at sunrise, and that was typical of the Old Dominion line—a synonym of vigilant warfare, comfort and pleasure of coast line travel. Eh, Llewellyn of the Roanoke!

That flock may, as fledglings, have fled from my birch bark canoe on Tchitagama waters, in the frozen North; and the brant sweeping over me may have hidden in the sedges on Paradise river, in Labrador, when the dory passed by.

Thus the morning passed until I heard the Captain call, and the skiff ranged alongside the blind.

"Well, how many shells left? The sound must be full of dead ducks," he said.

"Let's see; I'll go with you. I've enough for to-day;" and the Captain whistled. In with the blind and decoys; and before the wind we sailed to pick up the dead ducks, the Captain and I in the bow. "There's one!" "There's 2!" And down we sailed, picking up the dead, floating on the waves, the idle sport and toy of the wind beating and driving them to the leeward.

A bath and a rub down, and then I can hardly wait for my dinner. Overhead is the clank of windlass and the noisy tramp of the men getting sail on the Brant.

"White wings aloft!" The yacht must wing her flight to Roanoke, for I want to dine on terrapin, at the Club House, to-night; and on the morrow geese and swan on the II lump.

Yonder lies Kinnakeet and thither—not over a few hours' sail—is Hatteras; but our way is Northward, to the narrow stretch of waters uniting the great sounds. We are bound to the waterway under the cloudy path of the myriads of waterfowl, winging their flight down the coast edges; over the keys that run from Virginia down the Carolina coasts.

On the deck is spread the result of the morning's work, with smoothed plumage, wings folded and heads carefully arranged so that no beauty of pinion or feather may be lost when they are viewed at home in the North.

The stars are out and Bodie's Light is aflame when we pass the Southern point of Roanoke island. The little cannon booms our arrival as, a little later, we drop anchor off the Club House, which is ablaze with light.

Hello! That's curious. I didn't know of any members likely to drop down, and I rejoiced to think of good company as the lantern, on the flagstaff of the club house, returned the signal.

Telling the Captain to send my traps after me in eager haste I picked up a half dozen ducks and my favorite gun, and jumped in the dingey. I was in my gray Scotch sweater (no beauty) with an old canvas cap (no style), old shoes (a tramp's), no coat, in one hand the ducks and in the other my gun (a sight).

I threw open the door of the hall with a jolly, "Here's how to you and your feed," when astonishment struck me dumb; for around the huge fireplace, which roared and crackled with oak and pine logs ablaze, sat 3 ladies and 2 club members, who greeted me with a yell directed as much at my appearance as at the individual. Well that was the unexpected.

"Why, old man, no you don't;" and dragging me back they made me sit down and tell of the sport.

After the introduction, and before the

gossip was ended, supper, for which I had come, was announced and as we lingered, the others over the coffee and I over the indispensable cup of tea, the talk ran on.

"Bring in the dice, Bob."

"Do nothing of the sort; you can take your pick."

"Indeed, you won't. You'll take your cast."

"I'll take the III lump."

"What's the need of gambling for choice of the lumps? I'll take my chance at the III, whatever it may be."

"Well, let the girls toss the die."

Between "you first," and "I have no luck," and "you had better cast yourself," and "I'm sure I'll lose," and such ilk, the die was finally thrown.

The luck of the toss gave me the last and the tears of the tosser made amends for the probable ill luck; for II lump meant a sure bag and III meant hope, prayers and an early return; and there was only the "North lump," a long way off; and the South lump which was rarely used.

The II and I were quickly taken, with as many jibes from the guests, at my unfortunate champion, and mock congratulations to me from the others, over the rest of the labor that awaited me on the morrow.

"Well, what are you really going to do now, honestly? You had better drive over to the North lump if you want any shooting," said Jack; but I kept silent as I thought of the 12 mile ride, at midnight, and that I would have to start the decoys at once, in the skiff.

I went outside and looked at the skies, the drift of the milky way and a long, low haze in the Northwest; and the recollection of the early drift of the first tide down the sound, and the weather sayings in that regard, made a lump rise in my throat as the thought followed desire.

"Is that you, Spence?"

"Yes, sir; I have your traps."

"Wait; 2 lumps are gone, and I don't want to ride to Uncle Bill Basnight's this evening."

Spence gave a low whistle, probably reflecting on a change of my mind in anticipation of the mellow scuppernong wine, that outrivals Yquem, and the ripe yams that savor of the South Sea isles, to be had over at Uncle Bill's, both of which I worshiped equally with Spence. "No; I think—I'm looking at that haze." And Spence's laugh breaking out almost betrayed us as the voices from the inside called me to come in.

"Well, well, now old wiseone, what's up?"

"Only the South Hole for me," I answered. Such derisive laughter; such sarcasm and banter as I had to bear; for all knew what a forlorn chance I had unless it blew half a gale, banking up the water against the keys.

But I had some compensation when we went into the cold room to look at the morning shooting: for this time there was pleasure in listening to the comments.

Telling the steward to give Spence the lunch for to-morrow, an early call, breakfast and start, I bade all good-night and went to snatch a few hours' rest.

South Hole was an accident and a discovery. Only a knot of sand rising out of the waters, 2 rods from the long outer key, or ridge of sand, where, tired of buffeting against the storm, Spence had one day pulled up the skiff to wait until the wind went down; and marking the passing geese there and then capsizing the skiff, he had crouched behind it and killed until even that greedy, unappeasable, hardened old hunter's heart had grown tired.

Since then it had been hollowed out and a blind built; but save the combination of wind, weather and water, with low flying clouds, it had brought naught but disappointment that bit deeply and rankled sorely, with more than polite and gentle compassionate and forgiving phrases for lost labor and time, on the return to the Club House.

Therefore they laughed.

In the darkness we staked the live wild geese decoys, by a torch of pine knot and lightwood; and the boys pulled out the skiff and decoy box.

Full 30 yards over toward the key we staked the 3 live swans, and one of them *could* "honk!" Then the quarry seldom came within 20 or more yards of the decoys.

That was indeed speculating; for there is no game hunted so difficult to get within range of as the wild swan. Naught but chagrin over great flocks settling on the shallows, so far away that we had to frighten and raise them with the rifle, although one was killed that way.

In the gray dawn, it was a wild scene of low flying clouds, shallow waters, lashed into wild froth and yeast; patches of blue, and many promises of squall and rain and storm, with the moon emerging bright, and great strips of stars in the intervals.

As we realized the day and the weather, we danced, shouted, and "Whoop-de-doodle-doo-ed," until the live decoys, floundering and straining at their thongs, threatened to break their legs and brought Spence and me to fair sense; although we saluted the "governor of North Carolina," and the "governor of South Carolina," again and again; and wound up with the senate, the legislature, the common people, and—a dry bottle.

To-day was sportsman's day at South Hole; for the breeze was blowing a quarter gale. Later it would freshen, and when it broke—but then, there was time enough to think of that, and work enough to provide for it when the time came.

The drift and scud of the clouds and the

spray and mist of the waters were gathered by the wind and blown down and out of the thick and rack, welcomed by the "honk," "honk" of the decoys, the wild geese came in irregular squads. Quick! quick! It's a wing shot at the fowl driving against and in the very teeth of the wind; and you squarely cover them before they can rise or turn aside as you spring to your feet and "let 'em have it!" They are flying so fast, and they come so near that you can hear the spat of the shot striking the thick feathers, and the strong "thud" of the hurtling, stricken fowl, against the sand or the water, is only equalled by the convulsive throb of your heart as it seems to pump every drop of blood in your veins!

Bah! That shot should have killed an ostrich; and, disgusted, you think of the shot a wild goose can carry away from a 10 gauge gun. And then, by Jove! the ecstasy of that long kill makes you pat your gun as daintily as though she were "yo' gal in Sunday dress," as Spence puts it.

Around the blind, as the morning waned and ran into noon, there must have been over 20 dead fowl staked up to life-like imitation of geese resting on the stand.

I was noisily working at the lunch basket when a grip at my collar pulling me backward, *sans ceremonie*, and filling me with wrath and the basket with wet sand, with Spence on top of me and hissing in my ears, ended all thoughts of lunch; for out of the blast came the high soprano tremolo of the swans; to which the old tenor, tugging at his thong, was responding like a very Lohengrin.

"For mercy's sake, get off!" Spence had put the gun in my hand but kept his hand on my neck, and his weight lay heavily on me.

"Do you hear them swans dropping out yonder? Let 'em come! Don't move; they're too far off!" We harked to every sound; for the decoy swans were noisily clattering, and I feared to stealthily peer through the brush.

"Giminy crackers! Look at them geese! There must be a million!" muttered Spence. And indeed it seemed true, when, with painful labor I screwed around to look; but not for me; one swan for a thousand geese.

There they are—5 of them—confound it, just the other side of the decoys, and in dead range. They might as well be in Jericho. The old male swan stands stark and stiff, with suspicious caution and vigilance gleaming in his eyes and looking straight at the blind. Can he see the muzzles of our guns in the gray brush? Or do our eyes shine like his? Lower down! Crouch and wait!

More cries, and more geese coming. What a pain to waste that sport! But the swans are coming nearer and when I look up, they are about 60 yards away. It may

be safe to shoot; but Spence's hand lies heavily on my arm. The old fellow has read my thoughts.

Now they're moving off, and we'll lose that shot sure. Then Spence whispers,

"Hit him back of the wing; a little low down. Now stand up and give it to him!" And we leap up. The swans flap and rise and the guns bark once—twice! "Missed? They're all off! No; the old one is swimming." Out of the blind I tumbled, and after him, through the water, I rushed. On swam the bird, and I chasing. There he tries to fly. Now on him! Only a broken wing and a shattered thigh as I lift him up.

What a beauty he is! Snow white and a very large one! How heavy he is and how tired I am when I get to the blind, wet through and through; and it is 2 o'clock.

We ate our lunch like savages, and Spence began to wish for the boat to come after us. The weather had settled thick and stormy, and it was going to be nasty.

Spence's heart was full of worry for the decoys; and really I shared in his anxiety when the boys came through the water towing the decoy coop and we began to hurry, for Spence was weatherwise and it was well to heed.

There were 26 geese and one swan! Then when we were fairly under way, in the skiff, the weather was upon us. It was dusk when we reached the club house, where we found our friends; and the sum of their sport was as nothing, compared to mine; but when the swan was brought in, 3 pairs of eyes filled with tears that had no pity for me, and viciously flashed in indignation when Jack ordered a bottle of wine to celebrate the swan!

"At least," said my fair champion, "luck was with us," and to the others she said, "You don't know good fortune when it meets you!"

All of which was true! The swan, a noble specimen, hangs on the wall of my dining-room.

---

## RECREATION.

BETH DAY.

To be up in the morning early, as day begins to dawn,

When the dew lies cool and rayless over the silent lawn;

When not a breeze has wakened to ruffle the sleeping lake,

When birds in the topmost branches are the only ones awake;

When the pale, wan moon is fading, out of the brightening sky;

When the sleeping flocks in the farmyards, or else in the pastures lie;

When the air is fresh and fragrant with scents from the orchard trees,

And the hint of blossoming roses is waking the honey bees;

To drink of the air of morning—a full, deep draught—that brings

A Lethean peace for trouble, and a thousand cankering things;

To feel lost youth returning, till the swift glad pulses reel,

As the level miles flow backward from under the gliding wheel;

To leave all care behind one; to be free as the birds that fly.

To be kin to the world of nature, to the earth, and air, and sky:

With the blood of some wild creature dancing in every vein,

And the peace and beauty of morning blooming in heart and brain;

To traverse the meadow, the upland, the forest, the valley, the hill.

The ocean, the lake, and the river, the rapids, the brook, and the rill;

All the year round, in the winter, the spring, the summer and fall,

Ah! this is true recreation, the best recreation of all.

---

# ELKLAND.

## II.

### THE BEAVER POND.

ERNEST SETON THOMPSON.

The other day, when Ellwood Hofer took me to see the big beaver pond, whence he took 3 beaver for the Washington Zoo, I saw at once a chance to publish a careful drawing of a real beaver pond, to replace the fanciful things one sees in books.

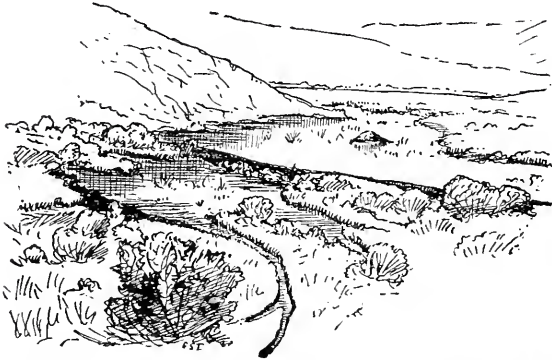

VIEW LOOKING SOUTHWARD FROM THE ASPEN. FIRST AND SECOND PONDS IN SIGHT. 7 FOOT CANAL IN FOREGROUND.

The task of making the drawings was a much greater one than I had expected; for instead of 3 dams I found 13. With a 10 foot pole, a one foot rule and a compass, I worked 2 days and produced the diagrams herewith.

"Lost Creek," a Northward running tributary of Elk creek, on which Yancey's

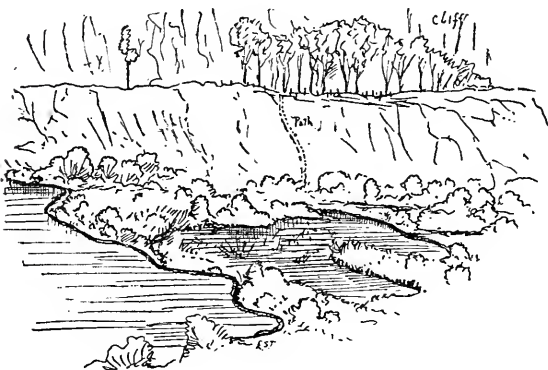

FIRST OR SOUTHERN SECTION OF THE BEAVER POND. 150 YARDS IN LENGTH.

Inn is placed, is a small one, 18 inches wide, averaging 3 inches deep and running about  $1\frac{1}{2}$  miles an hour. It rises in the marsh at the South end of the big pond.

This marsh teems with life. It is a veritable naturalists' paradise. Swarms of Brewer's blackbirds, scores of sora rails, broods of green-winged teal and dozens of song sparrows, hawks, woodpeckers, rock-

wrens, etc., are heard and seen in every direction. Muskrats swim about, on every side, and express their admiration for their big brothers, the beavers, by imitating everything they do—except work. The rock-chuck (*Arctomys flaviventris?*)



LOOKING UP THE VALLEY.

abounds in the criolite cliffs on either shore and adds its loud whistle to the other noises. Antelope, mule deer, and elk are common along the shores, and the coyote and badger are usually on hand to harry the gophers which infest the surrounding slopes in thousands. Of countless insects, frogs and snakes I shall say nothing further than that they are there.

As a matter of fact, it is only by straining a point that I can write of the beaver in a series of articles entitled "Elkland."

The diagrams and sketches herewith render text almost unnecessary; but a few general remarks will help to a realization of this interesting and complicated piece of engineering.

The great or central dam is the oldest; for the aspens opposite this were evidently

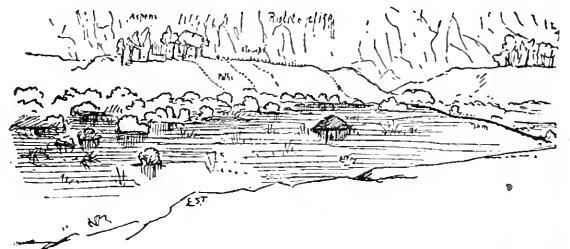

VIEW OF THE REMAINS OF THE ASPEN WOOD, OPPOSITE THE FIRST POND.

the first that were cut away. The willows in this pond are dead; the house is in it, and finally the fact of its superior size is some guarantee of its seniority. This dam is built largely of stone, where it reaches the talus of the cliff, and entirely of mud and wood where it runs into the marsh. While I was there the beaver added a charred pole, 18 feet long and 5 inches thick







THE FIRST AND SECOND PONDS, LOOKING WEST TOWARD THE ASPEN WOOD, AT PRESENT FEEDING THE COLONY.

—the only pole I saw used. This dam contains between 200 and 300 tons of material. The mud for it is dug out of the bottom of the pond and so deepens the water in 2

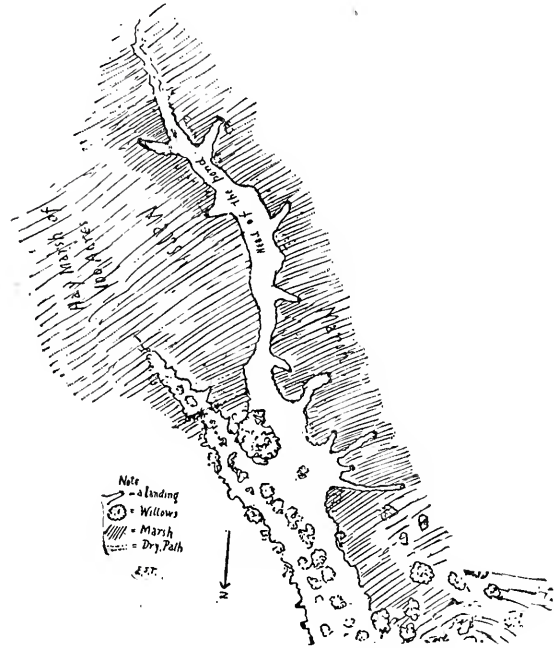

NUMBER 25. - SECOND SECTION OF THE BEAVER POND. 150 YARDS IN LENGTH.

ways. In taking the height I measured always from the bottom of the water, immediately below the dam.

No holes were found in the banks. They may have been overlooked, but as one side of the pond is rocky cliff and the other level marsh I suspect the central moated citadel is the only refuge.

The canals are numerous, but the great 70-footer, leading West from the second pond, is of chief interest. It is the highway to the feeding grounds; is clean cut,

with sharp, hard edges and has a most artificial look. It ends abruptly at the foot of the bank and then the path, sharply defined, continues on to the woods 145 feet further and 30 feet higher up.

The landing-places indicated are short canals with raised mud or sod wharfs at the end, and usually paths leading away. They are found chiefly on the West side, as there is no food on the Eastern bank.

Several of the paths lead only to anthills. These are the work of a small, wholly black ant, are about 2 feet high, and are used by the beaver either as lookouts or else as re-

sorts where he can lie in the sun and give the ants a chance to pick the vermin off from him.

There is but one house, and this is in the large pond. It seems about 5 feet high and 25 feet in diameter, above water; but I could not get to it without swimming. My salary does not justify wading above

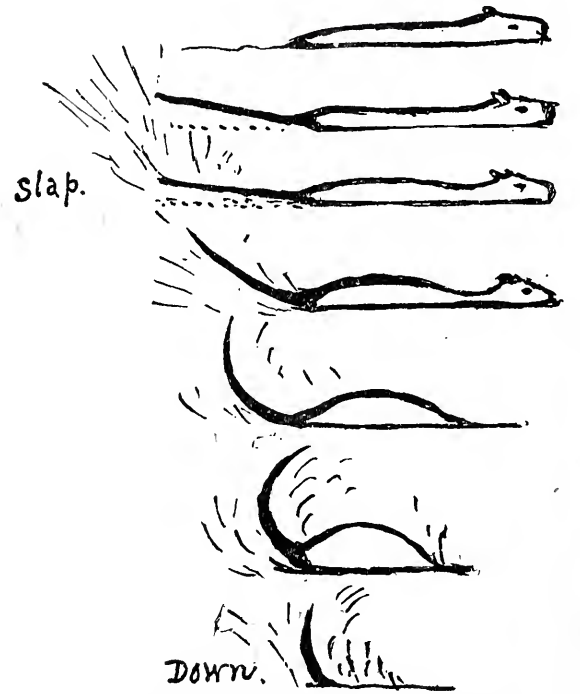

INSTANTANEOUS SKETCHES OF THE POSITIONS IN SLAPPING AND DIVING.

my knees, so I did not get accurate measurements.

As to the beaver themselves (I'm so much interested in their work I had nearly forgotten them) I saw 4 at one time, and think that is all there are. One big fellow



BEAVER CHIP, EXACT SIZE.

in the pond, i.e., the street, they would kiss each other on both cheeks and make a chattering noise just like Frenchmen.

There are several good reasons why I took no photographs. One is the beaver were so busy they had not time to "sit"

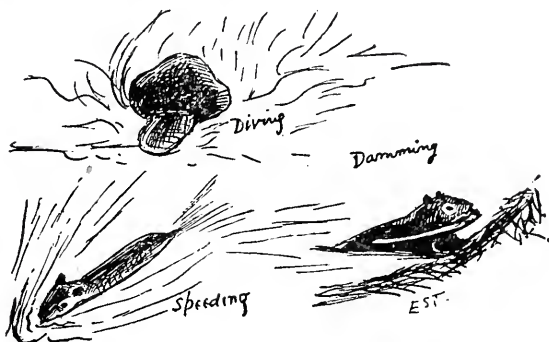

SNAP SHOTS.

for me. Another, the light was too poor for snap work, as the beaver do not come out till sundown.

It is no easy matter to say anything new about beavers' habits after reading Morgan's book on "The Beaver and his Work"; but I noticed these creatures are proud of their work. They are very jealous of intrusion and not without curiosity. When I sat on the bank, perfectly still for



TWIG OF QUAKING ASP (*POPULUS TREMULOIDES*.) THE PRINCIPAL FOOD OF THE BEAVER.

alone seemed interested in repairing the dam, and he worked "like a beaver" the whole time, digging mud out of the bottom of the pond and pounding it into the dam wherever he fancied the water was running over. It never seemed to occur to him that the water must go over somewhere; so the work of stopping the supposed leak goes on indefinitely, the dam grows bigger and the observant Indian remarks:

"Beaver work all time; him dam fool, all same white man."

Frequently when 2 beaver would meet

a time, they swam nearer and nearer, inspecting me closely. If I moved, suddenly, or frightened them, down they went, with a slap of their tails that was a signal heard and understood by every beaver in the pond. But they soon came up again and seemed to fully realize we were in the Yellowstone Park, whence traps and guns are banished.

It seems the muskrats are as great a plague to the beaver as they are to our mill-owners; for they continually pierce the dams with their burrows. The beavers seem to realize this, and Mr. Hofer tells me they kill a muskrat whenever they get a chance. The Brewer's blackbirds in the pond are busy with their young, just now. They are noisy, resentful birds and never fail to pursue and mob any hawk, raven,

muskrat, beaver or person who intrudes near their nests. But the beaver has a simple way of dispersing the mob that I would commend to the notice of our city authorities. When annoyed by half a dozen of the noisy birds he gives a flirt with his tail that sends up a shower of spray on his tormentors and drenches them so thoroughly they are glad to go back to the brush and mind their own business.

(To be continued.)

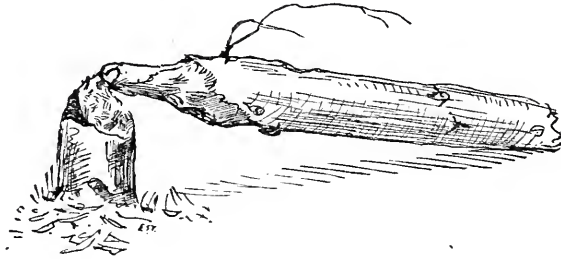

## THE LITTLE BREAKWATERS.

MARGUERITE TRACY.

A red flag was flying from the boat house and the beach was almost deserted. The only people in sight were Love, and a girl, and a little old gentleman.

Love had flung himself at the girl's feet and was scooping up handfuls of sand which he patted into neat little breakwaters, all around. A stone's throw from them the little old gentleman was also building breakwaters; and as he was alone he built them around himself.

Out in the surf, far beyond them, someone was saving someone's else life.

Love looked at the little old gentleman and laughed. "Bless my heart if he isn't building breakwaters like mine."

"How perfectly absurd," the girl said; and then she gazed out, far beyond them, to the surf.

"When you are 50," she went on, to Love, "you will still be patting little breakwaters around us, out of sand."

"But I shall never be 50," said Love. "I shall not grow old."

The girl nodded solemnly. "That is what I am beginning to see," she said. "You will be like the little old gentleman, when you do not grow old; and when I am

50 I shall be very tired of your breakwaters."

"I can do something else," said Love.

A stone's throw from them the little old gentleman drew out his handkerchief and, knotting it in the corners, put it on his head and settled in the sand to sleep.

"You can do that," said the girl. "When I tire of your breakwaters you can go to sleep."

"This sea wind makes one drowsy," Love confessed, and nestling in the sand fell asleep.

The girl knotted her handkerchief, put it on his head, stepped across the little walls of sand and went away.

"I am very fond of him," she murmured, "but I see too long a vista of his breakwaters."

A stone's throw from each other Love and the little old gentleman breathed in cadence as she went out, far beyond them, to the surf where someone had been saving someone's else life.

When a red flag is flying from the boat-house and the beach is almost deserted Love should find more valiant pastime than in building little breakwaters of sand.

## THE COPPER RIVER COUNTRY.

L. L. Bales, an old-time trapper, hunter, guide and explorer, who has been in Alaska for 8 years, trading with the natives and guiding hunting and exploring parties, writes an interesting letter to the "Seattle Times." He is well known to readers of RECREATION as an expert hunter, swift-water navigator and successful mountain-climber. He made a number of trips across the Olympics, years ago, accounts of which were published at the time. He also ascended Mt. Baker to the summit, in 1885. He was employed by Lieut. G. T. Emmons, executive officer of the U. S. S. S. Pinta, stationed at Sitka, to assist in making the collection of heads and skins of wild animals, for the Alaskan exhibit at the Columbian Exposition. This work took him not only along the coast, from Sitka to Bering Straits, but back many miles into the interior. Mr. Bales has explored the valleys of nearly all the streams tributary to the North Pacific and Bering Sea.

When asked about the prospects of a continuation of the gold excitement, Mr. Bales replied:

"The rush of gold-seekers is but in its incipiency. Another season at least 100,000 will go to Alaska. The vast extent and richness of the gold fields warrant this estimate. To-day the Klondike country is claiming the entire attention, but the near future will demonstrate that the rich gold region comprises a territory 50 times as large as that known as the Klondike region.

"The Copper river country alone, with its tributaries, is over 250 miles long, by 150 miles broad, which means an area of 37,500 square miles. Gold, as well as copper, exists in abundance throughout this vast section. I have seen specimens of ore, rich in copper, from this country; while the natives assert both gold and copper abound along the many tributaries to the main stream. The identical gold signs are found at the mouth of Copper river that first led to explorations of the Yukon, viz: Great quantities of fine flour gold permeating the mud and salt. Of course the farther up the streams one goes the coarser must be these particles of the yellow metal. Again, Copper river heads within a short distance of Forty-Mile and Sixty-Mile creeks, which latter are rich in gold placers and which empty into the Yukon near the Klondike.

"If I were going to head an expedition to Alaska to search for gold, I should take the steamer Dora, at Sitka, for Nuchek, on Prince William's Island 400 miles to the Northwest. From thence I should go to Orca, some 45 miles farther up the Sound, via the salmon cannery tugs, which make connection with the Dora, at Nuchek. This brings one within 45 miles of Valdeze Pass,

and some 100 miles Northwest of the mouth of Copper river. The remaining distance, to the pass, must be covered by small boats—Indian canoes being preferable. So far the route is almost exclusively by salt water, the exception being a few miles of fresh water encountered just before reaching the pass.

"Valdeze Pass is low and comparatively easy of ascent. With a 75 pound pack a man acquainted with the route can easily make the trip in 3 days, through the pass to water connections with Copper river. The route could be made passable for pack animals, with little expense in time and labor. I was intimately associated, last summer, with Billy Ribbstein, now of Sunrise City, Cook Inlet, who had but recently explored the pass and who had just returned from an extended trip up Copper river. He assured me the pass is preferable, in every way, to any other pass on the coast leading to the interior, and that little labor would make it a fine route for pack animals. It is by far the lowest pass on the coast.

"The trip through Valdeze Pass lands you on an unnamed lake, tributary to and but 30 miles from, Copper river. The point where you thus strike the main stream is about 150 miles from its mouth, as the river runs. The canoe journey, from the start down, is perfectly feasible, except in extreme low water.

"The best time to go in over this route would be either in March or June. In March you have the snow and ice for travel, by sleds, while in June comes the open water for canoeing.

"The Copper river country, from Valdeze Pass up, is rolling. There are few high mountains except in the Southeast. Occasional large round buttes take the place of mountains. Scattering groves of spruce are found on the uplands, while the streams are fringed with black alder, birch, cottonwood and willow. The slopes are covered with flowers in the summer time. There is also an abundance of wild berries of many varieties. Everywhere may be seen running water. The surface of the country is covered with moss through which the tickle top grass makes its way, growing breast high. The seed of this grass furnishes food for the armies of kangaroo mice that are found in every part of the country, being outnumbered only by the mosquitoes.

"The Klondike territory is pretty well covered by prospectors now, and by next spring the rush will be so great the chances will be mighty slim for striking a good claim, open for location. Newcomers will be obliged to push in farther to the North and East, all the way from 200 to 500 miles, where supplies will be more difficult to ob-

tain and where the winters are longer and much more rigorous.

"The Copper river country is wholly within the jurisdiction of Uncle Sam—no customs duties; no percentage; no reservations. Then the climate is milder as you approach the coast. The influence of the Japan current is plainly manifest in the Copper river basin. The ground thaws to a greater depth, while the summer season is all of 30 days longer.

"There is plenty of game in the Copper river country, both large and small. In the interior are moose, caribou, mountain sheep and bear. Mountain goats are found along the coast. The fur-bearing animals are foxes, wolverines, sable, beaver and otter. On the lakes and streams wild fowl are to be found in great numbers during the summer, comprising geese, ducks, swans, cranes and pelicans. Blue grouse and ptarmigans abound in the hills. Those who go to Alaska for the one purpose of digging gold had best take along a shotgun, in preference to a rifle, as much valuable time must be consumed if one attempts to hunt big game.

"The best boats for navigating the rivers and lakes in Alaska are something after the model of a Peterborough or Canadian canoe, made of thin, light slats, covered with stout canvas and well painted. Then there should be 3 light strips of wood extending the entire length of the bottom, outside of the canvas, to give protection when the boat is pulled up on shore. There should be a canvas cover, provided with manholes, eyelets and strings, to be tied over the boat to a strip along its sides. This is necessary to protect the supplies from the spray, in shooting rapids or in going against a stiff current. The canoe should be large enough to carry 2 men and 1,000 pounds of supplies.

"A better boat still is the bidarka, or kyak, a skin canoe made by the natives and used by them in hunting sea otters in the North Pacific Ocean and in Bering Sea. Properly handled these boats will live where a ship would founder.

"There are plenty of these kyaks on Prince William sound, but the fur companies discourage the natives from selling them to outsiders. The companies buy them up as fast as made, allowing the natives to use them, however. This precaution is taken lest others should engage in sea otter hunting. The boats are worth \$25 to \$100. They are the best made, in the hands of an experienced man, in bad water. They are light as a feather, and can be easily repaired by keeping on hand a piece of rawhide and some sinew. The framework is seasoned willow. The raw seal skins, with the hair off, are stretched and sewed over the framework, when green, and allowed to dry thereon. This renders the covering as taut as a drum head. The bidarka is not a 'cranky' boat if understood.

"There are reports that the Indians on Copper river, and in other sections of the interior are hostile, but this is not true. On the contrary they are the most peaceable, hospitable race of people I ever encountered. That report originated from some of the trading companies whose object, for many years, has been to keep people from exploring the interior; as they have all along foreseen that when once the richness of the country, in furs and mineral, became known their monopoly of the trading business must end.

"The Copper river Indians are few in number and could make little headway against prospectors, were they so disposed. They are ever ready to render aid and assistance where needed. They are scrupulously honest and will faithfully discharge an obligation. Prospectors need have no fear of the natives of the interior, so long as they treat them right."

---

I have known Mr. Bales 12 years, and have always found him honest and reliable. He is now located at Sitka, Alaska, and offers his services as guide for prospecting and exploring parties.—EDITOR.

---

There are still some unfortunate sportsmen who are not readers of RECREATION. If you know any such send in their names, and greatly oblige them and

THE EDITOR.

---

## THE WOLF QUESTION.

FROM THE UPPER MISSOURI.

Fort Assiniboine, Mont.

EDITOR RECREATION: In reply to your letter requesting information as to the wolf problem, in this locality I would say it is very far from being settled, and it becomes more difficult of solution as time goes on. Having been stationed at this post for nearly 4 years, and maintaining a large pack of English grayhounds and Russian wolfhounds I am naturally much interested in the subject, and gladly give you my conclusions on the list of questions submitted.

(1.) At Fort Assiniboine, Chotau county, Mont.

(2.) Gray wolves are troublesome in this vicinity, especially South of the post, in the Bear Paw mountains. They are rarely seen, however, doing all their foraging and traveling at night and resting during the day, in the rough country where they are able to escape observation.

(3.) Wolves in this vicinity seldom kill sheep, as the latter are too carefully herded. They get a good many young colts, but prey especially on young cattle—2 year olds and heifers.

(4.) It is said that in this country the loss from wolves and coyotes is about 15 per cent. of the annual increase. I have been told by stockmen along the Yellowstone and Musselshell, where wolves are especially numerous, that the loss from this source is half the annual increase. I have also seen statements, in the newspapers of that locality, to that effect. In riding with the hounds, during winter, I frequently come across dead cattle undoubtedly pulled down by wolves.

(5.) I have never known a wolf, or wolves, to voluntarily attack a human being; although they fight savagely if trapped, or rounded up by hounds. I know of at least 2 instances in which a dismounted hunter was attacked and narrowly escaped injury, while attempting to aid his dogs. I have tried to ride down a wolf, lacking firearms, while he was delayed by the dogs, and have had him charge the horse twice. A wolf ordinarily fears nothing so much as a human being, and always runs as soon as he sees a man, whether on foot or on horseback.

(6.) Wolves are certainly increasing in number. When poisoning was first introduced, in the buffalo days, the wolves fell victims in large numbers. Now they are much wiser and more wary. Few are trapped. They rarely venture out of rough country, in daylight, and hence are with difficulty caught with hounds. Experience with poisoning has made them chary of touching bait. A few wolf pups are poisoned; but an old wolf almost never falls a victim. I have

known them desert a freshly killed steer merely because I walked around it. I could see, from their foot prints, they had gone a hundred yards away, into the next coulee, and had pulled down another steer, rather than eat the one I had inspected.

Bounties are paid on some 3,000 wolf and coyote scalps, in this country, annually. I was informed that during the months of May and June, 1896, nearly 3,500 scalps were punched in Teton County, to the West of here.

(7.) I have never known wolves to signal across country. They certainly have a definite route which they follow, when foraging, and treat the stumps, stones, etc., as a dog would. In one instance, where 2 pieces of poisoned meat had been put out, a wolf swallowed one piece; but on biting into the other, he evidently tasted the strychnine. This piece he carried about 30 yards, deposited it on a snowdrift and urinated on it—presumably to show his contempt. His pride was a little previous, however, as the first dose of poison rolled him over within half a mile.

(8.) I have known a dog wolf to tip the scales at 138 pounds; and have seen others which I am positive would weigh 150 to 160 pounds. A bitch wolf is about one-third smaller. I have a mounted wolf rug which is 6 feet 2 inches from tip of nose to tip of tail, and have seen a number of hides larger than this.

(9.) Coyotes never attack grown animals, excluding sheep; but undoubtedly destroy many newly dropped calves and colts during one or 2 of the spring months. In this section, where but little ground is under cultivation, this destruction of young stock represents a loss which is not counterbalanced by a gain to the farmer, through the destruction of prairie dogs, gophers, jack rabbits, etc. Farther South, especially in Colorado, the increasing pest of jack rabbits is undoubtedly, in the main, due to the interference with Nature's balance through the destruction of coyotes. On the whole, the character of the coyote, like that of the crow, is not so black as it is painted.

(10.) The best method for the extermination of wolves would be.

*First:* To have the States interested appropriate a sum, raised chiefly by direct taxation of stock owners, sufficient to pay, in full, all the bounty claims for the coming year. This would prevent distrust of bounty payments and would enable men to engage in the business of wolf hunting without danger of having to discount the bounty certificates, for half a year's catch, at half their face value.

*Second:* To offer a bounty fairly commensurate with the time and trouble necessary for wolf catching. This should be \$10

for an adult wolf, and \$5 for a whelp. At the rates now paid in this State, \$3 a head, nobody but an Indian can afford to hunt wolves systematically, for profit.

*Third:* Make bounty certificates legal tender, for any amount, in the payment of taxes.

*Fourth:* Allow any Justice of the Peace to issue bounty certificates and not require, as in this county, that the hides shall be brought to the county seat for punching. A man with 3 coyote skins, worth \$9 in bounty, will hardly care to travel 300 to 400 miles to collect this sum, in a country where the railroads charge 5 cents a mile and where express rates are practically prohibitive.

*Fifth:* Require each person killing a wolf to bring the hide, for the collection of the bounty, and make bounty certificates non-transferable. Such requirements would exclude the middle man, who now stands between the wolf trapper and the State, who gets a large share of the benefits arising from the bounty laws and who in just so much nullifies the intended effect of these laws.

The direct means to be employed in wolf extermination are poisoning, trapping, digging out the whelps and hounding. As before stated, it is rare that poisoning results in anything more than the destruction of every dog within a considerable distance. Adult wolves rarely touch bait; whelps and coyotes take it a trifle more readily. This method is highly inefficient and absolutely prohibits the use of hounds. Coyotes and wolves often refuse to eat bait which they may carry in their mouths considerable distances, thus rendering even the most carefully located baits possible sources of danger. Poisoning should be restricted by law and the provisions of such a law should be rigidly enforced. Bait should not be put out within 2 miles of a travelled road, nor within the same distance of a habitation, excepting that of the poisoner. Violation of such a law should result in a heavy fine and judgment for twice the value of any domestic animal destroyed. The poisoning method is advantageous to the State treasury and correspondingly inimical to the interests of the wolf catcher, inasmuch as a majority of the animals poisoned run long distances, after taking bait, and are never recovered.

Trapping is a fairly safe method of destruction; but is much more successful on coyotes than on wolves. It is difficult to so place a trap as to deceive an old wolf and snow storms are apt to impair its efficiency. There is always a good chance, if the trap is located near a cattle trail, of catching cattle or horses; and any dogs in the vicinity are reasonably sure of lacerated paws or of broken legs.

Digging out the whelps, in the spring, is

an easy matter when the den is once located. Under the present bounty laws of this State searching for the burrows can be profitable only to those whose time is of no value, such as Indians and half breeds. The several hundred wandering Cree Indians, deported from this State a year since, were a potent factor in the killing off of the whelps in their vicinity.

Hounding is a method at once sportsmanlike and satisfactory in its results, although a source of constant expense. This does not apply to the use of fox hounds which, in this country, are absolutely unable to catch a coyote or to cope with a wolf, even if he should disdain to run from them. A pack of fast fox hounds, now 18 in all, has been thoroughly tested in this post, during my service of nearly 4 years. In all this time they have not only never caught a coyote, but they have never even come near doing so. This experience coincides with that of others who have worked fox hounds, in Indian Territory and in the Northwest Provinces of Canada.

The best pack for work on wolves is undoubtedly one composed of the best greyhounds and Russian wolfhounds—the latter of the coursing type. These are faster than the greyhound, for a dash, but are not so speedy in a long run, of several miles. The heavy set, fighting type of the Russian wolfhound is useless as a coursing dog, and should only be run with faster dogs. They are killers, not runners; and in this respect should undoubtedly surpass even the stag-hound, as their teeth and jaws are better and their coat a more thorough protection.

Packs of such dogs should be maintained by every large cattle company, or outfit, and the smaller ranchers should combine to keep up such a pack within a 10 mile radius of their ranches, moving the pack from place to place and not confining the hunting to one locality. Such a pack, properly worked, should soon kill off or drive out the wolves and coyotes in the country covered by them. The pack could be worked by boys at such times as the ranch work occupied their elders; and by properly restricting the number of pups and utilizing dead cattle, or worn out horses, as food, should not be very expensive. These dogs should catch at least  $\frac{1}{2}$  of all the wolves they chase. I have known a good pack to pull down as many as 5 or 6 coyotes a day, and to run the season's kill well up into the hundréds.

These remarks apply only to the best dogs. A pack of inferior or slow dogs is a constant source of annoyance and disappointment, and by their use the wolves are soon educated up to such a degree of wariness that even the best dogs are unable to get sufficiently near to stand a chance of overhauling them.

Edward L. Munson, Lieut. U. S. A.



FROM THE YELLOWSTONE DISTRICT.

Miles City, Mont.

Editor RECREATION: I note with interest Mr. Thompson's questions, in July RECREATION, touching the wolf question, and they should bring many responses from the rangemen of this country.

1st. I have just returned from a 2 months' buckboard trip, visiting the various round-ups working in the Powder, Tongue and Yellowstone river country. I regret I did not have copies of July RECREATION with me, for distribution, for everywhere the wolf question was being discussed and fresh tales of ravages of wolves and coyotes were being recited.

2d. Gray wolves are decidedly troublesome here. Within a few miles of town, in almost any direction, they are known to pull down and destroy colts and calves. Numerous instances are also noted of their killing yearlings, and 2 year olds, within sight of the ranch door and often inside the pasture fences.

3d. The wolves destroy cattle, horses and sheep, though colts and calves are their preference. Yearling calves are not cared for by the range cows and must fight for themselves; so, if cut off from the herd, are soon pulled down and killed.

4th. It would be extremely difficult to estimate the damage wolves do. Every ranch has its bands of horses and cattle, called "ranch stock"—stock that is seen every day and that ranges near by, or in pastures—milch cows, work and saddle horses, young bulls and valuable brood mares.

I know of many instances in which, this season, the wolves have destroyed 25 to 40 per cent. of the increase, and numerous grown animals, from among such stock.

If this be true what must the losses amount to among range animals that are only seen once or twice a year, and that during the round-up seasons? So serious has this condition become that many of our small ranchman are going out of the business.

While with one round-up outfit recently, I visited a wolf den, in the Badlands, where the day before the cow-boys had shot 2 old wolves and had killed 11 half grown pups. A ranchman took me there to show me how these pests locate their dens, near together, and to give me a practical demonstration as to the amount of food the wolves bring for their whelps to discuss at their leisure. There were remnants of not less than 25 colts and calves strewn about the ledge where these savage beasts made their home.

5th. I have never known wolves to harm a person; but I shall not soon forget a journey I made, on foot, one January night, some 15 years ago, between here and the Redwater. My horse got away with my gun, saddle and overcoat. I had 12 miles

to go to where I expected to overtake him. Just at dusk a wolf appeared, only a few rods ahead, in the trail. He lifted up his voice and was soon joined by 2 of his kin. They seemed to know I was unarmed—save for a butcher knife—and that I was tired and footsore. They soon had plenty of company and were, at times, much nearer to me than was comfortable, before I took refuge in an abandoned camp, where I awaited daylight.

I am therefore certain that wolves, when hungry and in numbers, will harm a lone foot passenger, plenty.

6th. Wolves and coyotes are increasing rapidly here. They were not so numerous 20 years ago, when the last of the American bison were being exterminated, for their hides and horns.

7th. I have never heard of or seen anything to lead me to the conclusion that wolves signal to one another across country, other than vocally. The howl of a gray wolf can be heard a long distance.

I once knew an old she wolf to carry a tallow ball—containing a big dose of strychnine—4 to 6 miles, laying it down in the snow every now and again, while she bayed, loud and long. She was joined by 2 full grown males, at different points. The trio travelled a mile together and then each ate enough of the bait (the ball was only an inch and a half in diameter) to kill, as was evidenced by the 3 bodies, found the next morning within 50 feet of each other. They must have known it was loaded but it would seem the temptation to eat was so strong they finally concluded to take the chances. They played for small stakes and lost.

8th. I have never measured a gray wolf, but I know they grow large enough, and are strong enough, to drag a colt or a calf many miles, over the roughest country.

9th. Yes, the coyote is a sneak thief and an unmitigated nuisance. He lives mostly on prairie dogs and the remains of animals left by wolves.

10th. It appears to me the only way to rid the country of wolves is to offer a bounty of \$5 or more, for pelts, and to provide funds to cash the certificates. This will set every practical wolfer at work.

Some cattle outfits keep packs of hounds and kill some wolves in that way. Only a few of the largest operators can bear the expense of that kind of sport. The old time wolfer, who locates the den and bags the whole outfit has the only practical scheme for reducing their numbers, perceptibly. Wolfers will not work—and it requires mighty hard work, and hard riding, to kill wolves—for a \$2 or \$3 bounty. Then to take a certificate that there is no available appropriation to pay, and that bankers and brokers will discount 25 to 40 per cent., if they handle it at all, is poor pay.

L. A. Huffman.

## FROM MONTANA.

Anaconda, Mont.

Editor RECREATION: Back in the 70's, when countless herds of buffalo covered Dakota and Montana and when the Indians reigned supreme, the coyotes and buffalo wolves were plentiful, easily killed, and exercised no such cunning as is attributed to them now. It was no uncommon thing for a wolfer to strychnine 40 to 60 large wolves, and as many coyotes, in a single night. This could be done until about '83, when the buffalo were practically no more.

Then the cattlemen put out so much poison, to exterminate the pests, that the wolves, from being gluttons, and carrion eaters of the lowest order, have acquired tastes that are quite fastidious. In fact it is now almost impossible to poison a wolf. I put out 8 ounces of good strychnine last winter and got only 8 coyotes.

The wolves and coyotes would eat the drop baits, and sometimes whole carcasses of cattle or horses; but few would die. I would follow up their trails, in the snow, and find where they had staggered about and vomited the poison. Then they would soon recover.

In conversation with 3 coyote men, last fall, from Northern Montana, they told me they had frequently watched coyotes eat poisoned meat. When they got sick they would immediately stagger about in search of a weed which, on eating, neutralized the poison and Richard was himself again. I do not vouch for the truth of their story but it sounds plausible.

Few coyotes were killed in Western Montana, last winter, because it does not now pay to follow them.

Trapping and shooting are the best methods of exterminating wolves and coyotes. Two years ago, last spring, I shot 37 coyotes in one week. The Montana bounty is \$3 a head, payable every quarter—if there is money on hand. There is always more or less difficulty in getting a settlement and coyote hunters have lost interest in hunting down the animals and then being compelled to sell their bounty certificates to the bank at 50 per cent. discount.

I will now answer Mr. Thompson's questions in their order:

1st. There are not many gray wolves here. It is too near the mountains; but coyotes are plentiful and troublesome. All ranchers and cattlemen who have 50 to 200 head of cattle, lose 5 to 20 head of calves every spring. These, at 3 years of age would bring \$40 a head. Hence the wolves cause a clear loss of \$200 to \$800 to the ranch. The losses of cattlemen, who keep large herds, run into thousands of dollars every year.

These varmints also destroy a great many sheep and lambs. Farther North and East of here they kill a great many colts every

season. So, in the aggregate, the loss runs into the millions every year.

2d. I have never known of a buffalo wolf, or a coyote, molesting any person, with the intention of holding a post mortem. The gray timber wolf is said to have killed people in the Minnesota and Wisconsin woods, but no such cases have ever occurred on the plains.

6th. I believe wolves and coyotes are on the increase during the last year or so. At least they hold their own.

7th. Although wolves and coyotes are very cunning I do not think they can or do, signal across the country to other wolves.

8th. Have never weighed or measured a wolf. Judging from the size of their howl they weigh a ton.

9th. The coyote is a greater menace to stock than the wolves, and in a year destroys more young game than all the hunters and Indians put together. He never overlooks any bets in the shape of young calves, sheep, chickens, or game.

10th. A \$10 bounty on coyotes and wolves, payable whenever certificate is presented, would practically exterminate these animals in less than 2 years. There are many thousands of dollars worth of State bounty certificates, issued years ago, that remain unpaid. Now where is the inducement for wolfers to rustle for scalps? Gray wolves are far more shy than a coyote, and far scarcer. They frequently kill grown horses and cattle, while the coyote, like the poor, is always around us. So, in my opinion, based on years of observation, the coyote commits far more depredations in a season than Mr. Wolf ever dreamed of.

Vic Smith.

## FROM THE BIG HORN BASIN.

Editor RECREATION: At request of Governor Richards, I will tell you what I know about the wolf question. My experience is limited, but what I shall say is at least practical—not theoretical.

1st. I am located in Big Horn Co., Wyoming, in what is known as the Big Horn Basin, at the foot of the Big Horn range of mountains, on the West side, about 90 miles South and West from Buffalo, Wyoming, and 125 miles from Casper, Wyoming, in a Northeasterly direction.

2d. Gray wolves are becoming very troublesome in this locality

3d. They destroy cattle, horses, sheep and game of nearly all kinds.

4th. As to the amount of damage done in a year it is a hard matter to estimate. This I am sure of, where stock is properly taken care of, the wolves are by far the greater source of loss. We have had 2

wolves kill 3 or 4 head of stock in a short time, and they would undoubtedly have done much more damage had we not tracked them to their den and caught the young ones. Then we set a trap in the den and in 2 or 3 days the old female was caught. I think the dog left, as we were not bothered any more for some time. In this county they kill at least 5 per cent. of the small ranchmen's stock each year, and there is no telling what per cent. of range stock they do destroy; but considerably more than 5 per cent., in my opinion.

5th. No, I never knew of a gray wolf killing a person, but I have known of their chasing people 2 or 3 different times. I believe they would kill a man, when starving, and when there are a lot of the wolves together.

6th. Wolves are increasing rapidly. If they increase here for the next 5 years as they have in the past 5, they will take all the profit of the stock business.

7th. No; I don't believe they tell one another what parts of the country are dangerous; but they do signal one another when they want help to attack something that is too large for one wolf. Their howl can be heard a long distance; from 5 to 10 miles, according to the condition of the air.

8th. Absurd as it may seem, I never measured or weighed a wolf, in my life. We have a skin mounted, as a rug, that measures 76 inches from tip of nose to tip of tail. The feet have been cut off, and as near as I can judge, it would have measured about 50 inches from tip to tip of fore paws, when stretched out, and the hind legs measure about 52 or 54 inches, in the same way. This wolf would have weighed over 100 pounds; but as I did not weigh him, I will not attempt to give a very close guess.

9th. The coyote is undoubtedly a nuisance to the sheepman, but does not harm cattle or horses much.

10th. The best means of ridding the country of wolves is undoubtedly the bounty scheme, as a good bounty will set a great many people to hunting them; but the bounty must be paid all over the wolf infested territory. It will do no good to hunt them in one section and let them thrive in another.

As we are much interested in the wolf question, I shall be glad to furnish you any information in my power, at any time. While I have killed a number of wolves, I have never given the matter close attention until of late. They now seriously threaten our business. I have procured 5 hound pups, gray hound and stag hound, mixed; and intend running the wolves with them. I do not know how it will work, as I have never had any experience; but next year I can tell something about it, for I intend to give the matter personal attention and to get the best results possible.

Geo. B. McClellan, Red Bank, Wyo.

FROM DEER LODGE COUNTY, MONTANA.

Woodworth, Mont.

Editor RECREATION: I have not much to say on the wolf question, from personal knowledge, as I have never seen a wolf kill a domestic animal; though I know they do kill sheep at every chance—even while the herder is with them. When I was on the buffalo range I have seen as many as 100 gray wolves in a drove, all traveling together. They did not need to kill game, at that time, for there was plenty of it already killed.

In those days if one could get the wolves hungry they would take poison freely; but they have grown too smart now; and it is almost impossible to get a wolf of any kind to take a bait.

They are very hard to trap. They will discover a trap where a fox will walk into it, and the wolf is too wild to make a success of shooting. The only way I have found to be successful is to have a good pack of dogs and run the wolves down.

I will answer all your questions, to the best of my ability. You want facts, and not hearsay.

1. Woodworth, Montana—in a timbered country.

2. There are a number of gray wolves here, but they kill nothing but deer—mostly white tail.

3. I have not heard of their killing any stock in this vicinity.

4. I do not think the gray wolf does any damage to stock, in this county, though the stockmen complain of the coyotes killing calves, out on the open range.

5. No; that is all done in newspaper offices.

6. They are holding their own, to all appearances.

7. No; I do not believe they have any such signals; though, to my certain knowledge, gray wolves can call others to a feast. Coyotes have signs that will warn others to keep away from a poisoned carcass. After one has visited it no others will go near it.

8. The largest wolf I ever saw, dead, weighed 105 pounds. I did not make any measurement.

9. A pair of coyotes will do more harm in one night, in a sheep herd, than all the gophers will do in a year, in any county in this State.

10. The best way, to my thinking, to get rid of the wolves and coyotes, is to pay bounty enough to make it worth while for hunters to spend their time after them. Then they will soon disappear.

M. P. Dunham.

I will esteem it a personal favor if you will send me the names and addresses of all the sportsmen you know, who are not yet readers of RECREATION.

## FROM THE GAME FIELDS.

MR. LEAVENWORTH'S DEFENCE.

Mt. Vernon, Indiana.

Editor RECREATION: I notice in your August number, an article by P. W. Roche, regarding game in Posey county, and some bags made by local sportsmen, myself among others. I also note the comments of the editor regarding a "reasonable bag" and the epithets applied by said editor to him who, in the opinion of said editor, has taken more than said editor considers a "reasonable bag." Before I fall before the fire of the many "high minded sportsmen" called to the charge by the "Hey Rube" of the editor, allow me to present to the readers of RECREATION a statement of the facts; as I am not desirous of being tried upon the article of my friend Peter Roche, whose imagination is almost as great as his circumference.

My friend Peter is all right; whole souled, jovial and with a corporation as big as the State of Texas. But he never fired a shot gun in his life, and could not tell a choke bore from a boomerang. He would not know the whistle of a wood-cock from a calliope, and I know, of my own personal knowledge, he labors under the impression that squirrels go in beavies, and that the proper time to shoot Bob White is "when the wheat is in the shock, and the quail is on the top." For these reasons I forgive Peter. If I thought he had done this deed through malice I would stick my frog spear in him.

My wife and I did kill 296 squirrels last season, 12 being the most bagged in one day. The season, in this State, commences June 1st, and ends December 20th. (It ought to be from June 15th to November 1st.) So we get 6 months and 20 days of shooting. The squirrels were killed in 3 States—Indiana, Kentucky and Illinois. It took just 15 hunts to get them.

My wife and I rise at 3 a. m., go to the woods and return by 9 a. m. I have made it a practice for years to quit hunting, in any piece of woods, when the squirrels begin to get scarce. I keep memoranda of all the squirrel woods within 20 miles of this city. In this book I write anything of interest I note, regarding the game there; such as its becoming scarce; the number killed there, etc. I am the only man in this county who has ever taken any initial steps to enforce the game and fish laws, and to protect game and fish generally. I have made many enemies and lost some law practice by so doing.

The statement regarding the killing of quails by Stallings and Knight is, in the main, correct. I think the birds were shipped to Evansville and sold. We now have a law against selling quails, that will

do much good; and while it will not stop quail selling, it will restrain it. As for myself I never bagged over 20 quails in one hunt last year. My wife and I, on several occasions, killed 25 mallard ducks, last fall. We would commence shooting at 9 a. m. and quit at 2 p. m., frequently with ducks flying in clouds over us.

We do not kill game to see it die, or to boast of our prowess. The only regret we have, in hunting, is the pain we must inflict on the beautiful inhabitants of field, wood and water, and the life we take but cannot give again. We love the sweet morning, the sparkling water, the dark wood, and the cries of the wild creatures of the forest. We would not give these, for all the lifeless bodies of game ever killed by man.

Mr. Roche writes, "the greatest duck, squirrel and quail shooting to be found anywhere is in Posey county, in the South-western part of Indiana."

This is a great error. The only duck shooting we have here now, is on Hovey's lake. This lake is on a private preserve, and no one is allowed to shoot there except members of the Hovey Gun Club. It was on this lake the bags before mentioned were made. Twenty years ago this country literally swarmed with water fowl; but they are now gone; or, if they do come, are soon driven away by countless hunters, who fire at them out of range. Nothing, in my opinion, scares ducks away like shooting at them at long distances. Few are killed, but as they never get a chance to feed or rest, they soon leave.

Squirrels were never so scarce in this county as now. Not because of the 300 we got last year, but for some cause, unknown. They were abundant through the winter and in the spring, and in many localities I know they were not killed, out of season, as I watched them myself. They were not even shot at. In February I counted, in one locality, 41 squirrels while going through a piece of woods. I was in a boat and marked them, intending to get them in June, when mulberries were ripe. In June, when I went to hunt them, they were gone. There was no "sign," no nests, no digging in the ground, no gnawing of rotten logs. I find the same state of things everywhere. Private woods where no gun has been fired for years, and where the squirrels have been always fed and petted, are deserted.

Mr. Templeton, who has kept a 10 acre tract of woods, for years, stocked with squirrels, says they have left his woods also. He has observed their habits closely but can give no explanation of their absence. Nor can I, or anyone else. Perhaps RECREATION can, or some of its readers.

Quails are fairly abundant, and would have been unusually plentiful had it not been for a queer throat disease that attacked them, early in the spring, and then suddenly disappeared; some were also killed, with their broods, by heavy floods. The hunters here go to Kentucky and Illinois for quails, although we have some at home. It is only across the river to Kentucky, and 7 miles to Illinois.

Now Mr. Editor, you have the truth—blaze away! And if you hit a tender spot in my "high minded sportsmen's" conscience again, I will "bob up serenely" and let you know; because I did not know I was a "game hog." I suppose "a game nog" might grunt around the classic shades of Posey county 40 years, and not know it, unless some one from the *effete* East should happen to mention it to him. Meantime, if you happen to hear of a man or several of them, with the "sinews of war," who would like to invest in about 1,000 or more acres of fine hunting land, with a lake in it, where there are jack snipe, wood-cock, squirrels, ducks, geese, quails, etc., that have been hunted too much, and that have never known protection, but that can be easily and inexpensively restocked; men who would take your humble servant, the "game hog," in with them, not as an object of charity, but as a capital furnishing partner, kindly let me know, and I will forgive you the hard things you have said of an old subscriber. Seth Leavenworth.

Mr. Leavenworth has certainly made a frank and manly defense of his action. I believe his statements are true, and if my friend Mr. Roche had given all the facts regarding this shooting, that Mr. Leavenworth now gives, I should not have made the criticisms on Mr. Leavenworth's action, which I did make in August RECREATION. It alters the status of the case materially to learn that Mrs. Leavenworth accompanied her husband on all these shooting trips, and that she did her full share of the killing. Three hundred squirrels for 2 guns, in 6 months' shooting, is not excessive, as I set forth in the article referred to. Furthermore I did not apply any epithets to Mr. Leavenworth or to the other men mentioned, as Mr. Leavenworth says I did. He should turn to my criticism and read it again. He will find it mild and dignified, even though severe.—EDITOR.

#### DEER IN VERMONT.

Boston, Mass.

Editor RECREATION: During 20 years of protection, under the well-enforced game laws of the State, deer have so increased in number, in Vermont, as to become a positive nuisance to farmers in the mountainous sections.

In order to protect their crops they found

it necessary, last fall, to appeal to the State Legislature for relief, and on the last night of the session a law was passed by which, on the first day of October next, the first deer legally killed since late in the seventies may fall a victim to the hunter's rifle. By virtue of this statute October in each year, beginning this year, will be an open month for shooting, throughout the whole State. The law provides that only deer with antlers may be shot and that 2 may be taken by any one person, in the course of a season. It prohibits the use of dogs, salt licks, jack-lights, crusting and traps, and allows one deer, and the head and hoofs of another, to be taken from the State, when accompanied by the captor. The first provision is intended to protect does and young bucks.

In Essex and Orleans counties, deer are said to be most numerous, although they are to be found in numbers in nearly every county of the State, excepting possibly those bordering the upper part of Lake Champlain where there have been fewer opportunities for them to multiply. They have long been regarded as too friendly to the farmer, in the mountain regions of Rutland, Windsor, Lamoille, Caledonia and Orange counties, and some mighty interesting stories are to be heard, at the country stores and taverns, of their tameness, their pranks with cattle and their utter disregard of danger.

It is told for the truth, and need not be doubted, that along the line of the Central Vermont railroad, deer are frequently seen on the tracks, and in more than one instance engineers have slowed their trains to avoid killing them.

In several sections among the foothills of the Green mountains, deer herded with the cattle in the mountain pastures, last summer, and when the herds were driven home for the winter the deer followed, hovering around the farm-buildings, and, in some instances, even entering the barn yards and feeding with sheep and cattle. About a month ago, while mending a fence, J. H. Hoadley, a well known farmer of Woodstock, one of the principal towns of Windsor county, found a fawn lying in the brush, shivering with the cold. The mother deer had left it, and after waiting 3 hours Mr. Hoadley picked it up, carried it home, and wrote to the State game commissioner, who directed him to care for it. The little fellow plays about the house, sleeps in a rocking chair; seems to enjoy the society of human beings, and laps their hands, exhibiting all the apparent affection of an intelligent dog. The kind hearted farmer would like to keep the little fellow for a pet, but the law will not allow it; and as soon as it is able to care for itself, the fawn must be liberated.

Right in the heart of the Green mountains, in Rutland county, is the little village

of Sherburne. There a good story is told of "Uncle Billy," a large buck who had grown so tame that he often fed with the cattle, in the farmers' barnyards. During the summer Billy had pastured with some young cattle, back on the mountain's side.

After they were driven home for the winter, late in October, Uncle Billy began to get lonesome and one cold day, the last of November, he left his fellows of the forests, went to town and established his headquarters in the sheds near the old church, in Sherburne.

He soon came to be recognized as one of the fixtures of the little village, and expected and usually received daily rations from the villagers.

When food was not placed at his disposal, however, "Uncle Billy" would make good the deficiency by stealing fodder left by horses, in their stalls.

For some time the old fellow was a great pet, but he finally became unruly and ugly and now and then knocked down his benefactors, which of course did not please them.

At length the villagers began to think of getting rid of "Uncle Billy;" but how to do it and evade the law was the question.

To shoot the old fellow would be a breach of the law, punishable by a heavy fine. One Sunday morning matters came to a crisis. "Uncle Billy" was feeling uglier than usual, that morning. He appeared on the street, just at church time. A venerable deacon was on his way to divine worship, "Uncle Billy" caught sight of him and gave chase. Just as the deacon was entering the church door the infuriated buck gave him a foot-ball push from behind and the little congregation was treated to the unusual spectacle of Deacon — making a "Kelly Slide" to his family pew. The sequel to this unholy act was not far distant. Next morning "Uncle Billy" was found dead in the horse sheds, back of the church. Paris green, in a manger of corn meal, had done its work well and faithfully.

That the wooded mountains and valleys of Central and Northern Vermont are full of deer is not to be questioned, for a moment. The stories of farmers generally and the statement of the Essex county men to the last legislature, in particular, give ample proof of an abundance of the animals in many sections. State game commissioner Titcomb is authority for the statement that there are more deer in Vermont than in either Maine or the Adirondacks; and he is not given to talking at random. Certain it is that by October 1st, there will be few, if any, better deer hunting grounds in the East than among the Green mountains of picturesque old Vermont. D. L. C.

#### SPORTSMEN'S EXHIBITION IN BOSTON.

An announcement which interests every true sportsman comes from Boston, giving

a general outline of the plan on which the first exhibition under the auspices of the New England Sportsman's Association will be given in the Mechanics' Fair Building, Boston, March 14 to 26 inclusive. This is to be, essentially, a sportsman's exhibition with numerous delightful gleanings from forest and stream and with actual, practical, demonstrations of life in the woods, controlled and managed by true sportsmen, and will by no means be the conventional "trade show." On the roll of membership of the New England Sportsman's Association one finds inscribed the names of nearly all the representative sportsmen of the East, many of them of national reputation, whose broad, liberal policy and true sportsmanship bespeak a most comprehensive and successful exposition.

Here the visitor will find all the latest and most improved paraphernalia pertaining to life in the woods, with the newest inventions in rifles, shot-guns, rods, reels, and shooting and fishing outfits. Electric and naphtha launches, ducking boats, canoes and kyaks will form an interesting exhibit, their peculiar features and possibilities being demonstrated on a miniature lake, where also various exhibitions of aquatic sports will be given.

Realism—not idealism—is the watchword of the association, whose game preserves will form a startling exhibit, abounding in superb specimens of elk, moose, caribou, deer and antelope—not menagerie or circus stock, but trapped in the forest, especially for this exhibition. There will also be many cages of game birds—quail, grouse, prairie chickens, etc., and a huge enclosure wherein will be shown a great variety of game mammals.

But perhaps the most fascinating of all will be the demonstrations of life in the woods, from the picturesque Indian camp, and the log cabin of the trapper, to the temporary lean-to of the amateur sportsman, all equipped with practical utensils and paraphernalia, and each presided over by guides—Indians, Canadians, hunters and trappers from all parts of the country.

The basement, which is light and airy and in every way perfectly fitted, will be utilized for ranges on which rifle and revolver contests will occur; while an art department for amateur photography, now so popular a pastime, will undoubtedly be established in one of the galleries.

Each department will be in charge of the leading sportsmen of New England, in their respective lines, and will be managed intelligently so as to appeal to the devotees of each particular sport. Plans of the building and other details are being prepared and the trade will shortly be furnished with full particulars.

Inquiries, applications for space, etc., may be addressed to The New England Sportsman's Association, Boston, Mass.

## THE INDIANA QUAIL LAW.

Anderson, Ind.

Editor RECREATION: I notice in your August number a communication from Stanley Waterloo, Paoli, Indiana, that is misleading. He says, "The law protecting quails in Indiana, allowing no open season for 2 years, has resulted in a noticeable change in the habits of the birds."

There is no such law on the statute books of the State of Indiana. Section 2209, Burns' Revision of 1894, reads.

"Whoever shoots or destroys or pursues, for the purpose of shooting or destroying, or has in his possession, any quails or pheasants during the period from the 1st of January to the 10th of November of the same year, or shoots or kills any wild turkey between the 1st day of February and the 1st day of November of any year, shall be fined in the sum of \$2 for each quail, etc."

You will observe the open season is November 10 to January 1, inclusive. House Bill 97 approved March 3, 1897, prohibits the killing of grouse or quails for market. Our last Legislature is entitled to the thanks of all self-respecting sportsmen for the destruction of pot hunters. The law referred to is as follows:

"Section 1. Be it enacted by the General Assembly of the State of Indiana: That it shall be unlawful for any person to pursue or kill, within this State, any quail, ruffed grouse or pinnated grouse for purposes of sale, barter, traffic or removal from the State, or to sell, barter, keep, expose or offer for sale or remove from this State any quail, ruffed grouse or pinnated grouse caught or killed in the State of Indiana."

This statute has a penalty provided, in section 2, in the sum of \$1 for every quail, ruffed grouse or pinnated grouse so unlawfully pursued, etc., for the purpose of sale.

No doubt Brother Waterloo feels, as most other sportsmen in this State do, that the pot hunter and market butcher are largely responsible for the almost extermination of the quail. I have, within the last 15 years, seen 25 or 30 covies of quails in a day's sport, and have, on many days, bagged 2 dozen birds. Last year, during the open season, I think I did not, at any time, bag to exceed 8 or 10 birds in a day's hunt. I understand, from farmers in this vicinity, the prospect for good shooting, this fall, is better than it has been for many years.

I am delighted with RECREATION. Am a regular subscriber and through a local news dealer have sent annual subscriptions to some of my friends. I have sportsmen's journals that cost me 3 times the price of RECREATION, that are tame compared with this splendid magazine.

O. M. Keltner.

## IDAHO NOTES.

M. W. MINER.

Some 3 or 4 miles from the goat lick, in Dead Man's canyon, Boise Co., Idaho, is a high table land dotted with numerous small lakes, one of which is the source of Warm Spring creek. This lake simply swarms with the salmon trout, or Dolly Varden trout, and peering down into its clear waters one can see thousands of them. One peculiarity of them is that when one bites they all bite. At other times not a nibble can be had from any of them, though bait or fly be dragged under their noses. Like the small girl "when they're good they're very, very good, but when they're bad they're horrid."

On our arrival there not a fish could be induced to rise to a fly, rush at a spoon hook or to taste venison, grass hoppers, white grubs or even a mouse; yet we could see hundreds of trout beneath our raft. Finally I became desperate. I made a lariat from a piece of silk line, and fastening it to the end of the rod snared a beauty that was more than sufficient for our dinner.

About 3 p. m. the trout commenced jumping and would bite at any thing thrown on the water. We frequently had 2 or 3 fish hooked at one time.

In the course of an hour they suddenly ceased biting and not another rise could we get. Nor could we tempt them with bait.

Parties visiting these lakes often catch a horse load of fish in an hour or 2. At other times they are unable to catch a fish for days together. Why?

\* \* \*

It is estimated there are between 2,000 and 2,500 mountain sheep now inhabiting the slopes and mountains of the Middle Fork of Salmon river, mostly in the vicinity of the upper end of the great canyon, which is about 60 miles from the main Salmon river. The country is almost unexplored and inaccessible. Two trappers who wintered in that country, last winter, told me of them, and said from their cabin door it was almost a daily occurrence to see bands of 60 to 100, feeding on the bare hill sides, near the canyon. Dietrick said there were two rams in the outfit that would almost catch Sheard's prize; but that he was not sufficiently up in sheep hunting to capture them. He said he used to watch the sheep, with his field glass, by the hour.

\* \* \*

We camped 10 days near the big licks on Sulphur creek, near the Middle Salmon, and it was indeed a rare treat to be there. A camera fiend would simply have reveled in the chances. Morning and evening, and all day long, deer would come into the licks; sometimes alone and sometimes 2, 3 or even as many as 8 in a band. Oftentimes

they would carefully approach our tent; stopping at short intervals and stamping their fore feet as if impatient.

I found that by holding a bright red handkerchief before my face I could, by making short advances, and then halting, approach to within 40 or 50 feet of them. It was amusing to see them wheel and run when I would throw down the flag.

The bucks were all in the velvet. I saw many beautiful sets of horns. A 3 pronged buck, that often visited the licks, was the largest deer I ever saw. He would outrank all the other deer in height, by some 8 inches, and was much broader across the back and shoulders. Many of the yearlings were but little larger than fawns.

The deep snows of last winter, in the mountains of Idaho, caused the death of a great deal of large game. We found several deer that had died from starvation and some trappers told me that never before had they found so many dead or dying deer.

\* \* \*

In the vicinity of Canyon creek, on the South fork of the Payette river, roams a monster elk. I saw his tracks and they are larger than those of a work ox. We found one horn he had shed and it measured, at the base, above the crown,  $10\frac{1}{2}$  inches in circumference, and  $53\frac{5}{8}$  inches in length. We left it at the cabin of a trapper, near there. He told us he had gotten glimpses of the elk but had never been able to get a shot at him, and that he looked as large as a bull moose. This elk has been known of in that vicinity 4 years. What a prize he would be for a real sportsman. But he will doubtless fall a victim to some prospector or trapper, who will complain of the tough steaks and, on account of the law, will hide the head and skin in the brush, to go to waste.

\* \* \*

Just above the mouth of Dead Man's canyon, in Boise County, is a goat lick. It is a warm spring whose water has a slight alkaline flavor, and is greatly relished by big game. It is constantly visited by the numerous goats that inhabit the rocky, snowy range of mountains, there. The tracks in the immediate vicinity would lead a tenderfoot to imagine a few thousand sheep had been there to drink. In July and August the lick is also visited by numerous deer and some few elk. It is indeed a charming spot for the man who seeks to add to his trophies, for he can sit in a blind and take his choice, at a range of about 100 yards.

---

#### WHERE TO FIND GAME AND FISH.

Dotsero, Col.

Editor RECREATION: During the summer and early fall, many tourists visit this locality to hunt, and to fish in our streams

and lakes, which are well stocked with trout. Last autumn I made frequent trips up Deep creek, a picturesque mountain stream, after trout. My catches numbered 10 to 12, ranging in length from 6 to 12 inches.

The fish I have seen here, thus far, are all salmon trout. The largest I have heard of, taken from Grand river, measured 23 inches.

Though an excellent fish, still, I do not think its flavor is so good as that of the little fellows back in the Pennsylvania streams.

Here, I prefer the brook trout to those taken from the lakes; while for sport, I take the stream every time. Then, too, I would much rather catch a 2-pound trout, in a small stream, than a 6-pounder in a river like the Grand.

This Deep creek is the outlet to Deep lake, a fine body of water, almost 10,000 feet above sea level, hence the clear waters of lake and stream are always very cold. I venture to say a sportsman and lover of nature, after having made the trip along this stream, from its source to its mouth, would feel amply repaid for his journey, though he had come hundreds or thousands of miles. The canyon through which the stream flows is from 2,000 to 3,000 feet in depth. I think it equal to the famous Royal Gorge of the Arkansas. Standing in a narrow part of the canyon and looking upward, one can get an idea of its immensity. On either side are perpendicular walls of solid rock, while the sky is only a narrow band of blue. To leap from one wall to the other would, apparently, be an easy task.

Along the rocky cliffs are mountain sheep, and it is to be hoped they are safe from hunters. Among the neighboring hills are deer, elk, bear, grouse, and other game. Here, too, is a magnificent field for the amateur photographer. Innumerable views may be had, while pictures of wild animals can be easily secured.

Not behind Deep lake, in attractiveness, is Sweetwater lake, without exception the prettiest little body of water I have ever seen. I have, on several occasions, spent a few days there, catching trout. There seems to be an inexhaustible supply of them in the lake; but of this more anon.

I heartily endorse your course toward the men who mercilessly slaughter game.

L. D. Gilmore.

---

WHAT CONSTITUTES A REASONABLE BAG.

Lindsay, Ont.

Editor RECREATION: I have taken RECREATION, for the past 6 months, and am very much pleased with it; and especially with your earnest attacks on the game hog.

Allow me to express my opinion of the people mentioned by Mr. Roche, in August



RECREATION, who killed 300 squirrels in a season and 105 quails in one day I think those men are pure *hogs*, with the emphasis on the whole word.

Mr. Roche says they are expert hunters. I would like him to tell me what difference that makes. Because a man can drop 105 quail in 10 hours, he is not justified in doing so.

My definition of the term game hog is "one who does more than his fair share in the extermination of game." This leads to the question, "What is his fair share?" In my opinion Mr. John F. Knight was a hog, that day, by about 80 birds. How many quail will be left in Posey county in 5 years, at that rate? This is a problem that should have the serious consideration of every true sportsman.

Last fall I had an opportunity of playing hog with ruffed grouse; but stopped short on my 15th bird, although I had not been out much over 2 hours.

This is a good country for bass, muskallonge, ducks and grouse; and to all readers of RECREATION I extend a hearty invitation to come over and enjoy some good sport. This invitation, however, does not apply to John F. Knight & Co.

Arthur S. Parkin.

P. S. I intend taking some photos of deer shooting, for RECREATION'S competitions, this fall.

Noting your request for an expression of opinion, by your readers, as to what is a reasonable bag of game for one day's shooting, where the law names no limit, I wish to say I think a reasonable bag of game for one, 2 or 3 days' shooting is all one can kill with a gun, and make good use of, either personally or by putting it in the hands of others who can and will make good use of it.\* It is more reprehensible to kill one game bird and let it spoil than to kill 100 for which the shooter has need and which he can preserve and take care of.

It is unlikely anyone will make an unreasonable bag under such conditions, as the growing scarcity of game keeps limiting the shooter's capacity to kill, and in remote sections, where game is still abundant, the shooter's capacity to use it will be the limit.

I say "kill with a gun" for I don't wish to open the road to the ink hunter; for of all classes of hunters the ink hunter is the worst game destroyer.

It is so easy to go out and shoot away a whole bottle of ink, and never miss a shot, that the bag usually grows to such undue proportions as to disgust even a market hunter. He is likely to think he is not get-

\* This is a very extravagant theory, for this age of the world, and I am sure Mr. Jaques will find few men, among the readers of RECREATION, who will agree with him.—  
EDITOR.

ting his share, and to redouble his efforts, while the farmers, country merchants, and rural sportsmen generally, seeing how utterly impossible it is for them to get their share during the open season, improve their opportunities the year round.

E. P. Jaques, Geneseo, Ill.

In the August number of RECREATION I read the report of Mr. Roche regarding a friend who he says killed 300 squirrels in one season; yet Mr. Roche claims the man is not a game hog. I think he is.

If every shooter should kill that many squirrels, in one season, there would not be enough left in the whole State of Indiana to stock an apple orchard.

As to what constitutes a good bag, for a day's shooting, my idea would be 3 or 4 squirrels a day, killed with a 22 calibre, or other small bore rifle. The idea of a man going out with a shot gun to kill a little squirrel, that will sit still and let you shoot at him, is decidedly unsportsmanlike, to me.

I expect to take a hunt this fall, in Michigan, after big game, and if I bring out one good head, shall consider my hunt a grand success.

D. Wogaman, Quincy, O.

You ask for opinions of your readers as to what constitutes a reasonable bag of game. I consider the figures you set down very liberal, say 15 to 25 quails or 10 to 15 ducks, chickens, or squirrels. This would make a fine day's sport.

I look upon the man who goes out every day he can, and shoots all he possibly can (to make a record), as being no better than the market hunter. The one shoots for gain. The other to satisfy a selfish ambition, without any thought as to the protection of the game; and it is a poor excuse for him to say he did not let the game waste, but that he gave it away to his friends. The fact of his thinking it necessary to make any excuse, shows he knows, in his heart, he has done a mean piece of work.

I am pleased to see you take this matter up and will be glad to read the opinions of others.

T. A., Rochester, N. Y.

#### ON THE YELLOWSTONE.

During our outing in Montana, in 1896, the severity of the weather was phenomenal. Leaving St. Paul on November 4th, we reached Glendive on the 5th, and the evening of the 6th found us snugly camped, under a double tent, on Big Bear island, in the Yellowstone valley. There was every evidence of stormy weather and we made unusual preparations for keeping out the cold.

We banked up and trenched around the

tent, laid in a good supply of dry cotton-wood, fixed our bunks well up from the ground and retired, the first night, to the music of a Northeast gale, with snow. We awoke to find a zero temperature and plenty of snow.

This was simply a foretaste, for there followed 15 days of weather ranging from zero to 28 degrees below. The snow increased in depth until we had about 15 inches on the level, in the valley. Through all of this we were warm and snug in camp. Thanks to the double tent and a good Cree camp-stove, the lowest temperature inside, on the coldest night, was above freezing; and no one ever got up in the night to build fires.

The shooting was good; white and black-tail deer; grouse, antelope, with occasional brushes with grey wolves and coyotes to keep the interest up. We tried smokeless powder cartridges and I found, to my sorrow, it is quite easy to overshoot unless sights are readjusted. We got more game than we needed, and finally grew careless and indifferent. We are not game hogs, and 4 deer each seemed quite enough.

With these thoughts of past pleasures there mingles the inevitable vein of sadness. George Leonard, the partner of our outings during the greater part of the last 20 years, has crossed the valley. A lump comes to my throat as I think of him. He escaped the exposure of our outing only to fall a victim to pneumonia, during our changeable spring weather

A. A. C., Toronto, Can.

#### A SPORTSMEN'S EXCURSION TO INDIA.

Being about to form a party for this purpose I shall be glad to communicate with any gentlemen wishing to avail themselves of my services. I am willing either to contract to defray all legitimate expenses, from the date of departure until return to New York, for a fixed sum, or, if preferred, will accept my expenses and a fixed fee from each passenger. There will be no "roughing it" in my camp.

The game to be had, in large numbers, is antelope and gazelles, ducks, quails, snipe and grouse, with a possibility of larger game. The natural and architectural beauties of India require no description. Let me hear from you.

C. E. Ashburner, Richmond, Va.

#### CATCHING WILD DUCKS.

York, Neb.

Editor RECREATION: These long summer days are tiresome to any sportsman who has to keep in doors on account of ill health, and I am one.

I read with great pleasure your most valuable RECREATION and consider it the best

periodical I ever had the pleasure of reading.

Game in this locality consists mostly of quails, chicken and rabbits. The former are very plentiful this year.

I am waiting, patiently, for the 1st day of October, when the law is out. Then I expect to enjoy myself for a few days.

I wish to ask, through RECREATION, if any thing like this was ever noticed by any sportsman. A week ago I was out in the yard and saw 8 young ducks, which, on examination, proved to be blue wing teal, too young to fly. I caught them and have kept them ever since. They eat and drink and seem to enjoy yard life very much. Again this morning I was at a neighbor's house and he said:

"I caught 6 young ducks yesterday, out by the water tank."

I went to look and found these were teal also; but instead of 6 young, there were but 5 young and the mother. They are very tame. The old one comes to you and will eat out of your hand.

I never heard of such a thing before. The only cause I can find, that would tend to bring them to the houses, is the want of water, as the basins are all dry and many ducks were hatched last spring.

This party recently started for the Rocky mountains, on a 2 or 3 months' outing: Thomas Hamilton, Court Reporter, and wife; A. W. Richardson, Court Reporter, and sister; Glen Becker, of David City, and Thomas Epley, wife and 2 sons, of Denver. They outfitted at Denver and went to Steam Boat Springs and down on White river.

J. W. Stapleton.

#### NOTES.

The prospect for game in this locality is good. There has been a great deal of rainy weather but I don't think it has hurt the young birds. Grouse will be about as usual, 5 or 6 birds being a good day's bag, and one must know the ground, in order to get them. Furthermore you must have a good dog, familiar with the birds of this section, without which a man would be more comfortable at home, and would get just as much game.

Quails are very much in evidence and there should be an extra large crop this fall. Woodcock are an uncertain quantity. We depend on the flight, for our shooting. Most of the woodcock raised here leave before the season opens. After all there is little satisfaction in killing summer woodcock compared with the shooting of the big, strong, flight birds of October.

The game of this vicinity has changed a great deal, in the past 20 years. When I first commenced to shoot, grouse were comparatively plentiful, while quails were unknown. I remember the first grouse I

killed. No one to whom I showed it knew what it was. Now quails are quite plentiful and grouse have grown beautifully less. I think this is accounted for by the fact that much of the cover has been cut off, making the conditions much better for quails than for grouse. The open season, on our birds, should be shortened at least a month. Make it unlawful to shoot upland birds until October 15th, giving the young grouse a chance to become stronger of wing and more worldly wise.

H. F. Chase, Amesbury, Mass.

Fridley, Montana.

Editor RECREATION: Last winter I took a trip up the mountain to see if a bunch of 3 does I knew of had increased in number, during the year. I found where they had been staying for some time; and then saw fresh tracks leading down to a creek, where I expected to find them in the bushes. They had gone on up the mountain on the other side. Half way up I found their beds in the snow, 8 of them.

Like a boy after a rabbit, I stayed with it, to see if there was a buck among them. I had a new Winchester 30-30 and wanted to give it a trial. The snow was knee deep and the going heavy. A mile from their beds, I came up with them, pretty well tired. They were all lying down among some scrubby firs. I crawled to within 30 yards and looked the deer over—5 old does and 3 fawns. Not a buck, so my hard work was for nothing.

If these deer are let alone, in a few years there will be a good number of them. Grouse are plenty enough for fine shooting. Fifteen miles from my place there is a band of mountain sheep, 26 in number. There are some fine rams among them.

Recently I had a letter from my brother, who was in Yellowstone Park during the winter. He says young elk died, during the winter, in large numbers. Last year was dry, so grass did not grow well, and the ranges were eaten off so close that there was not feed enough, in the winter, for the elk.

In the park elk increase rapidly, and if the game law was enforced in Montana, elk would drift out of the park, to the North, and soon be plentiful here. They would find better feed than in the park, and in a few years would be as plentiful as they now are to the East and South. Now, if an elk crosses the line, there are men after him at once, with all kinds of guns.

W. A. Hague.

Greenville, Ohio.

Editor RECREATION: There are always 5 or 6 young fellows here, waiting to see RECREATION, about the time they think it should come. Want to see the pictures,

you know. The old man gets a little fidgety about that time, too.

Wisconsin now has a law requiring all non-resident deer hunters to pay a license fee of \$30. I have hunted in Wisconsin and Michigan, nearly every fall, for 18 years. Sometimes 5 to 6 of us go, and stay 2 or 3 weeks. In all that time I don't think we averaged one deer to the man.

On one of my annual hunts I met a native in the woods, one day. He admired my rifle, and said he was going to get a new gun, for he had killed enough deer that *summer* so he could sell the pelts and buy one. I asked him how many deer he killed. His reply knocked the wind out of my sails—"97 deer!" Just think of it, and weep! Ninety-seven deer killed for their skins!

On another trip I stopped at a cabin, in the woods. While talking with the man, I glanced into an old shed. There I saw a stack of deer hides over 3 feet high. The man told me he killed deer all summer. Said he ran lots of deer down in winter, when the snow was deep. He hunted for the market. Just think of these things, ye wise law-makers!

Tamarack.

Game, such as rabbits and quails, is more plentiful this fall than for several years, because of the excellent cover for hiding last year, and the new rabbit law. Squirrels are scarce in this vicinity, on account of the depredations of the 2 legged rioters. Fish are also getting scarce, because of the market hogs netting them. Several men were taken, with their nets, but they claimed they were catching turtles, and the mayor did not know the difference.

There were also some rabbits killed here, during the close season, but the men claim they did not hear of the new law. I think the game commissioners ought to issue a great number of pamphlets and distribute them over the country; or better still send RECREATION to all poachers and pot hunters.

Your efforts in making a sportsmen's journal have far exceeded my expectations, and RECREATION will always be a welcome visitor in my den. I am pleased to see it gaining favor with so many sportsmen, and hope it will soon reach 1,000,000 circulation.

I want to ask you if you think the Remington shot gun will stand common charges of nitro powder.\* Hoping to hear from all brother sportsmen on some subject, I am

David I. Shafer, Covington, Ohio.

With the exception of the buffalo, big game in the Yellowstone park, is increasing and it is estimated there are 25,000 elk here. Any day one can see bands of 75 to 100, by going an hour's ride from the Grand Canyon hotel. The best authorities place

\* Yes.—EDITOR.

the buffalo at 25 head, and it is positively certain there are not over 30.

The Allard herd is in fine condition and number about 250. They are located about 65 miles from here. Dr. Baker, director of the Zoological Garden at Washington, has just bought 3, for which he paid \$500 each.

Dr. Baker passed through here to-day and says the bear have increased to such an extent, and commit such depredations on the young antelope and elk, that the government will be compelled to take steps for their destruction. Last Friday evening, about sunset, 13 of these animals fed at a scrap heap,  $\frac{1}{4}$  of a mile back of the Fountain hotel, in the Lower Geysers Basin.

On July 28th Billy Sisson, a poacher, was arrested for killing an elk within the borders of the park. He was fined \$250 and sentenced to 3 months in jail. Eli Waters, president of the Yellowstone Steamboat Co., has 4 buffalo on Dot Island, in Yellowstone lake. He also has a female mountain sheep, which he claims is the only one ever raised in captivity.

Bald Eagles are numerous in the Canyon, and several nests can be seen from Inspiration Point.

J. P. Webster,  
Grand Canyon Hotel,  
Yellowstone Park.

Can this method of killing be called sport; or can it be patented?

A miner, working near this camp, met a mountain lion at close quarters. The beast sprang at the man, who had nothing with which to defend himself but a can of cyanide of potassium. He threw this, hitting the lion fairly in the mouth. At the same time he threw himself flat on the ground.

The lion, from the force of its spring, went clear over the man and before the varmint could recover himself the deadly cyanide got in its work and the miner came home dragging the lion behind him. Every inhabitant of this city, myself excepted, will make his oath to the above facts. Furthermore, these same people will make said oaths go!

Dr. J. E. Miller, Aspen, Colo.

That's all right about the oaths; and I don't want to get any of those Colorado chaps on my trail; but all the same I don't believe the story. The mountain lion, or cougar, is one of the most cowardly beasts on the earth, and I don't believe one ever sprang at a man, unless cornered in some way where he could not move except toward the man; or unless he were so badly wounded he could not get away.

This miner might easily have stolen a march on the lion, in some way, and have gotten a whack at him with a can of cyanide; but the lion never sprang at the man, with his mouth open, to receive it.

EDITOR.

#### A HANDY COMPASS.

When in the wilds, and for any reason somewhat "twisted," so that I do not know where I am, I have been in the habit of making use of a scheme which I came across some years ago, and which never fails. It may some time prove of use to some reader of RECREATION, so I will describe it.

Point the hour hand of your watch at the sun, wherever it may be, and exactly halfway between the hour hand and 12 o'clock (the figure XII on the dial) will be due South. From this, of course, any other direction may be determined. Even on a cloudy day, if an object is held up and the shadow looked for carefully, the position of the sun can usually be determined.

Sepia, Allegheny, Pa.

I am in receipt of a letter from Capt. W. C. Brown, Commanding Troop E, 1st Cavalry, who made the 10 days' march on an allowance of one-half the emergency ration, as stated in August RECREATION. Speaking of the march, Capt. Brown says:

"It might be desirable to modify our emergency ration to some extent to suit tastes of sportsmen, who dislike so much fat meat. Our ration contains really an excess of fats, but we decided on the bacon because we already have it as part of the regular ration. A great many will prefer ham, dried beef or pemmican, with a little bacon, to having the meat ration all bacon. The new style hard bread, and the pea meal, are excellent.

"We saw but little game—only 3 antelope, a few turkeys and quails; but then a troop makes so much noise that naturally we would frighten the birds away before coming in sight of them. The grass in this section is so heavy this year, from continual rains, that it furnishes good cover for birds, and we expect fair shooting, in the fall. Deer and antelope are scarce."

Enclosed find money order for \$1.00, for which please send RECREATION to Herman Dose. It is a pleasure to me to send you a new subscription, as I think a great deal of the little book, and would not be without it for double the price.

There are but few true sportsmen here. The rest are hunters, who like to be called sportsmen, but who belong to the class called in RECREATION game hogs, and pot hunters. They go out at all times, even out of season, and kill everything, whether lawful or not. In consequence there is little game here, and I shall have to go about 300 miles Northwest to get a little sport this fall.

L. Bennequitz, Wolcott, Ia.

In answer to many letters received let me say, through RECREATION, that Vancouver Island, B. C., is a good trapping ground. Beaver, wolves, bear, martins, and land otters are fairly plentiful on the head waters of Salmon and Campbell rivers. Salmon river empties into Johnston's straits, and Campbell river into Discovery passage, just North of the gulf of Georgia, East coast of Vancouver Island. Take boat at Vancouver, B. C., for Bear River Camp and follow up Bear river to head of right hand branch, a distance of 12 miles, thence West into a lake region barely explored. Elk, deer and cougar also abound there.

L. L. Bales, Seattle, Wash.

The deer are numerous around Pleasant Pond, this summer, and are quite tame. They are seen almost every night, feeding in the fields near the dwelling houses.

Moose also are quite numerous. Lewis Williams recently saw a fine specimen taking a bath, near the outlet of Pleasant Pond.

The outlook for the open season never was so good before.

Trout fishing is good in this locality. James Martin's house is finely situated on the shore of Pleasant Pond, ready to accommodate all sportsmen, and the guides are near.

Geo. W. Spaulding, Carritunk, Me.

I went up to the mountains, a few days ago, with Mrs. Rice, leaving her there for the summer. Caught some good trout and saw 3 deer, 2 of which I could easily have shot, as I had a rifle with me. It was a novel and not wholly enjoyable experience to see a magnificent buck standing on the shore of the lake, and not to pump any lead after him; but I have felt all right about it since, for "of such is the kingdom of sportsmen."

A. F. Rice, Passaic, N. J.

Some one asks for suggestions as to learning to shoot on the wing. I learned this before I was 10 years old, by following the rules I gave in the article I wrote for RECREATION, entitled, "In Early Days."\* It is good for any kind of shooting, as well as snap shooting. When a boy, I have killed 7 ruffed grouse, straight, in the thick brush; 24 prairie chickens and 14 jack snipe. I have never been beaten in the field.

Geo. Hayden, Jacksonville, Ill.

We have lately organized, here, the Recreation Gun Club, with about 30 members, and the following officers: President, A. M. Pride; Vice President, A. J. Olsen;

\* This article will be printed in an early number of RECREATION.—EDITOR.

Treasurer, R. D. Eppley; Secretary, J. P. Hughes.

The object of the association is the banding together of those interested in out door sports, and in the protection of game and fish. We have the best of fishing and hunting, in season, and there is no doubt of our success.

George Hall, Tomahawk, Wis.

Fishing has not been very brisk so far, but some of our local anglers have secured fairly large strings of large sized perch and sun fish. To-day I heard a quail whistling; the first I have heard this summer. Rabbits are plentiful and I predict good shooting next November. About a month ago a large black eagle was shot near here, measuring 5 feet from tip to tip of wings. We expect to have a good day or 2 with woodcock.

H. T. Severns, Burlington, N. J.

A responsible guide told me, the other day, that only 10 miles from here, on his way down, he saw 45 deer and 7 bull moose. He said he paddled within 25 feet of one large moose that was standing in the water, and one of them was standing on a camp ground I made last year. None of the moose ran away, but simply stood there and watched him. I will vouch for this, as I have seen such cases several times, within the past 5 or 6 years.

J. J. Kelley, Kineo, Me.

Game is doing well. Prairie chickens hatched liberally and quails wintered better than ever. I know of 4 nests, right in town, and you can hear the birds call at all times. We offer a standing reward for information of illegal shooting.

Fred A. Ward, Waterloo, Iowa.

The following are fairly plentiful here: Grey squirrels, ruffed grouse, quails, rabbits, hares, foxes and coons. Ducks, woodcock, and snipe are in limited numbers during the flight.

Geo. F. Lawson, Lowell, Mass.

Grouse wintered well. Each nest has hatched from 10 to 15 chicks, giving promise of great sport, this fall.

Geo. Cornell, Mt. Upton, N. Y.

I am very much pleased with RECREATION. It would be like missing my fall hunt to miss an issue of it. Our party got 5 deer last fall and expect to do equally well this fall.

F. Fessey, Reedsburg, Wis.

## FISH AND FISHING.

### TROUTING ON THE AU SABLE.

Dearborn, Mich.

Editor of RECREATION: I have enjoyed the articles in RECREATION so much that I give you here some notes of a 3 weeks' camp, on a Michigan stream, which I trust may interest some of your other readers.

We left Dearborn in August, on the M. C. R. R., to Grayling, a small town in the Northern part of our State, and went in, by team, 12 miles to the Au Sable river.

We camped on the banks of the stream, among the jack pines, and were soon among the trout.

We were up with the sun, the next morning, and while the ladies were preparing breakfast we went out again. The trout will not raise to a fly in the latter part of August as well as they do in June or July, and we therefore fell back on the old reliable grass-hopper. These we found in great quantities and with our scheme for catching them it only took a few minutes to get enough bait for the day. This scheme consists of 2 pieces of mosquito netting, about 15 feet long. Two of us take one piece and 2 the other. Separating about 30 feet, we keep the netting in an upright position with the one edge on the ground. We walk toward each other and on meeting double the nets and find we have 100 to 300 hoppers. These we fish out and roll in strips of cloth 2 inches wide. We are now ready for business.

My father and "Blackberry Jim"—so named for his record breaking capacity for blackberries—went up to wade down, while "Art" and I got in at the camp and went a mile or so below. We had excellent sport with some large rainbows. Art struck some white clay, on the bottom, right on the verge of a big hole, and said he guessed he would back out; but the swift current carried him into the hole, out of sight, and he came up some 30 feet down stream.

He reported having seen some fine specimens of trout, while scraping along the bottom, which he intended to lay for on the following day. We returned to camp, by an old logging trail, and found the other boys in with a good catch, which they had kept alive and placed in a crib, for use in case we should run short. By having a box made of lath, about a foot square, with open space through which the water can pass, and a hole on top to put the fish in, it is an easy matter to keep your fish alive by letting the box float in front of you, held back by a string about 4 feet long attached around your waist.

After supper we had our pipes, and enjoyed the camp fire until a late hour. And thus all the days passed.

We did not fish every day; but caught only what we needed to eat, and if the crib got over-stocked we laid off and went for berries.

The Au Sable is a pretty stream and is full of trout, but has very few grayling. We have camped on the Big and Little Manistee, Sturgeon, Pine and Brule rivers; but find the Au Sable better fishing than any of the others.

I am but a recent subscriber to RECREATION but have found it the best sportsmen's journal I have ever read. If any reader wishes any information about the streams I have fished on I should be only too glad to give him what points I can.

Lew Howe.

### THE REDFISH OF IDAHO.

In the June number of RECREATION there was an interesting article by Lieut. C. B. Hardin, in which, writing of redfish found in Central Idaho, he says: "I have never seen or heard of them in any other place." In a foot note Prof. B. W. Evermann, ichthyologist, was given as authority on the naming, etc., of this fish.

We find redfish in several small inland lakes in Western Washington. I think the Professor is "off" in several of his assertions regarding our salmon. I reside, during the summer, on a lake about an hour's drive from our city. About a mile from us there is a body of water now called a lake. It was originally a small, glacier-fed stream, emptying into Puget sound. Years ago a dam was built across a narrow place between the low hills. Since then this stream, filling up between the hills, has become a lake, deep in places, with trout and other fish, since planted by the U. S. Fish Commissioners.

Every September, for about 2 weeks, redfish appear in countless numbers, and afford good fishing. They take worms or other bait readily. They are, in color, red on sides and back. The head and throat, and close up to tail, are dark, with silvery spots. The fish are scaleless. In shape they are a duplicate of a salmon, and are 10 to 12 inches long. The flesh is red and free from bones. Cut the head from one and place it alongside that of a salmon—a silver-side female—and you would think it a miniature duplicate. Old residents say it is a landlocked salmon. We do not see them during other months, for they are in deep water. They cannot run up stream, for an artificial trout-pond has been put in at that end of the lake.

Can the Professor account for this variety of fish? He is greatly in error when

he says red salmon run up the Columbia river from the sea. Salmon are not red until they enter fresh water; and they certainly do return to their ocean feeding-grounds and are taken in seines at the mouth of such rivers as the Puyallup, Nesqually and Snohomish. After spawning season they are red—or partly so.

As for salmon dying after spawning—great heavens! There would be millions of dead fish coming down the Columbia, instead of the millions that are now caught and canned.

I have seen Columbia river salmon 4 feet 10 inches long. North of this river they seldom grow longer than 26 to 40 inches and few of 40 inches are taken.

A. L. Lindsley.

---

#### FISH SHARPS IN OREGON.

New Pine Creek, Oregon.

Editor RECREATION: We are in camp on the East shore of Goose lake, a few rods above the Cal.-Ore. State line, or 16 miles South of Lakeview, Ore., the only town of any size within 175 miles. With 2 assistants and a cook we left Ashland, Ore., July 15, with one big wagon and a light spring wagon.

Coming via Klamath Falls we reached Goose lake on the 20th inst., having driven close on to 200 miles over several mountain ridges and across an equal number of small valleys. *En route* we passed several streams that would be famous for their trout if they were nearer New York. Klamath, Lost and Sprague rivers, and Spring creek, are all full of magnificent black-speckled trout that rise readily to the fly. They reach a weight of 2 to 14 pounds and are regarded as being very hard fighters by expert anglers. The fame of the Sprague river and Pelican bay trout has already reached the East and several pioneer anglers, from that region, have visited those waters.

Goose lake is about 40 miles long, 10 miles wide, and 8 to 23 feet deep. It is well supplied with a handsome variety of the black-spotted trout. It is quite silvery in color, with few spots, and no red on the throat. It attains a weight of 2 to 10 pounds, is as game as any one would desire and is very delicious.

From here we go East, 50 miles, to the Warner lakes: then North to Abert, Summer and Silver lakes, when we return to Ashland.

The object of our trip is to determine the physical and biologic features of these lakes, in order that the U. S. Fish Commission may know how best to improve their fish supply, should any such step ever become necessary.

B. W. Evermann.

#### BROWN TROUT IN MICHIGAN.

Grand Rapids, Mich.

Editor RECREATION: Your favor of July 26th, together with the letter from A. N. Cheeny, of the State Fishery, received, and I want to show this letter to our Michigan fishermen, and see what they have to say about it.

Since I saw you, I have been on Baldwin creek and have tried to catch some of these brown trout, but have been unable to raise them, either with a fly or a minnow. This stream was planted a good many years ago and the fish are very large. I believe some of them would weigh as much as 10 pounds. In fact, one was speared there that weighed 11 pounds.

The people connected with our fisheries all regret having planted this brown trout in the Baldwin, for it had been a good rainbow trout stream, until the brown trout were planted and drove them out.

No more brown trout will be planted in any of our other streams.

The fish is a beautiful one, and as it grows to a great size, I am interested in learning all I can about its habits. Mr. J. Van Valkenburg is one of our most successful trout anglers, and he tells me he has caught the brown trout on a minnow, at night. He says he has also had them rise to a fly, after dark.

I should be glad to see in RECREATION an article from some one who is posted on the German brown trout and its habits, and am sure it would be read, with interest, by a large number of Michigan anglers.

J. Elmer Pratt.

---

In reply to your comments on my items, published in August RECREATION, I wish to say, I have never guided a party who ever destroyed one pound of trout. I ought to have said, in my previous letter, that all of these trout we did not eat, were put back into the water. If you catch trout on the fly, 9 out of every 10 caught, if returned to the water at once, will live. I have never been with a party that wanted to catch trout for the sake of destroying them.

Nor have I ever yet seen a sportsman who did not want to have all the sport he could get out of his vacation. If a man catches 100 trout, and returns 90 of them to the water, why call him a game hog?

These gentlemen carried home with them only 20 pounds of trout, while the law allows them 25 pounds each. Do you call that destroying trout?

I do not call 60 trout, in one hour, very great fishing, as in that time, at Grace pond, you will get 3 at a cast, perhaps 4 times, and 2 at a cast, 6 times.

I am not finding fault with you for roasting people who destroy fish or game. I hope you will give it to them, at every op-

portunity; but I want to clear Messrs. Wadleigh and Wheaton of any blame.  
Geo. C. Jones, Carritunk, Me.

ANSWER.—Mr. Jones' statement exonerates Messrs. Wadleigh and Wheaton in a measure, but not wholly. I insist that the taking of 60 trout in an hour is not sportsmanlike even if you do occasionally get 3 or 4 at a cast. It is pot fishing. A man must simply "yank them out," in order to make such a score. A refined sportsman, when he gets 3 or 4 trout on a cast, plays them at least 15 to 20 minutes before trying to land them.

Furthermore the refined sportsman does not catch 100 or 200 trout and return them to the water, just because he can. He takes a dozen or 20 fish and then quits, for that day, and lies in the shade or roams through the woods enjoying nature. He does not fish for a record. He does not carry on a war against the fish or the game.—EDITOR.

#### HOW TO KEEP MINNOWS.

I notice that A. D. Curtis, Marinette, Wis., in an article on "Trouting on the Thunder," says: "Our minnows kept hard and fresh, by our method of packing."

Would you kindly let me know by what method they were packed? I find it very hard to keep minnows alive.

I referred this inquiry to Mr. Curtis, who replies as follows:

Regarding the best method of preserving minnows: Don't net them until the last moment before starting. Dump them from the net into the minnow pail, without touching them with the hands. Keep the pail in a cool place.

The minnows, when crowded, soon exhaust the oxygen in the water and unless it be frequently changed they will come to the top to get the oxygen from the air; but this does not seem the natural way for them. Unless supplied otherwise they soon die. A bicycle pump, with long stem, can be used to good advantage in charging the water with air, if change of water is not convenient.

I have seen minnows do well when driving over a rough road; for the water will mix oxygen by splashing around in the can.

As fast as they die pack them in corn meal. Give the survivors a bracer by putting in a few drops of brandy. You will be surprised to see how it livens them up. Unless your journey is too long you will probably arrive with most of the minnows alive. Those you have packed in the meal you will find fresh, hard and excellent bait for almost any kind of fish. When trout would not rise to a fly, or take worms or grasshoppers, I have had excellent sport with minnows, packed in this way. They will not decompose, but simply dry up, hard.

Some say it is unsportsmanlike to use anything but flies, in trout fishing, but after a long and expensive trip, to a trout stream, I like to catch some, and if they will not rise to a fly, I entice them with something more plebeian, such as minnows, worms, or grass hoppers. Many times when unsupplied with bait, I have made excellent catches by using trout fins, gullets, or eyes. The latter especially seem to have a charm for a trout, whether hungry or not.

A. D. Curtis, Marinette, Wis.

#### NOTES.

RECREATION is the best book of its kind published.

The game here is scarce on account of the game and fish hogs. One man, who is working in a fish market, said he caught 1,000 trout in one week. He ought to be branded and have a ring put through his nose, so other sportsmen would know him when they saw him. Last spring we saw many geese and ducks.

While walking through the fields, and along the river, I saw a flock of 31 geese. Another flock of 18 was seen later.

About a year ago, I was fishing with a man who said his brother caught a trout in this river, the Merrimac. About 2 months ago, I was fishing and it began to thunder, so I started to wind up my line, and said I would go home. I felt a pull at my line and on reeling in I found I had a one pound trout.

Please tell me if worms are better than flies to catch trout with.

J. F. Gardella, Haverhill, Mass.

ANSWER: Flies afford the best sport whenever the trout will take them; but there are times when they will not, and at such times it is necessary to resort to worms, or other bait, in order to get the trout.—EDITOR.

Dunning's creek is a small branch of the Blue Juniata, in Bedford Co., 4 miles from this place. It is not a great stream for bass; but you can have a good day's sport there, sometimes.

On the afternoon of August 3d I packed my outfit on my bicycle and left town for my favorite place. After a ride of 4 miles I arrived at the creek and found the water in good order. After securing several small frogs I went to work.

My first cast brought a one pound bass, and during the afternoon I succeeded in landing 3 smaller ones. About 4 o'clock I set my rod, not having had a strike for some time, and went to a nearby shade tree. On arriving at the tree and looking around I was surprised to see my rod going down the stream. Before I knew what



I was doing I found myself in 10 feet of water, swimming after my rod. After a race of about 50 yards I overtook the rod, caught hold of it and let myself down to the bottom of the creek. The water just came up to my ears. I gave the reel a turn and found, to my surprise, I had him fast. Now the sport began. I found it difficult to reel him in, while in water up to my neck, but I secured him and swam to the bank. He weighed about 2 pounds.

A. S. C., St. Clairsville, Pa.

The fishing trip I wrote you of, in my letter a few days since, resulted in more pleasure, in a short time, than any similar trip in my experience. I visited Ed Walsh, an ex-guide, who has a model sportsmen's resort on Lake Shishebozanna, about 8 miles from Minocqua, Wis. I would advise all lovers of the rod, who desire good sport on black bass (both small and large mouthed varieties), wall eyed pike and muskalonge, to go to Ed's place. He is a genial, whole souled fellow, who has spent most of his life as a guide in Northern Wisconsin woods, and is a gentleman. In his wanderings, he selected this lake as his paradise, took up a homestead claim and settled down. He has a charming little wife, who superintends the "cuisine," and to say it is first class, is putting it mildly.

I caught 3 muskys, the largest only 8 pounds, and black bass until I got tired, keeping only those over 2 pounds in weight.

Wall eyed pike are the preferred table fish, at that resort, and cooked in Mrs. Walsh's inimitable style, are unequalled for flavor and delicacy.

The lake is itself a picture. It is probably 5 miles long by 2½ or 3 miles wide, in the widest part.

Deer are plentiful. Saw plenty of fresh signs and grouse are thick as bees in a flower garden. It is worth a trip up there, simply to get a drink of the delicious cold water from Ed's superb well

Bert Cassidy, Chicago, Ill.

I congratulate you on the success of RECREATION. I cannot possibly see how you can afford to give your readers so much good reading for so small a price.

It pleases me to see how you rip those fish and game hogs up the back. Give it to them. They are a scurvy lot, and deserve all you are giving them.

If you will give me a shot at that fish hog on page 88, at 50 yards, I will go you for a new hat I can make a bullseye.

I enclose you names and addresses of some of my friends who are sportsmen, and hope you may succeed in procuring their subscriptions.

L. W. M., Dillingersville, Pa.

Magdalen, Mont.

Editor RECREATION: In reply to Mr. Evermann's article, in the July number of RECREATION: The other lake I wrote of as having the Mackinaw trout, beside Elk lake, lies on the West side of the Big Hole basin, near the head of the Big Hole river, directly under the Continental divide, which is there very rugged. It is quite a large lake, I should judge about 5 or 6 miles long by ¾ of a mile wide. I don't believe it has a name. At least I never heard it called anything but "the Lake." The outlet of it is called Lake creek, and empties into the Big Hole river. The nearest railroad points are Melrose and Divide. These are stations on the Union Pacific or Utah Northern railroad, 40 or 50 miles away. I am positive the Mackinaw trout that Sawtell sent to the National Museum came from Elk lake. I was here at the time they were caught, and there are other parties here who were at Henry's lake, Idaho, at the time they were sent off, and who remember the occurrence well.

Elk lake is only about 10 or 12 miles from Henry's lake and Sawtell lived there at the time. There are thousands of pounds of other trout caught out of Henry's lake, every winter, but not one Mackinaw trout.

James Blair.

Mr. C. C. Hiscoe, 12 West 29th St., N. Y., has sent me a basket of black bass which he caught at Chapinville, Conn., 2½ hours' ride from this city. These bass would weigh about 1½ to 3 pounds each, and are unusually healthful and vigorous looking fish. Mr. Hiscoe says he caught 32 in one day, on a chain of small lakes near Chapinville, and that he threw back a number of small ones he did not count.

Ed. Ball, whose address is Chapinville, Conn., guided Mr. Hiscoe, and proved an expert in this line. He is a thorough sportsman, fishes for the love of it, and charges only \$2.50 a day, for himself and boat. He knows where all the good holes are, and Mr. Hiscoe advises any one, who may be in search of a day's good fishing, close to New York, to engage him.

I will give you a few facts about black bass fishing in Jefferson county, in the waters of Lake Ontario.

I was fishing last Wednesday and in 8 hours caught 35 small mouthed black bass. The smallest weighed one pound and the largest 5 pounds. This was the largest bass caught here in years.

Will have good squirrel hunting this fall. Grey squirrels are plentiful in this vicinity.

RECREATION is the best magazine there is for sportsmen.

C. A. Keller, Mannsville, N. Y.

## CAUGHT A TON OF FISH.

Mike Knaul and B. W. Gale, who, with their wives, went on an extended trip in the lake region of Canada, returned yesterday and were on 'change. The party originally included B. W. Wasson, who returned earlier. The object of the trip was a fishing excursion, and the points visited were near Sanfield. They fished in Clear lake, Blackstone lake, Alicelake and others, and caught, in all, 2,000 pounds. The first catch made by Mr. Knaul was a 20 pound muskalonge, measuring  $46\frac{1}{2}$  inches.—Cincinnati paper.

If this report be true the pound master should put all these people in the pound, brand them and put rings in their snouts.  
—EDITOR.

## WISCONSIN NOTES.

Mr Barnum, of Wausau, caught a 20 pound muskalonge at Eagle river, and 2 other men caught 22 bass in a lake near there.

A. McKinzie, of Eagle river, and Mr. LaForge, of Rockford, Ills., caught a muskalonge each, one weighing 28 pounds, both being taken from the Eagle river.

Mr. J. J. Roderick caught a 20 pound muskalonge, a 5 pound bass and 5 pike, weighing 2 to 3 pounds each, in the same stream.

J. Flannigan, of Chicago, landed a 30 pound muskalonge, in a lake near Eagle river. After landing it, he started to put out his line again, and only had out about 15 feet when another large muskalonge took it. Mr. Flannigan was taken at a disadvantage and did not succeed in landing the second fish.

E. J. Wirtz, of Chicago, caught 2 muskalonge, at Eagle river, of 28 and 23 pounds each, and 40 bass and pike, all in 2 days' fishing.

P. Walsh, of Eagle river, caught a 20 pound muskalonge, in a lake near that town.

J. B. Sloan, Miss M. Clark and F. E. Kerns, of Chicago, in 3 days' fishing caught 4 muskalonge, at Three Lakes, weighing 18 to 25 pounds each, and about 75 pike and black bass.

Another party of 3, from Kaukauna, caught, one day last week, 120 pike and bass. In 6 hours' fishing a Kaukauna party caught 146 pike and bass, and one muskalonge weighing 13 pounds, all at Three Lakes.

M. Warehouser caught a 32 pound muskalonge, in Cat Fish lake, near Three Lakes.

In 2 hours' fishing at Three Lakes, Dr. Busher and Mr. Miner, of Indianapolis, caught 32 black bass, weighing  $3\frac{1}{2}$  to 5 pounds each.

The picture of the fish hog, in August RECREATION, is the hottest burning up I ever saw any one get, and it is highly appreciated by every one here. Had we been there at the time it was taken, I'll bet dollars to doughnuts we could have heard him grunt. I got a subscriber on the strength of that picture, and every one here appreciates your discrimination between sport and butchery. Hoping to send you another club soon, for the best magazine published, I remain

T. H. Wade, Livingston, Mont.

I have just received the July number of RECREATION, and it is the best yet. Would not do without it for anything. Was greatly interested in the picture of halibut. It is a large one, but the statement that it was the biggest one ever caught on a hand line is incorrect. In 1881, one was caught by one of the crew of schooner Etta E. Tanner, of Gloucester, Mass., which weighed 380 pounds, dressed.

C. H. Dolliver, Tremont, Me.

The lake fishing, in Minnesota, is the best for years. Bass and pike are being taken in great numbers, and it does not take an angler long to get the limit of 25, allowed for one day's catch. I spent all last week up in the deer country, and learned, from the natives, there are many deer left over, though they suffered greatly on account of the severe winter, and deep snow.

M. L. Parker, Minneapolis, Minn.

The trout fishing never was so good in this vicinity as this spring. Three deer were seen, about a mile from the village, a few days ago. About 25 were killed in this town last fall. Only a few years ago they were as scattering as hen's teeth. Who says our game laws are no good?

W. E. Briggs, Parkman, Me.

I took a trip down the Shiawassee river, by boat, 40 miles, and caught 25 black bass and 6 pickerel, with the Bristol steel rod which I received from you. I am very much pleased with it.

J. Loch, Owosso, Mich.

RECREATION is at the head of all the sporting publications. Wish it came oftener. Fishing is good here, and 10 to 40 pickerel can be caught in a day.

James A. Judson, Rochester, N. Y.

Near this town is a beautiful lake, 9 miles long, which is stocked with red spotted and black spotted trout, togue, black bass, pickerel, perch, etc.

E. A. Keene, W. Poland, Me.

## GUNS AND AMMUNITION.

### THE 30-30 SMOKELESS.

Baltimore, Md.

Editor RECREATION: In the July issue of RECREATION G. R. Roberts, Northfield, Vt., asks for some information relating to the shooting powders of the Savage small bore smokeless cartridge rifle, also if the soft nose bullet is more effective than the solid.

A great deal has been said in RECREATION as to the killing powers of these small bore guns, and while I cannot add materially to the information heretofore given, yet every hunter's experience will assist in making up the sum total from which reliable conclusions may be deduced.

I hunted deer and turkeys in Southern Florida, last winter, and used the new model Winchester 30-30 smokeless. The gun more than met my highest expectations. The best test I had to ascertain its killing powers, was on a large alligator, on the Caloosahatchie river. The 'gator was shot from the bow of a boat, while swimming away, at a distance of 50 yards. The ball, a soft nose, struck him squarely in the back of the head, shattering the entire skull, and, taking a downward course, was found in many fragments lodged against the skin, at the chin, or tip of the lower jaw. The hole made by the bullet, at the entrance, was about an inch wide and 2 inches long, leaving a decidedly wicked wound.

Another alligator weighing several hundred pounds, and killed on the same river, just above Ft. Meyer, was found taking a sunbath on the shore and was instantly killed by a soft-nose bullet, at a distance of about 100 yards. The bullet struck near the base of the skull, shattering the vertebrae and tearing away the bony hide, and the flesh, in a manner quite amazing. Those who know how hard an alligator's head is, and what is required to kill one instantly, will appreciate this report. The old saying "shoot an alligator in the eye, only," means that at this spot the ball is more apt to penetrate than to glance from his hard head; but with the 30-30 smokeless, such fine marksmanship is not required.

I further found that the metal jacket shell is the thing to use on turkeys, and other large birds. A soft-nose ball fired at a sand-hill crane, at 200 yards, tore a hole through the bird large enough for a boy to run his arm through; while the full jacketed ball went through an egret, with little or no mutilation.

Mr. Roberts also says he would like to hear especially about the Savage rifle. Dr. Siremba Shaw, a well-known wing-shot of Chicago, and a true sportsman, who hunted deer and bear in Florida, last winter, writes me this:

"In regard to your 30-30 Winchester, I am not surprised at your praise of its work. Mine is a Savage, .303, and I have never seen anything to equal it. They are perfect terrors and tearers."

I am now planning a September hunt, for large game, in the Big Horn country of Wyoming, and will depend on my 30-30 smokeless to do the work, leaving at home that faithful old killer, the 40-82 Winchester.  
J. E. Taylor.

### DEVICES FOR INCREASING THE RANGE OF SHOT GUNS.

M. B., Conway Center, N. H., asks how a charge of shot can be held together and made to go in a solid body, a certain distance. I have tried various devices and have not yet found one that is certain in its operation. They all are irregular and uncertain, so far as I have tried them. Sometimes the shot will be carried *en masse* 30 yards; sometimes 60 or 75 yards.

About as good a device as I have found is to cut the paper shell nearly off just below the shot and above the top wad over the powder, leaving about 4 small places uncut. I have, by this means, made as good a target at 65 and 70 yards as I could ordinarily make, with the cartridge intact, at 40 to 45 yards. I have tried this with both cylinder and choke-bore guns; but don't recommend it for the latter. I don't think it good for the gun.

Some years ago I got, from a New York dealer, a device made and patented in England, and called the Schrapnel shot cartridge. It consists of a hollow globe, composed of 2 halves, with perforated lips at each end. This globe is filled with shot and held together by a straight steel wire or spindle, to one end of which an extra thick wad is securely fastened. This shell and its spindle are pushed down into the cartridge shell, on top of the powder, and the edges of the cartridge shell are then bent down, with the fingers, to keep the contents in place. The length of the cone determines the distance at which the spindle will be drawn out, by atmospheric pressure, and the shot scattered to perform their work. The theory of the device is, that as the charge leaves the barrel the expansive force of the powder drives the wad on the end of the spindle against the metal globe, preventing it from separating and carrying it forward a certain distance as a solid shot. When the impulse of the discharge begins to fail the resistance of the air, against the forward side of the wad, pulls out the spindle.

Suppose the longest range of this charge be 125 yards and you desire to reduce it to

75 yards. You must cut off a part of the spindle so as to make the 2 pieces of the shell separate sooner. I did not have enough of the shells to make a satisfactory trial; but from the experiments made was satisfied the shell would not work uniformly. I had no difficulty in sending the charge, as a solid shot, through a barrel standing on the beach at a distance of 80 yards.

This device must be used with cylinder gun, and I understand the smallest size made is 10 gauge.

MacCurdy, Fresno, Cal.

#### A GOOD RIFLE SIGHT.

Tomahawk, Wis.

Editor RECREATION: Some years ago I was in Kennedy Bros.' gun store, in St. Paul, looking about to see if anything new had come out, when I found, in a box of odds and ends, a rifle sight to fit in the slot usually occupied by the old buckhorn. It attracted my attention at once, and I thought I could see an advantage to be gained in using it. I bought and adjusted it to my Marlin; used it for a number of years, and now consider it simply indispensable. I sold my gun, last winter, supposing I would have no trouble in getting another sight like this one; but have been unable, so far, to find one. It is similar to the Lyman middle sight, No. 6; but differs from it in having but one leaf, a straight upper edge, and no notch. This one leaf is on a hinge, and will fold down. It has a narrow strip of ivory, near the upper edge, which relieves the strain on the eye, and should be used on the rifle with a Lyman front sight, No. 4, and Lyman rear peep sight, or his new No. 21.

The advantages are these: First adjust your rear sight, by screwing it up or down, so you can just see the ivory point on your front sight. Now, aim at a target, or a deer's heart or shoulder, and you will find the lower half of the object aimed at hid. Try it and you will agree with me that when you cannot see the lower half of the animal, it is easier to get a bead on a central vulnerable spot, than it is with ordinary front and rear sights, and with all the animal in view.

This sight is a great improvement on the old buckhorn sight, for nearly every hunter knows the buckhorn hides so much of the animal that it is often impossible to tell what part is in view, and you may hold on the flank, when a heart, or a shoulder shot is due you. It is possible this sight is known and in use in other parts of the country; but I have hunted in Northern Wisconsin and Minnesota for 15 years, and have never seen but one in use, beside my own, and that was last fall. It was gotten on my recommendation, by an old hunting

companion, who now thinks as much of the sight as I do. Who else has seen one?

George Hall.

#### RELOADING SMOKELESS SHELLS.

Houston, Minn.

Editor RECREATION: I read RECREATION with deep interest and always turn to Guns and Ammunition first. Am a beginner in this field and am becoming a crank on the 30 calibre.

Mr. M. W. Miner's remarks on the 30 calibre, and the reloading of shells for same, are the cause of this letter. His experience in reloading 30 calibre shells is another of the unaccountables. A year ago last March I bought a 30-30, 1894 model Winchester, and Ideal double adjustable reloading tool; also, an Ideal perfection mold, for grooved bullets, from 100 to 211 grains, also 100 cartridges. A month later a friend got a 30-40-95 model Winchester, with Ideal tool. The one mold does for both of us.

Then we tried all weights of bullets and charges of F.F.G. Dupont powder. We made bullets from pure tin up to 1 part tin to 60 of lead. The softest bullets, with about 1 grain of powder to 6 grains of pure lead, did the best shooting; but it did not give satisfaction.

Then we got some No. 1 Dupont smokeless rifle powder and went at it again. Now we have adopted a load of 10 grains of the smokeless powder and 140 grains of pure lead, which makes an accurate load for practice and for small game. We can put the majority of our shots into a 3½ inch ring at 100 yards. I made one 10 shot score, at 71 yards, out in the woods, resting over a stump, and using Lyman rear and front hunting sights. A strip ¾ inch by 2 inches covered 6 shots; and a 5 cent piece covered 3 of them. A 4 inch ring covered all of them. This charge causes no leading of barrel, no keyholing, no wild shots. If we hold the same each time, they go the same; and the smokeless powder is clean. We can shoot all day without cleaning.

We don't claim to have a money winner, but do claim to have a good small load for the 30-calibres. It does well for men who work every day and who use hunting sights.

Some day I will shoot a target and send to RECREATION to prove these statements.

I have used only 50 shells and have shot 800 loads out of them. Have never burst one and they have never been resized.

My friend's 30-40 has never burst a shell. We use Winchester shells. A. L.

The subscriber who asks for the name of the maker of the schrapnel shot cartridge is informed they are, or were, made by George Boice & Co., Birmingham, England,

## AS TO NITRO POWDERS.

Buckingham, P. Q.

Editor RECREATION: I have recently made a careful test of various smokeless powders. I find that S. R. is not good for the 40-82 but that .450 Rifleite is "just what the Dr. ordered" for this gun. I have also used 6 grains of .250 Rifleite in the .25-20 Winchester single shot, with good results. These powders are suitable for various other rifles. From 12 grains to 18 grains of .250 Rifleite gives good results in the 44-40 Marlin. No doubt this powder will work well in nearly all small bores, as it is recommended for them; but I am speaking only of those in which I have tried it.

In the 40-82, I use 50 grains (measured) or about  $\frac{2}{3}$  of the usual black powder charge. The penetration, with this charge and a metal patched bullet, is 26 inches of green cedar. With a soft point bullet the penetration is 12 inches dry cedar. The trajectory is very low—about 7 inches for 200 yards, as nearly as I can find out.

The powder I speak of is clean, strong, gives perfect shooting, and far less noise and recoil than any black powder I have used.

During the last few weeks I shot 9 woodchucks, with the 40-82. The soft-nosed bullet would simply tear them open, crush the head bones into small pieces, and frequently blow one side of the head clean off. They were shot at distances of 15 yards to 100 yards and I did not miss one shot.

I am now experimenting with the 32-40 Marlin and will give you the results when satisfied they are worth reporting to RECREATION.

L. D. von I.

## HOW TO LEARN.

I would like to add a mite, for the information of D. T. R. and others in regard to learning to shoot on the wing. Many good things have appeared in your recent issues that are of profit to old as well as young lovers of field shooting; but I want to say that, in my estimation, the most essential thing is to learn to bring up your gun with precision. This can be done only by practice. Fix your eye on some small object near you. Throw your gun to your shoulder without taking your eye from the object. Then look along the barrel and see how far off your aim is.

Practice this every time you can, in your room or out of doors, and you will be delighted to see how soon you can learn to bring your gun exactly on the spot you look at. Then advance to moving objects in the same manner; taking some particular point of flight for your object, and when that point is fixed in your eye, bring your gun to bear on it. Then you will have learned to shoot on the wing.

When you can do this, all you need is the practice, in order to become expert. I advise, in shooting at straight-away flights, that you wait until you see the height they will attain and then fire as if the bird were stationary.

For cross shots, you will need to hold ahead, in proportion to the speed the object has attained, which you will have to learn for yourself, by actual practice.

I had for a companion, on a duck hunting trip last spring, a man who had never shot at a duck, and who had only owned a gun a few weeks. He was coached as above and his bag contained 11 ducks at the close of one day, all of them killed on the wing.

Donnel, Springfield, Ill.

## RIFLES FOR AFRICAN GAME.

I saw in the May number of RECREATION an article by E. E. Vandyke, in which he advocates the use of 45-90 rifle for large game.

The only game here, antelopes, are small—not weighing more than say 100 pounds at most. What would you consider the best calibre for use on these? At present I use a repeating carbine, 44-40-200, and find it often takes 3 or 4 shots to kill these small animals.

What is your opinion of the 38-55 and 32-40 rifles, for game? Which is the better cartridge, a 25-20 or a 25-25?

I saw an inquiry about Lyman sights for rifles. I have them fitted to my 44-40 and although at first I did not like them I now think them indispensable, especially for running shots.

W. T. Adams,  
Adamhurst, Natal, South Africa.

## ANSWER.

I should recommend, for your game, a 30-30 Marlin or a 30-40 Winchester, using the new smokeless cartridges. If you have read the reports on the work of these guns, in the various issues of RECREATION during the present year, you understand fully what I mean by advising the use of these guns. They have undoubtedly greater killing power than the 45-90, or even the 50-95, while the ammunition is much lighter, and the absence of smoke is a great advantage. The 38-55 and the 32-40 should both prove effective, also, on your small antelopes; but the other cartridges have ample power and the guns in which they are used have the added advantage of being repeaters.

I should not advise the use of the 25-20 or the 25-25, as these calibres are too small and the powder charge too light to be effective, on antelope, unless the bullet be placed in the most vital spot.—EDITOR,

## 16 VS. 12.

In reply to J. A. B., Osage, Ia., as to 16 gauge guns against 12 gauge: My experience with both has convinced me that for all round shooting I prefer the 12 gauge, for the following reasons:

1. In wing shooting the 16 gauge does not make a target large enough, when shooting among brush; but will do in open field work.

2. If you choose a 16 gauge that makes a target large enough you cannot use load enough to fill the target properly. I recently tested the penetration of a 16 gauge and 12 gauge together, and the victory lay with the 12 gauge for 2 reasons: *a.* The size of the target was the same; and *b.* the penetration was better, using as a load 3 drams powder and 1 ounce No. 7 shot in both guns. According to the usual theories the 16 gauge should have made the closer pattern; but it did not make any better target than the 12. Judging from my experience a 16 is not in it with a 12 gauge gun. Let us hear from others.

W. B. Seavolt, Lock 53, Md.

## NOTES.

Do you think the 22 calibre rifle is large enough to kill game, up to and including foxes?

A. G. Sullivan, Fanningdale, N. Y.

## ANSWER.

No. A 22 bullet will kill even a deer, if it hits him in the brain or in the heart; but if you hit him, or a fox or a woodchuck, with one of these, in any other part of the body, he will have life enough left to run a long distance, and, in many cases, would escape. I would much prefer a 32-20 Marlin or Winchester repeater. This cartridge is cheap, gives no recoil to speak of, is accurate and yet has plenty of killing power for such game as you mention. It is all right even for squirrels, because it is so thoroughly accurate you can hit them in the head, and not waste any meat.—EDITOR.

In the current number of RECREATION I notice a communication from Chas. T. Pinkham, Brooklyn, in which he asserts he has killed game at 127 yards with a Winchester shot gun, using  $3\frac{1}{4}$  drams powder and  $1\frac{1}{8}$  ounce No. 8 shot. I should like to ask Mr. P. if that 127 yards was measured or estimated. I have done considerable shooting, and have been plentifully sprinkled with No. 8 shot at much shorter range than 127 yards, and do not believe the 12 gauge shot gun has yet been made that will kill game at such a range. One of my brothers shoots a model '93 Winchester, but, while

it is a close, hard shooter, it will not kill at any such distance as 127 yards.

Shanghai, New York City.

I do not understand why there has not been a more combined and vigorous protest, from the shooters of this country, against the advance in price of all nitro powders. It was a shrewd move on the part of the manufacturers of powder, after they had it well introduced and had proved it as effective as black powder, and much pleasanter to use, to advance the price 25 per cent. If, as I have seen it stated, the companies can furnish to the Government smokeless powder for less than 20 cents a pound, I say the sportsmen of this country should kick vigorously against paying 4 times as much for what they use. We can kill all the game we ought to kill with black powder, and it is but a short time ago we thought it all right. Let us drop the nitro powder, each and every one of us, until the manufacturers "come to their gruel" and give us nitro at reasonable figures.

H. F. Chase, Amesbury, Mass.

I am a close reader of RECREATION and find every subject discussed interesting, as well as instructive; especially those relating to guns and ammunition. I would like to hear, through your journal, as to the effect of a 38-55-255 on big game, such as moose, elk and deer, and whether there is any way of making this arm more effective.

Does smokeless powder, in this shell, make any difference? If so, what?

R. C. G., Merriam Park, Minn.

After another season's use my partner and I find no reason to change our good opinion of the 30-30 Winchester smokeless rifle; and would not trade one for any black powder gun ever made. We find the full jacketed bullet best; as the soft point bullet lacks penetration, and we are unable to see that it tears a much greater hole than the full jacketed bullet. We have made some remarkable shots with the 30-30, owing to its flat trajectory.

M. W. Miner, Banner, Idaho.

I should like to hear, through RECREATION, whether the 32 long smokeless cartridge, used in the Marlin '92 model rifle, is a success, and whether it would be strong enough to kill bear and deer.

A. F. Schroeder, Neenah, Wis.

Will some reader of RECREATION please tell me what can be done with a gun that is pitted in the barrels?

E. J. D., Syracuse, N. Y.

## NATURAL HISTORY.

### TRAPPING BIRDS.

Union City, Pa.

Editor RECREATION: In your answer to R. E. Borhek, in August RECREATION, you say the chances are 10 to 1 wild trapped birds would languish and die, in captivity.

Having been a bird fancier for over 20 years, and having trapped and kept nearly every kind of bird that can be kept in captivity, I can honestly say birds trapped in the early spring, before they have begun nest building; or late in the fall when they are migrating, seldom die if given proper food and kept in large, roomy, semi-dark cages, for the first few days.

Of course birds trapped when they have eggs or young usually grieve themselves to death, no matter what attention they receive, and no true fancier would think of trapping a wild bird during the nesting season.

Young birds taken from the nest are far more difficult to raise than most people suppose, and only people whose entire time is their own can hope to have success, as regularity in feeding is of even more importance than the food itself.

I have been a reader of the magazine of magazines, RECREATION, for a long time, and as it speaks of everything I would like to ask: Why can't the amateur bird fanciers have a corner? At present their only means of communication is through the mails, which is far from satisfactory.

There is no more interesting study, with which to pass away your idle moments, than Ornithology—not with a gun in one hand and a skinning knife in the other, but in the study of living, breathing specimens, whose melodious notes thrill us with pleasure. Who, that has ever seen an aviary, or bird-room, filled with native songsters, with their sprightly movements and beautiful plumage, will say the birds are not happy?

Now, Mr. Editor, give us a little space and see if you can't induce some of our fanciers to devote a few moments, once a month, to fill it. I promise to do my part. Shall also be pleased to correspond with any amateur fanciers who may care to write me; with a view to organizing a club, or merely for mutual entertainment.

C. T. Metzger, Union City, Pa.

Your suggestion, as to the establishment of a department of Ornithology, is a good one, and I should be glad to hear from other readers on this subject. For the present, I should have to print such contributions as may come, in the Natural History department; but if a sufficient number of contributors can be secured to sustain a separate department of bird lore, I will gladly establish it.—EDITOR.

### ABOUT THAT SKUNK STORY.

Eufaula, I. T.

Editor RECREATION: In your August number I find an article by W. T. Hornaday on the striped skunk, wherein he also speaks of the Indian. I should like to say that Mr. Hornaday's theory is not correct, because an Indian is better posted in his style of doctoring than his white brother is, and can and does cure rabies, whether resulting from a skunk or from a dog bite.

Friend Hornaday is certainly a hunter and yet can learn something from an Indian hunter that may be useful. I am one-half Indian. My father was a white man and of course when the Indian question is brought up I am interested. If Mr. H. would come to this, the Indian Territory, the Indians would cook a skunk for him in a fashion that would surprise him.

Five years ago 2 young bloods came here from the great State of Texas, to go on a camp hunt, with 4 half breed Indians. The Y. B.'s were driven to the half blood's came at 10 o'clock p.m. The half blood had a negro cook who had killed a skunk and had fixed it up and baked it for his breakfast. It was baking when the Y. B.'s landed. They had missed their dinner, and were hungry. One of them scented the odor of the baking skunk, which odor was very different from that of the live skunk.

He asked the cook what was cooking. The darkey told the Y. B.'s he had killed a possum, and was going to eat him later. The Y. B.'s said they had never eaten a possum but had heard so much about them they would like to try some of it. So the negro took the well browned baked skunk, placed it on a plate, put it before the Y. B.'s, and there, under the towering pines, the Y. B.'s fell to; tore the possum limb from limb, devoured him bodily, and pronounced him as fine meat as ever went into their gizzards.

After the hunt the negro gave the snap away; but more possum, of that kind, was called for by the Y. B.'s. It might be the same way with friend Hornaday.

The Indians have a sure cure for rabies, also a sure cure for rattlesnake bite. The remedy for rabies is a secret; but the other is simple and will not fail. It is this:

Take an onion, the size of a hen's egg, a piece of tobacco and common table salt, each of about same weight. Cut the tobacco up fine, also the onion. Then put all in a dish. Take a potato masher, or something as blunt, and mash the 3 together. The sap in the onion will mix up the poultice nicely. Spread on a piece of cloth and place on the wound, the poultice being exposed to the skin. Do this as soon as possible after the bite is inflicted. Let the

poultice stay all day or night, and put on a new poultice in 12 hours. Two poultices will be enough to cure any case. This is a dead shot cure for snake bite.

Chas. Gibson.

#### BIRDS TO BE PROTECTED.

The Audubon Society, of the State of New York, is doing some excellent work for the protection of birds.

The society works in co-operation with the American Museum of Natural History, and Morris K. Jesup, President of that institution, is also President of the society. The honorary Vice-Presidents are Mrs. Robert Abbe, Miss Maria R. Audubon of Salem, N. Y.; Mrs. Samuel P. Avery, Mrs. William C. Doane of Albany, Mrs. David S. Eggleston, Mrs. Morris K. Jesup, Mrs. Cadwalader Jones, Mrs. William M. Kingsland, Mrs. Francis P. Kinnicutt, Mrs. Charles Russell Lowell, Mrs. Seth Low, Mrs. Henry Fairfield Osborn, John Burroughs of West Park, N. Y., John P. Haines, Henry G. Marquand, Bishop Henry C. Potter, Theodore Roosevelt, and Abbott H. Thayer of Scarborough, N. Y. Miss Emma H. Lockwood is Secretary and Treasurer. The Executive Committee is composed of Frank M. Chapman, Chairman; Mrs. J. A. Allen, Mrs. Winthrop Cowdin, Miss Emma H. Lockwood, Mrs. Olive Thorne Miller, Mrs. J. H. Ryland, Mrs. May Riley Smith, Mrs. Mabel Osgood Wright, J. A. Allen, Ph.D., William Dutcher, the Rev. Henry Van Dyke, D.D., George Bird Grinnell, William T. Hornaday, Frederick Peterson, M.D., and Henry S. Williams, M.D.

A declaration of principles in circular form, has been sent out, which has been the means of arousing much interest, and of largely increasing the membership of the society. The purpose of the association is to discourage the purchase or use of the feathers of any birds, for ornamentation, except those of the ostrich and of domesticated fowls.

Members are urged to discourage the destruction of birds and their eggs, and to do all in their power to protect them. They are also asked to use their influence to establish "Bird Day" in the schools of the State of New York and a movement in this direction is gaining strength daily.

This circular has also been sent broadcast over the State:

"Laws of 1897, Chapter 699. Signed by the Governor May 22, 1897.

Section 78.—Certain wild birds protected.—Wild birds shall not be killed or caught at any time or possessed living or dead. This provision does not affect any birds the killing of which is prohibited between certain dates by the provisions of this act,

nor does it protect the English sparrow, crow, hawk, crane, raven, crow blackbird, common blackbird, and kingfisher; and it does not apply to any person holding a certificate under the provisions of this act. Whoever shall violate or attempt to violate the provisions of this section shall be deemed guilty of misdemeanor, and in addition thereto shall be liable to a penalty of \$25 for each bird killed, trapped, or possessed contrary to the provisions of this section.

Section 80.—The nests of wild birds shall not be robbed or wilfully or needlessly destroyed, unless when necessary to protect buildings or prevent their defacement. . . . Whoever shall violate or attempt to violate the provisions of this section shall be deemed guilty of a misdemeanor, and in addition thereto shall be liable to a penalty of \$25 for each nest robbed or destroyed contrary to the provisions of this section."

Requests for further information concerning the law protecting wild birds, and reports of its violation, may be made to

MORRIS K. JESUP,

President Audubon Society of the State of New York, American Museum of Natural History, New York City.

The society desires the co-operation of all bird lovers throughout the State. Requests for literature, and applications for membership, may be made to the secretary, Miss Emma H. Lockwood, 243 West 75th Street, New York.

A fee of \$1 purchases a life membership, except for teachers and pupils in any of the schools of the State of New York, who pay 25 cents for a life membership. There is no annual assessment. The fees are devoted to the work of the society, which includes the free distribution of circulars and reports relating to bird protection.

#### THE BIG HEAD AGAIN.

Tacoma, Wash.

Editor RECREATION: I saw the article signed W. T. H., in August RECREATION regarding my buffalo head.

Evidently Mr. Hornaday believes in measuring the hair on a buffalo head, instead of the skull and horns, to get at the size of the head. I am surprised at this, and believe the majority of taxidermists and sportsmen would prefer to have the skull and horn measurements, instead of those of the chestnut locks he speaks of.

Some people might prefer to leave the top hair full of mud, burs and rubbish; but I prefer to have these combed out. Mr. H. says no one he ever saw cares a rap about the horns. That is strange. I never saw a



sportsman, in my life, who did not want the largest horns he could get, on all his heads.

Mr. Hornaday is in error when he says this buffalo head of mine has not long hair. The bull was killed in the dead of winter, high up in the mountains, and has extremely long hair; though the horns are so large and so long they might cause one to think the coat was short. Had the hair been left matted, as in the cut Mr. H. shows, the "chestnut locks," as he calls them, would have fallen in a ragged mass over the head and horns, as on the old bull killed and mounted by Mr. Hornaday, which, by the way, has brought forth as much criticism, from taxidermists and naturalists, as any specimen in the National Museum. Men who should know what a buffalo looks like claim the body of this specimen is stretched out of all proportion, and that the hump is twice the size it should be. I notice Mr. Hornaday has wisely left these defects out of the photograph.\*

He says he challenges the world to surpass, in real magnificence, the head of this old bad lands bull. All right Mr. Hornaday; I accept the challenge. Make it an object and I will match you for real magnificence, size of skull, size and length of horns and chestnut brown locks.

I also noticed in August RECREATION a few remarks regarding my big buffalo head, from a man signing himself "Onyitta," Manchester, N. H.

It is really unnecessary to answer him, and I presume every sportsman who read his remarks made up his mind the man never saw a buffalo.

I wish to ask the old time buffalo hunters how many buffalo, in a herd, they ever saw with horns the same shape and curve. This man from New Hampshire might be able to pass judgment on boiled horns, stewed tripe, etc.; but his judgment would not carry much weight on buffalo heads. He says "the skin seems to have been stretched. The head looks swelled, and the horns are set too low." He is inclined to think an artificial skull is on the inside, and that the horns have been boiled.

While I am inclined to think this New Hampshire man was just getting over a case of prostration, and that he must have in mind some of the animals he saw while he "had 'em"; yet if he, or any other reader of RECREATION doubts the measurements of this head as given, and will deposit \$500. with any responsible person, I will send a like amount, with the head for dissection, and prove that the skull is natural; that the horns are natural; that they have never been off the skull; that the measure-

ments given are correct, and that the horns have not been stewed.

Since this head was shown in May RECREATION I have received a great many letters congratulating me on owning such a large, well mounted buffalo head. Many travelers, who saw the cut in RECREATION, have come in, measured and examined the head and all pronounced it the largest and best they ever saw. W. F. Sheard.

#### WHY IS IT?

Cohasset P. O., Itasca County, Minn.

Editor RECREATION: I noticed the inquiry of E. S. Thompson as to why wolves roll in carrion. I have never seen a wolf do this, but have seen dogs, of different breeds, rub and roll on the dead carcasses of animals, reptiles and birds, in different stages of decomposition, from the recently killed subject to the most stinking and rotten stage. I have studied the habit, closely, and have noticed that if the carcass is fat or oily, the dogs will rub and roll on it before it has much if any smell, other than the natural smell of the subject.

As the habit is practiced by non-hunting dogs, and by hunting dogs when not on hunting excursions, it would seem to do away with the theory that the doping is done for the purpose of disguising the dog's or the wolf's own odor, to aid him in catching game.

I have noticed the peculiar actions and expressions of a dog at such times. The mind seems to be a blank to everything else. He pays no attention to being scolded, sometimes requiring the use of a whip to get him away from the carcass. Then, if not watched, he will return to it, if passing that way some hours afterward.

In some such cases, I have allowed my dogs to stay and roll until satisfied, and when they came to me they seemed to say, by their actions and expressions,

"I disobeyed you, but have been true to my own law."

Shall we call this habit or superstition? Possibly our dogs are controlled by other dogs' spirits.

I am an investigator, evolutionist, and mental scientist, and believe in the power of the mind to produce peculiar characteristics.

I should like to hear from some of the readers of RECREATION with regard to the condition of the various hibernating animals, in spring. The old saying that "they go in as fat as butter and come out as thin as a rail" does not prove true with the bear, excepting with the female when she has cubs. I caught a male bear that was very fat, about the 20th of May.

Would also like to know if all hibernating animals have the valve (*Foramen ovale*) open while hibernating? Or do they open and close it at will? William Dicer.

\* The photograph Mr. Hornaday sent me for publication shows the entire animal, but I had the cut made to show only the head, as that was the only part in controversy. The specimen shows an excellent piece of taxidermy, if I may be permitted to judge.—EDITOR.

## Forest Glen, Md.

My dear Coquina: Under the caption, "Why is it?" in the current number of RECREATION, is an interesting article from the pen of E. S. Thompson, which gives the author's theory of the motive wolves have in "doping" themselves in carrion.

It requires some courage to take issue with an authority so celebrated as this artist-naturalist, and I preface my remarks with a request for pardon, in advance.

The motive, Mr. Thompson thinks, is to cover their trail with a scent sufficiently powerful to hide their own—all other animals fearing the wolf.

Now, it happens that the dog also has this habit, as every country boy knows, and one filthy mess of carrion will "dope" all the dogs in a neighborhood. It is not because all animals fear the dog, for such is not the case. If the artist's theory be correct, then "doping" has descended to the domestic favorite, from a very remote ancestry, just as a modern writer—Romaine, I think—says his habit of turning round and round before lying down, has come to him: this latter being necessary with his wild ancestors (who inhabited grassy selvas) in order to make a bed in the tall grass. Rather a far-fetched supposition, one would think.

Cats, too, will roll and rub in a bunch of "catnip." Is this to cover the scent of their trail?

All the races of men have some favorite kind of dope, some of them nearly as offensive as that of the canine family. It is no uncommon thing to meet with the animal which we classify as the "dude," so doped with perfumes as to cover the trails of all the wolves in America. Why is this? I believe it all arises from the character of the animal which dopes itself. In other words the smell of the dope depends on the taste of the animal. It is a filthy, vulgar preference for something loud. Perfumes are only tolerable in those who are themselves offensive. Nimrod II.

In June RECREATION E. S. Thompson seeks information regarding the habit of wolves rolling in carrion. The state of New York owns a wide awake fox terrier, assigned to duty as a rat catcher, at the state hospital here, who has a similar habit. I have noticed, recently, that he has killed a number of squirrels, which he covers, lightly, with grass or earth, until they reach a proper degree "of mellowness," when he unearths and rolls on them, evidently preferring his game "ripened." He does not do so with rats which he has killed. An eminent physician, connected with this hospital, gives it as his opinion, that it is a case of "in-stink," pure and simple.

"C.," Middletown, N. Y.

It is certainly natural for certain carnivora to roll in carrion, especially such as have not been refined by domestication. Even among the higher grade of domestic quadrupeds the habit is found. From years of personal observation I must conclude this filthy habit is simply inherited, just as the love of blood is natural to their kind.

In lower brute life there is instinct but little intelligent reasoning. It does not seem plausible that the wolf, or any other animal, endeavors to disguise its natural odor by this means, else why should the dog have recourse to it?

Some years ago I was in White County, Indiana, after chickens. While there I discovered 3 or 4 gray wolves, left over from a large pack, who were having fine sport with the farmers' turkeys. I spent 10 days in their quest and discovered a dead turkey that had been partially eaten and then wallowed in. A constant watch, on this body, rewarded me with a shot, and with the unusual sight of an old male wolf sporting "snout and tail" in this decaying body, as if it were a gala time and his the acme of pleasure.

It seems to me this habit is simply without purpose, save to emphasize the lower status and the vile nature of the beasts that indulge in it.

G. W. H., New York City.

## ANOTHER BRANT STORY.

In the July number of RECREATION I noticed a letter, and an illustration, descriptive of a remarkable incident, viz., the finding of an Esquimau spear head, fastened in the sternum of a brant shot on an Indiana farm.

The rarity and strangeness of the thing have led me to write you of a similar case which came under my observation while living in Alaska, some years ago. A native brought in a brant which he had shot, on the sand spit in front of the village. On picking the bird up, his attention had been drawn to something sticking among the feathers of the right wing. This, on examination, proved to be a spear head, similar in every respect to the one described in your July issue.

The point had passed between the 2 bones of the wing and had become wedged.

It gave evidence of having been there some time, yet the bird was strong and in good condition. As this was in the spring, when the flocks were passing North, the bird must have carried its strange burden with it during all the wanderings of its winter migration.

Such weapons as this spear are not, to my knowledge, used within a thousand miles of the place where the bird was shot.

H. R. Gould, Tacoma, Wash.

AN ELK HEAD FOR THE GERMAN EMPEROR.

Hans Leiden, the German consul of Netherlands, and director of the Zoölogical Garden of Cologne, has recently shipped to the Emperor of Germany an elk head which probably bears the largest pair of horns in the world. They measure 11 feet 7½ inches from tip of beam to tip of beam, across the skull, and have a spread of 62 inches. They were mounted by Prof. Gus Stainsky of Colorado Springs, Colo.

They have a beam length of 67 and 67½ inches, respectively, and the longest prongs are from 22 to 23½ inches in length. There are 12 of these prongs, in all, and, including beams, they have a total length of nearly 30 feet. The elk was killed in the White river country, Colorado, by a hunter named Monjeau, who was in the employ of Professor Stainsky.

RABBITS CAN SWIM.

Until March of last year I entertained the common belief that rabbits could not swim. During a rabbit drive, which occurred in that month, a few miles from Fresno, I saw a rabbit swim across a pond more than 100 feet wide.

In April of this year, during the progress of a drive, over substantially the same ground swept by last year's drive, I saw several rabbits take to the water and swim across a pond nearly 200 feet wide.

I now know that rabbits—jack rabbits at least—can swim, and will swim—though I do not consider them amphibious animals. Nor do I think they would ordinarily take to the water with any more readiness than would the harmless and necessary cat.

The July number of RECREATION came to-day and hits the spot. It is easily the best of its class.

MacCurdy, Fresno, Cal.

NOTES.

I am an interested reader of the Natural History department of RECREATION, and will give you an item from our farm.

We have a large number of chickens, among which are about a dozen Plymouth Rock roosters. A hen made a nest in an old straw stack and after 2 or 3 days one of the old roosters concluded to sit on the eggs and raise some chicks. He drove all the old hens away, took possession of the nest and sat on it until night came. Then he went to the hen house to roost. A large Thomas cat, in looking for a good bed to pass the night in, found the now vacant nest which he promptly appropriated. And it came to pass that the rooster sat on the nest during the day, the old cat went on duty about sunset and between them they never allowed the eggs to get cold. After keeping this up for about 2 weeks they both got disgusted and dissolved partnership by

mutual consent. Had they kept the eggs warm another week I am confident they would have hatched, but as it was the labor of the cat and of the rooster was thrown away. W. B. Cuckler, Athens, O.

I notice in July RECREATION a communication from Mr. John E. Brock giving size of an antelope head. I have a larger one, which measures as follows:

- Length of left horn.....13¾ inches.
- Length of right horn.....13½ "
- Spread at tip.....8¾ "
- Spread at widest point...12½ "
- Circumference of horns... 6¼ "

This antelope was shot at by me, and killed by Mr. Milo Burke, of Ten Sleep, Wyo., a ranchman and guide whose name appears among those given in your directory.

I am glad to be able to add my testimony to that you already have, that Mr. Burke is a perfectly competent and reliable guide, as well as a pleasant companion for a hunting trip.

C. S. Myers, Omaha, Neb.

I have an unmounted antelope head here that measures as follows:

- Length of left horn.....15½ inches.
  - Length of right horn.....15 "
  - Spread at tip or horns.... 2 "
  - Widest spread of horns....10¼ "
  - Circumference at base.... 5½ "
- Gus Stainsky, Colorado Springs, Col.

Seeing a request by John E. Brock, for reports on the largest antelope heads, I give you measurements of one I killed in Jackson's Hole, Wyo.

- Length of horn.....13 inches
- Around curve.....16 "
- Spread, in widest place.....12½ "
- Circumference of horn.....6⅞ "

M. P. Dunham, Woodworth, Mont.

As well as I like RECREATION, there is one criticism I should like to make in regard to Mr. Angus Gaines' article on the brown thrush, in your June number. In describing its eggs, he says they are of a delicate light blue, with perhaps a light shade of green, but free from all spots and markings. This is phenomenal. I was raised where the brown thrush was one of our most common birds, and have examined hundreds of their eggs, in the nests; but never saw one without markings, and in all the works at my command, the eggs are described as speckled.

I am not seeking a controversy, but if I am mistaken, I should like to hear from others, for the brown thrush (*Harporhynchus rufus*), varies as little in its egg markings as any bird I know.

C. E. Pleas, Clinton, Ark.

When you see the full page picture on page 217 of the July *Bulletin of the Sportsmen's Association*, I think you will say, "It is to laugh." The picture stands for a night scene, in a deep and narrow Arizona canyon, with either mule deer or white-tailed deer (the writer does not say which) coming down to drink. The legend that introduces the picture says, "I heard a snort from the bluff above me."

Now there are at least 3 places where the laugh comes in. The scene depicted is in broad daylight; the deer are coming up the slope of a mountain divide (in Scotland?), the species represented is the well-known European stag, or red deer—and if the original was not done by Landseer, my memory is at fault. It is a fine picture, and even though it does suggest a misfit, I enjoy it. I always liked Landseer, but to put him in as an illustrator of an Arizona deer story is a rather rude shaking up of the old man's bones.

---

Fort Sam Houston, San Antonio, Tex.

In answer to K. H. C., of Leech, Minn., in June RECREATION, I enclose a photograph of the finest mounted head of a deer I have ever seen. It has 78 points, and is owned by Albert Friedrich of San Antonio, Tex.

He has over 1,000 curious heads, small animals, snakes and birds on exhibition, free of charge. Sam Hawkins.

---

G. S. G., Meadow Creek, Montana, in May RECREATION, gives measurements of a large deer head. Here are the measurements of one I secured in Routt County, Colo., in September, 1894. The horns spread 36½ inches, and have 21 points, not counting the small points at base of horns.

J. W. Cox, M. D., Mapleton, Iowa.

---

When I read the account of the nesting of the brown thrush, by Angus Gaines, I felt called upon to correct his error. He seems to have gotten the brown and wood thrush mixed. The brown thrush does not (to my knowledge) use mud in the construction of its nest. Neither does she lay plain blue-green eggs.

A. Hall, Lakewood, O.

---

Is the fur of the fox, mink, and such animals, of any value when taken as far South as Virginia?

W. R. McLain, Galena, Kan.

ANSWER.—When taken in winter, yes; but their value is less than that of more Northern furs, of course. Fur buyers grade fox, skunk and mink skins according to locality.

The Highland Gun Club of this city is leading in a movement to introduce English and Chinese pheasants, on the government island. They claim it is the best kind of a game preserve, from which the pheasants would spread all over this part of the country. The club has already obtained permission from Capt. Blunt, commandant of the arsenal, and will attempt to raise a fund sufficient to bring a number of these birds to the island.

Moline (Ill.) "Dispatch."

---

On the bank of the Payette river, a short distance below the mouth of Warm Spring creek, Idaho, is a fir tree more than 3 feet in diameter. Firmly imbedded in the tree, some 12 feet above the ground, is a large granite boulder, about 16 inches in diameter. The rough bark encloses the rock firmly and there is no sign of decay nor of there ever having been a limb beneath the rock to hold it up. Was it imbedded there on being thrown from the sling of some prehistoric giant?

---

Large numbers of elk winter on the warm slopes of the South Payette river, between Five Mile and Eight Mile creeks; also numerous goats, and bear of all kinds. Within the past week 7 bear have been seen in that vicinity, by different persons. None of the settlers in that region kill them in summer. An unwritten law protects them until October, when they are fat and their fur is of some value.

M. W. Miner, Warren, Idaho.

---

I have just received the Clipper bicycle and it would be useless for me to try to express, in words, my appreciation of your kindness. I shall certainly do my best to get more subscribers, and shall always be a worker for RECREATION.

Many people laughed at me, and told me I would never get any thing for my work; but he laughs best who laughs last. I shall take good care to show these people what a handsome premium you have sent me.

A bicycle dealer here tells me there is not a finer wheel in town than my Clipper.

Kittie Argo, Clinton, Ill.

---

The Marlin revolver sent me as a premium for a club to your most popular magazine, RECREATION, is, indeed, a fine piece of mechanism; demonstrating most positively, the merits of your magazine, as a means of bringing before American sportsmen the best that can be found.

A. W. Cassidy, Vigo, Ohio.

---

Getting subscriptions for RECREATION is easy. The magazine does its own talking. Turn to the premium list, on page xlvi., and see what you can get by sending in a club.

## EDITOR'S CORNER.

### ANOTHER POTENT RECOGNITION.\*

RECREATION has been adopted as the official organ of the American Canoe Association. This is a most grateful tribute to this magazine, inasmuch as the first proposition, looking to such a recognition, came from the executive officers of the Association. When the A. C. A. convened in its annual encampment at Grindstone Island, in the St. Lawrence, on August 9th, the question of the choice of an official organ came up, and after some discussion the officers wrote me to come to the camp for a conference. I went, and the result of the meeting was as above stated.

RECREATION thoroughly appreciates the honor thus conferred upon it. This is one of the incidents that are constantly occurring to build up this magazine, and to make it the greatest sportsmen's periodical ever published in the world. It is gradually becoming recognized, as such, everywhere, and my efforts to make it better than it has ever yet been are greatly stimulated by the generous endorsement of my friends.

This action of the American Canoe Association means 1,000 new subscribers, as that number represents the total membership of the Association, and the contract provides that the Magazine shall go to every member. This fact should have great weight with advertisers, and will have with all shrewd ones. It is a well known fact that the members of the A. C. A. are gentlemen of means and of culture; and the fact that a dealer in any class of goods, used by outdoor people, can reach these gentlemen and their families, through RECREATION, should remove the last objection that could possibly be raised by any advertiser, to the use of this publication.

This new arrangement means the opening of a Canoe Department in RECREATION, and, in addition, the publication of more or less illustrated matter bearing on this sport. I have heretofore given but little space to canoeing interests, preferring to leave this field to other periodicals that had previously occupied it. Now, however, it becomes necessary to take up this class of literature; and canoeists may rest assured their interests will be as well represented in RECREATION as are those of shooters, anglers, bicyclists and amateur photographers.

The lovers of other sports, and who are not interested in canoeing, need have no fear of their interests being neglected, or that their space in RECREATION will be reduced. The magazine will still be pre-eminently for them, but the canoeists will simply be provided for in addition to the departments heretofore conducted.

I thank the officers and members of the

A. C. A., one and all, and especially my good friend Ned Towne, for the valuable recognition accorded RECREATION, and beg to assure them they shall have no occasion to regret their action.

The following letter is of interest in this connection:

Galt, Ont., August 24, 1897.

Mr. G. O. Shields,

Editor RECREATION, New York.

Dear Sir: The proposal to make RECREATION the official organ of the American Canoe Association was laid before the annual meeting at Grindstone Island, August 18th, and I have much pleasure in stating that the proposition, as contained in your letter of August 15th, was accepted and that I have been instructed to enter into a contract with you, on behalf of the Association, for that purpose. I am

Yours truly,

J. N. McKendrick,  
Commodore A. C. A.

### SUBSCRIPTION RECEIPTS FOR 2 YEARS AND 8 MONTHS.

Read the deadly parallel columns:

|                | 1895.   | 1896.    | 1897.          |
|----------------|---------|----------|----------------|
| January .....  | \$379   | \$723    | <b>\$2,146</b> |
| February ..... | 256     | 693      | <b>2,127</b>   |
| March.....     | 300     | 1,049    | <b>2,215</b>   |
| April.....     | 342     | 645      | <b>1,921</b>   |
| May.....       | 292     | 902      | <b>1,596</b>   |
| June.....      | 307     | 770      | <b>1,402</b>   |
| July.....      | 345     | 563      | <b>1,101</b>   |
| August.....    | 306     | 601      | <b>1,906</b>   |
| September..... | 498     | 951      |                |
| October.....   | 438     | 969      |                |
| November.....  | 586     | 1,054    |                |
| December.....  | 652     | 1,853    |                |
|                | \$4,671 | \$10,773 |                |

Look at the figures for August '95, '96 and '97. They afford a lot of food for reflection. August '97 shows a gain of 300 per cent. over August '96; yet many people call this a bad year for business.

Watch this table for the next 4 months. It will show some mighty interesting figures.

The shrewd advertiser puts his money where it will do him the most good.

### ANGLING FOR FOX TERRIERS.

A new sport becoming popular among anglers is that of bait casting for fox terriers. This title is somewhat inaccurate.

as no bait is really used. The average fox terrier will strike, vigorously and unfailingly, at a chunk of lead, or a piece of leather, and will hang on as persistently as a channel catfish. He is as gamy as a black bass or brook trout, and if of good size, will test your striped bass tackle, or your tarpon tackle, to the utmost. Some anglers use much lighter tackle in "fishing" for fox terriers; but in many instances, fine rods have come to grief.

One attractive feature of this sport is that it requires no wading, no walking, no long hours of sitting cramped up in a boat. In fact it entails no hardship of any kind. You simply rig up your tackle, go out on the lawn, call your fox terrier, make the best cast you can and send him after the lead. He will not require a second bidding; but will go like a bolt from a catapult. When he takes the "bait" he will endeavor to run with it, and you must exert all your skill in order to hold him, or to "land" him. If you can do this you may well consider yourself an expert, and your tackle good for a 100 pound fish of any kind.

The frontispiece of this issue of RECREATION illustrates this new sport. If you do not believe there is fun in it, call out your fox terrier and try it.

I am having a good many inquiries as to how to outfit for the Alaskan gold fields. In general the equipment for camp life and for hunting in Alaska would be the same as in the mountainous districts of Wyo., Mont., etc. The check lists printed on pages 488 and 489 of June RECREATION may, therefore, be consulted, to advantage, by persons going to Alaska. The supplies for actual mining, would perhaps best be obtained in some general supply store in Tacoma or Seattle. These dealers also keep special leather clothing, adapted to the more rigorous winters of Alaska. Some of these garments are made of sheep skin, with the wool turned in. Others are made of various other skins, with or without fur or hair. For sluice mining, hip rubber boots are almost indispensable. For work in quartz mines, heavy cowhide shoes or boots are usually worn.

I commend to all readers and writers of hunting stories the delightful paper of Mr. Wilmont Townsend, which opens this issue of RECREATION. Here is an instance in which the instinct of the naturalist was stronger than that of the sportsman; in which a man's love for the bird was stronger than his love of sport. Mr. Townsend tells how he spent the whole afternoon sitting in a duck blind and studying the habits and the domestic affairs of a pair of willets. He refrained from shooting at the ducks for fear of disturbing the willets in their paternal duties.

Stories of the killing of game are all right, in their way, and I like to read and to print them, but I would rather read this story of the life history of the willets than to have read of the killing of 20 ducks.

I trust Mr. Townsend, and other students of nature, will send RECREATION many such delightful studies of nature's bright creatures.

Some of the leading features of November RECREATION are, "Memories of a Quail Hunt," by G. E. Brown; "Drifting on an Ice Floe," Samuel J. Entekin; "Elkland," Ernest Seton Thompson; "Deer in the Coast Range," Daniel Arrowsmith; "Speed Skating," A. M. Anderson, and "His First Bass," Dr. F. C. Kinney.

The discussion of "The Wolf Question" continues to grow in interest; there will be a lot of matter of special interest to Canoemen; the Gun and Ammunition Department will have many valuable papers and all the other sections will be full of interest.

#### PUZZLE CORNER.

Whoever will solve puzzle No. I., and send solution to RECREATION, stating on what page of this issue the "ad" is found, will receive, in return, an order on a store for 50 cents' worth of goods which, to many people, will be worth its face value.

#### HIDDEN LETTER PUZZLES.

##### I.

There are just 7 letters in  
My trisyllabic name,  
Three vowels and 4 consonants,  
And only 2 the same.  
My 1st in *tennis* and my next  
In *tramping* can be found,  
My 3d in *wheeling* and my 4th  
In *rowing* make their sound,  
My 5th in *sailing* and my 6th  
In *golfing* plainly show,  
My last in *trouting* may be seen;  
My whole is *comme il faut*.

##### II.

My name of 13 letters has  
3 syllables complete,  
4 vowels and 9 consonants,  
And 3 of them repeat.  
My 1st, 5th, 7th, 10th, 11th, 13th,  
In *Bobolinks* are found;  
My 2d, 3d, 4th, 6th, 8th and 12th,  
In *Partridges* abound;  
My 9th in *Hérons* leads the rest—  
How many have my total guessed?

Each person who may solve puzzle No. II. will receive, as a prize, a beautiful colored picture, well worth a place in any home or office.

Ask all your friends to answer the puzzles in RECREATION. The more the better, for all concerned.

## BICYCLING.

### THE FINEST CENTURY IN AMERICA.

W. G. IRWIN.

Wheeling along the great lakes is most delightful, perhaps more so than in any other part of our big country. There the roads are perfect; the weather and climate usually all that could be desired and the cooling breezes from the water constantly blow over the level land to refresh the rider and give him the desire for more of the pleasure.

Here it is that the wheelman finds his tour all one long sweet song. There is no hill climbing, no scorching heat, no rough roads. The scenery is delightful. On the one hand the great blue waters of the inland seas rise till they meet the light blue of the sky; while on the other the land rolls in gentle undulations, as it recedes from the lakes, until its lighter blue is mingled with the sky. The cyclist is carried among beautiful vineyards, nurseries, fine farms and through many beautiful little towns and hamlets, and the ever changing panorama presents varied and charming scenes.

While wheeling along the whole of the great chain of our inland seas is most delightful, and while there are hundreds of miles of superb roads close to their shores, the finest century run in America, and perhaps in the world, is along the South shore of Lake Erie, between Erie and Buffalo; or, perhaps more properly, between Erie and Niagara Falls. This delightful run is along one of the most beautiful of our great lakes and follows, for some miles, the banks of the most famous river in the world. The entire course is practically level. There are no hills worthy of the name, and the scenery along the route is scarcely surpassed anywhere.

For a number of years past this route has been popular with the wheelmen of Buffalo, Erie, Cleveland and other nearby cities; but it was not until within the last year or so the delights of the run became generally known to the wheelmen of other States.

Erie is a city of 40,000 people and is located in the Northwest corner of Pennsylvania, nearly midway between the cities of Buffalo and Cleveland. The distance between these 2 latter cities is, in round numbers, as cyclists go, 200 miles. As the roads between Cleveland and Erie are also excellent it affords the enthusiastic rider, who desires to spin off a double century, a fine opportunity. At the same time they may take in some more delightful country.

Erie is a delightful little city and is a fitting place for the inauguration of a century

run. Its streets are among the best in the land, and all around it are places of interest, well worth visiting. It is rich in historical memories, and the famous Conneaut lake, and Lake Chautauqua, are within easy reach. A whirl around Erie bay, a distance of some 15 miles, will be greatly enjoyed by all cyclists.

But it is the fine prospects of the century run that occupy the attention of the enthusiastic cyclist. So, let us start on our journey.

It is early morning and the faint rays of sunlight are just breaking through the Eastern forests as we leave the queen city of the lake, whose name it bears, and spin out along the blue waters which lay between us and Canada. Directly we are in the vineyard region and the whole country seems one great garden. Mile after mile we are mixed and mingled with the vines of that beautiful country. Here and there are pleasant little woodlands, with cooling springs, where the weary rider may rest and refresh himself. Then at times the monotony of the grape farms is broken by stretches of handsome nurseries and thrifty orchards. Ever and anon the great, blue expanse of water is hid from view; and when it appears again it seems more beautiful than before.

The road winds out along the railway lines, through quaint old Wesleyville, on through Moorheads, out to Northeast and before we know it we have completed the first 10 miles of our run. A few miles further on we unconsciously pass the State Line and leave behind the Keystone State.

Soon we are at Ripley, and the next 7 miles, to Westfield, is delightful wheeling. The road is as level as a floor and the breezes seldom cease blowing. Westfield is a delightful town, and is one of the centres of the grape industry.

A myriad of hamlets and villages are passed in the next 7 miles and then we reach Portland, which is as handsome a little town as could well be built. From Portland to Brockton is only 2 miles, and from the latter to Dunkirk 9 miles, all of which are pleasant ones for the cyclist, for each of them presents to him new beauties and renews his interest in the charming lake country.

We have now made a good half day run and so tarry here for dinner. The entire distance from Erie to Dunkirk is 50 miles. We have turned off half a century and feel little if any fatigue.

Dunkirk is a most interesting old town and is an excellent place for a hungry wheelman, for it has one or 2 famous hos-

telries which serve up just what such people want.

An hour's rest here and we are again off on our flight along Lake Erie. As we spin along vineyards are still on either hand and woodlands are scattered along the route. Waites Crossing is soon passed and then we reach Silver Creek. Here we strike a slight grade but it is scarcely noticed by a century rider.

In this vicinity we find some delightful scenery. Irving is 4 miles further away and on reaching it we find much of interest.

In the next dozen miles we pass Farnham, Angola, Derby and North Evans; all delightful places and some of them busy towns. Next picturesque Idlewood is passed and a few miles more brings us to Lakewood.

Then we reach Wanakah, in the name of which town is preserved the cognomen of some dusky son of the forest, who lived long before the pleasures of cycling were known.

Past the quaint old town we speed on our way. Athol Springs, which we next reach, has taken on a summer resort air and Bay View, a mile beyond, is a beautiful little lake town. Next we wheel into Blaisdell, and on through West Seneca. Now we catch a magnificent view of Buffalo, and soon we wheel, unwearied, into the city, where we prepare for supper.

Our century run has been made, but the 20 miles run from Buffalo to Niagara Falls, still before us, is a most delightful after supper turn. Nearly the whole road is macadam, and follows the shore of Lake Erie, and of Niagara river. The scenery is subdued and restful.

As you wheel out through Conawanda you take a parting look at old Erie's broad expanse, and then spin along through a magnificent stretch of country cleft by the Niagara river.

Lasalle is a beautiful little town, and nearer Niagara Falls we pass the great power house which is to furnish power for half a dozen states. The whole trip, along the river, is a most delightful one and as we near the end of our journey the roar of the world's greatest cataract comes distinctly to our ears.

At the Falls the cyclist is at a decided advantage. For him the army of cabbies and hotel drummers have no terrors. He is entirely independent and can spin around to a great many of the interesting points, at will. Niagara is a wheelman's paradise if there is one on this earth. From it we can take many interesting side runs, and in our wanderings find much of interest.

---

The horses will still be preserved  
 In spite of wheel or tandem,  
 Because of those Chicago men  
 Who 've cut 'em up and canned 'em.

## TWO GIRLS IN HALIFAX.

Editor RECREATION: We reached Boston at 10 a. m. and as the Halifax steamer did not leave till 4 in the afternoon we started out to see some of the sights.

We went to the Public Gardens, the Common, the Museum of Art and the Public Library. On leaving there we were caught in a terrific thunder shower and were drenched before we could get a car.

When we arrived at the steamer we thought our troubles were at an end; but alas! they had just begun. We were on board only about 3 hours when we went below to our berths and were not able to get out of them again until we landed at Halifax, which was at half past 8 the next evening.

We were both so dreadfully sick we could not raise our heads. A great crowd was there to see the steamer come in—half the town apparently.

The next thing was to find the Austens, so I took out a copy of RECREATION and carried it in my hand. "The Only Magazine on the Beach" attracted the attention of a young man who told us Mr. Austen had sent him to escort us to our hotel, Mr. Austen, himself, having gone out of town.

So here we are comfortably situated. This is a funny old seaport town, thoroughly English, you know, but we like it very much. The people are not at all up to date, according to our way of thinking. The nearest approach they make to our Yankee ideas is in having the trolley; but it is no such terror as the Brooklyn article. It is a milder brand, and goes easily about its devious ways.

Yes, and they are thoroughly up with the procession in one thing—that is they read RECREATION. We see it on all the news stands and hear bright men quoting it wherever we go.

An old gentleman, Mr. Greenwood (no relation to the cemetery—he is quite wide awake), escorted us to the military concert which we very much enjoyed. The soldiers are everywhere. One never goes out without meeting a bunch of red coats. We have been through their barracks and expect to go on board a man of war to-morrow.

The people here are charming—very sociable, slow moving, but they enjoy life thoroughly in their stolid English way. The other girls would have lots of beaux if they were here. Of course we don't have any. We don't approve of beaux.

This is not a cycling town. There are but few good streets or roads, for wheeling, and these are short. Hills are everywhere in evidence and altogether we are glad we did not bring our wheels.

So now Mr. Editor I wont take up any more of your time, for I see the sign "This is my busy day;" but I have one query which I hope you will answer in next issue



—When will they build a board walk across the Atlantic, from Boston to Halifax, so girls can come here without being sea sick? Dear me! how I dread the trip back! Tell the girls who are in camp I think a wet camp must be a lot better than a sick ocean trip.  
Jean Chapman, Bethune.

---

THE SCORCHER.

STANLEY WATERLOO.

Of callow and cheap ambition full,  
He lowered his head like a charging bull,  
And, bending over his handle-bar,  
Left a trail amazing of bruise and scar.  
He "scorched."

Terror on avenue, road and mall,  
Hated by wheelmen the worst of all,  
He chanced on a trolley, and then he died  
As fast as he'd ridden—and nobody cried—  
He'd "scorched."

And his soul went well and his soul went ill  
Till it found a path and it climbed a hill  
Where a saint named Peter it met, who said:  
"You were better alive than to be now  
dead.

"You scorched!"

And he heaved the soul, with an easy grace,  
As one's starter heaves in a cycling race,  
And the soul went down, in a coasting way,  
To a place where such as it go to stay  
And scorch!

---

BICYCLE IMPROVEMENTS.

To what limit the inventing of bicycle improvements has gone is shown by the Patent-office records in the United States. Up to 1876, only 300 patents for cycles had been issued from that office. In '76, invention revived on account of the excellent exhibit of English cycles at the Centennial Exhibition. Since '76, over 4,000 cycle patents have been granted and nearly or quite one-half of this number have been issued since 1890. In '90, one assistant examiner was able to dispose of all applications that were filed. In November, '96, it required 8 expert assistants to handle the applications for cycles; and even with this force there have been lately 1,000 applications constantly on hand awaiting action. At the present time, it is said, no country in the world is granting so many patents, for cycles and cycle improvements, as the United States.—*Cassier's Mag.*

---

A scorcher scorched on a scorching day,  
He scorched down the street pell mell;  
He scorched right into a trolley-car,  
And he's scorching now in — well,  
he isn't scorching any more in Illinois, anyhow.—*Chicago Record.*

CYCLING NOTES.

During these glorious September days we begin to have hints of Autumn, and to revel in golden rod and all the other good things the month has to offer wheelmen. The honey crop, of New England, largely depends on golden rod, which is more than ever bountiful this year, owing to the frequent rains.

What wheelman, touring, or otherwise, but delights in bread and milk and honey, a combination I can live on, and ride on, to good purpose.

And say, lets have a few big, baked sweet apples to go along with the aforesaid.

Of course a tender broiled venison steak should be "applied at breakfast time," and grouse pot-pie at eventide does not meet with much adverse criticism.

How general a custom it has become for city people to take their wheels with them when they go to the country, for the summer! And how the wheels do glide through Brookhouse valley, in the cool of the mornings and evenings, all through the summer!

More and more, each season, they multiply on our reads. And at least one motor carriage is owned here, that charms all who see it.

How free from dust, and dirt, and excreta our roads would be if horses were entirely replaced by these delightfully smooth running and much less costly motor vehicles!

This blessed state of affairs will some day be a matter of fact, I hope; for it does not cost a fraction to run the motor, that it does to feed a pair of horses, not to mention the dangerous and unpleasant habits and freaks of the latter.

Will any RECREATION reader, who has been to Jamaica, W. I., kindly send his address to Arthur Munson, Stamford, Ct.?  
Stam.

---

The new girl came half way up the front stairs, in the early morn, and vigorously tinkled the breakfast-bell. Instantly Mr. Pemberton squirmed to one side and fell out of bed with a dull thud. "Close shave," he muttered, as he rolled over on to his hands and knees. "What's the matter with you, Thomas?" cried his startled wife. "Eh—oh—where am I? Why, confound it all! I thought I heard a scorcher right behind me."

---

Arthur Munson, the Stamford, Ct., L. A. W., Veteran, whose broken hip last season was due to Connecticut's bad roads, is painting several hundred L. A. W. guideboards to put up all over the Nutmeg State. Its new law calls for them at every cross roads. They are good things for all road users.

## ON THE WHEEL.

A bright and happy face,  
A form of strength and grace,  
A speed that set the pace,  
Upon her wheel,

And she seem'd all alone,  
Yet room for me there's none,  
So, in my sweetest tone,  
Upon my wheel,

I said, "Excuse my mood,  
But do I not intrude?  
If you'll not think me rude,  
Upon my wheel,

I'll ride by you, my dear."  
She said, "Oh, no, not here,  
My husband's in the rear,  
Upon his wheel."

Albert Hardy, in  
L. A. W. Bulletin.

"Gracious, Billy, I'm in a fix; you know  
I sold my old wheel and got a '97?"  
"Yes?"

"Well—my wife got onto it—and blamed  
if she hasn't gone and sent off her sewing-  
machine and piano—bound to have this  
year's make."

Fatal accidents to wheelmen have been  
alarmingly numerous, during the season  
now drawing to a close. As usual the  
most of these may be attributed to reckless-  
ness on the part of the victims, and it would  
seem other riders should take warning; but  
they will not. Beginners, or new riders,  
are always cautious; but from the very day  
on which a rider comes to class himself as  
an expert, thence dates his recklessness.  
In 9 cases out of 10 it is the Smart Alecks  
who are hurt, or killed, while on their  
wheels.

It serves them right, but in some cases  
their death or injury is a hardship to their  
friends, or to those who are dependent on  
the riders for support.

"Madge suffered terribly when her en-  
gagement was broken."

"Yes, but her father got her a '97 wheel  
and she soon came around all right."—  
Chicago Record.

Six expert wheelwomen rode from Jer-  
sey City to Philadelphia in 12 hours, on  
September 1st.

The party was captained by Mrs. Ida F.  
Wallars and the other centurions were Miss  
Clara Jones, Miss Bessie Sheldon, Miss  
Laura Berg, Miss Ida Johnson and Miss  
Lizzie Sheridan, all well known in the met-  
ropolitan district.

Male escorts accompanied the ladies, but  
were not to figure in the distribution of  
century medals.

Helen—Why, I never saw anybody like  
George; he can talk on any subject.

Aunt Hannah—Any subject? Nonsense!  
Name one subject on which he can talk  
intelligently.

Helen—Well, aunty, you should hear him  
talk bicycle.

Aunt Hannah—Bicycle! Fiddlesticks!  
What other subject?

Helen—What other subject? There is no  
other subject worth talking about.—Bos-  
ton Transcript.

The silver punch bowl won by the Morris  
Wheelmen, in the New York-Philadelphia  
century runs, has been engraved with the  
names of the 34 members who captured it  
for the club.

"There is one class of people who are  
thoroughly down on the wheel."

"Who are they?"

"Keepers of boarding houses."—Wash-  
ington Times.

In addition to the single, double and  
triple century runs of the Rutherford  
Wheelmen, several other centuries have  
been planned to take place in October.

Maud Muller on a summer's day  
Raked in the meadows, sweet with hay;  
And later on, with a joyous squeal,  
She raked in cash to buy a wheel.

—Chicago Record.

A century run, under the auspices of the  
Empire State Wheelmen, will go over the  
Brooklyn-Oakdale (L. I.) course, on Sep-  
tember 12.

"Does your baby walk yet, Mrs. Tar-  
bell?"

"Walk! Bless you, no.' But he can ride  
all round the nursery on his little bike!"—  
Cleveland Plain Dealer.

The crossings of Eighth avenue at 14th  
street, 23d street, 34th street and 42d street  
are to be repaired at once.

Burrows—What is the best wheel on the  
market?

Hills—The best wheel is not on the  
market any more. I bought it myself 2  
weeks ago.—Indianapolis Journal.

Wheelmen are elated over the fact that  
Park avenue is to be asphalted.

Mary got a little bike,

When to that length she'd gone,  
She likewise wed, that she might have  
A man to hold her on.

—Detroit Tribune.

## CANOEING.

### THE A. C. A. '97 MEET.

E. G. M.

Wishing to miss nothing of the sport and good fellowship which rule at a canoe meet I determined to be early on the ground; so, 6.30 a. m., of August 6, 1897, found me on the wharf at Clayton, N. Y. A steamer flying the well-known A. C. A. signal soon tied up at the station wharf, and a porter with a badge which identified him as being connected with the canoeists' camp, took my checks and my duffle was soon aboard.

We found several other passengers on the "Pastime," and before we came in sight of the big burgee, flying from the high hill above the camp, we had become well acquainted, as canoeists always do, no matter where they meet.

We reached the camp, at the head of Grindstone island, in the St. Lawrence, at 7 a. m. Every one there seemed still asleep, except a few early bathers.

The reception committee of 3, in bathing suits, introduced themselves as Commodore McKendrick, Acting Secretary-Treasurer Aitkin and Camp Site Committeeman Morse. Our hand satchels were deposited on the Commodore's "front door step." Then "Camp Site" Morse disappeared for a few minutes and reappeared ready for his daily routine of duty.

As we had followed the advice given in the Camp circular and had mailed instructions, in advance, as to tents, cots and chairs, before the thrilling "Mess Call" sounded from the hill top we found ourselves comfortably settled in our canvas homes and ready for one of Caterer McElveney's satisfying breakfasts.

Among the arrivals that morning was Ex-Commodore Huntington, who introduced us to one of the luxuries of the camp—a swim in the clear cold waters of the St. Lawrence.

Friday night a special trip of the Pastime brought in the Rochester contingent, under command of Vice-Commodore H. M. Stewart, with that well-known and most comfortable war canoe the "Huff," which, with its brightly painted sails, was thenceforward one of the features of the camp. As the new arrivals were weary with handling their canoes and duffle several times during the day they accepted an invitation to remain at headquarters, and at 9.30 there were 9 weary canoeists stretched on cots in the "Home-for-the-Friendless"—a 20 x 40 tent, pitched near the wharf.

Early Saturday morning the New York car arrived under the careful attention of Mr. J. K. Hand, familiarly known to every one about camp as "Jimmy" Hand.

The camp was so well planned that within an hour after landing the men were busy pitching their tents.

Saturday night a reunion was held, around a great camp fire at headquarters, which was enlivened by the orchestra under the combined leadership of Tommy Hale, of Yonkers, and Dr. Leroy, of Newark, and by vocal selections by the Commodore's Squaw Point party.

Sunday was a quiet day in camp. The incident of the day was the arrival of 2 full manned war canoes from Brockville, 30 miles down the river. On landing they were decorated with visitors' badges and were made the guests of the Association. After enjoying the good things to be found in the mess tent, as good paddlers can, they visited the various sections of the now extensive camp grounds. The sight, as they left for home, was one long to be remembered. The blue waters of Eel bay were dotted with white winged sailing canoes.

The Kingston yachts, Chickadee, Hustler and Geisha, were manœvering in the background; the Huff, manned by a full crew with the signal cannon and official bugler on board, and the official steamer Pastime, acted as escort across the bay, the 45 paddles keeping stroke to the march played by the bugler. Before parting the visitors gave 3 cheers for the A. C. A.; which were answered by the signal cannon and 3 and a tiger for the Brockville Canoe club.

After "Sundown" had been sounded, and the colors lowered, the Huff set sail for Squaw Point and gathered the musicians. Then, floating about with many smaller craft the passengers treated those on shore, about the camp fire, to a series of sacred songs.

An alarm of fire was sounded and No. 1 Fire company, under command of Captain Harry Dater, turned out in some seconds below the record time and, making a good run and coupling quickly, put out the blaze before any serious damage was done. The hose reel had been kindly loaned by the baggage master, at Clayton, and did good service during the meet, as many an amateur baggage smasher can testify.

As the clear notes of the bugle sounded "First Post" the party dispersed, and by the time the sleepy notes of "Last Post" were heard the camp was in darkness.

Early Monday morning, the sailing buoys having been laid, the sailing craft were feeling of one another and presented many pretty pictures during the first days of the meet; but as the wind blew very hard, during the last days of the first week, the bay was almost deserted by sailing craft; though occasionally a paddling crew

would do a half mile over the paddling course.

The advent of an enthusiastic party of a dozen canoeists from Buffalo, under command of Captain Thorn, added much to the interest of the meet, they being new members and desirous of having a full share in all that took place.

On state occasions they all appeared in uniform dress, reminding us of the early days of the A. C. A., when the New York and Brooklyn club men were known by their camping costumes. The buffaloes brought with them their war canoe, the "Quid Pro Quo," and right well did they man her. Seldom was she found on the beach. She was usually filled with a merry party of Squaw Pointers, who had accepted the invitation of the Buffaloes to paddle to some of the interesting points near camp.

Before the Buffalo boys had been in camp 48 hours they were the darlings of Squaw Point; and the cinder path that ran round the bay, to the South, was a regular "Buffalo run."

Never before was Squaw Point so popular. The Officer of the Day was besieged with applications, from members of the main camp, who begged to be appointed Squaw Point pickets; and he was considered a favored brave who wore the red badge in the ladies' camp. Some pickets were so zealous in their duties that they never got beyond the first inviting hammock, where they would sit and watch for intruders. Others preferred a cold lunch, at a private mess tent, to one of McElveney's best dinners when the enjoyment of the latter required that they should absent themselves from the presence of the ladies for an hour. Another, who shall be nameless, spent his hours of duty in an eloquent reading of his favorite poet to the favored squaws.

Squaw Point offered much variety this year and the campers there proved themselves genuine canoeists. At one end of the line we find 10 cruising canoeists, who paddled into camp, set up their little cruising tent and, over an open fireplace, cooked their meals and enjoyed the variety even more than those who relied on the general mess. Another and larger party had their private kitchen where many a wanderer was invited in to partake of bread and home-made jam, or of a bit of rare old Canadian cheese. Still others provided their own breakfast and supper and relied on the general mess for their mid-day meal. This was one of the signs of a return to the simplicity of former years. Other such signs were to be found at the extreme end of the main camp, where a number of camp stoves and fireplaces were set up, and where many and varied tin dishes were hung on the trees.

I shall not attempt to give the results of

the several races but shall merely mention them as they impressed me.

The sailing races were not the attractive feature they have been in other years. The reasons advanced why this was so, were many. Some suggested this was because results in the principal races seemed to be practically settled before the races started.

There were a number of untried boats and the strong and puffy winds of Eel bay caused others to hesitate. The greatest number of starters in any sailing race was 6; and several races were called several days before they were finally given up. The open canoe sailing races produced pleasing contests and, strange to say, the Northern division, the home of the open canoe, was practically unrepresented in these events.

The paddling races were well contested and in some of them better work was done than has been for many years, at an A. C. A. meet. Particular mention may here be made of the mixed tandem, the ladies' single and the ladies' tandem; where, though the number of contestants was small the style of work done, by one and all, served as a model for others to strive to reach.

The swimming race, and the hurry scurry, brought out better men than have ever before contested in these events.

The war canoe race was the most exciting and enjoyable event of the meet. Vice-Commodore Burns gathered together a crew of sinewy Canadians, in the heavy and slow "Argo." Captain Drake, of Boston, brought his braves from the East and manned that beautiful racing canoe, the "Mabewawa." Captain Thorn, of Buffalo, sounded his war-whoop and shipped a select crew of "Ancient Mariners," who surprised us all by making an exciting finish with the leading canoe. This latter was at once dubbed "The Old Men's Home."

Had I a facile pen I should try to describe some of the funny incidents of the meet; such as the baseball match, in the hayfield, Canadians versus—What?—United Statesians?—in which the home team well upheld the honor of their national game. Who can describe the instructions given the umpire, and several players, by the megaphone artists perched on top of the 2 haystacks that served as backstops? Here it was that F. M. Pinckney, making a brave steal of second base (a huge boulder) sprained his ankle and thereafter enjoyed the fun of the camp from a reclining chair, in "Hogan's Alley."

Shall I attempt to describe the celebrated Hogan's Alley? No, I will merely insert here the ode, composed by the Squaw Pointers, to "the only Hogan," and sung at one of our camp fires by a jolly lot of voices:

Oh! sweet Mr. Hogan has beautiful eyes;  
As deep as two oceans, as blue as two skies;  
And the glances they cast are like comets' big tails—  
Sure such eyes are quite fit for the Princess of Wales.

## Chorus :

Fal-dal-de-al dal-de-al dal-de-ay,  
 Masha-fal-dal-de-al-dal-de-al-dal-de-ay,  
 Fal-dal-de-al dal-de-al, dal-de-ay,  
 Arrah-fal-dal-de-al-dal-de-al-dal-de-ay.

His teeth are like pearls strung out in two rows,  
 'Tween luscious ripe cherries right under his nose ;  
 They form a nate fence, round such nice private grounds  
 Where a sharp tasing tongue never stays within bounds.

His complexion, indade, has an exquisite tint,  
 So rich and so rare, by the angels was lint ;  
 Oh ! nought could compare with his blushes so red—  
 When he walked in the garden, the roses dropped dead.

His neck and his shoulders, each arm and each hand,  
 With freckles and sunburn are frescoed and tanned ;  
 Like brown-speckled beauties right out of the brook,  
 The ladies are pining for one killing look.

“ What it is, is it ? ” and “ Where am I at ? ”  
 “ Ask me the question the answer is, what ? ”  
 There's one thing he does, 'tis the joy of his life,  
 And that is to write to his far-away wife.

There's Upham and Dater, and Dunnie and Hale,  
 And Wilkin, whose gay jokes they never grow stale ;  
 And Unfortunate “ Pink,” who has had a bad sprain  
 “ Hogan's alley ” for “ rare bits ” that ne'er give a pain.

I would I could describe one of the mid-night swims, when some restless mortal would start through the camp and invite all to swim “ in the altogether,” from the main dock. It is needless to say there was sound sleep after that, till the sun would almost burn holes in the tents. Then there was the official swim, under command of Ex-Commodore Huntington, when the face of the waterscape was changed by the removal of all the reeds, by 3 dozen sturdy pullers.

Then there was the formation of the Sailors' Union, followed by a general strike ; and the mass meeting on the hill, where the Union decided to boycott the races until the breezes blew more gently.

The hop, in the big mess tent, was one of the events of the encampment. Invitations were issued to the several summer hotels, near camp, and the Pastime was sent to convey the invited guests, who found the camp ablaze with camp fires, and with red, white and blue lanterns, by the hundreds, all along shore, with a plentiful supply of Chinese lanterns to add to the beauty of the scene.

The visitors declared this the most picturesque function they had ever attended, and hoped they might have the pleasure of being invited to other and similar partys.

Can I ever forget the “ Tearing of the Shirt,” when, on a calm Sabbath evening a well-known Philadelphia paddler appeared at the mess tent, late for supper, in a most gorgeous, blazing, red-hot tartan shirt? Or the groans, the howls, the cat calls that greeted its appearance? Or the invitations to remove it; the attempts to light cigarettes from its blazing folds? Or its appearance at the top of the highest flagstaff within 3 minutes of its first dazzling the eyes of the canoeists? In less time than it takes to tell this, every man, woman and

child in camp was wearing that shirt—some as hatbands, some as neckties and some as badges. Some men then slipped quietly away to their tents and placed under lock and key, at the farthest corner of their trunks, certain articles of wearing apparel in order that the vulgar gaze of their fellows might not be offended thereby.

As to the business done at the meet the official records will show that Frank L. Dunnell, of New York, was elected Commodore; C. V. Schuyler, of the same place, Secretary-Treasurer, and that a recommendation was received from the Atlantic division, that the St. Lawrence be the scene of the '98 meet.

The making of RECREATION the official organ of the A. C. A., and providing for the sending of this magazine to every member, marks an important stage in the life of the A. C. A.; and those who shared in obtaining this favor feel that they have given the American Canoe Association a great impetus toward a still more extended influence and power.

If the canoeists, and more particularly the cruisers, do their duty by the official organ, no issue will be published, hereafter, without one or more accounts of cruises, which accounts will be read with pleasure by hundreds of members whose time and circumstances do not permit of their sharing in this best of all forms of canoeing.

This latest move will answer the oft repeated question, “ What do I get for my dollar.” Hereafter each member gets a full dollar's worth of clean, attractive and varied reading matter, in addition to the latest news from the canoeing world.

The retiring officers were assured, by many of the members, that the meet of August 6th-20th was one of the most enjoyable ever held by the American Canoe Association.

## AMERICAN CANOE ASSOCIATION.

## OFFICERS FOR 1898.

Commodore: Frank L. Dunnell, 35 Wall Street, New York; Secretary-Treasurer: C. V. Schuyler, 309 Sixth Avenue, Brooklyn, N. Y.; Librarian Custodian: W. P. Stephens, Bayonne, N. J.

## BOARD OF GOVERNORS.

President: Robt. J. Wilkin, Brooklyn, N. Y.; Paul Butler, Lowell, Mass. Recorder: C. V. Winne, Albany, N. Y.; J. N. McKendrick, Galt, Ontario, Can.

## DIVISION OFFICERS.

*Atlantic Division.*

Vice-Commodore: Thomas Hale, Jr., Yonkers, N. Y.; Rear Commodore: F. M. Pinkney, 111 Broadway, New York; Pur-

ser: W. M. Carpenter, Sing Sing, N. Y.; Executive Committee: F. C. Moore, Bensonhurst, N. Y., Geo. P. Douglass, 24 Broad Street, Newark, N. J.

*Eastern Division.*

Vice-Commodore: L. S. Drake, Auburn-dale, Mass.; Rear Commodore: R. H. Hammond, Worcester, Mass.; Purser: F. J. Burrage, West Newton, Mass.; Executive Committee: Parry C. Wiggin, Boston, Mass., Butler Ames, Lowell, Mass., A. W. Dodd, Hartford, Conn.

*Northern Division.*

Vice-Commodore: D'Arcy Scott, Ottawa, Ont.; Rear Commodore: G. R. Howell, Toronto, Ont.; Executive Committee: J. McD. Mowatt, Toronto, Ont.

*Central Division.*

Vice-Commodore: J. R. Stewart, Rochester, N. Y.; Rear Commodore: A. N. McNabb, Buffalo, N. Y.; Purser: L. C. Woodworth, Gouverneur, N. Y.; Executive Committee: H. C. Morse, Peoria, Ill., F. G. Mather, Albany, N. Y., T. H. Stryker, Rome, N. Y.

Membership Competition.

The Commodore and Secretary-Treasurer offer an *Open Canadian Paddling Canoe*, with single blade paddles, as a first prize, also a pair of single blade, or double blade paddles as second prize, the member, who secures before the opening of the 1898 Meet, the *greatest* number of new members (active) to the A. C. A.

The re-election of ex-members will not count in this competition.

The presentation of prizes will take place at the Meet.

Send a postal card to the Purser of your Division, for application blanks. For further particulars apply to the undersigned.

Frank L. Dunnell, Commodore,  
C. V. Schuyler, Secretary-Treasurer.  
New York, September 7, 1897.

To the members of the Board of Governors, A. C. A.:

There will be a regular meeting of the Board of Governors of the American Canoe Association on Saturday, October 16, 1897, at the Clarendon Hotel, Brooklyn, N. Y., at 2 o'clock p. m.

You are invited to be present.

Robert J. Wilkin, President,  
Charles V. Winne, Recorder.  
Albany, N. Y., September 7, 1897.

NOTICE.

To the Executive Committee of the American Canoe Association:

The Annual Meeting of the Executive Committee of the American Canoe Association will be held at the Clarendon Hotel,

Brooklyn, N. Y., on Saturday, October 16, 1897. Meeting will be called to order at 10 o'clock, a. m.

Frank L. Dunnell, Commodore-elect,  
C. V. Schuyler, Secy.-Treas.-elect.  
New York, September 7, 1897.

PUBLISHER'S DEPARTMENT.

Mr. J. H. Barlow, manager of the Ideal Manufacturing Co., New Haven, Ct., sends out a circular to the Sporting Goods Trade in which he announces the mailing of the Co.'s Hand-Book, No. 9. This line of arms, ammunition and tools is fast becoming complex and puzzling, on account of the great increase in the varieties of ammunition for the various arms. Mistakes in ordering, or not understanding orders correctly, cause delay and extra expense, as well as annoyance. Particularly is this so on account of the similarity in the names of calibres and weights of bullets for cartridges that are entirely different. It is hoped the lessening of the possibility of mistakes will be appreciated by dealers, and by all shooters.

The Ideal Implements are well known wherever fire arms are used. They stand on their own merits. Close attention to the perfection of the various points that are required to produce perfect work, has made a reputation for these goods, second to none. The makers are constantly on the look-out for the requirements of the shooter, presenting new and useful implements, from time to time, that are up to date, thus bringing dealers and customers into touch with the present.

Write for the new Handbook, mentioning RECREATION.

The Marlin Arms Co., New Haven, Conn., is always up to date, and always has something interesting to offer sportsmen. It has lately put out a new catalogue, that contains a vast fund of valuable information regarding new rifles, cartridges, re-loading tools, sights, etc. Almost every rifle cartridge in the market, from the 22 short to the long smokeless, is illustrated and discussed; and among other new features are a number of reproductions of targets, made with these new rifles and the new ammunition, at various distances and under various conditions. There are a lot of cuts of new bullets, separate from the shell, showing methods of inside and outside lubrication, of front cavities, for imparting the express feature, that are exceedingly interesting. There is a discussion of the manufacture of gun barrel steel that will interest every rifleman who has any mechanical or scientific turn of mind.

Every reader of RECREATION should have one of these new catalogues, and in asking for it should mention this magazine.

## FOUR SNOW COVERED MOUNTAINS

on the Pacific Coast, can be seen from the car windows by the traveler over the Northern Pacific Railway. They were once volcanoes—aggregate almost 48,000 feet in height—are seen for hours at a stretch and in regular succession, not all at the same time. It is an inspiration, an education to every man and woman, every boy and girl to see these magnificent peaks. They are covered with ice and to climb to the summit of one of them is a great feat. The lowest of these mountains is 9,750 feet high, and each mountain is visible for its full height. Their names were given to them 100 years ago, by distinguished men. Every attendant of a public school should know something about these snowy peaks, even if not able to see them. Send 6 cents in postage stamps to Chas. S. Fee, Gen. Pass. Agent, St. Paul, Minn., and he will mail you a book of about 100 pages, that describes these mountains and that has illustrations of them.

The Union Metallic Co., 315 Broadway, N. Y., has issued a digest of the game laws of all the States and territories in the Union, and all the provinces of Canada, a copy of which will be sent free to any person writing for same, and mentioning RECREATION.

This is a remarkable piece of liberality on the part of this company, and will save the sportsmen of the United States and Canada thousands of dollars. Several digests of game laws are published, each year, by individuals, but all have been for sale; and to have a reliable compilation, put up in a neat, convenient form, as this book is, and sent for the asking, is a favor which all sportsmen will appreciate. Do not forget to mention this magazine when you write for the book.

As many birds as we have, and they have never been more vociferous, we cannot hunt them till January 1st. Turkeys are unusually plentiful and actually come up with our tame ones. I hear of no deer. Under these circumstances, we are not seeking sportsmen *per se*, but if you know of any gentleman who would care to bring his family to a healthy old country place, where there is comfort and satisfaction in being alive, I wish you would commend us to them for the months of October and November. We would give them all the entertainment to be had and there is certainly much satisfaction to be gotten out of country life during these 2 months. It would cost no more than staying at home and would be possibly more enjoyable. As the house is large we could take quite a colony.

Jennie P. Buford,  
Lawrenceville, Virginia.

The Ideal Mfg. Co., New Haven, Conn., has gone into the soap business. Brother Barlow has not, by any means, quit making reloading tools, but has hit a bright idea, which he has simply hitched on to the hundreds of others he has evolved, in times past. This new soap is put up in thin sheets, cut into small leaflets, and bound in a book which you can carry in your vest pocket. Each book contains 50 leaves of soap, and each of them will wash a pound of dirt and grease off the hands of any man.

This soap will be indispensable to sportsmen when they find out how good and how convenient it is. For my part I do not intend to be caught out of the house, again, without one of these books in my pocket.

The American Metal Polish Co., Akron, Ohio, makes a line of polishes for various metals, for china ware, window glass, etc., that are exceedingly useful in every office and in every household. Among the various brands they make are Tripoli, Crocus, Emery and Rubber Compositions; White Nickel Compositions; Chandelier Stick; Gold, Silver, and Nickel Rouges; Eagle Brand Brass and Copper Polish; Engine Polish; Putz Pomade; Steiner's Household Polish, etc.

All these goods do excellent work, and the polishing material in them is so finely prepared that it does not cut the metal, as many preparations do. Send for circular. Mention RECREATION.

THE ONEITA union undergarments, for men, women and children, undoubtedly fill more of the requirements of perfection in underwear than any other style of undergarment on the market.

Write Wm. Iselin & Co., 1 Greene St., N. Y., and they will send you a handsome little illustrated booklet, giving the reasons why this underwear has been so wonderfully successful. It also gives other interesting details regarding these goods. Mention RECREATION.

Members of the American Canoe Association, who have fine photos of any scenes or objects pertaining to that sport, are requested to send me copies of them for publication.

## DON'T FORGET

that if you want Volumes I and II of  
RECREATION  
you must order in advance.

The book will not be printed unless 400 advance orders are received.

ORDER AT ONCE.

Definition of the word

**“KODAK”**

The *Standard Dictionary* says:  
 “Kodak is an arbitrary word constructed for trade-mark purposes.”

We originated and own this trade-mark. No camera is a “Kodak” unless manufactured by the Eastman Kodak Company.

Don't let the clerk sell you any other camera under the name of “Kodak.”

If it isn't our make, it isn't a “Kodak.”

**Bicycle Kodaks, \$5.00 to \$25.00.** *Booklet free.*

*“You press the button,  
 We do the rest.”*

|                                                                                                                                                            |
|------------------------------------------------------------------------------------------------------------------------------------------------------------|
| <p>\$2,853.00 in Prizes for<br/>         Kodak Pictures.<br/>         \$1,475.00 in Gold.<br/>         Send for “Prize Contest”<br/>         Circular.</p> |
|------------------------------------------------------------------------------------------------------------------------------------------------------------|

**EASTMAN KODAK CO.**

**ROCHESTER, N. Y.**



## AMATEUR PHOTOGRAPHY.

### HOT WEATHER DEVELOPMENT.

During the hot months plates and films have a tendency to soften and frill. This may be overcome, altogether, if proper care is taken during development. Have the developer cold, made so by the addition of a lump of ice. Then add ice water, from time to time as the bath becomes too warm. Plenty of ice will prevent any plate, or film, from frilling.

Then the fixing bath. I use Carbutts, made as follows: dissolve 16 ounces hypo in 48 ounces water; 2 ounces sulphite of soda crystals, in 6 ounces water; one dram sulphuric acid, in 2 ounces water; 1 ounce chrome alum in 8 ounces water.

Mix sulphuric acid with the sulphuric solution; add it to the hypo solution and then add the chrome alum. Label this "stock solution." For use take 8 ounces stock, 8 ounces water and 3 ounces hypo crystals.

This may be used repeatedly, strengthening occasionally by adding a few lumps of hypo as it becomes weak and fixes too slow. This bath hardens the film and yields a good, clear negative.

In handling films I always develop several at a time, face down to avoid scratching. When taken from the final washing I place them in water 32 ounces, glycerine 1 ounce, for 5 minutes. Then hang or pin up to dry, without further washing. This makes them stay flat, which, in turn, makes them easy to handle. Make up the hypo bath just before you begin developing, using cold water. The rapid dissolving of the hypo reduces the temperature still further, which is the main point in warm weather.

Let the films, which have been soaked in glycerine, hang several days. It takes some time to dry them, owing to the slowness with which glycerine evaporates. I neglected to do this and had a large number stick together. They also stuck to the paper, during printing, by a few small drops which I did not notice until it was brought to my attention, forcibly, by the paper adhering to and destroying the plate, for future use. Make haste slowly. It don't pay to rush work, in photography.

---

### HER CONTRIBUTION TO THE BOOK.

The "Detroit Free Press" tells this story":

Gentlemen—A letter from you addressed to my husband has come to hand. You ask him to write an article for your "Photographic Annual" that is to be published next year; and you put in some taffy about his being a well-known amateur, and some stuff about what he writes

being of interest, and that sort of thing. My husband is now on a photographing tour, as he calls it, and of course I open all his letters. It is not likely he will be back in time to write the article you wish. When he goes off with that confounded camera of his you never know when he will come home. So I am very pleased to give you a woman's view of amateur photography, and you can print it in your "Annual" if you like.

My unfortunate husband was stricken with the amateur photographic plague about 3 years ago. Up to that time I always considered him reasonably sane. I made no objection, at the time, to his joining the army of photographic cranks, because, you see, I knew nothing of the subject. I have done everything I could, since that time, but, although he has quit smoking at my request, he refuses to give up the camera habit. At the time he began this so-called recreation my house, or perhaps I should say our house, was one of the neatest in the neighborhood. You ought to go through it now. My carpets have been ruined with the abominable chemicals he uses. I don't pretend to know their names, but I know the effect they have. Then the bath-room is something frightful to behold. He uses that for what he calls his dark-room, and has contrivances for shutting out the light.

I noticed that in one of the books you sent him, Daguerre was the inventor of photography. He may have been the inventor of photography, but I think it was another sulphurous gentleman, with the same initial, who was the inventor of amateur photography.

My husband was reasonably good-tempered until he took up your diabolical art. I one time opened the door of the room in which he was working. It was all dark inside except a fearful red lamp, which threw a ruddy glow on his face and made him look as if he were going to have an epileptic fit. The moment I opened the door that man went perfectly crazy. He said I had spoiled a dozen of his plates, although I had touched nothing, and I came near suing for a divorce because of his awful remarks. If the evil one was not the inventor of amateur photography, then I should like to know who was.

The pictures my husband does turn out are perfectly awful. He has tried, at different times, to photograph the children; but the poor little dears looked like wooden images, in the pictures. I went into the bath-room once, with the baby, and put him in the bath-tub. There was some water there already, and it looked clear enough, but in it was some horrible solution of silver that turned most of the baby

jet black, and we haven't been able to get the color out to this day.

Then the cost of the thing is something frightful, although my husband carefully conceals what he spends on it. I came across one of the photographic dealer's bills the other day, and it was enough to make one's hair stand on end. Pyrogallic acid, whatever that is, was 50 cents an ounce.

Just think, if I had to pay that price for sugar it would be 88 a pound, instead of 10 cents!

Fifty cents an ounce! And that wasn't the worst of it. Now what do you think chloride of gold costs? For 15 grains he is charged 50 cents. Now that, as you know, is nearly \$20 an ounce, and \$20 an ounce is over \$300 a pound! I don't know how many pounds of the wretched stuff he uses every week, but if he uses 10 pounds of it, and I am sure 10 pounds of sugar doesn't go very far in a house with a large family like ours, you see that is \$3,000 for that one thing alone, not to mention the dozens of other chemicals he uses; and I am sure I don't know what the price of them is.

I tell you amateur photography was invented to drive a poor woman crazy, who has a husband who is a victim of the villainous practice. No wonder he says he can't afford a new dress for me, when I ask him for it. The house is stained with horrible solutions from cellar to garret, and I am always afraid to use any cups or glasses for fear there is some dreadful poison in them. The cat took some milk out of a saucer that had something or other of potassium in it, and it just curled up and died.

I am always afraid to sweep, in any part of the house, for fear it will raise a dust that will spoil something he has tacked up on a board to dry. I wouldn't mind all this so much if he ever took a picture that was worth looking at; but, as I said before, he never does. There, now, print that in your miserable photograph book, if you want to.

Mrs. John Tripod.

N.B.—If you ever write to my husband again, telling him his articles on photography will be appreciated, I will burn your letter, and you will lose your postage stamp. So just remember that.

Mrs. J. T.

Is it possible to photograph a running horse, and get a good picture, that will look as if he were perfectly still? If so, where can I get a shutter and a lens that will do it. I am an ardent RECREATIONIST.

F. D. Fowler, Denver, Colo.

ANSWER.

Thousands of photos of running horses have been made, some of which show scarcely any movement. The majority of them, however, are more or less blurred,

especially about the feet, which move faster than the body. The Prosch, the Gundlach, the Bausch and Lomb, or almost any of the high power shutters are quick enough to make these pictures, under proper conditions. Of course, the light must be very strong and the camera should be 50 to 100 feet away from the horse, so that the angle of movement may be as low as possible. The best results are obtained where the photographer stands either in front of or behind the horse; though, as I have said, good broad side pictures may be made and thousands of them have been.

A lens expert recommends the Dallmeyer extra rapid Rectilinear lens, as the quickest aplanatic lens in the world.—EDITOR.

RECREATION'S 3rd Annual Photo Competition will open January 1, '08, and will close April 30, '08. The conditions will be similar to those of previous years, though there will be some changes, and the list of prizes will be fully as liberal as heretofore.

I trust every amateur photographer in the country will improve the golden opportunities afforded by the autumn months, for making pictures for entry in this competition. It is my intention to establish a special class and to offer a special prize, in the next competition, for pictures of live wild animals and birds, and in this class I hope to have many entries.

I have but lately become acquainted with RECREATION, and now would not do without it, if it cost twice as much.

I carried a camera over 8,000 miles, last summer, and would like to exchange prints with any amateurs who have learned to do their own work, from start to finish, as I do.

F. R. Archibald, Rock Creek, O.

Have read the latest number of RECREATION from cover to cover and it can't be beaten. One feature that pleases me is the space devoted to photography. I am always pleased to see the boys go into details as to the plates used, time, make of camera and various other items of interest.

I would like to exchange some Black Hills minerals for books or magazines on out-door life, photography, fishing, etc.

A. E. Parks, Lead, S. D.

All sportsmen should do a large part of their hunting with the camera. If Richelieu had lived in these days he would have said,

"In the hands of men entirely great  
The camera is mightier than the gun."

He—Did you ever have things stolen from you?

She—Oh, yes.

He—What were they?

She—Kisses.—Chicago Record.

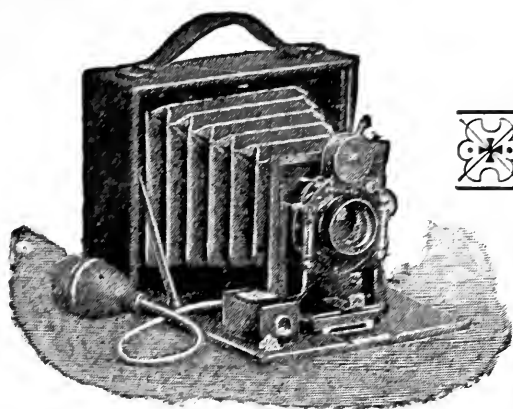

**P**REMIOS  
PRODUCE  
PERFECT  
PICTURES



# Premo Cameras

Have achieved an enviable reputation the world over. Their PERFECT construction and ease of manipulation, combined with grace, beauty, and superb finish, have placed them in the front rank, and they are to-day the Favorite Camera with the foremost Amateur and Professional Photographers.

MADE IN

**20**

DIFFERENT STYLES  
AND SIZES

Special Designs for the Sportsman and Tourist

CATALOGUE MAILED FREE

Rochester Optical Co., Rochester, N. Y.



(Taken on a Carbutt Orthochromatic Plate.)  
By ALOIS BEER, Photographer to Emperor of Austria.

## To Obtain Artistic Results

as much care must be used in the selection of the Plates or films as the Camera.

### CARBUTT'S PLATES AND FILMS

(STANDARD FOR 20 YEARS)

Give Universal Satisfaction

Also J. C. DEVELOPING TABLOIDS, put up in 3 sizes, price 25c., 40c., 75c.

If you intend competing for prizes let us assist you in winning by the aid of our Plates, Films, and Developer. For sale by all dealers. Catalogue free.

JOHN CARBUTT, <sup>WAYNE</sup>JUNCTION Philadelphia, Pa.

## THE MARLBOROUGH CAMERA

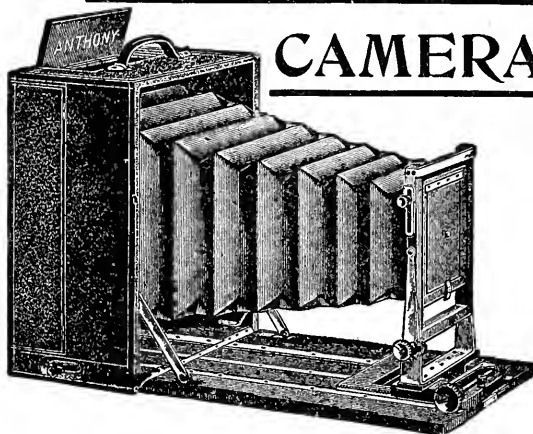

### REVERSIBLE SWING BACK RISING AND SWING FRONT

- 5x7, fitted with Rapid Rectilinear Lens, B. & L. Shutter, and two Double Holders, \$60 *Send for Free*
- 8x10, without lens and shutter, . . . . . 50 *Illustrated*
- 6½x8½, . . . . . 45 *Booklet*
- 5x7 . . . . . 35

Send for Free Pamphlet of \$5 and \$8 Cameras

Try Metacarboll, the most powerful developer known.

Catalogue of all kinds of Cameras and all requisites for photography mailed on application. Free

We recommend CLIMAX DRY PLATES They are quick to amateurs and reliable

The INTERNATIONAL ANNUAL, Vol. IX., 100 illustrations, 80 practical articles on photography, now ready. Price, 75 cents; postage, 15 cents.

E. & H. T. ANTHONY & CO.  
591 Broadway, New York

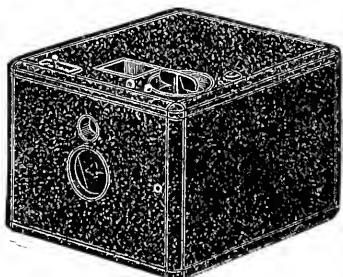

The Baby, \$6

Size, 2 1-2 x 3 1-2 x 4 in.  
Photo, 2 x 2 1-2 in. Weight, 7 oz.  
Loaded with 12 exposures

## Success in Photography

is only obtained by using an outfit well made, with high-grade lens, and reliable shutter.

### The Hawk-Eyes

manufactured in various styles and sizes from the "Baby" up, can be loaded and unloaded in broad daylight, can be used with film or glass plates and warranted to prove just as represented.

## Why not make your Own Photographs?

A Guide-Book is furnished with each camera that will enable the novice to produce good results from the start

THE BLAIR CAMERA CO., Mfrs.  
22 Randolph St., Boston, Mass.

Send for Illustrated Catalogue which tells everything

# ARTISTIC RESULTS EASILY PRODUCED

On the New Pure Collodion, Non-Curling  
Permanent Matt-Surface Paper . . . . .

# ARISTO- PLATINO

Carbon Effects Easily Produced. May be Toned  
with Gold or Platinum

4 x 5, per dozen, 25 cents; 5 x 8, per dozen, 45 cents

CABINETS=====PER GROSS===== \$2.00

Of glossy papers, the best and cheapest is the pure collodion paper

# ARISTO, JR.

4 x 5, per dozen, 25 cents; 5 x 8, per dozen, 40 cents

CABINETS=====PER GROSS===== \$1.35

OTHER SIZES IN PROPORTION

MANUFACTURED BY

TRADE AGENTS

The American Aristotype Co. E. & H. T. Anthony & Co.  
JAMESTOWN, N. Y. 591 Broadway, NEW YORK

# The Baby Wizard Camera

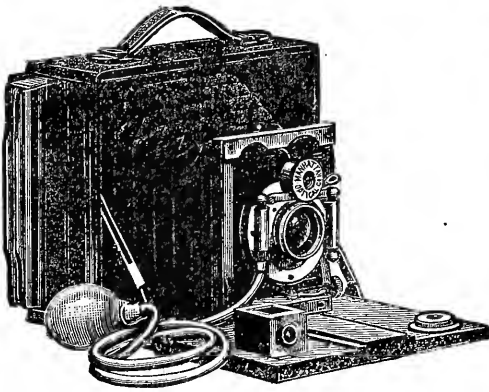

Only 2 $\frac{3}{8}$  x 5 $\frac{5}{8}$  x 6 $\frac{3}{8}$  inches ]

*Is the  
Ideal Camera*

FOR TOURISTS, WHEELMEN  
OR SPORTSMEN GENERALLY

*Fitted with our Extra Rapid Rectilinear Lens (unequaled in this country), and the Bausch and Lomb Optical Company's Iris Diaphragm Shutter.*

Complete with Carrying Case

**\$25.00**

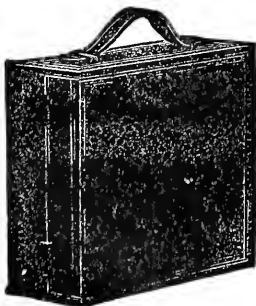

Same without rack and pinion, for focussing, and swing back

**\$20.00**

SEND FOR CATALOGUE

Manhattan Optical Co., Cresskill, N. J.

MILLEN'S  STANDARD  
Photographic Specialties



**THE NORMAL**  
PHOTOGRAPHIC  
DEVELOPER for Dry Plates,  
Films and Bromide Paper

 PRODUCES the most exquisite detail with good strength and printing qualities. Does not stain either the plate or the fingers, and may be used over and over.

 IS IN ONE solution, requiring only to be diluted with water to be ready for use.

 PRICE FORTY CENTS, delivered to any Express Office in the United States.

*Send for full descriptive circulars of our  
Photographic Specialties*

 J. C. MILLEN, M. D.   
Manufacturing Chemist  
Denver, Colo., & Phila., Pa., U.S.A.

#### BOOK NOTICES.

Dr. Gustav Jaeger, the well-known German scientist, has written an excellent book entitled "Problems of Nature." It treats of the origin and development of animal life; of the fundamental laws of the development of the animal body; of the origin of species; of the different kinds of animal cells; of the animal soul; of human vitality; of the source of the vital forces; training and exercising; the doctrine of infection; of constitutional strength; of the treatment of infectious diseases, and of many other subjects of deep interest to the student of zoology and anthropology.

A letter from Charles Darwin, to Dr. Jaeger, is printed on a fly leaf of this book, in which Darwin says: "You have done great service to the principle of evolution, which we both support, by publishing this work."

Dr. Jaeger is well known to the English speaking world through his hygienic discoveries and researches, and is best known to the masses of Americans by his system of sanitary clothing. His book is published by Brentano's, Union Square, New York, and sells at \$1.50.

"Haunts of the Wild Game" is the title of Isaac McLellan's latest book of poems. Every reader of sportsmen's literature knows the power of this venerable poet to portray the denizens, and to sound the music of the woods; and in this volume, he

has fully sustained his world-wide reputation.

Among the titles of the poems in this volume, are "The Angler's Realm," "The Bluefish," "Salmon Fishing in Labrador," "The Trout Brook," "The Sportsman's Greeting," "The Antelope," "The Last Buffalo," "The Great Gray Wolf," "The Hunter's Camp," and "Forest Music."

The book was published at \$1.50, but owing to an unfortunate complication that has arisen, between publisher and printer, it is now being offered, by the latter, at 60 cents, post paid. This protects the author in his royalty, gives the printer the mere cost of printing and binding the book and the book buyer a big bargain. At this low price, thousands of copies should be sold within the next 3 months. I hope every reader of RECREATION will respond to this appeal, and help out the old bard of the forest, beside securing a delightful volume for the fire side and the library.

Address orders to David H. Knott, 188 W. Houston St., New York. Mention RECREATION.

There is a misunderstanding on the part of the public, regarding Colonel Young's order as to the carrying of arms in Yellowstone park, by hunters who are going into the territory South of the park, for big game. The order simply provides that hunting parties going through the park shall carry sealed arms, and that such shall provide themselves with a registered guide. Any guide of good reputation, on registering at Fort Yellowstone, Mammoth Hot Springs, will be authorized by Colonel Young to conduct hunting parties through the park, where their objective point is the territory beyond.

There are some 14 reliable guides who have already registered and who are ready to conduct hunting parties through the park, to the hunting grounds referred to. The order will, therefore, in no manner interfere with hunting parties who may desire to make this trip during the fall months. In fact, Colonel Young says he will furnish small escorts to accompany each party to the South, East or West boundary line, as desired.

Every reader understands that RECREATION's greatest revenue must come from its advertisers. There are a number of gun makers, powder makers, fishing tackle makers and others, who advertise in several other sportsmen's periodicals but discriminate against RECREATION, simply because it is aggressive; because it fights the game hogs and the fish hogs, and thereby reduces their trade. Friends of RECREATION will serve their own best interests by buying goods that are advertised herein.

# WOODBURY'S

FACIAL SOAP, FACIAL CREAM  
FACIAL POWDER  
and DENTAL CREAM

## THE GRANDEST TOILET COMBINATION KNOWN FOR THE SKIN, SCALP, COMPLEXION, and TEETH

*Manufactured by Dermatologist John H. Woodbury, who has had twenty-six years' experience curing skin diseases and facial blemishes. The daily use of Woodbury's Facial Soap and Facial Cream will eradicate all oiliness and other imperfections of the skin, and render the complexion clear, soft, and beautiful. They are sold everywhere.*

**Will Your Face Stand Close Inspection?** Get the hand-mirror. Take a good look at yourself.

**Don't Throw Your Face Away.** No matter if you are tired of it. Don't let it go until you have read Dr. Woodbury's Book or called upon him.

**Dandruff, Warts, Pimples, and Itching of the Scalp** cured.

**Your Ears** are ill-shaped. They stand out too far from the head.

**Your Cheeks** are sunken in. Don't use plumpers, but read the article on Facial Development by John H. Woodbury, Dermatologist.

**Superfluous Hair** permanently removed by the electric needle, never to return again.

**Pretty as You are,** you are not attractive when Pimples and Pustules are on your face.

**Barber's Itch,** a painful and obstinate affliction, is quickly cured. It is better still to prevent it by using Woodbury's Antiseptic Shaving Soap.

**Birthmarks are Removed** by Dermatologist John H. Woodbury, because he takes a particular kind of interest in this kind of work—and, too, because some blockhead has probably said you could not be cured.

**If You Were Caught** in a railroad accident and received a scar or blemish on the face, you would sue for \$5,000 damages. Still you go around with a lot of pimples on your face and imagine yourself contented.

**If You Draw the Flies** about you it is your own fault, for I can remove all bad odors about the body. I do it with Woodbury's Facial Soap. It is the only soap that can be used in salt water.

**A Red Nose is Not** always sign of drink. **Actresses Save** their nice complexion by using Woodbury's Facial Soap in washing off the make-up. All the latest theatrical trunks have a special place built in the side to hold Facial Soap.

**Woodbury's Facial Soap** is considered a "Mascotte" in many of the New York Hospitals. You see, the soap contains a disinfectant, and it is valuable in such places because they will only use the best.

**I can't take the spots off a frog.** Soap was not invented for that purpose, but Woodbury's Facial Soap will make the human skin most beautiful to look upon.

**Physicians [Stand by Woodbury's Facial Soap** because there is nothing quack about it. It took years before Facial Soap was originally perfected and put on public sale.

**Old Discolored "Secretions** pack up and get out quick when Woodbury's Facial Soap marches in upon them. They can't stand Facial Soap. It is one too many for them.



1/8 Regular Size

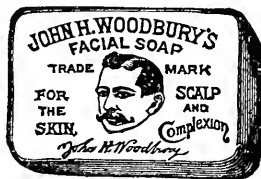

1/8 Regular Size



**Moles and Warts are Stubborn.** They like to live on your skin, just the same as you, for instance, would like to live on ice cream or any favorite dish. Send for 150-page book on Dermatology.

**Freckles Grow Larger** all the time—you, of course, can't see them grow. They grow when you are asleep. Send for a book.

**Gunpowder Marks and Coal Pittings** are erased from the skin without a knife or pain.

**"Beauty is but Skin Deep."** In other words, with a blemished skin there can be no beauty.

**Those Freckles have Killed** every chance you've had lately of getting a man. Men seem to abhor freckles almost as much as they do pimples.

**Your face,** you say, tans easily. Well, Woodbury's Facial Soap was not made to eat; it was made for the purpose of taking away the tan, and lots of other blemishes, too.

**Doctors recommend Woodbury's Facial Soap** for washing infants; and for ladies' all-round use it is matchless.

**Woodbury's Facial Soap** is antiseptic. **As We Never Know** when germs are around, the safe way is to use Woodbury's Facial Soap whenever any washing is done.

**It is hard,** and one cake will outlast two ordinary cakes of soap.

**Woodbury's Facial Soap** is cleansing, healing, and refreshing.

**After a Bath** with Facial Soap nothing is so soothing, softening, healing, and cooling to the skin as an application of Woodbury's Facial Cream.

**Woodbury's Facial Cream** contains no gum, oil, or grease of any kind whatever.

**Woodbury's Facial Cream** will keep fresh and sweet indefinitely.

**Woodbury's Facial Cream** is a blossomscented softener, healer, and beautifier.

**Woodbury's Facial Cream** is unequalled for chaps, chilblains, sunburn, eczema, and all mild cutaneous affections.

**It can be freely used** on the face and will absolutely not cause superfluous growth of hair. For inflamed eyelids, rub in a little Woodbury's Facial Cream. It gives immediate relief.

**The Use of Woodbury's Facial Cream** will not only remove the inflammation, but if rubbed around the eyes, rub out the wrinkles.

To sum it up, **Woodbury's Facial Soap and Facial Cream** make the grandest toilet combination known. **Pure, Antiseptic, Medicinal,** they cleanse, purify, beautify, refresh, and preserve the Skin and Complexion of all humanity from the cradle up.

### DIAMOND PIN GIVEN AWAY

A solid gold scarf pin, set with two genuine diamonds, suitable for lady or gent, will be mailed free to anyone sending us thirty of the outside wrappers of Woodbury's Facial Soap or Facial Cream, or fifteen of each.

**WOODBURY'S DENTAL CREAM** is endorsed by the dental profession, is fragrant, contains no grit to scratch or mar the enamel of the teeth, and is put up in tubes, which makes it convenient to use at home or when traveling. Each tube will last from three to four months, is sold by all druggists and fancy-goods dealers, or mailed on receipt of 25 cents.

**WOODBURY'S FACIAL POWDER** is harmless, contains nothing to irritate the skin, will not cause blackheads, makes the skin transparent and smooth, is recommended by the theatrical profession, and is sold by all dealers in toilet preparations, or sent by mail on receipt of 25 cents.

For 10 cents we will mail you a sample of either Woodbury's Facial Soap or Facial Cream, with 132-page illustrated book on Dermatology and treatment of the skin, also telling how the features are changed. For 20 cents we will send you by mail a trial of Woodbury's Facial Soap, Facial Cream, Facial Powder, and Dental Cream (sufficient for three weeks' use) with illustrated book on Dermatology and the improvement of the complexion

## JOHN H. WOODBURY DERMATOLOGICAL INSTITUTE

*Offices for the Cure of Skin and Nervous Diseases, the removal of Facial Blemishes, and correction of any irregularities of the Ears, Nose, Mouth, and Body.*

NEW YORK, 133 West 42d Street  
BOSTON, 11 Winter Street

PHILADELPHIA, 1306 Walnut Street  
CHICAGO, 163 State Street

ADDRESS ALL CORRESPONDENCE TO 133 WEST 42D STREET, NEW YORK



## S. HEMMENWAY & SON

Make a specialty of  
High Class Yacht and  
Canoe Sails

**SAIL** ❁❁❁  
**MAKERS**

Also Manufacturers of Tents and Flags

60 South Street, New York City

Send 5c. for our Tent and Flag Catalogue

## Kampers' Kommodities

SPECIALTIES

Considerations: Comfort, Convenience, Lightness,  
Including "KAMPERS' KOMFORT" Combination  
Sleeping-Bag and Spring Bed.

Inexpensive  
15 Pounds

**T. PHELPS,**

CIRCULARS

11 Central Street, Boston, Mass.

**FINE MOUNTED GAME HEADS,  
BIRDS, ETC.,** for sale at unheard-of prices.  
Send 10 cents for photos.  
JOHN CLAYTON, Taxidermist, Lincoln, Maine.

We have fine fishing here (mountain and Dolly Varden trout), and, in the line of game, moose, elk, mule deer, white-tail deer, 3 kinds of bear, mountain sheep and goats. Am glad to know the stand you take in regard to the game hogs. Pour it into them, and we will keep you posted from this part of the country.

We have some beautiful lakes, within 7 to 20 miles of here, and all are full of fine trout. The Flathead river runs through the town and thence South into Flathead lake. The river is full of fish and good strings of trout can be taken any day. I have a Bristol steel rod, and took a Dolly Varden with it, the other day, that weighed 9 pounds, 13½ ounces. The little Bristol is all right, and I don't want anything better.

H. H. Gart, Columbia Falls, Montana.

"Them folks from town didn't stay much of a spell, Uncle Reub?"

"Naw; went back mad 'cause we didn't hev no cycle paths an' 'lectric lights in ther blackberry patch."—Chicago Record.

I am a reader of RECREATION and would not be without it for twice its cost.

We have good rabbit, fox and ruffed grouse shooting here, in season; also good deer shooting can be had 4 hours' drive from here. A party of 15 killed 16 deer in 8 days, last fall.

Some of the boys who have been trout fishing, in the mountains, report good catches, and deer plentiful.

There have been some nice catches of pike and bass made, at this point on Lake Champlain, this season; but I am happy to say we are not cursed with the fish or game hog. All your readers are well pleased with the way you treat that kind of cattle.

H. B. V., Port Henry, N. Y.

Mrs. Manhattan—So your cook left you?  
Mrs. Sadone—Yes, and I'm about all she did leave.

A great gun tournament is to take place at Grand Rapids, Minn., on October 29 and 30, 1897, under the auspices of the Itasca Gun Club. The indications are that the attendance will be unusually large. The events of the shoot, rules, prizes to be awarded, and other information, have been printed and a copy will be mailed to any one writing Dr. W. P. Brown, Secretary, Grand Rapids, Minn.

"Billy is in love with Miss Billingham."  
"Did he tell you so?"  
"No, but he's got her picture hung up by the side of the portrait of his best dog."  
—Chicago Record.

Deer are unusually plentiful, this year, in Northern Minnesota, along the Mississippi river. The country is accessible via the Northern Pacific R. R. to Aitkin, Minn. From points South of St. Paul the C. B. & Q. R. R. is the best and most convenient route, landing passengers in the Union Depot at St. Paul, and avoiding the necessity of transfer of baggage.

A. L. H., Brainerd, Minn.

Have just come in from a fishing trip, in the Adirondacks. There were 3 in our party, and we were in camp a week. Total catch for 3 rods, 113 trout—just what we needed for food. No large ones—½ pound being the best. We could have caught hundreds, but are not of that breed.

C. H. Melins, Gloversville, N. Y.

I caught 7 bears last spring. The 8th got out of the trap. First one we ever lost, since we got those big traps. Was no fault of the trap. The burr should have been riveted on, but it was overlooked. Traps weigh 5 to 9 pounds each.

Wm. Dicer, Albion, Calhoun Co., Mich.

RECREATION continues to increase in attractiveness and interest. I could not get along without it.

Jas. S. McCain, Washington, N. J.

# Cruisings in the Cascades

A NARRATIVE OF

## TRAVEL, EXPLORATION, AMATEUR PHOTOGRAPHY, HUNTING, AND FISHING

WITH SPECIAL CHAPTERS ON HUNTING THE

**Grizzly Bear, the Buffalo, Elk, Antelope, Rocky Mountain Goat, and Deer; also on  
Trouting in the Rocky Mountains; on a Cattle Roundup;  
Life Among the Cowboys, Etc.**

BY G. O. SHIELDS ("COQUINA")

AUTHOR OF "RUSTLINGS IN THE ROCKIES," "HUNTING IN THE GREAT WEST," "THE BATTLE OF THE  
BIG HOLE," ETC.

12mo. 300 Pages. 75 Illustrations. Cloth, \$2.00; Half Calf, \$3.00.

The learned writer, scientist, and sportsman, Col. W. D. Pickett, better known as "P.," says of this book: "The true lover of nature who delights to occasionally escape from the annoyances and worriments inseparable from so-called civilized life, and to wander amid scenes that tell only of the infinite power, the beneficence, and the grandeur of the Great Ruler; who delights to worship in the grandest of all His temples—the mountains; who realizes and feels His presence on every mountain peak, in every dark canyon, in every rushing wind, in every gentle zephyr, and who, amid such scenes, above all realizes his own weakness and littleness; he it is who will take pleasure in following the author amid some of the grandest and most beautiful scenery on this continent. If, added to this, the reader should be imbued with some of the tastes and sympathies of the sportsman, additional zest will be given in the pleasant, graphic, and truthful descriptions of fishing and hunting incidents. The young sportsman who is desirous of hunting large game, will find here many indispensable hints as to their habits and the best methods of pursuing them. This book will meet with universal favor."

Mr. T. S. Van Dyke, author of "The Still Hunter," and other popular books, says: "It is one of the most entertaining books on field sports yet published. Mr. Shields always has something to say, and says it in a way that makes one see it. He is never dull, and there is an air of truth about his work that fully satisfies the reader."

Mr. Orin Belknap, known and loved of all sportsmen by his familiar pseudonym "Uncle Fuller," says: "The author of this work has placed the sportsmen of America under lasting obligations by his pleasing descriptions of his adventures in the wilds of these little-known mountains. Any writer who calls the attention of American sportsmen to the wonderful opportunities for legitimate sport—worth a trip across the continent, or a life-time of the tame enjoyment of Eastern sportsmanship—hidden away in the mysterious gorges of the Cascade range, deserves the thanks of each and all who ever shouldered gun or rod. May this book prompt others of America's adventurous lovers of the wilderness to more thorough search for the hidden wonders of these mighty hills."

"Boone," the writer of so many charming reminiscences of days among the hills, says of this book: "To the reader whose calling in life, or whose personal limitations shut him off from the privileges enjoyed by Mr. Shields, there is given in these pages descriptions of scenery so vivid as to enable him to realize the grandeur in nature of the land that gives us birth. There are given him descriptions and traits of animals, in their wild state and in their native haunts, that he may never see save in collections. Let me commend it to all into whose hands this book may come—and they ought to be many—to give it a *careful*, not a cursory reading. On second, and attentive reading, I was really struck by the accuracy of the author's descriptions of the bison, elk, antelope, grizzly bear, and mountain goat; and the delineations from his camera make the whole work graphic indeed."

"Sillalicum," another well-known and popular contributor to the sportsmen's journals, has this to say: "Mr. Shields evidently saw everything that could interest the sportsman, farmer, lumberman, or tourist; and has described the country and its objects of interest in an effective and truthful way, with the eloquence of the artist, and the enthusiasm of the sportsman. No book ever published on Western sports is so delightfully written. A perusal of its pages places the reader among the scenes described, and he imagines himself looking at the rushing schools of salmon; he hears the murmuring of the mountain stream; the whispering of the alpine zephyr; and can almost catch the gleam of the mountain lake as it washes the foot of the cragged peak on which roams the white goat."

Says W. B. Leffingwell, the gifted author of "Wild Fowl Shooting," and of "Shooting on Upland, Field, and Marsh": "I have rarely encountered, anywhere, such vivid descriptions of life in the mountains, as are found in 'Cruisings in the Cascades.' My blood tingles as I follow the author, through these pages, in his encounters with the noble game he found in the great hills; and I long to lay aside the cares of business and seek those mighty fastnesses wherein he had such grand sport."

"Men who enjoy jaunts into the woods, in search of big game, will find this book extremely interesting."—*New York Herald*.

"'Cruisings in the Cascades' is by far the best thing Coquina has ever written."  
—*American Field*.

"It is a handsomely printed and finely illustrated volume, made up of spirited sketches of travels, explorations, hunting, and fishing. It is charmingly interesting. The author mingles solid facts of great value with accounts of his wild adventures, and tells the story in an offhand style that banishes sleep from tired eyes."—*Chicago Inter-Ocean*.

"Mr. Shields handles a much diversified group of subjects with a master hand, and adheres throughout to a singularly pleasant and original way of expressing himself. His chapter on 'Trouting in the Rocky Mountains' is as delicious a bit of word-painting as we have ever met with."—*Sports Afield*.

"'Cruising in the Cascades' is Mr. Shields' latest, and, we think, best publication. It will be heartily appreciated by American sportsmen. One of the most important chapters in the book is that on the Rocky Mountain goat. Heretofore little has been written on that animal, and Mr. Shields has treated the subject in a thorough and careful manner. He has recorded much valuable matter, with regard to this animal, which can be referred to by naturalists and sportsmen with profit. Many of the illustrations in the book are from photographs taken by the author, and are unusually good."—*Shooting and Fishing*.

"Coquina is widely and favorably known as an entertaining, practical writer on outdoor sports, and 'Cruisings in the Cascades' will add to a well-earned fame in his special field. His pen-pictures of wild life and wild sports, in the Far West, are accompanied by many excellent illustrations of fish and game, and of the scenes and places visited, adding greatly to the attractive character of the work."—*The Independent*.

"The pages are breezy and the illustrations numerous and attractive, the camera having been freely used by the author in his travels."—*The Bookbuyer*.

"Mr. Shields touches on numerous subjects. Nothing seems to escape his keen eye, and whatever he describes becomes vivid to the mind of the reader, full of interest and clearly defined. His pen-pictures of hunting adventures, boating, and the sports of the ranch, tingle with the warm glow of quickened pulse-beats and rapidly coursing blood."  
—*Book Chat*.

"The author's style of writing would make even a dull subject enjoyable, but with such a theme—his own extended and rich experience—we have a book whose wide circulation seems assured. There are enchanting sketches of scenery, pleasing stories of mountain climbing, of hunting and fishing; excellent estimates and delineations of Indian character, drawn from personal contact; a fine description of salmon and their habits, and such accounts of bear, elk, deer, and goat hunting as to make the blood of the hunter tingle in every vein."—*Public Opinion*.

"Mr. Shields is not only a hunter, but an angler, and an amateur photographer, and on his excursions in the mountains has made good use of his opportunities. As a narrative of adventure the book is entertaining, and as a record of sport it will delight many readers."—*The Literary World*.

"It is sure to meet with a large sale."—*Chicago Tribune*.

"It is by all odds the most fascinating book on big game hunting ever published."  
—*The Journalist*.

"The illustrations are, for the most part, made from photographs, and are one of the chief charms of the book. Those who have read 'Rustlings in the Rockies,' by the same author, are familiar with the charm of his style."—*Photographic Times*.

"It is beautifully printed and profusely illustrated, detailing a great variety of adventure in travel, exploration, hunting, and fishing. Mr. Shields is an enthusiastic lover of nature, in all her wilder forms, with an eye quick to see the beauty and grandeur of river and plain, and forest and mountain, and a ready pen to describe them. He is a keen and tireless sportsman, a quick and accurate judge of men, with that curious quality of humor that enables a man to see and enjoy the oddities, even in perilous passages, all grounded on the restless spirit of the born rover. To the great majority of men, for whom wild adventure possesses an irresistible fascination, this book is full of the most absorbing interest."—*Chicago Times*.

Mailed, post-paid, on receipt of price, by the Author,

G. O. SHIELDS, 19 West 24th Street, New York,

Or given as a Premium for 5 Subscriptions to Recreation

# THE AMERICAN BOOK OF THE DOG

THE ORIGIN, DEVELOPMENT, SPECIAL CHARACTERISTICS,  
UTILITY, BREEDING, TRAINING, DISEASES, AND KENNEL  
MANAGEMENT OF ALL IMPORTANT BREEDS OF DOGS

*A Book for Dog Fanciers and Dog Owners*

EDITED BY G. O. SHIELDS ("COQUINA")

AUTHOR OF "CRUISING IN THE CASCADES," "RUSTLINGS IN THE ROCKIES," "HUNTING IN THE GREAT WEST," "THE BATTLE OF THE BIG HOLE," "THE BIG GAME OF NORTH AMERICA," "CAMPING AND CAMP OUTFITS," ETC.

8vo, 700 Pages, 85 Illustrations. Cloth, \$5.00; Half Morocco, gilt top, \$6.50; Full Morocco, gilt edges, \$8.00

## CONTENTS

- |                                                                                                                                          |                                                                                                                                       |
|------------------------------------------------------------------------------------------------------------------------------------------|---------------------------------------------------------------------------------------------------------------------------------------|
| The English Setter. Bernard Waters, Kennel Editor                                                                                        | The Yorkshire Terrier. P. H. Coombs.                                                                                                  |
| The American Field, and author of "Modern Training, Handling, and Kennel Management."                                                    | The Chesapeake Bay Dog. George W. Kierstead.                                                                                          |
| The Irish Setter. Max Wenzel, Secretary The Irish Setter Club of America, and B. F. Seitner, Vice-President The Pointer Club of America. | The Bedlington Terrier. W. H. Russell.                                                                                                |
| The Gordon Setter. Harry Malcolm, President The American Gordon Setter Club.                                                             | The Irish Terrier. Dr. J. S. Niven.                                                                                                   |
| The Pointer. Charles K. Westbrook, A. M.                                                                                                 | The Bull Terrier. Frank F. Dole.                                                                                                      |
| The Greyhound. Col. Roger D. Williams, President The Iroquois Hunting and Riding Club.                                                   | The White English Terrier. E. F. Burns.                                                                                               |
| The Deerhound. Dr. O. Van Hummell.                                                                                                       | The Airedale Terrier. F. H. F. Mercer.                                                                                                |
| The Foxhound. Dr. M. G. Ellzey, Associate Editor The National Economist.                                                                 | The Scottish Terrier. John H. Naylor.                                                                                                 |
| The Bassethound. Lawrence Timpson.                                                                                                       | The Dandie Dinmont Terrier. John H. Naylor.                                                                                           |
| The Dachshund. William Loeffler.                                                                                                         | The Skye Terrier. Lawrence Timpson.                                                                                                   |
| The Bloodhound. J. L. Winchell.                                                                                                          | The Black and Tan Terrier. Dr. H. T. Foote.                                                                                           |
| The Russian Wolfhound. William Wade.                                                                                                     | The Maltese Terrier. Miss A. H. Whitney.                                                                                              |
| The Beagle. H. F. Schellhass, President The American-English Beagle Club.                                                                | The Collie. Henry Jarrett and J. E. Dougherty.                                                                                        |
| The Irish Water Spaniel. P. T. Madison, Secretary The Indiana Kennel Club.                                                               | The Old English Sheep Dog. William Wade.                                                                                              |
| The English Water Spaniel. William A. Bruette.                                                                                           | The Great Dane (German Dogge). Prof. J. H. H. Maenner.                                                                                |
| The Clumber Spaniel. F. H. F. Mercer, Kennel Editor Sports Afield.                                                                       | The St. Bernard. F. E. Lamb.                                                                                                          |
| The Sussex Spaniel. A. Clinton Wilmerding, President The American Spaniel Club.                                                          | The Mastiff. William Wade.                                                                                                            |
| The Field Spaniel. J. F. Kirk.                                                                                                           | The Newfoundland. L. F. Whitman.                                                                                                      |
| The Cocker Spaniel. J. Otis Fellows.                                                                                                     | The Bulldog. John E. Thayer.                                                                                                          |
| The Fox Terrier. August Belmont, Jr., President The American Kennel Club, and The American Fox Terrier Club.                             | The Dalmatian Coach Dog. Maj. T. J. Woodcock.                                                                                         |
|                                                                                                                                          | The Poodle. W. R. Furness.                                                                                                            |
|                                                                                                                                          | The Italian Greyhound. Dr. G. Irwin Royce.                                                                                            |
|                                                                                                                                          | The Pug. G. W. Fisher.                                                                                                                |
|                                                                                                                                          | The Mexican Hairless Dog. Mrs. Elroy Foote.                                                                                           |
|                                                                                                                                          | The Toy Spaniels. Miss Marion E. Bannister, Secretary The New York Pet Dog Club.                                                      |
|                                                                                                                                          | The Schipperke. E. R. Spalding.                                                                                                       |
|                                                                                                                                          | Diseases of the Dog, and their Remedies. Dr. J. Frank Perry ("Ashmont"), author of "Dogs; Their Management and Treatment in Disease." |
|                                                                                                                                          | Spaniel Training. F. H. F. Mercer.                                                                                                    |

The Hon. John S. Wise, the eminent statesman and lawyer, President of the Pointer Club of America, and one of the most distinguished sportsmen and dog fanciers in the country, says of this book:

"In selecting contributors to this work Mr. Shields has displayed rare good judgment. His list of writers embraces the names of many gentlemen who are recognized as leading authorities on the subjects of which they write. While those articles may, in some cases, be more or less tinged by the peculiar views of their authors, the book, thus drawn from many different minds, is not only very eclectic in character, but, in my judgment, much more correct and valuable, as a whole, than it could be were it the production of an individual.

"The book is exceedingly interesting. It is free, too, from the sameness of expression and treatment so often found in books of this character, written by one man. It is, moreover, a very instructive book, and of practical value, in many features, to the owners and breeders of dogs.

"A valuable feature of this book is the illustrations. Many of these are artistic and beautiful in a high degree. The portraits of several dogs of world wide reputation are shown, and those of many other typical specimens, less widely known, add to the interest and attractiveness of the work. Nearly every breed is illustrated, and of some breeds several good specimens are pictured."

This book will be mailed, post-paid, on receipt of price, by

G. O. SHIELDS, 19 West 24th Street, New York

Or given as a Premium for 7 Subscriptions to Recreation

# The Big Game

## OF North America

ITS HABITS, HABITAT, HAUNTS, AND CHARACTERISTICS  
HOW, WHEN, AND WHERE TO HUNT IT

### A Book for the Sportsman and the Naturalist

EDITED BY

G. O. SHIELDS ("COQUINA")

AUTHOR OF "CRUISING IN THE CASCADES," "RUSTLINGS IN THE ROCKIES," "HUNTING IN THE GREAT WEST," "THE BATTLE OF THE BIG HOLE," "CAMPING AND CAMP OUTFITS," ETC.

8vo, 600 Pages, 80 Illustrations.

Cloth, \$3.50; Half Calf, \$5.00; Full Morocco, \$6.50.

#### CONTENTS

|                                                                                                                          |                                                                     |
|--------------------------------------------------------------------------------------------------------------------------|---------------------------------------------------------------------|
| Introduction. By the Honorable John Dean Caton, author of "The Antelope and Deer of America," etc.                       | The Musk Ox. Sergt. H. Bierdebick, of the Greely Arctic Expedition. |
| Moose Hunting in the Rocky Mountains. Newton Hibbs ("Roxey Newton").                                                     | Still-hunting the Antelope. Arthur W. du Bray ("Gaucho").           |
| Elk Hunting in the Olympic Mountains. W. A. Perry ("Sillalicum").                                                        | Coursing the Antelope. M. E. Allison.                               |
| The Wapiti (Poem). By "Wah-bah-mi-mi."                                                                                   | The Death of Venus (Poem). Wm. P. Lett.                             |
| The Caribou. By William P. Lett ("Algonquin") and Dr. R. B. Cantrell.                                                    | The Rocky Mountain Goat. John Fannin.                               |
| The Mule Deer. Rev. Joshua Cooke ("Boone").                                                                              | The Rocky Mountain Sheep. G. O. Shields ("Coquina").                |
| The Mule Deer of Southern California. T. S. Van Dyke, author of "The Still Hunter," etc.                                 | The Peccary. A. G. Requa.                                           |
| The Columbia Black-tail Deer. Thomas G. Farrell.                                                                         | The Cougar, or Mountain Lion. W. A. Perry ("Sillalicum").           |
| The Virginia Deer. Walter M. Wolfe ("Shoshone").                                                                         | The Lynx. J. C. Nattrass.                                           |
| A Deer Hunt (Poem). "Wah-bah-mi-mi."                                                                                     | The Wild Cat. Daniel Arrowsmith ("Sangamon").                       |
| Hunting the Grizzly Bear. Rev. Dr. W. S. Rainsford.                                                                      | The Wolf. Wm. P. Lett.                                              |
| The Polar Bear. Sergt. Francis Long, of the Greely Arctic Expedition, and George S. McTavish, of the Hudson Bay Company. | The Wolverine. C. A. Cooper ("Sibyllene").                          |
| A Polar Bear Hunt.                                                                                                       | Coon Hunting in Southern Illinois. Daniel Arrowsmith ("Sangamon").  |
| The Black Bear. Col. Geo. D. Alexander.                                                                                  | Fox Hunting in Virginia. Dr. M. G. Ellzey.                          |
| The Buffalo. Orin Belknap ("Uncle Fuller").                                                                              | Alligator Shooting in Florida. Cyrus W. Butler.                     |
|                                                                                                                          | The Ethics of Field Sports. Wm. B. Leffingwell.                     |

The Hon. John Dean Caton, the eminent naturalist and jurist, author of "The Antelope and Deer of America," etc., says of this work:

"Altogether, there is given here such a study of the natural history of our game quadrupeds, and of the thrilling incidents encountered in hunting them, as has never before been offered to the reading world. Each chapter in this book is in itself a complete work, and the book, as a whole, is a most valuable library.

"Any one of the names on Mr. Shields' list of contributors should insure the sale of an entire edition of his book, and when we multiply this possibility by twenty-six, the whole number of names on his title-page, the result obtained indicates the magnitude of the success that should, and that we hope will, crown his labors and those of his collaborateurs."

"This sumptuous volume, profusely and elegantly illustrated, written by a score or more of sportsmen, is a very captivating book. No single writer could have had all the experiences here narrated. The descriptions and incidents cover every variety of large game on the continent. \* \* \* \* \* The stories are as excellent in their variety as in their quality. There are no dull chapters in the book. In fact, it may be said it is the finest collection of hunting stories ever published."—*Chicago Inter-Ocean*.

"This is one of the best and most valuable of the books as yet written or edited by Mr. Shields. It comprises a collection of intelligently written monographs on all the various kinds of big game to be found in North America, from the grizzly to the polar bear, and from the Virginia deer to the Rocky Mountain goat. Each writer speaks from his own experience, tells what he has done and seen, and recounts the often thrilling incidents he has met with in hunting. All the contributors to the volume are well-known writers on field sports and hunting, and each one writes of a species of game he has studied for years in the field, on the mountain, or in the forest."

"The paper on the Rocky Mountain sheep is by the Editor, and is a fine account of the wildest, wariest, and most difficult animal to hunt on the continent. Mr. Shields is a most enthusiastic sportsman, and moreover, wields the pen of a ready writer, as indeed all these sportsmen do, so that one follows him in his adventures with almost breathless interest.

"From beginning to end and in every chapter this book is positively fascinating."—*Chicago Herald*.

*This book will be mailed, post-paid, on receipt of price by the editor.*

G. O. SHIELDS, 19 West 24th Street, New York

Also given as a Premium for 7 Subscriptions to Recreation

# THE GREAT WESTERN BRAND OF CHAMPAGNE

MADE  
BY  
THE  
Pleasant  
Valley  
Wine  
Co.

OF  
RHEIMS, N. Y.



IS  
THE FINEST  
PRODUCTION

IN AMERICA  
AND EQUAL TO ANY

**THERE IS HEALTH IN EVERY DROP**

FOR SALE BY ALL WINE MERCHANTS, AND  
H. B. KIRK & CO., New York S. S. PIERCE & CO., Boston

## AS TO GUIDES.

Eastern sportsmen will soon begin to flock to the hunting-grounds of the West. The open season commences, in this State, September 1st, lasting 3 months. Males only of the game animals may be killed, and then only in such quantities as will supply the hunter with food. Non-residents are required to pay a \$20 license fee. These are the main points of the law.

The game wardens of this locality are courteous, and never persist in forcing themselves on hunting parties; and never make arrests without good cause. They generally allow hunters the privilege of taking care of the trophies of the chase, providing they otherwise comply with the law.

To kill game one must employ a competent guide. I would advise hunters to employ guides who live in the game country. Employ those who protect the game and keep it for those who give compensation to kill it. The people of a game country are, as a rule, extremely jealous of non-resident guides. They say a person who has no interest in the game, other than a mercenary one, will have no interest in its protection. Consequently the game wardens insist on non-resident guides obeying strictly, the letter of the law. If I were hunting in Idaho, I would employ Idaho guides; if in Montana, Montana guides; and if in Wyoming, then Wyoming guides. To do otherwise would, in my opinion, be a waste of money and a loss of pleasure.

The season of 1896-7 was a hard one for the game in Wyoming. Many thousand elk died in Jackson's Hole. Yet this great loss did not exceed the increase.

Many new wardens have been appointed, and I have no doubt they will do themselves justice, as well as those with whom they come in contact. Sportsmen will find them honorable men, who will insist only on the proper enforcement of the law.

The Secretary of the Interior has notified

all Indian agents to keep the Indians on their reservations, and not to permit them to go on to the game ranges. This will have a material effect on the game. The State authorities, too, are a unit for game protection. O. E. S., Jackson, Wyo.

Game in this part of the country consists of quails, ruffed grouse, grey squirrels, rabbits, and a few woodcock. We also get a chance at ducks, in fall and spring. Trout fishing is not good. There is an old trout brook, a short distance from my home, that is fished out, but I get 1 or 2 good ones out of it, every year. Caught 2 out of it this year. The first one measured 13 inches and the 2d 14 inches. I have a hole dug, near a stream, which contains about 500 small trout, which I intend to let go when they get big enough, and put them in certain waters, in hopes they may do something later.

I am a small bore crank, and use a 22 calibre rifle which I like very much. I can now hit a tin can, thrown in the air, at a distance of 100 feet away, 45 times out of 50. Can cut a string at 30 feet, and at 100 yards can kill small game, such as rabbits and woodchucks.

Geo. B. Hodges, W. Mansfield, Mass.

All of your subscribers here are highly pleased with RECREATION. They can't well help being pleased with it. I have just gotten back from the Indian Territory, where I went hunting. Carried my Forehand gun, which I got from you for 35 subscribers to RECREATION, and it is hard to beat. The squirrels can't get too high up in the trees for it to knock them out; and it shoots buck shot just as well. I shot at a knot on a tree, which was about 2 feet through, and the knot 6 inches across. Put seven No. 8 buck shot, out of 15, in the tree, and one in the knot. Distance 55 yards.

Chas. C. Beck, Paris, Texas.

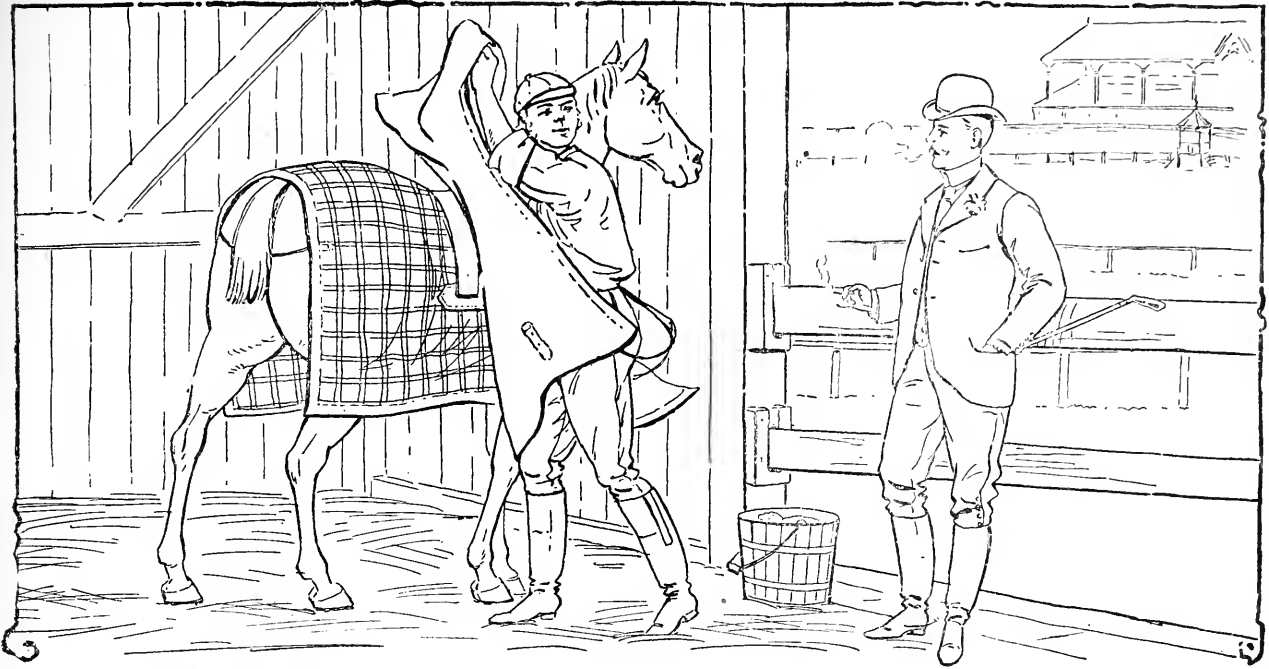

**A Gentleman** returning from riding noticed his groom putting two blankets on his horse, and asked—

**Why do you** put that second blanket on the horse this hot weather? The man replied, to prevent him from taking cold. The outer blanket absorbs the moisture, leaving the under blanket perfectly dry.

**The Harderfold Underwear** does for the man what the two blankets do for the horse,—it is two-fold, and the only sanitary underwear manufactured.

Over eleven hundred physicians, representing every State and Territory in the Union, have united in testifying to the sanitary excellence of the HARDERFOLD system of underclothing. Two or more thin fabrics are lighter, warmer and in every way better than heavy single fabrics.

For illustrated catalogue, address,

**HARDERFOLD FABRIC CO., TROY, N. Y.**

I noticed in July RECREATION, an article entitled "A Fish Duck," in which Mr. Robert Ridgeway, Curator of Ornithology in the National Museum says: "The merganser is not good to eat." If not I would like to ask why not. While in camp, during duck season we often eat mergansers, and if Mr. Ridgeway will boil a merganser, in 2 waters, with onion chopped in them, until the meat starts to leave the bones and then fry the bird, he will not hesitate to eat it. If he did not know he could not tell the difference between merganser and blue bill.

J. H. D., Hammond, N. Y.

There is a law here protecting quails till 1900 and they are increasing, fast. It is pleasant to hear them whistle and see them, with their little ones, running over our gardens. Prairie chickens are here in good numbers this year.

I think the man who shot 300 squirrels got more than his share, the word pig might be applied to him, at least.

RECREATION comes regularly and I am always glad to get it. It is better every month.

Hoffman Livingston, Gallatin, Kans.

RECREATION came yesterday, and is better than ever. I sat up almost all of last night and read it through, advertisements and all. Would like to hear, from other readers of RECREATION, about yachts and yachting cruises, on a small scale. I am delighted to see RECREATION ripping the game hogs up the back. Florida is full of them, in winter. They shoot hundreds of blue bills, and don't even pick them up.

James K. Clarke, Pittsburg, Pa.

When my year is up please let me know. I do not want to be without RECREATION.

On page 88, of August number, you have a picture showing a big pile of fish that were caught by Harry Yates. You say every reader of RECREATION knows his other name. I do. It is Mr. D—d Hog. Am I not right?

John O. Law, Cleveland, O.

Please send me the names and addresses of all your friends who are sportsmen, in order that I may send them sample copies of RECREATION.

# Where to Go!

**THE Best Game Country** in the Mississippi Valley to-day is along the line of the

**FOR GOOD SHOOTING AND FISHING**

## Iron Mountain Route

IN MISSOURI  
ARKANSAS  
AND  
LOUISIANA

**Small Game** is very abundant, and has been shot at very little. **Deer** and **Turkeys** are plentiful, and the fishing, for black bass and other game fishes, of the very best. **This Line** also reaches, direct from **St. Louis** or **Memphis**, by double daily through car service, the famous hunting and fishing grounds on the Gulf.

### SPECIAL FEATURES OFFERED

**Reduced Rates to Sportsmen**      **Side Tracking Cars On or Near the Grounds**  
**Hunting Cars Fully Equipped**      **Carrying Free of Dogs, Guns, and Camp Equipment**

WRITE for copy of **Ideal Hunting and Fishing Pamphlet** (descriptive and illustrated) of best locations, and other information, to Company's Agents, or to

C. G. WARNER  
Vice-President

W. B. DODDRIDGE  
General Manager

H. C. TOWNSEND  
General Passenger and Ticket Agent

ST. LOUIS

## Some Rare Opportunities

...YOU CAN GET...

A \$75 Bicycle for 75 yearly subscriptions to *Recreation*.

A \$35 Hammerless Breech-Loading Shot Gun for 35 yearly subscriptions.

A \$40 Camera for 25 subscriptions.

A \$20 Gold Watch for 20 subscriptions.

A \$20 Repeating Rifle for 20 subscriptions.

A Good Single Barrel Shot Gun for 15 subscriptions.

A Single Shot Rifle, or

A Bristol Steel Fishing Rod, or

An Automatic Reel, or

A Kenwood Sleeping Bag  
For 10 subscriptions.

**WHY DON'T YOU GET THEM?**

Write for premium list and sample copies of *RECREATION*

## THE... ADIRONDACK... MOUNTAINS

Called in  
Old Times

"THE GREAT NORTH WOODS."

A marvelous wilderness, abounding in beautiful lakes, rivers and brooks, filled with the greatest variety of fish.

An immense extent of primeval forest, where game of all kinds is to be found.

This wonderful region—located in Northern New York—is reached from Chicago by all lines, in connection with the New York Central; from St. Louis by all lines in connection with the New York Central; from Cincinnati by all lines in connection with the New York Central; from Montreal by the New York Central; from Boston by a through car over the Boston & Albany, in connection with the New York Central; from New York by the through car lines of the New York Central; from Buffalo and Niagara Falls by the New York Central.

A 32-page folder and map entitled "The Adirondack Mountains and How to Reach Them" sent free, post-paid, to any address, on receipt of a 1-cent stamp by George H. Daniels, General Passenger Agent, New York Central & Hudson River Railroad, Grand Central Station, New York.



## CHARLES SCRIBNER'S SONS

"This is, we think, the best book ever written on practical taxidermy."  
—NEW YORK INDEPENDENT.

"A handsome, valuable, and richly illustrated volume."  
—BROOKLYN EAGLE.

# Taxidermy and Zoological Collecting

A complete hand-book for the Amateur Taxidermist,  
Collector, Osteologist, Sportsman, and Traveler

By WILLIAM T. HORNADAY

For eight years Chief Taxidermist of the U. S. National Museum; for seven years Zoological Collector and Taxidermist for Ward's Natural Science Establishment; now Director of the New York Zoological Park.

With Chapters on Collecting  
and Preserving Insects

By W. J. HOLLAND, Ph.D., D.D., Etc.

Illustrated by CHARLES B. HUDSON, and other artists

24 Plates, 104 Text Illustrations. One vol., large 8vo, pp. 362. Price, \$2.50 net

SCOPE OF THE BOOK: Part I, Collecting and Preserving; Part II, Taxidermy; Part III, Making Plaster Casts; Part IV, Cleaning and Mounting Skeletons; Part V, Collecting and Preserving Insects; Part VI, General Information (Insect pests, poisoning, best books of reference, etc.).

## FIFTH EDITION

" 'Taxidermy and Zoological Collecting' is the best book in the world on Taxidermy."  
—RECREATION.

"There is no other book of equal scope available."—*Science*.

"It is a work to which the student of the art of taxidermy can always turn for advice in any difficulty, and information on every possible point connected with his work. . . . No trace of 'padding' appears."—*Journal of Education*.

"It is by all odds the best work which we have ever seen on the subject, and deserves a wide circulation."—*Forest and Stream*.

"This is the finest work of the kind ever laid before us for review."—*Sports Afield*.

### FROM THE LEADING AMERICAN JOURNAL OF ORNITHOLOGY

"In placing before the public, in the form of a 'manual,' the results of his long experience, both in the field and in the workshop, he has conferred a boon, not alone upon collectors and taxidermists, but upon zoological science in general. No work, it is safe to say, in any sense comparable with this, has ever been written; and the impulse it must give to intelligent field work and scientific taxidermy is almost beyond estimate. . . . Beyond question, Mr. Hornaday's book marks the beginning of a new era in the history of both natural history, field work and taxidermy, and naturalists cannot be too grateful for his admirable manual of 'Taxidermy and Zoological Collecting.'"

—DR. J. A. ALLEN, in *The Auk*.

CHARLES SCRIBNER'S SONS, 153 Fifth Avenue

**The Hermitage:** Is on the bank of Henry's Lake, at the foot of the Grand Tetons. Fine trout fishing in the lake and adjacent streams. Elk, moose, deer, bear, mountain sheep, goats, and antelope are found in the neighboring hills. Superb scenery, fine climate, good, comfortable boats, and plenty of substantial food, well cooked. What more could a sportsman want? Address

BURTON HARRIS, Jackson, Wyo.

**Jas. L. McLaughlin:**—Experienced Guide. Best references furnished. Elk, moose, deer, mountain sheep, antelope, lions, bear, sage hens and grouse. Best trout fishing in the country, within 10 minutes' walk of my ranch. Would take a few boarders. Tourist outfits furnished on short notice. Address,

Ishawood, Big Horn Co., Wyoming.

#### ANY PARTY

wanting to see the  
**National Park,**  
or to hunt in the  
Teton or Jackson's Hole countries,  
should write me.

These are the best big game ranges in the United States. Moose, elk, deer, bear, mountain sheep, mountain lions, and all kinds of small game abundant; also the best of trout fishing in the West.

Have put in 16 years hunting, trapping, and guiding in Wyoming, Idaho, and Montana, and know where to go for any kind of game you want. Write me and I will give you full particulars.

GEORGE WINEGAR, St. Anthony, Fremont Co., Idaho

#### GEO. CORNELL, Mt. Upton, N. Y.

Offers his services as Guide for Visiting Sportsmen. The best ruffed grouse, squirrel and woodcock shooting in the State.

Terms reasonable. All inquiries promptly answered. Good reference given.

**To Sportsmen and Tourists:** I am located in Northwestern Colorado, in a paradise for sportsmen. Large game abundant and trout fishing unexcelled. Gentle saddle horses, pack outfits, etc. Everything first class. Correspondence solicited.

J. M. Campbell, Hunter and Guide,  
Buford, Colorado.

#### The Brahan Patent Pen

One dipping writes a large page. Fine quality steel pen, with reservoir. Samples: 5 kinds, 10c. Agents wanted.

BOWEN & SON, Springfield, Mass.

**For Sale:** A very fine specimen of a bull buffalo head. For particulars, measurements and photo. apply to R. F. SLAGHT,  
660 West Delevan Ave., Buffalo, N. Y.

**L. L. Bales,** Sitka, Alaska, offers his services as guide for hunting, exploring, and prospecting parties. He has lived in Alaska 8 years, has travelled many thousands of miles through the interior, and is prepared to give accurate and reliable information concerning it.

References: Lieut. G. T. Emmons, U. S. Navy, Naval Dept., Washington, D.C.; Will D. Jenkins, Secretary of State, Olympia, Wash., and the editor of RECREATION.

Correspondence promptly answered, on my return from each trip into the interior.

**WANTED**—To exchange a new 30 calibre Savage rifle for a 3 barrel gun. Address J. F. P., care RECREATION.

**To Sportsmen:** The Big Horn, Shoshone, Teton mountains, Jackson's lake and the country to the East and South of the Yellowstone National Park is the best region in the United States for "big game," such as elk, deer, bear, antelope and mountain sheep, and nowhere in the world is found such trout fishing as in the streams of this section.

The country is easily accessible with a pack outfit. We are thoroughly familiar with it and will guide sportsmen to any part, including the Yellowstone National Park.

Our outfits of saddle and pack horses, camp equipage, etc., is of the best, and complete in every particular.

VanBuskirk & Whitaker,  
Gardner, Mont.

**For Sale or Exchange:** Osgood folding canvas boat; used but little; complete with oars, paddles, etc.; 12 feet long; in first-class condition; weighs, complete, only 50 pounds; canoe style 25 pounds.

Exchange for rifle of medium or large calibre, or best cash offer takes it. Reason for selling: too many boats.

C. J. Halpen,  
Secretary M. & M. Association,  
Haverhill, Mass.

#### Pheasants, Call Ducks, Etc.

**Prices Reduced.** Golden, Silver, Reeves, Versicolor, Lady Amherst, Swinhoe, Peacock, and Ringneck Pheasants; also White Call, Mandarin and Wood Ducks for sale.

**JAMES MORRISON**

Mr. Schieffelin's Place, Tarrytown, N. Y.

**Adirondack Lands**

**FOR SALE** in Various  
Parts of that Region; Suitable  
for Grand Parks, Game  
Preserves, Cottage Sites. Forest Land Co., Syracuse, N. Y.

Cycle Touring in England at small expense. All about it, for 25c.

Arthur Munson, Stamford, Ct.

**LITTLE GIANT TYPEWRITER** Price \$1.00  
 INTERCHANGEABLE TYPE PLATES.  
 WILL WRITE IN BOOK, ON PAPER PACKAGE, ANYTHING.  
 ADJUSTABLE FEED.  
 WILL WRITE OF THE SIDE OF A HOUSE.  
 Send for Circular  
 FOR SALE IN STATIONARY AND DEPARTMENT STORES.  
 SENT BY MAIL OR EXPRESS ON RECEIPT OF \$ 1.15  
 Simplex Typewriter Co. 26 East 13<sup>th</sup> St. New York

**ROCKY MOUNTAIN DIAMOND**



1-karat size, set in a substantial scarf-pin or stick-pin or shirt-stud, by mail, postpaid, 25 cents; ring, 50 cents (give size). "The nearest approach to the real Diamond ever sold." That's our opinion; if it's not yours, "your money back." This offer is made for a different purpose; one than to simply sell you one Rocky Mountain Diamond—it will be plain to you. Order by return mail—only one pin or ring sold to any one person.

H. H. TAMMEN CURIO CO., Denver, Colo.

**KAREZZA** ETHICS OF MARRIAGE.

A bold, brave book teaching ideal marriage, rights of the unborn child, a designed and controlled maternity. Union Signal: Thousands of women have blessed Dr. Stockham for Tokology, thousands of men and women will bless her for Karezza.

**Arena:** Karezza is worth its weight in gold. Sample pages free. Agents Wanted. Prepaid \$1.00. ALICE B. STOCKHAM & CO., 277 MADISON ST., CHICAGO.

**TRY IT FREE**  
 for 30 days in your own home and save \$10 to \$25. No money in advance.  
 \$60 Kenwood Machine for \$23.00  
 \$50 Arlington Machine for \$19.50  
 Singers (Made by us) \$9, \$11.50, \$15 and 27 other styles. All attachments FREE. We pay freight. Buy from factory. Save agents large profits. Over 100,000 in use. Catalogue and testimonials free. Write at once. Address (in full). **CASH BUYERS' UNION** 158-164 West Van Buren St., B359 Chicago, Ill

Toronto, August 28, 1897.

I am obliged to spend the winter in Southern Colorado. Will some reader of RECREATION, in that section, advise me as to where I can find some of the things needed to make life worth living, viz.: good shooting, fishing and good food. Answer through RECREATION. A. A. M.

I start October 1st for San Francisco, by wheel, and would like a line of goods to advertise, en route.

H. A. Horton, Huntington, N. Y.

Where can I find good beach bird shooting along the shores of Massachusetts?

C. N. W., care RECREATION.

Teacher—What is taxidermy?  
 Johnnie—I guess I know, teacher?  
 Teacher—Well, Johnnie.  
 Johnnie—It's puttin' down carpets.—  
 Cleveland Plain Dealer.

**ASHLAND HOUSE**

FOURTH AVE. and 24th ST.

Two blocks from Madison Sq. Garden

...HEADQUARTERS FOR SPORTSMEN

American and European Plan

**RATES:**

|                       |                           |          |
|-----------------------|---------------------------|----------|
| Rooms, with board,    | \$2.00, \$2.50 and \$3.00 | per day  |
| Rooms, without board, | \$1.00 and upwards        |          |
| Breakfast,            |                           | 75 cents |
| Lunch,                |                           | 50 "     |
| Table d' Hote Dinner, |                           | 75 "     |

DO YOU TRAVEL ?  
 DO YOU HUNT BIG GAME ?  
 DO YOU SPEND YOUR SUMMER VACATION IN THE MOUNTAINS ?

If so, you need an Aneroid Barometer

**CALL & LEMBKE**

12 UNION SQUARE, NEW YORK

Can sell you one registering elevations up to 15,000 ft. and combining a thermometer and a compass.

A most valuable instrument to travelers and hunters.

Ten per cent. discount to all readers of RECREATION. Mention this Magazine when you write.

**Dixon's Graphitoleo**

Lubricates not only the chain and sprockets, but also the pins in the links of the chain, which stick Graphite cannot do and is not intended to do. For gun locks, for copying presses, and for office chairs it is unequalled. If your dealer does not keep it, mention RECREATION, and send 15 cents for sample.

JOS. DIXON CRUCIBLE CO., Jersey City, N. J.

WANTED.—LIVE ELK, MOOSE, CARIBOU, BLACK-tail deer, wild turkey, European roebucks, fallow deer, etc., for Litchfield Park, Adirondacks. Address, with particulars, EDWARD H. LITCHFIELD, 59 Vall Street, New York.

**Blair's Pills**  
 Great English Remedy for  
**GOUT and RHEUMATISM.**  
 SAFE, SURE, EFFECTIVE.  
 Druggists, or 224 William St., New York.

IN ANSWERING ADS, IF YOU WILL KINDLY MENTION RECREATION YOU WILL GREATLY OBLIGE THE EDITOR,

THE BEST OF ALL AMMUNITION



Try .22 Peters' Short Smokeless and New Victor Shells, Loaded with King's Smokeless

FOR ACCURACY, VELOCITY, STRENGTH, PENETRATION AND CLEANLINESS.



INSIST ON YOUR DEALER SUPPLYING YOU

THE PETERS CARTRIDGE CO.

CINCINNATI, O.

FOR SALE EVERYWHERE

J. B. CROOK & CO. Established 1837

1180 Broadway, Cor. 28th Street

Manufacturers and Importers of NEW YORK CITY, U. S. A.

HIGHEST GRADE FISHING TACKLE HIGHEST GRADE

SPECIALTIES FOR 1897

Featherweight Rods, Aluminum Reels Trout and Salmon Flies

The only Waterproof Fly Lines: The London Black or Trout, Salmon, and Black Bass.

Send 7 cents for catalogue. Mention RECREATION.

A Practical Common Sense Camp Stove.

In 6 Sizes. Patent applied for.

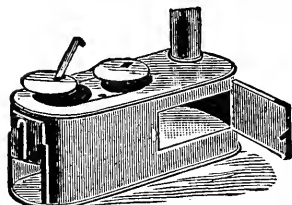

The lightest, most compact, practical camp stove made; either with or without oven. Won't get out of shape, combination cast and sheet steel top, smooth body, heavy lining, telescopic pipe carried inside the stove.

Burns largest wood, keeps fire longest of any stove made. For full particulars address

D. W. CREE, Manufacturer, Griggsville, ILL

Taxidermists' Supplies

WHEN you get a good specimen of bird, fish, mammal etc., that you would like to get mounted, send it to us. We will do it right and also make the price right.

Send five cents for new Taxidermists' Catalogue.

Artificial Glass Eyes

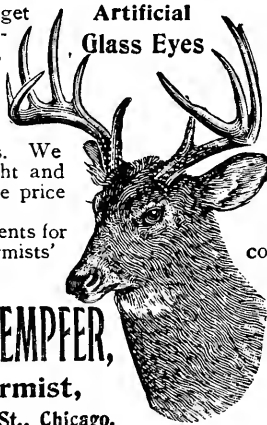

We prepare and mount all specimens of natural history true to nature, in the best style of the Taxidermist's art, at reasonable prices. We also keep a complete line of

Oologists' and Entomologists' Supplies

FRED. KAEMPFER, Taxidermist, 217 Madison St., Chicago.

FOSTER & CO.

Dealers in

Natural History Specimens

Animal Heads and Horns, Bird Skins and Eggs, Dead Game Panels, Indian Relics and Photos, Modern Indian Goods of Utility, Minerals, Fossils and Shells, Bicycles and Sundries, Natural History Supplies and Publications, Sporting Goods, Curios, etc. High-Class Taxidermy, Group Work.

ANN ARBOR, MICH.



Ernest L. Brown The Minnesota Taxidermist

Does true and artistic work at reasonable figures.

WARREN, MINN.

Moosehide Moccasins Slippers

METZ & SCHLOERB, Oshkosh, Wis.

PRICE: MEN'S - - - \$2.75 LADIES' AND BOYS' 2.25

Sent, prepaid, on receipt of price.

Write for our illustrated circular and price-list of hand made hunting shoes and moccasins of every description.

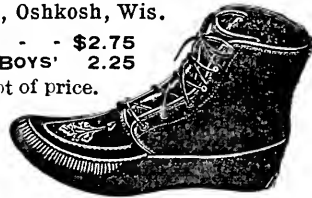

Wyoming...

For Antelope, Bear, Cougar, Deer, Elk, Fish, Goat, Moose, Sheep, Grouse, Duck, and Sage Chicken Shooting,

ADDRESS H. D. DEKALB, BIG PINEY, WYO.



# THIS FRIENDLY FACE

is PLEASED to ANNOUNCE to  
**ALL SHOOTERS**  
 of RIFLES, PISTOLS or SHOT GUNS  
 that the **Ideal Hand-Book No. 9** is just out. 116 pages of solid in-  
 formation about Nitro, Smokeless and  
 Black Powders, how to use them in various arms to get the best results. It is  
 the recognized authority on all matters relating to Shooting. You can't afford to be  
 without it. Mailed to any part of the world. Your address with two 2 cent stamps to  
**IDEAL MANUFACTURING CO., New Haven, Conn., U.S.A.**  
 WHEN YOU WRITE KINDLY MENTION "RECREATION"

Sectional View

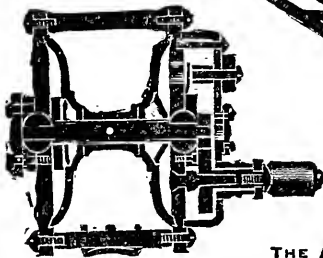

Globe Bearing.



Don't believe imitators of "**HENDRYX**" standard  
 goods when they say their Fishing Reels "are **NOW**  
 as good as **HENDRYX**". The fact that they  
 imitate proves the "**HENDRYX**" is the recognized  
 standard line of Fishing Reels. Ask your dealer for  
 them.

THE ANDREW B. HENDRYX CO., NEW HAVEN, CONN., U. S. A.

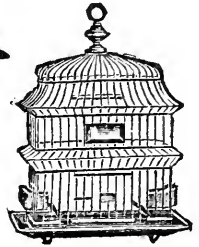

This is a picture of Sewell New-  
 house, inventor of the celebrated

## NEWHOUSE STEEL TRAPS

known the world over as the  
 best traps made for catching fur-  
 bearing animals. Send to

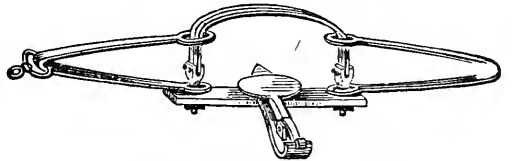

**ONEIDA COMMUNITY, Ltd., Kenwood, N. Y.**

for catalogs, prices and discounts.

# RUPTURE ABSOLUTELY CURED . . . .

without truss, operation or con-  
 finement, on strictly scientific  
 professional principles, based on  
 an experience of many years.

My method of treatment is known only to myself, and I object to long  
 letters explanatory thereof. An interview is positively necessary for those re-  
 quiring information.

Complete cure effected in 6 to 8 weeks; one treatment each week,  
 with no detention whatever from business.

# SAGREDO

Care F. C. PRESTON, 98 Hudson Street, New York

**Exchange:** Kodak, 4 x 5, cost \$50.00,  
 used some, and slightly marked, but in per-  
 fect condition, to exchange for 12 or 16  
 shot gun. Prefer Hollenbeck or Ithaca  
 hammerless, or will exchange for perfect  
 mounted game head, of equal value.

Dr. Wm. A. Hastings, Oswego, N. Y.

I have a 44 calibre English revolver, Eng-  
 lish Government stamp on barrel, double  
 action, nickel plated, which I would like to  
 exchange for 12 gauge shot gun.

A. Wilson, Baltimore, Md.

**For Exchange:** An elegant deer head—  
 mounted—for pair of fox hounds, or pups.  
 O. B. VanDusen, Phillips, Wis.

# \$200.00 FOR CORRECT ANSWERS

**Most Unique Contest of the Age — \$200.00 Paid for Correct Lists made by Supplying Missing Letters in Places of Stars — No Lottery — Popular Plan of Education — Read All the Particulars.**

In the United States four times as much money is expended for education as for the military. Brain is better than brawn. By our educational facilities we have become a great nation. We, the publishers of **Woman's World and Jenness Miller Monthly**, have done much toward the cause of education in many ways, but now we offer you an opportunity to display your knowledge and receive **most generous payment for a little study**. The object of this contest is to give an impetus to many dormant minds to awaken and think; also we expect by this competition of brains to extend the circulation of **Woman's World and Jenness Miller Monthly** to such a size that we shall be able to charge double the present rate for advertising in our columns. By this plan of increasing the number of subscriptions and receiving more money from advertisers of soaps, pianos, medicines, books, baking powders, jewelry, etc., we shall add **\$50,000** a year to our income, and with this mathematical deduction before us we have decided to operate this most remarkable "missing letters" contest.

## HERE'S WHAT YOU ARE TO DO.

There are **thirty words** in this schedule, from each of which letters have been omitted and their places have been supplied by stars. To fill in the blank spaces and get the names properly you must have some knowledge of geography and history. **We want you to spell out** as many words as you can, then send to us with 25 cents to pay for a three months' subscription to **WOMAN'S WORLD**. **For correct lists we shall give \$200.00** in cash. If more than one person sends a full, correct list, the money will be awarded to the **fifty best lists** in appearance. Also, if your list contains twenty or more correct words, we shall send you a beautiful **Egeria Diamond Scarf Pin** (for lady or gentleman), the regular price of which is **\$2.25**. Therefore, by sending your list, you are positively certain of the **\$2.25** prize, and by being careful to send a correct list you have an opportunity of the **\$200.00 cash award**. The distance that you may live from New York makes no difference. All have equal opportunity for winning.

## PRIZES WILL BE SENT PROMPTLY.

Prizes will be **honestly** awarded and promptly sent. We publish the list of words to be studied out. In making your list of answers, be sure to give the number of each word:

- |                                                                                                                                                                                                                                                                                                                                                                                                                                                                                                                                                                                                                                                                                                                                                                                                         |                                                                                                                                                                                                                                                                                                                                                                                                                                                                                                                                                                                                                                                                                                                                      |
|---------------------------------------------------------------------------------------------------------------------------------------------------------------------------------------------------------------------------------------------------------------------------------------------------------------------------------------------------------------------------------------------------------------------------------------------------------------------------------------------------------------------------------------------------------------------------------------------------------------------------------------------------------------------------------------------------------------------------------------------------------------------------------------------------------|--------------------------------------------------------------------------------------------------------------------------------------------------------------------------------------------------------------------------------------------------------------------------------------------------------------------------------------------------------------------------------------------------------------------------------------------------------------------------------------------------------------------------------------------------------------------------------------------------------------------------------------------------------------------------------------------------------------------------------------|
| <p>1. * R A * I * A country of South America.</p> <p>2. * A * I * I * Name of the largest body of water.</p> <p>3. M * D * * E * * A * E * * A sea.</p> <p>4. * M * * O * A large river.</p> <p>5. T * A * * S Well known river of Europe.</p> <p>6. S * * A N * A * A city in one of the Southern States.</p> <p>7. H * * * * X A city of Canada.</p> <p>8. N * A * A * A Noted for display of water.</p> <p>9. * E * * E * * E * One of the United States.</p> <p>10. * A * R I * A city of Spain.</p> <p>11. H * V * * A A city on a well known island.</p> <p>12. S * M * E * A well known old fort of the United States.</p> <p>13. G * * R * L * A * Greatest fortification in the world.</p> <p>14. S * A * L E * A great explorer.</p> <p>15. C * L * F * * * I * One of the United States.</p> | <p>16. D * S M * * K A noted ruler.</p> <p>17. * * C T O * I * Another noted ruler.</p> <p>18. P * R * U * A * Country of Europe.</p> <p>19. A * S T * A * I * A big island.</p> <p>20. M * * I N * E * Name of the most prominent American.</p> <p>21. T * * A * One of the United States.</p> <p>22. J * F * * R * * N Once President of the United States.</p> <p>23. * U * * N A large lake.</p> <p>24. E * E * S * N A noted poet.</p> <p>25. C * R * A A foreign country, same size as Kansas.</p> <p>26. B * R * * O A large island.</p> <p>27. W * M * * S W * R * D Popular family magazine.</p> <p>28. D * H * I * G A sea.</p> <p>29. A * L * N * I * An ocean.</p> <p>30. M * D * G * S * A * An island near Africa.</p> |
|---------------------------------------------------------------------------------------------------------------------------------------------------------------------------------------------------------------------------------------------------------------------------------------------------------------------------------------------------------------------------------------------------------------------------------------------------------------------------------------------------------------------------------------------------------------------------------------------------------------------------------------------------------------------------------------------------------------------------------------------------------------------------------------------------------|--------------------------------------------------------------------------------------------------------------------------------------------------------------------------------------------------------------------------------------------------------------------------------------------------------------------------------------------------------------------------------------------------------------------------------------------------------------------------------------------------------------------------------------------------------------------------------------------------------------------------------------------------------------------------------------------------------------------------------------|

In sending your list of words, mention whether you want prize money sent by bank draft, money order or registered mail; we will send any way that winners require. The **Egeria Diamond** is a perfect imitation of a **Real Diamond** of large size. We defy experts to distinguish it from real except by microscopic test. In every respect it serves the purpose of **Genuine Diamond of Purest Quality**. It is artistically mounted in a fine gold-plated pin, warranted to wear forever. This piece of jewelry will make a most desirable gift to a friend if you do not need it yourself. At present our supply of these gifts is limited, and if they are all gone when your set of answers comes in, we shall send you **\$2.25** in money instead of the **Scarf or Shawl Pin**, so you shall either receive the piece of jewelry or the equivalent in cash, in addition to your participative interest in the **\$200.00 cash prize**. **This entire offer is an honest one**, made by a responsible publishing house. We refer to **mercantile agencies** and **any bank** in New York. We will promptly refund money to you if you are dissatisfied. What more can we do? Now study, and exchange slight brain work for cash. With your list of answers send **25 cents** to pay for three months' subscription to our **great family magazine, Woman's World**. If you have already subscribed, mention that fact in your letter, and we will extend your subscription from the time the present one expires. To avoid loss in sending silver, wrap money very carefully in paper before inclosing in your letter. Address:

**JAMES H. PLUMMER, Publisher,**

WHAT THE PULLMAN CAR IS  
TO THE RAILWAY TRAVELER,  
THE NEW ZEALAND MOS-  
QUITO TENT IS TO THE CAMPER

# New Zealand Mosquito Tent

“Fresh, pure air, and plenty of it, is the surest and most natural remedy for more than half the ills man is heir to.”

## Our Special Affair

is to make **Tent Life** a luxury instead of the misery it has too often proved on trial.

Twenty-six years “roughing it,” in all kinds of weather, from 110 degrees of heat to six feet of snow, is the experience from which the New Zealand Mosquito Tent has been evolved.

It is, in point of comfort, as far ahead of old style tents as the Pullman car is ahead of the western “Prairie Schooner,” or as the modern “Atlantic Greyhound” is ahead of the old time “Columbian” sloop, or the “Mayflower.”

T. W. HICKSON

23 William Street  
New York City

INSECT  
REPTILE  
AND  
VERMIN  
PROOF



AIRY  
COSY  
LIGHT  
BRIGHT  
WATERPROOF  
DURABLE  
VENTILATION  
PERFECT  
EASILY  
SET  
UP



PATENT  
APPLIED  
FOR

'97

The Best Practical  
**SLEEPING BAG**

THE  
**JOHNSON**

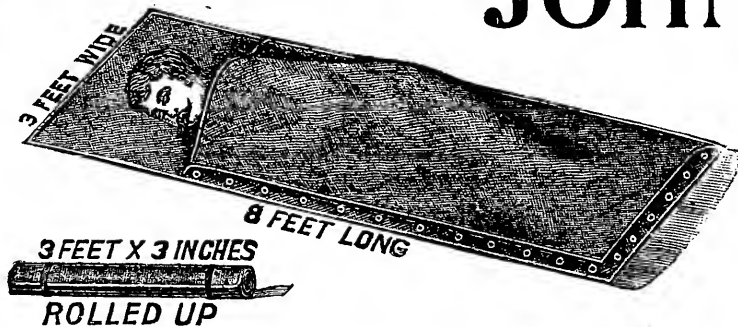

It is made of the best close-woven canvas, thoroughly waterproofed by our process, without seam, and having edges bound with a hard linen braid, more durable than leather,

giving a neat and trim appearance. The pattern is unique. A side and foot are closed by an overlapping piece, with patent clasp buttons, making a wind-tight joint, so the bag can be opened for airing or arranging linings. We furnish linings in squares, fastened to bag with clasp buttons, so there is no slipping or twisting of blanket. We have linings in Himalayan Dog Skin, Imported and Domestic Sheep Skins. Heavy, Medium, and Light Wool Blankets.

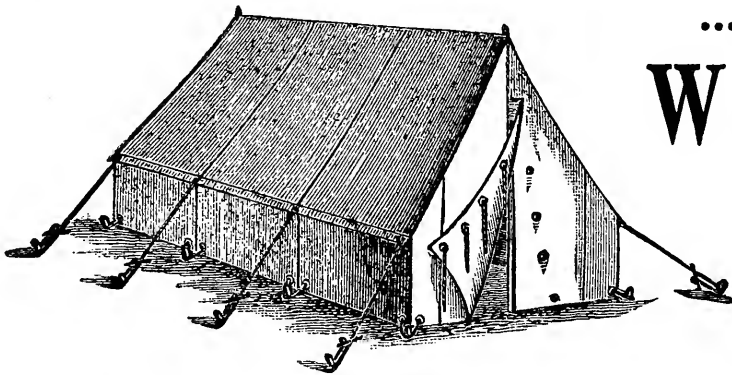

...THE...

**WATER-  
PROOF  
TENT**

A camper knows the advantages of a tent that is an absolute protection against rain and dampness. We secure this by our waterproof process and thus avoid the necessity of a fly, with its extra weight and bulk—a great advantage to travelers.

We make tents of all sizes and shapes.



Canvas Buckets, Ammunition, Clothing, Provision, and Saddle Bags, Pouches, Bicycle Cases, Ground Cloths, and many other Canvas Specialties.

Send for Catalogue R and Samples.

**DERBY, ABERCROMBIE & CO.**

36 South Street, New York

Mention RECREATION.



The Only Practical  
**Camping Bag**

IS THE . . .

# Kenwood



Enthusiastically endorsed by campers everywhere—not an experiment. Now made with improvements suggested by usage under all conditions—as, for instance, the outside waterproof canvas cover, the middle bag and the soft, warm, light inner bag—to be used separately or combined, thus giving perfect protection from cold, rain or sudden climatic changes. Strong, durable and useful, as a hold all.

A perfect  
 shelter.  
 Tents  
 unnecessary.

No stiffened muscles. No uncovering.  
 The Prices

**\$6.00 to \$16.00**

are a revelation to buyers of the old, heavy and unsatisfactory square blankets.



## The Kenwood Hunting Cape

meets every requirement of the sportsman "waiting for a shot," whether at a deer, ducks or pigeons. Better than coats. Carefully made to combine all desirable features. Excellent as a Driving Cape.

Price

**\$15.00**

## The Kenwood Storm Hood

for use with the Bags, or for anyone exposed to severe weather, will be found very serviceable and a comfort in cold or windy weather.

*Every Camper, Hunter, Angler, Prospector or Military Man should send for our FREE illustrated circular, about these goods and camping information*

**THE KENWOOD MILLS, Albany, N. Y.**

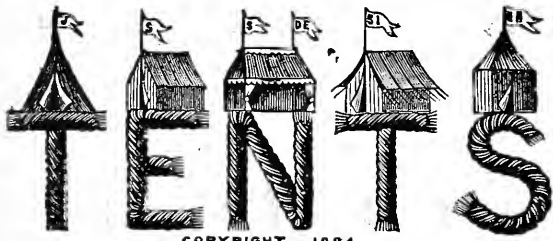

COPYRIGHT 1884

# AND CAMP OUTFITS

We manufacture the largest and most complete line of tents in the country, and our goods are celebrated for their wearing and waterproof qualities.

Send 4 cents in stamps for our new 40-page illustrated catalogue showing all styles of Tents and Camp furniture.

**GEO. B. CARPENTER & CO.**

202 to 210 S. Water Street, CHICAGO

Established 1840.

# "Fenton" BICYCLES

outgrade the so-called high grade. They have distinctive qualities of their own. Riders use them once and then always.

Send for Catalogue

**Fenton Metallic Mfg. Co.**  
Jamestown, N. Y.



NEW YORK AGENTS  
C. M. MOSEMAN & BRO.  
126-128 CHAMBERS ST.

# Tribune Bicycles



**The Best in the World**

Send for Catalogue

**THE BLACK MFG. CO.**  
ERIE, PA.

Mention RECREATION.

## 1897 High Grade Bicycles



for Men, Women, Girls & Boys. Complete line at lowest prices ever quoted.  
\$100 'Oakwood' for \$45.00  
\$85 'Arlington' " \$37.50  
\$55 " " \$25.00  
\$20 Bicycle " \$10.75

\$75 'Maywood' Simplest, Strongest Bicycle on Earth " \$32.00  
Fully guaranteed. Shipped anywhere C.O.D. with privilege to examine. No money in advance. Buy direct from manufacturers, save agents and dealers profits. Large illustrated catalogue free. Address (in full):  
Cash Buyers' Union, 162 W. Van Buren St. B. 359 Chicago

## \$12 3000 BICYCLES



must be closed out at once.  
Standard '97 Models, guarant'd, \$14 to \$30. '96 models to \$20. 2d hand wheels \$5 to \$15. Shipped to anyone on approval without advance deposit. Great factory clearing sale  
**EARN A BICYCLE**

by helping advertise us. We will give one agent in each town FREE USE of a sample wheel to introduce them. Write at once for our Special Offer. D. R. MEAD & PRENTISS, Chicago, Ill.

For Sale or Exchange: An old muzzle loading rifle, once owned and used by the Prince of Wales, when hunting in this country. Was by him given to the scout, Cass Lewis, and by him sold to Kit Carson. It uses a 1 ounce round ball, is in perfect condition, and has a globe sight. Will exchange for modern 12 gauge D.B.B.L. gun.

Chas. L. Lundy,  
9th & Main Sts.,  
Cincinnati, Ohio.

(N. Y., 3318. Ed. 3—25,000.)

MEMORANDUM OF WEIGHT.

DATE OF MAILING.

| DAY.         | A. M.     | P. M.        |
|--------------|-----------|--------------|
| <i>Apr 2</i> |           | <i>5 30</i>  |
|              | <i>to</i> |              |
| <i>" 30</i>  |           | <i>10 25</i> |

ORIGINAL.

New York Post Office,

*5-4<sup>th</sup>* 189*7*

Received from

*Recreation*

IN WEIGHT, AS FOLLOWS:

|                               | TARE. | GROSS WEIGHT.   |
|-------------------------------|-------|-----------------|
| <i>244</i> No. 1 Sack, 3 lbs. |       | <i>13554</i>    |
| No. 2 Sack                    |       | <i>732</i>      |
| Net weight,                   |       | <i>12822</i>    |
| Rate per pound,               |       | <i>.01</i>      |
| Amount of postage,            |       | <i>\$128.22</i> |

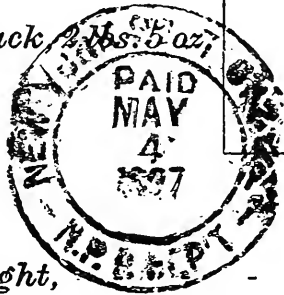

Per *A. W. Lamb* Postmaster.  
Receiving Clerk.

NOTE.—It is important that this receipt be compared with its duplicate, signed by the Postmaster, and issued at the close of each month.

Post-office receipt for May number of RECREATION. Other receipts cheerfully shown on application.

A copy of RECREATION weighs  $\frac{1}{2}$  lb. and the postage is 1 cent a pound. This means a subscription list of 25,600 copies a month. Figure it and see. Then call for further proof.

Address RECREATION, 19 West 24th Street, New York

(N. Y., 3316. Ed. 5—25,000.)

MEMORANDUM OF WEIGHT.

DATE OF MAILING.

| DAY.   | A. M. | P. M. |
|--------|-------|-------|
| May 25 |       |       |
| to     |       |       |
| June 2 |       |       |

New York Post Office,

6-2-1897

Received from

Recreation

IN WEIGHT, AS FOLLOWS:

|                          | TARE. | GROSS WEIGHT.   |
|--------------------------|-------|-----------------|
| 185 No. 1 Sack, 3 lbs.   |       | 16718           |
| No. 2 Sack, 2 lbs. 5 oz. |       | 555             |
| Net Weight, - - -        |       | 16163           |
|                          |       | .01             |
| Rate per pound, - - -    |       | <u>161.63</u>   |
| Amount of postage, -     |       | <u>\$161.63</u> |

Per C. A. L. Postmaster.  
 Receiving Clerk.

2-1-96

Post-office receipt for June number of RECREATION. The postmaster does not stuff the returns for any publisher.

This is for subscriptions only. The News Co.'s trade of 11,000 a month is not included. Total circulation, 40,000 a month.

If interested call for further proof.

Address RECREATION, 19 West 24th Street, New York

(N. Y., 3316. Ed. 5—25,000.)

MEMORANDUM OF WEIGHT.

DATE OF MAILING.

| DAY.   | A. M. | P. M. |
|--------|-------|-------|
| June 2 |       | 9 -   |
|        | to    |       |
| July 2 | 1115  |       |

New York Post Office,

7-7-1897

Received from.

*Recreation*

IN WEIGHT, AS FOLLOWS:

|                          | TARE. | GROSS WEIGHT. |
|--------------------------|-------|---------------|
| 140 No. 1 Sack, 3 lbs.   |       | 13125         |
| No. 2 Sack, 2 lbs. 5 oz. |       | 420           |
| Net Weight, - -          |       | 12705<br>.01  |
| Rate per pound, -        |       |               |
| Amount of postage, -     |       | \$ 127.05     |

C. VAN COTT, P. M.

Per *A. W. Lamb* Postmaster.  
Receiving Clerk

2-1-96

Here is a third receipt, and all these 3 are for the 3 dullest months in the year

(N. Y., 3318. Ed. 3—25,000.)

# MEMORANDUM OF WEIGHT.

DATE OF MAILING.

| DAY.   | A. M. | P. M. |
|--------|-------|-------|
| July 6 |       | 745   |
| 10     |       |       |
| " 30   |       | 735   |

ORIGINAL.

New York Post Office,  
8-2<sup>nd</sup> 1897

Received from

*Recreation*

IN WEIGHT, AS FOLLOWS:

|                             | TARE. | GROSS WEIGHT. |
|-----------------------------|-------|---------------|
| 139 No. 1 Sack, 3 lbs.      | 417   | 16379         |
| 39 No. 2 Sack, 2 lbs. 5 oz. | 90    |               |
|                             |       | 507           |
| Net weight,                 |       | 15872         |
| Rate per pound,             |       | .01           |
| Amount of postage,          |       | \$ 158.72     |

Per *AW Lamb* Postmaster.  
Receiving Clerk.

NOTE.—It is important that this receipt be compared with its duplicate, signed by the Postmaster, and issued at the close of each month.

Here is still another. This is for the August issue. You will observe it takes 139 to 185 sacks, each month, to hold RECREATION'S mail. You have doubtless noticed the preceding receipts. Others will be published in future, showing much larger mailings than either of these.

## SOME GOOD GUIDES.

Following is a list of names and addresses of guides who have been recommended to me, by men who have employed them; together with data as to the species of game and fish which these guides undertake to find for sportsmen.

If anyone who may employ one of these guides finds him incompetent or unsatisfactory, I will be grateful if he will report the fact to me.

## ALASKA.

William York, Juneau, moose, bear, deer, sheep, goats and small game.

## CALIFORNIA.

Chris. Ringsin, Avalon, Santa Catalina Island, goats, water-fowl, and salt-water fishing.

John Broder, Visalia, trout, deer, bear, grouse, and quails.

S. L. N. Ellis, Visalia. ditto

## COLORADO.

J. M. Campbell, Buford, elk, bear, deer, antelope, trout and grouse.

Chas. Smith, Buford, ditto

Frank Allen, Dotsero, Eagle Co., "

Charles Allen, Dotsero, Eagle Co., "

John Meier, Sweetwater Lake, Dotsero P. O., "

Eagle Co., "

R. W. McGee, Debeque, "

Lem Crandall, Debeque, "

Sam. T. Himes, New Castle, "

Luke Wheeler, Pinkhampton, "

Nathan Fisher, Gunnison, "

W. H. Hubbard, Glenwood Springs, "

W. L. Pattison, Buford, "

J. E. Borah, Glenwood Springs, "

Ed. L. Stockton, 527 11th St., Greeley, "

## FLORIDA.

C. L. Farnham, Avon Park, bear, deer, turkeys, quails, ducks, black bass, etc.

Oliver Tinny, Ozona, Hillsboro Co., deer, bear, turkeys, quails, ducks and salt-water fishing.

E. M. Reynolds, Fort Myers, ditto

Wm. Webb, Osprey, Manatee Co., "

Frank Guptill, Osprey, Manatee Co., "

W. J. Meyer, Tarpon Springs, "

Frank Carson, Ft. Meyers, "

E. T. Robinson, Keuka, "

Carson Bros., Frostproof, "

J. L. Sandlin, Punta Gorda, "

Oliver Archer, Clearwater, "

L. W. Scroggins, Homeland, "

Capt. Jas. Argo, Oviedo, "

F. J. Adams, Sanford, "

C. B. Bailey, Winter Haven, "

W. H. Steacy, Pt. Tampa City, "

Wm. J. Lyon, Interlacken, "

L. L. Sutton, Sutherland, "

M. B. Carson, Frost Proof, Polk Co., "

W. D. Isler, Eagle Lake, "

George W. Hawthorn, Hawthorn, "

C. H. Hill, Maitland, "

J. E. Bowen, Laughman, "

Margan Bass, Kissimmee, "

B. C. Lanier, Leesburg, "

John Hunter, Winter Park, "

H. Shipman, Haskell, "

Robert James, Emporia, "

Alex. Brown, Martin, "

W. J. McCullough, Boardman, "

Frank Smith, St. James City, "

Jinks McCreary, Higly, "

Baldwin Cassady, Lisbon, "

W. H. Howell, Centre Hill, "

Ed. Brown, Dunedin, "

G. B. Lawson, Lake Maitland, "

J. H. Maddox, Wauchula, "

Will Montgomery, Arcadia, "

T. E. Fielder, Calvinia, "

W. F. Hays, Webster, "

John Beidler, Gabrielle, "

## IDAHO.

W. L. Winegar, Egin, Fremont Co., elk, bear, deer, antelope, mountain sheep, trout and grouse.

Geo. Winegar, St. Anthony, Fremont Co., ditto

R. W. Rock, Lake, Fremont Co., "

Ed. Stailey, Lake, Fremont Co., "

J. S. Sadorus, Sarilda, Fremont Co., "

Geo. W. Rea, Orange, Fremont Co., "

Wm. Fraser, Beaver Canyon, "

## IOWA.

Geo. Jenkins, Spirit Lake, ducks, prairie chickens, black bass, etc.

Wilbur Clark, Spirit Springs, ditto

## MAINE.

Wm. S. Emery, Blakesley Camps, Eustis, moose, caribou, deer, trout, grouse.

Charley Condon, Moro, ditto

Wm. Atkins, Oxbow, "

J. E. Jenkins, "

Miles D. Arbow, Oxbow, "

Nathan B. Moore, Bingham, "

Walter Dacey, Medway, "

Elliott Rich, Bethel, "

John C. Lamb, Kineo, "

John J. Kelly, "

Winn McKenney, Patten, "

Royal E. Paine, Stratton, "

Charles Hathaway, Medway, "

Victor Scott, Millinockett, "

C. O. Norton, Dover, "

Benjamin Woodard, Dover, "

Col. N. D. Brown, Roach River House, "

Alonzo Davenport, Shesuncook, "

Ichabod Smith, Greenville, "

Ernest Ham, Guilford, "

Charlee Capen, Capens, "

Ed. Masterman, Moosehead, "

Marsh Carlton, Rangely, "

Freeman Tibbetts, Rangely, "

Fred Reed, Medway, "

Dan Hale, Medway, "

Will Meyer, Eustis, "

Charles Haley, Eustis, "

H. R. Horton, Eustis, "

P. E. Young, Sherman Mills, "

Abner McPhiters, Norcross, "

Albert McPhiters, Norcross, "

Horace B. Cushman, Norcross, "

Irving Hunt, Norcross, "

Wm. O. Shaw, Dobsy Lake, Washington Co., "

Ran. Day, Princeton, Washington Co., "

Geo. C. Jones, Carritunk, "

Geo. W. Spaulding, Carritunk, "

Geo. Douglass, Eustis, "

David Quint, Eustis, "

Davis Moody, Stratton, "

Gus Jones, Stratton, "

Fred Viles, Stratton, "

John Darling, Lowell, "

Joe Francis, Old Town, "

Sebat Shay, Old Town, "

Louis Ketcham, Old Town, "

Granville M. Grey, Old Town, "

Thomas Benham, Jay, "

L. A. Orcutt, Ashland, "

## MASSACHUSETTS.

Recommended by Dr. Hitchcock, Cliftondall, grouse, squirrels, salt water fishing.

## MICHIGAN.

Bony Markelty, Negaunee, deer, bear, grouse, trout, black bass, and muskalonge.

Thos. Starr, Alpena, ditto

## MINNESOTA.

C. L. Porter, Glenwood, ducks, geese, prairie chickens, and black bass.

E. L. Brown, Warren, ditto

Jack Baldwin, Jackson, "

Guy H. Remore, Bemidji, Beltrami Co., "

Mr. Thos. Clark, Bemidji, Beltrami Co., "

SOME GOOD GUIDES (Continued).

MONTANA.

M. P. Dunham, Woodworth, elk, bear, deer, antelope, mountain sheep, trout and grouse.  
 G. H. Heywood, Red Lodge, ditto  
 Geo. W. Solleder, Lake Como, "  
 W. H. Ryther, Columbia Falls, "  
 Quincy Myers, Columbia Falls, "  
 Theodore Christiansen, Columbia Falls, "  
 Mr. William Jackson, Browning, Montana, "  
 W. A. Hague, Fridley, "  
 E. E. Van Dyke, Red Lodge, "  
 Vic. Smith, Anaconda, "  
 James Blair, Magdalen, "  
 George Whitaker, Gardiner, "

NEW HAMPSHIRE.

P. Marden, Wolfboro Falls, black bass, grouse and quails.  
 Frank Britton, Wolfboro Falls, ditto  
 J. Walter Akers, Errol, "  
 Ned Norton, Colebrook, moose, caribou and deer.  
 John Bresette, Diamond Pond, ditto  
 Henry Bresette, Diamond Pond, "  
 Lafayette S. Covell, Connecticut Lakes, caribou, deer, etc.  
 M. Burnham, Conway Centre, ditto  
 W. H. French, South Conway, "  
 L. D. Mills, South Conway, "

NEW JERSEY.

Billy Throckmorton, Mannahawkin, ducks, geese, brant, shore birds, grouse, salt-water fishing.  
 Dory Hulse, Mannokoking, Ocean Co., ditto  
 Ernest Worth, Bayville, Ocean Co., "  
 James Emmans, Jr., Swartwood Lake, Swartwood, black bass, pickerel, quails and rabbits.  
 Mr. Riker, Culver's Lake, Branchville, perch, black bass and pickerel.

NEW YORK.

Cal. Blanchard, Upper Jay, deer, grouse, rabbits, squirrels and trout.  
 Abe Rundle, Eldred, Sullivan Co., ditto  
 H. M. Tacey, White Lake, Sullivan Co., "  
 Eugene Scrafford, Eighth Lake, Old Forge, "  
 Edson Brown, Spring Cove, Franklin Co., "  
 F. A. Young, Big Moose, "  
 Dan Ainswarth, Big Moose, "  
 Chris Wagner, Beaver, "  
 Edw. Ball, Old Forge, "  
 Eugene M. House, Glendale, "  
 L. C. Pendell, Athol, "  
 Geo. Goodsell, Old Forge, "  
 Martin Humes, Harrisville, "  
 Frank Perkins, Greg, Lewis Co., "  
 Chas. McKaffery, Saranac Inn, "  
 C. I. Stanton, Blue Mountain Lake, "  
 Leonard Bunting, Greenfield, Ulster Co., grouse, woodcock and trout.  
 Thomas Flake, Cape Vincent, pickerel, muskalonge, black bass.  
 Wilfred Dodge, Cape Vincent, ditto  
 Ren Dodge, Cape Vincent, "  
 Warren Aldrich, Greenwood Lake, black bass, trout, grouse, squirrels, rabbits, etc.  
 Charles Lane, Good Ground, L. I., ducks, geese, snipe, plover and salt-water fishing.  
 Harry Rogers, Eastport, L. I., ditto  
 Geo. Rolston, Lake Ronkonkoma, L. I., "  
 Willett Ellison, Freeport, L. I., "  
 W. C. Raynor, Freeport, L. I., "  
 W. N. Ackerley, Patchogue, L. I., ducks, baybirds, salt-water fishing.  
 H. Smith, Moriches, L. I., quails, woodcock and grouse.  
 Dan Havens, Centre Moriches, L. I., ditto  
 Hugh Smith, East Moriches, L. I., "

NORTH CAROLINA.

Fenner S. Jarvis, Haslin P. O., deer, bear, turkeys and quails.  
 Robert Waterfield, Knotts Island, ditto  
 Jas. Tooly, Belleport, "  
 W. C. Halsted, Currituck C. H., deer, turkeys, quails, ducks, salt-water fishing.  
 Fred. Latham, Haslin, ditto

NORTH DAKOTA.

Geo. Carr, Sanborn, ducks, geese, prairie chickens, snipe, black bass and pike.

OREGON.

Wm. Ascher, West Fork, Douglass Co., deer, bear, elk, trout, grouse, ducks and geese.  
 E. L. Howe, Creswell, Lane Co., ditto

PENNSYLVANIA.

Leonard Champion, Prop'r Lehigh Valley Hotel, Mahogany, Wyoming Co., bass, pickerel, salmon.  
 John W. Kelletsville, deer, grouse, trout, black bass, etc.

VERMONT.

E. Ward, Fair Haven, woodcock, grouse, black bass and trout.

VIRGINIA.

M. Corbel, Virginia Beach, geese, brant, ducks, shore birds, quails, salt-water fishing.  
 Captain R. E. Miles, Machipongo, ditto  
 C. A. Spencer, Buckingham, "  
 M. A. Barner, Clarksville, "

WASHINGTON.

John S. Wood, Morton Lewis Co., deer, grouse, trout, etc.

WISCONSIN.

T. R. Page, Bruce, deer, grouse, trout, black bass and muskalonge.  
 Charles Johnson, care Williams, Salsich & Co., Star Lake, Vilas Co., ditto  
 L. L. Thomas, State Line, "  
 John Thomas, State Line, "  
 Chas. French, Three Lakes, "  
 John Albright, Three Lakes, "  
 M. E. Monsell, Star Lake, Vilas Co., "  
 H. E. Soule, South Range, "  
 Judd Blaisdell, Camp Franklin, Woodruff, "  
 Alexander Gillies, Camp Franklin, Woodruff, "  
 C. J. Coon, Camp Franklin, Woodruff, "  
 Chas. Lebell, Manitowish, Wis., "

WYOMING.

Mark H. Warner, Ten Sleep, elk, bear, deer, mountain sheep, antelope, grouse and trout.  
 Milo Burke, Ten Sleep, ditto  
 James Fullerton, Ten Sleep, "  
 Nelson Yarnall, Dubois, "  
 Geo. Y. Hayes, Dubois, "  
 S. A. Lawson, Laramie, "  
 R. C. Tregoning, Laramie, "  
 A. Pache, Laramie, "  
 N. E. Brown, Marquette, "  
 H. D. DeKalb, Big Piney, "  
 Ira Dodge, Cora, "  
 S. N. Leek, Jackson, "  
 Jack Hurst, Ishawood, "  
 W. A. Kepford, Ishawood, "  
 Wm. Wells, Cora, "  
 Frank L. Peterson, Jackson, "  
 O. F. Bike, Jackson, "  
 F. E. White, Jackson, "  
 W. A. Hague, Pleasant Valley Hotel, via Mammoth Hot Springs, "

CANADA.

Christopher Bowers, Shelburne, Nova Scotia, moose, bear, grouse, black bass and trout.  
 E. Thompson, Hammond Plain, Nova Scotia, ditto  
 John Bowers, Shelburne, Nova Scotia, "  
 Frank Komondo, Desert or Maniwaki, P. Q., "  
 Philamon Gashon, Three Lakes, P. Q., "  
 Robert Elliott, Kennebec Road, Armstrong, County Beauce, P. Q., "  
 Geo. Gillard, Little Bay, Notre Dame Bay, Newfoundland, caribou, bear, ptarmigan, ducks and geese.  
 W. Kelly McKay, Upper Clyde, Shelburne Co., N. S., moose, bear, lynx, fox, partridge, rabbit, trout.  
 James H. Bower, Upper Clyde, ditto  
 Thomas Davis, Upper Clyde, "  
 Purney Davis, Upper Clyde, "  
 Christian Ryer, Middle Clyde, "  
 Daniel McKay, Middle Clyde, "  
 Parker K. Freeman, Milton, Queens Co., N. S., moose, bear, lynx, fox, partridge, rabbits, trout, salmon.  
 John Jeremy, Milton, ditto  
 Stephen Glode, Milton, "  
 Alick Michel, Milton, "  
 Enoch Freeman, Greenfield, "  
 Boardman Hunt, Greenfield, "  
 Capt. Jesse Milliken, St. George, N. B. "  
 Henry I. Millar, River Desert, "  
 David McDougal, Okanagan Mission, B. C., goats, sheep, elk, deer, etc.  
 Guy Thomas, Cherry Creek, B. C., ditto  
 J. S. Wilson, Okanagan Lake, B. C., "



## You Get the Profits

Of Dealers, Agents, Jobbers  
and Middlemen by buying di-  
rect from the manufacturer.

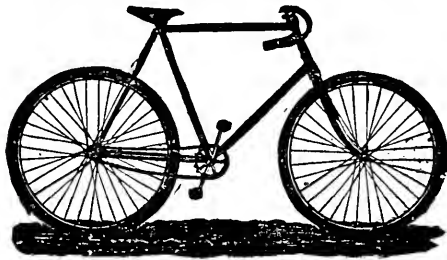

No better wheel made than the

## Acme Bicycle

Built in our own factory by  
skilled workmen, using the best  
material and the most improved  
machinery. *We have no agents*  
Sold direct from factory to the  
rider, fully warranted. Shipped  
anywhere for examination.

WRITE FOR

## Our Interesting Offer

Acme Cycle Co., Elkhart, Ind.

# The Press Button Knife

Can be Opened Instantly with One Hand by Slightly Pressing the Button :: ::

## FOR Hunting, Fishing and Camping

Our 4-inch or 5-inch jack-knife is invaluable in emergencies when you need a strong knife quickly. Press button and blade is open for use.

Four-inch Blade, Stag Handle. . . . . \$1.00  
Five-inch Blade, Stag Handle, . . . . . 1.25

SENT POSTPAID

**LOTT & SCHMITT**

112-114 Walker Street  
NEW YORK

### LADIES' AND GENTLEMEN'S POCKET KNIFE

AS CUT

In Sterling Silver, . . . . . \$1.75  
In Pearl, Plain, . . . . . 1.50  
In Ivory, Plain, . . . . . 1.25  
In Stag, Plain, . . . . . 1.00  
In Ebony, Plain, . . . . . 1.00

SENT POSTPAID

SEND FOR ILLUSTRATED CATALOG

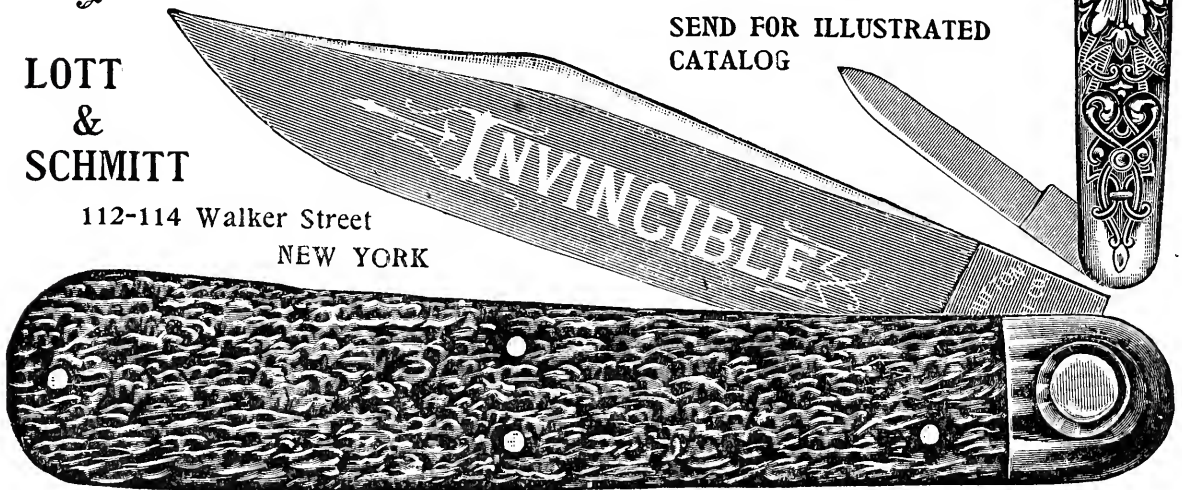

Owing to the Wisconsin game law being invalid, last fall, few deer were killed in this section. While fox hunting last spring, I had the pleasure of seeing 8 deer in one bunch, 4 miles South of Baraboo, on the Devils lake bluffs.

F. A. Moore, Baraboo, Wis.

I have received my Willsie pocket camera, and am well pleased with it.

Arthur Dorman, Sioux City, Iowa.

I recently saw a haul of fish which Alderman Ferris, of this city, made at the Missouri river, with a seine—a barrel and a bag full of fish. He told me, personally, there were over 2,000 fish in the lot. On another trip, to the Dearborn river, he claims to have caught 800 trout in 2 days. Alderman Ferris keeps a restaurant but all truesportsmen will be careful not to eat there, after such exhibitions of swinishness as these.

F. N. E., Helena, Mont.

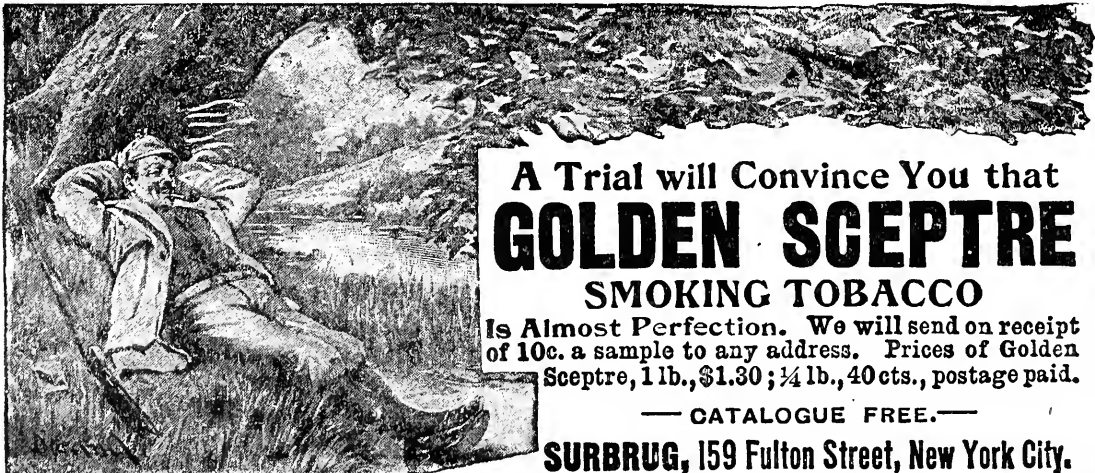

## A Trial will Convince You that GOLDEN SCEPTRE SMOKING TOBACCO

Is Almost Perfection. We will send on receipt of 10c. a sample to any address. Prices of Golden Sceptre, 1 lb., \$1.30; ¼ lb., 40 cts., postage paid.

— CATALOGUE FREE. —

**SURBRUG, 159 Fulton Street, New York City.**

# The Wing

# Piano

STYLE 7

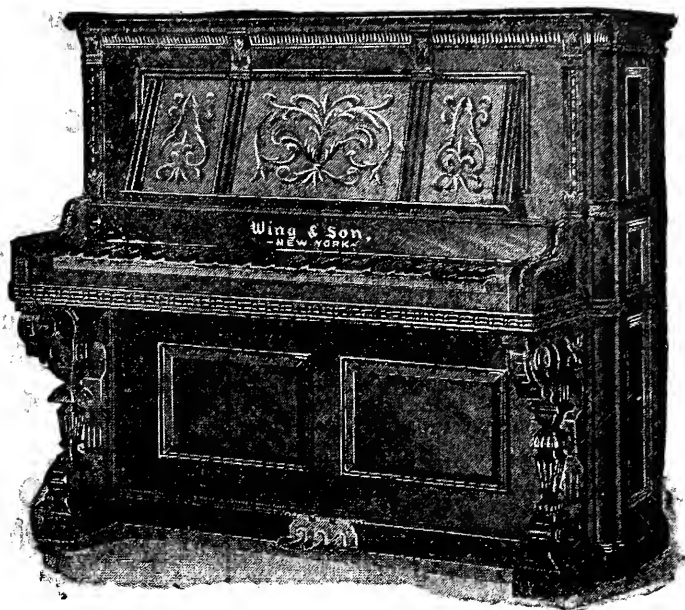

You do not have to pay an extravagant price for a first-class piano



In justice to yourself write for prices of the Wing Piano before you buy

## The Instrumental Attachment

imitates perfectly the tone of the Mandolin, Guitar, Harp, Zither and Banjo, giving the effect of an entire orchestra of these instruments playing in concert with the piano

**SENT ON TRIAL** We will send this piano, or your choice of four other styles, to any part of the United States *On Trial* (all freights paid by us), allow ample time for a thorough examination and trial in the home, and, if the instrument is at all unsatisfactory, we will take it back at our own expense. No conditions are attached to this trial. We ask no advance payment; no deposit. We pay all freights in advance.

**OLD INSTRUMENTS EXCHANGED  
EASY PAYMENTS**

OUR BOOK should be in the hands of every one who intends to buy a piano. It contains many valuable hints and instructions, and tells a great many things every buyer ought to know. We will send it free with our catalogue to any one who writes us.

**WING & SON,** 443 and 445 West 13th St., N. Y. City  
ESTABLISHED 1868

# The Muskoka and Midland Lakes Resorts

Reached only by the

## Grand Trunk Railway System

Is the Paradise for not only hunters, fishermen, and canoeists, but also those in search of health, where comfort and pleasure can be obtained economically.

The woodland and lake scenery would satisfy the most critical tourist.

Camping outfits can be purchased cheaply, or guides, thoroughly acquainted with this region, fully equipped for camping, can be secured readily.

Parties can be furnished with names of guides, and by communicating with them, make all necessary arrangements in advance.

The following fish and game, in season, are to be found in abundance, the variety of which is not surpassed by any other sporting region in the world:

**Fish.**—Bass, pickerel, brook trout, lake trout, whitefish, perch, sunfish, salmon, trout, sturgeon, catfish, herring, and muskalonge.

**Game.**—Deer, partridge, rabbits, pigeons, ducks, geese, plover, bear, woodcock, snipe, grouse, and moose.

**A few of the other Principal Resorts.**—Androscoggin Lakes, the White Mountains, the salmon resorts of Quebec, New Brunswick, and Nova Scotia, Lake St. John region, the River St. Lawrence, the Thousand Islands.

For descriptive book showing routes and rates, apply to M. C. DICKSON, D.P.A., Toronto, Ont.; D. O. PEASE, D.P.A., Montreal, P.Q.; L. R. MORROW, C.P.A., Chicago, Ill.; R. MCC. SMITH, S.P.A., Cincinnati, O.

CHAS. M. HAYS, Gen'l Manager, Montreal, P. Q.      GEO. B. REEVE, Gen. Traffic Manager, Montreal, P. Q.      W. E. DAVIS, G. P. & T. A., Montreal, P. Q.

FRANK P. DWYER, E. P. Agent, 273 Broadway, New York.

# ...To "the" Pleasure Resorts of... Texas and Gulf of Mexico

TAKE



Via CHICAGO, KANSAS CITY, or  
ST. LOUIS

WAGNER BUFFET SLEEPERS  
FREE "KATY" CHAIR CARS

For further information, address

W. S. ST. GEORGE, Gen. East. Agt.  
409 Broadway, New York

# Go See the Geysers Play in Yellowstone Park

For the general public they begin

JUNE 1st

and close

OCTOBER 1st

They don't travel around giving exhibitions—you must go to them.

NORTHERN PACIFIC'S

New Tourist Book describes them.

Send six cents for it.

CHARLES S. FEE

General Passenger Agent  
ST. PAUL, MINN.

## UNEQUALED ATTRACTIONS

ON THE LINE OF THE

# Union Pacific

FOR TOURISTS

It traverses the Grandest Scenery of the Rocky Mountains, and reaches all the Health and Pleasure Resorts of the Mid-Continent.

**Sportsmen** will find in scores of localities along this line game worthy of their skill, such as Bear, Mountain Lion, Coyotes, Elk, Deer, Antelope, Mountain Sheep, Feathered Game of all kinds. And everywhere are Beautiful Streams well stocked with Trout.

For Gun Club Rules, Game Laws, and any information relative to localities for Hunting, or for information in regard to the UNION PACIFIC SYSTEM, call on or address any General or Traveling Agent of this Company.

R. TENBROECK, Gen'l Eastern Agent,  
287 Broadway, New York City

E. DICKINSON, Gen'l Manager,      E. L. LOMAX, Gen'l Pass. & Tkt. Agt.,  
Omaha, Neb.

**BO**  
**BEST LINE**  
 TO  
 Pittsburg  
 Cincinnati  
 St Louis  
 Chicago  
 Indianapolis  
 Toledo

## 20 BOOKS ❄ ❄

ON 20 DIFFERENT SUBJECTS,  
 BUT ALL RELATING TO SOME  
 DELIGHTFUL PHASE OF  
 AMERICAN TRAVEL, VIA  
 "AMERICA'S GREATEST RAIL-  
 ROAD."



ILLUSTRATED CATALOGUE SENT  
 FREE, POST-PAID, ON RECEIPT  
 OF A 1-CENT STAMP BY GEORGE  
 H. DANIELS, GENERAL PASSENGER  
 AGENT, NEW YORK CENTRAL &  
 HUDSON RIVER RAILROAD, GRAND  
 CENTRAL STATION, NEW YORK.

## NEW MODEL REVOLVER

Has important advantages over all other makes. Rebounding Lock, which obviates all liability of accidental discharge when closing, after discharging cylinder. Simple and superior method of holding cylinder to barrel. Can be removed instantly by pressing a catch in front of the cylinder.

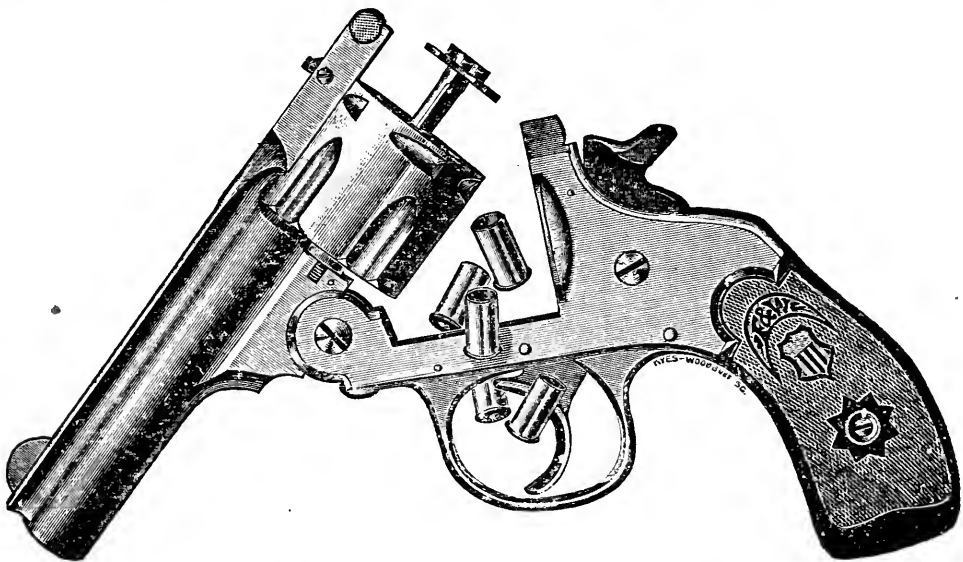

Workmanship unexcelled. All parts interchangeable, and made from drop forgings. Frame is made of cast steel. No malleable iron about it.

SEND FOR CATALOGUE

Mention RECREATION

FOREHAND ARMS CO., Worcester, Mass.

Given as a Premium for 10 Yearly Subscriptions to Recreation



# ALL THE WORLD

OF FISHERMEN ARE BUYING THE

## Bristol Steel Fishing Rods

### WHY ?

Because they are finding out that sun or rain, pleasant weather or stormy, can not affect their utility: They don't rot, warp, "set," break easily, or ever disappoint. Their price—owing to improved and special machinery—is only about one-half the original figure, and, in their present form, the Bristol Steel Fishing Rods are the most practical, sensible, and durable rods on the market.

FULL DESCRIPTION IN CATALOGUE "R"  
SEND FOR IT

## The Horton Manufacturing Co.

BRISTOL, CONN.

For nearly 50 Years the name

**“Davenport”**



has been identified with the manufacture of

**Guns...  
and Rifles**  
+++++

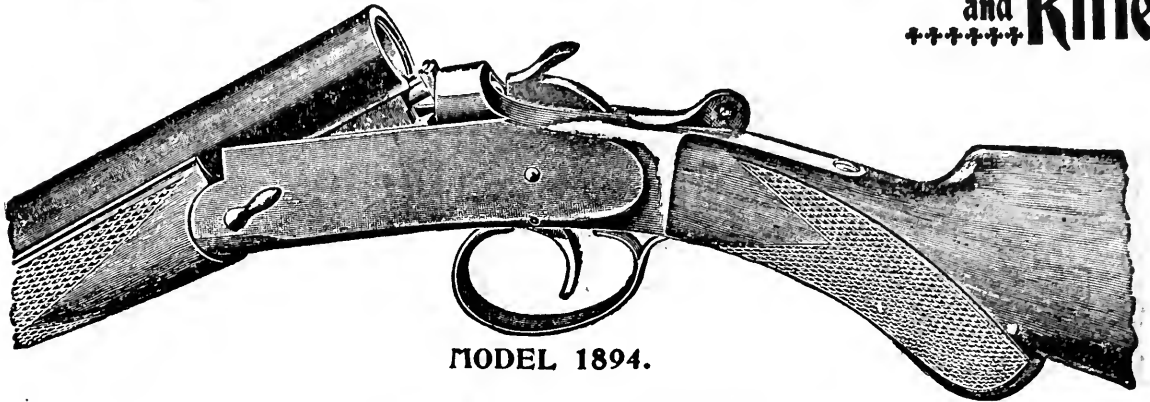

MODEL 1894.

**AUTOMATIC EJECTOR**

Our present line is complete and varied and shows the result of years of experience.

For catalogues and information address

**THE W. H. DAVENPORT FIRE ARMS CO.**

**NORWICH, CONN., U. S. A.**

Mention “RECREATION”

*Ejector Guns  
no longer a  
luxury*

**Good News for Sportsmen**

Lefever Automatic Ejector Guns at a price within the reach of every sportsman.

OUR NEW EJECTOR MOVEMENT

*Has only two pieces: One in the Hammer, One in the Frame.*

We have decided to meet the demand for *medium* price Ejectors, and are now prepared to accept orders for all grades of our hammerless guns fitted with Ejectors.

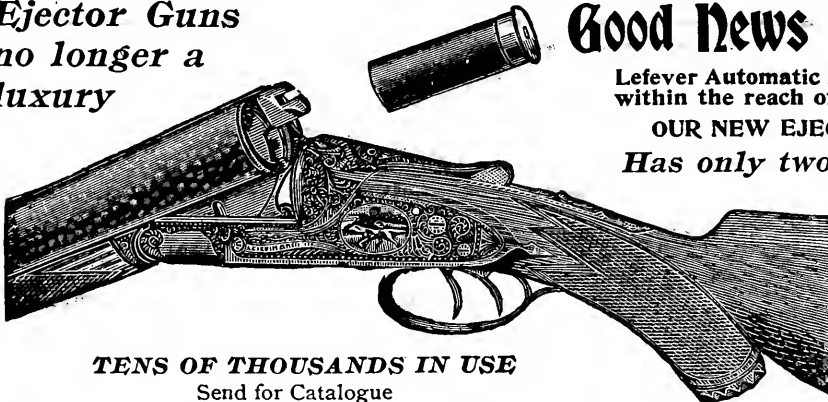

**TENS OF THOUSANDS IN USE**

Send for Catalogue

**LEFEVER ARMS CO. - - Syracuse, N. Y.**

(Mention RECREATION.)

Date,..... 1897.

G. O. SHIELDS,

Editor and Manager of RECREATION, 19 West 24th St., New York:  
Herewith find One Dollar, for which please send me RECREATION  
for one year beginning with..... number.

Name,.....

Remit by P. O. or Express Money Order, or New York Draft.

DETACH THIS, FILL OUT, AND SEND IN.

# New Ithaca Guns

Self compensating,  
taking up wear  
at every point

Bored  
**FOR BLACK AND  
NITRO POWDERS**

Close and Hard Shooting Guns  
at long range a specialty



Price but a little more than one-half that of any other good gun, and warranted in the most positive terms, shooting included

## ITHACA GUN COMPANY, ITHACA, N. Y.

Send for circular  
Mention RECREATION

Manufacturers of fine Hammer  
and Hammerless Guns

FOR FIELD OR FOR TRAP,  
FOR POT HUNTING OR FUN,  
NO SPORTSMAN IS EQUIPPED  
WITHOUT A SYRACUSE GUN

“MORE TRUTH  
THAN POETRY”

### We do not say that SYRACUSE HAMMERLESS GUNS

“Are as Good” as any gun in the market.

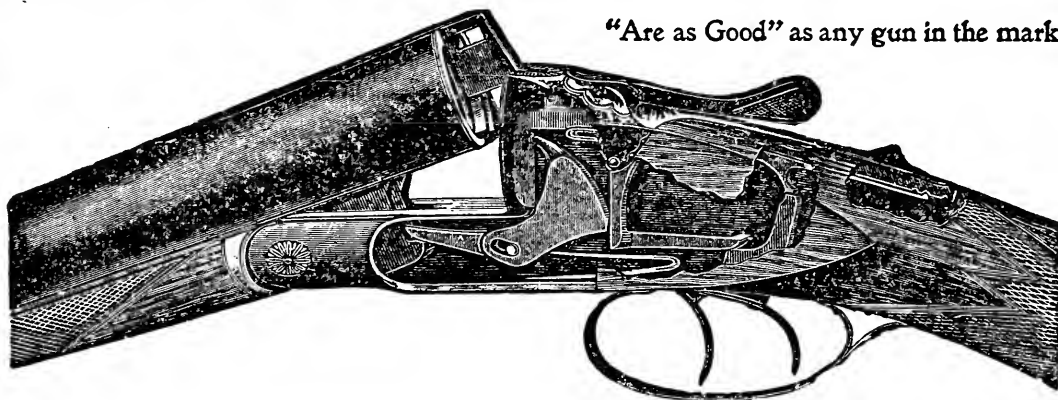

Their simplicity of construction and superiority of finish stamp them “BETTER” for practical all-round work than any gun in the market. The “old, old story” but, nevertheless, substantiated by every man who ever drew a Syracuse to his shoulder.

## SYRACUSE ARMS CO., SYRACUSE, N. Y., U. S. A.

Sole Agents, HERMANN BOKER & CO., 101 Duane Street, New York City



# Forehand Arms Co.'s

EJECTOR AND NON-EJECTOR  
HAMMERLESS DOUBLE GUN



## LATEST MODEL

I received the Forehand gun, in good condition, and am much pleased with it in every particular. It is exactly as I requested. Have killed ducks with it which, my companions said, were out of reach of any shotgun. The subscribers all like RECREATION, which is not strange, by any means.

FRED. D. JONES, Fort Townsend, Wash.

Read what men  
say of the  
**Forehand**  
who are using it

**We get  
Thousands  
of such  
Testimonials—  
all Unsolicited**

By reason of your generosity, I am the owner of a fine double-barrel hammerless shot gun, received a few days ago from the Forehand Arms Co., and sent me as a premium for 35 subscriptions. Have been out with it two or three times and am perfectly satisfied with its shooting qualities. It shoots strong and makes a good pattern. It is greatly admired by all the sportsmen here, and they wonder how you can give such liberal premiums with so good a magazine as RECREATION.

F. C. DOANE, Knoxville, Pa.

**"WHAT EVERYONE SAYS MUST BE SO"**

*We challenge competition in Beauty, Workmanship, Simplicity of Mechanism, Shooting Qualities and Price. We target all our guns with nitro powder. For Catalogue, address*

**FOREHAND ARMS CO., WORCESTER, MASS.**

# DOG HAMPERS

FOR SHIPPING DOGS OR CATS BY RAIL

5 SIZES, \$6.00 TO \$15.00

(RATTAN OR WICKER)

Order through your Dealer and send for Catalogue to

**SPRATTS PATENT LIMITED**

245 EAST 56TH STREET, NEW YORK CITY

**DOG AND POULTRY  
SUPPLIES**

## Our Specialties IN FALL SPORTING GOODS .... ARE ....

CHARLES DALY Hammerless Guns

CHARLES DALY Three-Barrel Hammer and Hammerless Guns  
Price \$90 to \$375



PENN ARMS CO. A New American-made Hammerless Gun for  
\$25.

WALSRODE Smokeless Powder. Gaining in Popularity Every Day.  
Send \$2 for 100 12-Gauge Loaded Shells, 29 grains, 1 1-8  
Chilled Shot.

List of Odd and Second-Hand Guns Ready for Mailing

**SCHOVERLING, DALY & GALES**

General Sporting Goods Dealers

.....302 Broadway, New York

# MARLIN DOUBLE ACTION REVOLVERS

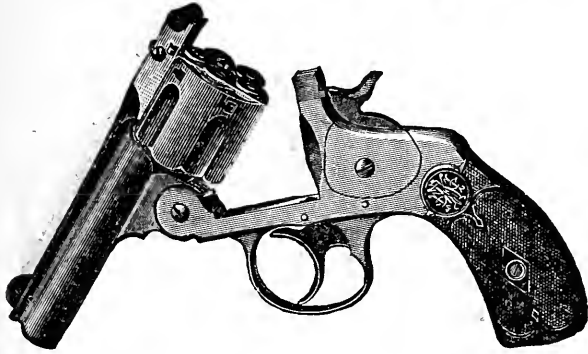

All Parts of   
DROP FORGED STEEL

Perfect in Finish

Unsurpassed  
in Accuracy

MADE IN 32 AND 38 CALIBRES, WITH 3¼ INCH BARREL  
Blued or Nickel Finish

Send for  
Catalogue

The Marlin Fire Arms Co., New Haven, Conn.

Given as a Premium for 10 Subscriptions to Recreation

## MR. FRED GILBERT

In the Contest for the

**E. C. Cup**

Made the following score:

**48 out of 50**

UNKNOWN ANGLES

**48 out of 50**

EXPERT RULES

**46 out of 50**

DOUBLES

HE USED

**DuPont  
Smokeless  
Powder**

**E. I. DUPONT DE NEMOURS & CO.**

WILMINGTON, DEL.



# What's the Use

of walking when you  
can get a first-class, high-  
grade bicycle for nothing?

## How?

By getting 75 subscriptions for  
**Recreation**

If you live in a town of 3,000  
or more, and if you are a hustler  
you can get these in 2 days.

I can give you the names of 20  
people who did this in 1896, and  
who now have their wheels.

Write for particulars.

## RECREATION

19 West 24th Street  
New York



I have some fine English setter puppies, sired by Royal Gladstone II, he by Royal Prince II, he by Champion Sir Allister, he by Ch. Tam O'Shanter. These puppies are all blue beltons. Their mother was bred at Washington, Iowa, breeding unknown, but she is a No. 1 hunting dog. I have hunted her in several States, and she has always won high honors. She whelped 10 puppies May 9th, and 6 were sold here, at \$5 and \$10. I have 2 bitches and 2 dogs left.

M. C. Mourey, Newton, Kans.

**For Sale:** Winchester repeating shot gun: sliding forearm movement, model 1893, 12 gauge, full choke, good as new; used on one shooting trip only; \$14.00.

H. Pemberton, Jr.,  
1008 Clinton St.,  
Philadelphia, Pa.

**For sale,** 45-90 or 45-70 Winchester rifle, 1886 model, both fine shooters and practically new, for \$15. Have Lyman front and rear sights. Or, for \$12 with regular open sights. M. K. Barnum, No. Platte, Neb.

**To Trade:** A salt water rod; cost \$7.50, used only once; for a 22 rifle, or anything of equal value.

Homer Haxby, 229 S. Main St.,  
Jacksonville, Ill.

## BOOKS BY C. O. SHIELDS (COQUINA)

### THE BIG GAME OF NORTH AMERICA

Its Habits, Habitat, Haunts and Characteristics. How, When and Where to Hunt it. 8vo, 600 pages, 80 illustrations. Cloth, \$3.50; Half Morocco, \$5.00; Full Morocco, \$6.50.

### CRUISE IN THE CASCADES

A Narrative of Travel, Exploration, Amateur Photography, Hunting and Fishing, with Special Chapters on Hunting the Grizzly Bear, the Buffalo, Elk, Antelope, Rocky Mountain Goat, and Deer; also on Trout in the Rocky Mountains; on a Montana Roundup; Life Among the Cowboys, etc. 12mo, 300 pages, 75 illustrations. Cloth, \$2; Half Morocco, \$3.

### AMERICAN GAME FISHES

How, When and Where to Angle for them. 8vo, 400 pages, 50 illustrations. Cloth, \$2.50; Half Morocco, \$4.

### HUNTING IN THE GREAT WEST

(*Rustlings in the Rockies*)  
Hunting and Fishing Sketches by Mountain and Stream. 12mo, cloth. Over 300 pages. Illustrated. Price, 75 cents.

### THE AMERICAN BOOK OF THE DOG

The Origin, Development, Special Characteristics, Utility, Breeding, Training, Diseases and Kennel Management of all Breeds of Dogs. 8vo, 650 pages, 100 illustrations. Cloth, \$3.50; Half Morocco, \$5; Full Morocco, \$6.50.

### CAMPING AND CAMP OUTFITS

A Manual of Instruction for Young and Old Sportsmen. 12mo, 200 pages, 30 illustrations. Cloth, \$1.25.

### THE BATTLE OF THE BIG HOLE

History of General Gibbon's Engagement with the Nez Perce Indians in the Big Hole Basin, Montana, August 9, 1877. 12mo, 150 pages. Profusely illustrated. Cloth, \$1.

*These books will be mailed, post-paid, on receipt of price, by the author.*

**G. O. SHIELDS**

19 West 24th St., New York

# Some Rare Oppor- tunities

These goods are all new, and will be shipped direct from factory. Prices named are those at which manufacturers and dealers usually sell. Here is a good chance to get

**A BOOK  
A GUN  
A CAMERA  
A TYPEWRITER  
A BICYCLE**

**FREE OF COST**

Subscriptions need not all be sent at once. They can be sent in installments as taken and credit will be given on account. When the required number is obtained the premium earned will be shipped.

**“Recreation”**

19 West 24th Street  
New York

## To any person sending me

- TWO yearly subscriptions to RECREATION at \$1 each, I will send a copy of *Hunting in the Great West*, paper; or a Czar Camera, listed at \$1.
- THREE subscriptions at \$1 each, a copy of *The Battle of the Big Hole*, cloth.
- FOUR subscriptions at \$1 each, a copy of *Camping and Camping Outfits*, cloth.
- FIVE subscriptions at \$1 each, a copy of *Cruising in the Cascades*, cloth; or a Will-sie Pocket Camera, valued at \$5. It makes a picture  $2\frac{1}{8} \times 2\frac{3}{8}$  inches and can be loaded with 24 cut films.
- SIX subscriptions at \$1 each, a copy of *American Game Fishes*, cloth; or a Baby Hawkeye Camera, listed at \$6.
- SEVEN subscriptions at \$1 each, a copy of *The Big Game of North America*, or of *The American Book of the Dog*, cloth; or a Cyclone Camera, listed at \$10.
- EIGHT subscriptions at \$1 each, a Pocket Kodak, made by the Eastman Kodak Co., and valued at \$5.
- TEN subscriptions at \$1 each, a single-shot Davenport Rifle; or a Fishing rod, or a Yawman and Erbe Automatic Reel, worth \$9; or a Kenwood Sleeping Bag, worth \$10; or a No. 10 Gramophone, worth \$10.
- TWELVE subscriptions at \$1 each, a Manhattan Improved Hand Camera, made by the Manhattan Optical Co., and valued at \$12.
- FIFTEEN subscriptions at \$1 each, a Davenport Single-barrel, breech-loading Shotgun, worth \$15; or a Camera, worth \$6 to \$10; or a Kenwood Sleeping Bag, complete with canvas cover, worth \$16; or a No. 2 Bullet Camera, loaded, worth \$10.
- TWENTY subscriptions at \$1 each, a 14-karat Gold Hunting-case Watch, with Elgin Movement, worth \$20; or a Marlin Repeating Rifle, listed at \$20; or an Improved Night-hawk Hand Camera, made by the Manhattan Optical Co., and valued at \$25; or a No. 4 Bullseye Camera, made by the Eastman Kodak Co., and worth \$12.
- TWENTY-FIVE subscriptions at \$1 each, a No. 4 Bullet Camera, made by the Eastman Kodak Co., and worth \$18; or a Gramophone, valued at \$25; or an Australian Mosquito Tent valued at \$25.
- THIRTY-FIVE subscriptions at \$1 each, a Forehand or a Syracuse Double-barrel Hammerless Breech-loading Shotgun, worth \$35; or a Camera, worth \$25.
- FORTY subscriptions at \$1 each, a Camera, worth \$30.
- FIFTY subscriptions at \$1 each, a Marlin Rifle, with fancy curled walnut stock, pistol grip, checkered four-end, handsomely engraved, half octagon, half magazine, with take down, listed at \$50.
- SEVENTY-FIVE subscriptions at \$1 each, a Safety Bicycle, worth \$85 to \$100; or a Bo-peep Camera, for 5x7 plates, made by the Manhattan Optical Co., and valued at \$90.
- ONE HUNDRED subscriptions at \$1 each, a fine Lefever Hammerless Gun, worth \$85; or a Bo-peep Camera, for  $6\frac{1}{2} \times 8\frac{1}{2}$  plates, made by the Manhattan Optical Co., and valued at \$120.



The Athlete  
is best sustained  
by food which gives  
the greatest strength  
while not overtaxing  
the stomach.

*Vigoral*  
is  
both meat and drink  
and is stimulating  
and nourishing.

It is a  
foe to fatigue  
and in it the athlete  
and brain-worker will  
find an ideal condensed  
food, palatable and  
strength-giving.



To be had at all places of refreshment and of druggists and grocers everywhere.  
The little pamphlet "Various Views on Vigoral" is mailed for the asking.

Armour & Company  
Chicago.

# For Fall Shooting

USE \_\_\_\_\_

## U.M.C. LOADED SHELLS

“New Club,” loaded with Black Powder  
“Smokeless,” loaded with Nitro Powders

WADDING AND CRIMPING ARE THE  
RESULT OF CARE AND EXPERIENCE

SEND FOR CATALOGUE OF ALL THE COMBINATIONS OF LOAD

THE UNION METALLIC CARTRIDGE CO.  
BRIDGEPORT, CONN.

313 Broadway, New York

425 Market Street, San Francisco

## Is this Name Familiar?

### REMINGTON HAMMERLESS

AUTOMATIC AND  
NON-AUTOMATIC  
EJECTORS

GUARANTEED FOR  
NITRO POWDERS

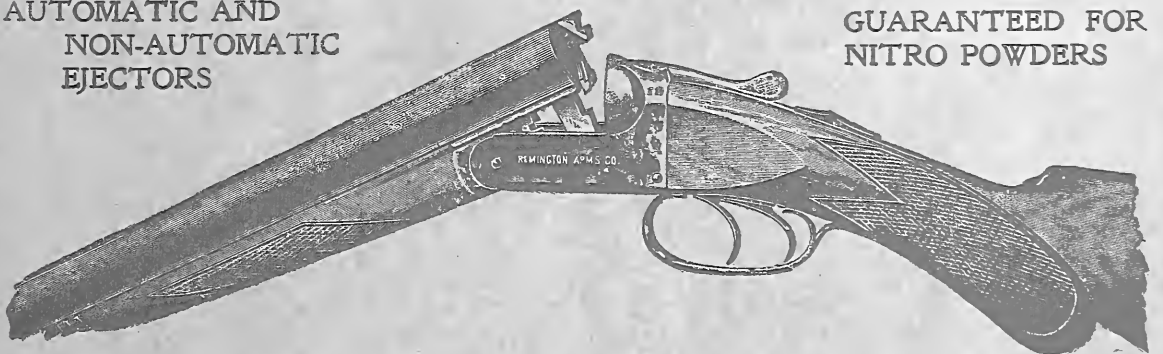

STRONG ——— SIMPLE ——— STABLE

You Need a Good Gun for Your Fall Shooting

SEND FOR  
CATALOGUE

REMINGTON ARMS COMPANY  
ILION, N. Y.

313-315  
BROADWAY  
NEW YORK



"More than a Million in Use."

# WINCHESTER RIFLES

Adapted to All Kinds  
of Shooting

UNEQUALLED FOR

Accuracy, Penetration, Rapidity And Range

TEN DIFFERENT MODELS

ALL DESIRABLE CALIBERS FROM .22 TO .50

## WINCHESTER AMMUNITION

USED BY EVERYONE. SOLD EVERYWHERE.

WINCHESTER REPEATING ARMS CO., NEW HAVEN, CT.  
Send For Catalogue



**TURN ON THE LIGHT!** Compare the maker's  
COST of equipment on a  
high grade Clipper Special with the cheapest possible to use.

**Cost of Special Clipper Equipment against CHEAP WHEEL.**

|            |   |      |         |    |         |   |          |    |        |
|------------|---|------|---------|----|---------|---|----------|----|--------|
| Saddles    | @ | from | \$ 1.75 | to | \$ 2.00 | " | \$ .55   | to | \$ .85 |
| Chains     | " | "    | 1.20    | "  | 1.60    | " | .40      | "  | .48    |
| Tires      | " | "    | 6.00    | "  | 10.00   | " | 1.75     | "  | 4.50   |
| Rims       | " | "    | .70     | "  | .90     | " | .28      | "  | .40    |
| Tool Bags  | " | "    | .25     | "  | .40     | " | .07      | "  | .12    |
| Pedals     | " | "    | 1.50    | "  | 1.75    | " | .45      | "  | .65    |
| Steel Bars | " | "    | 1.50    | "  | 2.00    | " | Wood .30 | "  | .60    |
| Grips      | " | "    | .18     | "  | .28     | " | .09      | "  | .11    |

\$13.08 to \$18.93 against \$3.89 to \$7.71

Here's figures. They are facts. We can prove them, so can you. Be your own judge. But please DON'T compare a high grade Clipper with a bicycle that costs from \$9.00 to \$15.00 less for equipment only, and all other cost in proportion. The WORTH of a bicycle depends upon the cost of material and the care with which it is made.

Clipper Specials ARE expensive to make and equip. They are WORTH the price you pay.

Made by "THE CLIPPER PEOPLE." Grand Rapids, Mich.

P. 42-98.





# RECREATION

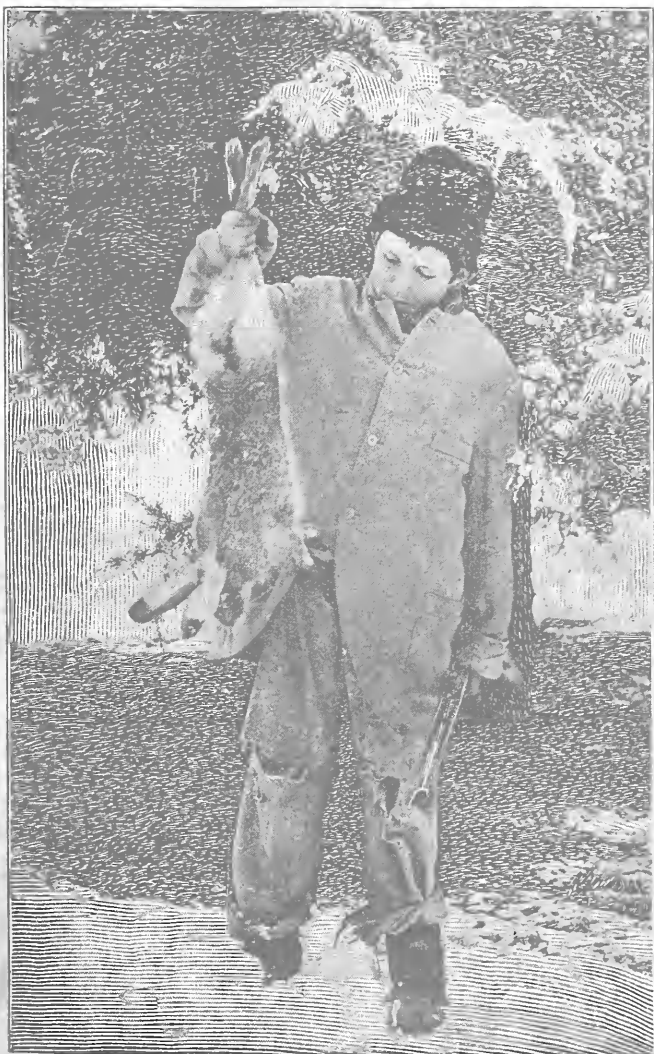
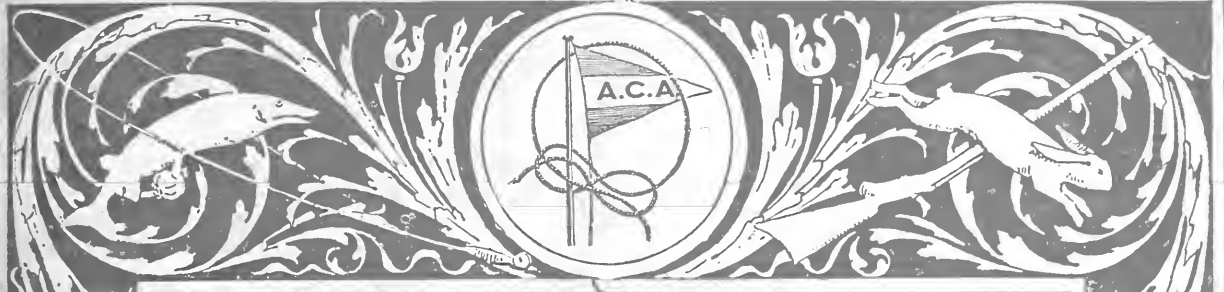

AMATEUR PHOTO BY G. H. FAIBYER  
HIS FIRST JACK RABBIT

PUBLISHED BY G. O. SHIELDS (COQUINA)  
19 WEST 24TH ST. NEW YORK

OFFICIAL ORGAN OF THE AMERICAN CANOE ASSOCIATION

HAROLD BROWN

Actual Paid and Proven Circulation, 44,000 Copies a Month

SINGING THE PRAISES  
OF EGG WHITE SOAP



*Dr. Raub's*  
*Egg White*  
*Soap*

## DR. RAUB'S Egg White Soap

MADE WITH THE WHITES OF  
EGGS AND SWEET CREAM

### Nothing Else Like It

Soothing to face and hands; makes the skin like velvet, the ingredients being the sweetest and purest obtainable, and selected under the direction of a noted skin specialist.

Leaves a sweet, refined odor, best French perfumes being used; and, owing to its solidity, will outlast two cakes of ordinary soap.

Sold at the popular price of **10 cents** by dealers everywhere.

**FREE**

sample cake to any one sending name and address and 2c. stamp for postage.

Full size cake sent on receipt of 10 cents. Send us your dealer's name and we will see that he keeps it. Don't fail to try it.

One Doz. Cakes \$1.00, Express Paid.

**CHARLES F. MILLER,** LANCASTER, PA., U.S.A.

NEW YORK, 73 Murray Street.

BOSTON, 129 State Street.

PHILADELPHIA, 45 N. Front Street.



STOP THE GAME!!! KILL THE UMPIRE?

**NO!**

Simply build a PAGE FENCE around the premises and you've got 'em. No obstruction to the view. Holds Buffalo, Deer, Elk, anything.

Write for Particulars . . . .

**PAGE WOVEN WIRE FENCE CO.**

ADRIAN, MICH.

# RECREATION

Copyright, December, 1896, by G. O. Shields

A Monthly Magazine Devoted to Everything the Name Implies

\$1.00 A YEAR.  
10 CENTS A COPY.

G. O. SHIELDS (COQUINA),  
Editor and Manager.

19 WEST 24TH STREET,  
NEW YORK.

## CONTENTS OF THIS NUMBER

|                                                                                 | PAGE                                                             |
|---------------------------------------------------------------------------------|------------------------------------------------------------------|
| "When the Wind Began to Blow Again I Would Sit Down and Slide in the Snow"..... | Frontispiece                                                     |
| Hunting Mountain Sheep in a Snow-storm. Illustrated.....                        | CAPT. S. A. LAWSON 339                                           |
| Speed Skating.....                                                              | A. M. ANDERSON 341                                               |
| Deer in the Coast Range.....                                                    | DANIEL ARROWSMITH 343                                            |
| Memories of a Quail Hunt.....                                                   | G. E. B. 345                                                     |
| In the Shin-Oaks of Texas.....                                                  | JOHN C. CASPARIS 347                                             |
| Shooting in Albania.....                                                        | D. G. CARY-ELWES, F. S. A. 349                                   |
| The Chiricahu Hounds.....                                                       | LT. A. F. CAPRON, U. S. A. 351                                   |
| The Indian and the Deer.....                                                    | OLD SILVER TIP 353                                               |
| Grouse in New Hampshire.....                                                    | OLD BILL 355                                                     |
| In the Bitter Root Mountains. Illustrated.....                                  | H. S. GARFIELD, M. D. 357                                        |
| In Early Days.....                                                              | GEO. HAYDEN 359                                                  |
| A Raid by the Kiowas.....                                                       | T. C. AUSTIN 361                                                 |
| A Grizzly and a Muzzle-loader.....                                              | A. PLUMMER 363                                                   |
| Notes on Making Bird Skins.....                                                 | F. E. FLEMING 365                                                |
| Foxes in the Big Swamp.....                                                     | C. P. FRANKLIN 367                                               |
| Grandfather's Wish. (Poem).....                                                 | J. C. BRIGGS 368                                                 |
| Elkland, III. Illustrated.....                                                  | ERNEST SETON THOMPSON 369                                        |
| Adrift on an Ice Floe.....                                                      | PETER AWICK 372                                                  |
| "In Autumn Time." (Poem).....                                                   | "OLANCHA" 374                                                    |
| The Wolf Question.....                                                          | Hon. B. B. BROOKS, Hon. HORACE BEACH, OTTO FRANC, and others 375 |
| While Sitting in the Blind. (Poem).....                                         | FRANK C. RIEHL 379                                               |
| On the Chilkat Pass.....                                                        | HARRY L. SUYDAM 412                                              |
| From the Game Fields.....                                                       | 380                                                              |
| Fish and Fishing.....                                                           | 393                                                              |
| Guns and Ammunition.....                                                        | 397                                                              |
| Natural History.....                                                            | 403                                                              |
| Editor's Corner.....                                                            | 406                                                              |
| Bicycling.....                                                                  | 407                                                              |
| Canoeing.....                                                                   | 410                                                              |
| Announcements.....                                                              | 411                                                              |
| Puzzle Corner.....                                                              | 411                                                              |
| Book Notices.....                                                               | 413                                                              |
| Publisher's Department.....                                                     | 415                                                              |
| Amateur Photography.....                                                        | 419                                                              |

Entered as Second-Class Matter at New York Post-Office, Oct. 17, 1894.

All you ever need—

A  
Good  
Dentist  
and



1857—1897.

Why?

Because a good dentist and a good dentifrice are indispensable in the proper care of the teeth.

A sample of Sozodont for three cents.  
Address P. O. Box 247, New York City.

HALL & RUCKEL,  
NEW YORK. PROPRIETORS. LONDON.

# SEN-SEN

THROAT EASE and  
BREATH PERFUME ~

Good for Old and Young

At all dealers or  
sent on receipt of  
5 cents in stamps

SEN-SEN Co,  
Dept. G.  
ROCHESTER, N. Y.

# GAS ENGINE & POWER CO.

and **CHARLES L. SEABURY & CO.,** Builders of

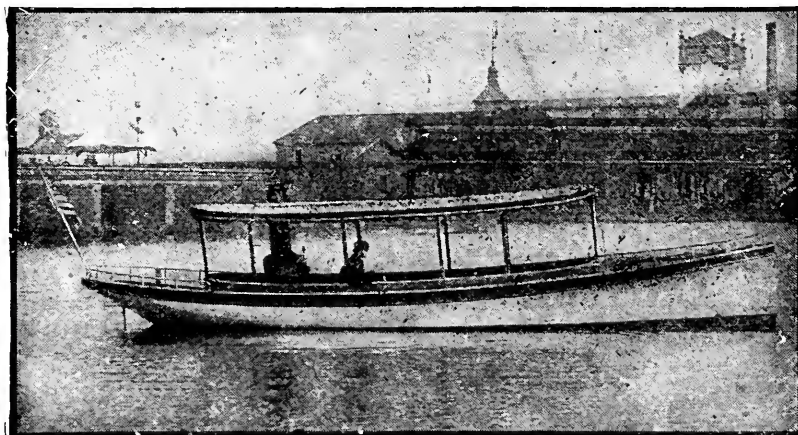

## The Only Naphtha ..Launch..

High-class Steam Yachts, Sail Yachts, Electric Launches, Dinghys, Gigs and Yacht Tenders, Seabury's Water Tube Boilers, Marine Engines

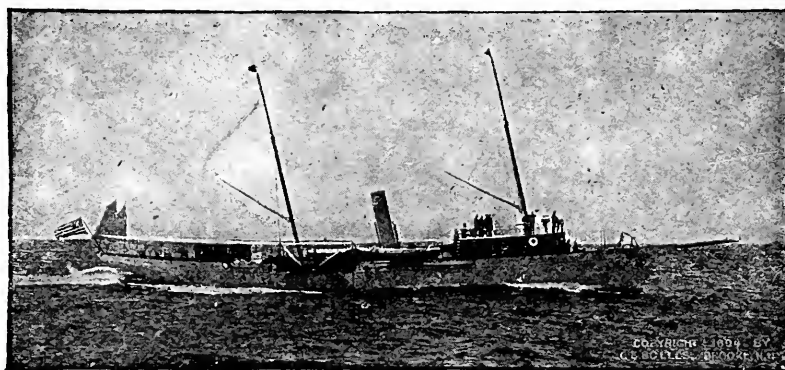

Storage Basin and Ship's ways. Overhauling of all kinds promptly done. Charters and Insurance. Boats bought and sold on commission . . . . .

CORRESPONDENCE  
SOLICITED . . . . .

Send ten cents in stamps for catalogues, to downtown office,  
50 BROADWAY, or to factory at

**MORRIS HEIGHTS, New York City**



BEFORE

# Savage

## THE Big-Game Killer

Leg of an animal before and after being shot with an expanding bullet cartridge fired from a .303 Caliber . . .

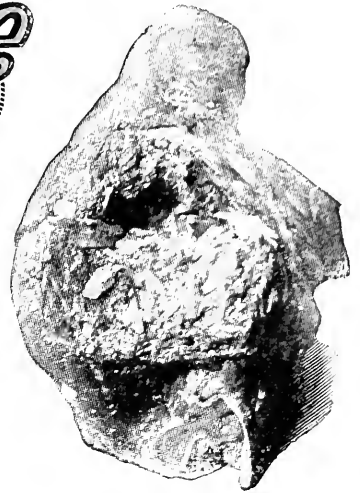

AFTER

## Savage Repeating Rifle



BEFORE

THE BULLET



AFTER

Catalogue on Application.

SAVAGE REPEATING ARMS CO., Utica, N. Y.

*There's nothing so good for the Baby's Skin as*

## Carbolated Talcum Powder



See that your druggist gives you

### Fehr's

It's not only the original (it has been commended by physicians for nearly forty years), but it is put up in paste board boxes.

**BEWARE!** of Talcum Powders put up in tin boxes. Scientific analysis shows there is danger of lead poisoning

Two kinds, plain and perfumed. All druggists keep it. Samples free by mail.

**JULIUS FEHR, Pharmacist**  
Hoboken, N. J.

*"Adds 50% to the relish of any meal of which it forms a part."*



If your grocer cannot supply you, write us for priced catalog and souvenir, descriptive of our full line Canned Fruits, Vegetables, Meats, Preserves, Jams, Jellies, etc.

TAKE A.....

# Marlin Repeater

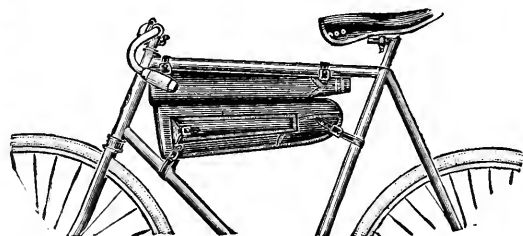

MODEL 1897

on your

.... BICYCLE

We make it with 16-inch barrel, expressly to fit your diamond frame  
Weight only 5 lbs. We have the proper covers also.

This 22-  
Calibre  
Repeater



is

Universally

Conceded

to be THE BEST

BECAUSE....



Cut Showing Rifle Apart



One rifle uses 22 short, 22 long, and 22 long rifle cartridges

The receiver is made of our "Special Smokeless Steel"

The working parts are all of crucible tool steel

The inside is finished and polished as well as the outside

The breech-bolt takes out so you can clean your barrel

The side ejection is a good thing. Ballard barrels

shoot straight

The rifling is to a rifle what choke is to a shot gun  
Good deep rifling is one reason why they shoot harder

EASY TO CLEAN

TAPER BARRELS

ADJUSTABLE SIGHTS

We will mail to any address, free, a 192-page book (just out) which is a veritable mine of information to a sportsman

Send stamps, to pay postage, to

## THE MARLIN FIRE ARMS CO.

Mention RECREATION.

New Haven, Conn.

# The Model 1893

is the rifle using the 30-30 Smokeless Cartridge. This cartridge as made for our rifle is loaded with 32 grains of Military Smokeless Powder, giving a velocity of 2,000 feet per second, a full 2,000, not 100 or so less. This, with our flat pointed bullet, makes as accurate a 30 calibre cartridge as can be loaded, and also one without a superior for hunting purposes.

## THESE ARE THE FACTORY CARTRIDGES



Full Metal Cased Bullet  
For Extreme Penetration

Soft Pointed Bullet  
(For Hunting Use)



Six grains of  
smokeless powder  
100-grain  
bullet



For Short Ranges

The Barrel and Action of this rifle are made of our

## Special Smokeless Steel

guaranteed to stand the highest pressure. We also use this steel in all the rest of our Model 1893 Rifles, viz., 25-36 Smokeless, 32-40 and 38 55, and also in the Model 1895 taking the 38-56, 40 and 45 calibre cartridges. We are determined to have our rifles just as strong and safe as good material can make an arm.

Our new catalogue is a veritable encyclopaedia of information regarding rifles, ammunition, etc. Free for the asking, but stamps will help pay postage.

## THE MARLIN FIRE ARMS CO.

New Haven, Conn.

Mention RECREATION.



THEODORE B. STARR

206 Fifth Avenue Madison Square  
NEW YORK

This house solicits the opportunity to submit special  
designs for prizes for all land and water sports

Among recent orders have been

THE SANFORD CUP  
THE LENOX CUP (Golf)  
THE ARDSLEY CUP (Intercollegiate Golf)  
THE STIRRUP CUP  
For Gentleman Riders, Coney Island, 1897

# MARLIN DOUBLE ACTION REVOLVERS



All Parts of   
DROP FORGED STEEL

Perfect in Finish

Unsurpassed  
in Accuracy

MADE IN 32 AND 38 CALIBRES, WITH 3¼ INCH BARREL

Blued or Nickel Finish

Send for  
Catalogue

The Marlin Fire Arms Co., New Haven, Conn.

Given as a Premium for 10 Subscriptions to Recreation





Every Woman Interested in Fancy-Work

Should have a copy of

*Corticelli* Home Needle-work

For 1898 Price 10c.

*Suggestions for Christmas Needlework*

Special New Patterns by the best designers in this country for Tea Cloths, Center-pieces, Doilies, and Photograph Frames.

27 Colored Flower Plates

REPRODUCED IN NATURAL COLORS OF THE FLOWERS

These show just how to embroider all the popular flowers, giving the colors of silk to use for each, and just how to shade them perfectly. *A great help for beginners.*

The book is "up-to-date" in every particular. 125 pages. Over 100 illustrations. All the new Embroidery Stitches described and illustrated. Also rules for knitting bicycle and golf stockings. The Colored Plates alone are worth the price of the book.

Send us 10 cents. Write to-day.

ADDRESS

NONOTUCK SILK COMPANY  
255 Bridge Street, Florence, Mass.

**A SALESMAN**  
of the  
**HARDEFOLD**  
**HYGIENIC**  
**UNDERWEAR**  
is met by this query:

Why this garment is double!  
Yes, that is the characteristic feature of the  
**HARDEFOLD**  
goods. They are made two-fold throughout, which creates an inter-air space and makes them the only genuine sanitary underwear manufactured. The two thicknesses serve to protect the wearer from sudden chills or draughts.

There is no irritation to the wearer because the interior of the garment is as smooth as the exterior, besides they won't shrink in laundering.

Over eleven hundred physicians, representing every State and Territory in the Union, have united in testifying to the sanitary excellence of the HARDEFOLD system of underclothing. Two or more thin fabrics are lighter, warmer and in every way better than heavy single fabrics.

For illustrated catalogue, address  
**HARDEFOLD FABRIC CO.,**  
TROY, N. Y.

**ROOT'S**  
**Camel**  
**Hair**  
**Underwear**

Made only from Finest Fleeces, clipped from the Living Sheep, Lamb or Camel.  
A soft but effectual armor against the climate, the best security against Grippe, Colds and Rheumatism. Perfect in fit and workmanship. Ask your dealer for it. Every garment stamped "Root's Tivoli Standard Underwear." Write for illustrated catalogue.  
ROOT MFG. CO., No. 1 Greene St., N. Y.

**ROOT'S**  
**Natural**  
**Wool**  
**Underwear**

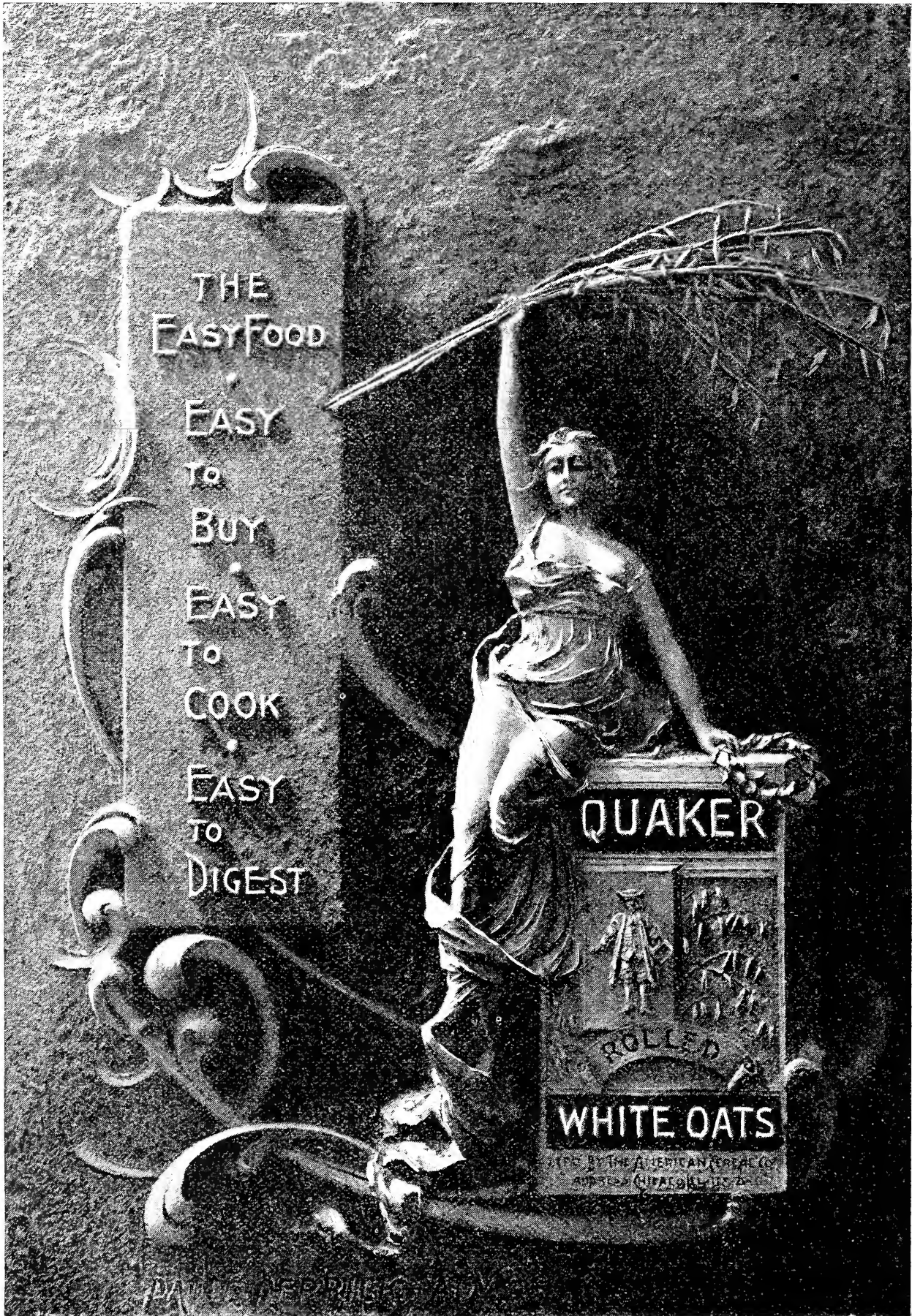

*Ceres, fair goddess of the harvest fields,  
 Now to the world her choicest treasure yields.*

**AT ALL GROCERS IN 2-LB. PACKAGES ONLY.**

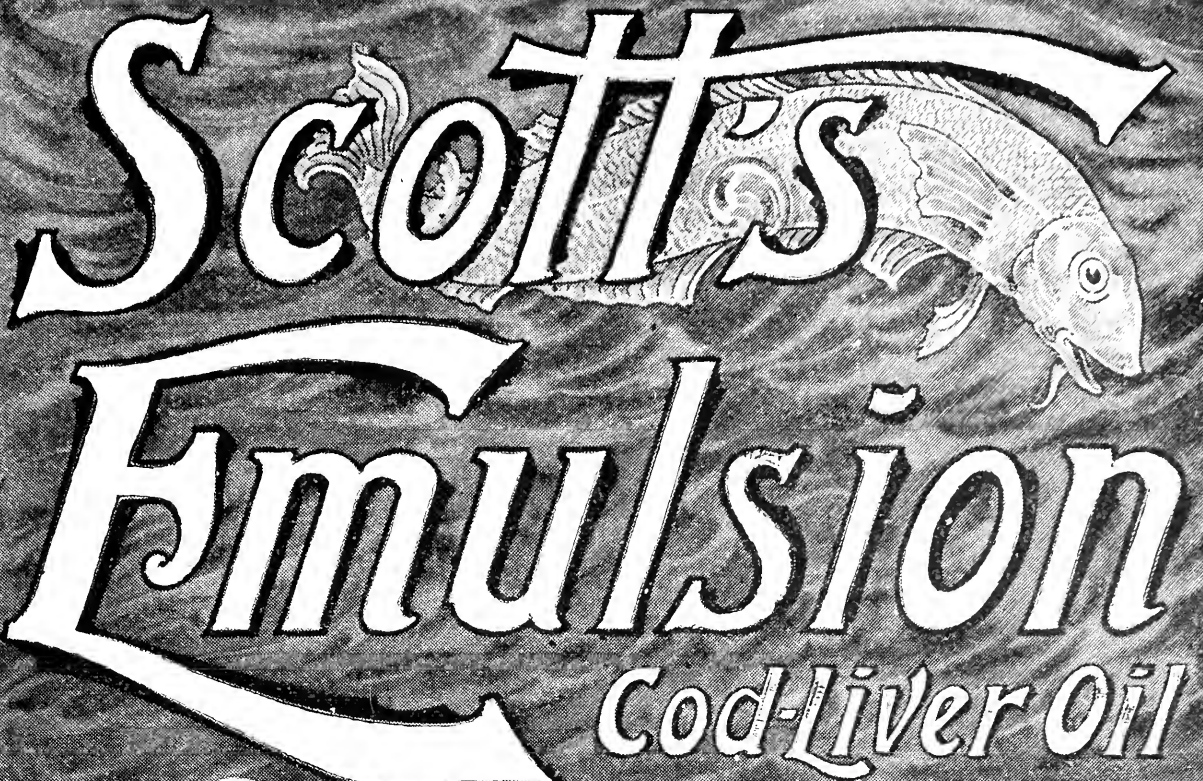

# Scott's

# Emulsion

## Cod-Liver Oil

## WHAT IS SCOTT'S EMULSION?

It is a strengthening food and tonic, remarkable in its flesh-forming properties. It contains Cod-Liver Oil emulsified or partially digested, combined with the well-known and highly prized Hypophosphites of Lime and Soda, so that their potency is materially increased.

## What Will It Do?

It will arrest loss of flesh and restore to a normal condition the infant, the child and the adult. It will enrich the blood of the anemic; will stop the cough, heal the irritation of the throat and lungs, and cure incipient consumption. We make this statement because the experience of twenty-five years has proven it in tens of thousands of cases.

*Be sure you get SCOTT'S Emulsion.*

50c. and \$1.00, all druggists.

SCOTT & BOWNE, Chemists, New York.



# THE "ONEITA"

PAT. APL, 25<sup>TH</sup> 1893.

## Elastic Ribbed UNION SUITS

are complete undergarments, covering the entire body like an additional skin. Perfectly elastic, fitting like a glove, but softly and without pressure. No buttons down the front. Made for Men, Women, and Young People. Most convenient to put on or off, being entered at the top and drawn on like trousers. With no other kind of underwear can ladies obtain such perfect fit for dresses or wear comfortably so small a corset.

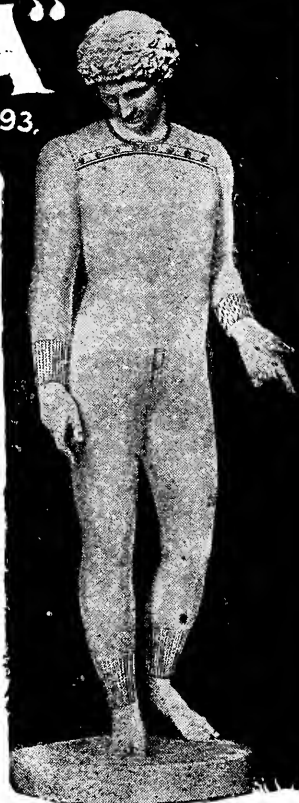

ONEITA KNITTING MILLS,

Send for illustrated booklet.  
ADDRESS DEPT. L

Office: No. 1 Greene St., N. Y.

# Popular Pease Pianos

NEARLY 60,000 IN USE

\*\*\*  
*Unequaled  
in  
Tone*  
\*\*\*

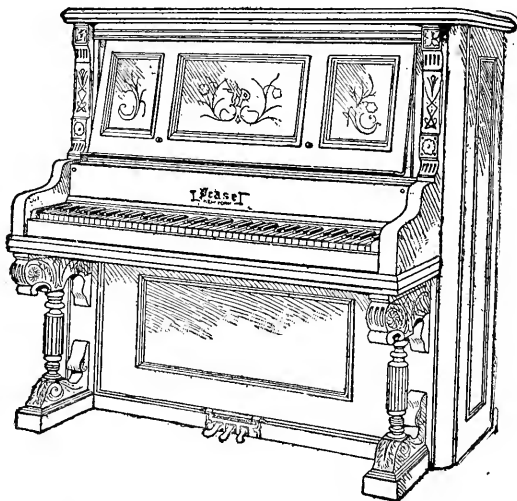

\*\*\*  
*Beautiful  
in  
Finish*  
\*\*\*

SEND FOR SOUVENIR CARD PIANO—FREE

PEASE PIANO CO.

316-322 West 43d Street  
New York City

# MENNEN'S

## BORATED TALCUM



TOILET  
POWDER  
AFTER  
BATHING

# MENNEN'S

BORATED TALCUM

## Toilet Powder

Approved by Highest Medical Authorities and Nurses as a perfect Sanitary Toilet preparation for infants and adults.

WRITE FOR FREE SAMPLE  
(Name RECREATION.)

Get MENNEN'S (the only genuine)

REFUSE ALL OTHER POWDERS, WHICH ARE LIABLE TO DO HARM.

Positively relieves Prickly Heat, Perspiration, Nettle Rash, Chapped Skin, Sunburn, etc., etc. Banishes all odor. Removes Blotches, Pimples, and Tan. Makes the skin smooth and healthy. Delightful after shaving. Sold by druggists or mailed for **25 cents**, to any address.

GERHARD MENNEN CO., 500 Broad Street  
NEWARK, N. J.

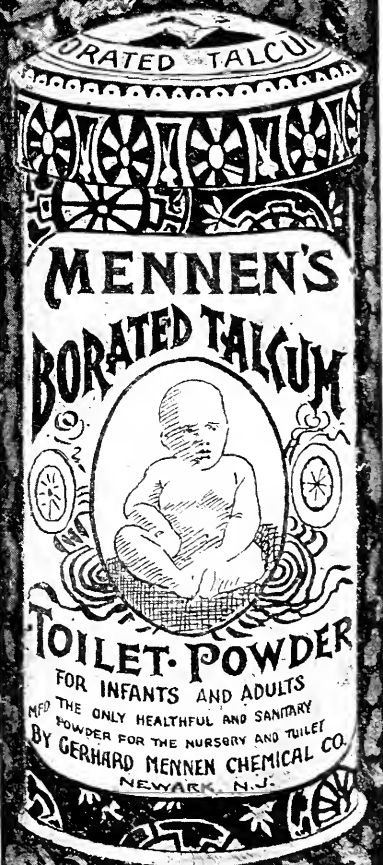

WAGSTAFF & CO. N.Y.

## THROUGH THE NEEDLE'S POINT.

CLEVELAND MOFFETT.

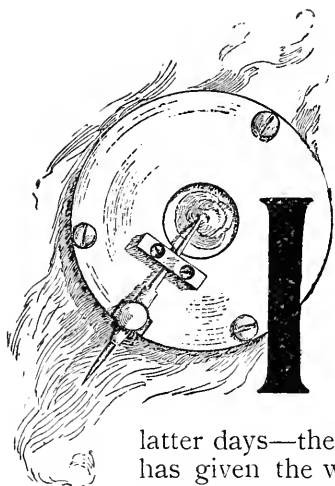

**I**T has long been considered a difficult thing for a camel to pass through the eye of a needle, but the science of these latter days—the same science that has given the world the telegraph and the telephone—has made it possible for men, women, and children, for camels, yes, and entire menageries, not only to pass through the eye of a needle, but to pass through the point, and, having thus passed through, to sing and speak, to roar and bark and whinny—in short, to make whatever sounds they please, and be heard after making them thousands of miles away. To-day the great Patti can sing her immortal songs in her castle in Wales and be heard, through the needle's point, in San Francisco and Honolulu and a hundred other places at the same time. And so of the world's great orators and entertainers, the great thinkers who stir the heart, and the merry people who aid digestion. In fact, whatever the cities have in their theatres and churches and concert halls that is best worth hearing may be heard quite conveniently, and with only the slightest falling off in quality, by the denizens of the most remote village, by dwellers on the distant alkali plains, by lonely huntsmen in the woods—and all through the point of a needle—the needle of the gramophone, which traces the undulations of the sound-waves as they are preserved on indestructible records, and reproduces them through that wonderful little instrument.

Aladdin's trick seems to have literally been performed in our time, and New York, Boston, London, and Paris may be picked up now by whomsoever will, and whisked off through hundreds of miles and made to strike all their beautiful instruments, pianos, and violins, and blaring horns, and sing with full chorus of voices, and otherwise disport themselves for the amusement or instruction of the humblest provincial.

Whoever buys a Berliner gramophone buys a box at the opera, rents a pew in a city church, secures permanent admission to the best music halls in the country, can order out a dashing military band at a moment's notice, can make the great piano-players of the day his obedient servants, and can do a great many other things which would have put somebody in danger

of being roasted for witchcraft had they been attempted by our forefathers.

And let it be understood clearly that this is no expensive arrangement, to be easily injured, nor is it anything that requires batteries or electric contrivances for its running. It is as simple and compact as a music-box, and is wound up in much the same way, while the discs which preserve the sound-records are flat surfaces of gutta-percha, and are practically indestructible. They may be thrown about or scratched, or left with the children to play with, and when put back under the needle after months of this treatment, they will give out the original words or music with unchanged sweetness and distinctness.

That is the first point, and another is that the singing of the gramophone really is singing, not squeaking, and the talking is real talking, as if the speaker were there before you.

When you hear a street fakir through the

gramophone you are almost in doubt whether the man is not actually in the room. So perfect is the method of reproduction that the human voice comes out of the receiver, whether in speech or song, practically as it went in, and thousands of people may listen to it at one time, for there is no need here of bending anxiously over an ear-trumpet; you hear what is going on whether you will or not. A cornet solo



HAPPY CAL STEWARD  
MAKING RECORDS FOR  
THE GRAMOPHONE.

played in the Metropolitan Opera House from the gramophone fills the whole auditorium.

And now let us see what this wonderful little instrument is going to do for people who live in the towns and smaller cities. In the first place, take the young ladies who, after four years at college, return to their little homes with many graces and accomplishments, particularly an appreciation of the best classical music. They find themselves suddenly in uncongenial surroundings, where most of the pianos are out of tune, and most of those who play on them play badly. The gramophone gives them a breadth of art life in the rendering of the great compositions they love by the finest performers. With this they have

"Annie Laurie" and "Down on the Swanee River," and "The Last Rose of Summer," and the old glees from years ago, sung to them, not by amateurs from the village choir, but by the greatest artists of the day—sung through the needle.

And then the comic songs—every one likes these now and then, but few who live away from the cities ever hear them sung in the best style; they must content themselves with the whistlings of the village lads, who pick the airs up as best they may a year or so late. But now the gramophone, with its discs kept closely up to date, gives the country the best that the city has—those much advertised entertainers from the music halls of London and Paris, whose enormous salaries are told of in the news-



THE GRAMOPHONE IN THE HOME.

masters to imitate in their own parlors, sources of inspiration ever present.

Then take the boys. What one of them does not love to hear the banjo played, a lively strumming of the strings by a cunning hand? The gramophone gives them what they want, and the best banjo-playing—gives it to them whenever they choose to listen. And if they tire of the banjo they can turn on a crashing brass band, with marches and songs of the regiment until their hearts beat with valor.

And the old folks themselves, with hearts ever fresh for the old emotions, will find themselves won over by the gramophone on many a winter's evening, otherwise lonely, when they will gather about fires of crackling logs, in farmhouse and country home, and listen to the dear old songs,

papers. All these the country may have now almost as soon as the city, and at nothing like the price; and it is plain that a great change will soon be wrought in the farmhouse Sunday—a dreary enough thing in the past. No more wheezy melodeons laboring away in cheerless parlors, no more feeble singing of hymns by untuned voices, but the finest anthems as sung in churches on Fifth avenue, and the beautiful solos of high-priced specialists, and the chanting of surpliced choirs, and the harmonies of double quartettes, not to mention inspiring addresses by the greatest preachers of the day.

Not only in the home is the gramophone to find itself a cause of entertainment, but already small and large private gatherings are using this many-sided instrument as a

public entertainer; and a programme which includes the best bands, the best storytellers, the best performers on various instruments, the best vocal quartettes, can quickly be made up from the rapidly growing repertoire of this wonderful instrument. Here is a specimen programme which speaks for itself:

## PROGRAMME.

## FIRST PART.

1. CORNET SOLO . . . . . *The Commodore Polka.*  
By the wonderful cornetist, W. PARIS CHAMBERS.
2. PATRIOTIC SONG . . . . . *When Johnny Comes Marching Home.*  
By GEORGE J. GASKIN.
3. RECITATION . . . . . *A Negro Funeral Sermon.*  
By GEORGE GRAHAM.
4. BANJO SOLO . . . . . *Yankee Doodle and Variations.*  
By the famous artist, VESS L. OSSMAN.
5. ITALIAN SOLO . . . . . *Di Quella Pira.*  
(The grand song from "Il Trovatore.")  
By the renowned Italian tenor, SIG. F. A. GIANNINI.
6. BAND SELECTION . . . . . *Romance of the Trombone.*
7. MALE QUARTETTE . . . . . *Hear Dem Bells.*  
By the MOZART QUARTETTE.
8. SOPRANO SOLO . . . . . *Die Nachtigale*  
(The Nightingale).  
Sung in German by FRAEULEIN VRONI VON EIDNER.
9. NEGRO SONG . . . . . *Turkey in the Straw.*  
By the negro delineator, BILLY GOLDEN.

## SECOND PART.

10. TROMBONE SOLO . . . . . *Happy Days in Dixie.*  
By ARTHUR WILLARD PRYOR, the trombone soloist,  
Sousa's Band.
11. HUMOROUS RECITATION, *Fakir Selling Corn Cure.*
12. TYROLEAN DUET . . . . . *The Mountain Climber.*  
By the GRAUS DUO of the famous Graus Mountain  
Choir.
13. ARIA FROM "RIGOLETTO."  
SEÑOR NORITTA, clarionette soloist, Sousa's Band.
14. BANJO DUET . . . . . *The Virginia Bells.*  
By CULLEN and COLLINS, the popular banjoists of  
Washington, D. C.
15. SACRED SONG . . . . . *Coronation.*  
By MR. STEVE PORTER.
16. ORCHESTRA SELECTION . . . . . *The Pomona Waltz.*  
By the METROPOLITAN ORCHESTRA.
17. TENOR SOLO . . . . . *Ben Bolt.*  
One of the old favorites that appeals to every one,  
sung by MR. E. M. FAVOR.
- 8 BRASS QUARTETTE . . . . . *Adeste Fidelis.*  
MESSRS. PRYOR, LYONS, HIGGINS, and PRYOR,  
of Sousa's Band.

It is plain that for pleasure, for instruction, and for general benefit the gramophone must soon become a real boon to millions of people whose lives are passed far from the amusements and advantages of our great cities. Its uses are numberless, as well as its possibilities for general entertainment. The girls of a family can in a few hours make up a programme of discs that will afford their friends far more pleasure than any ordinary party, and, if they want dancing, they may dance with light hearts and heels, for the gramophone gives you Sousa's Band or a Hungarian orchestra, for waltzes and two-steps, and that is better music surely than any local performer could offer. And if they wish to sing "Auld Lang Syne" before breaking up, the gramophone will lead the singing with a good grace, and play the guests out of the house with "Home, Sweet Home."



GRAMOPHONE INDESTRUCTIBLE RECORD.

The illustration is of the improved \$25.00 style, which is handsomely finished in oak with rich trimmings—runs by a perfectly governed clockwork motor.

The National Gramophone Company, proprietors of the Gramophone, 874 Broadway, New York, are so confident that this \$25.00 style will fulfil its claims, that it is willing to guarantee perfect satisfaction to any reader who will order the Gramophone and a dozen or more of the records mentioned in the above programme, paying \$25.00 for the Gramophone and 50 cents each for the twelve additional records (fourteen records in all, two being free). The distinct understanding being that if the Gramophone does not give satisfaction it can be returned at once and the money refunded, less the express charges. They have also \$10.00 and \$15.00 styles.

Catalogues and further particulars may be had by addressing the proprietors.



# THE JOHNSON SLEEPING BAG



Something entirely new in this line. Investigate it carefully before buying a Sleeping Bag of any kind.

**THE JOHNSON BAG** is sweet and clean, and can be kept so at all times.

In half a minute it can be opened out perfectly flat and exposed to sun and air, and in another half minute the cover can be detached and both spread out or hung up to dry or air.

The bane of sleeping bags has been the difficulty to keep them sweet. The Johnson Bag is the only perfectly sanitary bag in the market.

After using it, you pull a few patent snap buttons and presto! you no longer have a sleeping bag but a beautiful fur rug with new uses for camp comfort.

Made in three grades as follows:

**No. 1** Bag is lined with finest quality imported Himalaya dogskin, soft, warm and light; the finest lining a sleeping bag ever had, and the outside covering of patent water-proof cloth warranted to withstand wear and water. Price, complete, **\$18 net.**

**No. 2** Bag is lined with best bark tanned lambskins with the fleece on, a remarkably serviceable lining, as none but selected skins are used. Price, complete, **\$15 net.**

**No. 3** Bag is lined with heavy blankets of the best quality and is designed for less severe weather than Nos. 1 and 2. The covering is the same as Nos. 1 and 2. Price, complete, **\$12 net.**

**No. 4** is the waterproof outside covering. Many sportsmen have their own favorite blankets, and, recognizing the splendid practical features of the Johnson bag, may wish to use their blankets in this way.

We will make your blankets or furs into Johnson bags, complete, including binding, fitting, etc., for \$6 net.

A complete catalogue of these bags is being prepared with additional cuts and information.

## Genuine Siberian Moose Hunting, Golf or Walking Shoes

**ABSOLUTELY WATER-PROOF TO THE TOP**

This is a **special** line in every way. The result is a shoe as strong as steel, yet, pliable and soft as kid, graceful to the eye and easy on the foot.

**The leather** is the famous Siberian Moose.

**The color** is a dark Russia tan.

**The soles** are of the best anhydrous oak stock, water-proof.

**Bellows tongues** of the best Moose stock are used.

**The linings** are of russet calf-skin.

**English Backstays, extra heavy eyelets, "Bull Dog" toes, Pratt Fasteners, etc.,** etc. Every approved shoe point will be found in them. **Price to all alike, \$7.50 net.** Expressage extra.

**We also make** a short boot, 12 inches high, at **\$8.50**; a knee boot, "Hunter's Style," 16 inches high, lacing up the front, at **\$10.00**, and a "Cavalry Style" boot, 18 inches high, at **\$12.00**, all with the same good points as the shoes.

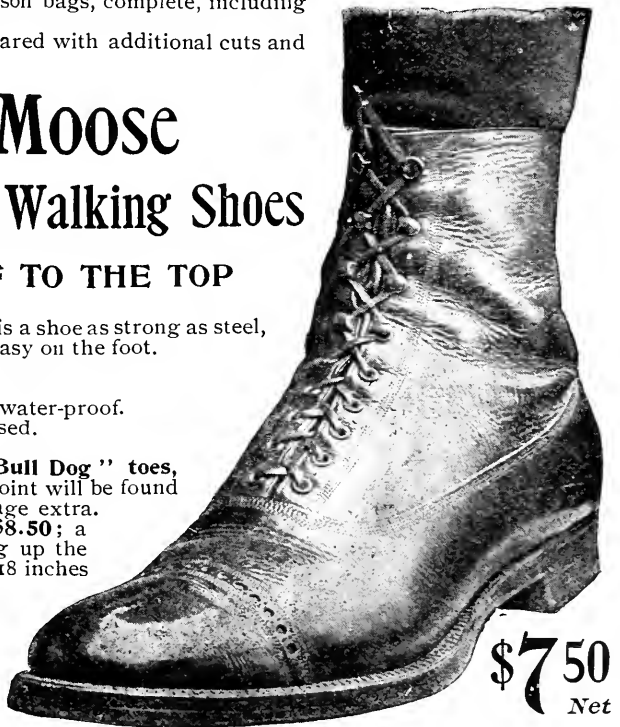

**\$7.50**  
Net

**Henry C. Squires & Son**  
20 Cortlandt Street, N. Y.



For  
Perfect  
Safety



USE

# The Victor Face Protector

It is recommended and worn by  
leading Intercollegiate players

Price \$1.75 Each

EASILY ADJUSTED, NO STRAPS  
AND BUCKLES, COMFORTABLE  
AND CONVENIENT ∴ ∴ ∴

We have many valuable novelties in  
Face Protectors and Head Harness



## The Victor Intercollegiate Football

Is Standard for Perfect Shape and Finish

*Send for Fall Catalog of Football Goods*

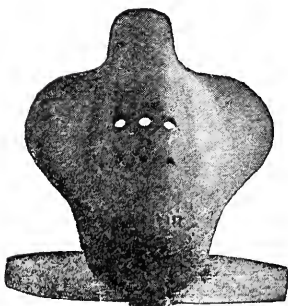

OVERMAN WHEEL CO.

New York

Boston

Chicago

Detroit

Denver

San Francisco

Portland, Ore.

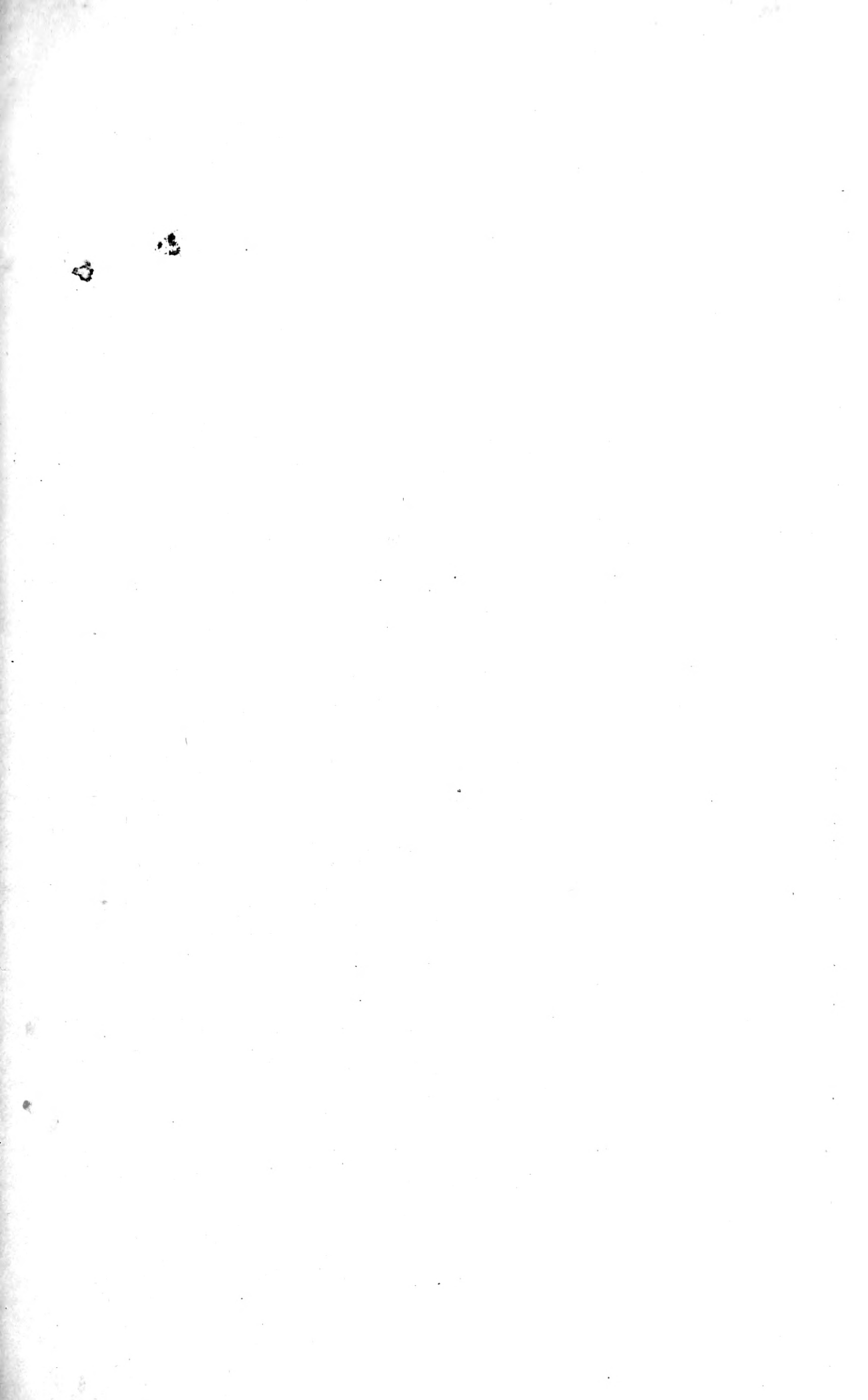



“WHEN THE WIND BEGAN TO BLOW AGAIN I WOULD SIT DOWN AND SLIDE IN THE SNOW.”

# RECREATION.

Volume VII.

NOVEMBER, 1897.

Number 5.

G. O. SHIELDS (COQUINA), Editor and Manager

---

## HUNTING MOUNTAIN SHEEP IN A SNOW-STORM.

CAPT. S. A. LAWSON.

A majority of the travelers who daily pass over the Union Pacific Road, through Laramie, Wyo., do not imagine that within 25 miles of that place are some of the most perfect specimens of the mountain sheep that can be found anywhere. Such, however, is the case; and it was in the range of mountains that seem to rise abruptly from the prairies, to the West of Laramie, that I decided to seek them.

It was in the winter of 1891 that I packed my traps and took the stage to a point where I felt confident I would find rams without having to spend too much time hunting their feeding grounds. After a 4 hours ride, in a heavy snow storm, we reached the station where I was to put up for the night, and there found an excellent meal awaiting us. Such a ride, in such a storm, was enough to whet the appetite of even a confirmed dyspeptic.

I knew it would not pay to start out so late in the day, so I watched the Stage pull out for the Keystone mines, 20 miles away, straight across the mountains, and after having waved the passengers a *bon voyage* I proceeded to make myself as comfortable as possible for the rest of the day. I was entertained during the greater part of the afternoon by a bunch of cow boys who were at the station, and who took the whole afternoon to get drunk, from a jug of "40 rod" as they called it. It seemed to me the drinks were not more than 10 min-

utes apart, and each time a new round was ordered a weird figure of an old woman appeared and each glass was filled to the brim. As I did not drink with them I was considered a curiosity and the old woman took quite a liking to me.

The next morning I started, at 9 o'clock, for the sheep grounds, and made camp at 2 p.m. without having seen anything but 2 deer, which I did not fire at. The next day I was out at 8; and as I knew where the ewes and lambs were feeding, I thought the rams might be with them. Soon after having left the ranch I saw a herd of 20 antelope; but as I wanted the more stately game paid no attention to these. The wind blew almost a gale and the snow was whirled so that I could see no signs of either ewes or lambs. Finally there was a lull, when I looked down the mountain side and saw about 15 sheep feeding—among them a magnificent old ram. As the rifle I carried was new to me, and as I had never shot it I tried to get as close as I could to the bunch. Whenever a lull came I would drop and lie as close to the snow as possible. Then when the wind began to blow again I would sit down and slide, in the snow. In this way I moved fast and soon found myself within 100 yards of the ram, when I took a careful aim and fired at him. At the report of my rifle he started to run. I fired again and he fell. Then I knew I had him.

I took another look at the herd, and picked out the next largest ram. He

was standing at about 250 yards away trying to determine what was the matter. I fired at him and, to my great delight saw he was hit. He trotted a little way, then stopped and sniffed at the dying ram. By this time he had put quite a distance between us. I had no more cartridges in my magazine, and in trying to put one in, got the action choked up. By the time I had again put it in working order the ram had gone off with the others, out of sight.

Seeing that owing to the storm I should lose the ram I had already killed, if I did not hang him up, I dressed him and hung him to a small tree, with a rope I carried with me. Then I started after the wounded sheep again, but his tracks had blown full of snow and I had great difficulty in following him. After much hard climbing I saw blood on the snow, and knew I was on his trail. I found where he had lain down, several times, and had left blood in the beds.

He went into the roughest ground he could find, and as the snow was still

blowing in clouds I could not see far ahead. I finally came to a large canyon. Just then the storm let up and I saw the old ram climbing the other side of the canyon, about 100 yards away. I fired 3 shots at him. At the third shot he fell, but got up and ran over a hog-back, out of sight. As he seemed to have so much vitality, and as it was growing late, I left him, for I did not care to spend the night on the mountain.

The next morning I started early and went to where I last saw the game. I found him just over the rise from where I had fired my last shot at him; and after cleaning him I hung him to a small pine tree. I then returned to the ranch, got a horse, took the sheep in and had them ready for the stage that was to leave the next morning.

Having read so much about mountain sheep being nearly extinct I was delighted with my success; and today the head of the largest ram adorns the drawing room of an old manor house, in England.



AMATEUR PHOTO BY A. E. COWIE.

CHICKEN SHOOTING IN MINNESOTA.

## SPEED SKATING.

A. M. ANDERSON.

Of speed skaters in America, Charles June, of Newburgh, N. Y., was one of the first. His reputation as a skater began in 1838. Of more recent date was T. Donoghue, also of Newburgh, who from 1863 until within a few years of the formation of the National Skating Association, was an unbeaten champion. Donoghue was, in 1878-79 training his sons, Tim, Jim, and Joe, who have their father's love for speed skating.

In Canada speed races are held in the principal towns. Canada has many good skaters, among whom are C. H. McCormick, H. Hulse, A. Scott, F. Dowd, F. Bren, Black and McCullough. McCormick has been Canada's greatest skater, but, owing to his age, he had to give way; now it is McCullough. McCormick's best performances were one mile, at St. John's, April, 1887, in 2 minutes and 58 seconds; and 5 miles in 16 minutes, 58 seconds, at St. Johns, March, 1888. Both races were in a rink, 14 laps to the mile.

Norway is another country with a list of good skaters. Axel Paulsen, there, made speed skating of national interest. His father, like fathers of all great skaters, was a good skater, and in 1865 was chief promoter of races.

A. Paulsen, A. Norseng, H. Hagen, P. Ostlund, F. Luhr, Frederickson and J. Nordelph, are all in the front rank. H. Hagen has a record of 2:39 for one mile; and in 3 races with McCormick, in Norway, he defeated the Canadian 3 times. Hagen's time, for the 5 miles, was 15 minutes and 56 seconds.

In 1883, Axel Paulsen for the first time crossed the Atlantic, where he again met McCormick, and was defeated by him, on account of the small rink, 14 laps to the mile. The next year, however, Paulsen again crossed the Atlantic with an improvement in racing skates. This time he swept the country, first at New York, winning a 25-mile race in 1 hour, 33 minutes and 28 seconds. Then he went to Milwaukee and defeated Dowse. Returning to the East, he won the International 10-mile race, at Washington, D. C., in 36 minutes, 7 2-5 seconds.

It seems strange that every country should have 3 leading skaters. The United States has its 3 Donoghues; England the 3 Smarts; Holland, 3 Kingmas; Canada has McCormick, McCullough, and Bren; while Norway's 3 champions are Paulsen, Hagen, and Norseng.

C. G. Tebbutt, of England, has won many a race on the track. He with his

brothers, Louis, Sidney and Arnold, skated from Earith to Wisbeach and back, a distance of 73¼ miles, in 9½ hours. Tebbutt, on the race-course of Amsterdam, March, 1, 1888, skated 40 miles in 3 hours and 7 seconds, making new records for all distances above 25 miles. In the same year Axel Paulsen skated a mile backward in 3 minutes, 31 3-5 seconds. It is recorded that J. F. Donoghue and 2 of his friends skated on the Hudson river, from Newburgh to Albany, 90 miles, in about 5 hours, after having run, in the morning of the same day, to Poughkeepsie and back, making in all 122 miles.

Among the performances of T. Donoghue, Jr., was that of skating a straight mile in a strong wind in 2 minutes, 12¾ seconds, on the Hudson river. On January 26, 1893, at Stamford, Conn., J. F. Donoghue skated 100 miles in a race in 7 hours, 11 minutes and 38 1-5 seconds, beating the best previous record by 4 hours 26 minutes and 6 4-5 seconds. The course on which Donoghue made this record was in a rink, 2 laps to the mile.

Of Western skaters, Minneapolis has a few good ones. J. S. Johnson, the great bicyclist and skater, holds the world's record, 2:42, for one mile. J. N. Nelsson holds the world's 3-mile record, 8:48 2-5; also the half-mile record, 1:20 2-5. These records were made at Montreal, in races, February 2, 1895. O. Rudd is the world's 660-yards champion.

St. Paul is full of good skaters. The leading rinks are the Aurora Park, where the championship races were held during Carnival week, 1896; Junior, Pioneer and Edgerton street rinks. At Como Park rink there is skating in summer as well as in winter; there the course is 2 laps to the mile.

On holidays and race days, in the winter, it is a picturesque scene to see thousands of young and old; with flushed faces and sparkling eyes, careening around this immense rink, with the grace and poetry of motion that makes skating so fascinating to the onlooker. At any hour of the day, rosy-cheeked girls, with their escorts, can be seen wending their way toward this rendezvous of the St. Paul skaters.

Among the best-known St. Paul skaters are, A. D. Smith, holder of many records; E. Pannell, H. Davison, J. Davison, L. Johnson, B. B. Bird, A. Scheibe, H. Bird, M. Martin, M. Anderson, A. Jones, C. Hoff, P. Hoff, G. Sudheimer, J. Cox, F. Schelo, T. Thompson, A. Lee, F. Crawford, A. Wold, R. Greenleaf, L. Larson,

D. Carmichael, F. Bogart, B. Hatry, C. Hofer, N. Noble, H. Althen and F. Perkins.

At the Edgerton rink, January 26, 1894, A. D. Smith made the world's record from 11 to 20 miles, going 20 miles in 1 hour, 6 minutes and 36 2-5 seconds; also the world's record for one hour, covering 18 miles and 215 yards. B. B. Bird holds the Amateur one mile record, reducing it from 2:56 to 2:49 3-5. E. Pannell won the American and World's Amateur record of 7 miles in 24:01 2-5; and 9 miles in 31:14. A. Scheibe has a record of 5:55 for 2 miles. Louis Johnson defeated J. Davison, a brother to the St. Paul amateur, in a 3-mile race, in 9 minutes, 52 2-5 seconds. H. Davison holds the world's 220-yard record, standing start, time 17 1-5 seconds; the quarter-mile, 33 1-3 seconds; 100-yard, 8½ sec-

onds; and the 100-yard flying start, 5½ seconds.

Nearly all of the champions use skates made in Norway, called the Norwegian racing skate. The blade is made of steel, 17 inches long and 1-16 inch thick, set in a hollow tube, which is fastened to a thin plate by 3 hollow tubes. The whole is fastened to the shoe by several copper rivets.

On a clear, frosty day, a skater feels his blood tingle, while the cold air sends new life through his veins, as he skims over the ice, with the long stroke of a Norseman, his hands loosely clasped behind his back. When through for the day, as he sits by the fireside, while the cold wind rattles the windows and the frost decorates them, he falls back in the easy chair and dreams of by-gone days, and again sees champions struggle for victory.



AMATEUR PHOTO BY AUG. GOTTSCHALCK.

TAME ELK. ROCK'S RANCH, LAKE, IDAHO.



AMATEUR PHOTO BY B. C. PACKARD.

THE DEATH WOUND.

Highly Commended by the Judges in RECREATION'S Second Annual Photo Competition.

### ROUTE FOR THE MILLION.

"Higgins has another great money making scheme on hand."

"What is it?"

"Balloons to bring people home from the Klondike."



## DEER IN THE COAST RANGE.

DANIEL ARROWSMITH.

On the morning of September 13, 1893, I saddled 2 of my friend's horses, and was off for a 2-days' hunt after blacktails. My destination was some springs near the head of Pickett creek, in the heart of the Coast range, 12 or 15 miles distant.

The previous day, my friend's sister, from Ohio, had come for a few weeks' visit; so he, being busy, said to me: "Now, S—, if you like, we'll get up the horses in the morning, so you can take an outing and get some venison for Mary."

"All right; nothing would suit me better," so, getting my rifle, I was ready. This was a No. 3 Remington, 32 inch barrel, 45 calibre, 11 pounds, shooting 110 grains of powder, and a 325-grain hollow-pointed, patched bullet (called "Col. Pickett's bullet").

At 10 o'clock I was on my way. Forging Rogue river, 100 yards wide, I turned down stream until I crossed Pickett's creek. Turning up the North bank of this stream, I left the dim wagon-road for the pack trail, which wound around the base of the steep mountain. I climbed higher and higher, passing through heavy timber—sugar and yellow pine, fir, and mountain mahogany—all of tremendous growth; now through dense thickets of chaparral, now coming into an open of several acres, covered with grass, with only here and there a tree, or a shrub; then down into wooded ravines again, so steep in places I dismounted and led the horses down.

At 4 o'clock I reached the springs. After picketing the horses and arranging the camp, I still had 2 hours of daylight, so I shouldered my rifle and started up the trail, to a wooded slope of the mountain, a mile above camp. Plenty of sign was seen, but no deer. I returned, following the summit, until just above the park where my horses were feeding.

The sun was descending behind the mountain forests. Spread before me, was a scene I may never see again. To the East, in the Cascades, rose the sharp cone-shaped crest of Mt. Pitt, 50 miles away. Across, and beyond the Siskiyou, in California, 160 miles away, in bold relief against the blue sky, shone the snow-crested summit of Mt. Shasta. Both Pitt and Shasta were clad in perpetual snow. The intervening mountains, with their dark timbered sides and deep glens, all showed distinctly in the light of the setting sun. No noise save the tinkling of Barney's bell, as he quietly grazed in the luxuriant blue-stem grass, disturbed the evening air.

I descended to camp, built a fire, and was soon eating my supper, by its light. Then, filling my pipe, I seated myself to smoke

and to muse on my first night-camp alone in the mountains, 10 miles from any human habitation.

That night, for the first time in my life, I heard the cry of a cougar. I turned in at 10 o'clock. About 3 hours later, I was awakened by a cry, coming from a wooded canyon, about 100 yards below camp. The cry resembled the combined wail of a big tom cat and that of the horned owl, but louder. I disengaged myself from the blankets, and got my rifle ready should he come into sight. In about 5 minutes, the cry came again, and that was the last I heard of the animal.

As soon as it began to grow light, I left camp, going down the trail about half a mile, then to the ridge of the mountain, and hunted along just under the crest, toward camp. With the sun had risen a dense fog, which rolled up the gulches. On passing over the crest to my side, it would soon disappear. I was nearly back to where I had stood the evening before, when I saw, indistinctly, some moving objects in some shrubbery across a little depression of the ridge, about 120 yards ahead.

The objects soon developed into 4 black-tails, coming directly toward me; an old doe, a yearling and 2 nearly grown fawns. I dropped slowly to my left knee. The deer gamboled and browsed along until within 60 yards. Then with right elbow resting on my knee, I drew bead on the breast of the yearling, and laid her out.

At the crack of the rifle, the fawns jumped once, then stood with their black tails straight out, not knowing what it meant. The old doe slunk out of sight into the low brush. Slipping another cartridge into the chamber, I pulled for the shoulders of one of the fawns. Down it went. One more high leap by the remaining one. Alighting in some firs about 2 feet high, it was screened so I could not see the position of its body. I fired but missed. Another spring and a stop, and the next shot finished him.

The doe had disappeared. I walked down, drew the deer together, dressed them, threw one over my shoulders—bullet-pouch fashion—and started down the mountain. Camp was not 200 yards distant. I had scarcely started when I saw the old doe returning. She saw the movement as I dropped my load, and stopped, not 60 yards away. I downed her with one shot. I now gathered my deer into camp, and after breakfast packed them on old John. At 9 o'clock I broke camp, and at 4.30 that afternoon unloaded my cargo at my friend's door.



CANVASBACK DUCK (*FULIGULA VALLISNERIA.*)

## MEMORIES OF A QUAIL HUNT.

G. E. B.

The hazy days of October have passed. The deep blue skies of the peculiarly rich tint known only at that season, and the resplendent coloring of leafage, have given place to the more sombre tints of November. With the deepening of the browns and the disrobing of the trees, as they prepare for their winter nap, the old longing again takes possession of me. Visions of eager dogs, ranging and quartering over brown meadows and stubble-tinted fields, mingled with memories of past singles, attempts at doubles, scores and misses, flit in pleasant panorama across my mental horizon.

The true sportsman's pleasure consists not wholly in present enjoyment of the chase, but many times and oft do scenes of past experiences rise, expelling the cares and perplexities of business life, until he again lives in delightful retrospect of the thrilling moments of bygone days. Now, after many years, there comes a picture, framed in recollections of a pleasant day afield; once again I smell the keen and frosty air of that November morning.

The hammerless, whose hibernation had been disturbed by only occasional inspection and fondling, was brought out. At the sight of its gleaming barrels and shapely, polished stock, the eyes of my Irish setter grew black with anticipation, and his body quivered with suppressed excitement. Well he knew the meaning of these preparations, and he replied to the question, "Do you want to go?" with a succession of short yelps and whines, dog language, which I understood as expressing his unqualified approval. He thrust his cold nose into the pockets of the soiled and blood-stained shooting-coat and revelled in the scent of game. Now, weighted down with shells, but with footsteps made light by hope of a successful day, I left the house.

By arrangement I met my friend G—, with his pointer, Spot of Kent, in the suburbs of the city. We immediately started for the hunting-ground, which was along a valley enclosing a small brook, about 2 miles distant, where a few beves of quails had been located in the early days of autumn.

A light snow covered the ground. The wind being rather cold, our quest must be among the thicker cover, for "Bob White" is a lover of sunshine, in his foraging expeditions among the ragweed and stubble of the open fields.

Long and patiently we searched. The dogs did their work thoroughly; but they showed signs of discouragement, as the

hours passed without a find. In vain we peered into seductive sedges and protected corners, looking for the imprint of dainty feet in the soft snow. We were on the verge of abandoning the hunt; in fact, had turned toward home, when—"What's the matter with Duke?" The resigned, patient gallop of the industrious though discouraged setter has vanished. Now every movement is replete with activity and caution. The brown nose is following the trail through the weeds at a pace indicating scent of foot rather than of body. Here, at last, are the footprints for which our eyes have hungered these many hours, and they are in plenty. Our spirits rise in anticipation, and words of caution are spoken to the dogs. Lack of success earlier in the day has rendered them fiercely intent on immediate capture.

Here, in the shelter of a tuft of grass, is where the birds spent the night. From the size of the resting-place, and the number of tracks leading from it, we know it is not a few scattered birds we are following, but a bevy of sufficient size to afford good sport. The trail leads toward the road, beyond which a dense thicket of maple and oak saplings forms the advance guard of the forest. Suddenly the tracks cease, but certain parallel incisions in the snow indicate that from here the bevy completed its journey by wing. It is not hard to guess where the "brownies" are now in hiding.

Calling the dogs to a closer range, we cautiously cross the road and enter the thicket. Now every nerve tingles with expectancy, and our eyes are strained to catch a glimpse of the winged bullets momentarily expected to start from tuft of grass or bunch of tangled weeds.

G— and I separate, the more thoroughly to beat the cover. Nothing but snap shots can score in this mass of underbrush, and all chances must be taken. I mentally prepare for many misses and—"Whir-r-r-r, bang!" How the rascal startled me!

"Did you get him?"

"No; clean miss." I resolve to do more hunting and less soliloquizing.

"Steady! boy." "Whir-r-r-r-r, bang! bang!" "Fetch! Spot." Which tells the story of a successful shot by my companion.

We now pass out of the thicket, into the meadow; the birds having shown a desire to take to the field. Scarcely have we emerged from the bushes when a single breaks from cover and comes directly at us. As he swerves to pass, I let go at him,

and he comes to earth, a clean kill. I am surprised to hear G— exclaim, "I got him that time!" Explanations and a post mortem examination of the victim, convince us that both fired, although the reports were heard as one. The bird is so mangled that, as an article of food, it is worthless.

For an hour, perhaps, we follow the birds from one end of the thicket to the other, without a kill. This in no wise detracts from the enjoyment of the hunt, for it is sport, not meat, we are after. In the excitement of those few minutes we were well repaid for the unfruitful search of the morning.

Now my ear catches the distant call of some straggler that sought safety in the woods. Wearied of his long concealment, he sends forth his liquid note, which is soon answered by another refugee among the briers that skirt the zigzag fence. Stepping cautiously in the direction of the sound, I have gone but a few paces when the rustling of leaves and the flutter of

wings, to the rear, remind me the quail is not the only crafty feathered game. As I quickly turn and fire a charge of No. 8's, the disappointment of a miss is mingled with a secret exultation; for here is a quarry worthy of my utmost skill.

Ah! there is a sight to make the nerves of any sportsman tingle with delight. Crouched among the briers, beyond the fence, I catch a glimpse of canine statuary. Spot, with nostrils dilated, eyes flashing, and tense muscles, says plainly, "Here they are!" While yonder, frozen at the sight, stands Duke, backing perfectly. Two birds rise, and, at the report of my gun, one falls into the grass. Duke hastens to fetch; halts an instant; but, at my command, rushes in and brings it, still struggling, to my hand.

The others fly—we know not where. After searching vainly, we turn our footsteps homeward, hastened by the dusk of eve, now thickening fast, counting the day's labor not in vain, for health and peaceful sleep are ours, with pleasant recollections.



AMATEUR PHOTO BY H. B. READING.

A THIRSTY TRAVELER.

Highly Commended by the Judges in RECREATION'S Second Annual Photo Competition.

## IN THE SHIN-OAKS OF TEXAS.

JOHN C. CASPARIS.

In October of 1893, 4 hunters left Johnson City, Tex., by wagon, for the Big Devil river, in Pecos county. We were on the road 18 days, though this included time taken for short hunts. Six deer were killed before reaching the camping-ground, but signs were scarce and things looked blue for a favorable hunt.

When a permanent camp had been made, we all started out that same afternoon to find the watering-places and feeding-grounds of the game. Our hounds, 8 in number, were left in camp, for their feet were worn out, from traveling over the hard, dry ground.

With one companion I went down the river, intending, after going a mile or so, to hunt back on a divide. As this was more of a prospecting trip than a hunt, we went on horseback. We found plenty of deer sign and evidences of bear. Nothing was killed, however, although we had 2 long shots, late in the evening, at deer.

We reached camp about dark; and soon after, our companions came, bringing a fat doe and 2 young turkeys. Best of all, they had surprised a bear at water, but did not get a shot. Our friends also reported plenty of sign, so the prospects for a grand time were good.

That evening the dogs were tied, and their feet greased, to harden them; for as soon as they were in good shape we intended to give the bear a run.

Before day, next morning, the camp was astir, and as soon as it commenced to get light we struck out in different directions, to look for deer. When hardly 15 minutes away from camp, I heard 2 shots, off to my right, which were shortly followed by one to the left. The boys had evidently found something, but I had not been looking closely, for it was hardly light enough for my old eyes.

Now on the alert, I had not gone 200 yards when 4 deer were seen, feeding among the shin-oaks—a species of oak 3 to 6 feet high, bearing heavy crops of acorns, on which deer and bear feed.

Dropping to the ground before being seen, and getting behind a thicket, I crawled to within 60 yards of the deer. Then, slowly rising, I covered the neck of a 4-point buck, hoping to drop him so quickly the others would not have a big

scare. At the crack of my 44, the buck made one leap, then plunged toward me, falling dead within 40 yards.

The others, not knowing where the shot came from, ran toward me and stopped, 20 yards to the left, in an opening. Before the buck had fallen, I pumped another load into my rifle, ready for a running shot. Now I held on the largest doe and dropped her. The remaining 2 started down a hill, and as they jumped over the bushes, I turned my repeater loose on them. In this way I fired 6 or 8 shots, when one, appearing to be hit, turned to one side. After bleeding the first 2, I hunted up the wounded buck. It took half an hour to find him, and then I had to shoot him again.

This might be called a good morning's work, but when I think of the number of deer seen, and the number of times I shot, between sun-up and 8 o'clock, it seems like hard luck that I got no more. I had 18 good shots and killed only 3 deer; but when camp was reached the cause of my misses was plain. The muzzle sight on my rifle had been moved about  $\frac{1}{16}$  inch.

I saw fully 50 deer that morning, and they were not wild, which showed they had not been hunted. When the other boys came in and made their reports, we all felt satisfied we had found the right country. Together we killed 7 deer, and if it had not been for a misunderstanding, through which we hunted over the same ground, several more would have been killed.

However, we had as much meat as we could take care of, for the weather was warm through the day. As we were hunting for pleasure, we intended to kill only what could be used and carried home. The saddles were salted, and the other parts were used in camp or fed to the dogs.

On the first day, after bringing in the deer, all hands were willing to lie around camp the rest of the day. We were going to take things easy until the dogs should be all right, when we intended to rustle a bear. From the sign, we knew there were some lying in the cedar brakes near by.

As the days passed, the order of camp life was to take a short hunt in the morning, fish in the river, if anyone felt like it, and to do a lot of resting. We had the bear hunt, but I will tell you of that, later.



A THANKSGIVING PROCESSION.

## SHOOTING IN ALBANIA.

D. G. CARY-ELWES, F.S.A.

On returning from China, in 1861, a brother officer and I found it cold, wintering in England. Having been quartered at Corfu, a few years previous, we decided to revisit that lovely spot. There we would hire a yacht and cross to Albania, to shoot woodcock and any other game we might find.

We went by the way of Vienna and Trieste, where we took steamer for Corfu. Arrangements were soon made for a yacht, crew and all. A noted shikari, known as Peter, was also hired. He could speak Greek, Turkish and Albanian, besides being acquainted with the country. Aside from the usual outfit for such trips, we had a motley crew of dogs: a worthless retriever, ditto cocker spaniel—brought from England—and 2 clumber spaniels—well known dogs in Corfu.

On the evening after sailing, we arrived in Butrinto, Albania, and anchored near the classic ground where Virgil makes Æneas meet Helenus, the son of Priam. However, our thoughts were on sports and not classics.

In the morning we landed and hunted woodcock, but found few birds. It was a bad year for them, though we could usually count on 10 or 12 brace a day. In a favorable season, a good shot has killed 60 to 70 brace in a day.

Our stay was short here. Anchor was weighed, and we sailed Southward, along the coast, landing at various points, making excursions inland. On one of these trips we hunted wild pigs. Soon after leaving the coast, traveling on mules and ponies, I missed our terrier. Riding back about a mile, I found the poor fellow hung by his long hair, in a bramble. He was of a kind that never yelped when hurt; and he would probably have died there, had I not gone back.

That night Peter arranged with a native Albanian to let us sleep in his cabin. We had a lively time between smoke—for which there was no outlet—and fleas. These pests were the thickest I have ever seen them.

In the morning the natives were in a state of excitement. They were going on a hunt of some kind. My friend was taken in one direction, to be stationed, I in another. I was placed in a jungle of tall reeds, not knowing what to expect, but with a hazy surmise that pigs would be driven that way.

After about half an hour, I heard a crackling of leaves and a stealthy tread. Presently a huge beast, nearly as big as a calf, and looking something like one of the native dogs, stalked past almost within reach. He

was red, with short curly hair; but as I had not been led to expect any such animal, and thought it might be one of the hounds, I let it go.

Ten minutes later I again heard a stealthy tread. Imagine my disgust at seeing a hound pass on the trail of the first brute. He was followed by a party of native beaters, who came up in wild excitement to learn if I had seen anything. When, by Peter's help, the situation was explained to them, they were furious. It was some time before I could find out the cause of the trouble. The animal I let pass was an enormous wolf, which had been devastating the flocks of the natives.

Later in the day I got a shot at a deer on a ledge, from which it tumbled over a precipice. The beaters hunted for it, but declared they could not run it down. I suspected, however, they did and kept it.

From here we returned to the yacht and got under way that night, going Southward, as far as Arta, the chief town of Albania. We introduced ourselves to the acting consul for England, a Turkish Albanian. He assured us woodcock were plentiful in the neighborhood, and said he would show us some sport next day.

We started early with him, but soon found there was little sport to be had, for the cover was light. Our host astonished us by stopping suddenly and pointing excitedly to the ground in front. He told us to shoot, but as neither my friend nor I could see anything to shoot at, he was persuaded to do so himself. The result was a woodcock killed, the only one seen during the day.

That afternoon we sailed Northward, toward Corfu. One evening we anchored at a small island, where, Peter told us, a rare kind of sport could be had. Just before dusk we landed and went up a steep ascent, from the summit of which we looked down on a bay about 300 feet below. A sheer wall rose from the beach. The water was covered with ducks.

Scattered about on the cliff were numerous natives, each having a stick, which they presently made good use of.

Just as it began to grow dark the ducks commenced to take wing, rising toward where we were stationed. The fun began as soon as they reached the top of the cliff. The natives, by swishing their sticks back and forth at the edge, succeeded in knocking down a number of them. We waited until the birds cleared the cliff, then shot as they descended the incline. We killed 3 or 4 each, while the natives, with their primitive weapons, secured more than that.

All through our trip we had various kinds of game, though woodcock were the chief. At the end of 6 weeks, from continual living on them, I loathed the sight of the birds on the table. For a year after, my taste for woodcock was gone. On getting back to Butrinto we anchored near a sportsman who had been shooting geese. He sent us

one; and I still remember the feast we had that night.

During the winter the climate of Albania is lovely. Although the mountains are covered with snow, the valleys are as warm as in Italy. The climate seemed much the same as that of Florida, but the scenery is much finer.



FROGGING.



POINTING OUT A VICTIM.



THE CATCH.

AMATEUR PHOTOS BY WALTER BLACKBURN.



## THE CHIRICAHU HOUNDS.

L.T. A. F. CAPRON, U. S. A.

We had been in camp for over a week, performing the usual routine duties, and it is needless to say I wanted a change. As I was passing through the camp of the prisoners of war, I met Naiche, the war chief of the Chiricahua Apaches, and he, like myself, was also weary of "straight duty."

To make up a hunting party was the work of a moment, and in an hour we were off for the mountains, which lie to the West of the fort. I will not tire you with an account of the trip, but will speak only of one incident of it.

We were after deer—Naiche, Perico, and To-clan-ny, all of whom were Indians, and myself. Just as we rode to the top of a little "divide," the Indians halted and pointed to a small clump of woods about eight hundred yards off.

"Deer" said Naiche.

"How many?" I asked.

"Three," he said.

I did not see them, but knew if the Indian said they were there, it was all right. These Indians beat the Dutch for being able to make out objects at a distance.

Naiche then gave a few directions to the other Indians, who dismounted and led their horses back down the divide. Now between ourselves and the deer, was a large open space, covered only with grass. On our right front, about a mile away, was a large hill, called Signal mountain, by the army people. The deer were about a thousand yards from this hill. It was the "key to the position," so Naiche and I set out to work our way to it, and by following up the near side of the "divide," finally accomplished the task without having been seen by the game. We then hid our horses and took up a good position.

Away off to our left we could see the 2 men who had remained behind, or rather Naiche saw them. I saw them afterward, with my field-glass. They were slowly working their way toward the clump of woods.

The wind was from the South—that is, it was blowing from the deer toward Naiche and me, so the other men could not work up in rear of the wood, and thus be screened from the view of the animals.

Then again, the grass was not more than 3 or 4 inches high, so it was mighty ticklish work trying to get close enough to be able to start the game up toward the hill.

The men would crawl a little way and then stop, and after watching the deer for a minute or 2, would begin crawling again. Several times the animals stopped grazing and looked over in their direction, and I thought they must have surely seen the men. Then the game would go to eating again, and again would the Indians commence their slow journey.

In this way the Apaches worked up to within 50 yards. It was the most beautiful and scientific stalking I had ever seen. But how they were to make the deer run at right angles to their position I could not see. I felt sure, that when they were seen, the game would go flying up the country, straight away from the men.

This is how they "worked it."

While working up to the animals, the 2 men had separated by about 25 or 30 yards. The man on the left, To-clan-ny, was about on a line with the deer, while Perico was nearer us.

Perico suddenly shouted, in a loud shrill voice. Of course, we could not hear it, but he told me about it afterward. The deer jumped and looked toward him. At the same instant, To-clan-ny jumped up and ran to his left and front, in such a way as to place himself slightly in rear of the game. Perico, after shouting, had remained perfectly still, and the deer saw only To-clan-ny, who was running behind them. They immediately turned and ran up the prairie, straight toward our hill, evidently intending to find a hiding place among the deep ravines.

A few moments later 3 shots rang out, in the crisp morning air. Then another. Naiche and I got our mark at the first volley, and, as I was using a Winchester, while he had a government single shot carbine, I got the other fellow.

My 2 "hounds" had done well—far better than the real article could have done under like conditions. I told Naiche they were just like 2 hounds, and to this day they are called by the Chiricahuas, "the 2 hounds."

---

### INVESTIGATING THE HARVEST.

She—"Wonderful about these great gold-fields in Alaska."

He—"Yes; wonderful indeed!"

She—"Tell me—do they cut the fields with a lawn-mower or a scythe?"



CAREFUL NOW.

AMATEUR PHOTO BY E. L. POWELL.

---

“I can't make out what species this bird  
belongs to.”  
“Take it to a milliner.”

## THE INDIAN AND THE DEER.

OLD SILVER TIP.

Well, here I am away up among the Whoop-em-up-heap-bad-Indians. I had the honor of being the first pale-face that had ever visited this tribe. I made the trip for the express purpose of studying the way in which the Ways and Means Committee, of the Tribe of Black-tail-Deer, conducted themselves. I did this merely to satisfy myself that Wood's Natural History was right, and that I was wrong. Now Mr. Editor I would like you to publish my unabridged edition of the research, for the benefit of the uninitiated.

After we had pitched our tent—now the pitching of a tent is a thing no man can thoroughly enjoy unless he does it under the following conditions: Use one hand to drive away the billions of mosquitoes and flies and if the other hand is not engaged in the same business try to hold up with it a tent-pin, and to drive it at the same time. Gentlemen, this is happiness complete. Well, as I was saying, after we got the tent pitched I threw the Winchester on my shoulder and started out. I soon found a large buck. He was looking right at me, just as saucy as you please. I also saw a buck Indian. So I made up my mind to kill him. Up went the rifle and down went the buck. I noticed he had on his war-paint and a magnificent pair of 6 pointed antlers.

As I was cutting his throat I noticed that his hair was long and black. His feet were also black, with some dried mud between the toes. He had a fine coat of fur which was ornamented with beads and buckskin fringe. I noticed that in all cases, when the bucks have their antlers on they carry their heads high, and almost all of them are armed with the 44-40 Winchester repeating rifle. Their eyes are set prominently, one on either side of the head, to enable them to see ahead as well as behind.

The bucks are, as a rule, fine specimens. They walk erect, chest well extended and their hair gets a little lighter as the season advances.

As I was taking his hide off, I noticed he wore a necklace of elk teeth and bear claws; and a tobacco pouch about his waist. He must have weighed all of 250 pounds. How nice they look when nicely

dressed and hung in a tree, alongside of one's shack! The bucks are fond of meat; and to see one, as he stands there chewing the soft twigs that are just sprouting up out of the ground, all unconscious that a human eye is upon him, is a picture long to be remembered. It is a very rare thing to find a buck with any deformity, such as lop-horns or 3 horns; although I have seen bucks going about on crutches, with a leg done up in splints.

As the buck falls at the crack of the rifle; as you walk up to cut his throat and as he rolls up that large, mild eye at you, you will see a scowl come over his face, and he will clutch his knife and try to raise himself up so as to plunge it into your heart. They are revengeful to the last, and when dying will almost always shout their war-whoop. The does, as a rule, fawn every spring; have one and 2 and have been known to have as many as 5. To see one as she comes toward you, with her fawn on her back, she appears short—about as broad as she is long. The fawns make a magnificent picture as one sees them in the evening, jumping and playing around the old doe. They have no cares in this wicked world of ours, except when old father winter spreads his snow all over the earth. It is then they crawl into the tepee and get around the little fire and toast their marrow bones, the oil of which is good to tan buckskin.

The does are the worst beggars you ever met. They will come around your tent and beg for anything that takes their eye. When the dog chases them, how beautiful they look as over the fallen trees they leap, never so much as touching one of them!

As they stand looking at you, they will stamp a foot, which I noticed, in all cases, was cased in buckskin. In some cases they were ornamented with beads. They were all clothed alike, although here and there one could see one clothed in a piece of blanket. One old doe that came to our tent, at last, got some flour and went off with it. Their legs are built for running and some of as juicy steaks as one could wish for come from near the hips. The does do not weigh so much as the bucks.

---

“The Indian language, they say, is rapidly dying out.”

“That can't be true; the dialect writers will keep it going a good while yet.”



AMATEUR PHOTO BY GEORGE R. GALLUP.

THE RESULT OF A COON HUNT.



THE MAN IN THE COON SKIN.

I send you 2 photos representing incidents in coon hunting in this vicinity. One of them represents G. R. Gallup, a member of the Northboro Coon Club, and owner of the famous coon dog "Trim," champion of Massachusetts. Mr. Gallup bought the dog 3 years ago, in Pennsylvania. Perhaps some of the readers of RECREATION would like to read Trim's record.

The first year he captured 18 coons; the second, 22; in the season of '95, 17, and in '97, 33. When Trim strikes a trail where he is most sure of his game members of the Worcester Club say they can hear him (and his master) as soon as he takes scent, even if 10 miles away.

Mr. Gallup and a party of friends captured 5 coons in one night. Following this they caught 9 in 3 nights, the largest weighing 24 pounds. Three of these were taken alive.

Mr. G. has a coat and cap made from the skins of coons which he and Trim caught.

Picture No. 3 represents the game taken by Mr. Gallup and his brother, Frank, in one day and night.

"Coon Hunter," Northboro, Mass.

Always mention RECREATION when answering ads.

## GROUSE IN NEW HAMPSHIRE.

OLD BILL.

The 14th of last September saw a party of 4 busily crowding guns, ammunition, cameras, clothing, etc., into a double-seated carriage, preparatory to a week's trip into New Hampshire.

There are various ways of "going to camp," but if one has the time and the horses, there is no other way so enjoyable as to drive. You have no trouble with the dogs, as is usually the case in the cars, and then you have your kit with you all the time. Besides, a drive gives you an opportunity to examine the game country. The stories each one has to tell, the dogs to watch as they run beside the team, the camp fires by the roadside, and the chances to take pictures of camp scenes, all tend to make it the pleasantest way to travel.



THE NOTED COON DOG, "TRIM."

*See page 354.*

At length we arrived at our destination, a large old-fashioned farm house. We all gave a loud "wha-whoop." Out popped the old man and his pleasant wife, looking exactly as they did 10 years before.

"Wa'll, by crackey! here's the boys!" the old man remarked, while his wife was as pleased as he to see us again.

The good old soul said she had made a "batch o' biscuits, sorter expectin' you ter day;" while the old man told of how the "pesky foxes" were killing his hens, while deer ran across the road occasionally, and said no guns had been heard in the vicinity.

Our party consisted of Doc, of Massachusetts—better partridge shot never hunted; "Old Nick," from Worcester; Clint, a wild-fowler from Hampton, N. H.; and me, sometimes called "Old Bill."

For dogs, there was Doc's "Trap," a keen-nosed Irish setter, an old hand at grouse; Nick's English setter "Don," and my "Dan."

Up early the morning of the 15th we hastened into canvas suits and leggins, and were soon off. I took a cart-path shortly after leaving the house. My brethren soon flushed 2 birds, from a swamp adjoining. One darted across my path ahead. I ran up in hopes of getting a view of his course, but slipped and sat down for a rest. While on the ground, the second bird came flying toward me, and I dropped him when within 30 feet. Doc winged a grouse, which was soon retrieved.

We went through a swamp, and flushed 6 birds, but did not get a shot. I again took a cart-path. A bird flushed; someone cried: "Look out, Bill." I did, and saw a bird coming directly toward me, on a level with my head. On he came at full speed, passing within a yard, then turned sharply to the right. As he disappeared in the brush, 20 feet away, I fired and dropped him.

Another swamp was beaten, and 8 birds flushed, but on account of the brush, no shots were had. At the edge of the swamp Dan was seen pointing, backed by Don, but before we could all get into position, the bird flushed and I got him.

As the afternoon drew to a close, we turned toward the house. I greatly pleased with my 3 birds. The rest were empty handed, except Doc, who had one.

That evening we sat around the room, listening to our host's stories. He was an old gunner and could tell fox, wolf, and rabbit stories until sunrise.

The second day we entrusted the lunch to Clint, for he urgently requested it, with an obliging look on his face. Doc began the day's sport by knocking over a grouse in fine style. I flushed a woodcock on the side of a hill, but shot too quickly and missed with both barrels. Doc finished him, however, on the second rise. This provoked me, for I wanted the bird, so I entered a swamp to get a shot, thinking to even things up. Three grouse were flushed, one of which was killed by Doc.

After a few hours of hunting, all but Clint complained of hunger. Of course we did not want to insist on eating, while he was not hungry, so we hunted an hour longer. Still he was not hungry. By 2 o'clock, however, we found a spring and insisted on nourishment. Then it was found the wild-fowler had helped himself to all the grub. Doc was provoked, for he is rather particular about not going hungry; but we consoled ourselves as best we

could, tightened our waistbands, drank spring water, and proceeded, with wicked eyes on Clint all the rest of that day.

Our little party hunted every day, with varying success, but always with a satisfied feeling at night. Finally the last day was at hand, and we anticipated a great time. In the morning we drove to a neighboring farm, and put the team up with an old hunter, who told us of several coveys of ruffed grouse. We failed to locate his flocks at first, but finally ran on to one of them and the fun began.

I was told to keep in a certain cart-path; Doc put me there, presumably in good faith. The other boys entered a little swamp and soon flushed 6 birds. Doc dropped 4, and Nick got the other 2. They were all young birds and lay close, and it was an easy place in which to shoot. Of course I did not get a shot from the path. One bird Doc shot, lit in a tree near me, then dropped to the ground dead.

Well satisfied with the morning's work, we drove out again in the afternoon. During the hunt, Doc called me to come over to him, for he was about to flush a covey of grouse. I ran across a swamp, jumping from tussock to tussock. Just as I leaped from one I saw a black snake on the next, coiled, with head erect. As I had jumped for this particular tussock, and was then in the air, I could not help landing on it. I can never forget the sensation as the snake coiled around my legs. I kicked pretty lively for a few seconds, and when at last clear of him I flew, not even looking around.

We had funny stories to tell the old man that night. Nick, who is a 6-footer, at-

tempted to jump a bog, about 8 feet wide, but slipped and went to his hips into mud. The butt of his gun somehow got under his arm, and he drove that down about 2 feet. We had hard work scraping the mud off from him and poking it out of his gun barrels.

There was also a little hitch in getting over a stream, about 20 feet wide, that afternoon. We followed its bank for half a mile, without finding a way to cross. Finally Doc saw a birch tree near the bank. This he climbed and bending it down, landed safe on the other shore. I let the heavy-weights try it first, then threw over my gun and began climbing. The tree bent, but not enough, and I hung over the water, unable to get back and not wanting to get wet.

As I had enjoyed a good laugh on Nick, when he was in the mud, he now retaliated. I could hang to the small branches, but a short time, and it was anything but funny to me; though the others enjoyed it, and even my dog howled with delight. After a time Doc assisted me, and I came off my perch, resolved to never again laugh at the misfortunes of others.

We reached the house pretty tired that night, but the feather beds of our host were a consolation. The mattresses were about 2 feet deep, and by taking a run across the room and making a good jump, I could get into bed. I would immediately sink into oblivion—not sleep, mind you, but simply out of sight. For half the night I imagined myself hanging to that birch tree.

In the morning, with everything, even to the dogs, packed into the carriage, we started for home, over beautiful New Hampshire roads.



AMATEUR PHOTO BY AUG. GOTTSCHALCK.

TAME BUFFALO. ROCK'S RANCH, LAKE, IDAHO.

## IN THE BITTER ROOT MOUNTAINS

H. S. GARFIELD, M.D.

Editor RECREATION: Our party returned to Pendleton August 29th. All were well and we had a grand time in the Bitter Root mountains.

Owing to an unfortunate accident to our large camera, which occurred soon after leaving civilization, we had to do all our work with the Baby Wizard. This crippled the artistic capacity of the party sadly; but we made some efforts with the little camera and mail you such pictures as seem most likely to interest you.

We found the greatest elk country I ever saw; and next season we will go there and give you photos of live elk, deer, and bear. We shall get moose there also, but do not hope to be able to photograph any of them alive. We shall set up a large camera, at the great salt licks, and watch it, by relays, until we get the pictures we want.

We camped at the cabin where Mr. Carlin was snowed in, while hunting elk, in 1895. There is a warm spring  $\frac{1}{2}$  mile above this cabin, on Wild creek, which has been used



AMATEUR PHOTO BY DR. H. S. GARFIELD.

### HALF ASLEEP.

Young Franklin grouse. Distance, 7 feet; time, 2 seconds.

These subjects are extremely difficult, and were secured only after great labor and many disappointments. I sacrificed every other detail to the birds in the foreground; and did so purposely, to get them as large and as lifelike as such a subject could be made with the apparatus in hand.

It is needless to say I am going into the Bitter Roots again next year, and will go fixed to bring out some grand pictures.



AMATEUR PHOTO BY DR. H. S. GARFIELD.

### FRANKLIN GROUSE.

Distance, 7 feet; time, 2 seconds.

by elk, for ages. There is no difficulty, whatever, in getting all the elk any reasonable man could want, in a few days' hunting at this cabin, in September.

There are three groups of warm springs near here, the Upper, Lower and Middle. From the upper to the lower is about 12 miles; and the middle spring is about 6 miles from either.

We got all the game and fish we wanted, and several times merged closely on the domain of the game and fish hogs, whom you so promptly hit on the heads with your editorial mallet, every time they are brought to your notice. We tried, however to quit in time, and wasted none of our game. We quit when we had enough.

“Here’s a telegram about your Montana uncle; he has just died with his boots on.”

“Well, he always was horribly lazy; I suppose he wanted his poor wife to have the trouble of pulling them off.”

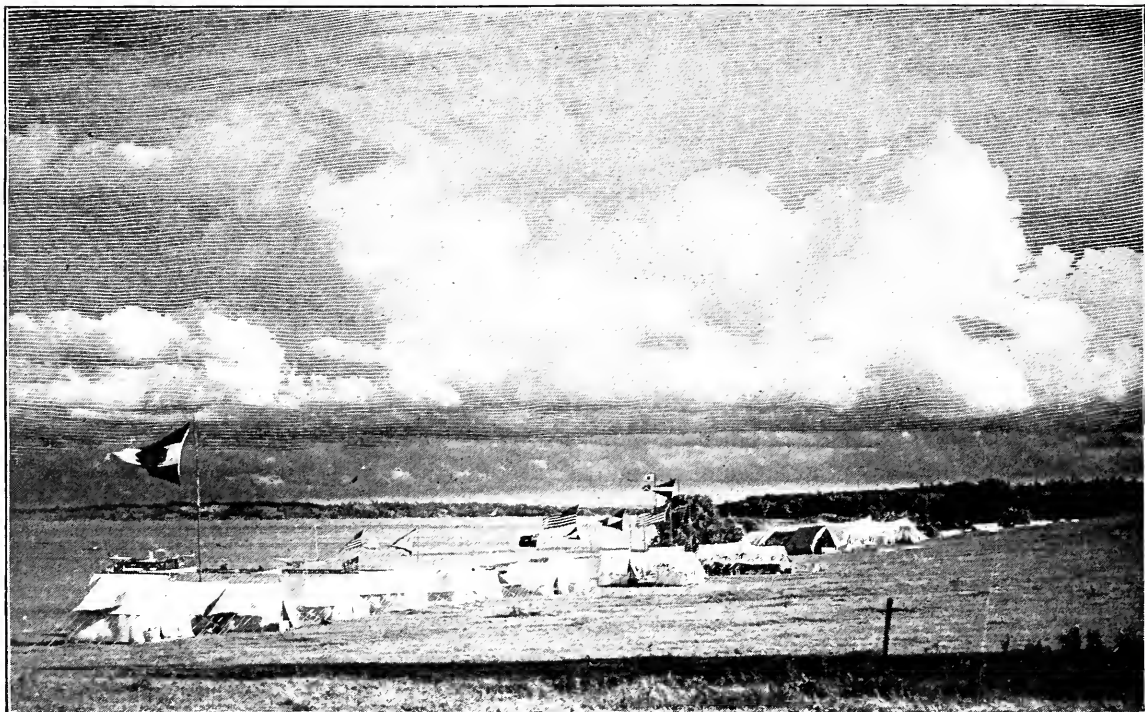

THE A. C. A. CAMP, GRINDSTONE ISLAND, AUGUST, 1897.



THE NOTED GROUSE DOG, "SKIP."  
Scotch terrier, owned by Ira T. Monroe, No. Livermore,  
Me. Record, for 6 years, 395 ruffed grouse.

#### A GOOD GROUSE DOG.

We have discussed, many times, in this State, the question as to which is the more humane and sportsmanlike, to wound one half the game, and not get the other half, or to kill dead and cause the least possible suffering. As a rule, only woodcock are shot entirely on the wing, hereabouts, owing to their lumbering flight, and the nature of the ground where they, as well as grouse, are to be found.

Two sportsmen, from New Jersey, visited me the past summer, to shoot ruffed grouse; but told me at night, after a day's hunt, that their style of shooting on the wing was entirely balked by the forest growth and by the roughness of the ground. I send you a picture of my dog. He is a Scotch terrier, of almost pure blood, of the short legged variety, and weighs 17 pounds; buff colored, shaggy hair. He is a capital grouse dog. He trails and flushes them on the run, puts them into trees, and then barks till I come. We rarely fail to bag any bird of which he strikes the trail.

Ira T. Monroe, North Livermore, Me.

How else can you do a friend so great a kindness as by giving him a yearly subscription to RECREATION as a Christmas present? Tell me that.



## IN EARLY DAYS.

GEO. HAYDEN.

The accounts of "clever boy shooters" interest and please me; for they take me back to boyhood days.

In 1844 I lived in the Territory of Wisconsin. I was then 8 years old. The only gun our family owned was a little single barrel muzzle-loader. My father often showed me how to handle it. He told me to select some small object, 30 or 40 yards away, and to look straight at it, bringing the gun up at the same time. I continued this practice until the barrel of the gun would come in line with the object the instant the gun was at my shoulder.

I never shot the gun, until one day when my parents were away. Hearing the farm dog running rabbits, in the thickets near the house, I loaded the gun with powder, but there was no shot.

I found some screws, and put them into the gun, then went to the nearest thicket. Walking along a path, I saw a rabbit coming toward me, the dog after it. The rabbit ran past, almost touching me. I turned, brought the gun to my shoulder and fired. One of the screws struck the back of the rabbit's head, nearly taking it off.

About 2 years after this, a boy visited me. One evening, as we were going for the cows, I asked father to let me take the gun. After we found the cows, we went to a patch of buckwheat, where a single prairie-chicken was flushed. The gun was brought to my shoulder in an instant, and I fired. Down came the chicken. My friend was greatly pleased and said he would drive the cows home and carry the chicken while I hunted.

I went to another patch of buckwheat on the brow of a hill and looked over. A prairie-chicken stuck up its head. As I fired, a covey rose. I ran into the field and picked up two dead birds. Then I started for home, in a hurry. On going a short distance, I looked back and saw my dog following, with another chicken in his mouth.

After this the gun was given to me. I have it yet, in good condition. It is a 20 gauge, 24-inch stub twist barrel, weight 4 pounds, 2¼-inch drop, and a good bar lock. When new it cost \$25.

When I could get the ammunition I killed considerable game: pinnated and ruffed grouse, ducks, quails, wild pigeons and rabbits. It was just the gun with which to shoot ruffed grouse in thickets.

My mother used to tell me not to kill more game nor catch more fish than we could use, as it was wicked to kill it and let it spoil. Game was plentiful at that time. One day I had no ammunition, and the wild

pigeons were flying in countless numbers. I had to stand on a field of corn, just coming up, to keep them off. If allowed to alight they would pull up acres of the young corn in a few minutes.

When about 11 years old I had a little rifle given to me. At every opportunity I practiced, on the same principle as with the gun. At the age of 14 I became quite expert with rifle and gun, but was a surer shot with the rifle, never shooting at the body of game at short range.

My father used to tell me if I missed twice in succession not to shoot any more that day. It was not easy to get money in those days, so I did not want to waste ammunition. When I was 9 years old, I worked 6 days for a neighbor; driving 2 yoke of oxen, breaking ground, and received a shilling (12½ cents) a day. I invested the proceeds, 75 cents, and 10 years later realized enough from this investment to give me a start in life.

By the time I was 10 years old I had caught a good many small fish but had never taken a pickerel. I wanted to catch one but had no line. One day I asked a neighbor if he would let me have his pickerel line. He said he would. "You will find it at Pickerel bay, on Eagle lake, hidden under a piece of bark." I found it where he said it was.

I got into a boat and shoved out to a floating bog, where the water was 10 or 12 feet deep. My brother, who was with me, was opposed to my trying for pickerel, for there was no chain on the hook, but I was determined. This being my first attempt I could not throw the line far.

After throwing and pulling in several times, I felt a jerk. I commenced to shake and my knees smote together as the line ran through my hands. I did not wait for the fish to stop, but jerked and pulled until it broke loose. I thought then I never could catch a pickerel.

My brother did not want me to try again, but I did, and after throwing for some time, I felt another jerk. This time I let the fish run until he stopped. When he started again, I jerked, and pulled him in. He was a large pickerel. I beat him on the head with the anchor stone, until he was dead. Shoving the boat to another bog, I began fishing again. I saw 2 pickerel run for the bait; one of them got it and ran back under the bog. I waited until the fish moved, then pulled him in. I did not have to throw many times before catching the third. The fish were about equal in size.

We strung them on a stick, and, partly carrying, partly dragging, got them home.

They weighed together, 37 pounds. I never caught but one larger than these, although my brother caught one in this lake weighing 18 pounds.

A short time after this, I was at the same place, when a man was fishing for pickerel. I asked him what luck. He said he had had 2 or 3 bites, but could not catch anything. He pulled the line as soon as he had a bite.

I took his line; I could now throw it full length, 100 feet. I had not cast many times when I felt a bite. I let the fish run until it stopped; when it started again, I pulled it in. This was a pickerel weighing 14 pounds. When fishing one evening, at Pickerel bay, I was standing in the boat talking to a man on shore. The line was in my hand, ready to throw. The bait may have touched the water, but I think not. The pickerel probably came from under the boat and saw the bait. At any rate, he jumped and caught it, broke the line and took the hook and chain with him, and nearly pulled me out of the boat. The commotion in the water was so great, and the jerk so strong, I thought it was the largest pickerel I had ever seen.

Getting a new hook and chain, I went to the same place next morning. I caught one pickerel weighing 7 pounds. I told my folks I could not catch the big one that took my hook; but on cutting this one open my hook and chain, lost the night before, were found in his stomach.

Bass were also plentiful at that time. I caught big-mouth black bass that weighed 7 pounds. In July and August I would go to a deep lake, now called Schwartz lake, to catch silver bass. Starting after breakfast, I would walk nearly 3 miles to the lake, catching grasshoppers on the way. I would paddle where the water was 20 feet deep, and catch 25 or 30 bass in as many minutes. They averaged  $\frac{1}{2}$  pound. Then I would get home in time for a fish dinner. I do not recollect ever having failed to do this.

After an absence of 36 years, I tried again to catch silver bass in this lake, using the same bait; the only difference was my rod and reel. I could not get a bite. I have fished in this lake the last 5 or 6 years without catching even one silver bass, although there are some there. However, I have taken some small-mouth bass, weighing from 1 to  $3\frac{1}{2}$  pounds.



BESS OF RUSH.

Here is a portrait of Bess of Rush (38.276) who is owned by F. A. Sweet, Smyrna, N. Y. She is by Royal Kent, out of Floss of Rush. Bess is a handsome little pointer and a splendid hunter. She has never been shown, but is capable of holding her own with the light weights—35 pounds—on the bench as well as in the field.

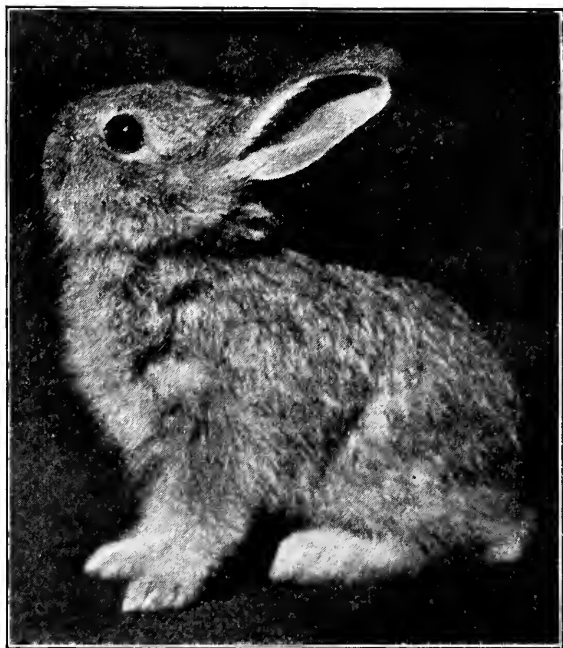

YOUNG JACK RABBIT.

A high grade modern upright piano for 200 subscriptions to RECREATION. Write for particulars.

When making up your list of Christmas presents don't forget to include a year's subscription to RECREATION for each of them. Nothing you could think of would give them more solid comfort.

## A RAID BY THE KIOWAS.

T. C. AUSTIN.

The article in RECREATION, by Lieut. Sands, "A Close Call for Gen. Sherman," recalled an episode in my life, never to be forgotten. The scene of those mutilated forms, victims of the red man's murderous vengeance, was burned deep into my soul, as if seared with a hot iron. There are, however, some incidents connected with that massacre not mentioned by the Lieutenant.

During the spring of 1871 I was connected with that Texas veteran, Gen. A. B. Norton, now deceased, of Dallas, in the publication of "Norton's Union Intelligencer," just being revived from its slumber, caused by the rebellion. There were few railroads in Texas at that time, and the vast plains West of Fort Worth were a range for thousands of wild cattle, with a knowledge of man limited to the cowboys who occasionally rounded them up to brand them. Weatherford, now a city of several thousands, was a village, the inhabitants of which were in constant dread of Indians, roving bands being frequently seen in close proximity.

Gen. Sherman had been a guest of Gen. Norton. From Dallas he went to Austin, and thence to Fort Griffin; on his way North. The day following his departure for Fort Griffin, I started on a business trip to Weatherford. I spent a day at Fort Worth, then but a village of 100 inhabitants, and on the following morning set out on horse-back, for a 40-mile ride.

The day was perfect, showing the magnificent beauty of the valleys of the Trinities to perfection. The road was the old Government trail, which followed the divides, between the streams, wherever possible. The ride was solitary, with no companion, save my horse and a brace of revolvers at my belt.

About 9 o'clock I crossed the Clear Fork and followed the road on the divide between the Clear and Middle Forks. On either side, far in the distance and below me, could be seen the 2 streams, like silver threads, winding through the low timber, which resembled a tow-path. There were no habitations; nature held sway in all its glory. Mile after mile was traversed, while I was "wrapped in the solitude of my own imagination."

Late in the afternoon I overtook an ox team, hauling a load of lumber to Weatherford. The driver told me he was going into camp at an old cattle corral about 3 miles ahead, and asked me to share his quarters for the night. I declined, for it was necessary to be at my destination as early as possible the next morning. I passed the

old corral an hour before sundown, and, crossing the little stream near by, proceeded in a smart gallop to the divide, reaching it just as the sun disappeared.

At the divide I stopped and glanced back. The valleys and plains were dotted with cattle, while the setting sun seemed to kiss the hill-tops a lingering good-night. My companion of an hour before was just entering the corral, and as he halted his team, I spurred over the hill, reaching my destination, a farm owned by a man named Johnson, at 8 o'clock.

This was a stopping-place for travellers going to and from Weatherford. The corral was filled with teams, and the house was occupied by 10 or 15 men, who, like me, had been overtaken by night. Supper was being served and nearly an hour was occupied with that meal.

The last man had scarcely risen when a horse's hoofs were heard on the road, ceasing at the gate. An instant later the door was thrown open by a man, all excitement and breathless. "Redskins!" he exclaimed, and a thunderbolt could not have created greater consternation. Instantly all was confusion; some of the men rushed for their firearms, some for one thing and some another. A few of the cooler heads asked an explanation, and the messenger told his story.

He had been on a round-up, and shortly after sundown started for the old corral, to spend the night. He found it in ruins and the bloody corpse of the teamster, scalped and mutilated, was lying near by. The cowboy at once sped on, to give settlers warning.

It is needless to say sleep was out of the question that night. A messenger was dispatched to Weatherford for assistance, while men were placed at various points to guard against surprise. The night passed without molestation, however.

Early the next morning 10 of us went to the corral. There we found the body of the teamster, filled with arrows and pinned to the earth. The poor fellow had been scalped and otherwise mutilated. The carcasses of his cattle were lying near by.

A thorough examination of the surroundings was made, and from appearances there were evidently 75 Indians in the band. The trail led up the valley, in a Northwesterly direction, but our party being small, it was decided to await reinforcements. At 9 o'clock 25 men from Weatherford arrived, when the chase was taken up.

During the day, several cattlemen joined us. From them we learned the murderers were Kiowas, in command of Satank, a

sub-chief of Satanta's, and that still another party, farther West, was being led by Big Tree, all from the Fort Sill reservation.

The chase was continued all that day and night. At daybreak we put into Jacksboro. Here more startling news awaited us. The Indian marauders had joined forces, some distance West of Jacksboro, and attacked a Government supply-train of 8 or 10 wagons and 14 men, on the way to Fort

Sill. Thirteen of the men were killed. The other, terribly wounded, managed to release one of the horses and make his escape to Jacksboro.

After this bit of news our company continued its march, arriving at the scene of the massacre, so graphically described by Lieut. Sands, shortly behind the troops.

After the burial of the men, the volunteers were released from duty and returned, I among them.



YOUNG SPORTSMEN.

AMATEUR PHOTO BY S. W. HOLM.

### A FLORAL ECLIPSE.

'Twas the hundredth performance, the play  
was most done,

And the bouquets were tossed up in  
showers;

When the maiden in front touched her es-  
cort and said,

"Look; the stage can't be seen for the  
flowers."

Then the man just behind touched her  
shoulder, and said,

"Miss, yer right what yer said 'bout  
them flowers;

But the bunch on yer hat is so near the  
same size

That I ain't seen the stage for two  
hours."

—A. Bushnell, Jr., in L. A. W. Bulletin.

## A GRIZZLY AND A MUZZLE-LOADER.

A. PLUMMER.

Editor RECREATION: From 1866 to 1871, Joe Blodgett and I were partners in the cattle business, in Bitter Root valley, Montana. Our cattle ranged in a basin called Ross's Hole, at that time one of the best game districts in Montana. During the spring and summer months of each year we spent several weeks there, looking after our stock, and in hunting.

In June, 1867, we left our ranch, on the Bitter Root river, near the present town of Corvallis, intending to pass the summer with the cattle. We had 6 pack animals and our saddle horses. We were armed with Hawkins' rifles, muzzle-loaders, carrying half-ounce balls.

After 2 days' travel we arrived in Ross's Hole. A week was spent in driving the cattle to the best ranges; then we moved camp to the Big Hole basin, 20 miles distant. This basin is about 60 miles long by 25 wide, and is the source of the Jefferson river, which in turn makes one of the 3 forks of the Missouri. It was an ideal spot for the sportsman, abounding in deer, antelope, elk, moose, bear, small game and fish.

After making camp we immediately prepared for a hunt; and on the following morning left camp, on horseback, accompanied by Jack, a large greyhound. We had gone perhaps 2 miles, when we saw, half a mile away, a bear and 2 cubs, digging roots. The animals were an old she grizzly and 2 cubs, about a year old.

They were in open ground, a mile from the nearest timber. Keeping between them and the woods, we approached within 200 yards before being seen. Hearing us, the old bear raised on her hind legs, then dropped on all fours, herding her cubs, in order to get behind us to the shelter of the timber. As soon as she started to run, the hound was turned loose, while Joe and I started to head her off. This we easily did, for our horses were good runners.

When we were within 75 yards, we jumped off our horses and fired; but owing to the great fright of the horses, only one shot took effect, and that too far back to stop her. On the contrary, it seemed to make her more determined to get away. In the meantime the cubs were going for the timber as fast as possible. The old one stopped now and then to fight off the dog and to bite her wound.

After great difficulty we managed to mount, and again headed her off long

enough to get a shot: but as before, only wounded her. By this time our horses were so frightened it was almost impossible to reload, but we finally succeeded in doing so and in mounting. I rode as near to the bear as my horse would go, and ventured another shot, on the run, but missed.

We headed her the third time and succeeded in stopping her by a bullet in the body. She was now badly wounded and immediately started for us. As our guns were muzzle-loaders and empty, we tried to mount, to get out of her way. Blodgett's horse gave a snort and a plunge, and almost before we realized it he was off toward camp as fast as he could go. Joe immediately started after him, not with the same speed perhaps, but with the same incentive.

Up to this time I had had all I could do to keep my horse from breaking away, and it now looked as though my only chance to escape was to let the horse go and to take to my heels, as my partner had done.

Brave Jack, seeming to understand my danger, rushed forward, in front of the bear and tried to frighten her off. This gave me time to mount, but at a great cost to Jack. Once he got too close to the bear, and as he sprang away she struck at him with both fore paws, catching him at the shoulder, and stripping the hide off clear to his hips; yet the brave dog kept biting her heels, which compelled her to turn and fight him off.

By this time I had gained control of my horse, and was circling around the grizzly, to distract her attention from Blodgett, who was still keeping up his 2.40 gait toward the timber. She finally took after me, but was so weakened by her wounds she did not run far.

After I had circled around her several times, she contented herself with sitting down and snarling, and fighting the dog off. I again tried shooting her from my horse, but only grazed her breast. I then dismounted and shot her, this time fatally, the ball breaking her neck. Seeing this, Joe turned from his mad career and came back. The cubs had in the meantime made their escape to the mountains, much to our regret, for we wished to capture them.

This was one of the largest bears I have ever seen, and was a formidable foe for anyone to meet. We took the skin, although it was not in good condition, and returned to camp, satisfied with our first day's hunt.



NO. 1.—THE START.

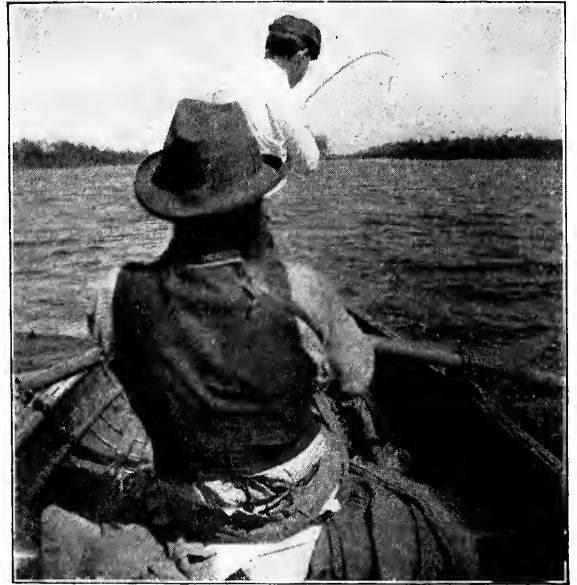

NO. 3.—HOOKED.



NO. 2.—THE CAST.



NO. 4.—LANDED.

AMATEUR PHOTOS BY M. S. WAGNER.

---

“Yes, I want a wife with auburn hair;  
none other will suit.”  
“Why, your own hair is auburn.”  
“That’s it; I don’t propose to fall into  
the clutches of any woman who can call  
me ‘red-head.’”

---

## NOTES ON MAKING BIRD SKINS.

F. E. FLEMING.

Having seen in RECREATION several requests for information on the art of taxidermy, I will attempt to give its readers a few hints on making small bird skins.

In the first place, when preparing for your trip, do not fail to place in your hunting bag a bunch of cotton batting, and a small pair of tweezers. Carry, also, some paper cones, \* of different sizes. When you have brought down your bird, open its mouth, fill the throat with a small tuft of cotton and stop the vent in the same manner. Plug each shot hole, also. This prevents the plumage from getting soiled, and saves you some work after the operation. Place each bird in a cone, to keep the feathers in place. Keep your birds as fresh as possible. The first signs of decomposition always appear on the abdomen, where the feathers and epidermis slip off.

If your bird does get spoiled, it must be washed before the skin is removed. Get a shallow box, of convenient size, and put in enough plaster of paris to cover the bird. Now take the bird, and with a tuft of cotton and cold water, wash the dirt and blood away. This done thoroughly, place the bird in the box, and cover its wet plumage with plaster of paris, changing the plaster as fast as it gets damp, otherwise it will cake and stick to the feathers. When the feathers are thoroughly dry, take the bird to a place where there is a circulation of air, and dust it carefully and thoroughly, to remove all the plaster.

Now comes the skinning. At best this is a delicate piece of work, and at first is quite difficult. But practice makes perfect, and you must not get discouraged if your first attempts are not entirely satisfactory. The tools necessary are, a sharp scalpel (if you do not possess one use your pen knife), a pair of bone breakers, or a heavy pair of shears, and a pair of small curved scissors, if you have them. With these and some plaster of paris, cotton batting, and preparation for curing the skin, you are ready to begin.

Place the bird on the table, with the head to your left; take the scalpel between the right thumb and forefinger, holding the bird and parting the feathers with the left hand, and proceed to cut the skin in a line from the centre of the breast to the vent.

The shorter you make this cut, in skinning a bird, the better, as there is less sewing to be done at the finish, and you get the body in better shape. Gently work the skin away from the base of the body, and be sure not to stretch the skin. Run one point of the bone breakers, or shears, under the flesh and bones at the base of the tail, just below the vent, and cut off the tail; leaving enough flesh on the tail feathers so that they will stay in place when cured. Next gently force the skin down on the sides, cut off the legs close to the body, and draw the skin down carefully toward the head till you reach the wing bones. Next break the wing bones, and cut off the wings at the point where broken. Now force the skin down the neck to the base of the skull.

In some of the larger birds, the skin of the neck will not pass over the head; in which case, skin as far as possible, then tie a string tightly around the neck, cut off the neck just below the string, and cover the end of the neck with plaster of paris to stop the blood. Then turn the skin back over the head and cut a slit in the back of the neck, from the base of the skull forward, large enough for the skull to be drawn through it.

In most small birds, however, this process is not necessary. By carefully and patiently working the skin forward with the fingers, it is possible to turn it wrong side out over the skull, down to the eyes. Here the membrane, which attaches the eyelids to the edge of the orbit, must be cut through, great care being taken to avoid cutting the edges of the eyelids. This being done, a few more touches of the scalpel bring you to the base of the bill, which is as far as you can go.

Now take your shears, cut off the base of the skull, and clear the brain cavity, thoroughly. Dig out the eyes, and remove every particle of flesh and fat from the skin, legs and wings. On birds as large as a robin, you must slit open the skin along the inside of the wing, and remove all flesh from the bones.

After this has been accomplished dust skin on inside with the mixture of powdered alum and arsenic; then turn the skin back, and fill the eye sockets with cotton, the size of the original eye. Next take a penholder, and wrap enough cotton around it to make a false neck, and anchor the end of the cotton roll in the brain cavity. Smooth the feathers, and draw out the penholder.

Next take a bunch of cotton large enough to make the body, and place it under what remains from making the neck.

\* I do not agree with the author in thinking that the finished skin should be put in a paper cone. To ornithological curators, such skins come out faulty in shape. The method approved by the highest authorities consists in wrapping each skin in a very thin sheet of cotton batting, or cotton "wadding," so arranging the parts and the plumage and so shaping the body and neck during the process, that the skin finally has the exact shape the dead bird exhibited before it was operated on.—ED.

Smooth the feathers, place the wings close to the body, pretty well forward so they will lie smoothly, and tie the elbow-joints together. See that all the feathers are in their place, and tie the bill together with a piece of thread. Cross the legs and tie a strip of paper to them, on which has been written all necessary data, such as sex, date, locality, etc.

Place the skin in a paper cone of the right size, and your work is finished.

Do your work well and carefully. If you use plenty of plaster of paris on the body, while skinning, you will avoid getting grease and blood on the feathers. Any dealer in taxidermist's supplies can furnish you with all the tools and materials you may require.

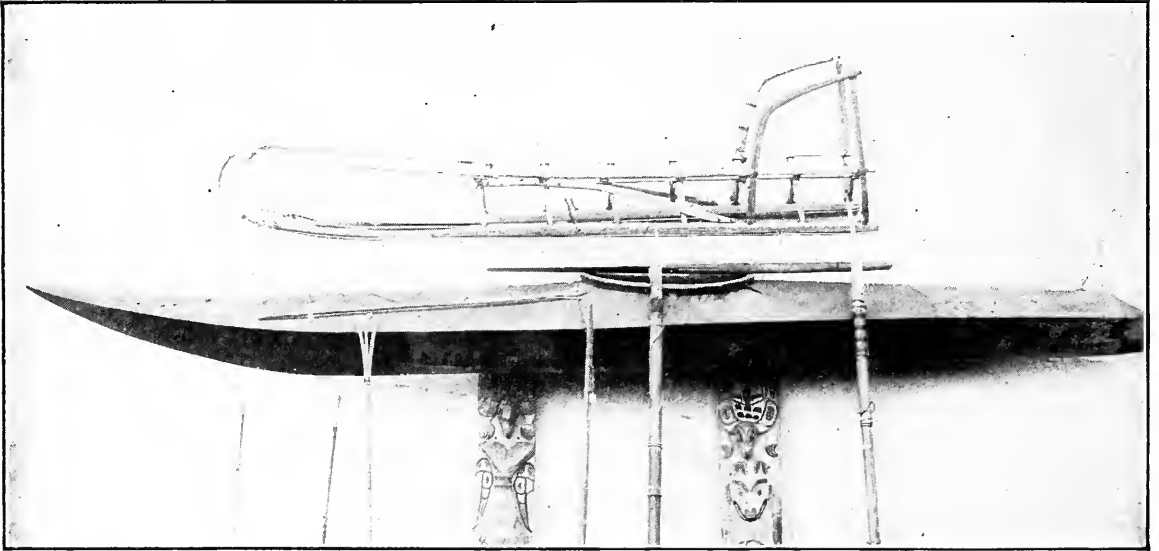

ESKIMO HANDIWORK. HUNTING AND FISHING OUTFIT.

I send you herewith a photograph of an Eskimo hunting outfit. I had 4 of these brought down from Alaska, last year. The outfit includes a kyack (or walrus hide boat), bird, fish, seal, bear, and walrus spears and a reindeer sled. The boats are 16 to 20 feet long, weigh 28 to 35 pounds, and beside being curious, are the finest duck boats I ever saw. They are not only light weight, but are of a dead moss color, strong, tough, and well made. The sharp point glides easily through grass and sedge; they are overdecked, and draw but little water.

The spears all have points made from walrus ivory. The sled has bone soles on the runners; all the points are lashed with walrus hide, while the ribs are made from reindeer horns.

W. F. Sheard, Tacoma, Wash.

If you feel kindly disposed toward RECREATION, always mention it when answering ads. It is a great help to the magazine.



AMATEUR FLASHLIGHT PHOTO BY CHAS. HUGHES.

STARTLED.

Is there not a farmer, a woodsman, or a guide, somewhere, who has at some time been kind to you, and to whom you would like to show your appreciation? Then send him RECREATION. It will tickle him a whole year, and you will never miss the dollar.



## FOXES IN THE BIG SWAMP.

C. P. FRANKLIN.

An account of a fox hunt I had in February last, in Jersey, may interest some of your readers. While the fox is not big game, he will usually keep one guessing for an hour or so before his brush can be carried home. For one who enjoys the music made by a pack of hounds, there is no better game to produce that sound.

The country where we hunted is about 15 miles from Woodbury, near a place called "Brooklyn," better known as the "head of Egg Harbor river." It is a district 2 or 3 miles across and 35 long, made up of swamp, scrub-oak, and meadow, cut by small streams.

We were up before daylight, and after breakfast started to drive to the swamp, picking up the other members of the party on the way. It was cold, and the little Japanese "hand-stoves" in our pockets were useful. As we drove along, stopping here and there, with a yell to bring out some one to join us, the gradually lengthening line of wagons and buggies soon looked like a funeral train.

We arrived at the swamp with 12 wagons, containing nearly 30 men, with 24 dogs, of a general assortment. There were fox-hounds, dachshunds, terriers, spaniels, and "just dogs." We were to hunt on foot. The air being frosty, there was no trouble about the scent lying well. It was not long before some of the younger dogs were off in full cry, but we soon found they were following the scent of other dogs that had been chasing rabbits. Then the young dogs struck their own back trail and followed their own scent; a proceeding looked on with great disdain by the older dogs. They were able to tell almost instantly whether the trail was fresh, if it belonged to a fox, and whether it was a forward trail. To the dog Major was usually left the decision as to the value of a scent.

We got on a good trail about 11 o'clock. There was a general scramble to follow the hounds, first up, then down, then back, mile after mile, the cry growing louder and louder as the chase came near us; then gradually dying away, as it left us.

At last, the dogs were evidently working up on the fox and tiring him, for there was a distinct change of tone in the cry. It became louder, more rapid and excited, and we were all on the jump to be the first to catch a glimpse of him, when suddenly the whole picture of the hunt burst into view.

The sleek-looking gray fox came first, on a swift lope, with the dogs strung out at his tail. Their tongues were hanging out, some of them fairly staggering, from the pace they had kept up; but full of grit, with wind

enough to not only run, but to give tongue also. A son of Major was at the fox's tail, with Major second. As we looked, the old dog fairly leaped over the younger one's back and seized the fox by the neck.

The nearest man ran in and grabbed the fox, and then had a *mauvais quart' d'heure*, as the French say, fighting down the excited dogs, as they struggled and leaped at the fox, to get a bite and to smell the scent they had been following so vigorously.

The training and instinct of the older hounds, Major especially, is shown by the fact of their never being deceived by an old scent. Nor would Major follow the trail of a fox after it had been killed.

Another scent was found almost immediately, and the sport continued. Holes, or "earths" have never been found in this swamp, which makes it an especially fine hunting-ground. Many fox hunts elsewhere have come to an inglorious end owing to "our friend of the brush" taking to earth at the critical moment. The foxes of this swamp, apparently, have cleaned out all other animals; for, except an occasional rabbit, there is no other living thing, not even a bird, to make interfering trails.

The second fox was shot by one of the hunters after a short, exciting chase. Then came a rest, to eat lunch, and to look after the horses. Of course, every one was in good humor. A fire was lighted and all crowded around. Then jokes, old and new, were bandied, and tales of wonderful feats performed by each man's dog, were told, some of them facts, some of the Munchausen order. The whole picture once seen was not soon forgotten. The crackling, roaring fire, the circle of rough-looking men, with the dogs playing, snapping, and fighting for a warm place by the grateful heat, as someone suggested, looked like a cross between a sheriff's posse, and a Cuban expedition.

We started again, with some grumbling about wet feet and heavy guns, but with no signs of backing out. As I had on hip boots of rubber, and my weapon was a 22 repeating rifle, I was not among the growlers, and could walk through the streams, cracking the thin ice, with impunity, while the others had to look for a pole to cross on.

Another trail was soon found, and the chase began again as though we had never before seen a fox; all troubles and tired feelings were forgotten in a moment. This time the fox gave us a long run, finally getting away, for darkness came on, and we gave it up. The dogs held on as long as they could, only stopping when, as the chase came near us, their masters called

them off, one by one, all but Major. He came home the following day, although 12 miles away. His long ears were cut, scratched and bleeding, from running through the brush in the dark.

The skin of one fox lies at my feet, and

every time I look at it, I think of the sport I had in getting it, only a few miles from Philadelphia. The party was out 6 times last winter, getting about 10 foxes, all of them gray. The supply is apparently inexhaustible.



AMATEUR PHOTO BY E. J. SWETLAND.

THE SHEPHERD AND HIS SHEEP.

## GRANDFATHER'S WISH.

J. C. BRIGGS.

When buds first swell upon the trees,  
When I first hear the hum of bees,  
When brooks are filled by frequent rain,  
I would I were a boy again.

When willows by the brookside sprout,  
When all the boys go after trout,  
When robins sing on hill and plain,  
I would I were a boy again.

When days begin to warmer grow,  
When moist South winds begin to blow,  
When flowers are blooming in the lane,  
I would I were a boy again.

# ELKLAND.

## III.

### OLD-TIMERS.

ERNEST SETON THOMPSON.

In previous letters I have written of the game. Let me now, for a time, make game of man.

Some of the American magazines have, for years past, been feeding the people on accounts of personages who played more or less prominent parts in the politics of Europe 100 or 1,000 years ago. Although these same histories are perfectly well-known and already fully remarked on in 100 different forms the discovery of a few trifling personal letters, or peculiarities; the accidental turning up of a new anecdote, or another doubtful portrait, is considered sufficient justification for a new rehash of the man's entire history. Within a few months the transfer, from England to Germany, of a wretched little barren rock, off the coast of Europe; and in South America a squabble over an inaccessible strip of jungle has called forth whole libraries of historical documents and reports.

All this, while a stupendous historical event—a vast revolution, is going on and is, under our very eyes, nearly completed—unnoted, unheeded, unheralded, and, to any adequate historian utterly unknown. I refer to "The Winning of the West" as it has been styled by one who, in advance of his time, has realized its importance.

This Westward march of the white race has at last been completed, and a vast empire finally wrested from a weaker race. Thus, though the fate of a continent of land, untold treasures of gold and millions of human beings have been decided within 2 generations—after thousands of battles and thousands of deeds of incredible heroism on both sides, it has not yet occurred to the average historian, that here is any event worth writing about.

Why? I don't know. I suppose the fashion is not yet set. Or, some may say it is too soon. We cannot write, historically, about an event when it is before us. This may be true, but what about the materials for the history when the time does come? It does not yet exist on paper. The men are dying out who made this epoch and who know the story of it. When the event is consummated, and the time ripe for the great historian who is to come, and tell how the empire was won, he will be unable to build his book for lack of proper records.\*

\* Bancroft's "Pacific States," Appleton's "Story of the West" series of books, and many papers published in previous issues of RECREATION should be excepted from this general statement.—EDITOR.

Let me now adjure every man, who bears in his head a scrap of the history of the West, to put it on file somewhere—in RECREATION, for instance. Let him write it as a history if he will and fail of greatness as he may, but let him put it where the real historian may find it, cull it and mill it till he gets out of it all the priceless stuff it contains. So let the chronicler go on gathering till he shall have collected all the precious metal necessary for that glorious,



J. F. YANCEY.

Has been on the plains and in the mountains since 1851.

golden web that is to attest the greatness alike of the recorder and of the event.

Now by way of setting a good example, away up here in Yancey's log shanty, in the Yellowstone Valley, let me jot down a few stories from the lips of Old-timers; of pioneers; of founders of this empire, who pass and repass and silently, almost mournfully regard the new race of whites that is succeeding them.

"Uncle John" Yancey himself, is a good example of the old-timer; as rugged as a mountain and as gentle as snow.

Born in Kentucky, in 1835, of the famous

old Virginian stock, John F. Yancey was early introduced to frontier life. An uncle of his had been a well-known trader in the great Southwest, of which Independence was the port of entry. His superb outfit, of over 100 pack mules, was well known in that country—Mexico they then called it—and he both made a large fortune and lost his life in the adventurous business before John Yancey was born. Undeterred, however, by the dangers of the West young Yancey, in 1851, then but a lad of 16, made his first trip, going far into Mexico. In 1854, after sampling the alkali in what are now a dozen different States, he drifted into Beckwourth Valley, California, and put up for a few days at the "House" of Jim



TASWELL WOODY.

Forty-niner, now camping with Yancey.

latto, or might have been an Indian, but for his kinky hair, which he wore at full length. He was about 5 feet 11 inches in height, and had enormous chest and shoulders, with muscular strength to match, for he weighed 190 pounds, in training. He was a man of reckless courage, a fair revolver shot, an expert with knife and rifle, and had a weakness for getting married. The quickness of all his movements was his most remarkable attribute. This applied also to his running, for he had legs like those of a deer and lungs like those of a greyhound. He was never beaten in a foot-race and Yancey gives full credence to the story that Beckwourth once, when pursued by the Sioux, ran 95 miles in 24 hours.

According to Taswell Woody, a common report is that Beckwourth moved to a ranch South of Denver, in 1864, but in 1867 became possessed of a longing to see some of his old time Crow companions; and setting out North he joined a band of



J. H. MOORE—"OLD PIKE."

Came to Montana in 1865.

Beckwourth, the famous scout and ex-Crow chief.

When Yancey entered the door Jim was playing poker with a stranger, who, on a flush, put it up to \$200. Jim raised to \$500. The stranger called and Jim laid down 2 pairs of queens.

The incident was curious because Beckwourth so rarely played, and because it showed the scale on which the early Californian conducted all money matters.

Beckwourth drank seldom and little. He was simple in his tastes and habits and straightforward and gentle in his manner. Occasionally when much interested in the talk he spoke rapidly, "like he was hot."

In general Yancey corroborates the story, as published in Bonner's "Life of Beckwourth," and especially lays stress on the fact that Jim was the biggest liar West of the Mississippi. Nevertheless Yancey attests the truth of some of the most incredible parts of Jim's history and supplies some personally descriptive information that, strangely enough, was omitted by the historian.

Beckwourth, he says, looked like a mu-

his old tribe near Clarke's falls of the Yellowstone. The band was almost immediately surrounded by a Sioux war party and every one, including Beckwourth, killed by their relentless foe.

Yancey doubts this story because he himself lived among the Crows, from 1871 to 1877, and heard nothing of it. Many of the older people talked about Beckwourth, their former chief; but by the younger generation he was quite forgotten. So much for a race that has no system of records.

Yancey believes Beckwourth died on his ranch, near Denver, in 1867; being then over 70 years of age. Among the Crows he saw an Indian, named Crazy-Head, who

was said to be one of Beckwourth's children.

Taswell Woody, the well known guide, whose portrait I give, is a Missourian by birth and is one of the few remaining 49ers. He went with the great rush to California, in '49; then with the stampede to Australia, later to British Columbia and is now going to Alaska. He is well known to many Easterners, not as a gold hunter, but as one of the best hunter-guides in the West.

Away back in 1865 2 mountaineers, named J. H. Moore and — Miller, better known as "Old Pike" and "Horn Miller" came into Montana to make their fortunes. They have made them, or have been within one



TOM DUFFY.

Ex-Deadwood stage driver.

jump of making them, many times since then; and they are still pegging away, hopefully, together. They came through and stopped at Yancey's the other day. I got a sketch of "Pike," but "Horn," who gave the name to Miller's creek, escaped me for the present. When these men first saw the Yellowstone, in 1870, the slopes of the valley were darkened with buffalo; and the great broad-fronted skulls strewn about every hollow, abundantly attest the truth of their accounts to-day.

Tom Duffy, whose portrait appears on this page, is a good type of the straightforward, frank plainsman. For 4 years prior to 1882 he drove the Deadwood coach, from Laramie, and was secured by Buffalo Bill to drive the old coach when the "Wild West Show" went to Europe.

During March, 1882, the great Dakota blizzard took place. I remember it only too well; for it occurred as I entered the West for the first time, and I was snowed up 19 days, South of Pembina. Away down at the other end of the storm Duffy was driving his 6 horses and had one of his many narrow escapes from death. It was of course impossible to keep the trail. All he could do was to keep the horses moving. Next morning he was 12 miles off his road but he reached a place of safety. One half his face was so severely frozen that it was 2 years before he fully recovered; but he was lucky. Duffy had no passengers this trip, but the other coach had 3, all of whom were frozen to death.

\* \* \*

Here by the camp fire we sit, my wife and I, amid the historical scenes, in this ancient land of the Crows, surrounded by land-marks that to the Old-timers, tell endless tales of joy and sorrow, human suffering and human heroism. Here I am gathering the fragments of their past history, recalling my own early days in the Northwest, and while hearkening to the wild tales of the mountains and of the past there comes over me a strange feeling of sadness, that almost shapes itself into the question, "Why was I born too late?" Then common sense reminds me that the glamour of memory and romance is over it all; that 20 years from now the present will wear the same charm for younger men, and that, after all, the best, the very best of all times, is the living present.

\* \* \*

#### A SONG OF THE WEST.

A meadow lark sang as the sun went down,  
He sang in the dying glow.  
He stirred up my heart with his artless art,  
And his song of the long ago.

#### REFRAIN.

He sang me a song of the West, the West.  
He set all my feeling aglow.  
He brought back the days of my youth  
with his song,  
His song of the long ago.

A coyote howled when the light was gone,  
A voice on the wind from the East:  
My horse turned his head from the place  
where he fed,  
He heard but a hated beast.

#### REFRAIN.

But he sang *me* a song of the West, the West, etc.

A Sioux in his teepee away in the night  
Drummed a chant of the "Buffalo days"  
Till the men with me swore at the savage  
uproar,  
And cursed him, his drum and his race.

#### REFRAIN.

But he sang *me* a song, etc.

The moon in the morning was still in the sky,  
 But the mountains in day were aglow,  
 And the girl by my side—the blue-eyed, my bride,  
 Sang, but not of the long ago.

## REFRAIN.

She sang me a song of the West, the West,  
 Swept sorrow and worry away;  
 She stirred up my heart with her tuneful art,  
 And her song of the strong to-day.

## ADRIFT ON AN ICE FLOE.

PETER AWICK.

On a bright day in June, a party of 5 Arctic travelers and 3 Eskimo hunters left the shore, to make their way over the ice floes to a ship, seen some miles away. She was steaming about to prevent getting caught between the immense floes, which were being twisted by the tides.

Between the floes were leads or lanes of water. These we crossed, with our dogs and sleds, by traveling along the leads until a loose "pan" of ice was found. Upon this we clambered, when it was pushed away from the solid ice with harpoons and poles. It was slow work crossing, but gradually we would near the opposite side, using the harpoon shafts for paddles. When within about the distance a walrus-line would reach, one of the Eskimo would coil his line, made from seal skin, and, fastening one end to his spear-handle, would throw it, to stick it into the ice. Holding to the other end of the line, as soon as the spear was fast, he would begin to pull, very gently, just enough to keep our raft moving. Safe on the floe, the Eskimo whipped up the dogs.

In this way several leads were crossed. After driving over an immense floe in which were several icebergs, we arrived at a very wide lead. In vain we searched for a loose piece of ice. The ship appeared to be steaming away, and the lead was getting wider and wider. We tried to retreat, but found we had drifted some distance from the last floe, and the pan which had served for a raft had drifted beyond our reach.

We now realized that we were prisoners on an ice-floe, drifting out to sea.

When we had been out for nearly a day, we thought it best to try to sleep. The sun was warm; at this season, shining brightly throughout the 24 hours. After a hasty luncheon—we had little food—the dogs were secured; then, planting the harpoons in the ice with signals fastened to them, we lay down on the ice for a rest. We hoped the ship would see the signals and come to our relief.

The rest of the party was awakened some hours later by one of the Eskimo, exclaiming: "The ship has gone!"

Shivering, I opened my eyes and glanced about. The ship was nowhere to be seen.

The landscape had changed; the high cliffs with their picturesque rocks forming figures of castles and men, covered here and there with patches of snow, which had loomed up near us when we lay down, were now specks in the distance. Our big ice raft was being carried out by a strong current. A storm was threatening, so we began to look about for shelter. The floe was perhaps a mile in length, by half as wide. Several icebergs were examined in the hope of finding a cavern. Finally a small cave, scarcely large enough for all to squeeze into, was found. However, the Eskimo soon built an addition with blocks of snow and ice. In an hour we had a comfortable shelter, with a hole through which we crawled on our hands and knees. When all were in, the opening was closed with a block of snow.

The Eskimo carried on their sleds a number of seal and reindeer skins. These were brought inside and spread around for us to sleep on. We had 2 rifles and plenty of ammunition; so except for food, we were not badly off. One of the natives, who had been out for some time, came running to the opening, exclaiming: "We now have plenty to eat. I have killed a seal."

The best parts of the animal were cut off and laid in a niche in the ice, away from the dogs, while the refuse was fed to those hungry brutes. A big piece of the seal was passed through the opening, and when all were in and the opening closed, we began, in true Eskimo style, to eat the raw meat. The chunk was passed around, each man cutting off a mouthful as it came to him.

The natives had several tin cans on their sleds, that had been picked up at our camp on shore. These, later, served for utensils in which to boil meat. Water we obtained from holes in the icebergs. The heat of the sun was strong enough, for a few hours each day, to melt the snow in the most exposed spots. With some moss which the natives had, and fat from the seal, a fire was built. We now huddled together for a rest. The storm—snow and wind—had begun, and the dogs on the outside howled dismally.

One by one we fell asleep. Some hours later a rush of wind awakened everyone.

One of the blocks of snow had fallen in, but was soon replaced, though not until we were covered with snow. The raw seal meat was passed around for another meal. The storm had abated, although the snow was still falling. So we stayed in our icy quarters for almost another day; drifting we knew not where.

On the 2nd day the storm ceased and the sun came out bright and warm. We were pretty well chilled when we crawled out, and felt the need of exercise to start circulation. Most of the snow had been blown off the floe, except against the icebergs, where it was drifted. There was, apparently, no chance of escape from the ice; and we were getting farther away from shore all the time.

The Eskimo looked in vain for the ship or for signs of other members of their race, exclaiming: "Kayak terrongy too." (We have no kayak, it is gone.) Several days went by, we anxiously watching and waiting. Our party lived on seal meat, with an occasional gull for a change. There were plenty of seals; and as long as these lasted, and the floe held together, we could at least live and hope.

The natives were expert seal hunters. They insisted on using their harpoons, for, they said, they made no noise.

On seeing a seal, one of the Eskimo would get down on his hands and knees and crawl toward it. The instant the seal looked up, the hunter would drop flat, face down, and imitate the movements of a seal. Dressed as he was in furs, he could hardly be distinguished, at a distance, from the game he was hunting. This was continued until the hunter crawled near enough to throw his harpoon. Then, waiting until the seal dropped its head, the hunter would raise himself on one elbow, and the harpoon would be hurled, like a flash, into the unsuspecting prey. One end of the line was held in the hunter's other hand, so it was the work of only a few minutes to pull the seal to the edge of the ice. A rap on the head, with a spear, and the hunt was over.

We had been on the floe about a week, when, one day, something was found that at a distance looked like a barrel frozen in the ice. It proved to be a coal-oil barrel, and near it were several pieces of a boat. The barrel was empty, but with the staves and pieces of wreck, we could have fire enough to cook some meat.

The seal were getting shy; finally they quit coming to our floe altogether. One evening we ate our last piece of meat; but the dogs remained. There was no alternative—it was dog meat or starve. The weakest of the poor brutes was killed and fed to the rest of the pack. A strong, healthy one was selected for ourselves.

Part of it was boiled in sea water, but when it was served there was a look on

the faces of some as if the thought alone was enough. Gradually we all came to it. Hunger will make a man do most anything! In a few days the meat was eaten with a relish. We were now living on 2 meals of this each day. The number of our dogs grew less, until finally the last one would have to be killed in 2 days. One of the sleds had been used for fuel.

A bright thought came to one of the natives one morning. He proposed that a kayak be made from the remaining sleds and the skins of seals.

The 3 Eskimo, assisted by us, set to work with a will. In a short time a rough frame was lashed together and the seal skins were scraped ready to be sewed on. Now, if an Eskimo owns a needle, he always carries it with him, in order to keep his boots in repair. All three of ours produced needles from little sealskin pouches, while for thread, they used sinew of reindeer, which is also carried along.

When the rough canoe was finished, it would hold only one man. One of the natives suggested that he be allowed to go, paddling from floe to floe, following the leads to shore, where he would find others of his tribe. He would then send help to us. The man said he recognized a certain high peak ahead. If he could make that, he was sure of finding natives.

A shout came from one of the men. On looking in the direction indicated, we saw that our floe had drifted against an immense grounded iceberg, and we were likely to stay here some time.

The native who was to go in the kayak started immediately after the floe stopped drifting, knowing he could easily locate us again by the big berg against which we were lodged. We watched the little boat depart, with much anxiety, and stood gazing after it until it was lost behind the hummocks of ice. The next day we walked up and down the floe, looking and listening. In the afternoon a shout came across the water. We saw figures of men in the distance, among the hummocks; then, presently 4 kayaks came into full view, each paddled by an Eskimo.

Our friend had found a village, and these men at once started to our rescue. Two kayaks were lashed side by side, and on these 2 men could be carried with no danger of upsetting. When all, including our lone dog, were over a lead, we would make a short cut across the floe, carrying the kayaks, until we again reached the water. In crossing the last lead, our dog plunged into the icy water and swam to shore—he was probably more anxious than we to reach land again.

The little village was made up of 7 families, on a low, flat beach. These people treated us kindly, and made us as comfortable as possible.

Our camp was a long distance from there,

and the only way to reach it was by an overland journey. Two of the natives agreed, for a knife each, to act as guides. The next day, with a supply of meat, we started, and for 4 days climbed over rocks, waded through snow, crossed streams and glaciers, sleeping among the rocks at night. In crossing a glacier, we nearly lost one of our companions.

The guides said it was not safe to walk on a certain glacier without all taking hold of a long line, for the ice sounded hollow. It might break and let us down. One of our companions, who was always in the rear, would not hold on to the line, as he thought it unnecessary. In crossing a deep crevasse, on a snow bridge, the man

stopped to look down. There came a crash and a roar. The bridge, with our companion, had disappeared. Horrified, we turned back, though we never expected to see the man again. A shout came from the crevasse. He was alive! With a line fastened about his waist, one of the guides crawled to the edge and looked down. Not more than 25 feet below, our friend stood on a shelving mass of snow. A line was passed down to him, and he was hauled out, badly frightened, but unhurt.

A high cliff overlooking the site of our camp was finally reached; then, in a short time, we were back in our old quarters with our friends, and never again did we trust our lives to the uncertain ice floes.

---

## IN AUTUMN TIME.

### OLANCHA.

When the brown, dried leaves of autumn,  
Floating earthward on the breeze,  
Sound that gentle, far-off rustling,  
As they blow against the trees—  
And the forest softly moaning,  
While the wind goes whistling through,  
Sending show'rs of ripened chestnuts  
Down among the drops of dew—

Something smould'ring in my nature  
Then is fanned to life once more,  
With that burning, restless longing  
Felt so many times before;  
And I catch my mind oft wand'ring  
From the duties of the day  
To the dark and stately forest,  
Ah! so many miles away.

Till at length is born a feeling  
That I cannot well explain—  
Though 'tis known to ev'ry hunter—  
Far from power to restrain;  
So I pack my traps together,  
Oil my rifle and my gun,  
Cast to wind the cares of living  
With the setting of the sun.

Call my dogs to make them ready  
Long before the break of dawn,  
For they, too, have caught the fever,  
And are eager to be gone.  
Why, the short time spent in travel  
Seems to never have an end,  
Scarce can I control my patience  
Till the train comes round the bend!

When, in time, I've gained my freedom,  
Reached at last my hunting ground,  
Ev'ry fibre in my being,  
With my pulses, seems to bound.  
Here the golden autumn sunshine  
Seems to clarify the air,  
And my lungs are filled with fragrance  
From the balsams growing there.

As I lay me down at even,  
In the camp-fire's beaming light,  
Warmly wrapped in heavy blankets,  
Gazing out into the night—  
Then I watch the sparks ascending,  
Hear the great logs crack and hiss,  
Till my soul is soothed and rested,  
And my heart is filled with bliss.

And I wonder, as I lie there,  
Quite at peace with all mankind,  
How my brother in the ball-room  
Can the least enjoyment find—  
If he would not gladly follow  
In my footsteps as I go—  
Gladly make his home the forest,  
With the nimble buck and doe.

---



## THE WOLF QUESTION.

FROM CENTRAL WYOMING.

Casper, Wyo.

Editor RECREATION: The wolf question, brought forward in the July number of your magazine, is well worthy of the thoughtful consideration of all Western stock growers. Ten years ago a gray wolf was a rarity, in Central Wyoming. Now there are thousands. They are slowly spreading Southward, and in a few years they will cover the entire range country, clear to the Texas border. Three years ago there were none in the Saratoga valley, of Southern Wyoming. Now they are numerous and destructive, and are rapidly crossing the border into Western Colorado. The damage they do to all classes of live stock is incalculable. In Wyoming they destroy more stock than all our taxes, county and State, amount to and their ravages steadily increase. They killed fully \$1,000 worth of cattle, mostly calves and yearlings, for me last year. They are very destructive to young colts, and whenever a sheep raiser is so unfortunate as to lose a portion of his flock on the range, as frequently occurs, the wolves completely wipe them out. Stock is so plentiful that I never knew of wolves attacking a human being. In fact they are extremely wary; and where bands of sheep are closely herded and watched, the wolves usually leave them alone. In winter they will run a full-grown steer into a snow-bank, or a gulch full of drifted snow, and kill him. They usually travel in packs of 2 to 20, and when in pursuit of a victim, their howling will attract others, for several miles.

A full grown wolf will weigh close to 100 pounds, and ranges from 2 to 3 times the size of an ordinary coyote.

This coyote is a great nuisance also, but is easily destroyed. They are of no benefit, whatever, in keeping down gophers and ground-squirrels. They destroy many sheep and lambs, and frequently kill young calves; living principally, however, on rabbits and sage-hens, with an occasional prairie dog mixed in, for an appetizer.

There are only 3 ways of killing wolves—poisoning, trapping, and shooting. Dogs have proven useless, in this mountainous country. Shooting them is rare sport, and with a good tracking snow and a swift horse, it is far more exciting than hunting bear. No. 4 steel traps are quite successful, but it takes lots of patient, hard work, to get sufficient bait, and to properly attend to them. Poisoning is the best and surest method of extermination but unfortunately there has never been invented a poison that would act with sufficient certainty and despatch. In winter a wolf will

devour a rabbit full of strychnine, and then travel completely out of the country, without apparent discomfort. Last fall I bought \$60 worth of strychnine, and put out immense quantities everywhere. In one place I shot a big-jawed steer, and filled the carcass and entrails with 3 ounces of poison. The wolves ate it up slick and clean, but I never found a dead one. I am satisfied it killed a number, but they went so far before the poison took effect, that I could never find them. Recently I poisoned 3 with the same brand of strychnine. All of these I found within a quarter of a mile of the bait; so I infer that in hot weather, the poison acts more quickly.

In regard to the best method of exterminating these pests, I think all the Western States interested should get together, and establish a uniform bounty; this to be steadily increased, year by year, as the wolves grow scarcer, until they are finally wiped out.

Wyoming's last legislature appropriated \$30,000 to pay a State bounty of \$4 on each full grown gray wolf, and 75 cents each on coyotes and wolf puppies; but many of the surrounding States pay no bounty, and this works a hardship on Wyoming. In addition to a bounty, I think the Western States should combine, and offer \$5,000 for the invention of a suitable poison, that would prove instant death. Then the States should lay in large quantities of this poison, and distribute it gratuitously.

B. B. Brooks.

FROM EASTERN COLORADO.

Prairie du Chien, Wis.

Editor RECREATION: I have been reading July RECREATION, in which you ask for information about wolves. I spent some time on the plains of Eastern Colorado, during 1882, 3 and 4, in the employ of the U. S. government, locating and superintending the location and boring of experimental artesian wells. During the fall of '83 and the winter of '84 I was at Cheyenne Wells, Colo., 177 miles Southeast of Denver, engaged in putting down a well. I found there wolves (*Canis occidentalis*), prairie wolves or coyotes (*Canis latrans*) and swifts, or sand foxes.

I procured some small double-spring New-house traps and set them, and at the end of 6 weeks had one large gray wolf, weighing 90 pounds, and measuring 5 feet 11½ inches from tip of nose to tip of tail; 13 coyotes, 33 sand foxes, one badger, one skunk and 5 kangaroo rats.

I lost 5 traps, the chains not being strong enough to hold the gray wolves.

My method of trapping these animals was

to take a piece of fresh beef and roast it in the stove; fix a string to it, sufficiently long to go over my shoulder, and then drag this after me wherever I went to set traps, which would sometimes be 3 or 4 miles from camp.

On the plains there are many ledges of earth that have been eroded by storms. I would dig a small hole in front of one of these, pin down my bait and set the traps about 16 inches below and in front of the ledge, so as to get the wolf by the foreleg. When caught, he would start to run. The trap chain would draw his foreleg back under his body and I have often seen a wolf turn a summersault. This operation would take up more of the momentum of the body than it would if the animal were caught by the hind leg. I found it quite as simple and as easy to capture any of these animals as it would be to catch a domestic dog or cat, notwithstanding all that has been written and said of the wonderful cunning of foxes and wolves.

Chambers's Encyclopedia says,

"Wolves have been known to eat off the cord to a set gun, so they could eat the bait without being shot!" Bosh!

There is one peculiarity about the coyote that is interesting. When caught in a trap and he sees you approaching he will always jump around frantically. If you yell at him loudly to lie down, he will nearly always do it; not of course to obey you but evidently to hide himself in the grass.

The large gray wolf is quite different. The one I caught was very ferocious and snapped his teeth and glared at me savagely. I killed him with a 38 calibre revolver, putting a ball through his heart. He made a savage jump for me but fell dead.

Wolves destroy many sheep in Eastern Colorado, and it is necessary to corral the sheep at night, in a high, tight board fence, and to accompany them with herders and dogs during the day.

I never knew of a gray wolf killing a human being.

I consider the coyote a nuisance. He is a sneak thief and will kill lambs, calves, chickens, etc.

Horace Beach.

#### WHAT UNCLE SAM SAYS OF THE WOLF.

In the year book, soon to be published, the Department of Agriculture will give some valuable data on the wolf question.

It cannot be said that in the United States bounties have brought about the extermination of a single species of animal in any State. The rarity of wolves East of the Mississippi river is rather due to the settlement of the country than to the number killed for rewards. On the great plains wolves have not decreased perceptibly, notwithstanding high premiums paid for scalps. Coyotes have increased in California during the last 3 years, since the boun-

ty on them was withdrawn, so that there are now as many of them in that State as ever. California, Montana, and Texas offered \$5 apiece for coyote scalps, for some time, the outlay aggregating hundreds of thousands of dollars; but the results were unimportant. Iowa and Minnesota are the only Western States which now pay more than \$3 for a wolf scalp, and in Iowa the rate for young wolves is \$2.

Meanwhile in some parts of the country wolves and coyotes are very destructive. In New Mexico they kill from \$150,000 to \$300,000 worth of sheep annually, and in Nebraska the damage done to sheep is reckoned at \$100,000 a year. One difficulty in the wolf problem lies in the fact that it is impossible to secure the co-operation of all the States. This lack of agreement, on the subject of bounties in general, opens a wide door to fraud. Scalps taken in localities where rewards are low are shipped to places where premiums are high, and thus it often happens that a county is compelled to pay for animals killed in another county. The bounty on wolves and coyotes now varies from \$1.50 to \$5, the latter price being paid in the Black Hills region of South Dakota. In North Dakota it is \$2, it is \$3 in Montana and Wyoming, and in Iowa \$5, except for young animals. Thus rewards may be claimed, profitably, in Iowa for coyotes killed in North Dakota.

The wolf bounty in Nevada was 50 cents when California was offering \$5 for scalps. Consequently, thousands of scalps were shipped from Nevada to California, and large numbers of them were actually imported from Mexico; so that California found herself getting poorer at a distressing rate, and the bounty law was repealed.

#### FROM RIO BLANCO COUNTY.

Editor RECREATION: In July RECREATION, page 45, a number of questions are asked about wolves, which I will answer.

I am located in Rio Blanco county, Colo., a long narrow county, the Eastern part of which is high and snowy. Wolves do little damage here, as there are few of them. The Western portion of the county, however, is not so snowy and is the home of a large number of wolves. They work principally on cattle, especially yearlings and calves, though cows, and even steers sometimes furnish them a good meal. A few years ago there were comparatively few wolves here, but they have been increasing until last winter, when quite a number were poisoned, though not enough to materially diminish their numbers.

I have never seen anything that would lead me to believe they had any way of signaling to one another. The coyotes kill a good many calves but do not attack the larger animals.

The best way, I should judge, to get rid

of the wolves would be to offer a bounty high enough to justify men hunting them, as a business. I have killed a number of wolves at different times. They are difficult to poison as they prefer to kill their own game; but are fond of horse meat, and at the present price of horses, could be poisoned if the bounty were large enough. The great trouble with bounties has always been that the men who earn them, are forced to sell their certificates for much less than face value, so that while the State or county might put a \$10 bounty on these animals, men who would hunt them, if they thought they could get the full amount, would not bother with them when they know they could only get 50 to 80 cents on the dollar for their certificates, and might not be able to sell them at all.

Young wolves can be smoked out of their dens, in spring, but the old ones will often stay in the hole until suffocated by the smoke. J. M. Campbell, Buford, Colo.

---

FROM THE BIG HORN MOUNTAINS.

Ten Sleep, Wyo.

Editor RECREATION: I am glad to see someone take hold of this wolf problem. They are getting very troublesome and numerous in this part of the country. Yesterday I found a 2 year old steer of mine, that had been killed by them the night before. This makes the 3rd one they have killed for me in the past 6 months, that I know of, and probably several others have been killed that I have not found. My neighbors are complaining of the wolves, and have all lost more or less stock by them. Still we are not bothered so badly here, as stockmen in other parts of the State.

I know of 23 head of my cattle having been killed in the past 6 years. At the rate the wolves are increasing, unless something is done to rid us of them, they are going to be a great scourge to the stock industry, in this country.

The mountain lion is another animal that does a great deal of damage to stock and game, in this country.

The wolf is hard to trap or poison, and this makes it difficult to get rid of them. They seldom eat a second time on a carcass they have killed; but generally kill a fresh animal for each meal.

I here submit answers to your questions in their order:

1. Where are you located?

At Ten Sleep, Bighorn county, Wyo.

2. Are gray wolves troublesome in your region?

Very.

3. What do they destroy? Horses? Cattle? Sheep?

All three.

4. About what amount of damage should

you estimate they do in a year, in your county or range?

In my judgment \$5,000 a year would be a low estimate for our range, or say within 25 miles square.

5. Did you ever *know* of a gray wolf killing or harming a human being?

No; but have heard of such cases, indirectly.

6. Are wolves increasing in numbers?

Yes.

7. Have you any reason to believe wolves can signal across country, and so tell each other what parts are dangerous, or where the hunting is good?

I don't think they can.

8. What is the average and the greatest weight and measure of a wolf, according to your certain knowledge?

I never weighed one, so cannot say.

9. Do you consider the coyote a nuisance; or do you consider the harm done in killing lambs, etc., more than balanced by the good they do in keeping down gophers, ground squirrels, etc.?

I think them a nuisance, and they should be gotten rid of.

10. What do you consider the best means—legislative and practical—of dealing with the wolf question?

Our State Legislature should place a bounty of \$6 a head on wolves, and \$1 on coyotes. As it is now our State pays a bounty of \$4 on grown wolves and 75 cents on wolf pups. This is one of the most absurd bounty laws I ever heard of.

Milo Burke.

---

FROM THE BIG HORN COUNTRY.

Meeteetse, Wyo.

Editor RECREATION: I take pleasure in sending you answers to the various questions on the wolf plague.

1. In Bighorn county, Wyoming.

2. Yes.

3. Cattle and horses; few if any sheep.

4. One wolf kills one yearling (cattle) a week. A yearling is worth \$15; therefore one wolf destroys \$780 worth of cattle a year. I estimate the number of wolves in Bighorn county at 500; therefore our country suffers a loss of \$390,000 a year.

5. I never knew of a case of this kind.

6. Yes.

7. I do not think they can.

8. Have never measured or weighed a wolf.

9. Coyotes should not be wholly exterminated, but merely kept down. The value of the few calves or lambs they kill is overbalanced by the good the coyotes do in killing jack rabbits, prairie dogs and gophers.

10. A general bounty (including Colorado, Wyoming, Nebraska, Dakota and Montana) of at least \$15 a head on grey wolves,

would do the work. Nothing less will. It would not be necessary to put a bounty on coyotes, as a great many would be destroyed by the trappers when trapping or laying poison for wolves. The same bounty should be paid on wolf pups as on grown wolves. This would cause lots of small ranchmen to turn out, in April and May, to hunt wolf dens and dig out the pups. This would of course require a large outlay of money for the first 2 or 3 years, but it would settle the question in the end. Wolves are so cunning that you cannot make any headway against them with poison or traps. Hounding is not practical in a rough country; but with a sufficiently large bounty on pups nearly all the litters would be destroyed, every year, and as wolves are not long lived, in a few years there would not be many left. Wolf dens are easy to find and when found, in 19 cases out of 20, you can get the pups; very often the old ones, also.

The difference between wolf pups and coyote pups is so apparent that there should be no danger of any enterprising trapper palming off the latter for the former, upon the person authorized to punch the hides and pay the bounty.

Unless something is done soon to exterminate the pests, the live stock business, in the West, is doomed. I am afraid the job is too big now for the different States, and should be taken up by the general Government.

Otto Franc.

---

FROM ARIZONA.

A correspondent of a Chicago paper, writing from Phoenix, says:

"In this part of Arizona the mountain lion is the wolf's equal as a scourge. In the country bordering on the Huachuca, Patagonia and Canelo mountains every colt, of 1895, was eaten; even in the barbed wire pastures they were all killed. Until lately the wolf, in this section of Arizona, travelled alone; but they have now become so numerous that, as in Texas and Montana, they go in packs. Within the past month, on the mesas bordering the Santa Cruz valley, we have found a dozen yearlings killed and partially eaten, and calves are, of course, killed in larger numbers and wholly devoured or carried into out-of-the-way places where they cannot be seen. A statement of the actual percentage of loss would stagger any reader.

"James Parker, a ranchman living close to the mountains, has seen wolves in packs and their depredations are constantly on the increase. We are informed that the same conditions of loss prevail in Cochise and that it is even worse in Graham county, where the supervisors contemplate offering a bounty.

"A county bounty does not by any

means meet the necessities of the occasion. The bounty should be territorial and the law could easily be framed to insure payment only for wolves and lions killed in Arizona."

---

Chico, N. M.

Below you will find answers to the wolf questions, according to my limited knowledge:

1. Chico Springs, N. M.
  2. Yes, very.
  3. All kinds of stock.
  4. Hard to estimate, but an immense amount.
  5. No.
  6. Decidedly so, and rapidly.
  7. No. But they roam around in bunches.
  8. Average weight not far from 100 pounds.
  9. He certainly is, in New Mexico.
  10. By offering a cash bounty of not less than \$10. We have plenty of good hunters that would spend their time exclusively in eradicating the worst enemy the stockman has to contend with, if they could get the cash for their time and labor, and not have to wait 2 or 3 years, which they now have to do where scrip is paid out.
- I wish you all success possible in getting this question before the proper authorities and I will do everything I can to assist. I like RECREATION very much.

P. A. George.

---

FROM THE POWDER RIVER COUNTRY.

Powderville, Mont.

Editor RECREATION: I shall endeavor to answer your questions as accurately as I can.

1. Powder river, Custer county, Mont.
2. Very troublesome.
3. Horses, cattle and sheep.
4. We estimate the damage done us at \$1,000 a year, or more (not less) per outfit.
5. No, never.
6. About holding their own in spite of strenuous efforts to exterminate them.
7. No.
8. —
9. A nuisance.
10. Offer bounty large enough to tempt able men to engage in wolf hunting as a business.

William Ferdon.

---

WAR ON COYOTES.

J. H. Calderhead, commissioner of labor, agriculture and industry, for Montana, has prepared some statistics as to the number of stock destroying animals killed, in that State, for the fiscal year ending June 30, 1897, on which the State will pay bounties as fast as the funds are provided for that

purpose. The report shows that 21,161 coyotes and 4,995 wolves were gathered in; a record that speaks volumes for the shooting, trapping and poisoning skill of the residents of the State. The total bounty on these animals, at \$3 a head, is \$78,468.

WOLF NOTES.

Deer and antelope can be found a few miles from this town. There are also a number of gray wolves in this section of country. Bounties have been collected here, lately, by different parties, ranging from \$50 to \$250, beside the small amounts paid on those which were brought in in lots of 2 or 3. As yet I have had no opportunity to investigate the wolf question personally; but expect to learn something in the near future. Enclosed you will find my dollar for my third yearly subscription. A magazine like RECREATION is sure to

succeed, where it stands on the lines you have drawn. Your work in the interest of game protection is grand and good.

A. D. Anderson, Newcastle, Wyo.

A friend of mine shot a timber wolf, in Michigan, which I measured. It was 7 feet 4 inches from nose to tip of tail, and was considered a very large one, at the office at Au Train, where the bounty was paid. It was alone and was killed, nose down, on a deer runway.

Percy Selous, Greenville, Mich.

I do not believe there are any gray wolves in this valley, though some of the settlers think there are. Coyotes are on the increase here, and we regard them as a nuisance. They do not harm stock, that we know of; but they kill a great many deer and young elk.

S. N. Leek, Jackson, Wyo.

WHILE SITTING IN THE BLIND.

FRANK C. RIEHL.

While sitting in the blind, alone,  
 Just watching my decoys,  
 I feel the subtle ecstasy  
 Of all a hunter's joys;  
 The memories glad of other days  
 Come tripping through the mind,  
 And rests the spirit, satisfied,  
 While sitting in the blind.

The whirring of the widgeon's wing,  
 The whistle of the teal,  
 And echo of my trusty gun  
 Are music just as real  
 As concerts of the rarest price  
 That kings and queens may find;  
 And bring a goodlier return,  
 While sitting in the blind.

With trigger set and steady hand  
 And every sense alert  
 I wait the passing of the birds,  
 And nothing may divert  
 The eye's intentness on the scene  
 As, coming with the wind,  
 I time the mallard's headlong flight,  
 While sitting in the blind.

E'en in the intervals of rest,  
 With nothing else to do;  
 Yielding to introspective mood,  
 I catch the broader view  
 Of life in all its meaning, till,  
 To any fate resigned,  
 I feel a monarch for the nonce,  
 While sitting in the blind.

So speeds the time on wings as fleet  
 As any duck that flies,  
 'Mid pleasure's richest, ripest zest  
 A sportsman's zeal implies:  
 All careless of the world's affairs,  
 Nor to its ways inclined,  
 I envy not a soul on earth,  
 While sitting in the blind.

## FROM THE GAME FIELDS.

### ON A CALIFORNIA MARSH.

Three years ago I received an invitation to have a day's shooting on the Canvasback Hunting Club's preserves. A drive of 10 miles brought Charley and me to our destination, where we found several gunners awaiting us. The Canvasback is the crack, nay, the swell, club of this city. Its rules are rigid and are strictly followed. Among them is one that no shooting shall be allowed the evening before a general hunt; so we were content to watch the ducks and geese pass from one lake to another. Shortly after supper the wind began to rise, and it was soon blowing strong from the Southeast, the rainy quarter. In the morning a gale was blowing and the rain was coming down in torrents. Rain had not been thought of, the day before, so Charley and I were the only ones who had been thoughtful enough to carry rubber outfits.

After breakfast we started for the nearest lake, in a rain so dense it was difficult to see 10 feet ahead. As we neared the pond, the noise of many geese told of a good day's sport before us.

My stand was at the farther end of the lake, and as I started from the shore I scared hundreds of geese and ducks from my end of the lake. I was delighted to find that the blind was so substantially built as to almost entirely keep the wind out. I put out my decoys and settled down to wait for day to break. I had hardly seated myself when a flock of ducks alighted among the decoys. They were followed by others, and soon I was surrounded by ducks and geese.

It is a trying experience, in duck shooting, to have flocks of ducks and geese among your decoys, and you unable to shoot. It seemed ages before it finally became light enough to see, and then it was all I could do to keep from shooting at a flock of mallards, a short distance away. Remembering the warning given me by an old duck hunter, to drive all the birds off the lake before beginning to shoot, I stepped from my blind and was almost deafened by the roar of wings.

I had hardly returned to the blind when a flock of green-wing teal, full 200, whizzed by, coming from behind. They no sooner caught sight of the decoys than they made a beautiful turn and came back, passing within 25 yards. I let go the first barrel into a bunch, and dropped a single bird with the second. As a result of the shots, I had 8 teal for a starter.

I had hardly loaded when a steady "Honk, honk," warned me to keep down. A flock of 10 gray geese were beating up against the wind. I waited until they were

over and a little past; then I made a double. It would have been nearly impossible to miss such a mark, for they were almost standing still.

With this flock the sport began in earnest, and after the first few shots I would shoot at only the choicest kinds of geese; no yelpers or brant or white geese for me, when I had only to wait a minute for a flock of "speckled-bellies." With the geese one shot was a repetition of another, for they all beat up against the wind and passed almost directly over me, generally not more than 10 or 15 feet high. As flock followed flock, it soon became monotonous to shoot at such large marks, so I turned my attention to the ducks.

After a time the rain stopped, the clouds parted and the sun made his appearance for a few minutes. Shortly after this a friend drove down to the lake and suggested that we take advantage of the let up of the storm to start for home, as the others were about to start. It was now a quarter of 9, and in my hour and a half of shooting I had killed 19 geese, 1 honker, and 38 ducks. Excepting the first shot, I did not kill more than one bird at a time. At the house I found Charley, with 23 geese and 14 ducks.

I used, on that morning's shoot, a 12-gauge Daly gun, 3½ drams of black powder and one ounce of No. 7 shot, for ducks and geese alike. When we quit, the geese were still flying, while the air was filled with ducks. At the risk of being called a game hog, I must say I was loath to leave, for the shooting was such as one gets but once in a life time.

W. H. Young, Sacramento, Cal.

### SHOOTING GEESE IN A SNOWSTORM.

Pawnee City, Neb.

Editor RECREATION: Last spring I was staying with a friend, in Nebraska, about 4 miles from the Missouri river. He was a good shot and a persistent hunter. We became satisfied, by signs, that a storm would strike us within 24 hours. We had been talking of a hunt on the river, and now thought the following day would be our time; for the more disagreeable the weather, the better for us.

Carrying out our idea, we hitched a horse to a road-wagon, loaded it down with the necessary accoutrements, and started, about 4 o'clock in the afternoon, for a point 12 miles down the river. We chose this place because of an invitation from another friend to join him in a hunt, and because of its being a good lighting place for geese. The river here is wide and there are long

sand bars, surrounded by shallow water, which is the character of the lighting ground sought by geese.

Before daylight we were on the river. After rowing a mile, we selected a favorable bar and set the decoys. We next dug pits at a convenient distance from them. Getting into these we awaited results. Geese and ducks were flying, but out of range. We stayed in the pits until 11 o'clock; then, being satisfied there would be no shooting that morning, we picked up the decoys, rowed to land and returned to the house.

Before we had finished dinner, the expected snow-storm broke. Our joy was unbounded, for this meant good shooting. We again started for the river, but decided on another bar for our afternoon shooting, and were soon ready for business. It was now 3.30 o'clock, so we could expect no shooting for an hour.

It continued to snow, and a cold, damp wind made it uncomfortable for us. Then, too, a pit, dug in a sandbar in the middle of the Missouri river, is not dry. After an hour of waiting we espied, coming up the river, a mile or so away, a flock of geese.

Closer and closer they came; then they began to circle. Twice they circled before being satisfied all was well. Then down they swooped, with loud squawks, and noisy flapping of wings. We waited until they were within 15 yards, then jumped to our feet. With my first barrel I hit a big fellow, hard, and with the second dropped another. My companion dropped one and wounded another, which got into the river and gave us a hard chase with the boat, but it ended in his capture.

We had just got settled in the pit again when straight for us came a flock of teal ducks, out of which we brought down 4; one, however, getting into the river, made its escape. Another flock of geese soon appeared, like specks, in the distance. They saw our decoys and made for them, but were suspicious and gave us no shots.

This flock was scarcely out of sight when another made for the decoys, but we had to take them at long range, and killed but one.

The next shot was also at long range. I wounded one bird, but my companion missed.

My bird fell 150 yards away and got into the river. Getting the boat I started after him, but owing to increasing darkness he got away. I was partly recompensed for this loss by bringing down a stray duck. My friend knocked down another goose, at long range, but falling into the river, the bird got away.

As it was now too dark to shoot, we rowed to the landing, and reached the home of our friend about midnight, thoroughly tired, but contented with the world.

James F. Prentiss.

#### HOW HE WON HER.

Crawford, Neb.

Editor RECREATION: As one of your readers, I desire to thank you for your untiring efforts, and to congratulate you on your great success, in making RECREATION a household pet. In showing RECREATION to my friends I always tell them it is the next thing to going hunting or fishing, and I advise all lovers of field sports to subscribe.

My wife and 2 children often gather around and ask me to read the hunting and fishing stories aloud.

Near Crawford we have 15 lakes (made by irrigation ditches), the largest covering 240 acres. These lakes furnish good duck shooting in fall and spring. They are stocked with fish, but these are not large enough to catch. White river runs through the town, and it was stocked with trout, about 8 years ago. Now we have trout-fishing at home. We also planted quails a few years ago, and they are now getting quite numerous; while grouse and rabbits are plentiful near town.

I will tell how I got my wife's consent to go hunting and fishing. She used to grumble, and consented to my going only on the ground that I needed outdoor exercise.

One evening I went home and asked her if she would like to take a ride. Of course she consented, so I told her to get the children ready while I hitched up the horses.

She did not see me put my gun and boots into the buggy, and so did not discover my intentions.

We drove to a small lake, where I expected to find ducks. I put on my waders, took my gun and asked my boy to go with me.

I then told her to drive to the next hill, where she would be in full sight of the lake, and she would see us shoot ducks.

The boy and I went round the hill, getting up a flock of mallards. I got 5 with 2 shots. The flock circled, and I dropped 2 more. Then they came past a second time, and I killed another double, making 9 altogether.

Looking toward the hill, I saw my wife standing in the buggy, waving her arms and wildly shouting, "See them fall!" Gathering the birds, we carried them to the buggy and dropped them at her feet.

"I'll never scold you again for going hunting," she said; "that was more fun than I have had all summer. I am going with you every time I get a chance."

We drove home, feeling we had had a pleasant ride. I often take my family now, when I go hunting or fishing, and they enjoy it as much as I.

S.

## WHO KILLED THE BUFFALO.

Gardiner, Mont.

Editor RECREATION: S. N. Leek, Jackson's Hole, Wyo., states, in RECREATION, that "no resident of Jackson's Hole ever killed buffalo in the Yellowstone National park." In a later issue, under the initials of B. V. K., I said residents of Jackson's Hole had killed buffalo in the park. In your August number Mr. Leek admits that buffalo were killed in the park, just where I said they were, on Crawfish creek (not Crawford).

As he says, the men did not live in the timber reserve, that winter, but it is not true that none of them were residents of Jackson's Hole. To my knowledge one of them lived in the Hole until recently. Another lived there until the spring of 1894 when, it is reported, he was killed, on his way to Evanston, to dispose of furs secured during the winter. Another man had his horses in Jackson's Hole during the winter of 1893; but he was reported to be in the adjoining county "wolfing." One of the others was lost in a snowstorm and perished, on Huckleberry mountain.

An article on this subject by C. G. N., of Mammoth Hot Springs, in August RECREATION can easily be verified by any one desiring the truth.

Mr. Leek makes another misstatement when he says the real cause of the park buffalo being gone, is that the syndicate and the soldiers have cut the winter feed of the buffalo, and put it up for hay.

Any one familiar with the facts, knows the soldiers never put up hay in the park and that the only hay cut by the syndicate, anywhere near the buffalo range, is cut on the bottom land along the Yellowstone river, where the snow lies 6 to 10 feet deep, all winter.

The truth is that on account of too many visits by the soldiers, to the winter feeding ground (Hayden Valley), such visits however being necessary to prevent poachers from getting in—the buffalo became scared and split up in small bands, going to the different parts of the park and trying to winter in the deep snow, where those that were not killed by poachers, died of starvation.

For years the calves of buffalo have been killed by the protected bear, wolves, etc., just as they kill the young of all other big game animals, every spring. These are the real causes of the disappearance of buffalo.

Wm. Van Buskirk.

Being a hunter and guide, knowing, thoroughly, the Jackson's Hole country and the people who live there, I beg to say S. N. Leek made an error, in his article in RECREATION, entitled, "Who Killed the Buffalo?"

Mr. Leek does not seem to know that

the 5 men who settled on Warm Spring creek, in August, '91, did so in good faith and that they had a perfect right to do so. At that time the timber reserve was not annexed to the park, and no notices were posted, by Captain Anderson, until later that fall. Theirs was not a case of trespass, at all. Wilson, the Chief Scout of the park informed Tom Brown (one of the squatters) that their camp was 3½ miles South of the park line.

The 5 men who established quarters there, were Tom Brown, Captain Edwards, John Shive, Jeff Simmerson, and Dave Defoe. Only 3 of the 5 wintered there, as Tom Brown was lost in the October snow storm and was found dead some weeks later. Captain Edwards pulled out on snow shoes, early in December. Certainly these 2 men had nothing to do with the killing of the buffalo. Those animals were not killed on Crawford creek, and far exceeded 3 in number.

F. W. Rising, Butte, Mont.

In July issue I see an explanation of "Where the Buffalo Went." Another way of departure was explained to me some years ago, by an old time missionary, Reverend Pritchard, of South Dakota.

In some of his early experiences on the Missouri river he says the Indians, in order to starve out the Northern tribes, with whom they were at war, burned the prairies to the North of the big herds, which he said would extend for miles, to prevent their Northern migration. Then they stampeded the buffalo into the rivers. On one occasion he had to camp 3 days, on the banks of the Missouri, as navigation was impossible owing to the thousands of dead animals floating down.

Another way was to rush them into the big snow drifts, on the coulee banks, and kill them at short range on snow shoes. The only part of the buffalo then used was the tongue, except where an extra good skin was to be had.

So these savages have only to thank themselves for the passing of the bison, which seems to be only an indication of their own fate.

C. A. S., Lowville, N. Y.

Philadelphia, Pa.

In the August number of RECREATION, "Syracuse" expressed doubt of the truthfulness of the story by Van Dyke, whose elk ran 100 yards, with a bullet through the heart. The experience of "Syracuse," with heart shots, cannot be great. My experience has taught me that wild animals invariably run a short distance, if shot through the heart.

One evening, while hunting in Colorado, I was startled by a signal from my com-



panion. On my turning around to ascertain the cause, he pointed to my left, where I saw a mule deer, not more than 50 yards distant. The gloom was so great I thought the animal was standing quartering from me, but instead, he was quartering toward me.

I fired where I thought his heart was. At the crack of the rifle, he gave 2 or 3 jumps. On going to the place, we saw where he had plowed the ground as he jumped, and that was all we could find of him.

I was certain he had been hit, so we located the spot and went to camp. The next morning we returned and took up the trail, which was sprinkled with blood. About 150 yards from the spot where he had stood, we found him. In his flight he had made 20-foot jumps, and had cleared one obstruction of fallen trees 5 feet high. The bullet had entered his breast and literally torn his heart in two, lengthwise, passing out at the flank.

Last year, in the same locality, I shot a mule deer, at a distance of 150 yards. The shot went directly through his heart, yet he ran 75 yards. I have known a number of other cases, from personal observation; but have never known a deer to drop dead in his tracks, unless shot through the brain or the backbone. Quaker City.

#### Missoula, Mont.

Editor RECREATION: Starting from a mining camp in Montana, for grouse, one morning, the trip took me into some of the wildest country in the mountains. It was not long till my dog had a covey of grouse raised, and I bagged 6. Pushing my way farther on, I was suddenly brought up standing to see, in front of me, about 40 or 50 feet away, a brown bear.

I had no ammunition for this kind of game. My senses were gone and for a time I did not know what to do. The bear sat on his haunches and looked at me. Then turning like a flash, he wheeled, as my dog came through the brush, and disappeared into the timber.

My first thought was to make a straight line for camp. After a lively walk of about an hour, I recovered a little and concluded to finish my hunt. I traveled over hills, gulches and mountains, and was getting a little discouraged, when my dog let me know there were grouse around. Presently he started up a covey and I killed 8 before they got out of reach.

As it was now past noon, I started for camp, after resting and eating my lunch. Not over 250 yards from where I sat, just across a small ravine, was another bear. This one looked like a grizzly. Away I went for home again. It was a good day for bear. Not long after my scare, lo, still another one came into view. He was easily

avoided and soon I was in camp, tired and worn out. When I again go after grouse in the Montana mountains, I will take a rifle. F. R. J.

In past years, it has unfortunately been the custom of a few game hogs, who think themselves sportsmen, to start about August 1st for the game fields and shoot grouse, in unreasonable numbers, for the Helena market, or, as they term it, for sport. Grouse have been left to rot, in heaps of 20 or more, on Canyon creek, Sheep creek and the Dearborn, to my own knowledge. I have often driven from 20 to 30 miles, to enjoy a few days with rod and reel, only to find some of my favorite pools depopulated by giant powder. Paid game wardens have not stopped it.

In view of these facts, the Marysville Fish and Game Protective Association has been organized. Among us are miners, prospectors, ranchers, and professional men. Our membership is scattered over the best part of our game country. The sole object of the Association is the enforcement of the game laws.

We have at present about 30 members, and expect as many more within 2 weeks. Although this is not a secret organization, we do not publish the names of the members, and not a little quiet detective work will be done.

We would be glad to see this idea spread, until all true sportsmen belong to similar organizations. I do not think a game hog would be left unpunished in this land. One of our by-laws reads: "Any member found guilty of violating the game laws shall be expelled from the association and prosecuted to the extent of the law."

J. V. C., Marysville, Mont.

There has been so much said of late about game hogs that I would like to know just what constitutes one.

In the July number of RECREATION a party of 6 gunners, who killed only 240 ducks, were so called.

Now, 40 ducks to the gun does not by any means seem out of the way, provided, of course, the birds were used. Almost everyone who has done much duck shooting has killed more than that in a good day.\*

We had rather a good flight of shore birds here last month and fairly good sport, on 2 days, killing plover, curlew and yellow-legs. A friend and I killed 93 the first day and 130 the second. We could have killed more, but shot all our shells away in about 1½ hours, each time.

We used no stool, but simply squatted in the grass and whistled.

\* See page 133 of August RECREATION.

We expect the second flight about the beginning of August, when there will be better shooting than earlier. I have never been in a big flight, but have been told it is not unusual for a man to kill 200 to 400 birds, if he has shells enough.\*

We do not kill these birds for market, but one or 2 gunners will kill enough to distribute throughout the neighborhood.

Bear are quite numerous, at this place. We had a small hunt about a month ago, jumping 2 bear inside of 20 minutes. Both got away however.

A. S. Doane, Coinjock, N. C.

---

GOV. HOGG A VIOLATER OF A GAME LAW.

The Court of Appeals of Nacogdoches, Tex., has affirmed the judgment given in favor of the State, against E. C. Dickinson of Cherokee county, in the county court of that county about 3 years ago, for violation of the game law. The case had much notoriety at the time because of its involving several distinguished men, notably ex-Gov. Hogg, of Texas.

The facts in brief are that Gov. Hogg went to Rusk, and joined some friends in a camp hunt. They killed one deer, and this was made known to the county authorities, who prosecuted the hunters. It was arranged that, as a test case, Judge Dickinson should be tried and the others would submit to the decision, the same as he. Judge Dickinson was convicted. His case was appealed and has now been affirmed. Gov. Hogg has, from the first, been anxious to have the case decided and be done with it.

The distinguished defendants can now step up to the captain's office and settle. It seems that in Texas the law is no respecter of persons. It is a mighty encouraging sign of the coming of the sportsmen's millennium when an ex-governor can be arrested and fined for violating a game law.

---

A number of our local sportsmen have become interested in the introduction into this vicinity of some of the varieties of pheasants, and of some variety of quail that can endure this climate. I am aware pheasants were introduced a few years ago, into Livingston county, this State, but have not been able to learn with what success. Some time ago a New York paper published an article in which it was stated that pheasants' and quails' eggs would be furnished to clubs, for the purpose of propagation. Can you give me any information on this subject? The ruffed grouse is about the only game left in the Mohawk valley, and unless some means are adopted

for his protection his ultimate extinction is only a question of time.

I am much interested in the vigorous fight you are waging against "game hogs," and hope, some day, to see all true sportsmen arrayed against that most detestable of beings. I would like also to see some rational reason given why our legislators should consider the meadow lark a game bird on Long Island and not elsewhere in this State. In my opinion the meadow lark should be protected, as much in one place as in another, and the same is true of all kinds of game.

I find RECREATION very interesting and instructive.

Geo. M. Albot, Fultonville, N. Y.

---

IDAHO NOTES.

Mr. Bovier and a party of friends from Elmira, N. Y., recently enjoyed a few days' trout fishing on the South Fork of Payette river and made good catches. This is a model trout stream. The water is clear and cold; there are many deep, rocky pools where trout love to hide. I have found here 3 varieties of trout; the large spotted mountain trout, cut-throat trout (*Salmo mykiss*) and the Dolly Varden, also known here as the bull trout. The natives call the cut-throat trout the silver trout. I have caught some of these that weighed more than 2 pounds.

The Idaho trappers tell me eagles are the worst trouble with which they have to contend. These birds swoop down, attempt to carry off the baits and get caught in the traps, thereby preventing fur animals from getting in and causing a clear loss of time. In other instances they tear up animals they find in the traps. The trappers denounce our National bird of liberty as a common thief and an unmitigated nuisance.

The other day, while riding over the mountain, I surprised 2 bears that were feeding in a huckleberry patch. They were yearlings—one a black and the other a brown. I rode up to within twenty yards of them before they ran. People living at and near Banner say it is a common thing to see an old bear with one black and one brown cub. In fact when a pair of cubs are found one is almost invariably brown.

Mountain lions are playing havoc with the game, at the deer licks in central Idaho. We found remains of several deer that had been killed and partly eaten, by them, and captured one big lion, with a set gun, at the carcass of a deer he had killed the night before. We also shot 3 other lions near the licks.

These same trappers say the Lemhi and Bannock Indians invaded that country, last

---

\* All such men should be enrolled as members of the swine herd.—EDITOR.

fall, and again during the past summer, and were slaughtering hundreds of deer, for their hides alone. A band of 19 elk shared the same fate. Dietrick ordered the Indians out; but they laughed at him, and said, "Go see Agent. Me got pass," which they produced.

The other night Billy Kirkham, of Banner, heard a noise, outside his cabin, and rising up in bed saw a big lynx sitting in the window. He reached for his rifle, fired at it and now its hide adorns the wall of his cabin. The beast had torn up a good deer skin before climbing up to the window.

The other day while Superintendent Rogers, of the Banner mines, was out grouse shooting he met a brown bear with 2 cubs. He said the old girl sat on her haunches and warbled to him, and he did not wait to enquire her, as he had only No. 6 shot in his cartridges.

Horace Johnson, who traps on the Middle Fork of Salmon river, caught last season 12 bear, 9 beaver, 7 foxes, 27 martins, 23 mink, 1 wolverine and numerous lynxes and mountain lions.

Bear valley is the nesting place of hundreds of sand hill cranes.

M. W. Miner, Banner, Idaho.

#### KILLING FOR THE NEIGHBORS.

I find your letter of 5th on my desk, on my return from a week with the rod; and if you had seen me getting off the train, I know you would have handed me your card with your favorite roast—"Hog," written on it; for I had a beautiful bunch of them. You may rest assured none of them went to waste, or to the market; for there are 14 judges here, beside more than 1,000 attorneys, all of whom have a fish and game tooth when they learn I am among them.

Our party brought back more than 300 ducks last fall, from the Illinois river, and for an hour or more the court house was actually deserted.

Chas. L. Lundy, Cincinnati, O.

#### ANSWER.

In my judgment a man is not justified in taking a big lot of fish or game, simply because he can give it away. If such a code of ethics were established among shooters, there would be no limit to the amount of fish or game a man might destroy, under this pretext. You could ship a car load of ducks or fish into our city, and give them away in an hour. You could, no doubt, even give them to your friends; yet this would not be justifiable.

If you agree with me that it would not, then where can we draw the line? An unwritten law, among the best class of sportsmen, is that a man shall kill only for

camp use, and for his own table, at home. If your friends want game, let them go and kill it, as you have done. If they are not sportsmen, let them buy their game. If they cannot do this, let them eat beefsteak, or bacon.

I am in favor of going still farther, and of prohibiting, by law, the sale of game at all times, and under all circumstances. I claim that a man who has not the skill or the energy to go afield and kill his game, or take his fish, in a sportsmanlike way, should do without. I am aware these are advanced views, and that thousands of men are not yet up to them; but we must come to this plan eventually, or submit to the entire extermination of game and game fishes.—EDITOR.

#### PHEASANT PROPAGATION.

I have noted many interesting articles in RECREATION, relating to various kinds of game, but comparatively little concerning the propagation of pheasants, in which at present I am interested. I succeeded in raising 41 birds out of 45 hatched; only one dying from any apparent disease. The other 4 were killed by the mother hens. I have 5 more hens than cocks—an exceptionally good proportion, for pheasants.

I have raised 7 Mongolians, 4 of them hens. I shall keep 2 pairs of these as breeders for another year. They are the best birds for this part of the country, being more hardy than the English birds.

My intention is to liberate all but a few of my birds, in the spring. Our game club here has quite an extensive preserve, on which no one is allowed to shoot, thus assuring the birds a safe retreat and breeding-ground, at all seasons of the year. Our game laws prohibit the shooting of pheasants, until 1900.

Pot hunting is the curse of the country. Some men here kill as many as 500 birds in a single season. There is small inducement to restock the woods with birds that will be more eagerly sought than our native game birds. Other experiments in pheasant raising have been made in various parts of the State, and in the Berkshire hills; but indifferent success is reported. I am inclined to attribute this to improper attention and unskilled care of the young birds.

On my annual trip to the Adirondacks, this fall, I shall take a few pairs of my English birds, to have them liberated in the spring, about 7 miles from North creek. I expect to do the same each year for some years to come.

These birds will be, I think, the first to be turned out in that great preserve. I can see no reason why they should not flourish, and eventually make excellent shooting for visiting sportsmen.

Dr. H. L. Ross, Canaan, Conn.

## GAME NOTES.

I have just returned from an outing on the Big Sangamon river, 35 miles South of this point, where we had a high old time. My eldest son, 2 nephews and I loaded our little basswood fishing boat, tent, grub stake, and "hoss" feed into a covered farm wagon, and pulled out for this trip on Saturday, and returned on Thursday. We caught crappies, perch—both pike and yellow—channel cat, and black bass, all we needed for camp use. We amused ourselves, at off times, by plunking bullets, from our little 32 rifle, into the backs of turtles, as they would come up on to partly submerged logs, to sun themselves.

At night we were serenaded by the great horned owls, and the first night by thousands of mosquitoes, but put a stop to these after that night. Along in the afternoons we fired old stumps and rotten logs, each way from the tent, and the smoke cleared the singers clean out of this neck of woods.

We had fine weather, and made many friends and no enemies, among the residents of this region, having some one of them to join us at our table, at each meal during our stay.

Sangamon, LeRoy, Ill.

Tacoma, Wash.

Editor RECREATION: I take all the sportsmen's journals published. Some I read and some I glance through and fire into the waste basket.

If there is anything on earth that makes me tired, it is to pick up some magazine that is supposed to contain reading matter of interest to sportsmen and find that half of it is devoted to some fool love story. What do I want with love stories? I have been married several years. What I want to read is a rattling good bear fight, where the air is full of hair, blood, dogs, etc. I want something that will make your hair stand on end, cause you to jump, grab your gun, call your dog and take to the woods. D— these lovesick tales that most of the sportsmen's magazines are full of. I have RECREATION from the first to the latest number. I also have an old smooth bore musket, loaded with slugs and scrap iron; and I am coming down to New York and turn it loose into you, Mr. Editor, the first time one of these "Lovey Dovey" stories appears in RECREATION.

W. F. Sheard.

We have an abundance of small game, such as rabbits, squirrels, quails, with some grouse. Our game laws are good and they are well enforced.

Open season for rabbits, squirrels and grouse is September 1st to December 15th; quails, November 10th to December 15th.

The law says quails and grouse shall not be sold in the State.

P. W. Roche's article in August RECREATION, telling of 300 squirrels in one season, and 105 quails in one day, can mean but one thing—game slaughter.

He excuses it by saying they were expert hunters and not game hogs. I fail to see why that much game, killed by an expert hunter, would destroy less than if it had been killed by an ordinary butcher.

Some men will denounce the pot hunter, but when it comes to themselves, they kill all in sight, offering as an excuse that they are experts and do not kill for the market.

We have no law limiting the amount of game a man may kill, but 8 to 12 rabbits or squirrels, 10 to 15 quails, or 2 to 5 grouse is a good bag. By practising moderation and seeing that the laws are enforced we may have good shooting every fall.

RECREATION is ahead and on the right track; success to it.

B. H. P., Sayre, Ohio.

Forest Glen, Md.

My Dear Coquina:

My September RECREATION came to hand yesterday, and I sat up with it, till I had finished it, of course. That is, I read all through it once. However, I shall do this over and over. My RECREATION is my share in the outside world—a world of which I once formed a happy, active part; but from which disease has closed me in. You may therefore judge with what yearning I look forward, through the slow weeks, for the next visit from you.

To me RECREATION is more than a magazine; it is a friend. It is *my* friend. It is Coquina himself, breathing of the majestic Rockies, and smelling of venison, like Esau of old, sweet with the freedom of the mountains, genial with the fraternity of the trigger. May all the blessings of the fields and the woods attend you; and may shekels pour in till your pockets burst, if that will minister to your happiness. You are doing good, generous, missionary work among sportsmen, and they should all stand by you.

W. H. Nelson, Forest Glen, Md.

As an old reader of your magazine, when not half so fat (I mean the magazine), I am glad to see it getting better form by the digesting of interesting reading matter, not inflated with quack medicine, and doctors' ads, which too many so called leading magazines find it necessary to use to keep up their forms.

In this connection I may say my form was greatly divided by traveling over most of the U. S., parts of S. A. and Mexico, not on pneumatic saddles, or tires, but on sweet faced bronchos, inflated with all the cussedness necessary to puncture your hide on

cactus or prickly pears, on the least provocation. While I am thus deformed I congratulate you on your success and will ever be glad to try to increase the interest in your beautiful book by giving reminiscences of fights, hunting or fishing trips that it has been my fortune to participate in, during my 40 years of travel.

"Uncle Sam," Ashland, Pa.

Let us have some of these stories.—EDITOR.

While Manton is not in the heart of the game fields of Northern Michigan, yet in the course of 2 or 3 hours' tramp from town, one can find all the sport the most enthusiastic lover of rod or gun would ask. The numerous streams and lakes are well supplied with fish; the former with trout and grayling and the latter with bass, pickerel, pike, perch, etc.

There are ruffed grouse and ducks in abundance, and a few quails and squirrels; while in the more unsettled parts deer are fairly plentiful; but they are fast disappearing. Some bear still remain; often within an hour's walk of town, their sign may be seen.

The game laws are strict and, in this vicinity, I am glad to say, are seldom broken. Should any reader of RECREATION find it convenient to stop at this place, for a few days' hunting or fishing, he will receive a warm welcome from the local sportsmen, and plenty of fun only a short distance from town.

The boys here who take RECREATION are delighted with it.

W. S. B., Manton, Mich.

With a companion, I have just put in a day riding in the mountains, between Spring coulee and Loop-loop creek. We counted, during the day, 70 old grouse, with their flocks of young. This I call a good prospect for some shooting later in the season. We saw the track of a large bear, but had no gun, so did not care to interview the animal. Later in the evening we jumped 2 fawns. As they skipped down the mountain-side, we contented ourselves with the hope of a shot at them in the fall. On coming down to the creek, we got our tackle into shape and soon had a string of trout; after which we returned to the ranch, feeling the weariness of an all day's jog through the mountains, but without any game. As we glanced at our guns, glistening under heavy coats of oil, we knew they would smoke before long.

J. B. Liptraps, Clover, Okanogan Co., Wash.

Prairie chickens are more abundant here than for 3 years past, and bags of 20 to 40 birds are made, by parties of 2 to 4 shoot-

ers. This is the more surprising since many game hogs have been hunting the birds since July 1st, when they could hardly fly, and a certain individual boasted of having killed over 300 chickens before September 1st, which is the end of the close season.

It is unnecessary to say that not the slightest respect is paid to the game laws in Nebraska, as convictions under them are practically unknown. The only remedy is to have a paid game warden provided, who shall prosecute violators.

Quails are fairly swarming in every thicket, and never were so abundant before.

M. K. Barnum.

Your magazine is getting better and better every month. The hot shot you keep firing at the "swine" who are responsible for the destruction of game, meets with my hearty approval. The "game hog" can be found among all classes, from the very lowly to the richest clubman from the city. The meanest man I ever met in the field was from the city, with his \$100 gun and thoroughbred dogs. One, a gentle bred animal I believe got so disgusted at his un-sportsmanlike actions she finally refused to work for him. Not another bird would she find, though he beat her unmercifully. (She was a borrowed dog, he told me.) Not one iota of pity could I have felt if some one had filled his anatomy with No. 8 shot, at 40 yards.

J. T. Maris, Portersville, O.

Mr. Libby, of Idaho City, owner of the "Lucky Boy" Gold Mine, has been camping with me for 4 days past, enjoying the fishing and Hot Spring baths. He is an old '99er, a thoroughbred sportsman, and a man among thousands whom it does one good to meet. He can catch trout with the boys too. I initiated him in fly fishing, and gave him a selection of flies to start him out properly.

I am getting all the game my neighbors and I can eat. I shoot them with a 22 calibre target pistol; but then I could kill the game with a club, if that wasn't such a beastly way of treating a game bird.

Well, it's a pity we couldn't get a roast on every one of the d— fools who take a shot at every live thing they see when they go in the woods. They are worse than game hogs.

M. W. Miner, Caldwell, Idaho.

As to hunting and trapping, this past year was the worst I ever had. I only got 4 bears in the spring and none last fall; but I have many reasons for expecting a good catch this coming season. Of course, there were plenty of deer and a few elk, at all times; but the bear and other fur animals

seem to have deserted that part of the country, viz. Cowichan lake, V. Island.

Wolves are plentiful up my way. I will try to bag a number next winter, and may write you an account if successful. Will be glad to see the July wolf proposition carried out.

I had a curious experience last January. Two panthers went into one trap at the same time. The trap, a wooden dead fall, held both; but when I got around the wolves had eaten both panthers, except the skulls and a small bit of spine under the drop pole.

Chas. A. Baylor, New Westminster, B. C.

I have lately seen a cut of a lot of fish and game, gathered up by a lot of fish and game hogs who formerly belonged to the Fin, Fur and Feather Club, of Cadillac, Mich. The picture represents the result of a great side hunt, said to have been participated in by 120 members of the club, in 1895. There appears to be a big wagon load of game and fish. In fact, it is doubtful whether all this stuff could have been gotten into an ordinary farm wagon box. Only 4 of the game hogs ventured to show their faces in the picture. The others had doubtless become ashamed of their butchery.

This slaughter took place 2 years ago, and I trust the missionary work that has been done by RECREATION, since that time, has taught these men something, and that they may never again be guilty of such brutal work.

Enclosed find \$1, renewal of subscription to RECREATION. The magazine is indeed a good one, and is entitled to the unqualified support of every admirer of the different sports, especially those of rod and gun. I notice several friends of mine, members of our order, contribute to the pages of RECREATION. One in particular, Sam Downs, of Mauch Chunk, Pa.

Last year I hunted and fished on Williams Fork of Bear river, in Routt county, Col., and had an enjoyable time. Our party starts this year, on August 30; and if business permits, I will join at Pueblo. In the event of my going, will try to write you a story, on my return. We all use the Marlin .30-30. After having tried them one season, we pronounce them an unqualified success.

W. V. P., Peoria, Ill.

You will remember I got an Irish setter dog from a Mr. Clark, by your help and influence. He gave up the dog, after you had threatened to expose him as a professional swindler. The setter is a fine specimen and a first class field dog; \$500 would not buy him. Everybody admires him.

I bought some English ring-necked pheasants, a cock and 2 hens, and built an

enclosure 42 x 23 feet, of poultry wire, top and bottom. The hens have laid 162 eggs. I would like to know if any pheasant breeder can equal this. As an amateur breeder, I had fairly good success, raising 50 pheasants. I intend to go into the business on a larger scale, for the market. I will have a few pairs for sale next spring, all taken out of my own stock.

J. F. Blome, Tomah, Wis.

It gives me pleasure to read RECREATION, the leader of sportsmen's magazines. Now is the time for good bass fishing, and some excellent catches have been made. The best is 7 bass and 2 catfish, weighing 7 and 10 pounds, respectively.

We have all kinds of game, but deer hunting is my favorite sport. Deer had it easy last winter, for there was no snow. One spike buck was killed after being run down by hounds. Farewell, hounds, if Siverly boys catch you running deer.

We have good deer hunting and we will protect it. O. E. D., Siverly, Pa.

I am a girl, 13 years old, and much interested in out door sports. Am fond of both rod and rifle. I live on the Neosho river, where we have excellent bass and crappie fishing.

We also have fine squirrel shooting, in the timber along the river, for which I use a 22 Winchester repeating rifle. Am much pleased with your magazine, and may send you a photo of my pet wolf and badger.

Zada Kingsley, Round Grove, Kan.

ANSWER.—I should like very much to have these photographs and hope you may send them soon.—EDITOR.

My wife, boy and I enjoy RECREATION exceedingly, and I will do all in my power to assist you in your good work.

I want to tell you of a few very poor specimens of sportsmen we are unfortunate enough to have here. They have been killing young ducks on the Nooksack river flats. The birds, at that time, were too young to fly, and fell an easy prey to these gluttons. A few men who are interested in legitimate sport have been instrumental in having a game warden appointed, and I hope he will have a chance to make an example of one or 2 of these pot hunters.

J. S. Stangroom, New Whatcom, Wash.

Deer shooting began August 1st, for bucks only. My chum and I killed 2, early one morning, at Walker lake.

Our camp was visited one night by a magnificent specimen of mountain lion. We arose in our retiring garments, to which were added boots and rifles, and started in pursuit. After following the

trail by moonlight for nearly 2 miles, we began to notice the lack of lower garments, so fled back to our blankets.

We named our camp "Recreation Camp." Everyone who sees the magazine is loud in its praise.

Turkeys, squirrels, and doves are plentiful in this locality.

Arthur C. Fayer-Hickey,  
Flagstaff, Ariz.

Have just returned from the North Fork of Big Otter, where I spent a day in the delightful sport of trout fishing. The prospect for grouse and prairie chickens is good in that district, if the hogs don't root them out before they can fly. I send clipping showing where one of the hogs paid for his grouse. Thanks to Game Warden Hill.

George Leuchars, Great Falls, Mont.

Martin Strasburg was up before Judge Fitzgerald, charged by Game Warden Hill with violating the game law. It appears that Martin wanted grouse and took his gun and got one. He pleaded guilty and the judge gave him the minimum sentence, \$25 and costs, amounting to \$35.60. In the future Martin will wait until the game law opens. Mr. Hill says he will prosecute, without favor, any and all cases brought to his notice, in which the game law is violated.—Great Falls "Tribune."

August 24, 1897.

Editor RECREATION: I enclose herewith my renewal of subscription, and must at the same time express my appreciation of your efforts to give us a first-class sportsmen's magazine. It seems to me 100 per cent. better, in every way, than it was one year ago, and it was good then.

Your letter, received 11 months ago, is before me, in which you express expectations that your list of guides will some day cover 2 pages and I see your prediction has come true.

I have been pleased with your stand against the fish and game hogs.

H. F. B., Boston.

I am an Indian and live, as you see, a long way West of your village; but I read RECREATION. Am fond of hunting—by nature, of course. I buy a copy of your little book every month, and have induced some of my friends to do likewise.

How would you like to print the best record of an Indian hunter? I will give it to you; it is a true record. He killed 10 deer, large ones, in as many hours of one day. The strange part of the story is this: The deer came one at a time and were killed with what is called a Leaman rifle, muzzle loader. The hunter had taken a position at a certain tree and the deer were killed from this tree. The Indian's name was Tar-Coser-Har-Jo.

Chas. Gibson, Eufaula, I. T.

I saw a lot of big game during the summer and all of it was fat. The bucks had

good antlers. On one trip of 2 days from home, up the Aroostook river, I saw 31 deer and 2 moose. One of the moose had the largest antlers I ever saw, and I have seen many.

Game is increasing in Aroostook county every year. Six years ago the dead waters and ponds were so full of lily-pads it was hard work to paddle a boat, but now they have been all eaten out by moose and deer. Beside moose, deer, and caribou, we have ducks, ruffed grouse and rabbits, in this part of the State.

J. E. J., Ox Bow, Me.

The Ohio Fish and Game Commission will distribute about 2,500 Mongolian pheasants, in different parts of the State, this fall. The birds will be turned out in the forests and will be permitted to run wild. They will be sent to nearly every county in the State, and as they multiply rapidly, it is expected that within a few years they can be found in considerable numbers.

They will be protected by law until the 10th day of November, 1900, and after that date may be shot only between the 10th of November and the 15th of December.

I have just returned from a 2-weeks' camping trip to Styles lake, about 7 miles from this place. Small game is abundant, and the prospects for rare sport this fall are bright, thanks to the scarcity of that villain, the game hog.

I read with much interest the article in July RECREATION, "The Question of the Day," by J. A. Mackenzie. All I have to say to it is Amen; for I, too, shoot a Syracuse gun, which I think is perfect.

I intend to get to work in earnest, getting subscribers to RECREATION.

C. B. M., Bradford, Mass.

In regard to the numerals used by you in place of writing out the words: This has been a source of annoyance to me, too. It was the only thing I disliked about your magazine. The established custom had engrafted itself so upon my ideas that I felt like suggesting to you it didn't look well; but your answer to a kicker, in the last number, has effectually dried me up, and I've nothing more to say. Surely utility is more than style, and perhaps when more magazines adopt the use of figures it won't look so odd to us.

E. L. Cole, Pelican Rapids, Minn.

Deer are plentiful here and there are some fine old bucks among them. There are also quails, squirrels, rabbits, grouse, pigeons, ducks, trout and a few bears and panthers. We would have more deer if a

miserable man could be caught who is killing deer for their hides, and leaving the carcasses to rot. His name is John Boyd. Don't fail to print this, for I want everybody to know who our game hog is.

Arthur Thompson, Bridgeville, Cal.

RECREATION is the best magazine I ever read, and I shall take it right along. I have one of the best deer heads I ever saw. Have hunted all over the country, and find Dresden as good a place as any. I live within 2 miles of Black mountain. Killed 3 deer in one day, and when I went after them, the next day, I shot another, and brought out 4 at once. Since then I have killed 2 or 3 each year. If any reader of RECREATION wants a day's hunting, and will call on me I will show him where the game is.

Patrick Crockwell,  
Dresden Centre, N. Y.

I wish RECREATION would come twice a week, now, as I have a bad hand and cannot get out much. While shooting, on July 8th, my gun burst and tore my left hand badly. My thumb was almost torn off and the muscles and flesh, in the inside of my hand were blown to pieces. I was shooting a Baker gun, and 31 grains Shultz nitro powder. I shall get more subscribers for RECREATION, when my hand gets better.

P. E. Clock, Oneida, N. Y.

The outlook for good shooting near here, this fall, is good. I have seen a number of rabbits, and hear quails whistle frequently. Grouse are scarce. Fishing is poor, although we have one of the finest streams in the countryside running near us—Moodna creek—but on account of the drainage into it scarcely a fish remains. There is fair bass fishing in the mountain ponds, but they are hard to reach, unless one camps. RECREATION is just out of sight.

R. H. W., Cornwall, N. Y.

I enclose a copy of our new game laws, which are supposed to go into effect July 9. While the game laws are all right, our legislature failed to provide a game warden to enforce them. The result is game is virtually without protection.

Verily, this is the State where the fish and game hogs are at home! You can see enough any day to make you inquire, What good is a game law with no one to enforce it?

P., Lincoln, Neb.

Fish are plentiful at Roach river, Lily bay and Moosehead lake. A man took a trout that weighed 5½ pounds. The next day he got a 6-pounder.

Moose and deer are in good numbers. I

see that many readers of RECREATION use 30-30-160 smokeless rifles. I, too, use one, and would not exchange it for any of the heavy rifles. I have used the 45-70, 45-75 and 45-90, but think the 30-30 the best of the lot.

B. J. Woodard, Dover, Me.

Owing to a favorable season for game-breeding, quails are without number. Have seen as many as 25 or 30 bunches, dusting in the road, in driving 20 miles. A few days ago I saw 15 turkeys in one flock. They were nearly grown and not wild. There will be the best of shooting when the season opens. Deer are plentiful, and a bear was shot within 4 miles of my house, about a month ago.

C. L. F., Avon Park, Fla.

Game is plentiful this fall. Our prairie chickens are protected until '99 and I see quite a difference in the numbers of them. We have a few pheasants, which were turned loose 3 years ago, and which have done well. This is a great summer for fishing. We have made some fine creels. You cannot go wrong in any stream here. I will send you a short history of a fishing trip, later.

Harry Chapman, Vernon, B. C.

Notwithstanding the unusually heavy spring rains, which it would seem would have been disastrous to nesting and hatching, reports from various parts of this country are that there are more quails this year than for many years past. The game laws are more generally respected than formerly, and RECREATION'S large circulation in this city has, without doubt, done a noble work in the interest of game protection.

C. F. Wadsworth, Springfield, Ill.

Some of the Stevens Point, Wis., sportsmen have been awakened to a sense of their duty, and to the necessity of protecting their fish and game, by the frequent roastings they have had in RECREATION. These men have organized a gun club, and are now offering a reward of \$10 for the arrest and conviction of any man violating the game laws.

I am glad to see my work is bearing fruit, in a place where it was so sadly needed; for if ever there was a reckless lot of game and fish hogs, in any town, they were to be found in Stevens Point.

I should like to call your attention to the Governor's veto of the Act of the Penn. Legislature providing for a State fish and game commissioner, and for county fish and game wardens. By his veto of this bill Governor Hastings, has made many oppo-



nents among the Pennsylvania sportsmen. James O'H. Denny of this place, President of the State Sportsmen's Association, has now set on foot a plan to organize county associations and to raise, by public subscriptions, the money necessary to employ county wardens.

W. G. Irwin, Ligonier, Pa.

I followed K. C. S.'s instructions regarding a trap, as published in June RECREATION, but found it a failure. I secured 2 heavy sofa springs, boards, hinges, etc., and blistered my hands putting in the screws. When I had finished the trap I found it would not throw a can 3 feet. Perhaps I made a mistake, but do not think so. I wish you would ask K. C. S., through RECREATION, if he ever made a trap similar to the one he describes, or if he described it entirely on theory.

H. E. S., Cambridge, N. Y.

On the 12th of June I started on a prospecting trip, for game. Was gone 3 weeks in the mountains and saw more elk and bear signs than one usually sees in so short a time. Goats and deer are so plentiful it isn't worth while to speak of them. They are everywhere in the mountains.

Fishing is good. Young ducks are numerous; so the sport will be good next fall.

M. P. Dunham, Woodworth, Mont.

Will you kindly inform me, through RECREATION, how to take mildew out of a tent?

W. H. T., Riverdale, N. Y.

I referred this question to Derby, Abercrombie & Co., tent makers, 36 South St., N. Y. City, who reply as follows:

New York, July 26, 1897.

To take mildew out of canvas wash the fabric with resin soap; then rinse well, and immerse in a weak solution of alum.

Will some reader of RECREATION please post me as to good hunting, of large and small game, in New Mexico? Some friends and I intend making a trip to that country, this fall, should we ascertain that it is a desirable place to go, for game. We wish to know what part of the territory one had best go to; also what game we might expect there. What month would be best?

W. E. Bartlett, M.D., Belle Plaine, Kan.

Our shooting opened August 20th. Chickens, ducks, geese are plentiful in this part of the State.

Fishing is no good in the vicinity of Devils lake, now. Nothing but pickerel in these waters, but some carp and bass have been planted in our lakes. Non-resi-

dents are required to take out license to hunt here, which costs \$25.

Fred W. Crafts, Devils Lake, N. D.

I receive RECREATION every month and am proud of it. I am not a sportsman, nor do I live in a place where hunting is good; still I enjoy reading RECREATION, as it interests all. Will some reader in Canada, who would like to exchange old Canadian stamps for old U. S. stamps please write me?

Walter H. Walker, Altamont, Ill.

I think RECREATION is worth its weight in gold. I can hardly wait a month for it and have to get out the old copies and read them over again.

We have good goose, duck, and prairie chicken shooting here, in the fall, and rabbit hunting in the winter. If there is anything I like better than RECREATION, it is more RECREATION.

W. C., Worthington, Minn.

Herein find my renewal for RECREATION. Would feel lost without it. If you see anyone looking for a good game and fish country, you can advise him to come here, and you will receive his thanks on his return home. Game and fish in fine condition; good feed, finest water in the world, and such scenery as only Wyoming can afford.

H. E. Wadsworth, Lander, Wyo.

Will some brother sportsman in Massachusetts, or elsewhere in New England, who is acquainted with a thoroughly reliable dog trainer, especially on retrieving, kindly oblige me by sending me his name and address? I have a spaniel that I want trained on ducks and have no time to handle him.

H. B. Clewley, Woburn, Mass.

I would not miss a copy of RECREATION for anything. I like the way you roast the game hogs and pot hunters. Give it to them, hot and heavy. We have lots of small game here; red and black squirrels, grey and jack rabbits, chickens, some ruffed grouse and quails.

S. C. Oxley, Ossian, Ia.

We have the finest game country on earth. Grizzly, silver-tip, brown and black bear abound; also mountain sheep, goats, deer and caribou. Small game of all kinds is plentiful and we have the gamiest silver trout ever caught.

Harry Chapman, Vernon, B. C.

We are having good hunting this fall. Owing to 3 conditions the birds are nu-

merous. First, we had enough birds left over for seed; second, an open winter; third, a dry spring. There are quails on every farm, and the rabbits are too thick to suit some farmers.

Will T. Haynes, Akron, O.

It is hard to trap a mountain lion, in summer. He will kill a calf, or a colt, eat one meal from it, and will not touch it again; but will kill another for his next meal. The bear is such a hog that he will never leave anything as long as there is a piece of it left to eat.

Ralph Anderson, French, Wyo.

The mountain lions are killing my calves and have killed one yearling colt for me. There are 3 bears living in the first big draw on this side of Sheep mountain. I wish some one would come here and kill them. Frank Bradford, Saratoga, Wyo.

I could not well do without RECREATION, but it gives me the fever awfully. There is not so much as a squirrel here. We have a few quails and rabbits; but I can enjoy reading of others having good sport.

Chas. Phillips, Alexander, Ark.

Squirrels and rabbits are plentiful in Sullivan county, New York. Last season fair sport was had, by some sportsmen who did not count the enjoyment of a day in the woods by the amount of game killed.

E. B. H., Eldred, Sullivan Co., N. Y.

We have grouse, mostly sharp tail; also deer and antelope within a day's drive. Speaking of that 35 point buck: There is one in Meeker, Col., that has 38 points. Let someone else speak, and see who has the largest.

A. E. Parks, Lead, S. D.

RECREATION gets better all the time. If you keep up your present licks I shall either get among the big game again, this fall, or be in the insane asylum. The old Marlin just aches, as well as I, to get at them.

S. H. Hazledine, Skull Run, W. Va.

T. G. Stewart, of Avoca, N. Y., was arrested for shooting 16 robins and was fined \$25 for each bird killed, making, with costs, a total of more than \$400. Hereafter Mr. Stewart will hunt larger game, in order to come nearer getting his money's worth.

I am well pleased with RECREATION. I think it the best and cleanest magazine of its kind I ever read. I like the stand you

take as to the fish and game hogs. Give it to them.

Chas. Nelson, Los Angeles, Cal.

I have taken RECREATION since the spring of 1895, getting it from our local news dealer. It is a splendid magazine, bright and clean in every sense. I wish it the best of success.

B. G. A., Bangor, Me.

W. W. Williamson, A. P. Milne and I planted 4 cans of pike fry, from the Caledonia hatchery, in Mud creek, last summer. When the black bass season opens, will let you know what luck the boys have with them.

W. P. S., Palmyra, N. Y.

The Bangor & Aroostook Railway reports that during October, November and December, 1896, there were shipped from stations on its line 2,508 head of big game. Of these, 2,245 were deer, 133 were moose and 130 were caribou.

There are no caribou here; but in Newfoundland is the best caribou hunting in America. We had fine luck fishing; got 102 in one day, and 80 the next, fishing in the evening only, as it was too warm in the day time.

W. E. Hahn, St. Stephan, Neb.

RECREATION is the right sort. Like wine it improves with age. It does me good to read your scathing rebukes of game and fish hogs. The outlook for chickens and quails never was better, in this neighborhood.

R. S. Montgomery, Omaha, Neb.

A carrier pigeon, with metal band No. 43, was killed here some weeks ago, by a shooter who did not know it was a carrier: Subscriber, Hackensack, N. J.

Friends of RECREATION will render valuable aid to this magazine by buying goods advertised therein, in preference to those that are not.

Send me \$1.50 for RECREATION one year and Mr. W. T. Hornaday's great book, "The Man Who Became a Savage." The book alone sells at \$1.50 in the stores. Renewals are included in this offer.

An Australian Mosquito-Proof Tent for 10, 15 or 25 subscriptions to RECREATION—according to size of tent. Send for circular. This tent is light, compact, waterproof and *insect-proof*.

## FISH AND FISHING.

### THROUGH THE ICE.

The lakes in Connecticut afford excellent fishing through the ice. This sport is generally preferred by the average angler, I think, to summer fishing; but my preference is "skittering" for pickerel. There is nothing in the way of fishing that satisfies me more than enticing a 3-pounder from under the lily-pads, which lie on the surface as if having a mission there.

However, I was tempted to the ice one day, and, with a friend, had some real sport. Before I left my home, in Middletown, several friends who had experienced the discouragements usual to the novice, made all sorts of predictions as to the condition of my creel on my return. Some of them unkindly intimated I would not get a bite; but encouraged by recollections of boyhood successes I paid no attention to their talk.

When we reached the lake every bay was occupied; so it was necessary to fish in deeper water than I should otherwise have chosen. After the holes were cut, I began to set the traps.

From the moment the wriggling shiner disappears beneath the ice there is pleasant anticipation. While success is not always realized, there is an uncertainty that contributes largely to making life worth living, as far as that day is concerned, at least. Where is the fisherman who ever set traps who did not look at the first a dozen times before he got the second ready. Sometimes I have even thought the shiner enjoyed the prospect, as he darted into unaccustomed depths, perhaps happy that he should escape the confines of the "imported" box of sardines; or it may be, in a friendly rivalry with his neighbor, for the capture of a 4-pounder.

While I was setting my fourth trap, a thrill of pleasure coursed through my system; for the first trap responded to what I thought was a good bite. When I pulled out a pickerel that easily resisted 3 pounds scale-pressure, the disappointment of the morning gave way to assurance of success. It was not long before I had a start toward a big string. The fishermen about me became envious of my good luck.

During the day we caught 57 pickerel, the largest of which weighed 4½ pounds. We had a number of chances to sell our catch, but I could not conscientiously accept; for I feared it would encourage some brother angler to handle the truth with carelessness, as to how he got the fish. Then, too, I could not forego the pleasure of showing my Middletown friends the result of the day's sport. My feelings received a shock, how much the pickerel cost!

Porcupine, Middletown, Conn.

### HIS FIRST BASS.

DR. F. C. KINNEY.

Early one June, I took my aged friend, S—, to a pond well stocked with small mouth black bass. Although an enthusiastic angler and an expert with the trout rod, S— had never tackled the fierce-fighting bass.

I acted as boatman, guide and host, rigging my friend out with a 10-ounce lance-wood rod, a multiplying reel, and 100 yards of oiled silk line to which was attached a 9-foot leader and a small phantom minnow.

In the first bout, S— several times hung the hook on the tree-tops, that reached over the pond. The expression on his dear old face was a study, as he exclaimed, "Snagged again!" When I backed the boat, to loosen the line, his wrinkled face, covered with a flowing gray beard, took on a pained look, as he thought his awkwardness in handling the long line had caused me so much extra work.

In the third bout the reel began to sing. "Snagged again," snarled my old friend. With one stroke of the oars I sent the boat backward. Quickly looking over the surface of the pond, I saw a bass break water, giving his head a vicious shake.

"Yes, snagged to a bass," I said, taking a quick stroke, shooting the boat ahead, to take up the slack line. "Get up and reel him in!" I cried, for I saw the old man was rattled. "Give him the spring of the rod!"

In his excitement, he turned the reel the wrong way, half the time, and—must I confess it?—used some strong language. I kept the boat moving, to take up the slack. Mr. S—'s face was rapidly decreasing in length and proportionally widening into a broad smile; for now he saw his victim coming in, on the surface of the water. The motion of the boat gave the fish no chance to fight.

Had I known how securely the bass was hooked, I would have kept the boat still, to let my friend fight it out alone. As I lifted the fish into the boat, the old man beamed with satisfaction; and well he might, for the bass weighed 4 pounds 6 ounces, and was the largest of the half dozen caught that day. In the evening, when we were driving home in the starlight, Mr. S— was loud in his praises of the black bass as a game fish.

### COPAKE LAKE.

New York City.

Editor RECREATION: I doubt if one in a hundred of your readers has ever heard of Copake lake. I have visited it a number

of times, during the past 15 years, and know, by experience, whereof I speak. It is in Columbia county, New York, 15 miles Southwest of the town of Hudson, and is full of fish. It is the most beautiful of all the smaller lakes of this state—bar none. It lies in a basin 1,700 feet above the ocean level, surrounded by the Berkshire hills on one side and by the Catskills on the other, and presents a most picturesque appearance. It is reached by the Harlem Railroad, and is only 3½ hours' ride from the Grand Central Station. It is one of the few remaining possessions of the Livingston family, who at one time owned all the land lying between Poughkeepsie and Albany. The lake is about 1½ miles long, from ½ to 1½ miles wide and is 7 miles in circumference. It has been stocked by the state with black bass, several times.

It is unfortunate that there is no good hotel at the lake, and that the game constable is not more active. It is currently reported that when the bass are spawning, in the spring, some of the countrymen, in their eager desire for fish, after a winter diet of pork and buckwheat, make up parties and spear the fish on the beds at night; thus destroying the young by hundreds of thousands. Nets are also used, and many fish are said to be taken from the lake by this method. Anything or any way to get the fish, seems to be the idea of the people in the neighborhood.

The lake is well stocked with black bass, wall-eyed pike, perch, etc., and contains some pickerel. It is a natural bass lake however, as it has principally rock or gravel bottom. It is watered by the snows from the surrounding hills and is fed by hundreds of springs. Many thousands of bass I have seen taken from its waters—fighters all of them; and if properly protected by the law's officers, this would be the greatest fishing water in the country. Even as it is, I am of the opinion it is today the best lake, for general fishing, in the state.

There are three houses at which anglers can be accommodated: Mrs. Herder's, at the Southwest end, where only transients are taken. Conklin's, at the East end, and the Island House, kept by John C. Loop. "The island" is not exactly an island, but a peninsula, of 23 acres, located about midway between the East and West ends of the lake. It is prevented from being an island by a strip about 15 feet wide. This point is covered by oak trees and is a most delightful resort, particularly adapted for picnic parties.

In the fall ducks and geese stop at Copake, and can be had by the thousands. It is a pity there is not a good, well kept, moderate priced hotel here. It would pay well. Better than that, however, some sportsmen's club should buy the property.

It could be bought cheap, and could be made, within 3 years, the best fishing lake and one of the best shooting grounds in the whole United States. J. C. Young.

#### THOSE ELK LAKE TROUT.

Woodworth, Mont.

Editor RECREATION: I have read the letters of Messrs. Comings and Blair, on the trout of Elk lake, and am sure the trout that Mr. Sawtelle sent to the U. S. Fish Commission, 1887, was caught in Elk Lake. I was with Sawtelle the day he sent them.

There are none of these fish in Henry's lake. I was there 12 years and did not see any taken from the lake. There were 50,000 to 100,000 trout taken from the lake each year.

Mr. Blair knows more about Elk lake than I do, though I have known the lake since '82. I am better acquainted with the lake in the Bighole basin than he, as I spent a summer there, with a sportsman from California.

We left the Railway at Dillion, Mont., and it took us 3 days to reach the lake. We did not have tackle strong enough to land the largest fish we hooked in the lakes, and did not get a fish of more than 6 pounds. We hooked some we thought would weigh 20 to 25 pounds.

I have no doubt there are fish in the lakes that will weigh 25 pounds. I saw the skeleton of one on the shore that could not have weighed less than 30 pounds. These lakes are called "Twin lakes." The lake is on the West side of the basin, above the 2 swamp creeks, 6 or 7 miles South of the wagon road that goes to Gibbonsville, on the North fork of Salmon river.

This is a fine place for a fall hunt. There is plenty of game near by—moose, bear, goats, elk and deer. In '85, when I was there, it was the best place for moose I have seen in the State. The outlet of Twin lakes, in spawning season, is full of greyling, as well as the lake. Cliff lake, which Mr. Blair writes of, has 3 inlets instead of 2, Horn creek, Antelope creek, or, as some call it Antelope Basin creek, and Hidden Lake creek. The fish in Cliff lake belong to the greyling family, and are said to be found in no other part of the world except in Scotland. They have a horny projection from the centre of each scale, in winter, and may have in summer though I never caught one in open water. I could not find any bait they would take; so I speared all I ever got. They resemble the Western white fish, in shape, but are more solid. The meat is white. The mouth is like that of a greyling, only smaller. I should like to know if they are found in any other part of America.

Mr. Blair could easily get some for the

U. S. Commission, as he lives less than 8 miles from the lake. An old Scotchman told me they were not found save in his country.  
M. P. Dunham.

## WISCONSIN NOTES.

Fishing on Lake Winnebago has improved greatly since the net fishing has been stopped. White bass are plentiful, while at some points black bass are caught in good numbers.

Richard Harney, of Oshkosh, fishing on Lake Winnebago caught 17 black bass. The same day Anton Marheine took the steamer to Island Park, on Lake Winnebago, and there took row boat to Black Bird island where he caught 37 black bass.

J. M. Eisner, 375 E. Division st. and A. P. Rust, with Sprague, Warner & Co., Chicago, caught 7 muskalonge in Allequash lake, one weighing 20 pounds and one 13½ pounds.

G. W. Stauff, 661 Orchard st. and L. F. Moeng, 346 Mohawk st., Chicago, caught 11 muskalonge, in Gresham lake, weight of largest 22 pounds. The same men made some big catches of wall-eyed pike.

Hosea McFarland took a 10 pound pickerel in Lake Elizabeth, near Rockford, Ill.

Seventeen black bass, weighing 50 pounds, an average of 3 pounds each, were taken from Duck lake, by F. C. Payne and Lloyd Breck, in 2 hours' fishing, near Watersmeet.

Martin Johnson, of Tomahawk lake, caught 3 muskalonge, weighing 41 pounds, and 8 pike weighing 24 pounds. Mr. LaSalle, of Rhinelander, caught a muskalonge weighing 29 pounds, in the same lake.

Mr. Chatterton, of Rhinelander, caught 40 bass, some weighing over 4 pounds each, at the same place.

A. F. Dod, of Chicago, caught 6 large black bass, 24 pounds of pickerel and some croppies, in one hour. The bass weighed 2 to ½ pounds each. E. Kentnor, St. Louis, caught 8 good bass.

Thos. F. Gane, of Chicago, caught a muskalonge weighing 24 pounds, and 12 black bass, all in half a day; and on another day 30 wall eyed pike.

Dr. E. C. Williams and wife, and W. H. Sterling and wife, of Chicago, caught, at Pelican lake, during the month of June, 48 muskalonge weighing a total of 503 pounds.

F. B. Miner, of Pelican Lake, caught 157 pike and bass July 11th. H. J. Frick of Antigo landed a muskalonge weighing 37 pounds. A. J. McLain and Chas. Ede, of Chicago, caught 17 pike in one hour. Mr.

Reynolds, bridge inspector for C. & N. W. Ry., and his brother, from Spokane, Wash., took a 13 pound muskalonge and 25 fine pike.

## A CAR LOAD OF HOGS.

Here is a bulletin that was sent out, in August last, by the Passenger Department of the Pennsylvania Railway, to the editors of the newspapers along its line:

"Superintendent Wilson Brown, of the Camden and Amboy Division, P. R. R., had a party of the division chiefs, as his guests, on his private car at this place. The party enjoyed a day's fishing on Barnegat bay, in the yacht *Lenox*, with Captain Charles Bozarth, and caught 400 fish, the largest number being caught by Thomas B. Appleget, G. C. Bishop, John Ford, Wilson Brown, Jr., C. E. Wiler, F. J. Potter, J. W. Perry and G. Latrobe.

"Prof. William R. Boswell, of Philadelphia, made a fine catch of 340 fish in 2 hours, and would have caught many more, had there been room in his boat for them. (!)

"The finest catch of the season was made by a party composed of T. N. Stokes, and John H. Craven, of Philadelphia; J. M. Howell and J. R. Bunting of Atlantic City, and George H. Fry of Jenkintown, Pa., who brought ashore 1,090 weak fish, the product of 2 days' fishing."

The exploit of these Railway officials is one of the coldest blooded pieces of butchery that has yet come to my knowledge. These men should be interested in the propagation and preservation of the fish and game in their territory; but instead they seem anxious to have them exterminated. One of the editors, to whom this bulletin was sent, referred it to me with the explanation that he had not printed it, and should not do so; as he did not wish to honor these men in this way. RECREATION is, however, glad to give them a place in its branding pen.—EDITOR.

## BROWN TROUT AND FLIES.

Hon. A. N. Cheney, N. Y. State Fish Culturist, replying to Mr. J. Elmer Pratt's article in October RECREATION on brown trout in Michigan, says:

The brown trout certainly does rise to the fly. Witness the dry fly fishing in England—the highest form of fly fishing—for this fish. It takes the fly, also, in this country; but I have heard of cases where the fish have been planted and have done well, and yet would not take a fly. As such instances have not come under my personal observation, I cannot explain why. Possibly the waters contain so much food (and I have inclined to this explanation in some cases, from what I have been

told) that the trout will not rise to the fly until they have reduced their local food supply, in a measure. Furthermore it is possible the right fly has not been presented, or presented in the proper manner.

I would try these Michigan trout at dusk, with almost any fly; or if in broad day, use a Marston's fancy, which I have found very killing, in many waters. It can be procured in most tackle shops. It is an English fly, and an imitation of the natural insect. Any of the close imitations to Nature should kill, also. Hare's Ear and March brown are also killing.

A. N. Cheney, Glens Falls, N. Y.

William Sweet and Joe Miller, of Lead, S. Dak., were using giant powder, on trout, in Sand creek, a tributary of the Belle Fourche river, when a stick which Sweet held in his hand exploded. This set off 2 other sticks that he was carrying, and one which Miller held. Sweet was blown to atoms, and Miller's right hand and fore arm were torn off. At last accounts, Miller was lying at the point of death. This is, of course, a sad affair for the friends of the unfortunate men; but so far as they themselves are concerned, it serves them right, and I wish every man, who attempts to use dynamite, or giant powder on trout, might meet a like fate.

A Walton, N. Y., paper says a number of Walton fishermen have recently made fine catches. C. DuBois and E. L. Guild made a trip to Terry Clove, Monday, and returned Tuesday, with an 8 and a 10 pound basket full of trout. David Rothensies and W. T. Smith visited Colchester fishing grounds and caught 225 fish; a number of which measured 15 inches in length.

If this latter report is true these last named men should be heartily ashamed of their conduct and should have kept their action a profound secret, instead of flaunting their record in face of the public.

We were fishing in Lake Meddybemps, Me., last July, when one of the party lost his hand-line overboard, with a piece of wood that it was wound on. Two of us were using rods. We fished on for half an hour, then moved up the lake. After another half hour, we moved the second time.

My companion with the rod cast over and let his line run down 20 feet, when feeling something on his hook, he reeled in and brought up the line and wood, with a good-sized fish. The distance from our first fishing was not less than a mile.

How many readers will believe this?

R. C. E., Milford, Mass.

I have but recently returned from salmon fishing on the Kedgwick, which is a

branch of the Restigouche river. Poor luck attended our party. The fishing on the famous Restigouche, it was said, was the poorest for years. This seems an off year for salmon everywhere.

Kindly send me the July number of RECREATION. If it came in my absence it has gone astray. I miss it much.

H. O. Wilbur, Philadelphia, Pa.

George Johnston, statistician for the Canadian government, has prepared a statement of the fish taken, annually, out of the great lakes. The catch, both American and Canadian, amounts to 140,000,000 pounds a year, or 460,000 pounds a day. At this rate it will not be many years before the fish of the great lakes will be practically extinct.

Last June Miss Lillian Harrington caught a 4-pound laker and a 2½-pound trout at the same time. I have guided here for years and never saw that happen before. On the next day Mrs. Ham caught 5 trout that weighed 15¾ pounds, and a white fish of 3 pounds. She fished only 4 hours.

E. A. H., Kineo, Me.

New York, August 28th, 1897.

A reader of RECREATION asks for some points on fishing through the ice, for pickerel and other winter fishes. Will some one who is familiar with this sport please advise, through these columns, and oblige, THE EDITOR.

My husband was fishing on Seneca river, to-day, and caught 18 pounds of fish, including 6 small mouth black bass and 3 Oswego bass. The bass fishing is good here, and nearby anglers who go out bring in good strings. Mrs. F. J. Springsted, Seneca Falls, N. Y.

I caught a trout, June 15th, in Spring creek, near here, that was 19½ inches long and weighed 3 pounds 9 ounces when taken from the water. Large trout are numerous in this stream; but this was the father of them all.

Jas. Donaldson, Spring Creek, Pa.

I saw D. T. Smith, of this city, land a 17¼ pound shovel mouth cat, on a 4 ounce rod, using a No. 9 bass hook.

Chas. L. Lundy, Cincinnati, O.

Please send me the names and addresses of all the sportsmen of your acquaintance, in order that I may send them sample copies of RECREATION.

## GUNS AND AMMUNITION.

### THE BEST RIFLE FOR BIG GAME.

Salt Lake, Utah.

Editor RECREATION: Yours is the best sportsmen's publication I ever read. While its contents are all interesting, there is no part of it more so, to Western hunters, than "Guns and Ammunition." The question "What is the best gun for big game," is an important one, and I have heard it discussed in many lonely cabins and around many campfires, throughout the Northwest, during the last 18 years.

The "Old Reliable" Sharps was a favorite with old timers; but the advent of the repeater has so widened the field for investigation that there is now a great range of opinion as to the relative merits of different guns and ammunition.

We see Mr. Van Dyke advocating the 50 calibre, while Mr. Dunham says the 25-35 is the best "all-round" rifle he ever used. Both these gentlemen are Western hunters, of many years experience. "How doctors disagree"!

I have owned and used more than 20 different rifles, during the past 18 years; have studied their merits closely, and my experience and investigation lead me to favor big bores. I do not think it possible to make a 25 or a 30 calibre that will stop a bear or an elk as quickly as will a 45 or 50. The small bores will do for deer or antelope; but of all the old hunters I know, and have talked with, I have yet to meet one who would willingly face a grizzly with one of these small bores.

I once saw a grizzly shot 8 times, with a 40-82-260, and the ninth shot, from a 50-110, dropped him. It requires a heavy ball—one with great smashing power—to stop a bear. The deadliest shot that can be given is by a heavy ball, with a large striking surface, which will go almost through the animal, but which stops in him; thus giving him the full shock of the ball without any loss of its energy. It is the shock that kills quickly. The 45 calibre ball, weighing 405 grains, and travelling at 1300 feet a second, has more energy and power, and will do more damage, than the 30 calibre ball travelling 2,300 feet a second. The 30 ball has the greater penetration, but it is not penetration you want; it is foot pounds of energy; it is weight and momentum. It is the difference between striking a blow with a light cane and one with a heavy club; between a pebble and a brickbat.

"Syracuse" may do good work on a dead horse with his 30-30; but let him face a live grizzly, in a patch of willows, and he will pray for a gatling gun—or a tree.

I have not seen the new 50-100-450; but agree with Mr. Van Dyke in thinking it will

be almost the ideal gun for big game. The ball is certainly a good one, but a little more powder might be better.

I notice several of your correspondents speak favorably of the 44-40-200. This gun was the favorite with cowboys, in the 70's, but is now obsolete. One of your readers asks, "Where should I aim at a grizzly walking slowly by at 50 yards?" My answer is: "If your gun will break both shoulders, aim at the centre of his shoulder and cut loose. If it will not, either do not aim at all, or, pick your tree before pulling the trigger." John J. Adams.

### TRYING IT ON CATTLE.

Editor RECREATION: Although I have not hitherto been a subscriber to RECREATION (the leading sportsmen's journal), I have been a constant reader, by obtaining it through a newsdealer. Enclosed please find \$1 as my subscription for one year.

I am deeply interested in many articles found in your magazine, especially those on repeating guns and rifles. I have a new 30-30 Winchester, and am very much pleased with it. I have not tried it on game yet; but went out to the slaughter house and tried it on "domestic game." I shot 2 cows and a large bull, and all were killed instantly. The first one I shot with a soft nose bullet. It entered the centre of the forehead. There was about a  $\frac{3}{8} \times \frac{1}{2}$  inch hole through the skull. Then the bullet mushroomed, so that it shattered bone and tissue over a space 2 inches in diameter. The bullet—or what was left of it—lodged just under the skin, on the under side of the jaw next the throat.

The next 2 animals were shot in the same place, but with full jacketed bullets, the result being about the same. The bull had his head raised, so that his bullet ranged higher, and I could not find it at all. It passed through the skull, making a hole the size of the bullet. Then it must have broken and upset considerably, as the bones in upper part of the head were terribly shattered. The bullet struck the large joint that joins the spinal column to the skull, and made a hole in it about one inch in diameter and about  $\frac{3}{4}$  inch deep. The bullets must have been as fine as the bones were, by this time, for I could only find fragments of lead among the bones, and could not find the jacket. The casing was all I could find of the other bullets, the lead being completely gone.

I intend to go hunting this fall, and try this rifle on game, and if it gives as good satisfaction there, as it does at target, and in killing these cattle, it will be a great way in advance of the old black powder rifles.

I am also a great lover of the Winchester repeating shot gun; and do not see how a company can make so good a gun for so small a price.

I should like to inquire of the readers of RECREATION, what experience and results they have had in reloading cartridges for the 30-30 Winchester, with low pressure powder and tempered lead bullets. I bought a Perfection mould, and special double adjustable reloading tool, from the Ideal Co. The tools work all right; but I have not had much success with these loads. Have not, however, had time to make exhaustive experiments. I can shoot a fairly good charge (14 grains Dupont's smokeless rifle powder) and not lead the barrel. I used a 150 grain bullet, cast about 1 to 12 lead and tin.

Smokeless, Stillwater, Minn.

#### HOW TO FIND OUT.

Forest Glen, Md.

Editor RECREATION: Allow me to say, to any one who may be in doubt as to what rifle to choose, that if he will write the Marlin Firearms Co., enclosing stamps, and asking for their new catalogue of repeaters, he can make his choice unaided.

If, however, a word, in addition to this hint, be not amiss I shall venture to add that the Marlin repeaters possess one great advantage to the hunter—the side ejection.

One who has the fundamental work of hunting to learn needs a large amount of practice in shooting. This, with a large calibre, involves a good deal of expense. He should, therefore, have 2 rifles; one for practice and the other for work. The former may be of small calibre, the latter large. The one will cost but a trifle to use, the other will then be saved for emergencies.

A good plan is to use the .22 for target work and for practice on rabbits running, crows flying, etc. Then when the hunter finds himself within range of a running deer he can use his larger weapon with some chance of winning.

As the Marlin Company now build their rifles several convenient combinations may be made in the way of "take-downs." For instance: One may have the .25-20 and the .32-20—2 barrels for one stock. Or, he may have the .38-40 and the .44-40 in the same way. Or he may have the .25-36, the .30-30, the .32-40, and the .38-55—4 barrels for one stock, and all take-down.

These last may all be for smokeless cartridges, if desired, and with reduced loads; and by reloading your shells practice may be made inexpensive.

Were I going into the Rockies, where coyotes, badgers, jack-rabbits, and prairie-dogs were to give me practice, and moose, elk, deer, bear, or antelope to furnish the

real work I should want the .25-20 for practice and the .38-55 for work. Both are exceedingly accurate and in skilful hands, will give good accounts of themselves.

The .38-55 is large enough for any game to be found in America, provided the shots are well planted; and it is but little glory to kill game simply by smashing it to pulp with leaden pumpkins.

Let the seeker after information write the Marlin people and he will find abundant light. Their new catalogue has covered a wide area of interest to riflemen, beside just rifles.

Nimrod II.

#### HOW TO BUNCH BUCK SHOT.

Tomahawk, Wis.

Editor RECREATION: I learn from RECREATION that many of our friends are experimenting to find out the best method of loading buck shot, to make it hold together for a considerable distance.

I think I have solved the problem. At least so far as my experiments have gone I am satisfied with the result.

I have been able to place a charge of buck shot in a target at a range of 80 yards (with black powder) as close together as when they leave the gun. By varying the method of loading, a trifle, I can cause the shot to begin to scatter at 30 to 50 yards. My plan is as follows:

Have turned a round stick of wood, of such a size that when 5 thicknesses of heavy express paper are wound around it, it will fit in the muzzle of the gun (presupposing of course the gun is a choke bore). Glue the paper firmly, when winding, so when it is slipped off the stick it will form a strong cylindrical container for the shot. Place the shot in this, in layers of 3 or 4 each. Pound in the ends of the cylinder until closed squarely, with the exception of a slight orifice in the centre which will remain unless closed with wax. If these openings, at each end, are closed with wax rendering the cylinder air tight, it will not burst at any distance until it strikes an object. If only a small opening be left the friction of the air, as the projectile passes through it, will gradually disintegrate the cylinder and allow the shot to begin to scatter at 20 to 50 yards.

It all depends upon whether the 2 ends of the cylinder are closed air tight, or whether a large or small opening be left, as to when the shot will begin to scatter, after leaving the gun. If the ends are simply pounded in, and not sealed with wax, the charge will not usually hold together more than 10 yards.

My gun is a "New Baker," 12 gauge, and choke bored, and throws buck shot to my entire satisfaction, when the charge is prepared in this manner.

J. C. W.



## BLACK POWDER IN SMOKELESS SHELLS.

Why cannot black powder be used in the 30-30 Winchester or Marlin cartridge, with hardened lead bullet, as well as in the Savage?

The Savage people load 40 grains black powder in a shell, for black powder ranges, and if it can be successfully used in that gun I do not see why it cannot in Winchester or Marlin? The twist is about the same and the calibre is not enough larger to make much difference. Will some one please enlighten me

A. D. A., Newcastle, Wyo.

I referred this to an expert rifleman, who replies as follows:

Black powder, with hard bullets, will give excellent results in the 30-30 Marlin, and should in the Winchester also, as this rifle has a barrel bored and rifled to the same size. The Savage cartridge, which is advertised, has black powder with a metal cased bullet. I have never seen any advertisement of the Savage cartridge, with black powder and lead bullet, except the short range cartridge. The factory cartridges, for the Marlin and Winchester rifles, are the smokeless with full metal cased bullet; smokeless with soft point bullet, metal patched, and the smokeless short range cartridge with, of course, a light lead bullet. The rifling in the Savage and Marlin rifles is exactly the same, one turn in 10 inches, and as the Marlin people make both rifles it is apparent that anything which the Savage rifle can do the Marlin can also, as the material, rifling, etc., are the same.

The new Marlin catalogue, which has just been issued, gives complete information regarding the Marlin 30 calibre cartridge with several loads of black and smokeless powder, and hardened bullets, which have been tested in this rifle. A careful reading of this catalogue will show A. D. A. that he is laboring under an error. In asking for the catalogue he should mention RECREATION.

Marlin Crank.

## DANGER IN CUTTING SHELLS.

In a recent issue of RECREATION there is an article signed C. S. S. in which he says: "I was recently told by an old hunter that if I would take a common paper shell and cut it almost in two, clear around just below the powder load, and then fire it I could bore a hole through a 2 inch oak board at 250 or 300 yards. I tried it and found it would carry, accurately, up to 250 yards."

I do not think such a charge would shoot accurately, owing to its shape. Furthermore it is dangerous to shoot a portion of the shell, containing the shot load and wads, from the shell chamber through the smaller barrel. No doubt it would compress the shot so that it would ball, I

should like to hear from some gun maker as to the safety of such a load.

I sometimes shoot round bullets from a shot gun. I fill the shell with wads until there is enough of the shell projecting above the ball to crimp and hold it firm. I do not think it wise, or necessary, to put a wad in front of the ball. A ball that will slip through the muzzle easily, loaded in this manner, with lubricant, will shoot fairly well up to 100 yards.

Frederick H. Belcher, Irvington, N. J.

I have a 25-36 Marlin repeating rifle, which is a beauty. Do you think it a good gun for me to take into the woods this fall, to shoot deer? I want your opinion on this, or that of some of your readers. Do you want to hear about the work of my 25-36, and what I know of my gun?

J. W. Griffiths, Randolph, Wis.

ANSWER: Your 25-36 is too small, and carries too light a bullet, to be effective on deer. Of course, it would kill a deer if you hit him in the brain, the heart, or the spine; but missing these, you might shoot him through any other part of the body, and while the wound might prove fatal, in time, he might run a mile, or 3 miles, before stopping, and you might never get him.

The 30-30 Marlin, or the 30-40 Winchester, while but little larger in the bore, carries more powder, and the bullet has much higher velocity, consequently greater stopping power. I should certainly advise you to get one of these rifles, for deer hunting.—EDITOR.

12 OR 16?

I note in my beautiful RECREATION that J. A. B., Osage, Ia., would like to be enlightened as to which shot gun of the same make has the greater killing power—a 12 or 16 gauge. Some say the 16, some say the 12. Of course a good 16 is better than some 12 gauges that are made nowadays; but we are talking of the same make, and same style of bore. I have studied and experimented on these lines for years. Have had 8, 10, 12, 16 and 20 gauge guns. The 8 gauge is the gun to kill.

You can find this out by taking a 20 and an 8 gauge gun, and shooting them separately, into pine boards. You will find there is more penetration in the shot from the 8 gauge than from that of the 20. You will always find that part of your shot have better penetration than the others. Why is this? Because the shot that lies on the powder wad has the best momentum. The back shot always passes through the upper part of the charge, in flight; and the upper shot have one inch slack to fall back. That is where the upper shot loses its strength.

The larger the bore of gun the closer the shot will lie to the powder. I would not recommend an 8 gauge for common purposes, but would recommend 16 or 20 gauge, if you want a safe gun and ammunition.

I also had a 40-65 and a 45-90 Winchester. They were both good guns, on big game, if I got close enough to it; but let us talk of one that is better. I mean the 30 U. S. Army. For large game use the soft nosed bullet. Mr. W. Warren and I tried the 45-90, and the 30 U. S. Army, on game, and found the 30 has at least one-third more penetration, even with the soft nosed bullet, than the 45-90 with lead ball.

Chas. D. Hirsh, Benton Harbor, Mich.

C. R. W., Oak Park, Ill., in August RECREATION asks for a report of some one's experience with a 16 gauge gun. I have used a 16 for many years, for small game such as rabbits, grouse, squirrels, quails, etc., and there is none better. I have found, after numerous experiments with loads, that Du Pont's smokeless powder gives the best results of any that I have tested. My load, for squirrels and other small game, is 2½ drams of powder, one cardboard wad next to powder, 3 pink edge wads, or, in place of pink edge, I frequently use 3 black edge wads; one ounce shot with a thin cardboard wad on shot. This leaves about one inch for crimping. I use the "Handy Crimper" and smokeless shells, reloading shells until worn out. The gun I use now weighs 6 pounds 5 ounces. The left barrel is full choke and makes a close pattern. The right barrel is cylinder bore. I use 5, 7, and 9 soft shot, preferring odd numbers, as I think they suit the 16 gauge gun better than even numbers.

John Minsker, York, Pa.

Can you or your readers, tell me as to the relative merits of the 38-40-180 and 44-40-200 cartridges for accuracy, stopping power, etc., used in revolvers with 5½ or 7½ inch barrels? Also can these cartridges be loaded with a light charge and get accurate shooting? If so, how? Powder loose in shell, or wadded, with round ball seated in muzzle?

While I do not suppose either of these cartridges is so accurate as the 44 Russian model, are they not better cartridges to take into the woods?

Can the 45 revolver cartridges be obtained throughout the West as readily as the other cartridges mentioned?

I am deeply interested in your magazine, and enjoy reading the comments and suggestions in the department of guns and ammunition; but would like to see more about the revolver.

Kindly give me your opinion on the above questions, as you are a practical man; also leave it open for your readers.

Lindley D. Hubbell, Hartford, Ct.

Will some of my readers, who are revolver experts, please answer?—EDITOR.

#### LIFE OF SHELL AND RIFLE.

What would you say as to a 30-30 smokeless rifle? Will the bullets in time wear out the rifling? What is the difference between a 32-20 and a 32-40 rifle shell? Is the 32-20 smokeless? What other shells will a 32-40 shoot? Willie Hadden.

I referred this to an expert, who replies as follows:

"Mr. Hadden's inquiries relative to 30 calibre ammunition, and other cartridges, are fully answered in the catalogue issued by The Marlin Fire Arms Co., New Haven, Ct. The 30-30 smokeless rifle uses bullets copper patched, nickel plated. These bullets are somewhat harder on the barrel than the lead bullets, but as the steel used in the barrels of these rifles is harder than the jacket of the bullet the wear is not so great as might be expected. Still, in course of time these bullets will wear away the rifling. Nevertheless, I have seen smokeless rifles from which have been fired 5,000 and 6,000 shots, and they are yet as accurate and apparently as reliable as ever. The bullets used by some military authorities have steel jackets and these, of course, wear the barrel more rapidly.

"Regarding the difference between the 32-20 and 32-40: The 32-20 has a bullet .311 in diameter, and the 32-40 is .319. One shell is a little less than 1½ inches in length, while the other is over 2 inches. Both of these cartridges are furnished with black and smokeless loads. The factories make up short range cartridges, for the 32-40, which are merely light loads in the regular shell. These shells are crimped to prevent the bullet from slipping down into the shell."

#### NOTES AND QUERIES.

H. M. Bacon wants to hear from some one who has had experience with the Winchester 40-72-330, as to whether it is as effective on big game as the 45-70, '86 model. I have had some experience with both these rifles, and think the '95 model is really more effective on large game than the 45-70, '86 model. In fact, I think it the best black powder rifle I ever used. Have killed 3 bear, 3 elk, and some deer with it, and here is the record of a few shots:

Elk at 100 yards, shot through shoulders. Dead when I got to him.

Ditto, 75 yards, shot through body, just back of diaphragm. Dropped after taking a few steps and was unable to get up.

Ditto, shot back of shoulder. Ran 100 yards.

Bear shot through shoulders. Both der. Dead when I got to him.

Bear 40 yards. Fore-leg broken and shot in the breast. Was disabled, but not dead when I got to him. The shot in the breast went through lengthwise, coming out over the tail.

Bear shot through shoulders. Both shoulders broken. Dropped in his tracks.  
A. E. Hammond, Darby, Mont.

I have been reading your valuable magazine for some time past, and it is the greatest sportsmen's journal I have ever seen. I have been reading several back numbers, and it seems almost impossible for me to take time to eat my meals. When I receive RECREATION, I eagerly devour the contents, from cover to cover. The department which interests me most is guns and ammunition, and I wish more might be written on that subject. I wish to ask the editor of RECREATION which is the best grade of smokeless powder, and which loads are best for all kinds of game shooting—hand loaded, or machine loaded paper shells?

David J. Shafer, Covington, O.

These questions are respectfully referred to my readers, and to the back number powder companies who do not advertise in RECREATION.—EDITOR.

Replying to C. R. W., who wishes information concerning a 16 gauge gun: For the past 10 years I have used 12 gauge guns—Lefever and Parker—but the 16 gauge Charles Daly I got last fall I think is best of the lot. For pattern, penetration and long shots, it beats all others. I have killed fox squirrels at 70 yards, with No. 6 chilled shot. I always use chilled shot for game, as it will break bones, where soft shot will flatten against them. Two and one-half drams of Dupont smokeless powder, one card, 2 felts on powder, 1 ounce No. 6 chilled shot, with thin card on shot, makes a good load for a 16 gauge.

C. A. Peterson, Allegheny, Pa.

Will some reader of RECREATION please write something on "How to learn to shoot, with a rifle, on the run."

Homer Raleigh, E. Oakland, Cal.

I wish to say to those who are using, or about to use, the new 30-30 calibre rifle. I have found, by experience, that it is useless to use the metal patched bullet in such a rifle, after having fired one or more lead balls from your rifle, until you have first wiped it out thoroughly. No matter how small the amount of lead may be, that is left in the barrel, it seems sufficient to deflect the metal patched bullet. I have seen

one thrown 3 feet off the target, in a distance of 75 yards. This was done when shooting from a rest; and, on one occasion, the metal patched ball darted down and struck a rock, not more than 30 yards from the muzzle of my gun, and about 2 feet below the line of sight.

W. E. Bartlett, M.D.

In reply to M. B., Conway Center, N. H., will say I have a fine 14 gauge breech loading shot gun that I have done some wonderful things with. It did not shoot close enough so I, like M. B., took it into my shop and rechoked it to a 1- taper choke.

I then took it down on Tulare lake and shot a jack snipe at the great distance of 190 yards, and put so many pellets in him that he sunk to the bottom of the lake before I could get to him.

Geo. Richardson,

L. A. W. Repair Shop,  
Tulare City, Cal.

P. S.: Size of shot was No. 9; charge of powder 3½ drams, 1⅛ oz. shot. This is a true statement.

In answer to E. R., in July RECREATION, as to using the 16 bore shell as a shot case, and firing from a 12 gun: It is the best thing I have yet found and I have tried everything I have ever heard of in the way of shot concentrators.

I loaded 2 shells with 3 drams of nitro powder to ⅞ ounce of No. 8 shot. The first shot, at 25 yards, put 136 pellets in a 9 inch circle. The second shot, at 30 yards, put 127 pellets in the same sized circle.

In both cases the shot remaining in the case struck above the circle, and made a large hole in the target.

We owe our abundant supply of game, in Sussex, to the mild winter. Quails, rabbits and doves are plentiful. Plovers and grouse I have heard little of.

Comet, Newton, N. J.

To make a good gun grease take of pure lard (no salt) ½ pound, gum camphor a lump the size of a hickory nut; place over a fire and boil until a scum raises. Take this off, then mix with the clean oil enough graphite to give it a dark steel color. (Graphitoleo would be a good substitute for the graphite.) Then take 2 ounces of raw linseed oil; place over a fire and boil 5 minutes. Darken this with graphite also. Then mix all together and let it cool. Then bottle for use. Keep it well corked. This is cheap and will come as near preventing rust as any preparation I know of.

W. B. S., Lock 53, Md.

I should like to hear from some of the small bore cranks, through RECREATION,

who have used the 22 calibre hollow point bullet, as to its penetration, etc.

I enjoy shooting the 22 rifle, and have a Colt's repeater. I cannot understand why the Colt people have not sense enough to advertise in RECREATION, the king of sportsmen's magazines.

I like the way you are giving it to the fish and game hogs. I hope soon they will come to their senses (the Stevens' Point hogs especially) and behave as sportsmen should.

Sandpiper, Osaga, Ia.

In your August number C. R. W. inquires about the 16 gauge gun, and the best load. I have a 16 gauge Parker, and use No. 12 shot, for woodcock, and No. 8 for everything else; and with Dupont powder, it does the work. Two and one-half drams Dupont and one ounce No. 12 shot will make a woodcock wilt mighty quick; and  $2\frac{3}{4}$  drams, with  $\frac{3}{4}$  ounce No. 8, will settle almost any bird. On account of the thick brush, 4-5 of the woodcock I have killed this year have been killed on the rise, within 25 or 30 feet, which speaks well for No. 12 shot.

16 Gauge, Akron, Ohio.

Game is very scarce here; nothing but a few rabbits. Reed-bird shooting is our main sport.

I do not approve of a 16 bore gun for the simple reason that it has not the spread or killing power of a 12. As for the shells, there is little difference in weight—not enough to be noticed.

A. B. Trainer, Trainer, Ga.

On September 11th, Mr. Robert Hoffman, of Pittsburg, improved his former score of 114 at 200 yards, muzzle rest, by one point. Mr. Hoffman used a 32-40 Ballard and U. M. C. shells, loaded with Du Pont powder, and his own moulded bullet. He made the following score, with 10 consecutive shots:

11 12 12 12 11 12 12 12 10 11—Total, 115.

I have experienced some difficulty in finding any address to give you, as Schrapnel shot cartridges are so seldom asked for now. I find however the address used to be, Schrapnel Shell Co., George St., Edinburgh, Scotland; and I understand that address will still find them.

Wm. Cashmore, Birmingham, England.

I should like to ask, through RECREATION, how heavy a trigger pull our friends think best to use in a sporting rifle, which cannot have a set trigger attached? I should also like to ask who does not think RECREATION the best magazine published? I do.

P. Barron, M.D., N. Y. City.

Will some of the readers of RECREATION please tell me whether they think the 30-30 Marlin repeating rifle large enough for big game; and how far it will kill.

Also is the 30-30 and 30-40 Marlin rifle of the same calibre. Victor Winfrey.

I should like to ask Mr. R. C. Fisk, or any one who has had experience with Lyman sights, whether or not it is advisable to have a rear open sight on the barrel, if a Lyman rear sight is used? I have an idea the open sight might obstruct the view from the peep. R. B. B., St. Louis, Mo.

I should like to hear from the readers of RECREATION as to how the Winchester 1894, 25-35, works on bear and deer. Also how it works with short range ammunition. G. M. Soule, Stoneham, Pa.

Will friend "Amateur," of Des Moines, Ia., please send me his name and address? I should like to correspond with him, privately, in regard to the Cashmore gun.

W. H. Fletcher, Alpine, Tex.

#### DEER PLENTIFUL IN MUSKOKA.

A Toronto despatch says: "The prospects for deer, this fall, are very promising," said Deputy Game Warden Lawrence, of Muskoka. "There never was so good an outlook. Never before have so many deer been seen, at this time in the year. The Ontario Government is anticipating a large increase in the number of hunters in the region, and has decided to increase the staff of officials in the district."

\* Send me \$1.50 for RECREATION one year and Mr. W. T. Hornaday's great book, "The Man Who Became a Savage." The book alone sells at \$1.50 in the stores. Renewals are included in this offer.

There will be a hot time in Grand Rapids, Itasca County, Minn., October 29 and 30, and November 1 to 10. Write to Dr. W. P. Brown, Secretary Gun Club, for information.

I have been taking RECREATION for the past year and think it, as my German friend expresses it, "de only bubble on de beer." N. C. Schoppert, Titusville, Pa.

I receive RECREATION regularly and enjoy it very much, it is the best magazine of the kind I ever read.

T. S. Penney, Alliance, O.

I heartily concur with you in your war against the game hogs. Keep it up.

M. D. Cary, Pulaski, Va.

## NATURAL HISTORY.

### MAMMALS NEAREST THE NORTH POLE.

W. T. HORNADAY.

Nansen's story of his unparalleled sledge journey, from the ice-bound *Fram* up to  $86^{\circ} 15'$ , and thence down to Franz Joseph Land, and safety, is of intense and even thrilling interest. To the naturalist, as well as to the meteorologist and geographer, it is even more than that; for it is full of zoological observations, all given with that exactness of detail which creates value.

It will be remembered that on March 14, 1895, Nansen and Johansen, with 3 sledges, 2 kyaks, 1,340 pounds of dead weight and 28 Siberian dogs to draw it, left the good ship *Fram* at latitude  $83^{\circ} 50'$ , where she was frozen fast in the ice pack, and drifting slowly across the polar basin toward Greenland. On their first night out the cold registered  $45^{\circ}$  below zero. Those 2 men left the ship without the slightest possibility of returning to it, and staked their lives on their ability to reach civilization and safety, somewhere, by their own efforts.

Over rugged ice-fields, and through blinding blizzards, they toiled toward the pole until, on April 8th, they attained what is now the "Farthest North," at latitude  $86^{\circ} 15'$ —nearly  $3^{\circ}$  farther than the point reached by Greely's men! No land was visible, and, finding it impossible to proceed farther, the retreat Southward, toward Franz Joseph Land, began.

Very soon Nansen's observations on the animal life of that desolate and terrible region became of absorbing interest. The first signs of animal life were tracks of the arctic fox, observed on the 85th parallel—a warm-blooded animal, living and thriving, within 300 miles of the North pole! The proof that *Vulpes lagopus* had recently dined was unmistakable. I have always said that if any wild animal ever reaches the pole, it will be the one to whom Nature has kindly given thick fur on the bottoms of his feet.

At  $83^{\circ} 20'$  the explorers found the water lanes in the ice-pack "full of narwhals;" but to any one save a whaler, narwhals are not exactly "game." On May 20, at  $83^{\circ} 10'$ , the first tracks of polar bears were seen. Other bear tracks were found 10 days later. The first living thing actually seen was a bird—a fulmar petrel—which was observed on May 29th, when the men must have been at about latitude  $82^{\circ} 30'$ . The next day 2 ringed seals (*Phoca foetida*) were seen on the ice, but they found safety in a water lane. A black guillemot circled round the party several times.

"It is beginning to grow lively here," says Nansen; "it is cheering to see so much life."

On June 4 (latitude  $82^{\circ} 17'$ ), the explorers made their first killing—an ivory gull (*Larus eburneus*), which was flying over the tent. Others were seen, but even in that wild ice-world they knew enough to keep out of gunshot. Nansen went after them, fired once and missed.

"One cartridge wasted; this must not be repeated!" said he. More seals and narwhals were seen that day, but none were killed. Strangest of all, however, "a small bird flew over, which Johansen, who was standing outside the tent, took to be a kind of sandpiper."

On June 18 (same latitude as before), Nansen shot 2 fulmars, 2 Brunnich's guillemots, missed 2 seals in a water lane, and wrote, "there is a good deal of life here, now." For all that, however, the men were faring badly for food. Little auks were numerous, but so small it was an extravagance to shoot them. They had only 148 shot cartridges, 181 rifle cartridges, and 14 ball cartridges; and their supper was 2 ounces of bread and one ounce of butter to each man.

On June 22d, a great event occurred. They saw and killed a bearded seal (*Phoca barbata*), and instantly the whole world brightened.

"We now have an abundance of food, and fuel for a month," says Nansen. "We need hurry no longer!"

They camped right where they were, for several days, and presently became "rich beyond the dreams of avarice," by killing another seal.

On July 10th (latitude about  $82^{\circ} 10'$ ) Nansen's camp was visited by 3 polar bears, a female and 2 cubs, all of which were killed. On the 15th "a Ross' gull came by," and from that time on many others were seen. From that point down to where the 2 wanderers spent the winter, polar bears were numerous, and many were killed.

On August 11th, at the Northeast corner of the Franz Joseph archipelago, in latitude  $81^{\circ} 30'$ , the 2 kyaks of the explorers were surrounded by walrus, who threatened to sink the whole fleet. A little later, 2 arctic foxes were seen on the ice, fighting over a little auk that one of them had caught, while myriads of little auks flew overhead, "screaming shrilly from the ledges in the mountain side."

On August 27th Nansen and Johansen landed on Frederick Jackson Island, (Franz Joseph Land), in latitude  $81^{\circ} 19'$ , and prepared to spend the winter there. An arctic highlander would have called it a paradise, for all around them, even at their very door, were walrus and polar bears literally to burn! At once the men went forth slaying and to slay, and ate and burned

bears and walruses, all winter long. They killed 21 polar bears, made beds of their skins, and lived and grew fat on fried bear steaks, and on bear meat, boiled over walrus-oil fires, and dipped in walrus-oil.

Of walruses they killed quite a number, with great and greasy labor gathered in the "product," and utilized their thick hides, their flesh and their fat in every possible way. The voyagers photographed many of their walruses at short range, and we rejoice that the negatives were not spoiled by any one of the score of evils that beset the camera and the plates of the explorer. For the first time we have, in Nansen's book, some pictures which show us the actual form of the Atlantic walrus *in life*, on his native ice. For 15 years I have waited and watched for the appearance of such pictures as are shown opposite pages 386 and 396; and to me, they alone are worth the price of the book. To my thinking, Nansen throws more light on the moral character of the Atlantic walrus than any other writer who has encountered him.

They killed polar bears until they were tired. On October 21st, that species disappeared, for the entire winter, but returned in force early in the spring, and prowled around the hut and the blubber-heap, only to get shot for their desire to be sociable. The walruses also disappeared during the winter, but the arctic fox remained to enliven the dreary months. Judging from Nansen's records, *Vulpes lagopus* is, for his inches, the champion thief of the world. The versatility of his talent for appropriation knows no bounds save the limit of his carrying capacity. Under varying conditions, the foxes stole and carried away everything they could carry—such as pieces of bamboo, harpoons, harpoon-lines and steel wire. The thermometer was stolen once, recovered, and stolen again; and even Nansen's collections of stones and mosses were not slighted by those persistent prowlers.

On the journey southward, in the spring of 1896, hundreds of walruses were encountered, and more than once the lives of both the explorers were imperiled by them. It is not good nor wise for a full grown walrus to try to climb into a thin-skinned kyak, in the open sea, especially into a kyak that never was built for 2. Of what they saw on June 14th, Nansen writes as follows:

"The walruses here were innumerable. The herds that had been lying on the ice and had now disappeared, were large; but there had been many more in the water, outside. It seemed to seethe with them on every side; and when I estimate their number to have been at least 300, it certainly is not over the mark."

#### WHERE ARE THE WILD PIGEONS.

Editor RECREATION: The question is frequently asked, "What has become of the wild pigeons, which 20 years ago were seen in such countless numbers?"

During the past 17 years I have seen but a few small flocks; hence it seems they have nearly all been destroyed. In May last I learned, to my great delight, that a vast body of these birds had passed Northward through Shasta county, Cal. From hunters living there I have since learned that where they roosted, in their passage, large limbs were broken from the trees; and that their tumult was so great that sportsmen shooting in the roost, a few rods apart, could scarcely hear the reports of one another's guns, above the continuous roar of wings. I should be glad to hear from any of your correspondents who have any knowledge of the whereabouts of these beautiful birds at this time.

Chief Pokagon, Hartford, Mich.

The birds seen in California were doubtless the band-tailed pigeon.

The American passenger pigeon is not known on the Pacific coast. If any reader of RECREATION knows, definitely, of the whereabouts of any members of this latter species I should be glad if he would send me a full report of the facts.—EDITOR.

#### THE MIDDLETOWN BUFFALO HEAD.

Editor RECREATION: In the August number of RECREATION I notice the corrected measurements of the J. Guenther buffalo head, and as they seem to me all out of proportion, I carefully measured the top spread, 30½ inches, then the widest spread, 41½ inches, and as the distances between horn bases were not given, I measured several of my largest buffalo skulls and found the distance across skull, at lower horn base, to be 14 to 15 inches, straight line measure. Now, allowing even 16 inches from horn base to horn base, straight line measure, I fail to make connection even with 21 inch outside horn curves; and as the lengths of horns given are only 19 to 21 inches, respectively, it would be interesting to see a photo of the Guenther head, with correct tape line measurements. I think the Guenther head must have a wider skull than nature provided.

The photo of the buffalo head in the national museum shows it is from a young bull.

Aug. Gottschalck, Bozeman, Mont.

#### A STUDY OF EYES.

Questions frequently arise among sportsmen and others, as to the color of the eyes of some animal or bird. Few men observe minor points in birds or in animals as they

should. The eye is one of the most interesting features of any living creature. Let RECREATION readers, therefore, take up the study of eyes especially. Let every person who may kill, or who may have an opportunity of observing, in the live state, any bird or animal, including fishes, examine carefully, and report to RECREATION—briefly, yet tersely and explicitly—on the shape, color and form of the eye.

Such reports will be printed, from time to time, in the Natural History Department of RECREATION; and I am sure such a symposium may be made deeply interesting, if my readers will devote the care and thought to the matter which it deserves.

NATURAL HISTORY NOTES.

The San Francisco Call recently printed a blazing article, headed in big display letters, "Got a Fortune in Feathers," and telling of 4 men (giving also their portraits, and pictures of feathers and eggs), who had been slaughtering birds, especially egrets, in Chiapas, Mexico.

These bird butchers reported that on an island "the birds were so tame we went right among them, and yet they wouldn't fly more than 20 feet away. In 5 months we got over 15 pounds of the egret feathers, which we brought home."

It is hoped the time will soon come when there will be no market for egret plumes, or other decorative feathers, and when such brutes will have to get down to honest work.

I have taken a deep interest in the discussion regarding the wolf's and the dog's habit of perfuming themselves by rolling in carrion.

I offer the following guess: Could it not be to drive away insect pests?

I have noticed the habit in dogs and they often select carrion in an advanced stage of putrefaction—generally dry or nearly so—around which no flies are hovering.

I only offer this as a possibility; but really believe it a probability. Who has not seen fleas leaving rabbits as soon as dead? Carrion baths have probably become hereditary, as have other habits peculiar to domestic animals.

Don D. Cornell, D.D.S., Knoxville, Ia.

Mr. Hornaday's article on the skunk, in the August number of RECREATION, is especially applicable to this locality. A Mrs. Randolph, of Tonto Basin, the wife of one of our big cattlemen, was recently bitten by a skunk, while camped at Little Springs, 20 miles from here. The animal fastened itself to her hand and retained its hold until her son smashed its head with a rock. They immediately packed up, came to

town, and took the first train for Chicago, where Mrs. Randolph is now being treated.

A. C. Fayer-Hickey, Flagstaff, Ariz.

Seeing the measurements of an antelope's head in RECREATION, and being interested in such matters, I inclose the measurements of a head I have.

The buck weighed 116 pounds and measured as follows:

|                                       |             |
|---------------------------------------|-------------|
| Length of left horn.....              | 16½ inches. |
| Length of right horn.....             | 16¼ "       |
| Spread of horns, at tips.....         | 13½ "       |
| Spread at widest part.....            | 16 "        |
| Length of skull.....                  | 14½ "       |
| Circumference of horns, at base ..... | 6 "         |

I have been careful about the measurements and know they are correct. I would like to hear from anyone who can go us one better.

Paul Compton, V D Ranch,  
Crazy Woman, Wyo.

I send you by express to-day, an antelope head (with my compliments) that will outmeasure, for length, circumference, and spread of horns, the head our Wyoming friend mentions. You can measure it and publish the measurements if you like.

W. F. Sheard, Tacoma, Wash.

|                               |             |
|-------------------------------|-------------|
| Length of horn, around curve  | 14¼ inches. |
| Spread at widest place.....   | 15½ "       |
| Circumference at widest place | 6 "         |

—EDITOR.

Apropos of the article in July RECREATION, on the brant with the arrow-head: 2 swans were killed here, in the Currituck sound, a few years ago, each of which had a flint arrow-head embedded between its shoulders and well covered with flesh, showing the missiles had been there for some time.

A. S. Doane, Coinjock, N. C.

The Natural History Department in RECREATION has given me many valuable points; and has taught me things I never dreamed of before.

C. T. Metzger, Union City, Pa.

Send me \$1.50 for RECREATION one year and Mr. W. T. Hornaday's great book, "The Man Who Became a Savage." The book alone sells at \$1.50 in the stores. Renewals are included in this offer.

Young man, go find a benison  
In twisting words from Tennyson:  
"Tis better to have loved and lost"  
Than to be married and be bossed.

## EDITOR'S CORNER.

SUBSCRIPTION RECEIPTS FOR  
2 YEARS AND 9 MONTHS.

Read the deadly parallel columns:

|                 | 1895.   | 1896.    | 1897.          |
|-----------------|---------|----------|----------------|
| January .....   | \$379   | \$723    | <b>\$2,146</b> |
| February .....  | 256     | 693      | <b>2,127</b>   |
| March.....      | 300     | 1,049    | <b>2,215</b>   |
| April.....      | 342     | 645      | <b>1,921</b>   |
| May.....        | 292     | 902      | <b>1,596</b>   |
| June .....      | 307     | 770      | <b>1,402</b>   |
| July... ..      | 345     | 563      | <b>1,101</b>   |
| August .....    | 306     | 601      | <b>1,906</b>   |
| September ..... | 498     | 951      | <b>2,223</b>   |
| October .....   | 438     | 969      |                |
| November .....  | 586     | 1,054    |                |
| December .....  | 652     | 1,853    |                |
|                 | <hr/>   | <hr/>    | <hr/>          |
|                 | \$4,671 | \$10,773 |                |

Look at the figures for September '95, '96 and '97. September '97 shows a gain of more than 400 per cent. over the same month of '95, and of 150 per cent. over '96.

Furthermore September '97 breaks all previous records. October will bring at least 2,700 subscriptions, and the succeeding 5 months will average more than 3,000 each. Stick a pin here and see how nearly correct this prediction will prove.

## SOME MODEL HUSTLERS.

Here are some remarkable records of club swingers. Mr. H. Z. Tillotson, of Dansville, N. Y., has sent in 141 subscriptions, for RECREATION, and has received as premiums for same, 2 gold watches, a Winchester repeating shot gun and a Marlin rifle. Mr. Tillotson secured these subscriptions in 15 days, besides attending to his regular business.

Mr. E. K. Tozer, A. E. Trask, Wm. Beaumont and Wm. Watts, all of Little Falls, N. Y., have each sent in 20 subscriptions and each has secured, as premium, a folding hand camera.

Miss Kitty Argo, and Miss Edna Hills, of Clinton, Ill., and Miss Marie Schneider and Mrs. C. B. Taylor of Williamsport, Pa., have each sent in 75 subscriptions and secured a bicycle, as a premium.

Mr. Wm. Gilbert, of Green Island, N. Y., has sent in 90 subscriptions and has been awarded a Winchester rifle, a gramophone, and a gold watch.

I could give hundreds of similar instances, from the records in this office, but these are sufficient to show what can be done, in almost any town, by people who are willing to hustle. Every person who undertakes to solicit subscriptions for this

magazine, reports that all that is necessary to secure the dollar is to lend the man a copy of RECREATION, over night, and call for it next day. The magazine does the rest.

The New York Sportsmen's Association has decided to give another exposition at Madison Square Garden, January 13th to 22nd inclusive. The managers combine, in this instance, with the bicycle makers, the show being held under the auspices of the 2 bodies, jointly. This is certainly a wise move. It insures every available inch of the garden space being occupied, either with sportsmen's goods, or with bicycles or bicycle accessories. It also insures a much larger attendance at the show than has ever been realized at either of the other sportsmen's expositions.

Another sportsmen's exhibition will be held in Boston, in March, under the auspices of the New England Sportsmen's Association, and under the direct management of Mr. C. W. Dimick, of the U. S. Cartridge Co.

RECREATION will be represented at both of these shows, and will hope to have the pleasure of meeting many of its friends there.

The December number of RECREATION will contain many good stories. Here are names of a few of them:

"Arresting a Navajo Indian Murderer," by Lt. E. H. Plummer, U. S. A.; "A Cart Load of Geese," Jas. Fullerton; "My First Buffalo," Conrad Haney; "Pierre's Stratagem," H. D. Ledbetter; "Among Iowa Quails," E. A. Johnson; "Hog Killin'" (Poem), W. H. Nelson; "Cayuga Lake Coons," L. Smith; and "Black Bass Fishing," W. H. Blackwell.

There will also be the usual array of good things in the departments, and a number of beautiful engravings.

RECREATION now has a larger paid circulation than any other sportsmen's periodical in America has, or ever had. This statement is made deliberately and without any disparagement to the other publications. It is a fact, and is given purely for the information of advertisers. I am prepared to furnish proof, on application.

She—What do you think of the Wedding March?

He—Not much. I never heard it but once, and I only wish I hadn't heard it then.

If you want to see RECREATION prosper, and grow larger, buy the goods advertised in it in preference to those that are not.



## BICYCLING.

### JED HOLLISTER'S BICYCLE.

MARION F. GIBBS.

Jonas Weld was not given to many words, and when he tilted his gray sombrero at an unusually quizzical angle, and announced that he supposed they did "Expose on the ol' man awful," the men and boys congregated at the store, at "The Corners," leaned eagerly forward, assuring the possessor of the one available chair, of an appreciative audience.

"It's a sight beyon' me, seein' the care he's allers givin' the hull fambly," Jonas continued, "an' him down on his luck ever sence he found out there wuz another claim on that farm ov his'n, an' \$800 to pay, jest the same as over agin. Never heerd ov that? Well boys it's this way—ol' man Hollister wants a bike to fetch the mail from Thalston down here, seein' there's no end ov fuss ev'ry time a harness is thrun over that ol' mule his son, Abe, calls a hoss; an' I'll tell ye the story ef ye'll all chip in an' give yer mite. Is it a go?"

"Well, years ago, ol' man McHenry owned most ov that trac' by Hollister's, an' roun' by Cranberry creek, cl'ar to the divide. He had 5 boys, all on the harum-scarum order, an' jest acrost the bay lived ol' man Johnson, with lots ov money, an' ony one gal, right purty at that. Arter awhile Phil McHenry went East, an' soon Mary Hanner Johnson follered, to enter some kin' ov an institooshun ov l'arnin', a universal like. Nobuddy ever dreamed they thought ov j'inin' han's, but so it 'pears, an' not a soul knowed ov it.

"Purty soon Phil com' back to help the ol' folks. Never sed nothin' 'bout bein' j'ined at all. Years went on. Mary Hanner visited her home, but people sed she airned big money as a musicianer. Ol' man McHenry died, an' typhoid kerried off the res'. The lan' had be'n divided into farms, an' sold an' paid fur. All seemed cl'ar sailin, as our crafts go, when 'long comes Mary Hanner with a smilin' young chap an' a city lawyer. Seems the lad belonged to Phil. He never knowed it. She'd riz right up. He wuz wild ye know, an' lef' her. She hired a nuss an' cared fur that kid, airnin' her own way, 'til Johnson lef' her all that money, an' now she'd come with all the proofs necessary to 'stablish her claim and the boy's.

"Pshaw! How it did break people up! Specially Hollister. Some wuz fur cl'arin' right out, an' others fur fightin', by supreme writ ov course; but 'twa'nt no use. The money had to be paid, an' she showed no marcy to a soul. Jed. Hollister wuz one ov the peaceafyin' ones. Wanted to move funder down stream; but Abe would-

n't lis'en. 'Ruther be a king among hogs, Dad, than a hog among kings,' he sed; an' mos' worn out then, an' that wuz years ago, the po're ol' crectur listened, to his sorrer. 'Toilin', scrimpin' an' savin, fur what? 'Cause boys," and the speaker arose, the embodiment of physical strength, his blue eyes alight with that greatest of all virtues, Charity; his voice ringing above the wailing storm; "'Cause the force ov sarcumstances kep' him down! An' we'll have him up, in spite ov Abe an' the hull fambly, up on a bike, boys, tearin' through the town to beat the engine."

"But," a mild voice interposed, "Hollister don't lack much ov turnin' 70, does he?"

"Who cares ef he's a hundred!" thundered the excited crowd. "Ef he wants a bike, he's a goin' to hev it, to-morrer, See!" And although several days elapsed, at last "the silent steed" arrived, to astonish, delight and perplex the venerable owner, who firmly resolved to master this "wheel within a wheel" as he admiringly called it.

His efforts, though untiring, seemed born of failure, and when the days became weeks, with success as far in the distance as on that memorable day of its arrival, Jonas decided to see for himself if it was an impossibility, as one of the more daring of his townsmen had asserted.

Half way to the house he met Abe, almost frantic with rage at this new freak of his hitherto docile parent, and a gleam of amusement lurked in Jonas's eyes, as he returned the brief salutation.

"You'd better go on up to the house. He's lassoin' the hull consarn, makin' a sort ov tackle on the piazza. Sich 'tarnal foolishness!" And the enraged man strode hastily away. A few minutes later, the gleam became almost a shout, of amusement as Jonas beheld the wheel securely fastened by stout ropes to a large hook in the roof of the piazza, the owner, firmly seated, pedalling away with an air of satisfaction impossible to describe.

"This'll bring her to her milk, eh! Weld?" was the anxious query.

"Keep this up a couple ov weeks an' I'll get the hang ov it! Conscience, but this is a power, an' no mistake!" as in a glow of perspiration he dismounted to critically inspect the once fractious, but now thoroughly subdued bicycle.

In spite of all objections offered, at home, and they were many, "A couple ov weeks" did elapse before the astonished group, seated on the front steps of the store at "The Corners," caught a glimpse of a figure in the distance, speeding toward

them. "It must be—no—it could not be—ol' man Hollister, at that rate ov speed!"

When he dismounted, and delivered the mail, there was no room for doubt, and a cheer arose from their brawny throats, while women and children gathered around to gaze—open mouthed—at the unexpected sight.

"I thank ye, boys, fur what ye've done fur an ol' man," he said. "An' I don't care how many laff an' say 'Here comes a scorcher,' an' 'Whar's my cameray?' Not a bit, boys"—the quavering voice was growing more tender—"fur as I fly through the woods an' hear the birds a singin', the frogs a croakin', an' think how free I am boys, fur a time, anyway, I realize I've jest begun to live. An' may God bless ye all fur makin' an ol' man happy."

The man was in the kitchen, eating bread and coffee;  
His wife was in her bloomers, trying to show off—he  
Having, in his blindness, given her a wheel,  
Which now, his only hope was somebody would steal.—Exchange.

#### BICYCLE FOR WAR PURPOSES.

Lieut. J. A. Moss, commanding the bicycle corps of the 25th infantry, has filed an official report of his trip, from Fort Missoula, Mont., to St. Louis, a distance of more than 1,900 miles. In this report he says:

"Thirty-four days of actual travel, at an average rate of 6.3 miles an hour, were necessary to make the trip. We were delayed 4 hours and 7 minutes repairing tires, 13 hours repairing bicycles and 372 hours and 28 minutes for luncheon and other purposes. Except while in the sand hills of Nebraska the health of the command was good, and none of the soldiers was in any way disabled or made sore from riding. The trip through the sand hills, however, was extremely tiresome and trying, and tested our powers of endurance to the utmost. About three-fourths of the corps were sick from the effects of alkali water. The water in Wyoming and South Dakota was also bad. In these 2 States we were sometimes compelled to travel as far as 30 miles without getting water fit to drink. On several occasions we were caught in rain storms, between our relief stations, where it was impossible to buy rations, and were consequently compelled to ride miles with little or nothing to eat. On one occasion we rode 42 miles on a cup of weak coffee and a small piece of burnt bread.

"We had a number of breakages, due to reckless riding. The greater part of the trip was made under the most trying circumstances, through mud, water, rain, sand, over mountains, bad roads, fording

streams, etc., the whole time living on the regulation field and travel ration, cooked in improvised utensils. The trip has been very satisfactory to me, and has, I think, fully demonstrated the practicability of the bicycle as a means of transportation."

When a scorcher in future is captured,  
And to justice, his victims appeal,  
A novel complaint might be worded,  
Arrested for "roasting" his wheel.

#### THINKS THE SOUTH AHEAD.

"In the matter of building good roads," says the Helena "Independent," "it is said the South is now ahead of the North, and that North Carolina leads the South. Under the law of that State, petty misdemeanants are employed at making public roads, and convicts are employed in the same way. Under the operation of this law the State roads are being changed from mud to macadam. Tramps are included as misdemeanants, and, when caught, they are set to work on the roads.

"We believe the California road law is better than that of North Carolina. Under it the tramp and the unemployed generally are not treated as criminals, but have the legal right to demand work on the roads, board and lodging, and that a small wage be paid. The North Carolina law does not put the tramp, who is willing to work, in the way of bettering his condition, while the California law does. Under the latter, with board and lodging furnished, an unemployed man can, with thrift, economy and frugality, on a wage of 35 cents a day for 300 days in the year, save up \$10,500 in 100 years; and then he can go into business for himself."

Daisy, Daisy, gave him her answer true,  
And now he's crazy, riding the avenue;  
It's proved a happy marriage and instead of  
a baby carriage,  
The third small seat looks trim and neat  
On a bicycle built for two.

—L. A. W. Bulletin.

#### WITH WHEEL AND ROD.

Editor RECREATION: I have just returned from a pleasant cycling and trouting trip, in Forest county, Pa. The trout were not plentiful this year, but I caught 155 in the 5 weeks I was there. I could have taken more but had no use for them.

The wheeling was fine, during the dry weather, especially along the river and creek roads. There is good trout fishing in Forest county, in summer, and during the fall and winter white and gray rabbits, ruffed grouse, and squirrels are abundant. There are also a few wild-cats and foxes. Deer and bear are also quite plentiful.

I have been in that country a number of times, and whenever I wanted a guide I got John Wolfe, of Kellettsville. He is thoroughly acquainted with all the best fishing and hunting grounds, and if you want a guide for that country you could not get a better one than him.

I am going to Minnesota this fall, after big game, and will write you of my trip when I return.

I consider RECREATION the best sportsmen's paper published. Keep up the good work against the game and fish hogs. It seems impossible to regulate them by law, but maybe you can shame them out of their infamous ways.

A. A. Harrington, Conneaut, Ohio.

"Slocum still rides a high wheel."

"Yes; he says when he gets a fall he wants one that will do him credit."

#### ASPHALT STREETS.

The figures below are from data up to January 1, 1897, except for Washington, which includes work completed up to July 1, 1897. In Buffalo, since the first of the year, there has been as much paving done as in Washington, and the difference between the two cities remains practically the same, although Buffalo's exact mileage is not obtainable. The following are the figures, in mileage, of 10 cities: Buffalo, 200 miles; Washington, 120; New York, 58; Kansas City, 46; Chicago, 33; Omaha, 31; Newark, N. J., 19; New Orleans, 17; St. Louis, 13; Topeka, Kan., 13. Washington's figures include asphalt, asphalt blocks and coal tar.—Post, Washington, D. C.

"Joe, you and that pretty Miss Flutter seem mutually impressed."

"I should say so; we've fallen off a tandem on each other three times."

#### FAR WEST CYCLE PATH.

The bicyclists of Port Townsend, Wash., contributed \$2 per wheel and have constructed one of the finest paths in the State. It is 4 miles long, and cost \$350. Although several hills are crossed, the grade was so carefully considered that the run can be made both ways without one having to dismount by the way. The view at the end, out over the Straits of Juan De Fuca, is something grand. Westward the rolling Olympics appear, northward the distant hills of British Columbia show above the horizon, while to the Eastward Mount Baker looms up in solitary grandeur (to use a stereotyped phrase). We were fortunate in being able to utilize the road bed of a defunct street-car line for part of the dis-

tance, which materially reduced the price of the path.

J. G. McCurdy, Port Townsend, Wash.

#### CYCLING NOTES.

Road improvement in Alabama was started several years ago, some of the pioneer work being done about Birmingham. The "News" of that place now reports that "the county commissioners of Colbert county will let contracts for the building of \$100,000 worth of roads in that county, the money having been placed in the county treasury for that purpose. The last legislature authorized the county to sell bonds, to the above amount, for this purpose. The bonds were sold and the money is in hand, in cash."

"Did you hear what Bobby told grand-ma?"

"No; what was it?"

"He said: 'Gran'ma, if you get a sailor-hat an' some leggins, I'll let y' ride my wheel.'"

The passenger committee of the Trunk Line Association has finally decided to accept bicycles as personal baggage, between States. This rule, however, does not apply to the transportation of bicycles between the United States and Canada.

The same committee, in November, 1895, agreed to impose a tax on all bicycles carried for passengers. "The world do move."

"What is a pedestrian?"

"He's a narrow-minded chump who won't climb a tree when he sees a scorcher coming."

We have excellent roads here for wheeling. They are like cement and so there are many riders. Albert McNulty is the champion racer of Humboldt county, and is a clever trick rider as well. We have a club of 60 members, and the ladies have one with a membership of 20.

Arthur Thompson, Bridgeville, Cal.

A Pocket Camera, listed at \$1, for 2 subscriptions to RECREATION. Makes a picture 1½x1½ inches. Send for circular.

Notwithstanding the decision of the National Cycle Board of Trade not to hold a cycle show next winter, a number of the bicycle dealers of Chicago have decided to hold a show on their own account, in that city, early in the new year.

I never saw a magazine I liked half so much as I like RECREATION. There is plenty of game here.

Harry Atkinson, Fordyce, Ark.

## CANOEING.

### A FORTNIGHT IN CAMP.

WM. ELLIOTT FAY.

A coat of thick tan is not the only thing the canoeists took home with them when they broke camp, the last days of August. It was the fourth time the American Canoe Association had camped on Grindstone island, and many an enthusiastic paddler greeted the St. Lawrence as an old friend. The wooded shore at the foot of the Hog Back was the tenting ground of copper colored canoeists, long before the pale devotees of the sport ever trod this land; and arrow heads are still found by turning over the pebbles. Perhaps the knowledge that the original canoeists once haunted these waters and shores makes the spot dearer to the present generation of paddlers. Anyway all have a tender feeling for old Grindstone, and they love the broad stretch of Eel Bay as a sailing ground.

These canoeists are an heterogeneous mass, coming from all portions of the United States, and several parts of Canada; but all are in camp with the same object—healthful sport and a royal good time. They commence at once by throwing away the togs of civilization and arraying themselves in garbs that are cool and comfortable and that give free movement to every part of the body. Sometimes these costumes are fantastic and picturesque; but they are always comfortable.

Of course the first thing to do is to pick out a site, put up a tent and decorate the canvas habitation with trophies and banners, not forgetting to scatter around enough camp duffel to make the place look homelike. The canoeists are experts in camp making and long experience has taught them just what to lug along to secure comfort without the bother of a vast amount of baggage. One little kit will contain all the toilet articles necessary; and another one, scarcely larger, will hold all the cooking utensils needed to prepare an elaborate camp dinner. When the appetite is whetted by a 5 or 10 mile paddle, food slips down easily, even if not served in its most tempting form; but the canoeists are fond of good things to eat. Some of them are even expert in preparing a camp banquet.

As in tropical climate, the evening in the canoe camp is the principal part of the day. It is a sort of every night Mardi Gras, with conservative old business men acting the part of clowns and the whole camp joining in the merrymaking. Some of these owls are scarcely seen in the daytime, and apparently sleep while the sun is up in order to make good its absence

with their bright sayings, which rival the very camp fire in brilliancy.

If you have never seen 200 men and women seated around a blazing camp fire of knots and dead branches, then you have missed the best side show extant. Any minstrel troupe could get valuable pointers from the spontaneous humor which flows incessantly at one of these gatherings. Music is a prominent factor at these home talent, outdoor entertainments, and charms the midnight air with its melodious strains.

Paraphrases are especially taking and one can hardly make a move, in the daytime, without having some singer work it into a song, for the delight of the crowd that evening.

Naturally, so much gazing at stars and flames makes a lazy camp in the morning, but a brisk St. Lawrence breeze soon blows the froth from one's brains, and a cool plunge in the river quickly washes the dust from sleepy eyes.

The great public events are the sailing and paddling races, for which the contestants begin practising as soon as they arrive in camp. Interest in the contests is strong, and craft of every description bring visitors to witness the events, the victory being always announced by cheers from every quarter, firing of small cannons and blowing of steam whistles.

The tan which the summer sun imparts will soon wear off, after the return to business; but the buoyant spirits and the pleasant memories of the meet hold good until supplanted by another.

Franklin, Pa.

### MEMBERSHIP COMPETITION.

The Commodore and Secretary-Treasurer offer an Open Canadian Paddling Canoe, with single blade paddles, as a first (1st) prize; also a pair of single blade or double blade paddles, at the option of the winner, as a second (2nd) prize, to the members securing, before the opening of the 1898 Meet, the largest, and next largest, number of new (active) members, respectively, to the "American Canoe Association."

The presentation of prizes will take place at the Meet. The re-election of ex-members will not count in this competition. By sending a postal card to the Purser of your Division, application blanks will be mailed to you.

RECREATION, a monthly magazine, the official organ of the Association, will be sent to each member, free of charge.

For further particulars apply to the undersigned.

Frank L. Dunnell, Commodore,  
C. V. Schuyler, Secretary-Treasurer.

## SPECIAL ANNOUNCEMENTS.

Galt, Ont., September 29, 1897.

Editor RECREATION: Please publish the following names of members of the Gouverneur Club, in the A. C. A. official organ, as candidates for associate membership:

| NAME.                | ADDRESS.                           | CANOE.   |
|----------------------|------------------------------------|----------|
| Mrs. A. L. Woodworth | Gouverneur, N. Y.                  | Nicolete |
| Miss Ione Jillson    | Edenton, N. Y.                     | Tusitala |
| Mrs. Lyman A. Walton | 7214 Webster Ave.<br>Chicago, Ill. | Aucassin |
| Mrs. C. P. Gaines    | Canton, N. Y.                      | Queen    |

John R. Blake, Secretary-Treas.

The following are appointed as committees to serve during 1898:

## REGATTA COMMITTEE.

Percy F. Hogan, Chairman, 243 Pearl Street, N. Y.; Raymond Apollonio, Winchester, Mass.; C. Howard Williams, 39 White Bldg., Buffalo, N. Y.

## CAMP-SITE COMMITTEE.

H. L. Quick, Yonkers, N. Y.; Henry C. Morse, Peoria, Ill.

(Chairman of this committee to be named later.)

## SPECIAL COMMITTEE.

*Auditing Committee—(Board of Governors.)*

John C. Mowbray (Chairman), 100 Broadway, N. Y.; N. S. Hyatt, Sing Sing, N. Y.

(Signed) Frank L. Dunnell,  
Commodore.

## PUZZLE CORNER.

## HIDDEN LETTER PUZZLE.

My name of letters 6 is known  
To readers far and near,  
In "books worth reading" you will find  
It frequently appear.  
Three letters of the 6 are found  
In "Tales" that thrill the soul,  
And 3 of them in "books" are seen;  
Now who can guess my whole.

Each person solving this puzzle will receive an article that will come handy in the library. State on what page the ad appears in which the hidden word appears.

I consider RECREATION the cleanest magazine published, at any price, for the advancement of true sport, and am glad to see the hogs get a roast. They deserve more than that; they should have their heads shaved and should wear the striped suit for a time. Then they would realize they were not the only people in the world.

E. S. Prescott, Littleton, N. H.

## FOR THE BOSTON SPORTSMEN'S SHOW.

Antonio Apache, the young Chiracahua Indian who recently went to the Canadian and Northern Maine game country in the interests of the New England Sportsmen's exhibition, to be held in Boston in March next, has just returned to Boston. His journeyings covered a distance of nearly 2,000 miles, and many of the Indian camps and settlements of New Brunswick and Canada were visited. Contracts were entered into which secure the personal attendance and services at the show, next spring, of a number of Indian hunters, trappers and guides, several of them to be accompanied by their families, all clothed in the primitive and picturesque habiliments of the aborigines, and engaged in canoe building, trap making, and in the fashioning of the rude weapons of warfare and woodcraft which have, since the introduction of the white man's methods, become almost entirely obsolete. Among the interesting specimens brought to Boston, by Antonio Apache, is a model of a primitive Indian tent, composed of birch bark, enclosed in a framework of saplings, open at the apex for light and air, and with a deer hide hanging over the entrance, and serving as a door. There are also birch bark canoes, as fashioned 200 years ago; a great variety of traps for the capture of bears, otter and other animals, and a number of devices for the taking of game birds: all composed of saplings and logs, and rudely, yet effectively, contrived.

The other features of the exhibition are in the hands of thorough sportsmen and effective workers, and rapid progress is being made.

Applications for space from all sections of the country are daily being received; and the management desires to especially invite the co-operation of all who may wish to secure space for exhibits which appeal to or are likely to interest the sportsmen of New England.

Application blanks, plans of the exhibition building and full particulars will be mailed on application to the executive offices of the New England Sportsmen's Association, 216 Washington Street, Boston, Mass.

You certainly have the best advertising scheme on earth. The man who fails to advertise in RECREATION is not wise. Each succeeding number of your brilliant magazine is better than the one before it, and I am always impatient for the next one to come. It is doing a noble work among game and fish hogs, by way of educating them to see matters in the right light, and I cannot say too much in praise of RECREATION. I wish you all the success you so richly deserve.

G. W. Humes, Harrisville, N. Y.

## ON THE CHILKAT PASS.

Skaguay, Alaska, Sept. 17, 1897.

Editor RECREATION: I am here for the winter. On arrival, we found many discouraged would-be miners. Some sold their outfits before starting on the trail, and took the next steamer for home. Others got as far as the summit of Chilkat pass and then brought back their supplies, at great expense, and packed them over the Dyea trail, paying the Indians as high as 40 cents a pound.

Messrs. Street and Wenzel, my partners, and I started in to buy outfits and sell them over. We did a good business, for awhile, but then the steamers brought merchants, with a full line of supplies, which put prices of general merchandise almost on a par with those ruling at Seattle. I surveyed the town site and made a map of it. In this way I picked up some dust that comes handy. There is a great demand for lots and cabins. I am locating on lots and my partners are putting up cabins. We each have filed on a lot and have cabins on them, which we could easily sell for \$250 each.

The cabin we live in is the cosiest and best in town. I must send you a picture of it and the surroundings. We have our musical instruments and firearms strung up, all around the interior. We never have less than a dozen visitors, any evening, and they are as fine a class of gentlemen as you would meet anywhere. They are such people we meet at the Sportsmen's Show. Almost everyone here has ready money. Among them are dozens of correspondents for newspapers and magazines. Mr. Kerney, representing a New York daily is here, now, waiting for a chance to see the trail; but will not be able to start for several days, for the storm of yesterday and last night carried away the first bridge. It is impossible to ford the river, now, as it is still raining and blowing hard.

Every day brings dozens of men back from the pass, the most discouraged and worn out mortals you could imagine. Some of them are sick in body, as well as in spirits. Two men from Seattle have been packing 7 weeks, on this trail, with 3 horses. They had crossed the summit, got as far as the meadow and, seeing it was impossible to go farther, sold their outfit for less than Seattle prices. They had but one horse left and he was almost dead. To-day they struck our camp and will wait for the next steamer home. They say they are almost afraid to close their eyes, lest the scenes of the trail may come up before them; and they are not pilgrims by any means. They have been to all the great gold camps, for the past 10 years.

Mr. Street and I have been over the trail. We went with a pack train of 6 horses, loaded with feed. After the outfits get over the summit, they have to bring back all the

horses, have them re-shod and pack all the feed they can carry.

We each had a pack of 70 pounds on our backs, and I led a horse and carried camp kettles, etc. We made 12 miles the first day, through mud almost waist deep, over sharp, high rocks; over stumps and roots, and ducking under low branches of trees.

If a man should stop and look ahead, he would say, "We can't possibly get through here." But that is not the way it is done. You just keep putting your feet in front of you, and take chances as to where you will land. Sometimes through the mud, you will strike the point of a rock and slide several feet. Sometimes your foot will strike a loose stone, and will give your ankle a terrible wrench. Again you will catch your toe under a root, and fall on your face, in the mud. All this time you have to watch for the horse behind you, for he often falls your way. There is a dead horse for every 100 yards of trail; and every rock, sticking out of the mud, is covered with blood where horses have struck their legs. The mare I was leading, tried twice to throw herself down the canyon. Several horses have been successful in this.

That night we went into camp where there was no firewood, and pitched our tent on a rock, between 2 green trees, about 5 feet apart. We had a wall tent, 10 x 12, and you know what small quarters we were in. It was raining hard and about 10 o'clock 2 men came and begged us to let them in. We consented and before morning we were all driven out, by the river rising to our bedding.

It rains almost every night, and is foggy during the day, with few exceptions. When we do have a clear day, we can appreciate it. The mountains are grand—to look at.

We thought our cabin the best place on earth, when we got back. The moon was shining on it, and inside were several jolly friends to welcome us. We were covered with mud, from head to foot. After taking a bath and putting on clean clothes, we had a good supper and some music; and with the exception of very sore feet, I was O.K. Still, I could not help thinking of the poor unfortunates who keep right on, from week to week, with no chance to change their wet clothes. After getting to Lake Bennett (if they ever do) it is hard to buy any kind of a boat for less than \$500.

Mr. Truerman, instructor in athletics, at Seattle, my partner, Bob, and I went up in the mountains, just West of Skaguay bay, on a hunting trip. We took sleeping bags and provisions for 3 days, a Marlin and a Winchester rifle and a shot gun. We had been told, by the Indians, there were plenty of sheep, caribou, moose and bear.

We climbed almost straight up, for 2 days, camped at timber line, and didn't see a living thing larger than a deer fly. These

were numerous, and a great bother. There were plenty of goat signs, but they were old. We found a well worn trail, leading to a beautiful lake. It looked like a moose trail, and must have been made in winter.

There are plenty of trout in the lake, for we could see them jumping; but had no fishing tackle.

We evidently did not strike the right mountain. There is plenty of game here, and fish too, for I have seen bear, moose and goat skins, and plenty of fish. When we get a chance, and the Indians stop packing, we are going hunting with them.

I hope, later, to write you something of interest for RECREATION.

Harry L. Suydam.

\* \* \*

Every visitor to the Sportsmen's Exposition knows Harry Suydam. He always makes headquarters at RECREATION'S booth, and is a most admirable young man. I hope he may strike rich dirt, when he gets over to the mines, and that he may have to charter a steamer to bring out his nuggets, 3 years hence.—EDITOR.

#### HOW TO REACH THE KLONDIKE.

Ft. Wrangle, Alaska.

Editor RECREATION: It is simply wonderful to see the mad rush of people for the Yukon region. The Klondike, a tributary of the Yukon, is the centre of attraction. Thousands of men have surmounted the Chilkat pass, large numbers have gone by way of Behring sea and up the Yukon, by the North American Transportation and Trading Co.'s steamers. Many others are going up the Stickeen river by way of Ft. Wrangle, and over the trail from the head of navigation, on the Stickeen, to Teslin lake. From there they go down the Hootlinquy river, and a number are going by way of Telegraph creek, the head of navigation on the Stickeen, to Dease lake; thence down Dease river to the Liard and up that to Francis lake. These purpose developing a new mining country on the head waters of the Yukon, still farther North.

For those, however, who are able to have their packing done, the route via the Stickeen and over the trail to Teslin lake is a very good one, and there are scarcely any hardships to be encountered. The trail is a long one, but not difficult; and when Teslin lake is reached plenty of timber is found for cutting lumber. From there you have clear sailing, over the lake and down stream to the Yukon.

Parties leaving the coast in winter can find good traveling on the ice, up the Stickeen, after the first of February, and can outfit and go over the trail to the lake on dog sleds, in good shape. Then they can go down when the river sheds its ice, in the spring.

A. J. Stone.

#### BOOK NOTICES.

"Citizen Bird," in spite of its unsatisfactory title, merits a warm welcome from everyone who loves birds. The book is a brave and spirited effort to make American bird lore so pleasing to young people that it will become popular with them. What would we not have given for such a book in our boyhood days! In competition with this fascinating story, brim full of interesting facts, ingenious aids to the memory and good bird pictures, even Robinson Crusoe would have had to take a back seat. I can not see how, to any boy or girl, possessing one spark of intelligence and love of nature, this book can be anything else than irresistible.

Briefly stated, it is a bright, breezy story, in 33 chapters, wherein Dr. Roy Hunter, a naturalist, 4 bright young people who also love birds, and a fisherman, range far and wide over the farm, up the river, by the marsh and along the shore, chatting about and diligently noting the birds they see. In the whole of the story there is not one technical term, nor a Latin name; but there is a good, clear, classified list at the end. Over 100 species of birds pass in review, and in addition to the bit of story belonging to each, there is a crisp 10-line description of size, colors, food habits and geographic range, and a good picture.

Every aid to the understanding, and the memory, that Mrs. Wright and Dr. Coues could devise has been introduced and exploited, to enable even the youngest readers to remember clearly what is here set down. On this ground only are we reconciled to such alliterative groups as "Tree Trappers," "Wise Watchers," and "Weed Warriors," which, without mitigating circumstances of some sort, I should consider too frivolous, even for this book.

The illustrations, 111 in number, are all by Mr. L. A. Fuertes, and while in the main they are full of life, originality and good art, their value varies considerably. Many are really fine, and of these particular attention is called to the skilful handling of the black species, such as the black-birds and crow, which are so difficult to treat, satisfactorily, in a book illustration. I am not quite satisfied with the feet of the perching birds; for very often they seem to pitch too far forward, and leave the bird hanging by its hind toes only. For example, the picture of the wood thrush shows how the toes should not grasp the perch; while that of the hermit thrush shows how they should. In several of the birds showing strongly contrasted colors, the treatment of the black plumage is rather hard; but, with a few exceptions, Mr. Fuertes's drawing is excellent.

Believing sincerely that our young people and our public-school teachers need more natural history, more love of living

things, and less algebra, fossilized ancient history, and other useless studies, that wear out our boys and girls to no purpose, I heartily welcome "Citizen Bird." It is the first volume of an important series, and I hope it may win for itself a permanent place in our schools, as a text book, or a supplementary reader.

CITIZEN BIRD. Scenes from Bird-Life, in Plain English for Beginners. By Mabel Osgood Wright and Elliott Coues. New York: The Macmillan Company. 1897. Crown 8vo, pp. 428. III Illustrations. \$1.50.

#### A BREEZE FROM THE SOUTHWEST.

Mr. Alfred Henry Lewis need not draw another card. With "Wolfville" he stands pat. Long before his publisher sent it to me for notice, I read it and gloated over it with many gloats. On taking it up again to see if it still seems what it did at first, I like it better than ever. Beyond a doubt it is great; and if Mr. Lewis only develops good staying powers, we have in him an author to be proud of. The editors of the "literary" magazines will not like him, for they can not stand anything not cast in their divine moulds. Instead of seeking to interest live people, they aspire to "make literature;" but the American people will like "Wolfville"; and, like little Oliver, they will "want some more!"

It is a book of tales of an Arizona cattletown, told by the Old Cattleman to an interested and sympathetic tenderfoot,—the author. Wolfville is the principal scene of action, but it also serves as the axis round which some of the stories revolve. The same characters appear in most of the stories, and I am glad they do.

There is a swing and "go" about the characters that is delicious. Contrary to literary-magazine custom, there are no dreary pages upon pages of heart-searchings and qualitative analyses of inner thoughts and secret motives, that have become a weariness of the flesh. Thank Heaven, we are spared all that! These stories have good, hard flesh on their bones, and blood in their veins. They are also American—another quality to which the "literary" editor usually objects.

The action is lively, but without a trace of spurring on the part of the author. The gun-play is frequent and free, and while at times the thread of a story is almost burned off by powder, somehow the tales do not seem gory! This is because the author does not take himself too seriously, nor pose as a heavy tragedian, working up awful climaxes. The tragedies are not described as such, but merely as incidents and accidents happening in the stories of Cherokee Hall, Dave Tutt, Enright, and the others.

But the humor of it! In "Wolfville" there are more laughs to the page than in any book that has reached my hands since the days of Nasby. Without the slightest apparent effort to be amusing, the picturesque similes and slang expressions of the Arizona cattle-country, and their application to human beings and their affairs, is irresistibly funny. The frontier philosophy throughout the book is simply delicious.

The inventive genius of the author, and the artistic quality of his touch are really great. His humor is genuine, original and abundant. For the sake of the lovers of good things, I hope he has come to stay. But I beg of him not to pump his well dry to please the literary syndicates, nor to deliver himself into the hands of the literary magazines, and fashion his work to suit their stupid standards. If he does either of these things, we will soon be writing of the light that failed; but if he preserves himself, sticks to his own standards, and strives for quality rather than quantity, all America is his.

WOLFVILLE; by Alfred Henry Lewis (Dan Quin). Illustrated by Frederic Remington. New York: Frederick A. Stokes Company. 12mo, pp. 337. \$1.50.

"SPORT ROYAL I WARRANT YOU.—*Twelfth Night*. Thomas Martindale. Price one dollar." And not another word on the title page! The make-up of this little book surely will throw some reviewers into fits. There is no imprint. The printer sticks his own name where the author's copyright notice should be; the frontispiece has jumped the claim of the dedication; there is neither table of contents, list of illustrations, nor index, and the dedication trails along after the preface.

But who cares? The book's a book for a' that; and when you have read it, and have taken a good look at the handsome portrait of the author, you make up your mind he is a genial gentleman, and a scholar; that you would like to hunt with him, and to have him for a member of the Camp-Fire Club.

We find Mr. Martindale is a Philadelphian, for, with rare and commendable judgment he roasts his own town, instead of ours. His book, of 148 pages, is an illustrated story of 2 hunting trips to Maine, for moose, caribou and deer, each trip being fairly successful; a long shooting trip over the Canadian Pacific Railway to Vancouver—almost as bloodless as a French duel. Then there is a story of brant shooting on Monomoy island, Cape Cod, and several sketches of hunting in Pennsylvania and elsewhere.

The stories are told with a degree of directness and fidelity to truth that is both refreshing and interesting. The author en-



joyed his recreations, to the limit, and the reader enjoys them with him—all but one. Oh, Martindale, Martindale! How could you be so careless as to hunt moose, for days and days, in awful weather, with so rusty a rifle that when your one great chance came the hammer would not fall? I sympathize with you, most feelingly, when your more trusty rifle failed to kill another big moose, but I trust that rusty rifle met its just deserts across the trunk of a large hickory tree. Next time you should keep it clean and well oiled.

I like the author's parting shot at the man of business, "chained like a felon in his cell," making money, and allowing his health to go to the dogs. Mr. Martindale preaches the gospel of Rest and Recreation. "Money without health is a much greater calamity than health without money." His example in taking such beneficial and interesting trips, and then describing them in word and picture, that others may enjoy them, is commendable.

Next time, however, I would advise him to counsel with some experienced book-maker before going to press—as most other book-writers do; to eliminate the mischievous little errors that even the most careful author is prone to overlook.

---

Every person who subscribes for RECREATION, or renews his subscription, this year, can get a copy of Mr. W. T. Hornaday's delightful book, "The Man Who Became a Savage," for 50 cents extra. The book sells in the stores at \$1.50; but you can get RECREATION one year, and the book, for \$1.50.

---

An Australian Mosquito-Proof Tent for 10, 15 or 25 subscriptions to RECREATION—according to size of tent. Send for circular. This tent is light, compact, water-proof and *insect-proof*.

---

I have organized a gun club, and have had it named the RECREATION Gun Club.  
A. H. Miegel, Augusta, Ga.

Thank you, cordially. I have sent you a flag bearing the name of your club.—EDITOR.

---

Ed. Billings and I are taking 7 sportsmen's periodicals, but think more of RECREATION than of any of the others.

Fred A. Sweet, Smyrna, N. Y.

---

She gathers bright autumn leaves—yellow and red—

What a muss in the parlor they make:—  
And she'd faint dead away if anyone said  
She must gather them in with a rake.

## PUBLISHER'S DEPARTMENT.

A new field is opened for lovers of the rod and gun, by an excursion which leaves New York, this winter, for all seaports of Mexico, Guatemala, Honduras, Costa Rica, Nicaragua, U. S. of Colombia, and Venezuela. The steamer, fitted up with all comforts for tourists and invalids, remains in each port long enough to visit the interior. For instance, she lies at Savanilla 4 weeks, as most passengers will ascend the Magdalena river, cross the Andes to Bogota, the capital of Colombia, and visit some of the gold mines in that republic. A party of 15 is being made up who intend to have a steam launch at their sole disposal, to go off from the ship on shooting and fishing trips, up the various rivers. Six months is calculated as the duration of the tour, returning about June 30th. The manager, Capt. A. L. Lowe, 567 W. Boulevard, New York, will answer all inquiries, promptly.

---

Gerhard Mennen tried a full page ad in RECREATION, reluctantly. He said he did not believe it was a good medium for his business; but the results were such as to induce him to supplement this with another full page order in the next 2 issues. This 2nd order expired with the October number, and he has now given me an order for a full page to run one year. Any advertiser who may be in doubt as to whether RECREATION is a good medium for general advertisers would do well to write the Gerhard Mennen Co., Newark, N. J.

---

There are several gun and fishing tackle makers, powder makers, and others, who persistently refuse to advertise in RECREATION though they do advertise in nearly all the other sportsmen's journals. This, of course, means that these manufacturers do not want the trade of RECREATION's readers. You will therefore assert your own self respect by not buying goods of such people.

---

If you have sent in a club of subscriptions to RECREATION, and have gotten your premium, and if it be satisfactory, please tell all your friends about it and advise them to do likewise.

---

Getting subscriptions for RECREATION is easy. The magazine does its own talking. Turn to the premium list, on page lix., and see what you can get by sending in a club.

---

I will esteem it a personal favor if you will send me the names and addresses of all the sportsmen you know, who are not yet readers of RECREATION.

# KODAKS

The annual family gathering at the Thanksgiving table, the Children's Christmas tree, groups of friends gathered to pass a winter's evening—all make delightful indoor subjects for winter Kodaking, while the fields and trees in snowy garb make quite as beautiful subjects for out-door work as do the green groves and meadows of summer.

**Put a Kodak on Your Christmas List.**  
**\$5.00 to \$25.00.**

#### POCKET KODAKS.

For Film Cartridges and glass plates  $1\frac{1}{2} \times 2$  inches, - - - \$5.00.

#### No. 2 FALCON KODAKS.

For Film Cartridges  $3\frac{1}{2} \times 3\frac{1}{2}$  inches, achromatic lens, - - - \$5.00.

#### No. 2 BULLS-EYE KODAKS.

For Film Cartridges  $3\frac{1}{2} \times 3\frac{1}{2}$  inches, achromatic lens, - - - \$8.00.

#### No. 2 BULLET KODAKS.

For Film Cartridges and glass plates  $3\frac{1}{2} \times 3\frac{1}{2}$  inches, achromatic lens, \$10.00.

#### No. 4 BULLS-EYE KODAKS.

For Film Cartridges  $4 \times 5$  inches, achromatic lens, - - - \$12.00.

#### No. 4 BULLET KODAKS.

For Film Cartridges and glass plates  $4 \times 5$  inches, achromatic lens, - \$15.00.

#### No. 4 CARTRIDGE KODAK. (Folding.)

For Film Cartridges and glass plates  $4 \times 5$  inches, with rapid rectilinear lens and pneumatic shutter with iris diaphragm stops, - - \$25.00.

The above Kodaks all take our Light-Proof Film Cartridges and can be

## LOADED IN DAYLIGHT.

*For Sale by all Dealers. Catalogues free at agencies or by mail.*

No Camera is a KODAK  
 unless manufactured by  
 the Eastman Kodak Co.

**EASTMAN KODAK CO.**

**Rochester, N. Y.**

## AMATEUR PHOTOGRAPHY.

### RECREATION'S THIRD ANNUAL COMPETITION.

RECREATION has conducted 2 amateur photographic competitions, both of which have been eminently successful. A third will be held, which it is believed will be far more fruitful than either of the others. This one will open January 1, '98, and close April 30, '98.

Following is the list of prizes as thus far arranged. Others may be added later:

FIRST PRIZE—A Folding Kodak, made by the Eastman Kodak Company, of Rochester, N. Y., and valued at \$75.

SECOND PRIZE—\$25 in cash.

THIRD PRIZE—A Cycle Korona Camera, made by the Gundlach Optical Co., Rochester, N. Y., and valued at \$22.50.

FOURTH PRIZE—An Adlake Camera, made by the Adams and Westake Co., Chicago, and valued at \$12.

FIFTH PRIZE—An Amateur Rotary Burnisher, made by the Acme Burnisher Co., Fulton, N. Y., and valued at \$10.

SIXTH PRIZE—A Baby Hawkeye Camera, made by the Blair Camera Co., of Boston, and valued at \$6.

SEVENTH PRIZE—1 Gross Blue Label photo print paper.

EIGHTH PRIZE—1 Gross Aristo Jr. photo print paper.

NINTH PRIZE—1 Gross Aristo Platino photo print paper, made by American Aristotype Company, Jamestown, N. Y.

The makers of the 15 next best pictures will each be awarded a yearly subscription to RECREATION.

*The contest will close April 30, '98.*

Subjects are limited to wild animals, birds, fishes, camp scenes, and to figures or groups of persons, or domestic animals, representing, in a truthful manner, shooting, fishing, amateur photography, bicycling, sailing, or other form of outdoor sport or recreation. Cycling pictures especially desired. Awards to be made by 3 judges, none of whom shall be competitors.

Conditions:—Contestants must submit 2 mounted silver, bromide, platinum, or carbon prints, of each subject, which shall become the property of RECREATION. The name and address of the sender, and title of picture, to be plainly written on back of each print. Daylight, flashlight, or electric light pictures admissible. Prize winning photographs to be published in RECREATION, full credit being given in all cases.

Pictures that have been published elsewhere, or that have been entered in any other competition, not available. No entry fee charged.

*Don't let people who pose for you look at the camera. Occupy them in some other way.* Many otherwise fine pictures failed to win in the last competition, because the makers did not heed this warning.

#### HOW SHE GOT THE FIRST PRIZE.

Editor RECREATION: It may interest you to know the picture reproduced on

page 177 of September RECREATION, entitled "The Hunter's Pause," appeared in another publication, as far back as 1894, under the title of "Mt. Jefferson from Grizzly Tarn, Oregon." I don't quite understand what you mean by your comment: "Joint winner of first prize." Neither can I see how this picture could have been eligible to the competition. I quote from the rules of the contest:

"Subjects are limited to wild animals, birds, fishes, scenes, and to figures or groups of persons, or domestic animals, representing, in a truthful manner, shooting, fishing, amateur photography, bicycling, sailing, or other form of outdoor sport."

There is nothing in this picture indicating any kind of sport; nor is there any indication or intimation of hunting; either in the past, present or future, expressed or inferred, except in the title given to the picture, on this present occasion. The man in the foreground surely is no hunter, unless he has left his gun and hunting clothes at home. Probably it is the dog who is the "hunter." In that case the printer has misspelled his "paws."

Seriously, I think Mrs. Wiggins, née Albert, has made a mistake in changing the title of this picture, although I must own she made no mistake when she changed the title of her other picture, "Hunting the Big Horn," which was awarded first prize in your competition. It is worth a \$75 kodak more, as "Hunting the Big Horn," than it was as "Mt. Jefferson, Oregon," when it appeared in the other magazine, in 1894. I have nothing to say as to the eligibility of this latter picture, in your competition. That has already been decided by your judges, in awarding it a prize. Besides I am aware a picture loses some of its snap, brilliancy and detail in being reproduced by the half-tone process. This doubtless accounts for my inability to discover in the picture, as reproduced in the July RECREATION, anything relating to hunting, or any other form of outdoor sport, either directly or indirectly.

As a photograph of a mountain it is certainly fine, but the very thing necessary to make it eligible in the competition seems to be wanting, in the reproduction at least. Will you not for the benefit of your readers who are photographically inclined, or who may not have an imagination flexible enough to fully understand these pictures, give us the "picture story" of each, as expressed in the originals of these 2 photographs, that we may be enabled to better appreciate the application of their present titles?

H. G. Reading.

ANSWER.—The first prize was awarded to these 2 pictures jointly. The judges realized that it required a stretch of the imagination to admit them, under the rules of the competition, but they decided to allow that the man in the picture entitled "The Hunter's Pause" might have left his gun on shore, when he walked out over the water; that while he was not in hunting costume this was not a fatal objection, as many men hunt in their every day clothes; and that, while the collie is not a hunting dog, he has often done good service in the woods, in various ways. In fact the judges adopted a most liberal policy, not only towards Mrs. Wiggins, but toward all competitors, and the rules were given as broad a construction as possible.

They did not know, however, nor did I, that either of these pictures had been published elsewhere. I did not learn this until after the September number had been printed. If I had known it these pictures would not have been admitted to the contest, at all.

As soon as I learned this fact I requested Mrs. Wiggins to return the camera which she had thus fraudulently obtained, in order that it might be awarded to the person to whom it now justly belongs. Mrs. Wiggins has thus far refused to return the prize, and holds it by mere force, and not by right.—EDITOR.

#### HE HAD PHOTOGRAPHS TO BURN.

Talking of the blunders of subordinates, writes DBJTX, in the News, a theatrical manager told me he had had made a number of costly photographs of his company, and had had them expensively framed. Being busy on the stage when they were brought to him, he called a stage attendant and told him to place them in the foyer. On entering the theatre, in the evening, he noticed the photographs were not there. He hunted up the attendant and asked him where they were.

"Shure I burnt them, sor," was the reply.

"Burnt them, you idiot! What did you do that for?"

"Bekase ye tould me to," answered the attendant in an injured tone.

"I didn't tell you to burn them!"

"Faith, sorr, ye did. Ye tould me to put them in the foire, and I wint right off and put them in the furnace beyant."—Exchange.

#### NOTES.

I have a fine collection of views of Western scenery, among which are the Spokane falls, old church bell tower, block of Washington spruce, 63 foot cedar stump, Castle Rock at Green river, Wyo., union

stock yards, Omaha, Neb., view at Point Defiance, part of Tacoma, Wash., a snow plow at work, and many others. If any of your readers would like to have any 2 of these, size 5x7, mounted on heavy cards, they can get them by sending me their name and address, and \$1.00 for one year's subscription to RECREATION. The magazine will, of course, be sent direct to their address from your office. The pictures cost the subscribers nothing.

C. G. Shepherd, Lathrop, Mich.

If you find a print which, after being toned and fixed, has not been printed dark enough, or which is weak, do not throw it away; but, after the final washing and drying damp it again and then squeegee it on to a piece of fine ground glass which has been previously well washed and polished with "French chalk." Of course this alters the tone a bit, but it strengthens the print wonderfully, and gives it a delightful matt surface.—E. B. N., in The Photographic News.

"Dickie has cried for two days."

"Poor child; what is the matter?"

"Well, Louise promised to take a photograph of him with his billy-goat. She worked an hour getting the goat posed to suit him, and when she developed the picture, the plate, being small, had taken only Dickie and the rope."

An Australian Mosquito-Proof Tent for 10, 15 or 25 subscriptions to RECREATION—according to size of tent. Send for circular. This tent is light, compact, water-proof and *insect-proof*.

There are still some unfortunate sportsmen who are not readers of RECREATION. If you know any such send in their names, and greatly oblige them and

THE EDITOR.

Please send me the names and addresses of all your friends who are sportsmen, in order that I may send them sample copies of RECREATION.

A Pocket Camera, listed at \$1, for 2 subscriptions to RECREATION. Makes a picture 1½x1½ inches. Send for circular.

I beg to acknowledge, with thanks, receipt of the Kenwood sleeping bag, which you gave me for 10 subscriptions to your excellent magazine. It seems almost like robbery to accept such a reward for so trifling a service as securing subscribers to RECREATION. However since the bag is here I will smother my feelings and retain it.

W. A. White, Orlando, Fla.

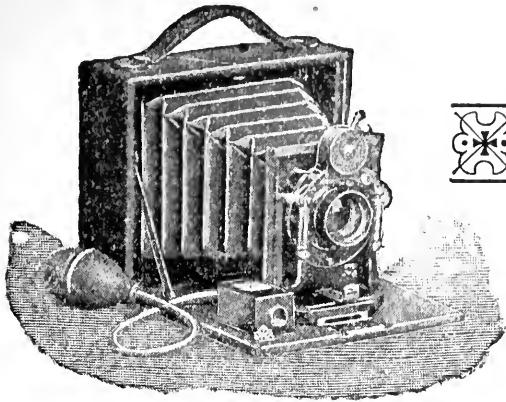

PREMOS  
PRODUCE  
PERFECT  
PICTURES

# Premo Cameras

Have achieved an enviable reputation the world over. Their PERFECT construction and ease of manipulation, combined with grace, beauty, and superb finish, have placed them in the front rank, and they are to-day the Favorite Camera with the foremost Amateur and Professional Photographers.

MADE IN

20

DIFFERENT STYLES  
AND SIZES

Special Designs for the Sportsman and Tourist

CATALOGUE MAILED FREE

Rochester Optical Co., Rochester, N. Y.

# Books Worth Reading

## Wolfville

By ALFRED HENRY LEWIS

A Story of the Far West, of greater force and truth than anything that has appeared since the early work of Bret Harte.

Wolfville is an Arizona camp, of which "cows is what you might call the leading industry." Mr. Alfred Henry Lewis ("Dan Quin") is the historian, he deriving his facts from the reminiscent prattle of the Old Cattleman, who is at once a Wolfvillian, an observer, a philosopher, and a systematic raconteur of high gifts.

"Mr. Lewis paints the real thing, and paints it with a virile force and freedom quite incomparable."  
—*New York Journal*.

The book itself is a superb example of the art of bookmaking. Frederic Remington, who is undoubtedly the best equipped artist in the world for such a work, has contributed 18 illustrations, most of them full-page.

12mo, cloth, \$1.50.

## Many Cargoes

By W. W. JACOBS

A Collection of Sea Stories, in a new vein. Over 12,000 copies of this book have already been sold in England. The critics pronounce the humor of these sketches unique.

"Some of his episodes are little masterpieces. . . . The reader who once took up this book would grudge every surprise; he would want to test each new story for himself, and, having tested them all, the chances are that he would sigh in the midst of his laughter for more."—*New York Tribune*.

12mo, cloth, \$1.00.

## Authors' Readings

Illustrated with one hundred and seventy-two pen-and-ink drawings by Arthur Young.

An illustrated "Story-tellers' Night," at which some of the most famous writers read or recite informally two or more of their best productions. *The author's pose and manner of recitation are illustrated—WITH SKETCHES FROM LIFE—down the margin of each page.*

The program includes nine authors:—Eugene Field recites; Bill Nye tells two stories; Ella Wheeler Wilcox reads from her works; Hamlin Garland reads a story; Mary Hartwell Catherwood reads a chapter from a well-known story; "M. Quad" reads two sketches; Opie Read recites a story; and James Whitcomb Riley recites.

1 vol., 12mo, \$1.25.

Two New Volumes in the Popular Twentieth Century Series

## The Touchstone of Life

By ELLA MacMAHON

Author of "A New Note." A Romance of South Africa. The plot of this story is most romantic, for the hero, Ivor Clay, is evidently modeled upon the character and adventures of Cecil Rhodes.

"It is a story of noble purpose and of brilliant aspiration, and a romance of unusual merit."  
—*Boston Courier*.

## They that Sit in Darkness

By JOHN MACKIE

Author of "The Devil's Playground" and "Sinners Twain."

A capital picture of the life at an Australian cattle station, and a delightful and unusual romance. One of the comments of the English critics on this work is:

"An entrancing work. Mr. Mackie in addition to his literary taste, unites the qualifications of rich and rare experience and observation."  
—*Northeastern Gazette*.

Each volume, 16mo, colored buckram, 75 cents.

## The Eye of Istar

A Romance of the Land of the No Return.

By WILLIAM LE QUEUX

Author of "Zoraida," "Stolen Souls," "The Temptress," etc.

The thousands of readers of "Zoraida" will welcome this similar (and better) romance, which is undoubtedly Mr. Le Queux's masterpiece.

"Zoraida" was a story of the Harem and the Great Sahara, and "The Eye of Istar" again takes the reader to regions replete with mysteries and adventures. An energetic and daring traveler himself in the dark continent, a serious student of Arabic and of the strange customs of the native tribes, Mr. Le Queux produces stories of an accuracy and value not often found in romance.

12mo, cloth, with illustrations by A. Pearse, and with ornate cover designed by Miss Richards. \$1.25.

## Lying Prophets

By EDEN PHILLPOTTS

A new novel by this popular author, which has already had a great success in England, where it is in its third edition. A story of great ability and force.

*The Pall Mall Gazette* says:  
"An excellent Novel. A piece of serious and admirable work. . . . Not unworthy of a place with George Eliot's 'Adam Bede' and 'Mill on the Floss.'"

12mo, cloth, stamped with gold, \$1.25.

## A Fountain Sealed

By SIR WALTER BESANT

A fascinating romance based on the early life of George III.

The story deals with the supposed courtship of a Quakeress, Hannah Lightfoot, by the Prince, and while imaginary, it corresponds with the probabilities and represents the Prince as he was—a young man of good principles, though of narrow views.

"No one can write better than Sir Walter of this period in English history, nor draw more effectively the pictures of the men and women of the past. The pathos in this last work of this distinguished author is touching."—*New York Times*.

Daintily bound in gray, white, scarlet and gold, after a design by Miss Richards. With illustrations of excellent quality.

1 vol., 12mo, \$1.50.

## The Charm

And Other Drawing-Room Plays.

By SIR WALTER BESANT and WALTER POLLOCK

With fifty delightful illustrations by A. Jule Goodman and Chris. Hammond. A most charming work of Fiction. The dialogue form employed adds to the attractiveness of the stories the authors have to tell. With a preface, giving many practical hints as to the best method of producing drawing-room plays.

12mo, cloth, \$1.50.

## Sheilah McLeod

By GUY BOOTHBY

Author of "Dr. Nikola," etc.

The scene of this interesting novel is in Australia. Mr. Boothby is thoroughly familiar with that country, and is at his best in depicting its picturesque life and inhabitants.

12mo, cloth, 75 cents.

FREDERICK A. STOKES COMPANY, 27 and 29 West 23d Street New York

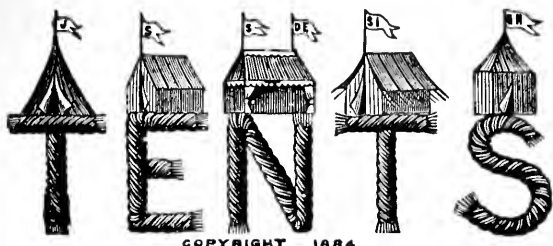

COPYRIGHT 1884

# AND CAMP OUTFITS

We manufacture the largest and most complete line of tents in the country, and our goods are celebrated for their wearing and waterproof qualities.

Send 4 cents in stamps for our new 40-page illustrated catalogue showing all styles of Tents and Camp furniture.

**GEO. B. CARPENTER & CO.**

202 to 210 S. Water Street, CHICAGO

Established 1840.

## Always Bright!



FOR '97

# WILL NOT JAR OUT

ALL RIDERS  
SAY  
IT IS  
The Best.

For Sale Everywhere.

**BRIDGEPORT BRASS CO.,**  
BRIDGEPORT, Conn.

Send for Circular.

# Tribune Bicycles

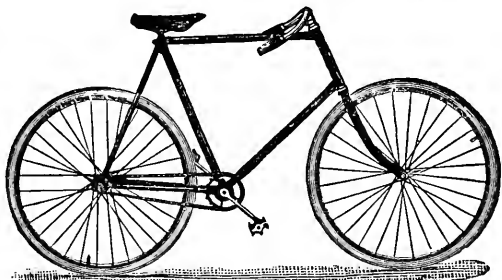

## The Best in the World

Send for Catalogue

**THE BLACK MFG. CO.**  
ERIE, PA.

Mention RECREATION.

## 1897 High Grade Bicycles

for Men, Women, Girls & Boys. Complete line at lowest prices ever quoted.  
\$100 'Oakwood' for \$45.00  
\$85 'Arlington' " \$37.50  
\$55 " " \$25.00  
\$20 Bicycle " \$10.75  
\$75 'Maywood' Simplest, Strongest Bicycle on Earth " \$32.00  
Fully guaranteed. Shipped anywhere C.O.D. with privilege to examine. No money in advance. Buy direct from manufacturers, save agents and dealers profits. Large illustrated catalogue free. Address (in full).  
Cash Buyers' Union. 162 W. Van Buren St. B 359 Chicago

## \$12 3000 BICYCLES

must be closed out at once.  
Standard '97 Models, guarant'd, \$14 to \$30. '98 models to \$20. 2d hand wheels \$5 to \$15. Shipped to anyone on approval without advance deposit. Great factory clearingsale  
**EARN A BICYCLE**  
by helping advertise us. We will give one agent in each town FREE USE of a sample wheel to introduce them. Write at once for our Special Offer. **D. R. MEAD & PRENTISS, Chicago, Ill.**

A married man (27), fond of all kinds of sport, and a fair shot, would like a position with some gentleman, as gamekeeper or shooting companion; or will take charge of a gentleman's place. Is not afraid of work, and can make himself generally useful. Can manage a farm, and is a good gardener. First class references, from Hon. W. C. Whitney and others. Address W. L. Hayes, Warrenton, Ia.



(Taken on a Carbutt Orthochromatic Plate.)

By ALOIS BEER, Photographer to Emperor of Austria

## To Obtain Artistic Results

as much care must be used in the selection of the Plates or films as the Camera.

### CARBUTT'S PLATES AND FILMS

(STANDARD FOR 20 YEARS)

Give Universal Satisfaction

Also J. C. DEVELOPING TABLOIDS, put up in 3 sizes, price 25c., 40c., 75c.

If you intend competing for prizes let us assist you in winning by the aid of our Plates, Films, and Developer. For sale by all dealers. Catalogue free.

JOHN CARBUTT, <sup>WAYNE</sup>JUNCTION Philadelphia, Pa.

# THE MARLBOROUGH CAMERA

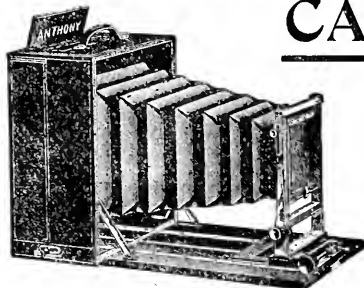

Reversible  
Swing  
Back,  
Rising and  
Swing  
Front

|                                                                                       |      |               |
|---------------------------------------------------------------------------------------|------|---------------|
| 5x7, fitted with the Rapid Rectilinear Lens, B. & L. Shutter, and two Double Holders, | \$60 | Send for Free |
| 8x10, without lens and shutter, . . . . .                                             | 50   | Illustrated   |
| 6½x8½, . . . . .                                                                      | 45   | Booklet       |
| 5x7 . . . . .                                                                         | 35   |               |

Send for Free Pamphlet of \$5 and \$8 Cameras

We recommend the New American Films for hand-camera work. Try Metacarboll, the most powerful developer known.

Catalogue of all kinds of Cameras and all requisites for photography mailed on application. Free

We recommend CLIMAX DRY PLATES They are quick to amateurs and reliable

The INTERNATIONAL ANNUAL, Vol. X. Full of valuable articles, and profusely illustrated by the best photographic workers in this country and abroad. Price, 75 cents; postage, 15 cents.

E. & H. T. ANTHONY & CO.  
591 Broadway, New York

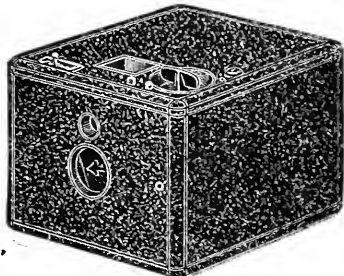

The Baby, \$6

Size, 2 1-2 x 3 1-2 x 4 in.  
Photo, 2 x 2 1-2 in. Weight, 7 oz.  
Loaded with 12 exposures

# Success in Photography

is only obtained by using an outfit well made, with high-grade lens, and reliable shutter.

## The Hawk-Eyes

manufactured in various styles and sizes from the "Baby" up, can be loaded and-unloaded in broad daylight, can be used with film or glass plates and warranted to prove just as represented.

## Why not make your Own Photographs?

A Guide-Book is furnished with each camera that will enable the novice to produce good results from the start

THE BLAIR CAMERA CO., Mfrs.  
22 Randolph St., Boston, Mass.

Send for Illustrated Catalogue which tells everything



## QUANTITY IS NOT QUALITY

This is More True Regarding  
Cameras than Any-  
thing Else



Some un-  
principled  
manufacturers will  
send you a picture taken out  
of the center of an exposure  
made with a \$25.00 Camera and  
claim it is made with the instrument they have for sale, but *OUR*  
*SAMPLES are actually made with*

## The "QUAD," Price \$5.00

*Other points to be considered are Weight and Length*

The "QUAD," loaded, weighs less than 1½ lbs. Others loaded, weigh from 5 to 10 lbs. The "QUAD" measures 6 inches in length. Others measure from 8 to 12 inches in length. The "QUAD" makes a picture 3½ x 3½ inches.

*No Slides to Draw! No Fumbling in a Coat Sleeve!  
No Opening the Box! It is all done from the Outside,  
consequently no chance to spoil plates.*

### NO EXTRA CHARGE FOR PLATEHOLDERS

The "QUAD" with Four Holders, \$5.00. Everything photographic can be done with the "QUAD." I manufacture and sell all kinds of Amateur supplies. Catalogue for the asking. Sample picture *actually* made with the "QUAD" for 5 cents in stamps. Send direct to

**EDWARD G. CONE, Manufacturer**  
804 Champlain Building, CHICAGO

California Camera Co., Pacific Coast Agents, 22 Geary St., San Francisco, Cal. E. & H. T. Anthony & Co., 591 Broadway, N.Y., Eastern Agents.

**To Exchange:** Model '95 Rambler Bicycle; 22 pounds; guarantee perfect condition; complete equipment included—for a Savage Rifle, Premo Sr. Camera, or a good typewriter. Orrin D. Bartlett, 25 Barrow St., N. Y. City.

**For Exchange:**—A fine 40-70-330 Ballard rifle, with complete set reloading tools, for Hand Camera. E. F. Pope, Colmesneil, Tex.

**An experienced cycle dealer** who is to spend the winter in Jamaica, W. I., would represent cycles and sundries for some American maker. Address, Arthur Munson, Stamford, Ct.

RECREATION is a welcome visitor at our house. We are more than pleased with the August number. Its pages are delightful. We expect to get up a club.

P. Carnahan, Carthage, Mo.

RECREATION gets better every month.  
A. Thomas, Jr., Brooklyn, N. Y.

## GASLIGHT

45c per 1000 feet

Anywhere—City or Country

Houses or other buildings can be lighted better and cheaper by use of our independent

## Naphey Acetylene Gas Generators

than by any other system of lighting in use. By actual comparison of Candle Power, its cost equals 45c per 1,000 feet of ordinary Gas (though a much smaller number of feet of Acetylene is used).

The U. S. Government has ordered these generators in every postoffice and sub-postoffice in Philadelphia.

**PERFECT SAFETY. PERFECT LIGHT.**

**J. B. COLT & CO.**

MANUFACTURERS OF

**STEREOPTICONS, Slides, Electric Lamps, Apparatus for Production and Projection of Light, etc.**

115-117 Nassau St., New York  
CHICAGO, ILL. SAN FRANCISCO, CAL.

Acetylene Gas Showrooms at New Zealand Building  
N.W. cor. Broadway and 37th St., New York.

## NOWADAYS.

Mommy uster say ter pop  
"Wish ter thunder somethin'd stop  
This infarnal fishin' fit  
That ev'ry spring you're sure to git."  
Thought it war a pesterin' craze—  
She goes with 'im nowadays.

Mommy used to say to pop.  
"Ding me, but I'd like to mop  
Them ar dogs an' shootin' gear  
Offen this ere hemisfere."  
Said it like she meant it strong—  
Nowadays she goes along.

Mommy used to say to pop  
"Land o' goodness! wish you'd stop  
Politics, for I can see  
It will sure your ruin be."  
Said it right along for years—  
Nowadays she 'lectioneers.

Nowadays it's just her whim  
For to be a pin' him,  
All the fads that poppy strikes,  
Clubs an' lectur' fiel's an' bikes.  
All the games that poppy plays—  
Mommy does 'em nowadays.

—Boston Courier Journal.

# The Baby Wizard Camera

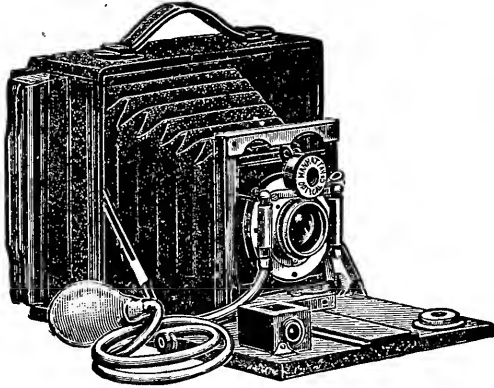

Only  $2\frac{3}{8} \times 5\frac{5}{8} \times 6\frac{3}{8}$  inches

*Is the  
Ideal Camera*

FOR TOURISTS, WHEELMEN  
OR SPORTSMEN GENERALLY

*Fitted with our Extra Rapid Rectilinear Lens (unequaled in this country), and the Bausch and Lomb Optical Company's Iris Diaphragm Shutter.*

Complete with Carrying Case

**\$25.00**

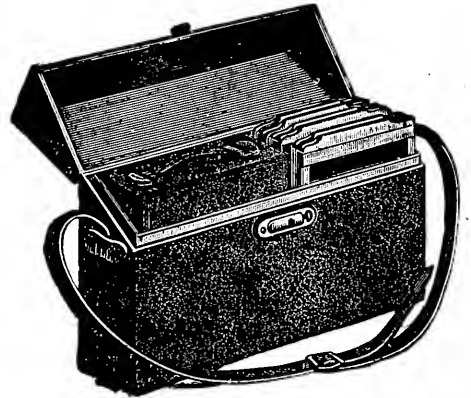

Same without rack and pinion, for focussing, and swing back

**\$20.00**

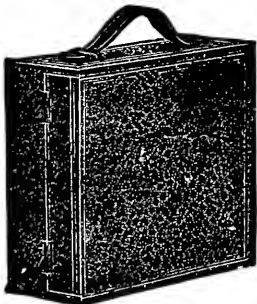



SEND FOR CATALOGUE

Manhattan Optical Co., Cresskill, N. J.

MILLEN'S  STANDARD  
Photographic Specialties



**THE NORMAL**  
PHOTOGRAPHIC  
DEVELOPER for Dry Plates,  
Films and Bromide Paper

 PRODUCES the most exquisite detail with good strength and printing qualities. Does not stain either the plate or the fingers, and may be used over and over.

 IS IN ONE solution, requiring only to be diluted with water to be ready for use.

 PRICE FORTY CENTS, delivered to any Express Office in the United States.

Send for full descriptive circulars of our  
Photographic Specialties

 J. C. MILLEN, M. D.   
Manufacturing Chemist  
PHILADELPHIA, PA., U. S. A.

On June 28th I met Geo. E. Howe and W. D. Merrill, of Boston, at Mike Marrs' camps, on Indian pond. We found the fishing fair, but not so good as usual, owing to the high water. We made 2 trips up the West outlet, catching 15 trout the first and 10 the last trip. The largest fish weighed 2 pounds. We also made a trip to Hog Eddy, where we caught 15 trout, the largest weighing 2½ pounds.

We saw 18 deer on this trip. One morning, as we were going down the pond, we saw a doe with her fawn. It was suggested that we see how close we could get. The boat was paddled within 30 feet before they saw us. It was the finest sight I ever saw.  
G. C. Jones, Carritunk, Me.

A new kind of trout food was found here the other day, by Mr. W. W. Babcock, of this place. While fishing in the East fork of the Clearwater river, in Deerlodge County, Mont., he caught 15 large trout. The 2 largest weighed about 2½ pounds each and were what might be called portly. Mr. B. thought he would see what they had found to eat, to fill themselves out so. On opening them he found in one a field mouse, and in the other a garter snake 20½ inches long. This is the first time I ever heard of a fish having eaten a snake.

I should like to hear, through RECREATION, if snake eating fish are common.

M. P. Dunham, Woodworth, Mont.

USE

*Snyder's*



**COCOA**

AN UNSURPASSED BREAKFAST DRINK.



UNEQUALLED FOR EATING, DRINKING & COOKING.



**PREMIUM CHOCOLATE**

FOR DRINKING, COOKING, CREAMS &c

*Snyder's* COCOA & CHOCOLATES.  
FOR PURITY OF MATERIAL  
FOR DELICIOUSNESS OF FLAVOR **UNSURPASSED.**  
**GROCERS EVERYWHERE.**

ANOTHER HIDDEN LETTER PUZZLE.

The letters of my name are 12  
The syllables are 3  
The words are 2 — 5 vowels and  
7 consonants you'll see.

The 1, 2, 3, 4, 5, and 8  
In *grains* are always found,  
The other letters of my name  
In *cattle* do abound.

My whole is made in "Yankee Land"  
And, therefore, without doubt,  
It's equal would be hard to find  
The whole wide world about.

No prize is offered for the solution of this puzzle, but it may interest you to work it out and find the ad. it refers to. A book which will interest dog fanciers, stock growers and farmers will be sent to such persons as send in solutions of this puzzle.

Every person who subscribes for RECREATION, or renews his subscription, this year, can get a copy of Mr. W. T. Hornaday's delightful book, "The Man Who Became a Savage," for 50 cents extra. The book sells in the stores at \$1.50; but you can get RECREATION one year and the book for \$1.50.

WHAT THEY SAY OF THE  
PREMIUMS.

I want to offer some testimony in favor of the Manhattan Optical Co. The "Baby Wizard" came promptly to hand, and is the handsomest instrument, among several of its class and size, in this town. It puts them all in the shade for compactness, portability, completeness, finish and execution. The lens and instruments are much better than we expected to get, for the money. I have subjected it to practical tests and it has come to the front in a very satisfactory manner indeed. It will surely lead to other sales here, for the camera boys are all infatuated with it and are making many inquiries.

H. S. Garfield, M.D., Pendleton, Ore.

The Ithaca hammerless gun you sent me, for 35 subscribers, received. Have given it a good test and am well satisfied with its shooting qualities. I chose the Ithaca on account of its having one feature that other hammerless guns do not have, and that is the 2 different actions of the safety slide, of which one is the independent notch, with just a pull of the thumb. I thank you, very much, for this valuable premium and wish success to RECREATION.

E. W. Francis, Stella, N. Y.

Please accept my thanks for your courtesy in the matter of the Yawman & Erbe automatic reel, which is all that could possibly be expected. I had, however, used the same make, several times before, and knew what I was getting. When once used it becomes indispensable, and no angler will be without it, after having given it a fair trial.

I am more than pleased with RECREATION, and shall, with great pleasure, do everything I can to advance its circulation.

R. F. Shaffner, Harrisburg, Pa.

I am delighted with the beautiful Ithaca hammerless gun you sent me, as a premium for 35 subscribers to RECREATION. I have tried it, at trap and in the field, and I never shot a better gun. All the boys are exceedingly pleased with RECREATION, and think it the neatest, the best and the cheapest magazine of its class they have ever seen. It is a pleasure to solicit for a book that all are pleased with.

W. A. Muriel, Traverse City, Mich.

The Marlin rifle given me for 20 subscribers has arrived and am very much pleased with it.

I thank you, many times, for this valuable present and wish you many years of prosperity and happiness. You will see a good many if you keep RECREATION at the standard it is to-day. It is the best sportsmen's journal published.

E. W. Tilton, Newburyport, Mass.

## WHAT THEY SAY OF RECREATION.

It is clear that the motive power behind RECREATION is imbued with all the instincts of a sportsman. The magazine you are now publishing is, without doubt, the most interesting and the best sportsmen's magazine ever published in this country, and I do not know but this statement could be applied to cover the old countries, as well. The articles in RECREATION are all interesting to sportsmen; are not published, as so many of the articles in the other magazines are, in the interest of railroad companies and parties furnishing free transportation to the editor; but are extremely interesting from a sportsman's standpoint. You are correct in devoting RECREATION to field sports exclusively.

I hope that with the general return of prosperity, in this country, you will have your share, and that the magazine will, in every way, be a great financial success.

Yours very truly.

W. H. Mullins, Salem, O.

We note by your new rate card you have made quite a jump in rates; but suppose this is in proportion to the increase of your circulation. We congratulate you on your success.

I applaud, with a brass band accompaniment, the stand you have taken against that element in sporting circles, appropriately dubbed by RECREATION as hogs. "Hogs" is good. Prefixed by say 3 or 4 strong and carefully selected Biblical adjectives, it will just about half express the contempt which most of us feel for these creatures.

J. H. Hegeman,

Ad. Mgr. Fenton Bicycle,

Jamestown, N. Y.

I read many papers that claim to give the sportsmen information in regard to sport; but not one comes up to RECREATION by half. RECREATION's information is true to the mark, and not over-written.

I have hunted, fished, and punched cows over the great Western game regions of Colo. and Wyo., for years, and can truthfully say RECREATION gives an honest and not overdrawn picture of the West, and of the sport to be found there. Am personally acquainted with a number of the guides whose names are given in RECREATION, and they are O. K.

James R. Gregory, Lamar, Mo.

RECREATION is the best thing going, and it continues to be better each month. The only trouble with it is it does not come often enough.

Frank G. Houghton, Leominster, Mass.

## S. HEMMENWAY &amp; SON

Make a specialty of  
High Class Yacht and  
Canoe Sails

SAIL  
MAKERS

Also Manufacturers of Tents and Flags

60 South Street, New York City

Send 5c. for our Tent and Flag Catalogue



## LYMAN'S RIFLE SIGHTS.

Send for 96 Page Catalogue of

Sights and Fine Shooting Rifles.

WILLIAM LYMAN, Middlefield, Conn.

FINE MOUNTED GAME HEADS,  
BIRDS, ETC., for sale at unheard-of prices.  
Send 10 cents for photos.  
JOHN CLAYTON, Taxidermist, Lincoln, Maine.



Jaeger



SANITARY UNDERWEAR

AS USED BY

Dr. Nansen

on his famous Arctic sledge journey.

"The result of all this experimenting was that I eventually made up my mind to keep to my woollen clothes, which would give free outlet to the perspiration. Johansen followed my example, and on the upper part of our bodies we each had two Jaeger Undershirts next the skin, etc., etc."

—Farthest North. Vol. II., p. 115.

This Applies to You.

Jaeger Underwear allows the skin to breathe freely, at the same time absorbing its exhalations and leaving the body dry and warm. Gives the greatest warmth with the least weight.

Send for Illustrated Catalogue

Main Retail Store

16 W. 23d St.  
NEW YORK

Branches { 166 Broadway  
              { 248 W. 125th St.

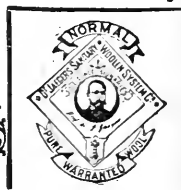

Chamberburg Pa - 9-17-97

Dear Sir:

For Heaven's sake take out my  
"ad" - asking a trade on my "Steamer Refit"  
I have had over three thousand answers -  
and only this morning received two - one from  
Canada - and one from Kansas City. No - not with  
standing that the ad has done its duty but  
these some good people their words do follow  
of this. If I ever want to buy, beg, borrow - steal  
or trade I shall surely put an "ad" in "Recreation"  
I made a good trade - got 6 Bassard - 45-70 for my Steamer  
this AM one wanted to trade Musket 50-95 - James S. Kennedy,

We get such letters as this every day.

The shrewd advertiser puts his money where it  
will do him the most good.



# THE Ingersoll Dollar Watch

$\frac{2}{3}$   
Actual  
Size.

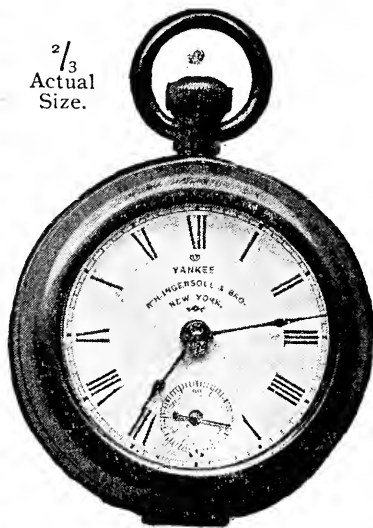

Good Enough for Anyone

Absolutely guaranteed for one year same as a Hundred Dollar Watch

Just the watch for rough use—Hunting, Camping, Fishing, Yachting, Bicycling, and for every use that a high-priced watch can be put to.

Years of hard knocks will not affect its accuracy.

Keyless wind, American patent lever movement, runs 30 hours to one winding.

Case of nickel or gilt, as preferred.

**\$1.00** each, postpaid

**ROBT. H. INGERSOLL & BROTHER**

"Watchmakers to the American People"

65 Cortlandt Street, Dept. No. 77, New York



**MONEY BACK IF NOT SATISFIED**



## Direct From Distiller

## To Consumer

Saving Middlemen's Profits,

Preventing Possibility of Adulteration.

We are distillers with a wide reputation of 30 years standing. Our whole enormous product is sold to consumers direct. We sell direct so that our whiskey may be pure when it reaches you. For medicinal purposes adulterated whiskey is dangerous. For sideboard purposes it is abominable, yet it is almost impossible to get pure whiskey from dealers. We have tens of thousands of customers who never buy elsewhere. A customer who once tries our whiskey is a customer always. We want more of them, and we make the following offer to get them:

We will send four full quart bottles of Hayner's Seven Year Old Double Copper Distilled Rye for \$3.20, Express Prepaid. We ship in plain packages—no marks to indicate contents (which will avoid possible comment). When you get it and test it, if it isn't satisfactory return it at our expense and we will return your \$3.20. Such whiskey can not be purchased elsewhere for less than \$5.00.

We are the only distillers selling to consumers direct. Others who claim to be are dealers, buying and selling. Our whiskey has our reputation behind it.

References—Dun or Bradstreet or any bank or business house in Dayton.

HAYNER DISTILLING CO., 267 to 273 W. 5th St., Dayton, O.

**\$3.20**  
**EXPRESS**  
**PAID.**

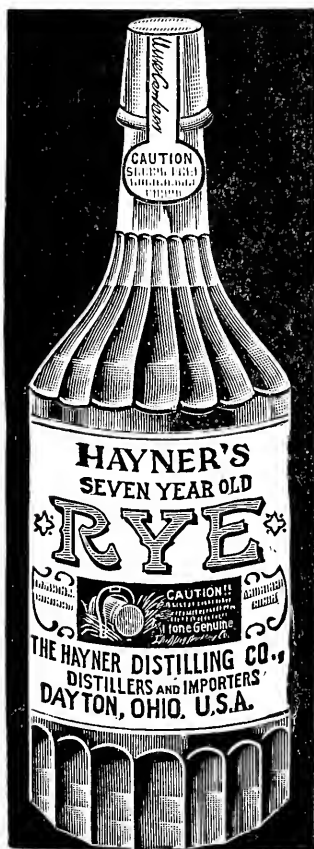

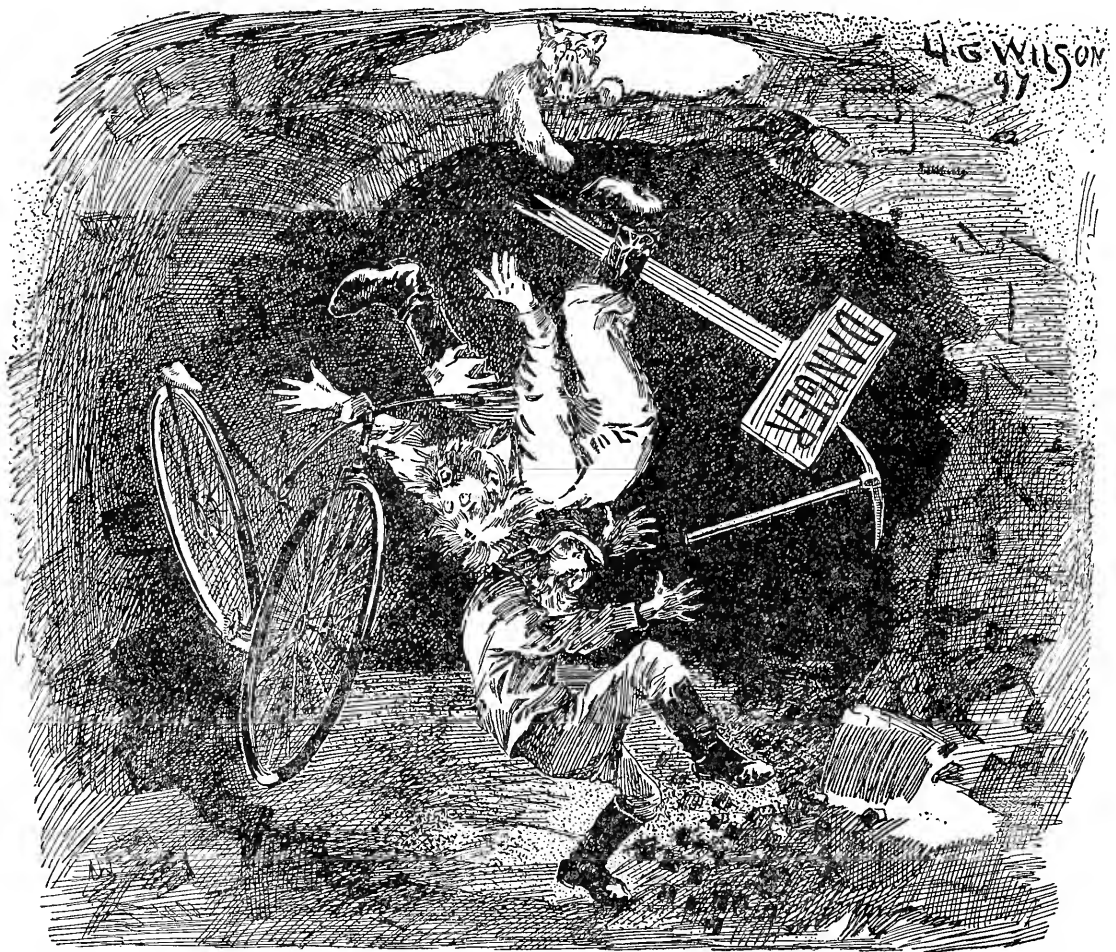

# St. Denis

BROADWAY & ELEVENTH  
STREET • NEW YORK  
OPPOSITE GRACE CHURCH



## European Plan

In a modest and unobtrusive way there are few better conducted hotels in the metropolis than the St. Denis. The great popularity it has acquired can readily be traced to its unique location, its homelike atmosphere, the peculiar excellence of its cuisine, and its very moderate prices.

**WILLIAM TAYLOR & SON**

## A Great Offer for the Holidays

BY **GERMANIA WINE CELLARS**  
Hammondsport and Rheims, N. Y.

We are determined to introduce our goods among the very best people in the country, and we can see no better way of doing this than by selling them a case of our goods, containing eleven bottles of wine and one bottle of our extra fine, double-distilled Grape Brandy, at one-half its actual cost. Upon receipt of \$5.00, we will send, to any reader of RECREATION, one case of our goods, all first class, and put up in elegant style, assorted, as follows:

- 1 Quart Bottle Grand Imperial Sec Champagne
- 1 Quart Bottle Delaware Riesling
- 1 " " Tokay
- 1 " " Sweet Catawba
- 1 " " Sherry
- 1 " " Elvira
- 1 " " Niagara
- 1 " " Angelica
- 1 " " Port
- 1 " " Sweet Isabella
- 1 " " Imperial Grape Brandy



This offer is made mainly to introduce our Grand Imperial Sec Champagne and our fine double-distilled Grape Brandy, without which no Sportsman or Hunter should start on an expedition, as it is very necessary where such exercise is taken. This case of goods is offered at about one-half its actual cost and it will please us if our friends and patrons will take advantage of this and help us introduce our goods.

All orders should be in before Dec. 15.



# THE GREAT WESTERN BRAND OF CHAMPAGNE

MADE  
BY  
THE  
Pleasant  
Valley  
Wine  
Co.

OF  
RHEIMS, N. Y.



IS  
THE FINEST  
PRODUCTION

IN AMERICA  
AND EQUAL TO ANY

THERE IS HEALTH IN EVERY DROP

FOR SALE BY ALL WINE MERCHANTS, AND  
H. B. KIRK & CO., New York S. S. PIERCE & CO., Boston



**KLONDYKE GOLD** is good, but

Dr. Jones's Dollar Health Exerciser is better because it brings Beauty, and Grace Woman, or Child

Health, Strength, to Man, Is a complete Gymnasium, weighs only 8 ounces, no wheels, no weights, develops every muscle in the body. Reduces obesity, strengthens weak lungs, fortifies the body against disease, brings firm muscles, steady nerves, erect form, good digestion, sound

sleep, and moulds the body into forms of beauty and strength. Sent postpaid, with full instructions, for \$1.00. Circular by request. JONES MFG. CO., 108 East 23d Street, New York.

## A Strong Stomach will Save Your Life

Therefore use **Bayle's Horseradish Mustard**. All sauces are valueless as tonics, and no other condiments compare with this. Ask for it. For sale everywhere. Geo. A. Bayle, St. Louis, Sole Maker.

**For Sale or Exchange.**—40-82-260 Winchester repeating rifle, model '86. Specially selected smooth action; 32 inch barrel, set trigger, Lyman sights, 100 rounds ammunition, 100 bullets, mills woven belt, canvas case. Inside of barrel in fair condition. First remittance of \$10.00 takes all; or will exchange for 32 or 44 calibre Russian model revolver, in good condition.

A. L. A. Himmelwright,  
P. O. Box 3064 New York City.

## The Brahan Patent Pen

One dipping writes a large page. Fine quality steel pen, with reservoir. Samples: 5 kinds, 10c. Agents wanted.

BOWEN & SON, Springfield, Mass.

"Faddler is a man who wants to be always on the go."

"That's a fact; the other day I overheard him trying to rent an elevator for an office."

"Why is that Western park called the 'Garden of the Gods'?"

"Well, it must be because the gods are too stuck-up to pull weeds."

RECREATION is the best of all sportsmen's magazines.  
Dr. A. W. Cassidy, Vigo, O.

I get RECREATION through the news-dealer, and can hardly wait for the months to come around. I wish you published every week.

I am a true lover of outdoor sports, but don't get much chance to go away. Camping, shooting, and fishing are my greatest pleasures.

There are lots of good things in RECREATION—the exchange column, amateur photography and natural history. In fact, it is all good, and I read every bit of it, advertisements and all.

Another thing (the best of them all), is your showing up these game hogs. It's a shame that a man (or hog) should do such things, and a stop should be put to it at once. F. C. Buell, New Haven, Conn.

"You sculptors never make equestrian statues of women."

"No; we never could find a woman-model who wouldn't squeal and spoil her pose when the horse stood on his hind legs."

"Don't say 'dead as a door-nail.'"

"Well, what shall I say?"

"Say 'dead as a '96 wheel.'"

I have received the 45-70 Marlin rifle, as a premium for club of subscribers to RECREATION. It is a handsome gun and a handsome premium, for my efforts. I thank you for your liberality.

RECREATION is valuable to the tenderfoot sportsman, as well as to the old stager, and my friends are all well pleased with it. I hope for its continued good work in behalf of all sportsmen.

A. C. Bigelow, Philadelphia, Pa.

You are putting up a good fight for the protection of game and fish.

G. C. W., Lansing, Mich.

## WHAT THEY SAY OF IT.

I just secured the current number of RECREATION this morning, and have done nothing but read it, the greater part of the day. It is the most interesting sportsmen's journal I ever saw. As I read some of the letters, from places where there is an abundance of game, it almost makes me want to pack my trunk and go; for there is little game around here. There is some fishing, but mostly bull heads and perch. However, I will be content, as long as I can get RECREATION to read, to let the other fellows do the work, and I will sit down and hear them tell about it.

G. D. Case, Trumansburg, N. M.

I would not be without RECREATION, for it fills a long-felt want. I shall show it to my friends, and with the full assurance that no lover of the rod and gun will be without it. I expect to draw on you, in the near future, for one of your valuable prizes. I take 3 other journals, of a like nature, but RECREATION is the peer of them all. May long life and posterity attend you. Teach the grand principles of true sportsmanship, as you are doing, and your success is assured.

Wm. B. Currier, San Francisco, Calif.

I am delighted with RECREATION. The most artistic, life-like illustrations of animal and bird life are contained therein, and the scholarly, highly entertaining descriptions of outdoor sports, the pictures of mountain and valley scenery, cannot be excelled. Send me RECREATION as long as you keep its moral and intellectual tone up to its present high standard.

Chas. A. Walker, Carlinville, Ill.

RECREATION becomes more enjoyable with each issue, and I can only regret it does not appear oftener. Some one suggests that you publish it semi-monthly, and charge \$2.50 a year for it. Can you not seriously consider this? I have not the slightest doubt that every one of your present subscribers would be only too glad to continue, at that rate.

Dr. C. P. Franklin, Philadelphia, Pa.

Meeting occasionally most of the 60 odd subscribers I obtained for you, I naturally ask "How do you like RECREATION?" The answers are always favorable, and most of them you would be pleased to hear, couched as they are in the kindest and most complimentary language.

John Boyd, Toronto, Ont.

I have been a reader of your best of sportsmen's magazines for some time, and must put in a good word for it, as everyone who reads it must. I have spent a number of years in the West, among the best of game, but before I left, 7 years ago, one could see it was doomed.

Chief Eng. Graham, Roslyn, L. I.

I have taken RECREATION only 3 months, but consider it the best magazine of its kind. The price is very low for such a high-grade publication. I am pleased to note the interest you take in protecting our game. It is, indeed, something that should be looked after.

Wm. J. Engh, Sharon Centre, N. Y.

I am already paid up to October, 1899, and intend subscribing until my boy begins to read. Then I shall turn RECREATION over to him, until he can, in turn, pass it over to his posterity, and so on until he turns up his toes and goes over the great divide.

Dr. Jas. S. Kennedy, Chambersburg, Pa.

I have been a sportsman all my life; but never before have I had the pleasure of perusing such a perfect encyclopædia of information, pertaining to that which is uppermost in the mind of every true sportsman, as is RECREATION.

H. W. Mallory, New Orleans, La.

I saw a copy of your July number, and was so well pleased with it that I soon got up a club in order to get "The American Book of the Dog," a book I have been wanting a long time. It is a most excellent work.

F. W. Latz, Minneapolis, Minn.

I have every number of RECREATION, from the first one issued, and shall have them bound. They will be a valuable addition to my library, and I wish to preserve them for my boys, who are inclined to be sportsmen.

M. K. Barnum, No. Platte, Neb.

The sample copy of RECREATION reached me in due time, and out of about 15 sample copies of different sporting papers I sent for I selected yours as decidedly the best, in my judgment. I inclose \$1, for which send me RECREATION one year.

W. E. Sullivan, Glencoe, Ky.

Allow me space in which to thank you, on behalf of all the genuine sportsmen in this section, for furnishing so attractive and valuable a journal as RECREATION. May your shadow ever be dense and your aim true.

Arthur Munson.

I am more and more pleased with each copy of RECREATION. I am glad it is possible for some real sportsman to produce such an excellent periodical at such a price. I shall recommend it at all times.

M. S. Miners, Brooklyn, N. Y.

I like your magazine very much. Too much cannot be said in praise of it. I always read it from cover to cover, as soon as it comes. I wish it came every week, instead of once a month.

F. W. Talpey, Somerville, Mass.

You deserve the immense success which crowns RECREATION, for it is the best prayer-book ever printed, for the man who has a true conception of nature's gifts to mankind.

Ferdinand Beck, Virginia City, Nev.

I have been a constant reader of RECREATION for the past 2 years. Your war against fish and game hogs makes me your sincere friend.

J. Cheever Goodwin, New York.

I trust your shadow may widen until it bring refreshment to the hunter "On Greenland's icy mountains, and India's coral strand."

W. H. Nelson, Forest Glen, Md.

I have read RECREATION 2 years, and it is the best magazine I have ever taken. Every sportsman should always take RECREATION.

E. E. Hiscox, La Crosse, Wis.

My husband is a subscriber to your valuable magazine, and I enjoy and await its coming as eagerly as he does.

Mrs. E. M. Burditt, No. Shrewsbury, Vt.

RECREATION is the best magazine printed, and is away ahead of those of twice the price.

F. J. Maynard, Jr., Flushing, L. I.

You are right in not publishing articles commending goods that are not advertised in RECREATION.

Victor Winfrey, Carbondale, Ill.

I think so much of RECREATION I do not wish to miss a single issue, and I praise it to all my friends.

Dr. Paul F. Munde, 20 W. 45th St., N. Y.

RECREATION is the finest magazine I ever had the pleasure of reading. I wish it came every week.

F. B. Kelly, Ausable, Mich.

RECREATION makes bad weather not only endurable but pleasant.

Banks Jones, North Westchester, Conn.

I enjoy reading your magazine more than any other I take.

John Hermson, Rockland, Mass.

Everyone who sees RECREATION speaks well of it.

H. W. Babcock, Silver Plume, Colo.

I could not keep house without RECREATION.

George W. Knapp, Tecumseh, Mich.

RECREATION is the best magazine printed.

J. M. Wolverson, Dundee, N. Y.

RECREATION is a peach. I cannot get along without it.

Harry G. Ward, Lansingburgh, N. Y.

## SANDFORD AND SANDFORD

**Merchant Tailors  
and Importers**

176 FIFTH AVENUE  
Bet. 22d and 23d Sts.

NEW YORK



Our importations  
from Europe, for  
Fall and Winter,  
have arrived, and  
are ready for in-  
spection.

## NEW ROUTE TO THE KLONDIKE

COLUMBIA NAVIGATION AND  
TRADING COMPANY

S. S. "City of Colum-  
bia" (1,900 tons) will  
depart from the Old Do-  
minion Line pier, 26 North  
River, Wednesday, De-  
cember 1, for *St. Michael*,  
connecting with company's  
river steamers for *Dawson  
City*.

Passengers desiring to  
meet the ship at San  
Francisco or Seattle will  
be provided with trans-  
portation by rail to either  
point.

The "City of Colum-  
bia" has been selected and  
purchased from the Old  
Dominion S. S. Co. by the  
Columbia Navigation and  
Trading Co., 69 Wall St.,  
on account of her sea-  
worthy qualities and adapt-  
ability to this service.

For diagram of ship,  
rates, list of prices of out-  
fits, passage tickets, circu-  
lars and further informa-  
tion apply to the agents

**RAYMOND & WHITCOMB**  
TOURS AND TICKETS

31 East 14th St., Cor. Union Sq. West, New York  
296 Washington St., Boston, Mass.  
1005 Chestnut St., Philadelphia, Pa.  
95 Adams St., Chicago, Ill.

## Captain Jack Crawford

Alaska Prospecting and Mining Corporation

CAPITAL STOCK - - \$250,000

Incorporated under New Jersey Laws.

Shares \$10 each. Full Paid. Non-assessable  
There are only 25,000 Shares

PAYABLE IN FULL AT TIME OF SUBSCRIPTION OR IN  
INSTALMENTS IF PREFERRED

Who has not heard of Captain Jack? An expert  
mining prospector and developer through all parts of  
the West and the Cariboo Placer Mines of British  
Columbia,—being one of the original discoverers of  
Gold in the Black Hills in 1876,—first bringing before  
the public the immense mineral wealth of New Mexico,  
and drawing capital to its development.

Loved and honored by Army men for his upright-  
ness and integrity, high in the regard and trust of the  
newspaper profession, he can count among his friends  
most of the prominent men in the country, beginning  
with President McKinley.

A master pioneer; experienced, vigorous, and  
shrewd, he will lead and direct under this Corporation  
an expedition of practical and expert miners in the  
new Alaskan Gold fields. Mother lode claims will be  
taken up for this Company, to be sold at enormous  
profits, often without expending much capital in their  
development.

Stockholders can rest assured that reports from the  
field of operation, over Captain Jack's signature, will  
be authentic and trustworthy.

Write for prospectus or call for further information  
at the offices of the Company,

**American Tract Society Building**  
150 Nassau Street, New York City

Captain JACK CRAWFORD, President and Gen'l Mgr.  
General HORATIO C. KING, Vice-President.

**There are no promoters' shares**  
**Every share issued will be paid for in cash**

# Where to Go for Good Shooting and Fishing



The Best Game Country  
in the Mississippi Valley to-  
day is along the line of the

## IRON MOUNTAIN ROUTE

### In Missouri, Arkansas, and Louisiana

**Small Game** is very abundant, and has been shot at very little. **Deer** and **Turkeys** are plentiful, and the fishing, for black bass and other game fishes, of the very best. **This Line** also reaches, direct from **St. Louis** or **Memphis**, by double daily through car service, the famous hunting and fishing grounds on the Gulf.

#### SPECIAL FEATURES OFFERED

**Reduced Rates to Sportsmen**    **Side Tracking Cars On or Near the Grounds**  
**Hunting Cars Fully Equipped**    **Carrying Free of Dogs, Guns, and Camp Equipment**

WRITE for copy of **Ideal Hunting and Fishing Pamphlet** (descriptive and illustrated) of best locations, and other information, to Company's Agents, or to

C. G. WARNER  
Vice-President

W. B. DODDRIDGE  
General Manager  
ST. LOUIS

H. C. TOWNSEND  
General Passenger and Ticket Agent

## Some Rare Opportunities

...YOU CAN GET...

- A \$75 Bicycle for 75 yearly subscriptions to *Recreation*.
- A \$35 Hammerless Breech-Loading Shot Gun for 35 yearly subscriptions.
- A \$40 Camera for 25 subscriptions.
- A \$20 Gold Watch for 20 subscriptions.
- A \$20 Repeating Rifle for 20 subscriptions.
- A Good Single Barrel Shot Gun for 15 subscriptions.
- A Single Shot Rifle, or
- A Bristol Steel Fishing Rod, or
- An Automatic Reel, or
- A Kenwood Sleeping Bag  
For 10 subscriptions.

### WHY DON'T YOU GET THEM?

Write for premium list and sample copies of RECREATION

**THIS IS THE  
EMPIRE STATE  
EXPRESS,**

About which all know, more or less;  
It runs from New York to Buffalo,  
Every day in the week, but Sunday, you know,  
At a speed so great,  
Through the Empire State,  
As to earn for its line  
The title sublime ---- of  
"AMERICA'S GREATEST RAILROAD."  
"The New York-Central leads the world"  
Leslie's Weekly.

COPYRIGHT, 1898, BY GEORGE H. DANIELS, GENERAL PASSENGER AGENT.

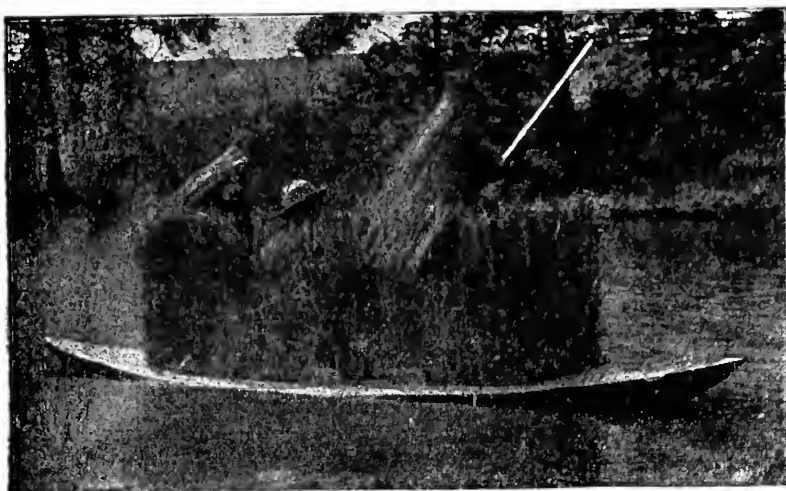

"Get There" Safety Ducking Boat, equipped with Grass Blinds

For your **Shooting** this **Fall**  
be sure and use one of

## Mullins' Metal Boats

The most complete hunting  
boat on the market.

Made in

GALVANIZED STEEL  
MANGANESE BRONZE  
ALUMINUM

Catalogue and full description on  
application.

**W. H. MULLINS**

228 Depot Street  
Salem, Ohio

## You Want a **Canvas Folding Boat** Or None

Any other kind is "A step backward." It's as practicable, subject to infinitely less strain per square inch, wears longer, and is easier mended than a pneumatic bicycle tire. It's the only kind in which **Compactness** or **Lightness** is possible; in short, it's the only kind worth considering. Ours are best. Perfect in construction. Equal in model to the finest wooden craft. Fifteen styles to select from.

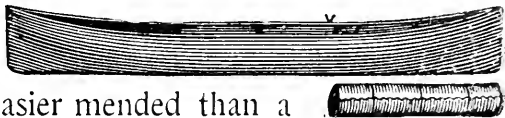

Send **NOW** for our catalogue, which, with a special offer we will make, may interest you

**ACME FOLDING BOAT CO., Miamisburg, Ohio**

ESTABLISHED 1875  
TELEPHONE 2591

**ELLWOOD E. HUEBNER**

15 John R Street  
DETROIT, MICH.

**FURS**

PRACTICAL  
FURRIER and  
DESIGNER

FASHIONS LATEST  
PRICES LOWEST  
PERSONAL ATTENTION  
TO ALL ORDERS  
WORK GUARANTEED

Write for prices

Mention RECREATION

A COMFORTABLE AND SAFE ROUTE TO THE  
KLONDIKE.

The S. S. Columbia, of the Columbia Navigation and Trading Company, will sail from New York, December 1, for St. Michael by way of Magellan straits reaching the former place about the middle of May. As soon as the Yukon river opens the passengers will be transferred to the river boats and conveyed to Dawson City, thus making the entire journey by water. Those who prefer, can take the steamer at San Francisco or Seattle.

The advantages of this method of reaching the Klondike, over all other routes, are manifest. The chief one, of course, is that the passenger is assured of reaching the Klondike within a reasonable time and at a definite cost, as the company guarantees, for a stated sum, to deliver the passenger at Dawson City. Those who go by steamer to Skaguay or Dyea, and thence over the dangerous mountain passes, have no way of ascertaining the cost beforehand, to say nothing of having any assurance of reaching their destination at all; as these routes are fraught with hardships and perils that might well make the most vigorous and hardy hesitate before undertaking them. Raymond and Whitcomb, who have offices in New York, Boston, Philadelphia and other principal cities, are general agents for this company, are now reserving accommodations and can give those interested full information regarding the Klondike.



**To Show  
Your  
Heels**

To other skaters wear the  
**Barney & Berry Skates.**  
**Highest Award World's Fair.**

Catalogue Free.  
**BARNEY & BERRY, Springfield, Mass.**

EVERY MONTH



**For Golfers  
By Golfers**

10 cents  
Copy

\$1 Year

150 NASSAU ST.  
NEW YORK

Send for a Sample Copy

**For Exchange:**—Gordon Setter, thoroughbred, 9 months old, for double barrel shot gun, breech loader, single shot rifle, or anything useful. Address H. H. Clark, East Angus, Que.

**For Exchange:**—Winchester model '73, 38 calibre repeater, and reloading tools; for a good second hand pneumatic bicycle. Gun is in good condition, almost as good as new. F. M. Barber, Hamlin Station, Washington Co., Pa.

**L. L. Bales**, General Delivery, Seattle, Wash., offers his services as guide for hunting, exploring, and prospecting parties in Alaska. He has lived in that Territory 8 years, has travelled many thousands of miles through the interior, and is prepared to give accurate and reliable information concerning it.

References: Lieut. G. T. Emmons, U. S. Navy, Naval Dept., Washington, D. C.; Will D. Jenkins, Secretary of State, Olympia, Wash., and the editor of RECREATION.

Correspondence promptly answered.  
Will return to Alaska in March, '98.

**For Sale or Exchange:**—A No. 1 single action, 7 shot revolver; 22 calibre, blue finish. *Very rare*—not made now. The most accurate 22 calibre ever made. In perfect condition. Cost \$13.50; sell for \$10; or exchange for 22 calibre repeating rifle, or for good plate camera. Other exchanges considered. Orrin D. Bartlett, 25 Barrow St., N. Y. City.

**For Sale:**—Worst pair of bloodhounds in Georgia. Eat you up in a minute. Price \$50. Also puppies. When you write enclose 10 cents stamps for genuine war relics. E. T. Luckie, Cross Keys, Ga.

**Wanted:**—One "American Ornithology." Cash, or sportsmen's books in exchange. Thos. A. Harrison, Burnet, Tex.

**For Sale:**—One Winchester repeating rifle, 38-55, model 1894, with reloading tools and 90 shells. Only about 200 shots fired from it. Will sell cheap. F. G. Kline, Bolivar, O.

**For Sale:**—Acme Folding Portable canvas boat, 11 feet long, used once. Harry Terhune, Middletown, N. Y.

**For Sale:**—English Setter Puppies, by Joe 24,190, ex Midge 45,225. Address Lock Box 52, Newark, Wayne Co., N. Y.

**For Sale:**—A grand moose head at \$60. Ernest L. Brown, Warren, Minn.

## Pheasants, Call Ducks, Etc.

**Prices Reduced.** Golden, Silver, Reeves, Versicolor, Lady Amherst, Swinhoe, Peacock, and Ringneck Pheasants; also White Call, Mandarin and Wood Ducks for sale.

**JAMES MORRISON**

Mr. Schieffelin's Place, Tarrytown, N. Y.

**Adirondack Lands**

**FOR SALE** in Various Parts of that Region; Suitable for Grand Parks, Game Preserves, Cottage Sites. Forest Land Co., Syracuse, N. Y.

**LITTLE GIANT TYPEWRITER** Price \$100  
 INTERCHANGEABLE TYPE PLATES. WILL WRITE IN BOOK, ON PAPER, PACKAGE, ANYTHING. ADJUSTABLE FEED. Send for Circular  
 WILL WRITE ON THE SIDE OF A HOUSE. FOR SALE IN STATIONARY AND DEPARTMENT STORES. Sent by mail or express on receipt of \$1.15  
 Simplex Typewriter Co. 26 East 13<sup>th</sup> St. New York

**ASHLAND HOUSE**

FOURTH AVE. and 24th ST.  
 Two blocks from Madison Sq. Garden

...HEADQUARTERS FOR SPORTSMEN

American and European Plan

**RATES:**

|                       |                           |          |
|-----------------------|---------------------------|----------|
| Rooms, with board,    | \$2.00, \$2.50 and \$3.00 | per day  |
| Rooms, without board, | \$1.00 and upwards        |          |
| Breakfast,            |                           | 75 cents |
| Lunch,                |                           | 50 "     |
| Table d' Hote Dinner, |                           | 75 "     |

**ROCKY MOUNTAIN DIAMOND**



1-karat size, set in a substantial scarf-pin or stick-pin or shirt-stud, by mail, postpaid, 25 cents; ring, 50 cents (give size), "The nearest approach to the real Diamond ever sold." That's our opinion; if it's not yours, "your money back."

This remarkable offer is made so that we may know you and be able to send our catalogue of Indian Relics, and other wonderful Curios, the products of the Rocky Mountain region. Address

H. H. TAMMEN CURIO CO., Denver, Colo.

**KAREZZA ETHICS OF MARRIAGE.**

A bold, brave book teaching ideal marriage, rights of the unborn child, a designed and controlled maternity. Union Signal: Thousands of women have blessed Dr. Stockham for Tokology, thousands of men and women will bless her for Karezza.

Arena: Karezza is worth its weight in gold. Sample pages free. Agents Wanted. Prepaid \$1.00. ALICE B. STOCKHAM & CO., 277 MADISON ST., CHICAGO.

**TRY IT FREE**

High Arm  
 for 30 days in your own home and save \$10 to \$25. No money in advance. \$60 Kenwood Machine for \$23.00 \$60 Arlington Machine for \$19.50 Singers (Made by us) \$8, \$11.50, \$15 and 27 other styles. All attachments FREE. We pay freight. Buy from factory. Save agents large profits. Over 100,000 in use. Catalogue and testimonials free. Write at once. Address (in full). CASH BUYERS' UNION 158-164 West Van Buren St., B359 Chicago, Ill.

**MAGIC LANTERNS**

and STEREOPTICONS, all prices. VIEWS illustrating every subject. For Public Exhibitions, Church Entertainments, and Illustrated Sermons. A Profitable Business for a man with a small capital. 250 page catalogue mailed Free. Headquarters for Animated Picture Machines. Send for descriptive CIRCULARS and latest FILMS. McALLISTER, Mfg. Optician, 49 Nassau St., N. Y.

**ASTHMA KILL IT WITH NAP**

The Antidote. Cures absolutely. Not for quick relief, but drives out the disease. Specific for Asthma and guaranteed to cure. Discoverer suffered 16 years. Send for circulars. NAP ASTHMA CO., 34 Park Row, New York.

For Sale: Living wild animals and game, for scientific and propagating purposes. Elk, deer, jack rabbits, quail, etc. Chas. Payne, Wichita, Kan.

**Do You Hunt? Do You Fish?**

Do you go into the woods or mountains, for any purpose?

If so, you need a COMPASS

GALL & LEMBKE 21 Union Square New York

put them up in watch cases, carefully fitted and adjusted, and a man who carries one of them need never have any doubt as to where North is.

Ten per cent. discount to all readers of RECREATION. Mention this magazine when you call, or write.

**Dixon's Graphitoleo**

Lubricates not only the chain and sprockets, but also the pins in the links of the chain, which stick Graphite cannot do and is not intended to do. For gun locks, for copying presses, and for office chairs it is unequaled. If your dealer does not keep it, mention RECREATION, and send 15 cents for sample.

JOS. DIXON CRUCIBLE CO., Jersey City, N. J.

WANTED.—LIVE ELK, MOOSE, CARIBOU, BLACK-tail deer, wild turkey, European roebucks, fallow deer, etc., for Litchfield Park, Adirondacks. Address, with particulars, EDWARD H. LITCHFIELD, 59 Wall Street, New York.

**Blair's Pills**  
 Great English Remedy for GOUT and RHEUMATISM.  
 SAFE, SURE, EFFECTIVE.  
 Druggists, or 224 William St., New York.

IN ANSWERING ADS, IF YOU WILL KINDLY MENTION RECREATION YOU WILL GREATLY OBLIGE THE EDITOR

THE BEST  
 OF ALL  
 AMMUNITION

Try .22 Peters' Short Smokeless  
 and New Victor Shells,  
 Loaded with King's Smokeless

FOR ACCURACY, VELOCITY, STRENGTH,  
 PENETRATION AND CLEANLINESS.



INSIST ON YOUR  
 DEALER  
 SUPPLYING YOU

THE  
 PETERS  
 CARTRIDGE  
 CO.

CINCINNATI, O.

FOR SALE EVERYWHERE

J. B. CROOK & CO. *Established 1837*

1180 Broadway, Cor. 28th Street

Manufacturers and Importers of NEW YORK CITY, U. S. A.

HIGHEST GRADE **FISHING TACKLE** HIGHEST GRADE

SPECIALTIES FOR 1897

Featherweight Rods, Aluminum Reels  
 Trout and Salmon Flies

The only Waterproof Fly Lines: The London Black  
 or Trout, Salmon, and Black Bass.  
 Send 7 cents for catalogue. Mention RECREATION.

A Practical Common Sense Camp Stove.

In 6 Sizes. Patent applied for.

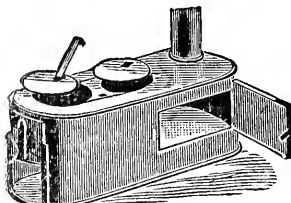

The lightest, most compact, practical camp stove made; either with or without oven. Won't get out of shape, combination cast and sheet steel top, smooth body, heavy lining, telescopic pipe carried inside the stove.

Burns largest wood, keeps fire longest of any stove made. For full particulars address

D. W. CREE, Manufacturer, Griggsville, Ill.

Taxidermists' Supplies

When you get a good specimen of bird, fish, mammal etc., that you would like to get mounted, send it to us. We will do it right and also make the price right.

Send five cents for new 'Taxidermists' Catalogue.

Artificial Glass Eyes

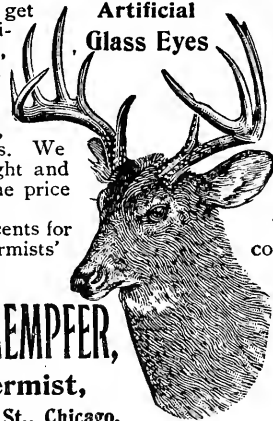

We prepare and mount all specimens of natural history true to nature, in the best style of the Taxidermist's art, at reasonable prices.

We also keep a complete line of

Oologists' and Entomologists' Supplies

FRED. KAEMPFER,

Taxidermist,

217 Madison St., Chicago.

FOSTER & CO.

Dealers in

Natural History Specimens

Animal Heads and Horns, Bird Skins and Eggs, Dead Game Panels, Indian Relics and Photos, Modern Indian Goods of Utility, Minerals, Fossils and Shells, Bicycles and Sundries, Natural History Supplies and Publications, Sporting Goods, Curios, etc. High-Class Taxidermy, Group Work.

ANN ARBOR, MICH.



Ernest L. Brown  
 The Minnesota Taxidermist

Does true and artistic work at reasonable figures.

WARREN, MINN.

Moosehide Moccasins Slippers

METZ & SCHLOERB, Oshkosh, Wis.

PRICE: MEN'S - - - - \$2.75  
 LADIES' AND BOYS' 2.25

Sent, prepaid, on receipt of price.

Write for our illustrated circular and price-list of hand made hunting shoes and moccasins of every description.

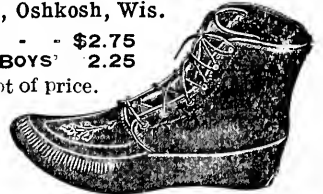

Wyoming...

For Antelope, Bear, Cougar, Deer, Elk, Fish, Goat, Moose, Sheep, Grouse, Duck, and Sage Chicken Shooting,

ADDRESS H. D. DEKALB, BIG PINEY, WYO.





# THIS FRIENDLY FACE

is PLEASED to ANNOUNCE to  
**ALL SHOOTERS**  
 of RIFLES, PISTOLS or SHOT GUNS  
 that the **Ideal Hand-Book No. 9** is just out. 116 pages of solid information about *Nitro*, *Smokeless* and *Black Powders*, how to use them in various arms to get the best results. It is the recognized authority on all matters relating to *Shooting*. You can't afford to be without it. Mailed to any part of the world. Your address with two 2 cent stamps to **IDEAL MANUFACTURING CO., New Haven, Conn., U.S.A.**  
 WHEN YOU WRITE KINDLY MENTION "RECREATION"

Sectional View

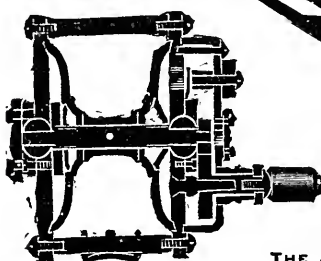

Globe Bearing.

## HENDRYX

Don't believe imitators of "**HENDRYX**" standard goods when they say their Fishing Reels "are **NOW** as good as **HENDRYX**". The fact that they imitate proves the "**HENDRYX**" is the recognized standard line of Fishing Reels. Ask your dealer for them.

THE ANDREW B. HENDRYX CO., NEW HAVEN, CONN., U. S. A.



This is a picture of Sewell Newhouse, inventor of the celebrated

### NEWHOUSE STEEL TRAPS

known the world over as the best traps made for catching furbearing animals. Send to

**ONEIDA COMMUNITY, Ltd., Kenwood, N. Y.**

for catalogs, prices and discounts.

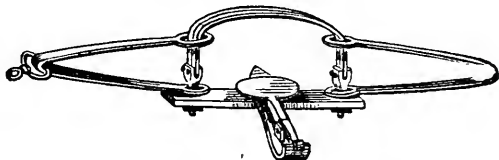

## RUPTURE ABSOLUTELY CURED . . . . .

without truss, operation or confinement, on strictly scientific professional principles, based on an experience of many years.

My method of treatment is known only to myself, and I object to long letters explanatory thereof. An interview is positively necessary for those requiring information.

Complete cure effected in 6 to 8 weeks; one treatment each week, with no detention whatever from business.

## SAGREDO

Care F. C. PRESTON, 98 Hudson Street, New York

**Exchange:** Kodak, 4 x 5, cost \$50.00, used some, and slightly marked, but in perfect condition, to exchange for 12 or 16 shot gun. Prefer Hollenbeck or Ithaca hammerless, or will exchange for perfect mounted game head, of equal value.

Dr. Wm. A. Hastings, Oswego, N. Y.,

I have a .44 calibre English revolver, English Government stamp on barrel, double action, nickel plated, which I would like to exchange for 12 gauge shot gun.

A. Wilson, Baltimore, Md.

**For Exchange:** An elegant deer head—mounted—for pair of fox hounds, or pups.  
 O. B. VanDusen, Phillips, Wis.

## WHAT THEY SAY OF THE PREMIUMS.

The "American Book of the Dog" you sent me as a premium for 7 subscriptions came duly, and I am much pleased with it. It is a handy reference book as to all kinds of dogs. I frequently have to decide questions in my business pertaining to them, and to treatment and kennel management, and it is very useful to me and to my customers. All the subscribers I sent you are more than pleased with RECREATION. The illustrations alone are worth the price, while the reading matter is interesting and suits all classes of sportsmen. That is why it was so easy to get subscriptions. I shall always take pleasure in recommending the best magazine published.

F. W. Latz, Minneapolis, Minn.

The Hollenbeck hammerless gun you sent me for 35 subscriptions to RECREATION was duly received, and I delayed writing you until I had given it a thorough trial. Yesterday was the day for the Knoxville Gun Club's weekly shoot. The boys all said my score beat any that was ever made on their grounds, by a man who had never before faced a trap. After the shoot my gun was targeted with the acknowledged best gun in our city. My little Hollenbeck beat it badly, both in pattern and penetration. I would not exchange it for any gun I ever saw, regardless of make, grade or price.

J. A. Bown, Knoxville, Ia.

You have done much better by me than I expected, and I thank you very much. The little Syracuse gun you sent me is a beauty, and shoots as good as it looks. The strongest points of the Syracuse (it has no weak ones) are its simple mechanism, perfect shape, good shooting and low price, quality considered. No sportsman need hesitate to invest in a Syracuse gun. And no lover of field sports can afford to be without RECREATION. Brother sportsmen try your luck at raising a club for RECREATION. You will be surprised to find how easy it is, and how well it pays.

John C. Briggs, Nevada, Ia.

I received the Marlin repeating rifle you sent me as a premium for 21 subscriptions to RECREATION, and I am well pleased with it. I fitted a combination rear and ivory bead front sight to it and took it out to try it. I got four consecutive shots in a 1 1/4 inch circle, at 75 yards, without cleaning between shots—U. M. C. ammunition—and am satisfied I can do better with it, after a little practice. The sights I used are similar to the Lyman, except that the rear is so constructed as not to interfere with the long firing bolt of the '95 model, and the front has a smaller bead.

D. C. Avery, Dunmore, Pa.

I have received the Davenport shot-gun sent me as a premium for 15 subscribers, and thank you for your promptness. Have delayed acknowledgment of the gun in order to give it a thorough test before writing you, and find that it far exceeds my expectations, being a powerful shooter. I have seen a number of the subscribers and they are well pleased with RECREATION.

Howard W. Gardiner, Nayatt, R. I.

I have just received the splendid gun sent as a premium for obtaining subscribers for RECREATION, and I am greatly pleased with it. All my subscribers have the kindest feelings for you and your magazine, and wish you success in your efforts to make it the best book of the kind on earth, and in your endeavors to unite all true sportsmen against the wanton killing of game.

George Hall, Tomahawk, Wis.

I received the 30-40 Winchester as my premium for RECREATION subscribers, and am well pleased with it. It is just the gun for this country. All of the boys to whom I had RECREATION sent are as much pleased with it as I am with the gun. They all say "I do wish the next number was out." I am going to get up another club and get a Kenwood Sleeping Bag.

C. L. Sporley, Negaunee, Mich.

I have pleasure in acknowledging receipt of the Hollenbeck gun you sent me for 35 subscriptions, and am very much pleased with same. I have shown it to a number of our sportsmen here and they all like the mechanism and finish of the gun. It is a little beauty; just the thing for brush shooting, and as good a pair of barrels as a man wants to look through.

J. Piegenschuh, Massillon, O.

The Bopeep A camera, made by the Manhattan Optical Co., which you sent me for my club of 12 subscribers, came to-day, and I am highly pleased with it. Have shown it to several of my friends, and they all praise it highly. I shall continue to recommend RECREATION to everyone. It surely is better every month.

Fred. L. Lee, Binghamton, N. Y.

I received the Syracuse gun yesterday, and thank you for your kindness in hurrying it forward; also for the opportunity of obtaining so fine an arm at so small an expense. I am pleased to have been able to add my mite to the circulation of RECREATION, and shall continue to do what I can to help it along.

H. D. Stebbins, Boston, Mass.

I thank you and the Marlin Fire Arms Co. for promptness in sending the rifle for the 20 subscriptions to RECREATION. It shoots where it is held, and is all anyone can wish. I killed ground squirrels with it at over 100 yards. Everyone should have a Marlin, and everyone should read RECREATION.

C. W. Bishop, Missoula, Mont.

The camera sent me as a premium, was received in perfect condition, and, on trial, I find it is everything a good camera should be. I am greatly obliged for your kindness, and you can rest assured I shall never let an opportunity pass to put in a good word for RECREATION.

W. H. Black, Harrisburg, Pa.

I thank you for the 30-30 rifle sent me for 25 subscriptions to RECREATION. I would have done so before, but was waiting to give it a trial, and it proves entirely satisfactory in every respect, both at long and short range. It is the hardest shooting rifle I ever used, and will be just the thing for big game.

L. W. Hodgins, Lynn, Mass.

I received the Marlin rifle all right, and cannot express my thanks in words. It fully meets my expectations. I have tested it and do not hesitate to pronounce it an up-to-date rifle in every respect.

Morris Berman, Port Henry, N. Y.

The Hollenbeck gun you so generously sent me, for a club of 35 subscribers, came to hand promptly, and is just as ordered. I would not ask for a better shooting gun. It makes a fine pattern at 40 to 50 yards. Long live RECREATION and its editor.

F. J. Taylor, Malone, N. Y.

The Bopeep A camera, made by the Manhattan Optical Co., and which you sent me for a club of 12 subscribers, has been received, and I am more than pleased with it. I shall continue to work for RECREATION, and wish you unbounded success.

Charles S. Glascoe, Pueblo, Colo.

I received the Willis camera you sent me as a premium, and find it a perfect little instrument. It works well in every way, and I thank you for your trouble. Will do all I can in getting you more subscribers.

Harry Saynor, Pine Lake, Ind.

I have just received the 35-56 Merlin rifle for 21 subscriptions to RECREATION, and am delighted with it. I don't see how you can give such fine prizes, for RECREATION is worth the money alone.

G. Roeluker, Galesburg, Ill.

I received the Marlin revolver you sent me as a premium, and I am well pleased with it. It is as good as any made in the world. Will send more subscribers soon.

L. M. Gridley, Corning, N. Y.

Have received the Marlin repeating rifle sent me for 20 subscriptions. It shoots excellently. It is well worth the time and labor I spent in securing the subscriptions.

Don M. Harris, Zanesville, O.

Accept my thanks for the Davenport rifle sent me for 10 subscribers to RECREATION. Am well pleased with it. Have tried it and find it a good shooter.

George Crow, Gas City, Ind.

I have received the Yawman & Erbe automatic reel you sent me as a premium for 10 subscribers to RECREATION, and it is a dandy.

Wm. A. Korter, Port Townsend, Wash.

WHAT THE PULLMAN CAR IS  
TO THE RAILWAY TRAVELER  
THE NEW ZEALAND MOSQUITO  
TENT IS TO THE CAMPER

# New Zealand Mosquito Tent

"Fresh, pure air, and plenty of it, is the surest and most natural remedy for more than half the ills man is heir to."

## OUR SPECIAL AFFAIR

is to make TENT LIFE a luxury instead of the misery it has too often proved on trial.

Twenty-six years "roughing it," in all kinds of weather, from 110 degrees of heat to six feet of snow, is the experience from which the New Zealand Mosquito Tent has been evolved.

It is, in point of comfort, as far ahead of old-style tents as the Pullman car is ahead of the western "Prairie Schooner," or as the modern "Atlantic Greyhound" is ahead of the old-time "Columbian" sloop, or the "Mayflower."

*Dr. L. T. Foss, of 132 Court Street, Boston, Mass., who bought the first tent sold in the States, last March, writes, October 4th, "We used your tent several weeks in the Maine woods. Not a 'skeeter' or midge could penetrate it. Not only that, for five days it poured in torrents, but the tent withstood the continuous deluge admirably. It is absolutely perfection."*

We are now getting out a special tent for arctic use, "**The Klondike**"—a tent within a tent. The inner or sleeping part is warmer than a frame house or log cabin. With a "Primus" stove, weighing two pounds, and using a quart of oil a night, the temperature may be kept at from 60 to 120 degrees. All cooking may be done with the same stove. Price, outer tent 12x10 with inner chamber 7½x7½, weight twenty-five pounds, \$25. Both tents also insect proof, and convertible into Summer tents at will.

INSECT  
REPTILE  
AND  
VERMIN  
PROOF



AIRY  
COSY  
LIGHT  
BRIGHT  
WATERPROOF  
DURABLE  
VENTILATION  
PERFECT  
EASILY  
SET  
UP



PATENT  
APPLIED FOR

'97



ASK FOR CIRCULAR  
MENTION RECREATION

T. W. HICKSON  
23 William Street, New York City

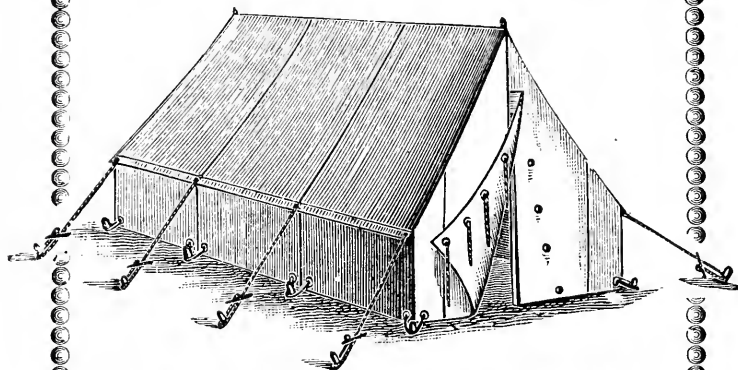

Every  
Sportsman  
Should  
Have a

# WATER-PROOF TENT

A camper knows the advantages of a tent that is an absolute protection against rain and dampness. We secure this advantage by **OUR** water-proof **PROCESS** and avoid the extra bulk and weight of a fly.

We make tents of all sizes, shapes and materials, suited to the needs of hunters, campers, travellers, canoeists; also

## Water-Proof Sleeping Bags

**CANVAS BUCKETS, AMMUNITION, PROVISION,  
CLOTHING AND SADDLE BAGS, POUCHES,  
PACKS, BICYCLE COVERS, FLOOR CLOTHS,  
and many other Canvas Specialties**

**Our Sleeping Bag** is unique, excellent in pattern and finish, and has been highly approved.

SEND FOR CIRCULAR R, SAMPLES OF MATERIALS AND PRICE-LIST TO

# DERBY, ABERCROMBIE & CO.

36 South Street, New York

# KENWOOD SLEEPING-BAGS

are right for every possible condition  
of climate or weather found from

## Alaska to Mexico

Members of the Peary expedition have them. Professor Libbey, of Princeton College, used one while exploring in Mexico. Many members of the noted Mazamas

Society of mountain-climbers used them in their ascent of Mount Rainier. Hundreds of **Klondike gold-seekers** have already purchased the **Kenwood Sleeping-Bag**, and sportsmen everywhere know them well.



Consists of outside water-proof, wind-proof canvas cover, a thick, warm, seamless, woolen bag, and a soft, fine, seamless, woolen inner bag. Used separately or together.

**Price, \$6.00 to \$16.00.**

Lighter, warmer, more durable, and more convenient than any other form of covering.

**The Kenwood Storm-hood** used with the bags or without them, will be found a great comfort and a perfect protection against cold and wind.

**The Kenwood Hunting-cape** is particularly suitable for this season. It is an ideal garment for the sportsman. Unusual warmth with lightness and perfect freedom of motion.

*Every Camper, Hunter, Angler, Prospector, or Military Man should send for our samples and FREE illustrated circular about these articles.*

**THE KENWOOD MILLS, - - Albany, N. Y.**

(N. Y., 3316. Ed. 5—25,000.)

# MEMORANDUM OF WEIGHT.

DATE OF MAILING.

| DAY.   | A. M. | P. M. |
|--------|-------|-------|
| May 25 |       |       |
| to     |       |       |
| June 2 |       |       |

New York Post Office,  
6-2-1897

Received from

*Recreation*

IN WEIGHT, AS FOLLOWS:

|                          | TARE. | GROSS WEIGHT. |
|--------------------------|-------|---------------|
| 185 No. 1 Sack, 3 lbs.   |       | 16718         |
| No. 2 Sack, 2 lbs. 5 oz. |       | 555           |
| Net Weight,              |       | 16163         |
|                          |       | .01           |
| Rate per pound,          |       |               |
| Amount of postage,       |       | \$161.63      |

Per *C. A. L.* Postmaster.  
Receiving Clerk.

2-1-96

Post-office receipt for June number of RECREATION. The postmaster does not stuff the returns for any publisher.

This is for subscriptions only. The News Co.'s trade of 12,000 a month is not included. Total circulation, 44,000 a month.

Receipts for each of the months of July, August, September, October, and November will be shown on application.

If interested call for them.

Address RECREATION, 19 West 24th Street, New York

(38)

**ORDER FROM THE PERIODICAL DEPT. OF THE AMERICAN NEWS COMPANY,**

TO M. Recreation  
NEW YORK, Aug 11, 1897 City

ANSWER BY RETURN ON ALL GOODS YOU CANNOT FURNISH AT ONCE.

SEND GOODS TO THE \_\_\_\_\_ NEWS COMPANY FOR ENCLOSURE. BILLS AND ANSWER TO US

*Please make order for Recreation - 11000*

(38)

**ORDER FROM THE PERIODICAL DEPT. OF THE AMERICAN NEWS COMPANY,**

TO M. G. O. Shields  
NEW YORK, Sept 10, 1897 City

ANSWER BY RETURN ON ALL GOODS YOU CANNOT FURNISH AT ONCE.

SEND GOODS TO THE \_\_\_\_\_ NEWS COMPANY FOR ENCLOSURE. BILLS AND ANSWER TO US.

*Please make order for Recreation - 11600*

Here are two standing orders from the American News Co. One is dated August 11, and the other Sept. 10. Only a few months ago their order stood at 9,000 copies a month. By May 1st it will reach 15,000. Straws show which way the wind blows.

The shrewd advertiser puts his money where it will do him the most good.



A  
 LITTLE  
 REFLECTION  
 ON THE  
 MERITS OF

# The Monarch

WILL CONVINCe ANY CYCLIST THAT  
 IT IS THE KING OF BICYCLES.

SEND FOR CATALOGUE

MONARCH CYCLE  
 MANUFACTURING CO.  
 CHICAGO - NEW YORK  
 LONDON





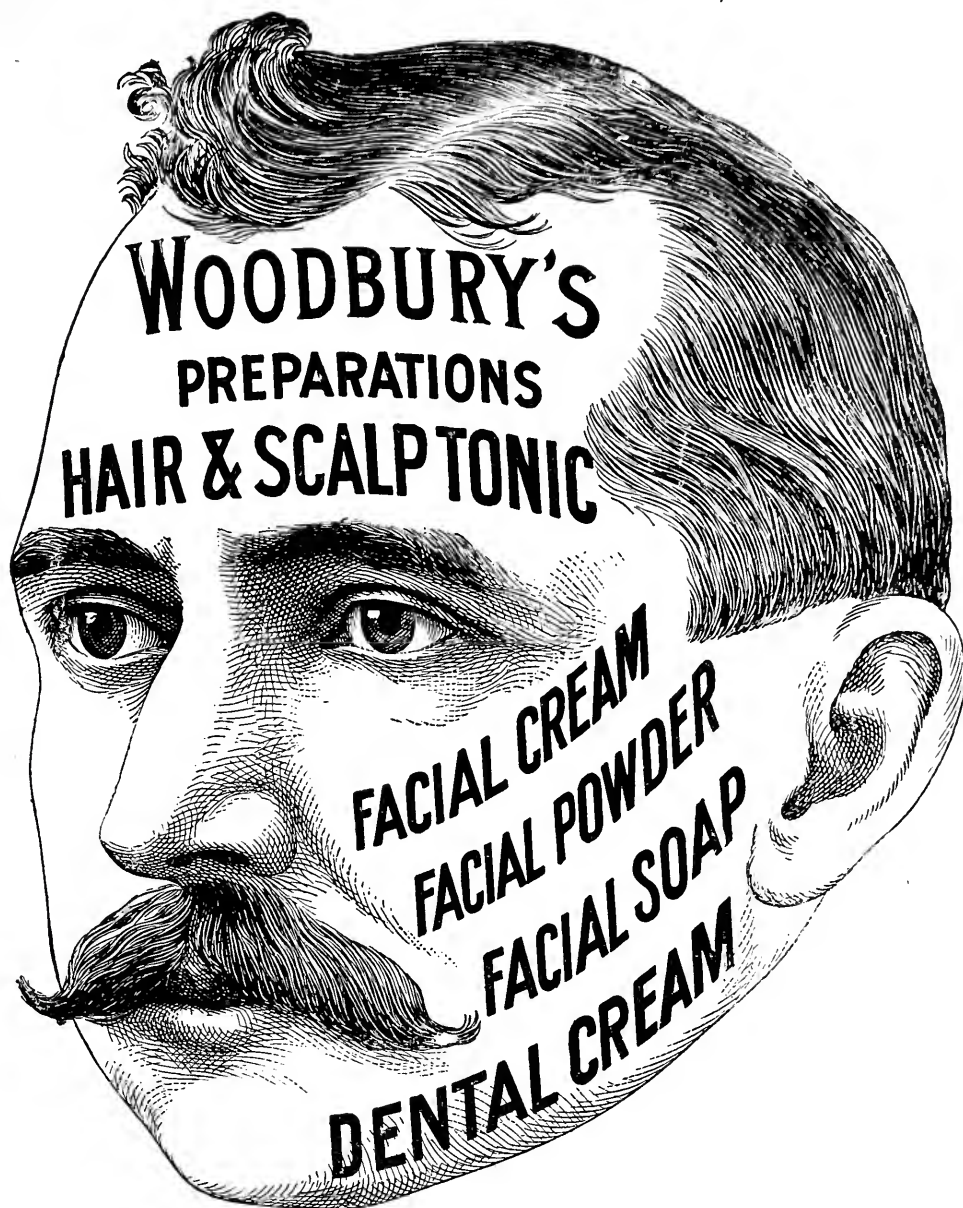

**T**HE GRANDEST TOILET COMBINATION known for the Skin, Scalp, Complexion, and Teeth, manufactured by Dermatologist John H. Woodbury, who has had over 26 years' practical experience treating the Skin, Scalp, and all Facial Blemishes. For 20 cents we will mail you a sample of each (sufficient for three weeks' use) of Woodbury's Facial Soap, Facial Cream, Facial Powder, and Dental Cream, and include our 132-page illustrated book on Dermatology, treatment for the Skin and Complexion, and telling how Featural Irregularities are corrected. The regular size of Woodbury's Facial Soap, Facial Cream, Facial Powder, and Dental Cream are sold everywhere at 25 cents each; Woodbury's Hair and Scalp Tonic, 50 cents.

**WOODBURY'S FACIAL CREAM** is highly perfumed, contains no gum, oil or grease. Its use will not cause a superfluous growth of hair, and for tan, freckles, eczema and all mild cutaneous affections it is highly recommended.

**WOODBURY'S FACIAL POWDER** is harmless, transparent, and when used is invisible. It is made by a dermatologist who has had over 26 years' practical experience treating skin diseases, and can be relied upon to contain nothing to irritate or cause a blemish of any nature on the skin.

**WOODBURY'S HAIR AND SCALP TONIC** removes scurf, scales and dandruff from the scalp, prevents the falling of the hair, stimulates its growth and restores the lustre. It can be used with advantage by both young and old. Its use does not stain the scalp or clothing.

**WOODBURY'S FACIAL SOAP** is recommended by physicians, being pure, antiseptic, medicinal. It is the only soap that will clear the skin of pimples, blackheads and eruptions of any nature.

**WOODBURY'S DENTAL CREAM** is indorsed by the dental profession, is strictly vegetable, and a most agreeable medium for cleaning the teeth, arresting and preventing decay, and imparting to the gums that high color and firmness indicative of their health. It is put up in tubes, which makes it convenient to use at home or when travelling. Each tube will last from three to four months.

John H. Woodbury Dermatological Institute offices, for the cure of Skin and Nervous Diseases, and the removal of Facial Blemishes: New York, 133 W. 42nd St.; Boston, 11 Winter St.; Chicago, 163 State St.; Philadelphia, 1306 Walnut St. Address all letters to 133 W. 42nd St., New York. Consultation by letter or in person free.

*Men can live on raw food;  
But they thrive better when it is cooked.  
So do horses, dogs, cattle, and fowls.  
Every dog fancier, every poultry breeder, every kennel owner, and  
every stock breeder should have a*

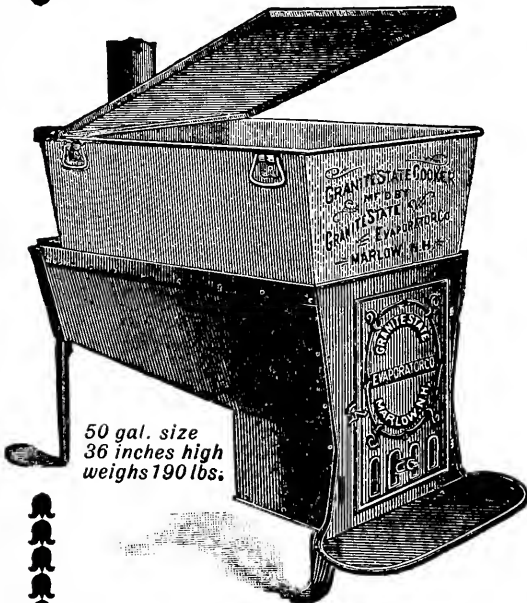

50 gal. size  
36 inches high  
weighs 190 lbs.

# Granite State

## FEED COOKER AND HEATER

Cooked Food is especially valuable for puppies, at weaning time, and they should never have any other kind.

The lightest, most convenient, and most

## Economical Farm Boiler

For Kennelmen, Poultrymen,  
Stock Raisers, and Dairymen

Guaranteed just as represented in the illustration or money will be refunded. Hundreds sold. No complaints.

Brookwood Farm,  
Lower Squankum, N. J., June 12, 1897.

GRANITE STATE EVAPORATOR CO.

*Gentlemen:*—I consider the Granite State Cooker, purchased from you, a valuable addition to the numerous needs of the farm. We use it for hog and duck feed at present, and find it clean, efficient, and expeditious. Last winter it more than paid its cost in its handy treatment of the "hot-mess" for the industrious hens.

Yours very truly,  
ALFRED E. JENNINGS.

New York, Sept. 30, 1897.

Mr. F. E. MORRISON, Pres.,  
GRANITE STATE EVAPORATOR CO.,  
Temple Court, City.

*Dear Sir:*—I am pleased to advise you that the Cooker reached me in good condition. I was much pleased with the careful and substantial way in which it is built, but more so with its efficiency as a Cooker.

I have been interested for the past fifteen years in breeding Scotch Deerhounds, and as all their food has to be cooked for them, I am familiar with the advantages of a good Cooker. All dog fanciers, where it is necessary to cook for dogs, should use these machines. Wishing you success, I am,

Yours very truly,  
ALBION L. PAGE.

The *Boiler* is made of galvanized steel. The *Furnace* sides and *linings* are of sheet steel plates. Front, door, and hearth of cast iron. Will last a lifetime. The boiler can be used for heating water and cooking all kinds of food for hogs, cattle, dogs, and poultry; and, with an extra boiler, for preserving fruits, vegetables, boiling cider, making apple jelly; and many other purposes for which a large cooking utensil is desired. Made in 7 sizes: 25 gallon, \$12; 50 gallon, \$17; 100 gallon, \$24. Send for circulars containing full description and testimonials.

Sold on installments if desired.

We publish a book, "*Cooking Food for Stock*," which we will send free, if you mention *RECREATION* when you write.

GRANITE STATE EVAPORATOR CO.  
627 Temple Court, New York

## SOME GOOD GUIDES.

Following is a list of names and addresses of guides who have been recommended to me, by men who have employed them; together with data as to the species of game and fish which these guides undertake to find for sportsmen.

If anyone who may employ one of these guides finds him incompetent or unsatisfactory, I will be grateful if he will report the fact to me.

## ALASKA.

William York, Juneau, moose, bear, deer, sheep, goats and small game.

## CALIFORNIA.

Chris. Ringsin, Avalon, Santa Catalina Island, goats, water-fowl, and salt water fishing.

John Broder, Visalia, trout, deer, bear, grouse, and quails.

S. L. N. Ellis, Visalia. ditto

## COLORADO.

J. M. Campbell, Buford, elk, bear, deer, antelope, trout and grouse.

Chas. Smith, Buford, ditto

Frank Allen, Dotsero, Eagle Co., "

Charles Allen, Dotsero, Eagle Co., "

John Meier, Sweetwater Lake, Dotsero P. O., "

Eagle Co., "

R. W. McGee, Debeque, "

Lem Crandall, Debeque, "

Sam. T. Himes, New Castle, "

Luke Wheeler, Pinkhampton, "

Nathan Fisher, Gunnison, "

W. H. Hubbard, Glenwood Springs, "

W. L. Pattison, Buford, "

J. E. Borah, Glenwood Springs, "

Ed. L. Stockton, 527 11th St., Greeley, "

## FLORIDA.

C. L. Farnham, Avon Park, bear, deer, turkeys, quails, ducks, black bass, etc.

Oliver Tinny, Ozona, Hillsboro Co., deer, bear, turkeys, quails, ducks and salt-water fishing.

E. M. Reynolds, Fort Myers, ditto

Wm. Webb, Osprey, Manatee Co., "

Frank Guptill, Osprey, Manatee Co., "

W. J. Meyer, Tarpon Springs, "

Frank Carson, Ft. Meyers, "

E. T. Robinson, Keuka, "

Carson Bros., Frostproof, "

J. L. Sandlin, Punta Gorda, "

Oliver Archer, Clearwater, "

L. W. Scroggins, Homeland, "

Capt. Jas. Argo, Oviedo, "

F. J. Adams, Sanford, "

C. B. Bailey, Winter Haven, "

W. H. Steacy, Pt. Tampa City, "

Wm. J. Lyon, Interlachen, "

L. L. Sutton, Sutherland, "

M. B. Carson, Frost Proof, Polk Co., "

W. D. Isier, Eagle Lake, "

George W. Hawthorn, Hawthorn, "

C. H. Hill, Maitland, "

J. E. Bowen, Laughman, "

Margan Bass, Kissimmee, "

B. C. Lanier, Leesburg, "

John Hunter, Winter Park, "

H. Shipman, Haskell, "

Robert James, Emporia, "

Alex. Brown, Martin, "

W. J. McCullough, Boardman, "

Frank Smith, St. James City, "

Jinks McCreary, Higly, "

Baldwin Cassidy, Lisbon, "

W. H. Howell, Centre Hill, "

Ed. Brown, Dunedin, "

G. B. Lawson, Lake Maitland, "

J. H. Maddox, Wauchula, "

Will Montgomery, Arcadia, "

T. E. Fielder, Calvinia, "

W. F. Hays, Webster, "

John Beidler, Gabrielle, "

## IDAHO.

W. L. Winegar, Egin, Fremont Co., elk, bear, deer, antelope, mountain sheep, trout and grouse.

Geo. Winegar, St. Anthony, Fremont Co., ditto

R. W. Rock, Lake, Fremont Co., "

Ed. Stailey, Lake, Fremont Co., "

J. S. Sadorus, Sarilda, Fremont Co., "

Geo. W. Rea, Orange, Fremont Co., "

L. C. Roberts, Weippe, "

Wm. Fraser, Beaver Canyon, "

## IOWA.

Geo. Jenkins, Spirit Lake, ducks, prairie chickens, black bass, etc.

Wilbur Clark, Spirit Springs, ditto

## MAINE.

Wm. S. Emery, Blakesley Camps, Eustis, moose, caribou, deer, trout, grouse.

Charley Condon, Moro, ditto

Wm. Atkins, Oxbow, "

J. E. Jenkins, "

John J. Kelly, "

Royal E. Paine, Stratton, "

Charles Hathaway, Medway, "

Victor Scott, Millinockett, "

C. O. Norton, Dover, "

Benjamin Woodard, Dover, "

Col. N. D. Brown, Roach River House, "

Alonzo Davenport, Shesuncook, "

Ichabod Smith, Greenville, "

Ernest Ham, Guilford, "

Job Folsom, Burlington, "

Alonzo Folsom, Burlington, "

Reuben Sibley, Burlington, "

Charlee Capen, Capens, "

Ed. Masterman, Moosehead, "

Marsh Carlton, Rangely, "

Freeman Tibbetts, Rangely, "

Fred Reed, Medway, "

Dan Hale, Medway, "

Will Meyer, Eustis, "

Charles Haley, Eustis, "

H. R. Horton, Eustis, "

P. E. Young, Sherman Mills, "

Abner McPhiters, Norcross, "

Albert McPhiters, Norcross, "

Horace B. Cushman, Norcross, "

Irving Hunt, Norcross, "

Wm. O. Shaw, Dobsy Lake, Washington Co., "

Ran. Day, Princeton, Washington Co., "

Geo. C. Jones, Carritunk, "

Geo. W. Spaulding, Carritunk, "

Geo. Douglass, Eustis, "

David Quint, Eustis, "

Davis Moody, Stratton, "

Gus Jones, Stratton, "

Fred Viles, Stratton, "

John Darling, Lowell, "

Joe Francis, Old Town, "

Sebat Shay, Old Town, "

Louis Ketcham, Old Town, "

Granville M. Grey, Old Town, "

Thomas Benham, Jay, "

L. A. Orcutt, Ashland, "

## MICHIGAN.

Bony Markelty, Negaunee, deer, bear, grouse, trout, black bass, and muskalonge.

Thos. Starr, Alpena, ditto

## MINNESOTA.

C. L. Porter, Glenwood, ducks, geese, prairie chickens, and black bass.

Jack Baldwin, Jackson, ditto

Guy H. Remore, Remidji, Beltrami Co., "

Mr. Thos. Clark, Remidji, Beltrami Co., "

E. L. Brown, Warren, moose, deer, prairie chickens, ruffed grouse, ducks, geese, black bass, pike, pickerel, etc.

## MONTANA.

M. P. Dunham, Woodworth, elk, bear, deer, antelope, mountain sheep, trout and grouse.

Geo. H. Heywood, Red Lodge, ditto

Geo. W. Solleder, Lake Como, "

W. H. Ryther, Columbia Falls, "

SOME GOOD GUIDES (Continued).

MONTANA (Continued).

Quincy Myers, Columbia Falls, ditto  
 Theodore Christiansen, Columbia Falls, "  
 Mr. William Jackson, Browning, Montana, "  
 W. A. Hague, Fridley, "  
 E. E. Van Dyke, Red Lodge, "  
 Vic. Smith, Anaconda, "  
 James Blair, Magdalen, "  
 George Whitaker, Gardiner, "

NEW HAMPSHIRE.

P. Marden, Wolfboro Falls, black bass, grouse and quails.  
 Frank Britton, Wolfboro Falls, ditto  
 Ned Norton, Colebrook, moose, caribou and deer.  
 John Bresette, Diamond Pond, ditto  
 Henry Bresette, Diamond Pond, "  
 Lafayette S. Covell, Connecticut Lakes, caribou, deer, etc.  
 M. Burnham, Conway Centre, ditto  
 W. H. French, South Conway, "  
 L. D. Mills, South Conway, "

NEW JERSEY.

Billy Throckmorton, Mannahawkin, ducks, geese, brant, shore birds, grouse, salt-water fishing.  
 Dory Hulse, Mannokoking, Ocean Co., ditto  
 Ernest Worth, Bayville, Ocean Co., "  
 James Emmans, Jr., Swartwood Lake, Swartwood, black bass, pickerel, quails and rabbits.  
 Mr. Riker, Culver's Lake, Branchville, perch, black bass and pickerel.

NEW YORK.

Cal. Blanchard, Upper Jay, deer, grouse, rabbits, squirrels and trout.  
 Abe Rundle, Eldred, Sullivan Co., ditto  
 H. M. Tacey, White Lake, Sullivan Co., "  
 Eugene Scrafford, Eighth Lake, Old Forge, "  
 Edson Brown, Spring Cove, Franklin Co., "  
 F. A. Young, Big Moose, "  
 Dan Ainsworth, Big Moose, "  
 Chris Wagner, Beaver, "  
 Edw. Ball, Old Forge, "  
 Eugene M. House, Glendale, "  
 L. C. Pendell, Athol, "  
 Chas. McKaffery, Saranac Inn, "  
 C. I. Stanton, Blue Mountain Lake, "  
 Leonard Bunting, Greenfield, Ulster Co., grouse, woodcock and trout.  
 Thomas Flake, Cape Vincent, pickerel, muskalonge, black bass.  
 Wilfred Dodge, Cape Vincent, ditto  
 Ren Dodge, Cape Vincent, "  
 Warren Aldrich, Greenwood Lake, black bass, trout, grouse, squirrels, rabbits, etc.  
 Charles Lane, Good Ground, L. I., ducks, geese, snipe, plover and salt-water fishing.  
 LeRoy Still, Blue Point, L. I., ditto  
 Capt. Alfred Lebanow, Amityville, L. I., "  
 Harry Rogers, Eastport, L. I., "  
 Geo. Rolston, Lake Ronkonkoma, L. I., "  
 Willett Ellison, Freeport, L. I., "  
 W. C. Raynor, Freeport, L. I., "  
 W. N. Ackerley, Patchogue, L. I., ducks, baybirds, salt-water fishing.  
 H. Smith, Moriches, L. I., quails, woodcock and grouse.  
 Dan Havens, Centre Moriches, L. I., ditto  
 Hugh Smith, East Moriches, L. I., "

NORTH CAROLINA.

Fenner S. Jarvis, Haslin P. O., deer, bear, turkeys and quails.  
 Rebert Waterfield, Knotts Island, ditto  
 Jas. Tooly, Belleport, "  
 W. C. Halsted, Currituck C. H., deer, turkeys, quails, ducks, salt-water fishing.  
 Fred. Latham, Haslin, ditto

NORTH DAKOTA.

Geo. Carl, Sanborn, ducks, geese, prairie chickens, snipe, black bass and pike.

OREGON.

Wm. Ascher, West Fork, Douglass Co., deer, bear, elk, trout, grouse, ducks and geese.  
 E. L. Howe, Creswell, Lane Co., ditto

PENNSYLVANIA.

Leonard Champion, Prop'r Lehigh Valley Hotel, Mahopany, Wyoming Co., bass, pickerel, salmon.  
 John W. Kellettsville, deer, grouse, trout, black bass, etc.

UTAH.

Stampp Bros., Ogden, elk, bear, deer, antelope, sheep, grouse, ducks, geese and trout.

VERMONT.

E. Ward, Fair Haven, woodcock, grouse, black bass and trout.

VIRGINIA.

M. Corbel, Virginia Beach, geese, brant, ducks, shore birds, quails, salt-water fishing.  
 Captain R. E. Miles, Machipongo, ditto  
 C. A. Spencer, Buckingham, "  
 M. A. Barner, Clarksville, "

WASHINGTON.

John S. Wood, Morton Lewis Co., deer, grouse, trout, etc.

WISCONSIN.

T. R. Page, Bruce, deer, grouse, trout, black bass and muskalonge.  
 Charles Johnson, care Williams, Salsich & Co., Star Lake, Vilas Co., ditto  
 L. L. Thomas, State Line, "  
 John Thomas, State Line, "  
 Chas. French, Three Lakes, "  
 John Albright, Three Lakes, "  
 M. E. Monsell, Star Lake, Vilas Co., "  
 H. E. Soule, South Range, "  
 Judd Blaisdell, Camp Franklin, Woodruff, "  
 Alexander Gillies, Camp Franklin, Woodruff, "  
 C. J. Coon, Camp Franklin, Woodruff, "  
 Chas. Lebell, Manitowish, Wis., "

WYOMING.

Mark H. Warner, Ten Sleep, elk, bear, deer, mountain sheep, antelope, grouse and trout.  
 Milo Burke, Ten Sleep, ditto  
 James Fullerton, Ten Sleep, "  
 Nelson Yarnall, Dubois, "  
 Geo. Y. Hayes, Dubois, "  
 S. A. Lawson, Laramie, "  
 R. C. Tregoning, Laramie, "  
 A. Pache, Laramie, "  
 N. E. Brown, Marquette, "  
 H. D. DeKalb, Big Piney, "  
 Ira Dodge, Cora, "  
 S. N. Leek, Jackson, "  
 Jack Hurst, Ishawood, "  
 W. A. Kepford, Ishawood, "  
 Wm. Wells, Cora, "  
 Frank L. Peterson, Jackson, "  
 O. F. Bike, Jackson, "  
 F. E. White, Jackson, "  
 W. A. Hague, Pleasant Valley Hotel, via Mammoth Hot Springs, "

CANADA.

Christopher Bowers, Shelburne, Nova Scotia, moose, bear, grouse, black bass and trout.  
 Frank Komondo, Desert or Maniwaki, P. Q., ditto  
 Philamon Gashon, Three Lakes, P. Q., "  
 Geo. Gillard, Little Bay, Notre Dame Bay, Newfoundland, caribou, bear, ptarmigan, ducks and geese.  
 W. Kelly McKay, Upper Clyde, Shelburne Co., N. S., moose, bear, lynx, fox, partridge, rabbit, trout.  
 James H. Bower, Upper Clyde, ditto  
 Thomas Davis, Upper Clyde, "  
 Purney Davis, Upper Clyde, "  
 Christian Ryer, Middle Clyde, "  
 Daniel McKay, Middle Clyde, "  
 Parker K. Freeman, Milton, Queens Co., N. S., moose, bear, lynx, fox, partridge, rabbits, trout, salmon.  
 John Jeremy, Milton, ditto  
 Stephen Glode, Milton, "  
 Alick Michel, Milton, "  
 Enoch Freeman, Greenfield, "  
 Boardman Hunt, Greenfield, "  
 Capt. Jesse Milliken, St. George, N. B. "  
 Henry I. Millar, River Desert, "  
 David McDougal, Okanagan Mission, B. C., goats, sheep, bear, elk, deer, etc.  
 Guy Thomas, Cherry Creek, B. C., ditto  
 I. S. Wilson, Okanagan Lake, B. C., "  
 Eneas McDougal, Kelowna, "  
 Urban McDougal, Kelowna, "

# "THE LITTLE FINGER DOES IT"

The Fisherman's Automatic Reel



## THE AUTOMATIC



## REEL

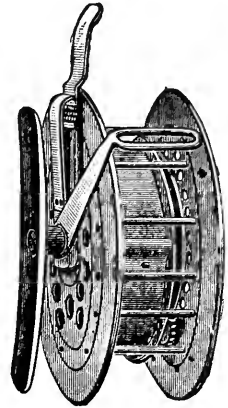

### What we claim for the Automatic Reel

**First**—It will wind up the line a hundred times as fast as any other reel in the world.

**Second**—It will wind up the line slowly if the angler chooses.

**Third**—No fish can ever get slack line with it.

**Fourth**—It will save more fish than any other reel.

**Fifth**—It will prevent tips, lines, and snells from being broken by large fish.

**Sixth**—The reel is manipulated entirely by the hand that holds the rod.

**Seventh**—It enables the angler and makes it desirable to use lighter tips.

SEND FOR CATALOGUE

# The Press Button Knife

Can be Opened Instantly with One Hand by Slightly Pressing the Button :: ::

## FOR Hunting, Fishing and Camping

Our 4-inch or 5-inch jack-knife is invaluable in emergencies when you need a strong knife quickly. Press button and blade is open for use.

- Four-inch Blade, Stag Handle. . . . . \$1.00
- Five-inch Blade, Stag Handle, . . . . . 1.25

SENT POSTPAID

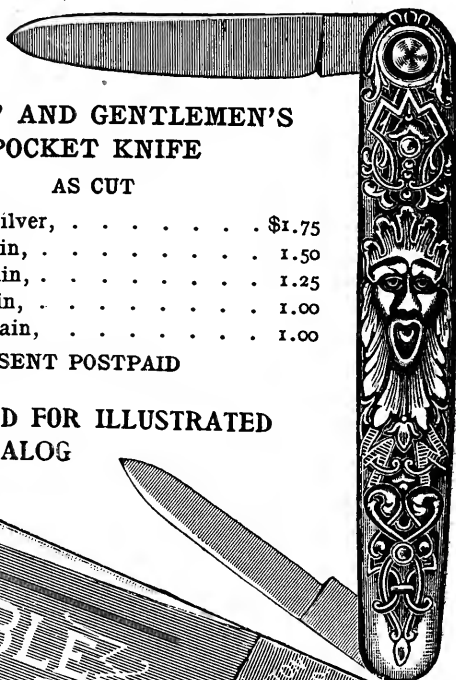

### LADIES' AND GENTLEMEN'S POCKET KNIFE

AS CUT

- In Sterling Silver, . . . . . \$1.75
- In Pearl, Plain, . . . . . 1.50
- In Ivory, Plain, . . . . . 1.25
- In Stag, Plain, . . . . . 1.00
- In Ebony, Plain, . . . . . 1.00

SENT POSTPAID

SEND FOR ILLUSTRATED CATALOG

## LOTT & SCHMITT

112-114 Walker Street  
NEW YORK

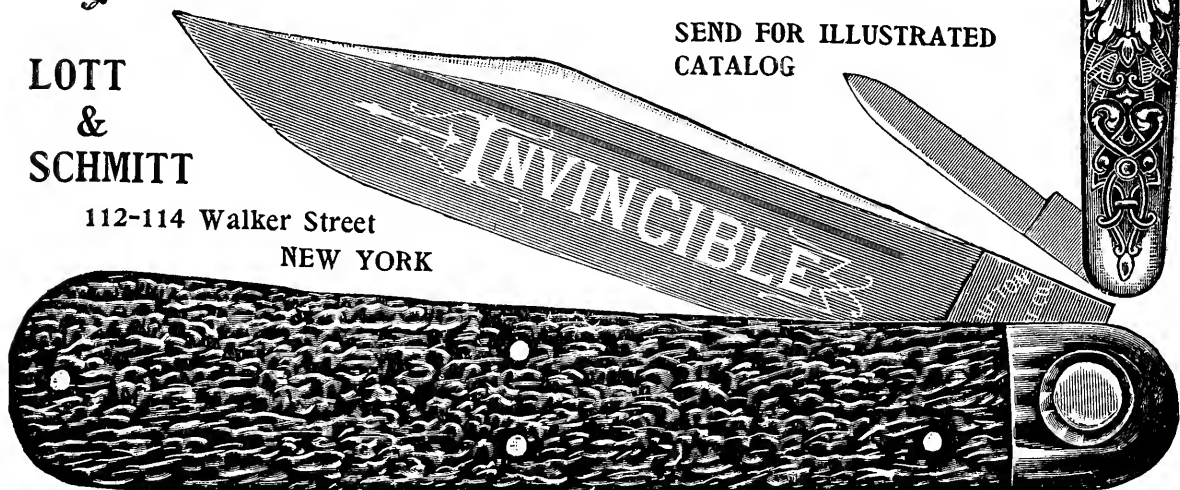

"Anything new at the vaudeville last night?"

"Yes; one of the actors had a storage-battery connected with his glass eye."

She—"Your dog is just determined to bring his bone and gnaw it at my side."

He—"Of course; the clever little scamp knows that 'the nearer the bone the sweeter the meat.'"

"Joe was furious last night."

"What was the matter?"

"Well, he lugged our folding wheel-rack all the way out to the picnic and when he got there found it was the folding hat-rack."

"How you women do jump at conclusions."

"I don't; I go on my wheel."



A Trial will Convince You that  
**GOLDEN SCEPTRE**  
 SMOKING TOBACCO  
 Is Almost Perfection. We will send on receipt of 10c. a sample to any address. Prices of Golden Sceptre, 1 lb., \$1.30; ¼ lb., 40 cts., postage paid.  
 — CATALOGUE FREE. —  
**SURBRUG, 159 Fulton Street, New York City.**

# The Wing

❁ ❁ STYLE 7

# Piano



You do not have to pay an extravagant price for a first-class piano



In justice to yourself write for prices of the Wing Piano before you buy



## The Instrumental Attachment ❁

imitates perfectly the tone of the Mandolin, Guitar, Harp, Zither and Banjo, giving the effect of an entire orchestra of these instruments playing in concert with the piano ❁ ❁ ❁ ❁

**SENT ON TRIAL** • We will send this piano, or your choice of four other styles, to any part of the United States *On Trial* (all freights paid by us), allow ample time for a thorough examination and trial in the home, and, if the instrument is at all unsatisfactory, we will take it back at our own expense. No conditions are attached to this trial. We ask no advance payment; no deposit. We pay all freights in advance.

### OLD INSTRUMENTS EXCHANGED EASY PAYMENTS

OUR BOOK should be in the hands of every one who intends to buy a piano. It contains many valuable hints and instructions, and tells a great many things every buyer ought to know. We will send it free with our catalogue to any one who writes us.

**WING & SON,** 443 and 445 West 13th St., N. Y. City

ESTABLISHED 1868

# The Muskoka and Midland Lakes Resorts

Reached only by the

## Grand Trunk Railway System

Is the Paradise for not only hunters, fishermen, and canoeists, but also those in search of health, where comfort and pleasure can be obtained economically.

The woodland and lake scenery would satisfy the most critical tourist.

Camping outfits can be purchased cheaply, or guides, thoroughly acquainted with this region, fully equipped for camping, can be secured readily.

Parties can be furnished with names of guides, and by communicating with them, make all necessary arrangements in advance.

The following fish and game, in season, are to be found in abundance, the variety of which is not surpassed by any other sporting region in the world:

**Fish.**—Bass, pickerel, brook trout, lake trout, whitefish, perch, sunfish, salmon, trout, sturgeon, catfish, herring, and muskallonge.

**Game.**—Deer, partridge, rabbits, pigeons, ducks, geese, plover, bear, woodcock, snipe, grouse, and moose.

**A few of the other Principal Resorts.**—Androscoggin Lakes, the White Mountains, the salmon resorts of Quebec, New Brunswick, and Nova Scotia, Lake St. John region, the River St. Lawrence, the Thousand Islands.

For descriptive book showing routes and rates, apply to M. C. DICKSON, D.P.A., Toronto, Ont.; D. O. PEASE, D.P.A., Montreal, P.Q.; L. R. MORROW, C.P.A., Chicago, Ill.; R. MCC. SMITH, S.P.A., Cincinnati, O.

CHAS. M. HAYS, GEO. B. REEVE, W. F. DAVIS,  
General Manager, Gen. Traffic Manager, G. P. & T. A.,  
Montreal, P. Q. Montreal, P. Q. Montreal, P. Q.

FRANK P. DWYER, E. P. Agent, 273 Broadway, New York.

# ...to "the" Pleasure Resorts of... Texas and Gulf of Mexico

TAKE



Via CHICAGO, KANSAS CITY, or  
ST. LOUIS

WAGNER BUFFET SLEEPERS  
FREE "KATY" CHAIR CARS

For further information, address

W. S. ST. GEORGE, Gen. East. Agt.  
309 Broadway, New York

2,000  
Miles



OF

varied scenery; mountains, hills, valleys, rivers, lakes, parks, canyons—found between St. Paul and Portland, Oregon.

All the best cities of the northwest reached via this line.

Pullman sleeping cars, both first-class and tourist, and through dining-cars, on all overland trains.

FINEST HUNTING AND  
FISHING RESORTS

Send six cents for our new book  
WONDERLAND '97

CHAS. S. FEE  
General Pass. Agt. St. Paul, Minn.

## UNEQUALED ATTRACTIONS

ON THE LINE OF THE

# Union Pacific

FOR TOURISTS

It traverses the Grandest Scenery of the Rocky Mountains, and reaches all the Health and Pleasure Resorts of the Mid-Continent.

**Sportsmen** will find in scores of localities along this line game worthy of their skill, such as Bear, Mountain Lion, Coyotes, Elk, Deer, Antelope, Mountain Sheep, Feathered Game of all kinds. And everywhere are Beautiful Streams well stocked with Trout.

For Gun Club Rules, Game Laws, and any information relative to localities for Hunting, or for information in regard to the UNION PACIFIC SYSTEM, call on or address any General or Traveling Agent of this Company.

R. TENBROECK, Gen'l Eastern Agent,  
287 Broadway, New York City

E. DICKINSON, Gen'l Manager, E. L. LOMAX,  
Gen'l Pass. & Tkt. Agt.  
Omaha, Neb.



# B&O

## Solid Trains TO all Points WEST

## 20 BOOKS ❀ ❀

ON 20 DIFFERENT SUBJECTS,  
BUT ALL RELATING TO SOME  
DELIGHTFUL PHASE OF  
AMERICAN TRAVEL, VIA  
"AMERICA'S GREATEST RAIL-  
ROAD."



ILLUSTRATED CATALOGUE SENT  
FREE, POST-PAID, ON RECEIPT  
OF A 1-CENT STAMP BY GEORGE  
H. DANIELS, GENERAL PASSENGER  
AGENT, NEW YORK CENTRAL &  
HUDSON RIVER RAILROAD, GRAND  
CENTRAL STATION, NEW YORK.

## NEW MODEL REVOLVER

Has important advantages over all other makes. Rebounding Lock, which obviates all liability of accidental discharge when closing, after discharging cylinder. Simple and superior method of holding cylinder to barrel. Can be removed instantly by pressing a catch in front of the cylinder.

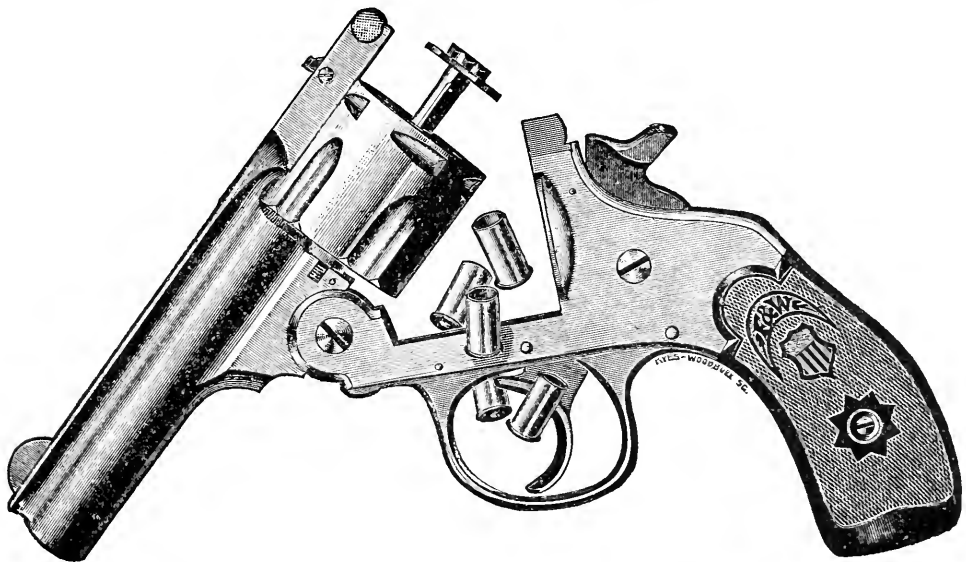

Workmanship unexcelled. All parts interchangeable, and made from drop forgings. Frame is made of cast steel. No malleable iron about it.

SEND FOR CATALOGUE

Mention RECREATION

FOREHAND ARMS CO., Worcester, Mass.

Given as a Premium for 5 Yearly Subscriptions to Recreation



# TIPS:—

Dealers and individual fishermen are always thankful for “tips.” That is to say: the dealers are thankful for business tips, and the fishermen for tips on reliable fishing waters, and real, actual rod tips. We are speaking about the “tips” made by the manufacturers of the celebrated Bristol Steel Fishing Rods—for rods. Tube Tips, Double Hole Tips, One-Ring Fly Tips, Three-Ring Tips, Agate Tips (solid), Agate Screw-off Tips, Agate Basket Tips, etc. Then there are Standing Ring Guides, Twisted Wire Guides, Agate Guides, Two-Ring Tie Guides, Anti-Friction Raised Tie Guides, Trumpet Guides, Common Tie Guides, etc.

Catalogue “R”  
has cuts of 'em all:

Send for it. Mention RECREATION.

The Horton Manufacturing Co.  
Bristol, Conn.

For nearly 50 Years the name

**"Davenport"**



has been identified with the manufacture of

**Guns....**

**and Rifles**  
+++++

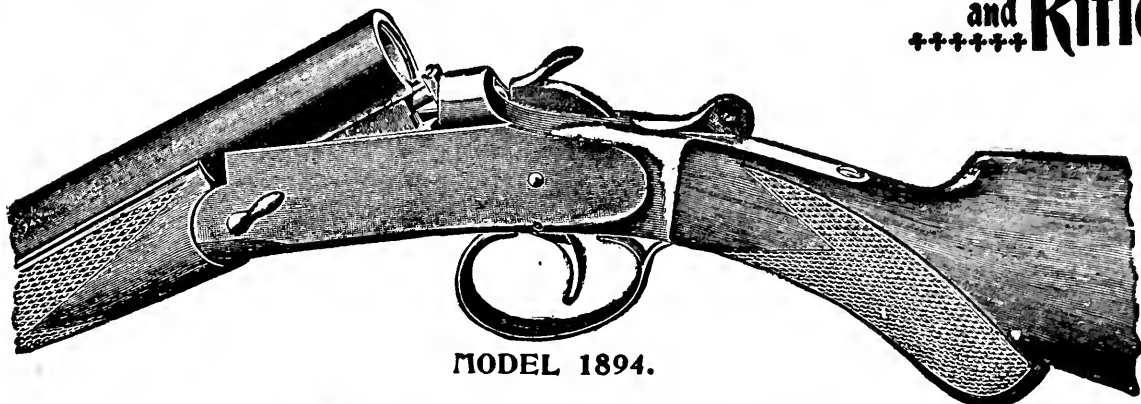

MODEL 1894.

**AUTOMATIC EJECTOR**

Our present line is complete and varied and shows the result of years of experience.

For catalogues and information address

**THE W. H. DAVENPORT FIRE ARMS CO.**

**NORWICH, CONN., U. S. A.**

Mention "RECREATION"

*Ejector Guns  
no longer a  
luxury*

**Good News for Sportsmen**

Lefever Automatic Ejector Guns at a price within the reach of every sportsman.

OUR NEW EJECTOR MOVEMENT

*Has only two pieces: One in the Hammer, One in the Frame.*

We have decided to meet the demand for *medium* price Ejectors, and are now prepared to accept orders for all grades of our hammerless guns fitted with Ejectors.

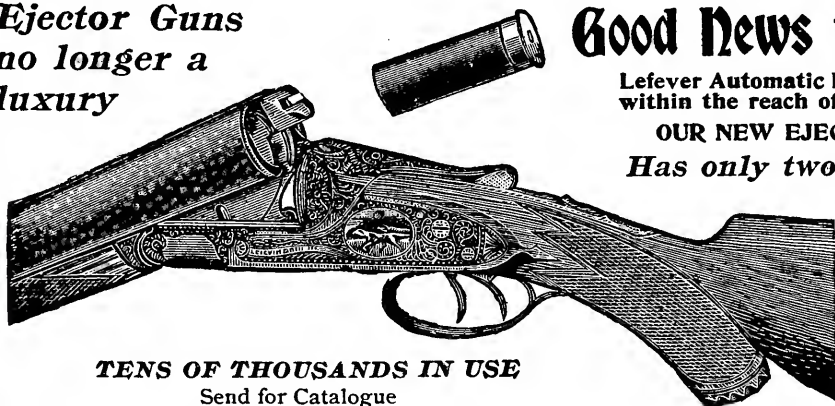

**TENS OF THOUSANDS IN USE**  
Send for Catalogue

**LEFEVER ARMS CO. - - Syracuse, N. Y.**

(Mention RECREATION.)

Date,.....1897.

G. O. SHIELDS,

Editor and Manager of RECREATION, 19 West 24th St., New York:  
Herewith find One Dollar, for which please send me RECREATION  
for one year beginning with.....number.

Name,.....

Remit by P. O. or Express Money Order, or New York Draft.

**DETACH THIS, FILL OUT, AND SEND IN.**

# New Ithaca Guns

Self compensating,  
taking up wear  
at every point

Bored  
**FOR BLACK AND  
NITRO POWDERS**

Close and Hard Shooting Guns  
at long range a specialty



Price but a little more than one-half that of any other good gun, and  
warranted in the most positive terms, shooting included

## ITHACA GUN COMPANY, ITHACA, N. Y.

Send for circular  
Mention RECREATION

Manufacturers of fine Hammer  
and Hammerless Guns

FOR FIELD OR FOR TRAP,  
FOR POT HUNTING OR FUN,  
NO SPORTSMAN IS EQUIPPED  
WITHOUT A SYRACUSE GUN

“MORE TRUTH  
THAN POETRY”

We do not say that **SYRACUSE HAMMERLESS GUNS**

“Are as Good” as any gun in the market.

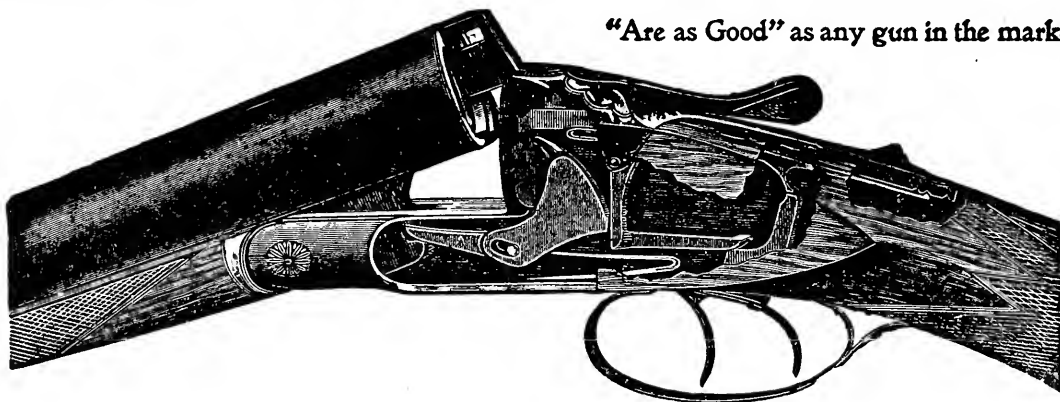

Their simplicity of construction and superiority of finish stamp them “BETTER” for  
practical all-round work than any gun in the market. The “old, old story” but,  
nevertheless, substantiated by every man who ever drew a Syracuse to his shoulder.

**SYRACUSE ARMS CO., SYRACUSE, N. Y., U. S. A.**

Sole Agents, HERMANN BOKER & CO., 101 Duane Street, New York City

# Forehand Arms Co.'s

EJECTOR AND NON-EJECTOR  
HAMMERLESS DOUBLE GUN



## LATEST MODEL

*Read what men  
say of the  
Forehand  
who are using it*

The Forehand hammerless gun, sent me for a club of 35 subscriptions, is a beauty. It is simple, but durable, in construction, and has superior shooting qualities. It has been tried at the trap, and gave perfect satisfaction, while in the field it cannot be surpassed.

HENRY DRUSE, Belding, Mich.

I received the Forehand gun, in good condition, and am much pleased with it, in every particular. It is exactly as I requested. Have killed ducks with it which my companions said were out of reach of any shotgun.

FRED. D. JONES, Port Townsend, Wash.

The Forehand hammerless gun you sent me, for 35 subscriptions, is a beauty, and fits me perfectly. I have tried it, and must say its shooting qualities are fully equal to its beauty. It is admired by all who see it.

R. A. H., Escanaba, Mich.

*We get thou-  
sands of such  
Testimonials  
all Unsolicited*

"WHAT EVERYONE SAYS MUST BE SO"

*We challenge competition in Beauty, Workmanship, Simplicity of Mechanism, Shooting Qualities and Price. We target all our guns with nitro powder. For Catalogue, address*

**FOREHAND ARMS CO., WORCESTER, MASS.**

Spratts Patent, Limited, are shipping large quantities of their Dog Cakes to the Pacific Coast for the supply of parties starting out for the  these biscuits having proved so satisfactory on recent polar expeditions. They are used at field trials, on hunting expeditions, and in the principal kennels of the world. Send for catalogue to the New York office, 239-245 East 56th Street, or to the California branch, 1320 Valencia Street, San Francisco.

## Klondike

Order through your Dealer and send for catalogue to  
**SPRATTS PATENT LIMITED**  
 245 EAST 56TH STREET, NEW YORK CITY

List of odd and second-hand guns now ready for mailing

# Schoverling, Daly & Gales

302 Broadway, New York

AGENTS FOR

Charles Daly Guns

Marlin Repeating Rifles

Walsrode Powder

Penn Arms Co. New \$25.00  
Hammerless

Kenwood Sleeping Bags

Swedish Coats, etc.

Catalogue mailed on application

# STEVENS

FOR THIRTY-FOUR YEARS Stevens Rifles have been celebrated for their accuracy. This is worth thinking about

"Stevens Favorite" Rifles are made for these cartridges only



Favorite No. 17

No. 17, see cut, . . . . . \$6.00  
No. 18, same, with target sights, . . . 8.50

Stevens Rifles are ALL "Take Down" Model. No Extra Charge.



Isn't it a beauty? Straight inside, slightly tapered outside. Stevens IDEAL rifles use it. Favorites do not.

Where our arms are not sold by dealers, they will be sent, expressage prepaid, on receipt of list price.

Book on shooting and small-bore circular mailed free on application; but stamps will not be refused.

J. STEVENS ARMS & TOOL CO.

P. O. Box 444

CHICOPEE FALLS,

MASS.

## MR. FRED GILBERT

In the Contest for the

**E. C. Cup**

Made the following score:

**48 out of 50**

UNKNOWN ANGLES

**48 out of 50**

EXPERT RULES

**46 out of 50**

DOUBLES

HE USED

**DuPont  
Smokeless  
Powder**

**E. I. DUPONT DE NEMOURS & CO.**

WILMINGTON, DEL.



# What's the Use

of walking when you  
can get a first-class, high-  
grade bicycle for nothing?

## How?

By getting 75 subscriptions for

## Recreation

If you live in a town of 3,000  
or more, and if you are a hustler  
you can get these in 2 days.

I can give you the names of 20  
people who did this in 1896, and  
who now have their wheels.

Write for particulars.

## RECREATION

19 West 24th Street  
New York



Every person who subscribes for **RECREATION**, or renews his subscription, this year, can get a copy of Mr. W. T. Hornaday's delightful book, "The Man Who Became a Savage," for 50 cents extra. The book sells in the stores at \$1.50; but you can get **RECREATION** one year and the book for \$1.50.

**For Sale or Exchange:**—A Stevens No. 9 range rifle. Weight 5 pounds 5 ounces;  $\frac{1}{2}$  octagon 26 inch barrel. Calibre 22-5-40 (long rifle). Nickel Swiss butt. Polished stock and fore-end. Full target sights front and rear. Very fine condition. Smooth tight action. Splendid shooter.

Want to exchange for single shot rifle of slightly larger calibre, with Lyman sights, or for a camera. H. B. Ward, Le Roy, N. Y.

**For Sale:**—Ten gauge, 32 inch,  $9\frac{1}{2}$  pound, L. C. Smith ejector gun; cost \$225; good as new,  $14\frac{1}{2}$  inch stock,  $2\frac{3}{4}$  inch drop at heel. Will sell for \$150. Reason for selling—have ordered a high grade Lefever. W. H. F., care **RECREATION**.

**For Sale or Exchange:** An almost new set of single buggy harness. Cost \$30 7 months ago. Want rifle or shot gun; or what have you to offer? C. R. Wagner, 728 Wenonah Av., Oak Park, Ill.

## BOOKS BY G. O. SHIELDS (COQUINA)

### THE BIG GAME OF NORTH AMERICA

Its Habits, Habitat, Haunts and Characteristics. How, When and Where to Hunt it. 8vo, 600 pages, 80 illustrations. Cloth, \$3 50; Half Morocco, \$5.00; Full Morocco, \$6.50.

### CRUISING IN THE CASCADES

A Narrative of Travel, Exploration, Amateur Photography, Hunting and Fishing, with Special Chapters on Hunting the Grizzly Bear, the Buffalo, Elk, Antelope, Rocky Mountain Goat, and Deer; also on Trout in the Rocky Mountains; on a Montana Roundup; Life Among the Cowboys, etc. 12mo, 300 pages, 75 illustrations. Cloth, \$2; Half Morocco, \$3.

### AMERICAN GAME FISHES

How, When and Where to Angle for them. 8vo, 400 pages, 50 illustrations. Cloth, \$2.50; Half Morocco, \$4.

### HUNTING IN THE GREAT WEST

(Rustlings in the Rockies)

Hunting and Fishing Sketches by Mountain and Stream. 12mo, cloth. Over 300 pages. Illustrated. Price, 75 cents.

### THE AMERICAN BOOK OF THE DOG

The Origin, Development, Special Characteristics, Utility, Breeding, Training, Diseases and Kennel Management of all Breeds of Dogs. 8vo, 650 pages, 100 illustrations. Cloth, \$3.50; Half Morocco, \$5; Full Morocco, \$6.50.

### CAMPING AND CAMP OUTFITS

A Manual of Instruction for Young and Old Sportsmen. 12mo, 200 pages, 30 illustrations. Cloth, \$1.25.

### THE BATTLE OF THE BIG HOLE

History of General Gibbon's Engagement with the Nez Perce Indians in the Big Hole Basin, Montana, August 9, 1877. 12mo, 150 pages. Profusely illustrated. Cloth, \$1.

These books will be mailed, post-paid, on receipt of price, by the author.

G. O. SHIELDS

19 West 24th St., New York



# Some Rare Opportunities

These goods are all new, and will be shipped direct from factory. Prices named are those at which manufacturers and dealers usually sell. Here is a good chance to get

|              |                      |
|--------------|----------------------|
| A BOOK       | } FREE<br>OF<br>COST |
| A GUN        |                      |
| A CAMERA     |                      |
| A TYPEWRITER |                      |
| A BICYCLE    |                      |

Subscriptions need not all be sent at once. They can be sent in installments as taken and credit will be given on account. When the required number is obtained the premium earned will be shipped.

**"Recreation"** 19 West 24th Street  
New York

## To any person sending me

TWO yearly subscriptions to RECREATION at \$1 each, I will send a copy of *Hunting in the Great West*, paper; or a Czar Camera, or a Gem Camera, each listed at \$1; or an Ingersoll Watch or Cyclometer, each listed at \$1.

THREE subscriptions at \$1 each, a copy of *The Battle of the Big Hole*, cloth.

FOUR subscriptions at \$1 each, a copy of *Camping and Camping Outfits*, cloth.

FIVE subscriptions at \$1 each, a copy of *Cruising in the Cascades*, cloth; or a Willsie Pocket Camera, valued at \$5. It makes a picture  $2\frac{1}{2} \times 2\frac{3}{8}$  inches and can be loaded with 24 cut films.

SIX subscriptions at \$1 each, a copy of *American Game Fishes*, cloth; or a Baby Hawkeye Camera, listed at \$6.

SEVEN subscriptions at \$1 each, a copy of *The Big Game of North America*, or of *The American Book of the Dog*, cloth; or a Cyclone Camera, listed at \$10; or an Australian Mosquito-proof Tent, listed at \$7.

EIGHT subscriptions at \$1 each, a Pocket Kodak, made by the Eastman Kodak Co., and valued at \$5; or a Water-proof Wall Tent,  $7\frac{1}{2} \times 7\frac{1}{2}$ , and listed at \$7.50.

TEN subscriptions at \$1 each, a single-shot Davenport Rifle; or a Fishing rod, or a Yawman and Erbe Automatic Reel, worth \$9; or a Kenwood Sleeping Bag, worth \$10; or a No. 10 Gramophone, worth \$10.

TWELVE subscriptions at \$1 each, a Manhattan Improved Hand Camera, made by the Manhattan Optical Co., and listed at \$12; or an Australian Mosquito-proof Tent, listed at \$12.50.

FIFTEEN subscriptions at \$1 each, a Davenport Single-barrel, breech-loading Ejector Shotgun, listed at \$10; or a Camera, worth \$6 to \$10; or a Kenwood Sleeping Bag, complete with canvas cover, worth \$16; or a No. 2 Bullet Camera, listed at \$10.

TWENTY subscriptions at \$1 each, a 14-karat Gold Hunting-case Watch, with Elgin Movement, worth \$20; or a Marlin Repeating Rifle, listed at \$14 or less; or an Improved Night-hawk Hand Camera, made by the Manhattan Optical Co., and listed at \$25; or a No. 4 Bullseye Camera, made by the Eastman Kodak Co., and listed at \$12.

TWENTY-FIVE subscriptions at \$1 each, a No. 4 Bullet Camera, made by the Eastman Kodak Co., and listed at \$15; or a Gramophone, listed at \$25; or an Australian Mosquito Tent listed at \$25; or a Marlin Repeating Rifle, listed at \$18 or less; or a Shattuck Double-barrel Breech-loading Shot-gun, listed at \$25.

THIRTY subscriptions at \$1 each, a New Haven Arms Co.'s Double-barrel Breech-loading Shot-gun, listed at \$30; or a Marlin Repeating Rifle, listed at \$21 or less.

THIRTY-FIVE subscriptions at \$1 each, a Forehand or a Syracuse or an Ithaca Double-barrel Hammerless Breech-loading Shot-gun, worth \$35; or a Camera, worth \$25; or a Marlin Repeating Rifle, listed at \$24 or less.

FORTY subscriptions at \$1 each, a Camera, worth \$30.

FIFTY subscriptions at \$1 each, a Marlin Rifle, with fancy curled walnut stock, pistol grip, checkered fore-end, handsomely engraved, half octagon, half magazine, with take down, listed at \$50.

SEVENTY-FIVE subscriptions at \$1 each, a Safety Bicycle, listed at \$85 to \$100; or a Bopeep Camera, for 5x7 plates, made by the Manhattan Optical Co., and listed at \$90.

ONE HUNDRED subscriptions at \$1 each, a fine Lefever Hammerless Gun, worth \$85; or a Bo-peep Camera, for  $6\frac{1}{2} \times 8\frac{1}{2}$  plates, made by the Manhattan Optical Co., and listed at \$120.



The Athlete  
is best sustained  
by food which gives  
the greatest strength  
while not overtaxing  
the stomach.

*Vigoral*  
is

both meat and drink  
and is stimulating  
and nourishing.

It is a  
foe to fatigue  
and in it the athlete  
and brain-worker will  
find an ideal condensed  
food, palatable and  
strength-giving.



To be had at all places of refreshment and of druggists and grocers everywhere.  
The little pamphlet "Various Views on Vigoral" is mailed for the asking.

Armour & Company  
Chicago.



For  
Field or  
Trap

...Use...

**U.M.C.**

*Ammunition*

Send for New Complete  
Catalogue

Union Metallic  
Cartridge Co.

BRIDGEPORT, CONN.

313 Broadway  
NEW YORK

425 Market Street  
SAN FRANCISCO



Remington-Union Metallic Cartridge Co. **TRIED AND TRUE**

Send for Illustrated Catalogue

REMINGTON ARMS CO., Union Metallic Cartridge Co.

313 Broadway, NEW YORK

425 Market Street, SAN FRANCISCO

"MORE THAN A MILLION IN USE."



Reliability,  
Strength and  
Accuracy

... ARE COMBINED IN

**WINCHESTER**

Rifles And Repeating Shot Guns.

ADAPTED TO ALL KINDS OF SHOOTING.

**WINCHESTER AMMUNITION** MADE FOR ALL KINDS OF GUNS.  
SOLD EVERYWHERE.

FREE—Send name and address on a postal card for new 136-page catalogue.

**WINCHESTER REPEATING ARMS CO., New Haven, Ct.**



**TURN ON THE LIGHT!** Compare the maker's COST of equipment on a

high grade Clipper Special with the cheapest possible to use,

**Cost of Special Clipper Equipment against CHEAP WHEEL.**

|            |   |      |         |    |         |   |          |    |        |
|------------|---|------|---------|----|---------|---|----------|----|--------|
| Saddles    | @ | from | \$ 1.75 | to | \$ 2.00 | " | \$ .55   | to | \$ .85 |
| Chains     | " | "    | 1.20    | "  | 1.60    | " | .40      | "  | .48    |
| Tires      | " | "    | 6.00    | "  | 10.00   | " | 1.75     | "  | 4.50   |
| Rims       | " | "    | .70     | "  | .90     | " | .28      | "  | .40    |
| Tool Bags  | " | "    | .25     | "  | .40     | " | .07      | "  | .12    |
| Pedals     | " | "    | 1.50    | "  | 1.75    | " | .45      | "  | .65    |
| Steel Bars | " | "    | 1.50    | "  | 2.00    | " | Wood .30 | "  | .60    |
| Grips      | " | "    | .18     | "  | .28     | " | .09      | "  | .11    |

\$13.08 to \$18.93 against \$3.89 to \$7.71

Here's figures. They are facts. We can prove them, so can you. Be your own judge. But please DON'T compare a high grade Clipper with a bicycle that costs from \$9.00 to \$15.00 less for equipment only, and all other cost in proportion. The WORTH of a bicycle depends upon the cost of material and the care with which it is made.

Clipper Specials ARE expensive to make and equip. They are WORTH the price you pay.

Made by "THE CLIPPER PEOPLE." Grand Rapids, Mich.

P. 42-98.

# RECREATION

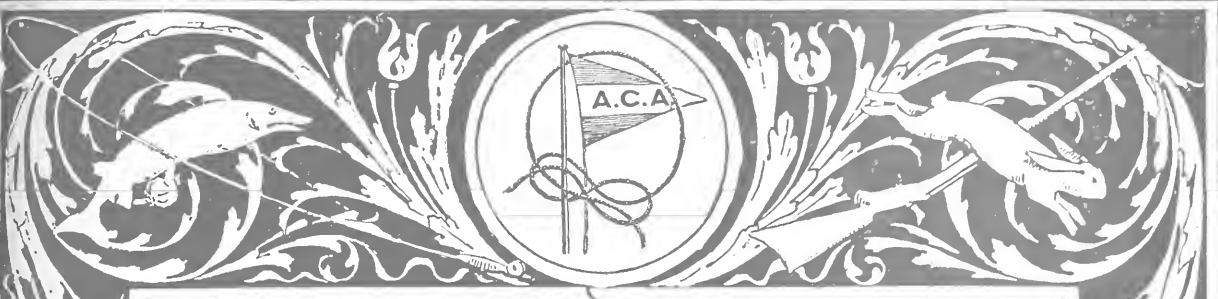

PHOTO BY JENNESS RICHARDSON, FOR MR. W. T. HORNADAY  
HEAD OF LIVE GRAY FOX

PUBLISHED BY G. O. SHIELDS (COQUINA)  
19 WEST 24TH ST. NEW YORK

OFFICIAL ORGAN OF THE AMERICAN CANOE ASSOCIATION

HAROLD BROWN

Actual Paid and Proven Circulation 50,000 Copies a Month

# SEN-SEN

THROAT EASE and  
BREATH PERFUME ~

Good for Old and Young

At all dealers or  
sent on receipt of  
5 cents in stamps

SEN-SEN Co.,  
Dept Q.  
ROCHESTER, N.Y.

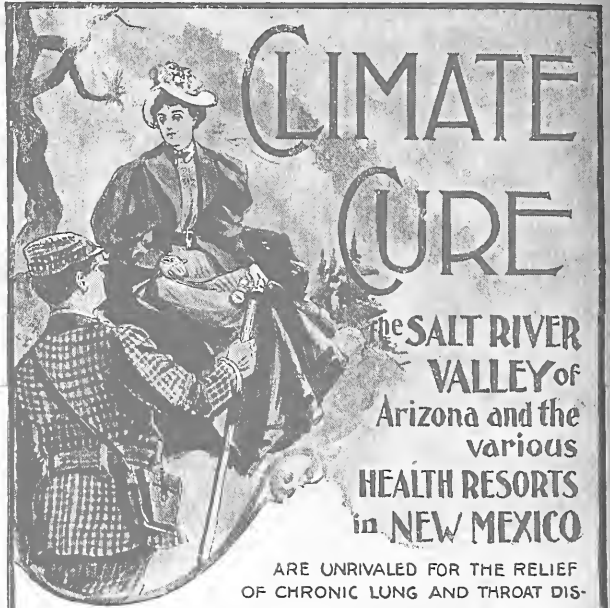

# CLIMATE CURE

the SALT RIVER  
VALLEY of  
Arizona and the  
various  
HEALTH RESORTS  
in NEW MEXICO

ARE UNRIVALED FOR THE RELIEF  
OF CHRONIC LUNG AND THROAT DIS-  
EASES. HERE ARE FOUND PURE DRY AIR,  
EQUABLE TEMPERATURE AND CONSTANT SUNSHINE.  
THE ITEMS OF ALTITUDE, TEMPERATURE, HUMIDITY, HOT SPRINGS  
SANATORIUMS, COST OF LIVING, MEDICAL ATTENDANCE, SOCIAL  
ADVANTAGES, ETC., ARE CONCISELY TREATED IN DESCRIPTIVE  
PAMPHLETS ISSUED BY THE SANTA FE ROUTE  
PHYSICIANS ARE RESPECTFULLY ASKED TO PLACE THIS  
LITERATURE IN THE HANDS OF INVALIDS.

ADDRESS W.J. BLACK,  
G.P.A., A.T. & S.F. RY.,  
TOPEKA, KANSAS.

OR C.A. HIGGINS,  
A.G.P.A., CHICAGO.

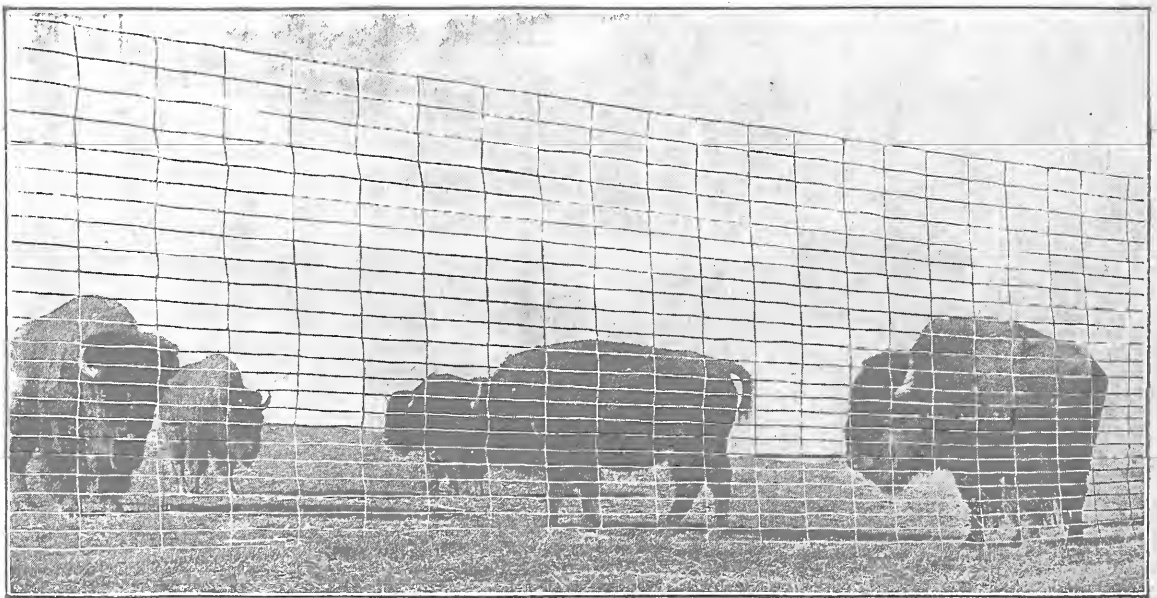

STOP THE GAME!!! KILL THE UMPIRE?

**NO!**

Simply build a PAGE FENCE around the premises and  
you've got 'em. No obstruction to the view. Holds  
Buffalo, Deer, Elk, anything.

Write for Particulars . . . .

PAGE WOVEN WIRE FENCE CO.

ADRIAN, MICH.

# RECREATION

Copyright, December, 1896, by G. O. Shields

A Monthly Magazine Devoted to Everything the Name Implies

\$1.00 A YEAR.  
10 CENTS A COPY.

G. O. SHIELDS (COQUINA),  
Editor and Manager.

19 WEST 24TH STREET,  
NEW YORK.

## CONTENTS OF THIS NUMBER

|                                                  | PAGE                           |
|--------------------------------------------------|--------------------------------|
| "Lumbering Away Across the Bench Land.".....     | Frontispiece                   |
| A Ram and Some Grizzlies. Illustrated.....       | HON. L. A. HUFFMAN 423         |
| A Rangeley Vacation. Illustrated.....            | C. J. HALPEN 425               |
| Among Iowa Quails. Illustrated.....              | E. A. JOHNSON 427              |
| "At Sea." (Poem) Illustrated.....                | ETHEL BROWNING 430             |
| Watching. Illustrated.....                       | E. W. ROBINS 431               |
| Chico. Illustrated.....                          | B. C. BROOME 436               |
| Hunting with a Camera. Illustrated.....          | W. E. CARLIN 441               |
| The Timmer-Doodle. Illustrated.....              | E. S. THOMPSON 445             |
| Where are the Wild Pigeons?.....                 | STANLEY WATERLOO 451           |
| "Hog Killin'." (Poem).....                       | W. H. NELSON 454               |
| A Cart Load of Geese. Illustrated.....           | J. F. 455                      |
| Elkland, IV. Illustrated.....                    | E. S. THOMPSON 456             |
| Cayuga Lake Coons.....                           | LOU SMITH 457                  |
| Pierre's Stratagem.....                          | H. D. LEADBETTER 458           |
| The Wolf Question.....                           | W. A. CAMERON and R. HOWES 460 |
| A Remarkable Shot.....                           | HON. W. A. RICHARDS 464        |
| For a League of American Sportsmen.....          | 465                            |
| Arrest of a Navajo Indian Murderer.....          | LT. E. H. PLUMMER 469          |
| My First Buffalo.....                            | CONRAD HANEY 472               |
| Woodcock and Snipe in Nova Scotia.....           | H. AUSTEN 474                  |
| Our Alaskan Exploring Expedition.....            | A. J. STONE 476                |
| Canvasbacks and Terrapin.....                    | COL. FRED MATHER 478           |
| The Successful Rearing of English Pheasants..... | PERCY SELOUS 480               |
| Canoe Sketches, II.....                          | E. L. COLE 481                 |
| On White River.....                              | J. M. CAMPBELL 483             |
| Up Mount Katahdin.....                           | F. S. CRABTREE 484             |
| From the Game Fields.....                        | 485                            |
| Fish and Fishing.....                            | 493                            |
| Guns and Ammunition.....                         | 497                            |
| Natural History.....                             | 502                            |
| Editor's Corner.....                             | 506                            |
| Publisher's Department.....                      | 507                            |
| Bicycling.....                                   | 508                            |
| Canoeing.....                                    | 510                            |
| Book Notices.....                                | 515                            |
| Amateur Photography.....                         | 517                            |
| Puzzle Corner.....                               | xxvii                          |

Entered as Second-Class Matter at New York Post-Office, Oct. 17, 1894.

*A Christmas-tide Suggestion.*



[PHOTOGRAPHED EXPRESSLY FOR SOZODONT.]

# Sozodont

Always suggests a smile and a row of pretty teeth, for it makes both possible. You cannot have them perfect if you neglect to use a perfect dentifrice. Sozodont is that because it presents both the liquid and the powder together and is absolutely wholesome.

*Miss Studholme says:—*"A smile is as good as a song, and a smile is enhanced if the teeth are pretty, for pretty teeth are part of an actress's stock in trade—and so is Sozodont, for it makes pretty teeth, as I can most heartily testify."

For a sample send three cents, mentioning this Magazine, to

HALL & RUCKEL, Proprietors,  
New York.

Established 1848.

LONDON OFFICE, 48, Holborn Viaduct.

# GAS ENGINE & POWER CO.

and **CHARLES L. SEABURY & CO.,** Builders of

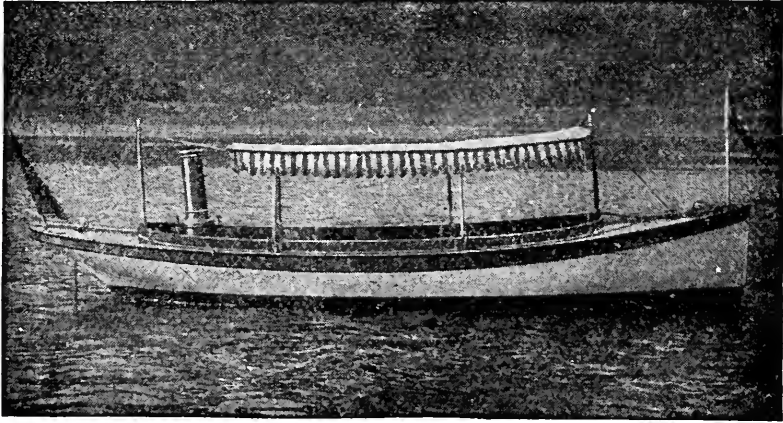

## The Only Naphtha ...Launch...

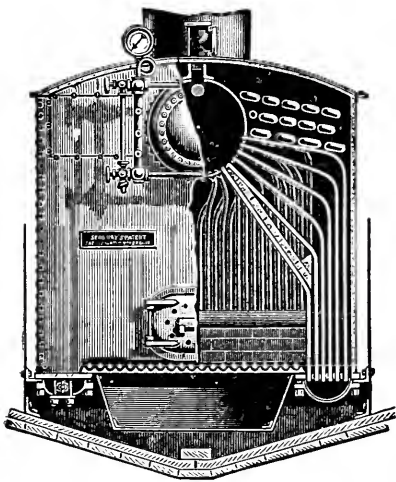

Our Patent Tubulous Boiler  
for Steam Yachts

High-class Steam Yachts  
Sail Yachts  
Electric Launches  
Dinghys  
Gigs and Yacht Tenders  
Seabury's Water Tube Boilers  
Marine Engines

Storage Basin and Ship's ways. Overhauling of  
all kinds promptly done. Charters and Insurance.  
Boats bought and sold on commission . . . .

CORRESPONDENCE  
SOLICITED . . . .

Send ten cents in stamps for catalogues to downtown office.  
50 BROADWAY, or to factory at

MORRIS HEIGHTS, New York City





BEFORE

# Savage

## THE Big-Game Killer

Leg of an animal before and after being shot with an expanding bullet cartridge fired from a .303 Caliber . . .



AFTER

## Savage Repeating Rifle



BEFORE

THE BULLET

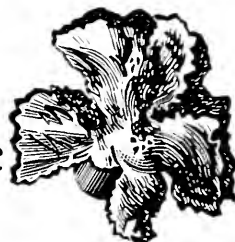

AFTER

Catalogue on Application.

SAVAGE REPEATING ARMS CO., Utica, N. Y.

**YOU MUST USE THIS TO EQUAL IT**

**FEHR'S TALCUM POWDER**  
 is the only original. Don't accept any substitute. Beware of any Talcum Powder put up in tin boxes, as there is danger of lead poisoning. See that you get the best. Manufactured only by  
**JULIUS FEHR, M.D., HOBOKEN, N. J.**

"Adds 50 per cent. to the relish of any meal of which it forms a part."



If your grocer cannot supply you, write us for priced catalog and souvenir, descriptive of our full line Canned Fruits, Vegetables, Meats, Preserves, Jams, Jellies, etc. **CURTICE BROTHERS CO., Rochester, N. Y.**

TAKE A.....

# Marlin Repeater

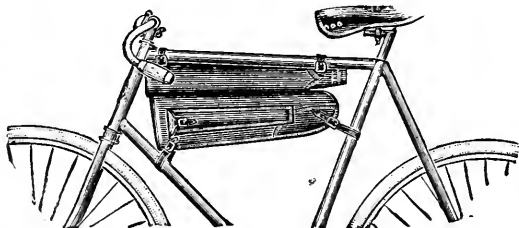

MODEL 1897

on your

.... BICYCLE

We make it with 16-inch barrel, expressly to fit your diamond frame  
Weight only 5 lbs. We have the proper covers also.

This 22-  
Calibre  
Repeater

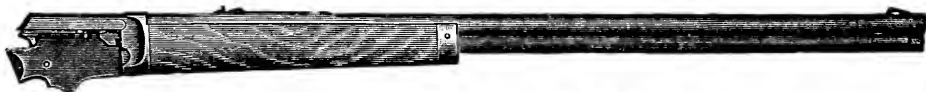

is  
Universally

Conceded

to  
be **THE BEST**  
**BECAUSE....**



Cut Showing Rifle Apart



One rifle uses 22 short, 22 long, and 22 long rifle cartridges

The receiver is made of our "Special Smokeless Steel"

The working parts are all of crucible tool steel

The inside is finished and polished as well as the outside

The breech-bolt takes out so you can clean your barrel

The side ejection is a good thing. Ballard barrels

shoot straight

The rifling is to a rifle what choke is to a shot gun  
Good deep rifling is one reason why they shoot harder

EASY TO CLEAN

TAPER BARRELS

ADJUSTABLE SIGHTS

We will mail to any address, free, a 192-page book (just out) which is a veritable mine of information to a sportsman

Send stamps, to pay postage, to

## THE MARLIN FIRE ARMS CO.

Mention RECREATION.

New Haven, Conn.

# The Model 1893

is the rifle using the 30-30 Smokeless Cartridge. This cartridge as made for our rifle is loaded with 32 grains of Military Smokeless Powder, giving a velocity of 2,000 feet per second, a full 2,000, not 100 or so less. This, with our flat pointed bullet, makes as accurate a 30 calibre cartridge as can be loaded, and also one without a superior for hunting purposes.

## THESE ARE THE FACTORY CARTRIDGES



Full Metal Cased Bullet  
For Extreme Penetration

Soft Pointed Bullet  
(For Hunting Use)



Six grains of  
smokeless pow-  
der 100-grain  
bullet



For Short Ranges

The Barrel and Action of this rifle are made of our

## Special Smokeless Steel

guaranteed to stand the highest pressure. We also use this steel in all the rest of our Model 1893 Rifles, viz., 25-36 Smokeless, 32-40 and 38-55, and also in the Model 1895 taking the 38-56, 40 and 45 calibre cartridges. We are determined to have our rifles just as strong and safe as good material can make an arm.

Our new catalogue is a veritable encyclopaedia of information regarding rifles, ammunition, etc. Free for the asking, but stamps will help pay postage.

## THE MARLIN FIRE ARMS CO.

New Haven, Conn.

Mention RECREATION.



A SALESMAN  
of the . . . .  
HARDERFOLD  
HYGIENIC  
UNDERWEAR  
is met by this  
query :

Why this gar-  
ment is double!

Yes, that is the  
characteristic fea-  
ture of the . . . .

HARDERFOLD  
goods. They are  
made two-fold  
throughout, which  
creates an inter-air

space and makes them the only genuine  
sanitary underwear manufactured. The  
two thicknesses serve to protect the wearer  
from sudden chills or draughts.

There is no irritation to the wearer because  
the interior of the garment is as smooth as  
the exterior, besides they won't shrink in  
laundering.

Over eleven hundred physicians, representing  
every State and Territory in the Union, have united  
in testifying to the sanitary excellence of the HAR-  
DERFOLD system of underclothing. Two or more  
thin fabrics are lighter, warmer and in every way  
better than heavy single fabrics.

For illustrated catalogue, address

**HARDERFOLD FABRIC CO.,**  
TROY, N. Y.

# ROOT'S

## Camel Hair Underwear

Made only from Finest Fleeces, clipped from  
the Living Sheep, Lamb or Camel.  
A soft but effectual armor against the climate;  
the best security against Grippe, Colds and Rheu-  
matism. Perfect in fit and workmanship. Ask  
your dealer for it. Every garment stamped  
"Root's Tivoli Standard Underwear."  
Write for illustrated booklet.

**ROOT MFG. CO., No. 1 Greene St., N. Y.**

# ROOT'S

## Natural Wool Underwear

ROOT'S  
TIVOLI  
STANDARD  
UNDERWEAR  
TRADE MARK

Savoy Columbia

*"Silver  
Plate that Wears."*

Made in artistic and original  
patterns only. Your silverware  
will be correct in every way if it is

# "1847 Rogers Bros."

Made only by  
**THE MERIDEN BRITANNIA Co.,**  
Meriden, Conn.  
208 Fifth Ave., New York.

*Sold by leading dealers  
everywhere.*

Vesta

Berksire

Berksire

# GRAND HOLIDAY MAGAZINE OFFER

In order to introduce **The Peterson Magazine** more fully to the readers of RECREATION, The Peterson Company, 244 Stewart Building, New York, will send their magazine for 1898 and continue your subscription to RECREATION one year for only **one dollar and a half**. This offer is unprecedented even in this era of cheap reading, and for liberality, attractiveness, and genuine value for the money has never been surpassed.

**The Peterson Magazine** has been published continuously for sixty years. It contains one hundred pages a month of the choicest family literature, admirably illustrated, printed on fine paper, with an attractive cover in color. These two publications (PETERSON and RECREATION) will supply every need of a family for reading-matter.

## RECREATION AND PETERSON

BOTH  
ONE YEAR  
FOR

# \$1.50

**Two Months Free.** Send your subscription promptly, and THE PETERSON MAGAZINE will be sent free for the months of November (Thanksgiving Number) and December (Christmas Number)—thus giving you 14 months of a dollar magazine and a whole year of RECREATION for only one dollar and a half.

## CONTRIBUTORS TO PETERSON FOR 1898

Representative work of the most prominent writers of the day will appear in the pages of THE PETERSON MAGAZINE during the coming year. Stories by the following authors are now in hand or arranged for:

Octave Thanet

Mary E. Wilkins

Ian Maclaren

Mrs. Burton Harrison

Amelia E. Barr

Clinton Ross

Stephen Crane

Sarah Orne Jewett

Frank R. Stockton

Gilbert Parker

Frances C. Baylor

S. R. Crockett

In addition to the above the articles on American topics will be continued, and will be of surpassing interest. Two series recently began on "American Inventions and Inventors" and "Great American Orators." Every member of the family will profit from a perusal of these articles. It is this strongly American spirit that has made THE PETERSON regarded as the representative American magazine.

**Read Carefully** This offer is open to new or old subscribers. If you are already receiving RECREATION, your subscription will be continued for one year. The two publications may be sent to different addresses if desired. Sample copy of THE PETERSON MAGAZINE, 6 cents in stamps. Remit by Registered Letter, Money Order, or New York Draft.

Don't delay. Write to-day. You'll never regret it. For New York City send us 25 cents extra on account of extra postage. **The price of Recreation is invariably one dollar**, which under all circumstances must be paid for RECREATION, but to obtain new subscribers The Peterson Co. has decided to make this unprecedented offer. Show your appreciation by sending one extra new subscriber to both journals when remitting your own subscription. Note the liberal combination offers with other journals made in this advertisement. If not what you want, send us a list for low prices.

ADDRESS, IN EVERY CASE

## OTHER OFFERS

|                            | Pub. Price | Our Price for Both. |
|----------------------------|------------|---------------------|
| Cosmopolitan.....          | \$1.00     | \$1.50              |
| McClure's Magazine.....    | 1.00       | 1.50                |
| Munsey's Magazine.....     | 1.00       | 1.50                |
| Leslie's Popular Monthly.. | 3.00       | 3.00                |
| Scientific American .....  | 3.00       | 3.25                |
| Scribner's Magazine .....  | 3.00       | 3.25                |
| Wom. Home Companion ...    | .50        | 1.00                |
| Godey's Magazine.....      | 1.00       | 1.50                |

We can save you money on any publication in combination with PETERSON.

THE PETERSON COMPANY

244 Stewart Building, New York

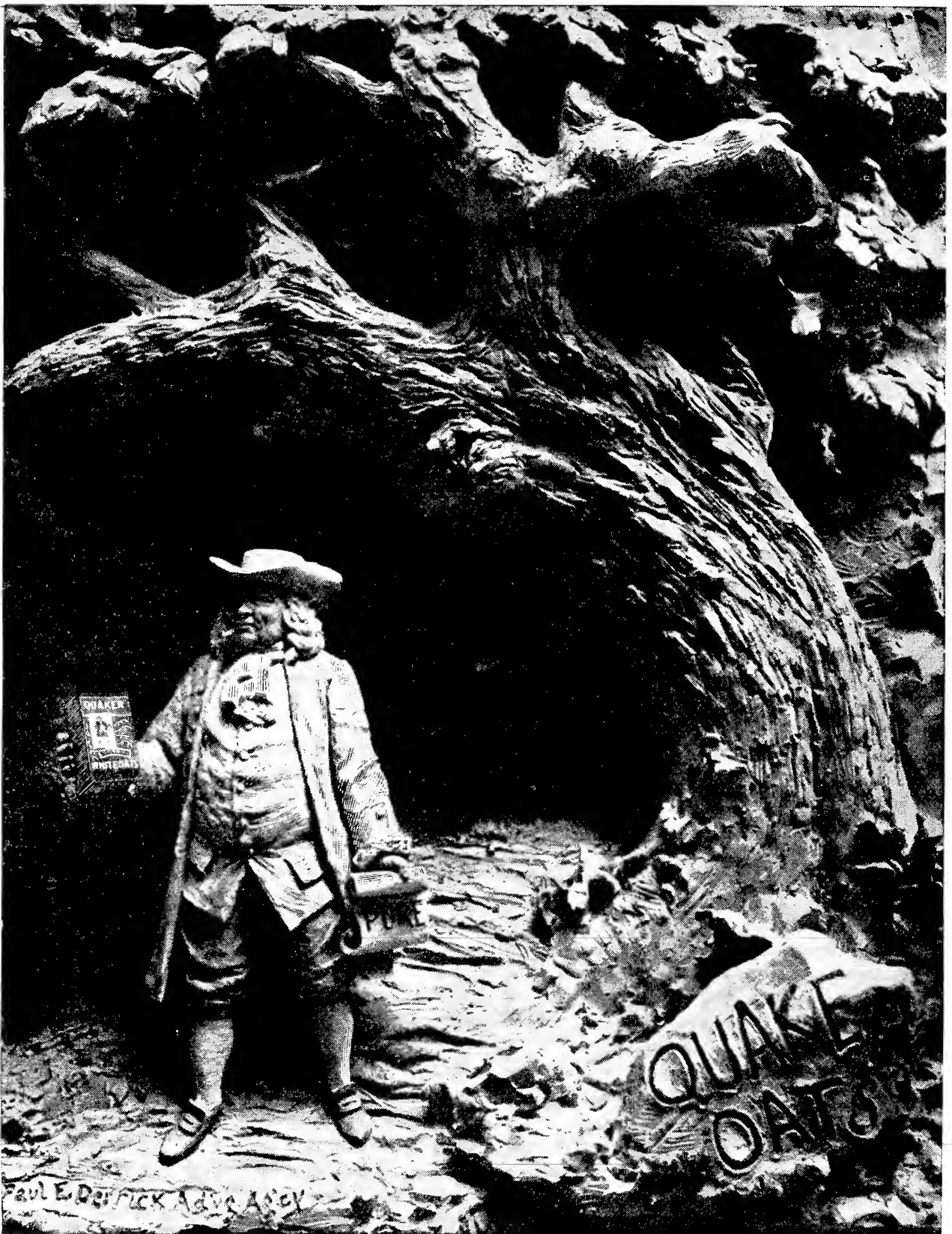

Strong and serene, as mighty forest tree  
That braves the blast and dares the storm, is he  
Who wisely lives, and living, learns to know  
The health and strength which Quaker Oats bestow.

AT ALL GROCERS IN 2-LB. PACKAGES ONLY.

# SCOTT'S EMULSION



OF  
COD LIVER OIL

## Persistent Coughs

A cough which seems to hang on in spite of all, certainly needs energetic and sensible treatment.

### SCOTT'S EMULSION OF COD-LIVER OIL

has, for twenty-five years, proved its effectiveness in curing the trying affections of the throat and lungs. The cod-liver oil, partially digested, strengthens and vitalizes the whole system; the hypophosphites act as a tonic to the mind and nerves, and the glycerine soothes and heals the irritation. Can you think of any combination so effective as this?

Be sure you get SCOTT'S Emulsion. 50c. and \$1.00, all druggists.

BINNER CHICAGO

# A TREASURE OF THE DEEP.

# GRAM-O-PHONE

## FOR CHRISTMAS

**NOTHING** in the whole range of Christmas Gifts combines so many elements of surprise, delight, and lasting satisfaction as the **GRAM-O-PHONE**—

The only Talking, Singing, and Music-making machine which *doesn't* merely imitate, but actually reproduces the quality of tone, distinctness of utterance, and every modulation of the originals, and having indestructible records.

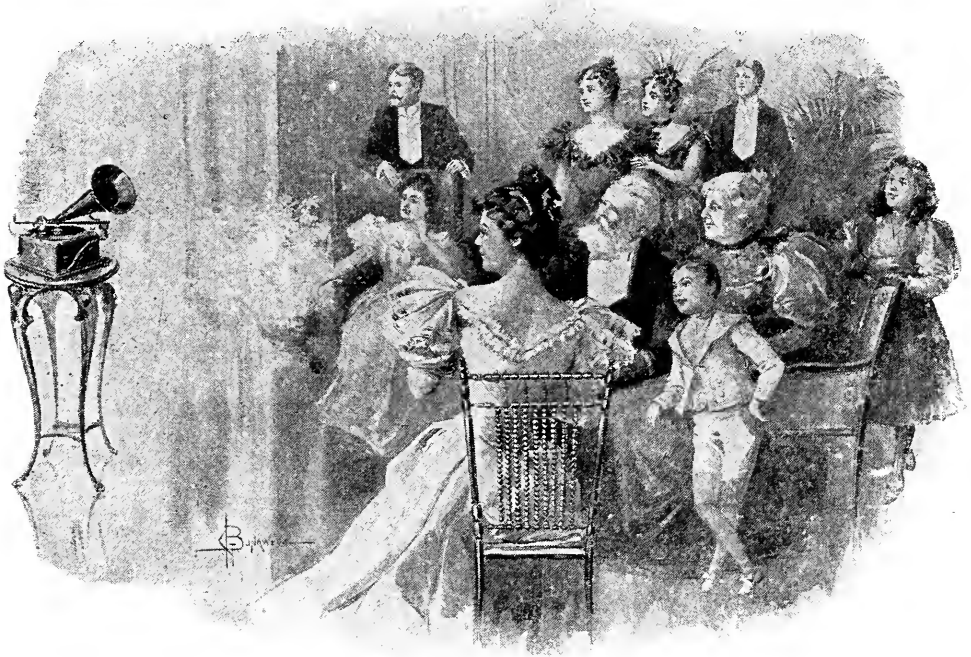

Not only a cornet, a trombone, a piano, and a banjo, but performances upon these and many other instruments by their respective masters.

You command Sousa's band at will.

You can listen to an aria from the opera, a "turn" at a music-hall, or a song at a camp-meeting, according to your fancy.

No matter how remote your habitation, it brings within the family circle the actual voices of orators, singers, funny-men, and story-tellers who perhaps at that very moment are delighting metropolitan audiences with the same eloquence, melody, humor, and dialect that is coming from the **GRAM-O-PHONE** in the quiet of a country home a thousand miles away.



There is, in fact, no form of entertainment addressed to the ear which cannot be reproduced upon the GRAM-O-PHONE.

And reproduced successfully.

For it should be understood by all that the GRAM-O-PHONE is an entirely new process which only reached its present state of perfection the past summer, and its superb reproductions should not, for a moment, be confounded with the indistinct and feeble imitations of other methods.

It is the only sound-reproducing instrument which, by actual test, has been heard in every part of the New York Metropolitan Opera-House ;  
The only one on which high C is satisfactorily reached ;  
The only one that " talks talk."



INDESTRUCTIBLE RECORD

**UNSOLICITED ENDORSEMENT.**

*Largest circulation of any weekly Presbyterian paper in the world.*

Chicago, October 14, 1897.

NATIONAL GRAMOPHONE CO., 874 Broadway, New York City.

*Gentlemen:*—The Gramophone which we secured from you has more than exceeded our expectations. We were much surprised and pleased with the clearness of the tones, and the volume as well, which is sufficient to fill an ordinary-sized hall or church. We can heartily recommend it to be all that you claim for it.

Yours, very truly,

THE INTERIOR.

Much of the value of the Gram-o-phone lies in its marvelous simplicity, because of which it is not only easily operated and kept in order, but instead of costing \$100 or more, like the earlier and inferior inventions, the new model, spring motor, sells for TWENTY-FIVE DOLLARS, express paid, with handsomely finished quartered-oak case, nickel trimmings, perfected speed regulator, latest Exhibition Sound-Box, large sound amplifier, two hundred needle-points, and two new-process records to be selected by customer. Extra records 60c. each or \$6 per doz.

PERFECT SATISFACTION GUARANTEED, or machine can be returned immediately, and money will be refunded, less express charges. Other styles for \$10 and \$15. SEND FOR CATALOGUE.

**NATIONAL GRAMOPHONE CO., 874 Broadway, New York**  
53 Washington Street, CHICAGO 136 Boylston Street, BOSTON



# What's the Use

of walking when you can get a first-class, high-grade bicycle for nothing?

## How?

By getting 75 subscriptions for

## Recreation

If you live in a town of 3,000 or more, and if you are a hustler you can get these in 2 days.

I can give you the names of 20 people who did this in 1896, and who now have their wheels.

Write for particulars.

## RECREATION

19 West 24th Street  
New York



# Florida! MID-WINTER SUN BATHS

## NASSAU BATHING EVERY MONTH IN THE YEAR

Sailings Mondays, Wednesdays, and Fridays, at 3 P.M., from Pier 29, East River, New York

### ....SUPERIOR STEAMSHIPS....

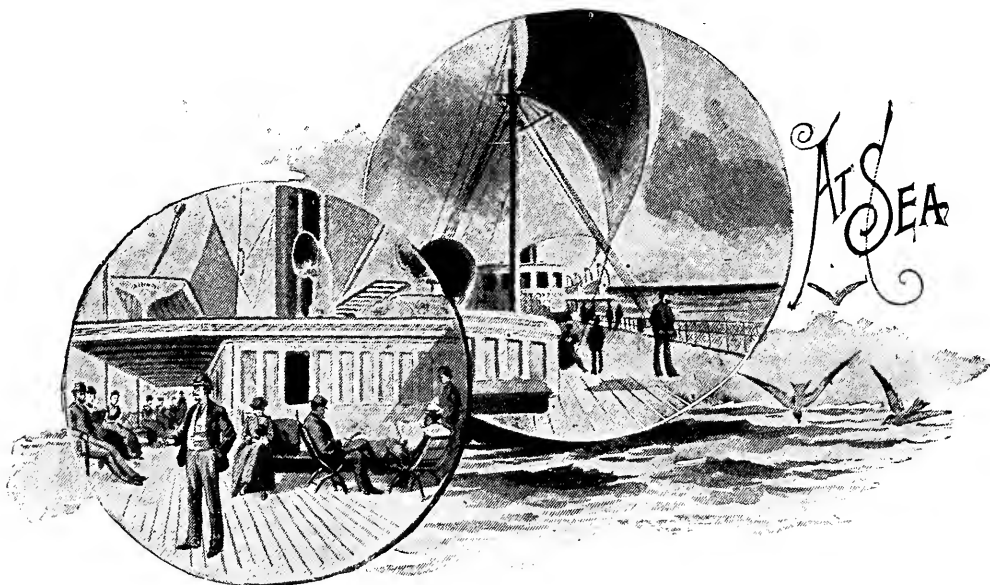

Comanche, Iroquois, Algonquin, Seminole, and Cherokee

To Charleston, S. C. and Jacksonville, Fla. **Without Change** Making Close Connection

### FOR ALL POINTS SOUTH AND SOUTHWEST

Tickets include meals and stateroom berth, thus affording a trip via this line at about 40 per cent. less cost than via rail.

### Safety! Comfort! Quick Time! Low Rates!

..... UNSURPASSED CABIN ACCOMMODATIONS .....

### CUISINE THE VERY BEST

Clyde's St. John's River Line (De Barry Line), the popular route between Jacksonville, Palatka, Enterprise, Sanford, and intermediate landings.

Write us for rates, sailing schedules and

### Beautifully Illustrated Booklet

**THEO. G. EGER**  
Traffic Manager

**W. H. HENDERSON**  
G. E. P. A.  
5 Bowling Green, New York City

**W. H. WARBURTON**  
G. T. P. A.  
City

**A. P. LANE**  
N.E.A., 201 Washington St.  
Boston, Mass.

**WM. P. CLYDE & CO., General Agents**

5 Bowling Green, New York

12 So. Delaware Ave., Philadelphia, Pa.

# MENNEN'S BORATED TALCUM



# TOILET POWDER

AFTER  
BATHING

Mennen's  
Borated  
Talcum  
Toilet  
Powder

The only Talcum Powder  
with a

**National  
Reputation**

as a perfect Toilet requisite.

This trade-mark on box cover is a  
guarantee of **absolute purity.**

Take no substitutes which are likely to  
do harm.

For sale everywhere, or mailed on  
receipt of 25 cents. (Free sample.)

**GERHARD MENNEN  
CHEMICAL COMPANY**  
NEWARK, N. J.

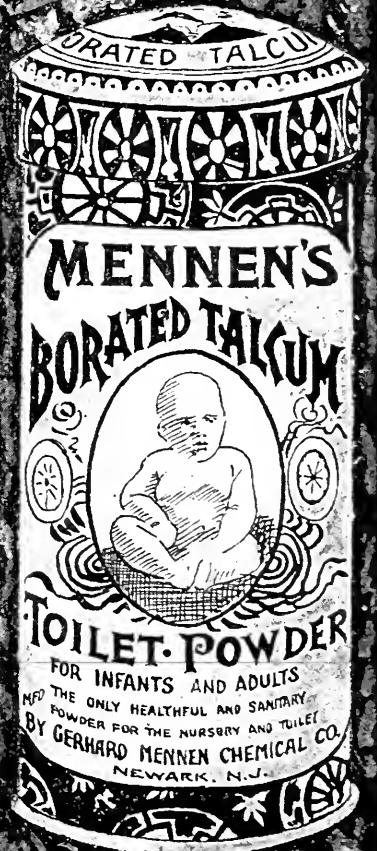

WAGSTAFF & CO. N. Y.

# Sportsmen's Cabinets

## as Christmas Presents

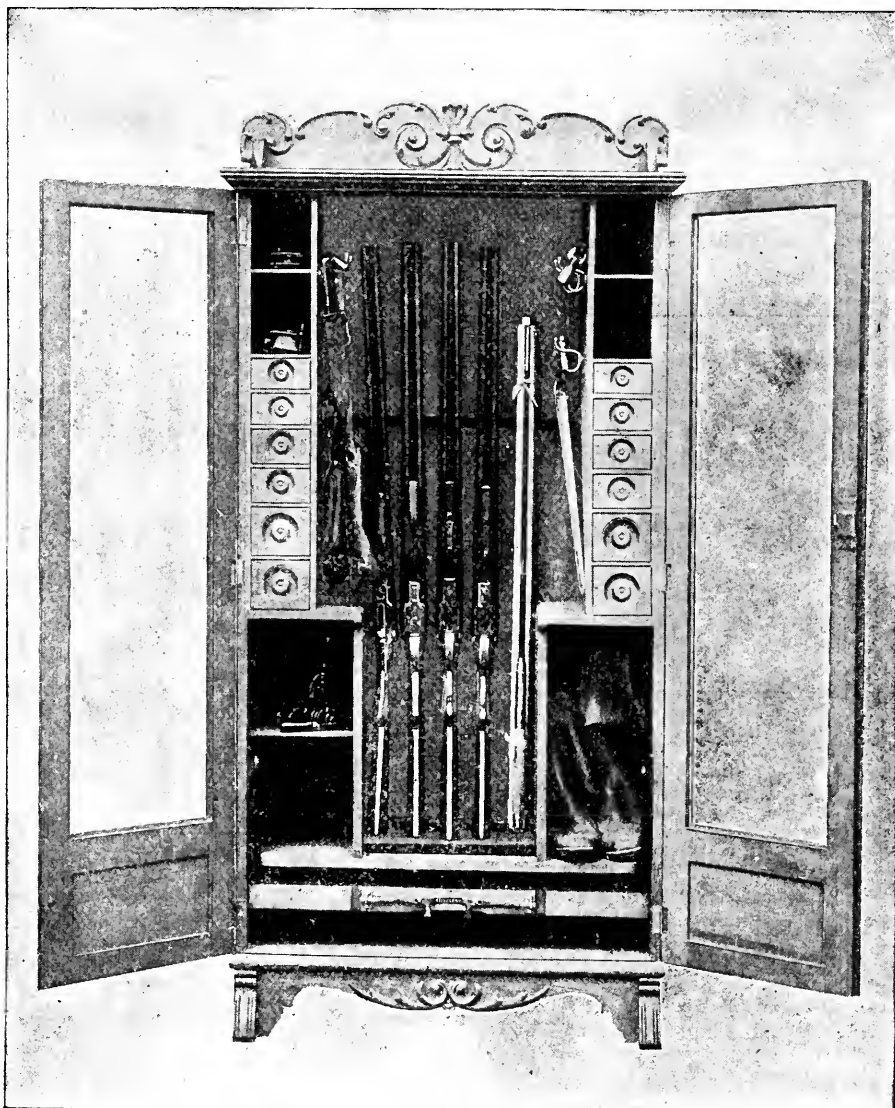

**A MOST USEFUL ARTICLE FOR ANY SPORTSMEN  
A REALLY BEAUTIFUL PIECE OF FURNITURE**

**Last year at this season we sold more of them than we could make.  
This year we can supply all orders promptly.**

These elegant cabinets are made of quarter sawed antique oak, top and bottom handsomely carved, all parts hand-polished—double thick glass doors. A special feature is a strong folding table, which locks automatically when raised, and can be used as loading-table or writing-desk.

The Cabinet stands 6 feet high, 31 inches wide, and 12 inches deep. Nearly 500 of them have been sold and everybody satisfied. Price, crated, f. o. b. New York, **\$35.00 net**. Special sizes made to order.

**HENRY C. SQUIRES & SON, 20 Cortlandt St., New York**

# Dr. Paul's Egg White Soap

**Nothing Else  
Like It . . .**

Soothing to face and hands; makes the skin like velvet, the ingredients being the sweetest and purest obtainable, and selected under the direction of a noted skin specialist. *Leaves a sweet, refined odor, best French perfumes being used; and, owing to its solidity, will outlast two cakes of ordinary soap.*

Sold at the popular price of **Ten Cents** by dealers everywhere.

**FREE** sample cake to any one sending name and address and 2c. stamp for postage. *Full-size cake sent on receipt of 10 cents. Send us your dealer's name and we will see that he keeps it.* Don't fail to try it.

One Doz. Cakes **\$1.00**, Express Paid

**CHARLES F. MILLER**  
LANCASTER, PA., U.S.A.  
NEW YORK, 73 Murray St.  
BOSTON, 189 State St.  
PHILADELPHIA, 45 N. Front St.

**Made with WHITES of EGGS and SWEET CREAM**

## CASH PRIZES FROM \$5.00 TO \$250.00

Are given TO ALL OR ANYONE who can supply the MISSING LETTERS in the following eight words or ANY THREE OF THEM

|                                                 |                                                |
|-------------------------------------------------|------------------------------------------------|
| For correct answer to any THREE words - \$ 5.00 | For correct answer to any SIX words - \$ 50.00 |
| For correct answer to any FOUR words - 10.00    | For correct answer to any SEVEN words 100.00   |
| For correct answer to any FIVE words - 15.00    | For correct answer TO ALL the words - 250.00   |

**PUT LETTERS IN PLACE OF SIGNS AND COMPLETE THE WORDS GIVEN BELOW**

- 1-L † † E † Y—Appropriate when reference is made to gentler sex.
- 2-T † B † † CO—An article used by both sexes.
- 3-† E † L † US—A disposition particularly manifested by women.
- 4-† † DN † SS—A merciful attribute that should be possessed by all.
- 5-R † LI † † † †—Every person should experience and cultivate.
- 6-B † DS † † A †—Useful in any house, especially sleeping-rooms.
- 7-C † LL † † † N—Something which all should try to avoid.
- 8-L † † DS † † E—A work of nature that appeals to the sight.

**REMEMBER** You are to put a letter in place of each star thus forming a complete word. If you succeed in making only three correct words you will receive \$5. If you succeed in making all of the words, you receive \$250. It does not depend upon the chance of being first. One living in Maine or California is on an equality with one in New York City. Time or distance makes no difference. This offer contains no element of chance or lottery and conflicts with no law. It is a study in words; an educational and instructive pastime for all who enter it regardless of the Cash Presents we give for a little work. Each successful contestant receives a cash reward for his (or her) labor of from \$5 to \$250. Prizes promptly paid. Mention when you send your list of words how you want prize money sent.

**CONDITIONS.** The only conditions are that in order to compete on four words, you must send 25 cents for a three months' subscription to The National Homestead Magazine. Send the four words (any four of the eight you choose), when you send your subscription and 25 cents. If you want to compete on all of the eight words, you must send 50 cents for a six months' subscription. Number each word to correspond with numbers above.

**OBJECT.** The National Homestead Magazine is not a cheap publication; its merit is conceded. With a circulation of 200,000 monthly its advertising revenue is worth to us \$150,000 yearly. We can therefore afford to expend a large portion of this amount in securing an additional 100,000 yearly subscribers because not only is that revenue good for a year, but for years to come. The magazine is nicely illustrated, beautifully printed, and bound with a handsome cover.

**EXTRA PRESENTS.** In addition to any cash prize which may be won, we promise all six-month subscribers an extra and valuable present worth many times the subscription money.

**AS TO OUR RESPONSIBILITY.** We refer to any bank or mercantile agency in New York City. We pay prizes promptly and honestly, and to assure you of this we shall invite three representative men from New York newspapers to make the award and see that all are treated fairly. We also agree to refund money to any dissatisfied subscriber at any time. Can we do more? Here is a chance to secure cash for a little study. The correct and complete list of words has been deposited with a well-known New York attorney and notary public under his official seal and not to be opened until this contest closes, in presence of witnesses. Complete lists of the correct words and winners' names will be printed in our magazine. If already a subscriber your subscription can be extended. No notice taken of letters that do not contain subscription money. Address

**NATIONAL MAGAZINE PUB. CO , 206-208 Broadway, New York**



## Just the Thing for Papa!

He will get more comfort from one of **Williams' Shaving Sticks**, or from a **Luxury Shaving Tablet**, or a cake of the famous old **Yankee Shaving Soap**, than from anything else you could possibly give him for Christmas.

You know how it tries a man's patience to shave, unless everything is exactly right. Ordinary Shaving Soaps are never right, nor anywhere near it. They make a man cross and pudgky, and set his nerves on edge.

Don't go near a man when he is shaving, unless he uses

# Williams' Shaving Stick

OR SOME FORM OF WILLIAMS' SOAP.

The rich, creamy lather of **Williams' Soap** soothes, comforts and refreshes, and makes him smile all over. **Williams' Soaps** are the only shaving soaps that thoroughly soften the beard, and make shaving what it should be—easy, safe and agreeable. They are the recognized standard all over the world.

**WILLIAMS' SOAPS—in principal forms—sold by dealers everywhere.**

**Williams' Shaving Stick, 25c.**

**Luxury Shaving Tablet, 25c.**

**"Genuine Yankee" Soap, 10c.**

**Williams' Shaving Soap (Barbers).**



Round—just fits the cup.  
Perfume delightful.



Oldest and most famous cake of shaving soap in the world.

*NOTE.—If your dealer fails to supply you, we mail these soaps to any address, post-paid, on receipt of price.*

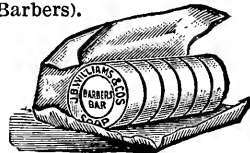

This is the kind your barber should use. Exquisite also for toilet and bath. Used in thousands of the best families. Six cakes in package, 40c. Trial sample for 2-cent stamp.

Address **THE J. B. WILLIAMS COMPANY,**  
Glastonbury, Conn., U. S. A.

LONDON: 64 Great Russell Street, W. C.

SYDNEY, Australia: 161 Clarence Street



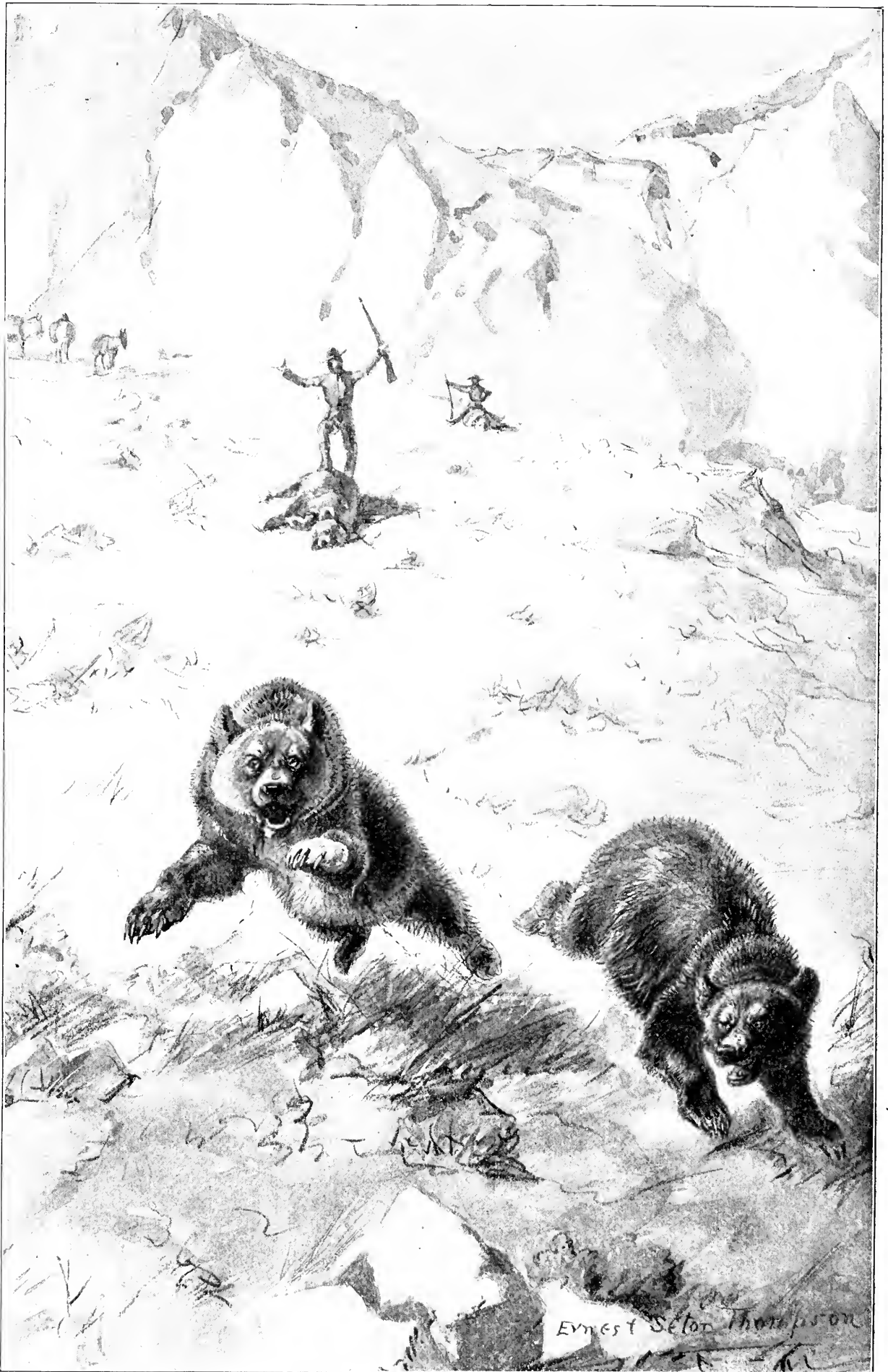

Ernest Seton Thompson

"LUMBERING AWAY ACROSS THE BENCH LAND."



# RECREATION.

Volume VII.

DECEMBER, 1897.

Number 6.

G. O. SHIELDS (COQUINA), Editor and Manager.

## A RAM AND SOME GRIZZLIES.

HON. L. A. HUFFMAN.

I have just read an article by "Syracuse" in which he says an animal shot through the heart will drop in his tracks. Long ago I would, like Syracuse, have thought Van Dyke's story of an elk running 100 yards—or any distance—after being shot through the heart, "fishy;" but 2 instances that came under my personal notice have convinced me that at least bears and mountain sheep will make a good many tracks, sometimes, after being pierced through the heart.

The first was the case of an old ram. Away back in the buffalo days, Joe Spence and I were crossing the Little Sheep mountains, between the Big Missouri and the Yellowstone. The climb was steep and we were leading our saddle animals and carrying our 45-120 Sharps, ready for trouble. When just at the notch where the buffalo trail then reached the summit, and where, to this day, the saddle trail dips toward the "Dad of Waters," we rested and made a search of the weird tangle of badland, buttes and gulches around us. We were looking for game and spying out the trail ahead.

There was no game in sight and we were about to remount, when, on the crest of a little round butte, just in front of us, up rose a noble old big-horn ram. One leap carried him out of sight, but not until each of us had taken a snap shot. Each turned to the other, and asked "Did you shoot?"

The canyon that is shown in the background of the photograph is

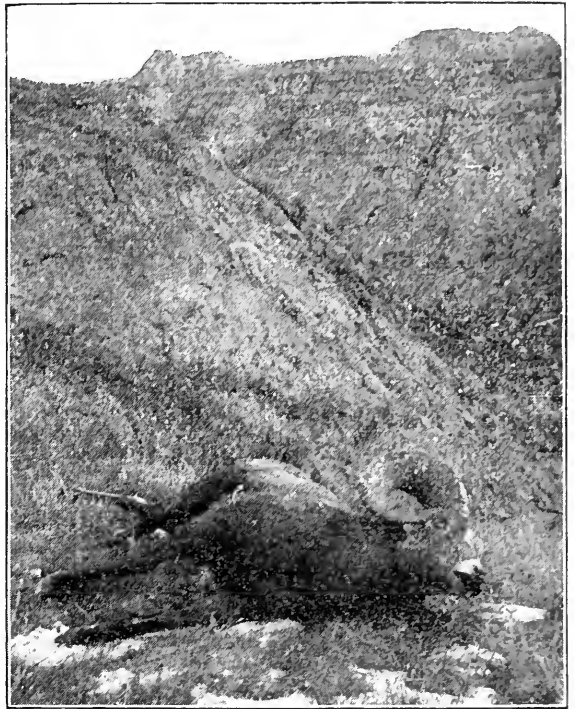

DOWN IN THE CANYON.

steep and rough. A man could scarcely cross it in half an hour, where that sheep plunged into it. We found him on top of the farther wall, stone dead, with more than an inch of the point of his heart torn off by the bullet, that had hit him back of the shoulder.

We had to wait for our wagon train to come up, and spent the time in dissecting and discussing what, to both of us, was a mystery—that the old turk had been able to find his way down into that gulch; but, stranger still, that he could climb out again, with such a wound as that.

\* \* \*

The other story is that of a bear, and is scarcely less remarkable. It was over on the big dry, in 1878. I was bringing a band of horses from the Northwest. The country was infested with hostile Indians and we travelled cautiously—early in the morning and late in the evening. On this particular morning, at daybreak, we were moving out of camp, when 2 of us, some distance ahead of the horses, ran foul of a whole family of bears—2 old ones and 2 well grown cubs.

They were making for the plums and choke cherries that grew in the breaks where we had camped.

It was against the rules of the outfit to shoot at anything but Indians; but this was too great a temptation to be withstood by any other than angels,

and we had not yet sprouted our wings.

Four bears, "wooh"-ing like fat hogs, as they crowded each other among the bowlders and sage brush, were just turning down the canyon. While we were waiting for the horses to come up, so we could explain that it was not Indians we had been shooting, we noticed one of the old bears who had escaped the hailstorm and who was lumbering away across the bench land, several hundred yards from where we started them. I said he would not run that way unless badly hurt; so I made a detour to see about it. I found him dead, with his heart cut through and through, by a 45 calibre bullet. That bear ran a good 300 yards, up a stiff grade, after the big slug went through him.

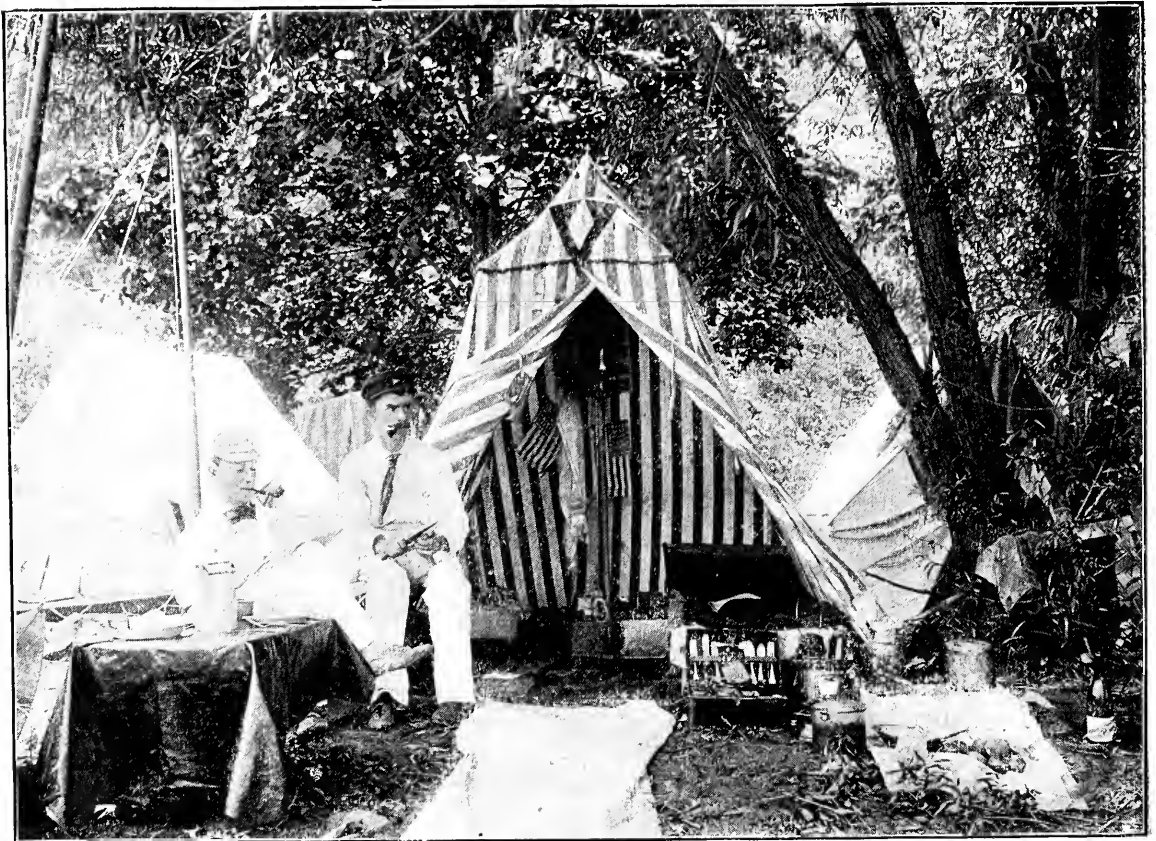

AMATEUR PHOTO BY WM. ALLEN.

THE PRETTY BOYS' CAMP AT EGG BEACH.

Highly Commended by the Judges in RECREATION'S Second Annual Photo Competition.

## A RANGELEY VACATION.

C. J. HALPEN.

Ye who love the haunts of nature  
Love the sunshine of the meadow,  
Love the shadow of the forest,  
\* \* \* \* \*  
And the rushing of great waters,  
\* \* \* \* \*

Listen!"

Far up in the Northwestern corner of the Pine Tree State, amid mountains clothed with forests primeval, lies the famous chain of lakes known as The Rangeleys. For generations these have been the resort of sportsmen, many of whom have,

Umbagog lake is 255 feet. With the exception of Rangeley, whose shores are bordered by rich farm lands, the entire region is clothed in dense forests, "where the wild cry of the loon is heard by night and the moose and the deer come down to drink."

It was on a beautiful morning in July that my wife and I left home for a camping trip of 2 weeks in the Rangeley region, our destination being Upper Dam, on Lake Mooselukmaguntic.

Leaving Haverhill, Mass., on the 9:30



AMATEUR PHOTO BY C. J. HALPEN.

WEST RICHARDSON POND, RANGELEY REGION.

in days gone by, cast their flies in the waters of other continents than ours. No inland fishing grounds are so widely and favorably known as the Rangeley lakes, which form a continuous water communication 50 miles in length and covering 123 square miles. The names of the lakes are: Oquossos, or Rangeley; Cupsuptic; Mooselukmaguntic; Molechunkamunk; Welokennebacook, and Umbagog. Bill Nye once said that were he to live his school days over again he should, whenever possible, write compositions on these lakes, because the names "fill up a page so beautifully."

The waters of Rangeley lake are over 1,500 feet above sea level, and the fall to

Pullman, we arrived in Bemis, the terminus of the R. F. & R. L. R.R. at 5:15 P.M. The station is built of logs, divested of bark and shell-lacked, the effect being thoroughly in keeping with the general surroundings. The building is the typical log cabin of the Maine woods. The only boards to be seen are in the floor and the roof, even the doors and the chairs being built of the same material as the walls, while massive fireplaces, at either end of the large waiting room, give to the whole an air of homely comfort. Mr. Ruel Taylor, the agent, is a thorough sportsman, genial and obliging.

Camp Bemis, on the shore, a short distance from the station, has long enjoyed an



AMATEUR PHOTO BY C. J. HALPEN.

#### WEST RICHARDSON POND AND MOUNT OBSERVATORY.

enviable reputation, and comprises a number of log cabins planned on a style of rustic elegance, types of the northland woods, full of comfort and good cheer.

We took the steamer Mooseluk for Upper Dam, 9 miles distant, arriving at 7 o'clock. The genial John Chadwick, for over 30 years in charge of the Upper Dam property, bade us a cordial welcome. Some of the guests who were there at the time of our visit have made annual trips for over 20 years. Among them were Mr. T. B. Stewart and son Douglass, of New York city, and Mr. J. C. Dougherty of the Natchaug Silk Co.

From the veranda of the hotel we are in view of both Mooselukmaguntic and Molechunkamunk, and facing the "Grand Old Pool," which forms the connecting link between them.

On either hand one sees  
"Pine sheltered shores that stretch 'neath  
Northern skies.

And under them a dreamy forest lies."

The Upper Dam was built in 1845-7 and is a massive structure of granite and timber. It cost \$300,000, is nearly a mile long, including wings, and has 21 feet head, to low water gates.

During our stay we had the good fortune to see 3 of the gates opened, owing to the high water, and were told that over 15,000 horse-power was running through, all wasted.

We stayed 2 days at the Upper Dam, and

then, having selected a suitable spot for camping, pitched our tent, ran up our little silk flag and were ready to receive callers.

We fished 2 days with indifferent success, taking a goodly number of trout weighing from  $\frac{1}{2}$  to  $1\frac{1}{2}$  pounds. The third morning I decided to try my luck above the dam. At the East end a gate was partly open, and through it the water was rushing, making a strong current. Parallel with it a pier extended into the water a distance of 30 feet, and between the pier and a boom, some 20 feet distant, several snags had drifted, so, in order to cast a line here I was obliged to make an opening. Securing a rafting pickpole, I struck the pick firmly into the snag nearest the pier, and by hard work succeeded in pushing it off far enough to secure the other end of the pick against the planking of the pier; then I was open for business.

My rod was a 6 ounce lancewood, rigged with a click reel carrying 300 feet of silk line. Casting 30 to 50 feet up the current, and allowing the fly to drift down the rapid water to the gate, I secured, after a few casts, a handsome brook trout weighing about a pound, which was returned to the water. A few more casts and I struck something that caused me to think the dam had broken away. I was fishing above that "ornery" pickpole which was midway the pier, when, as my line straightened out in the current close to the gates, my reel screeched, and

I have a dim recollection of calculating on looping on a new leader when that sea serpent should have fouled one of those snags. Yet all the while I was striving to lead the cause of my trouble, with all the force I dared exert, beyond the end of the pier, into open water. When I had succeeded in doing this, lo! there was a gleaming shape near the surface, but the pliant rod was too quick to allow it to break water. After several ineffectual attempts to reach Camp Bemis, during which the trout took out, again and again, 25 or 30 yards of the line, the landing net safely gathered a handsome brook trout of 3 pounds. This life is a huge affair after all.

A week later we made an excursion of 2 days to West Richardson pond, a beautiful little sheet of water, so well described as "a pearl in the heart of the wilderness." We had as guide, George P. Thomas, of Andover, Me., than whom there is none better in all the Rangeley region,—gentleman, hunter, fisherman, cook,—and the trip was one we shall never forget.

West Richardson pond is some 7 or 8 miles in the wilderness, North from the Upper Dam. There are several log cabins on its shores, owned by Boston and New York men. We caught some nice trout there, by trolling, and at 4 o'clock saw our first deer, near the inlet on the North shore. During the next 2 hours we saw 7 more. We spent the night at Camp Hollokton, a little woodland camp which nestles at the foot of Mount Observatory, whose wooded peak rises 15,000 feet above the surface of the lake. Beside our camp a brook, having its source far up the mountain side, ran to meet the waters of the lake.

After a bountiful supper, prepared by the guide, and consisting of baked trout, new potatoes, hot biscuits and coffee, with the small et ceteras, we spent on the lake one of the most beautiful evenings I ever saw. The moon was full and so were we,

when at 8 o'clock, wrapped in a silence that was broken only by the cry of some night bird or the splash of some deer feeding on the shore of the lake, we floated down the North shore, propelled by George's noiseless paddle. We drifted till midnight, and during that time saw or heard 12 more deer, making 20, in all, seen that day in the space of  $\frac{3}{4}$  of a mile on the North shore. We floated to within a canoe's length of one deer who fed a full minute before taking alarm. Then he started, and if he kept up the same speed and direction, he must have made Klondyke in about 10 days. After 2 days in this most beautiful place, we paddled back to camp again.

One hot morning, having cast for a solid hour in the big pool, without a rise, as my flies for the hundredth time settled softly on the rapid water near the dam, there was a mighty swirl near my tail fly, a silvery flash near the surface, and—I struck. The fight was on, and I knew at once, from the tension on the line as again and again the fish took out 100 to 150 feet of silk, that I had hooked something worth saving. But why dwell on a scene that every angler has lived over and over again? The maddened rushes at last grew weaker and shorter as the cautious reel slowly devoured the silken thread, and after a well fought battle of some 27 minutes my net sank beneath a royal prize, a brook trout of 4 pounds 9 ounces; more beautiful than words can tell, as every fisherman will grant. During our vacation we took over 100 trout, most of them weighing over a pound, and three fourths of them were returned to the water.

There is no more delightful way of spending a vacation than with camp and canoe in the Maine woods, with pleasant companions, particularly in this vast region in which the woodsman's axe has scarce been heard, and where is rarely known a sound foreign to nature's surroundings.

---

## AMONG IOWA QUAILS.

E. A. JOHNSON.

It was a dull morning in early November. Having nothing in particular to do, and thinking perhaps a few ducks had come in on the cold Northwest wind that was blowing, I concluded to stroll to the creek.

I had not fully made up my mind, by the time the creek was reached, whether to follow the stream to the river, 3 miles away, or to take to the corn fields and hazel patches, where I knew there were quails. While standing on the bank of the little stream, I heard a slight noise in a brush

heap, on the opposite bank. Hastily looking up, I saw a quail climbing up the bank. Judging from the fluttering and scrambling, there were a score of others, trying to get out of the brush heap, all at once.

Having No. 4 shot in my gun, and plenty of time, as I thought, I opened it to exchange for 8's: but just as I had the shells out the bevy flushed and was away before I could reload.

This decided the question for me. The birds settled not over 100 yards away, and

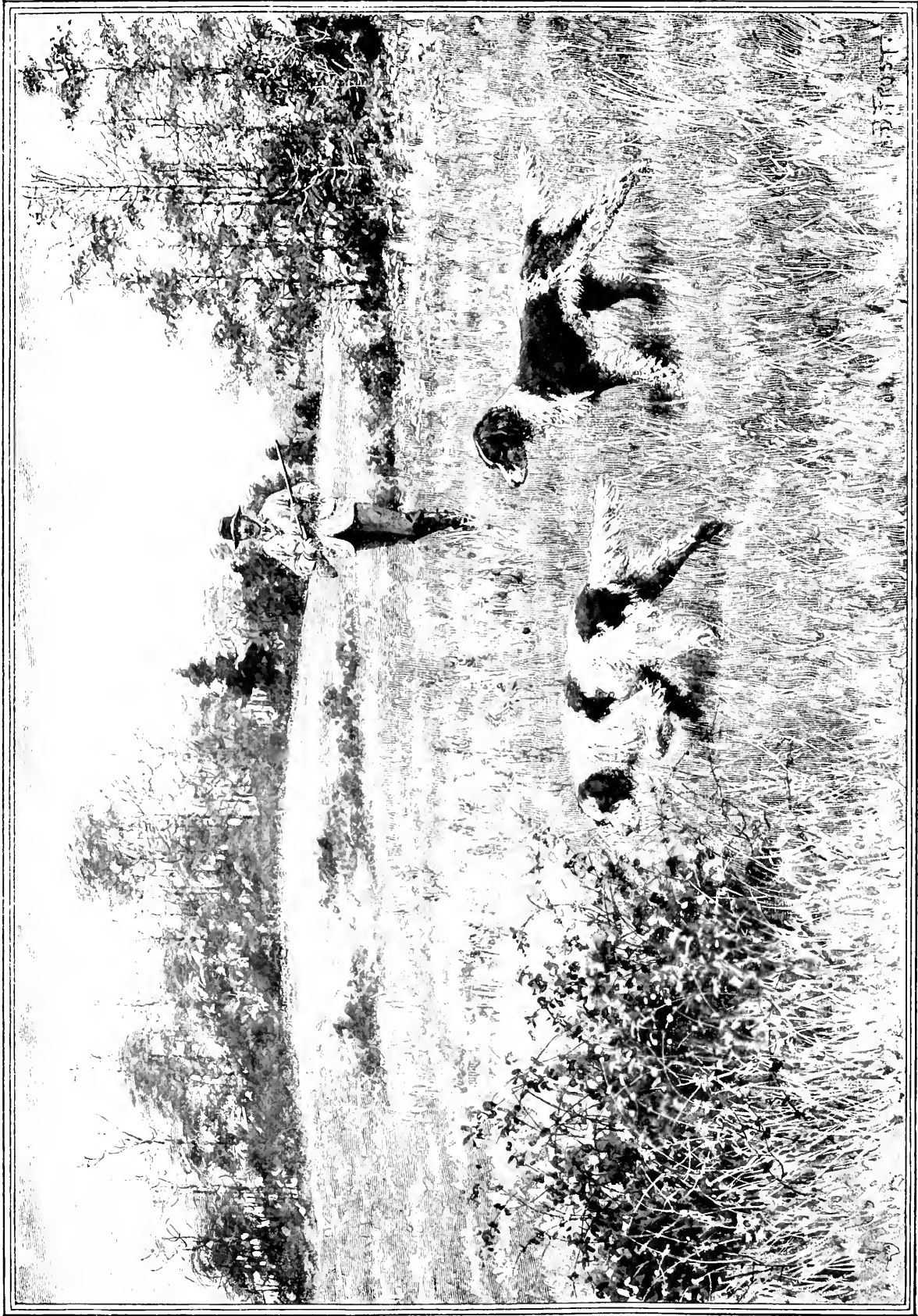

**QUAIL SHOOTING.**

From "With Gun and Dog," a series of 6 full-page drawings by A. B. Frost, in "Scribner's Magazine" for November.

calling Brant to heel, I crossed the branch, coming in below, to give the dog the wind.

Long before we were near where I had marked them down, Brant began to road. He would stop, move up a little and stop again. The birds were running. The wind was strong and the grass wet; every condition favorable to the dog worked well.

Finally, after roading and pointing for fully 200 feet, he froze fast, about 20 feet from a clump of rag-weed. As I reached the dog, there came a great fluttering, and away went as fine a bunch of quails as you will see in many a day's hunt.

Crack! crack! went the nitro, and of course I expected to see 2 puffs of feathers, and to gather 2 plump birds; but I did not. I then looked around to see if, perchance, anybody had seen me.

The birds took to a corn field near by, the stalks of which towered higher than my head. It would be folly to try for that bevy again, I thought; but as I walked around the corner of the field, Brant, a little wild after the excitement, flushed a cock, which fell at the crack of the gun.

Knowing where more birds could be found, I crossed the pond, gathered in one bird on the way, and started up the creek, having half a mile to travel to what is known as the big slough.

Sure enough, birds were there. Almost the instant the dog began showing signs of game, up they went, 30 at least, and away over the willows, up the slough into the corn field, scattering nicely—all but the one that was stopped with the first barrel; they were gone too quickly for the second.

"Now for a big match; and if you shoot as you have shot, on a few other occasions, you will have no reason to be ashamed of the result," I thought.

There were a good many quails in the slough grass, so Brant was ordered in. He stiffened into a point almost at once. Not caring to go down the steep bank, I kicked the bushes, where I stood, making a noise like a drove of cattle. This sent the birds out in a hurry, and I scored another—clean miss. "Wouldn't the boys guy me, if they knew." Brant was still there, as solid as at first. There must be another; yes—crack!—feathers. He's mine—no; he goes on. This is serious; something must be done.

Brant moves a yard and freezes fast again. A clod sends the birds out. Two puffs of feathers—one bird in the ditch and another in the corn. "You don't care for more than a dozen; you have 5 already; there are plenty of others at hand, so now pick your birds and shoot only cocks."

We had reached the limit of the willows. Here the slough divided, one branch going to the East, the other out into a meadow to the North. The East branch was full of long, dead grass and blackberry bushes; an ideal cover, but hard for dog and worse for

hunter. "Guess we'll try it. Hi on, old boy! in you go. Steady—fast again."

Oh, for a camera! What a picture! If scoffers could only see that they would never again ask why a fellow loves to hunt. "Old dog, you're worth a farm! Wonder how long they'll lay to the dog? Five minutes surely. Now it must be fully 6. This suspense is making me nervous; guess I'd better kick 'em out."

One step forward. Crack! bang! an awful recoil, and a cloud of smoke; 2 birds down.

How in thunder did that black powder get in there? What's this? 3 birds down? and I aimed at only 2.

The slough farther up proves a blank, but perhaps we can find them in the corn, close by. It had been gathered, and the wagons broke down every other row; so shooting was possible, if not so easy as one could wish. I had not gone far when 3 birds flushed wild. Taking a snap shot at the last bird, I noticed a leg drop, showing the aim was not at fault; but he continued to fly, apparently as strong as ever, and reached the fence with the others.

Following, I sent the dog around to the other side, to have the wind in his favor. I had gone perhaps 20 yards, when right before me on the grass, lay a dead bird, the one I had just shot at.

Following the dog up the fence, I bagged 2 more. Then, feeling sure of finding the other one, to fill out, I started home.

When near the place where I had found the first bevy, 2 birds flushed wild. I tried for a double, but missed with both barrels. Still, I was to have my last bird, for the gun was hardly reloaded when the dog came to a stand with a jerk, his head turned around against his side. The stop was so sudden, and the position so strained, he almost fell over. The birds got up almost immediately, 3 of them, and as the gun cracked, I counted No. 12.

"Now, my boy, you are no game hog; so call it a good day's sport, and leave the rest for seed."

The bag was "all feathers," so far, but my good luck had not deserted me; for, as I was passing through a patch of timber, Brant ran to a tree and sniffed around the roots and up the sides, finally standing up against it, wagging his tail and acting as if a cat was among the branches. He had no use for cats.

I looked up and saw a squirrel. "You'll go home with me, too; so here goes," and he was added to the bag.

Reaching home, I placed my game in a row, so it would show up well. I then called my mother to see what I had.

"How many?" she asked.

"Twelve quails and a squirrel," I proudly answered; and what do you suppose she said? It was this: "Oh, you pot hunter!"

# AT SEA

ETHEL BROWNING.



Dark is the night and full of mystery,  
A pale young moon and a bright trembling star  
Illume a portion of the heavens far  
And cast a beam of silvery light across the sea.

Upon the ocean's bosom dark it gleams,  
Piercing as like a sword, the gloom around  
Which doth appear thereby the more profound,  
A path unto some other fairer world it seems :

Into the darkness of my soul hath crept  
A ray of hope — a beam of coldly light —  
Such as the moon doth flash across the night.  
I raise to it my eyes that long have wept.

Bright Path of Light — could I but follow thee —  
Who knows — my heart that cannot here be glad  
Might find that which it longs for, but has never had,  
And from its doubts and sorrows might be free.

Where dost thou lead, say? — To the light — the sun —  
And shall I find what is to me most dear?  
I follow thee in hope, and yet I fear  
The End will only be — Oblivion.

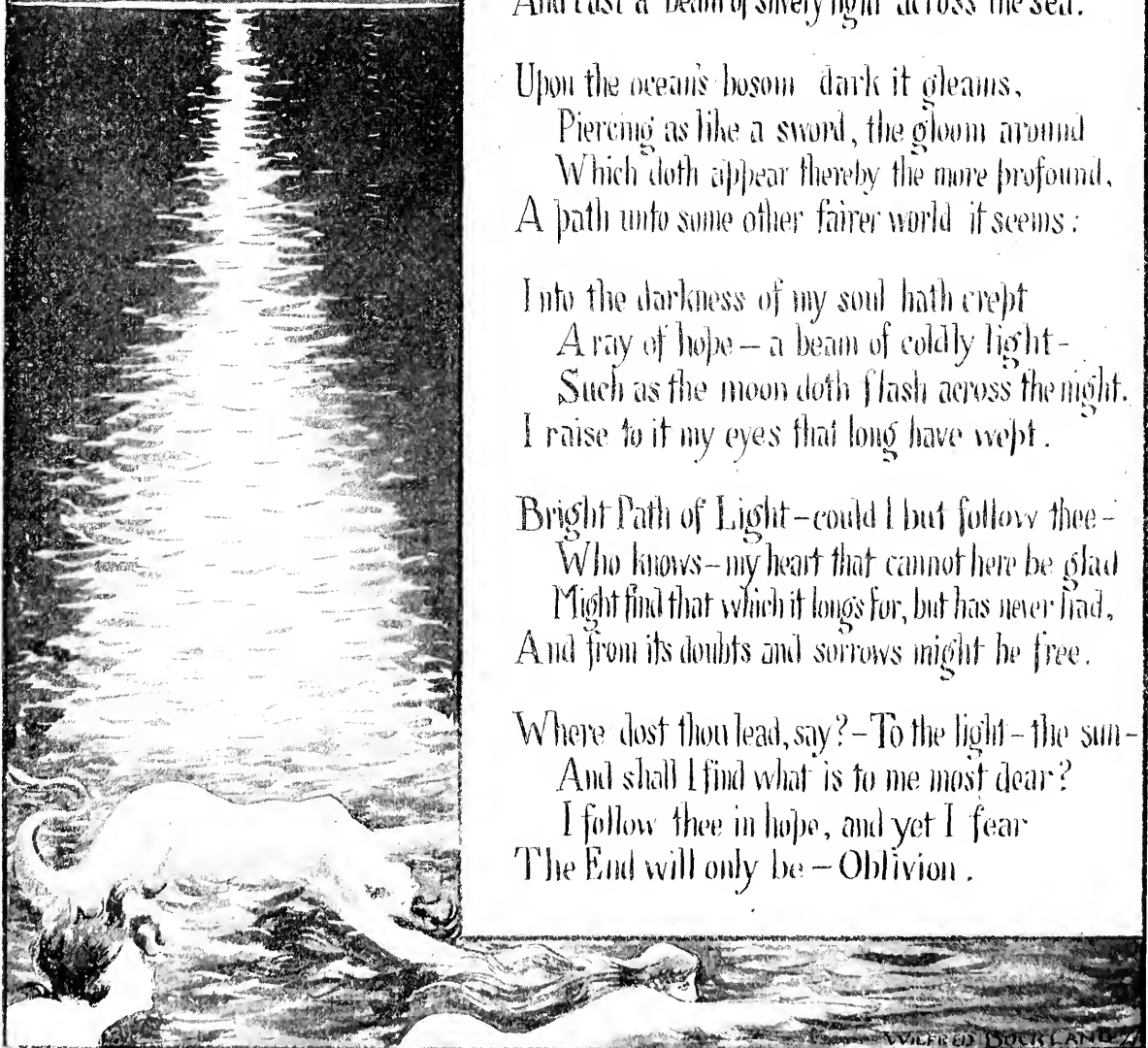



## WATCHING.

E. W. ROBINS.

Yes, he had been there, and that since daylight. The long claw marks, a 7 inch depression in the soft ground and the carcass of a horse, dragged fully 20 feet, left no room for conjecture. It was a grizzly; but the hard ground, covered with pine needles, left it doubtful as to the direction he had taken, after leaving the open space.

An East and West line, drawn through the little park in which the carcass lay, would meet no change in elevation for a quarter of a mile in either direction. The water from the tiny spring that oozes out near the middle of the park turns hither and thither as if in doubt whether to make its way to the Atlantic or to the Pacific. Had it started a few feet farther to the South, it would have been on the continental divide and might then have gone both ways.

A good mountaineer, with a good pony under him, might ride to the Big Hole basin, about 3 miles to the North and something like a thousand feet below; while to the South a loosened boulder, after a drop of several hundred feet, and then an angular descent of a few miles would hide itself in the dark blue waters of Salmon river.

From the South end of the park, a dense growth of firs, with considerable down timber, extends about 75 yards to the brink of a precipice of some hundreds of feet. North and East of the park, the timber is more scattering, with only here and there a fall-en tree.

It was between 5 and 6 o'clock of a September afternoon, when I reached the spot. The dead horse lay 20 yards from the South end, and nearly at the edge of the timber of the East side of the little opening.

After a great deal of looking and thinking, I came to the following conclusions:

First: that the chances were reasonably good for a shot at a very large grizzly;

Second: that he would be after his supper about sunset, or perhaps a little earlier, and

Third: that the direction of his approach was uncertain.

After a careful examination of all the surroundings, and weighing and reweighing all the probabilities, I selected a position between 2 trees. A bunch of rye grass afforded effectual concealment from any point in the park, and an approach from the South was not to be thought of because of the precipice.

Standing between the 2 trees, I made a careful survey of every visible object to the East, North, and West. Plans were laid—too numerous to mention here—in each of which Bruin, as well as I had a part

to play. However much these plans may vary in detail, each had the same beginning and the same ending. "But, if he should" was the beginning of each; and, "There he lies," was the common termination.

Having disposed of the bear under every conceivable combination of circumstances, I next sat down to enjoy my pipe, resting my back against one of the trees with the "old reliable" 44-90 against the other.

The smoke? Well, if he has my wind, which he hasn't, he won't come, smoke or no smoke; and if he has not my wind the smoking can make no difference. Mr. Phillips was not far wrong when he said,

"A little too much peruke is just about right, for out-door smoking."

It is too early yet to think of the bear's coming. That pine tree, over there, is a patriarch. It must be 700 years old at least. Think of it. It stood there when Columbus made his first voyage into the unknown seas!

What a grand view of the Big Hole basin! There is Gibbon's battle-ground—where he did up the Nez Percés. Into this basin flows Lake creek, Swamp creek, Bloody Dick and Warm Spring creeks. Yes, that's the place where, a year ago, my friend heard a dog bark, up the creek; took his gun and went. Next day they found the man dead. He had been scalped. It must have been close to where I camped 3 years ago, trapping bear. I did not see much bear sign there. I wonder if—What in thunder makes a fellow start so when he knows what it is? There is no possibility of an approach from that direction. There is not a crevice in that wall; and whatever comes from that direction must have wings.

Well, suppose they do repeal the Sherman law. What then? The shadows are creeping across the little park, and have almost reached the carcass. Yes, he might be sniffing around, even now; but it's a little early yet.

Another careful survey of the surroundings reveals nothing new, save two camp-robbers and a magpie, picking at the carcass, where Bruin got his breakfast. Looking through the aperture of the rear sight, I place the little ivory pin-head on the magpie's head, and pull the trigger, again and again. Certainly I could. Why, I would wager my good old Sharps against a last year's pine cone that I could take the head off that bird and never ruffle a feather of his body. I want only one shot at a grizzly's head, at that distance.

I resume my seat, with my rifle across my knees. The sun has just started to slide down the park to the West. How fast it

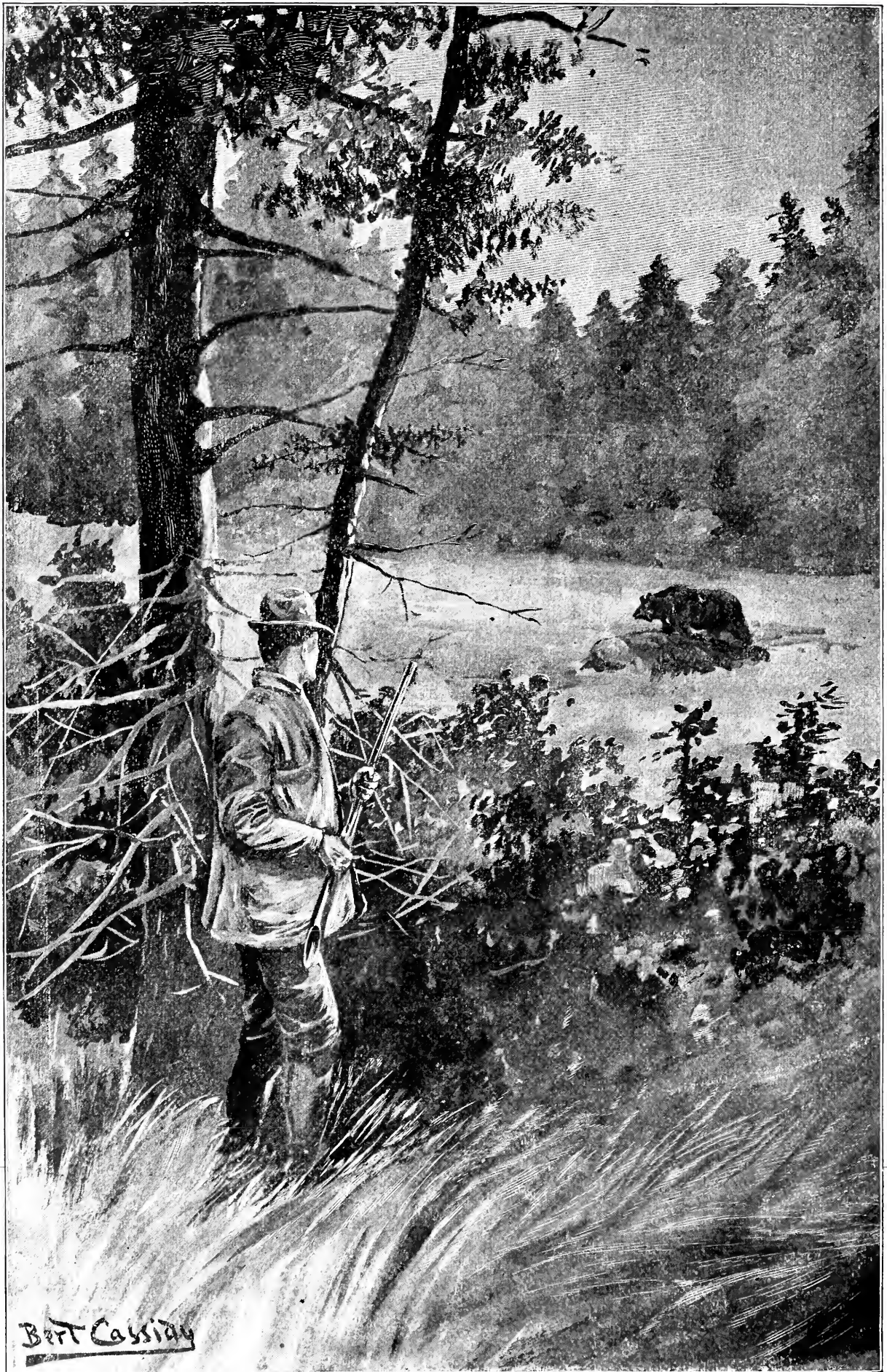

"A CALM CONSCIOUSNESS OF IMPENDING DANGER."

goes! Yes, I have seen them come earlier than this.

A while ago the wind was from the North; now it's from everywhere, or from nowhere. I shall need only one shot; but I'll see that the other 3 cartridges fit the chamber properly.

Just as the last cartridge is taken from the barrel, I find myself standing erect, facing the West; rifle cocked and almost to the shoulder; with every nerve strained to its uttermost tension. My whole soul goes out in the direction from whence the sound came. A wood mouse, nothing more. What makes one draw such a long breath after so short a period of concentrated thought? Does one forget to breathe? Perhaps. At such moments, forgetfulness is, in a measure, due to over cautiousness.

A few minutes later, I made the discovery that my gun was as empty as a last year's bird's nest, and the cartridge that should have been in the chamber was carefully deposited in my vest pocket. (I do not wear a belt.) I felt like—well, like loading my gun with one of the cartridges and placing the other 3 between my fingers, and this I did with exceeding alacrity.

The evening becomes chilly. I have watched the shadows grow longer and longer, until for want of room they have softened into a deep, heavy gloom. How is this? The dark object at the farther end of the park, which I know is a stump, is moving—just a little, but surely moving. I remove the old Sharps from my shoulder, for the third time. How annoying it is to have a gun continually click-clicking, and creeping up to your shoulder when you want to think about something.

The camp robbers and the magpie no longer make their serial trips for bits of meat to hide among the branches. The pine squirrel has ceased his chatter. The breeze—like the sun—has gone down; and the day is holding its breath as it merges into the night. How intense and oppressive is the total absence of sound. The mind abhors a silence, as nature does a vacuum.

What's that? Nothing.

My overtaxed imagination would have it the tread of a grizzly; but it's only the beating of my own heart. The tread of a grizzly is never heard, save in fiction.

A sharp crackling of brush to the East at last puts an end to the painful stillness and once more I am put to guessing. And now all is still again. Then another sound, uncertain and indistinct, but farther to the right. The animal, whatever he may be, is now near the edge of the precipice. Without knowing why, I turn back, quickly, in the direction of the park. I am not conscious of having heard a sound, but the eye goes direct to a dark object, dimly outlined, and a little beyond the North end of the opening.

The bear, no doubt. No nervous start this time. No snatching of the rifle to the shoulder. The nerves relax, and a calm consciousness of impending danger, tempered with a firm self reliance, takes possession of me. This, in a measure, restores both mind and muscle to their normal condition.

Strange, but that stump has moved from where it was a few minutes ago. It is now out in the park, and is still moving with an odd, billowy sort of roll, toward the dead horse. Occasionally it stops and rolls from side to side, as if searching for something. Then it moves on again. Now it is close to the carcass. Again the butt of the old rifle is pressing my shoulder, and my index finger is feeling for the trigger. The stump has paused for an instant beside the carcass. There is a roar, a column of fire and a smell of burning powder. Then another roar, as of some great beast in mortal agony; a growl, and a succession of guttural sounds. Then all is quiet.

By Jove! There are 2 dead horses, instead of one! How is it I did not see the other one before? No; as I live, one of them is a grizzly; but he is so near the same size as the horse it is not surprising, after all, that I should have been deceived, in this heavy twilight.

---

“I saw the sweetest little hat down at Gainesborough's you ever dreamed of, John, and it was marked down to \$25.99.”

“But you don't mean to say you paid that for it?”

“Why, certainly not, John; I told the clerk to charge it.”

---

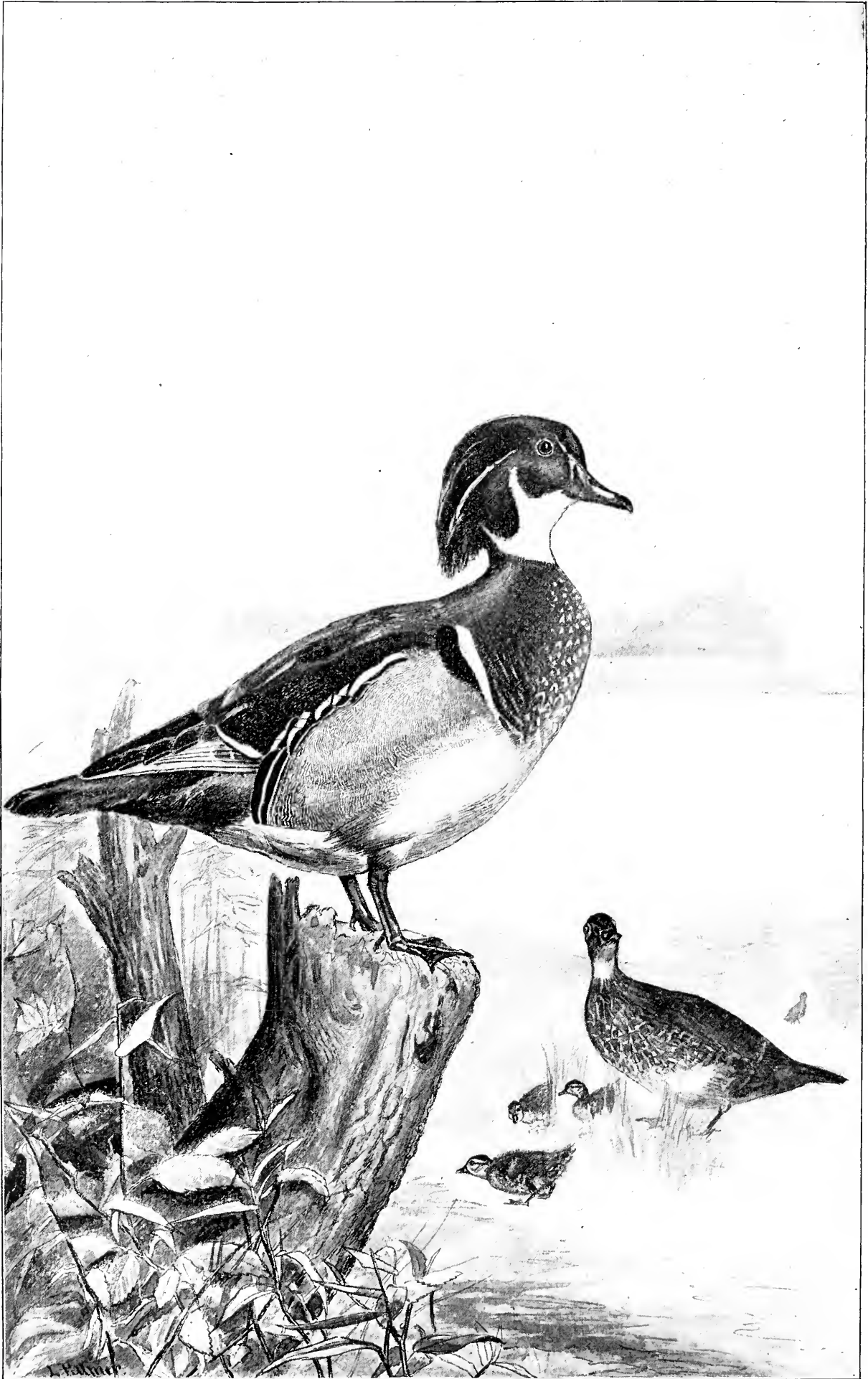

WOOD-DUCK (*AIX SPONSA*).

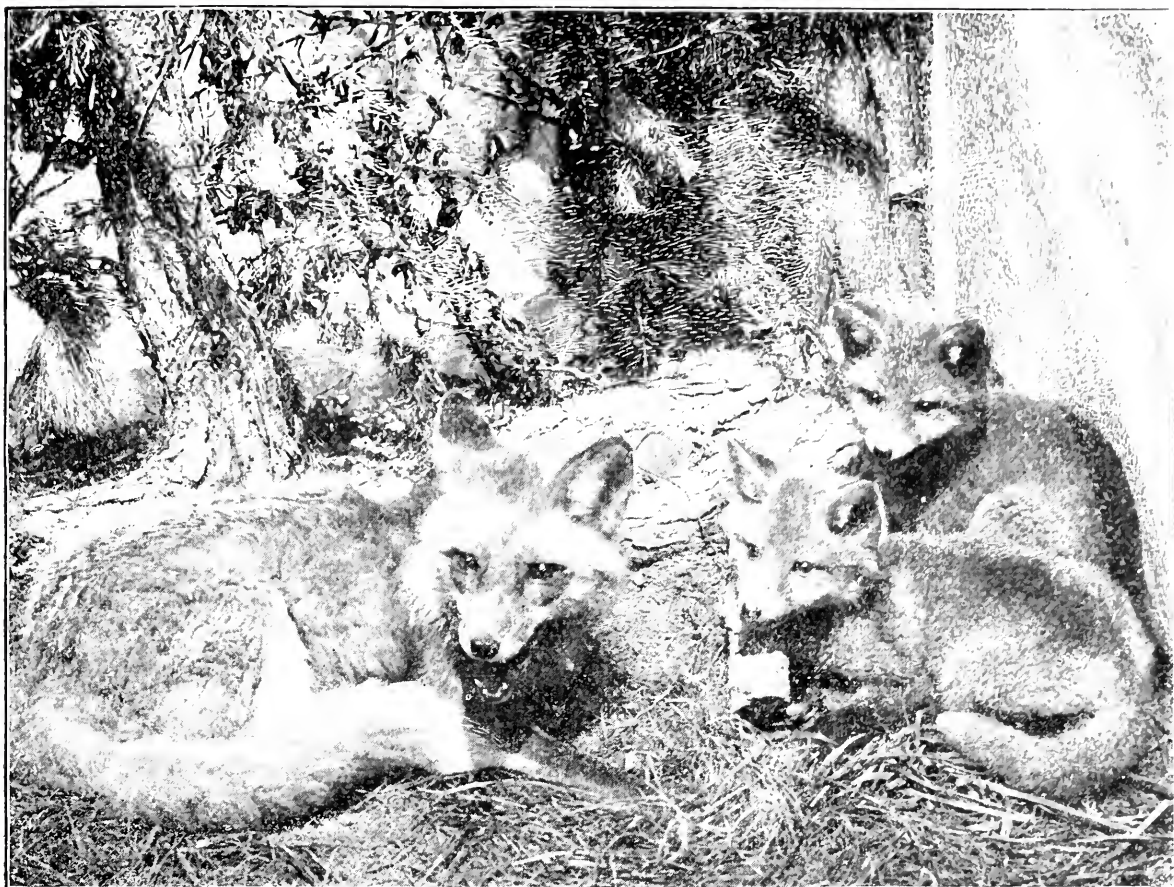

PHOTO BY JENNESS RICHARDSON FOR MR. W. T. HORNADAY.  
RED FOXES.



AMATEUR PHOTO BY A. C. MELLETTTE.

OUR NOVEMBER CAMP.  
Highly Commended by Judges in RECREATION'S Second Annual Photo Competition.

## CHICO.

B. C. BROOME.

It was daylight before Carl and I had eaten our simple breakfast of *frijoles*, *tortillas* and coffee, which the inhabitants of the Cuevas had offered us, and, by the time we had caught up and saddled our ponies, the sun rose above the sharp peaks of the Sierras, bathing the whole valley in a flood of light and warmth.

Bidding *adios* to our hosts we swung into the saddles and set off up the valley at a

at Las Cruces," said Carl, with an earnestness that made one smile, for he was not used to sleeping on the ground, with but one blanket between himself and the stars.

Hauling up our canteens we took a good drink and a long one, for at the rate the heat was increasing the canteens would soon become miniature boilers, and the necessity of drinking would be added to the list of the day's tortures.



"A MEXICAN WAS WATERING HIS HORSE THERE ALSO."

jog-trot, stopping to fill our canteens with fresh water at a water-hole in the bed of the arroyo. A Mexican was watering his horse there also, and after a few minutes' conversation, we tightened the saddle girths and struck back into the trail.

Carl had been sent by the American Mining Company, at Las Cruces, to the town of Tecora, to see about some freight that had not been forwarded to the mines, and as he spoke no Spanish, I was detailed to go along and act as interpreter. We had remained in Tecora until we saw the required articles loaded on a lot of burros, and were assured of their start in the right direction at least.

"To-night, thank heaven, we shall sleep

Taking up the trail again we jogged on, putting the miles behind us in a way highly gratifying. The ponies were beginning to sweat, and the dust that rose in clouds about us settled down over man and beast like a coat of white-wash.

We were more than anxious to make Las Cruces that night, and there were still some 25 miles of the roughest kind of trail before us.

The intense heat, the "chug, chug, chug" of the ponies' hoofs, the clouds of stifling dust and the jingle of spurs and bridle-chains, keeping up hour after hour, was mighty monotonous. Now and then Carl or I would say a few words, not altogether complimentary to the heat or dust,



"OCCASIONALLY WE WOULD MEET A YAQUI INDIAN."

and then settle down to a sort of "cussin' silence."

Occasionally we would meet a Yaqui Indian, or a Mexican driving a pair of pack burros, or a burro pack-train, loaded down with salt or other merchandise, on its way to the mines. In passing these pack-trains, all we could see, in the great cloud of dust that surrounded them, was the faint outlines of the little animals patiently plodding along. We could hear the patter of the many hoofs and occasionally the tinkle of the bells which hung about the necks of the leaders, and above all the voices of the *burreros*, or drivers, as they ran among the animals, distributing blows right and left and yelling like so many fiends.

About 2 o'clock we pulled up to one side of the trail, dismounted and unsaddled the ponies, allowing them to seek the shade of a small mesquite tree; while Carl and I, after smoking a *cigarro* or 2, went to sleep in spite of the heat and flies. Our nap was but a short one; still the animal's backs had cooled off, and so, resaddling, we struck into the trail once more.

About us the chaparral and cactus were covered with dust kicked up by the many passing hoofs, and far away on all sides the mountains were faintly discernible, their purple outlines softly blending with the intense blue sky. Everything seemed to quiver in the heat, and the handle of my 6-shooter was so hot it burned my hand.

A mile or so ahead we could see evi-

dences of the ubiquitous pack-train, apparently an unusually large one. Gradually we neared it, and, in passing, drew off to one side to avoid the dust. When amid the confusion a slight opportunity offered, I called to the *capitan*, one José Valdez, and asked if his outfit were going to Las Cruces. "*Si señor*," he answered. "And when do you expect to get there, to-day or to-morrow?" "*Lo mas pronto que posible*" (as soon as possible) was the reply, at the same time taking out a package of *cigarros* and passing it to us. Lighting one with a "*mecha*," ignited with flint and steel, we resumed conversation, which touched on the heat, the drought, on rumors of raiding Apaches and numerous other things. I interpreted the gist of it into English, for Carl's benefit.

Presently, looking up, José realized that his charge was gradually dwindling to a speck in the distance, so, saying a hurried "*Adios señores*," he dug his spurs into his horse's flanks and tore away, while we followed more leisurely. Nevertheless before long we were close on the heels of the outfit.

"Confound the dust," Carl said, "lets get out of this," and, suiting the action to the word, spurred his pony forward at a lope, while I followed. We had gone but a few rods when I thought I heard a child's voice, as if in pain, and reining in, I called to Carl to pull up. Riding into the cloud of dust, from whence came cries of "*per-*

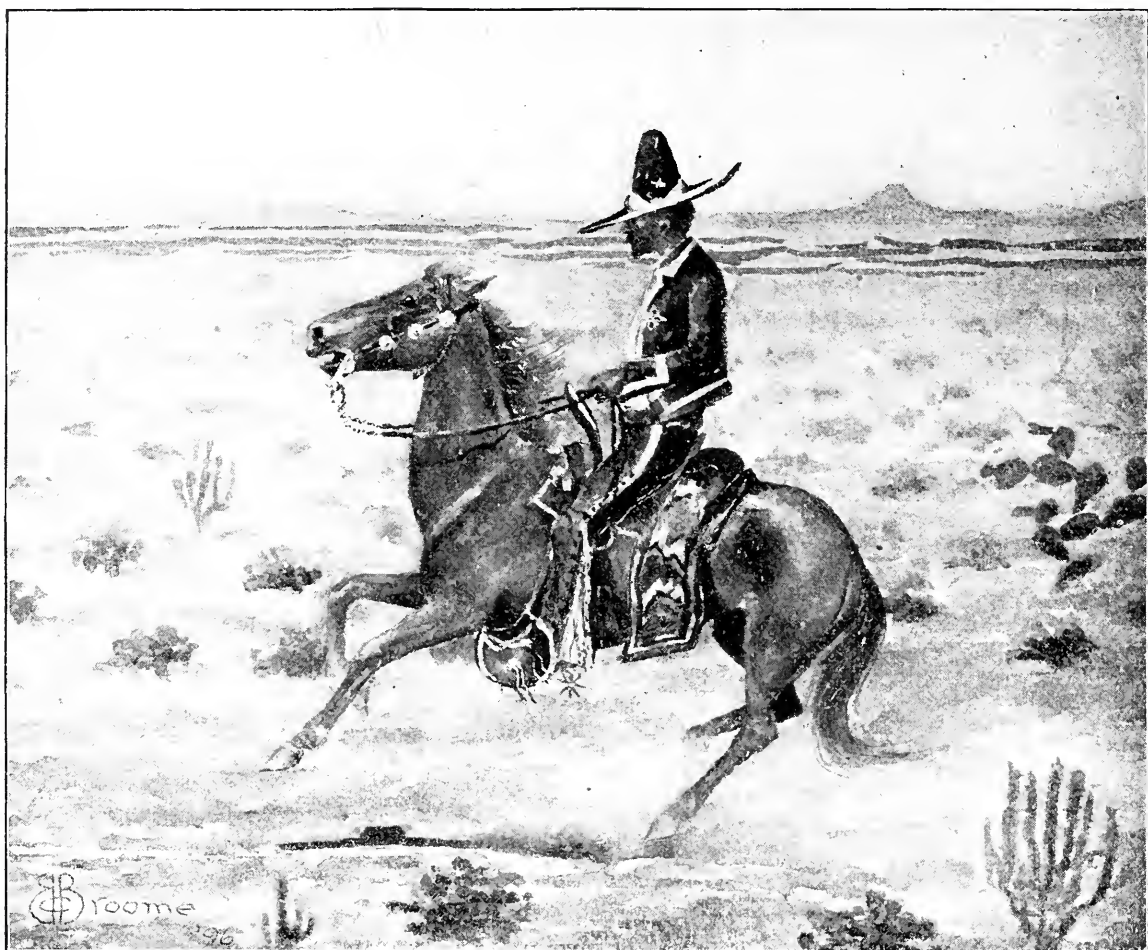

JOSE VALDEZ.

*done me señor, perdone me—sultame!*” (pardon me sir, pardon me—let me go!) we discovered a big *burrero* cruelly beating a little half naked Yaqui Indian boy, with his “*tapofo*,” or burro-blind, with a raw-hide lash attached. Seeing us, he stopped and released the little fellow, who cowered at his feet.

“You blankety blanked blank!” said Carl, in frontier English.

“What’s he beating the kid for,” Carl demanded. I asked the *burrero* why in “*el infierno*” he was chastising the boy.

“Ah, *señor*,” he answered, “the *muchacho* (boy) is very bad. He will not keep the burros in the trail, but allows them to wander to the side, and who knows but that they might be lost?”

“You don’t have to beat the life out of him, for that,” I said, indignantly; “don’t you know its cruel to whip a child, so?”

“*Si señor pero es necesario* (yes sir, but it is necessary). Then he is my property. I bought him from *los soldados* (soldiers) who captured him, while on their last campaign.”

“How much did you pay for him?” I asked.

“Ten dollars *señor*; but then he was very

little, and so I called him ‘Chico’ as I do now.”

When I translated this to Carl, he said:

“Well it’s a beastly shame. Poor little kid! Looks about scared to death. Say, why can’t we buy him, from that brute? We can find use for him at Las Cruces.”

“Just what I was thinking. Hold on till I find out if he is for sale.” He was, and for the enormous sum of \$20.

“I’ll pay half if you’ll pay the rest,” I said to Carl. “It’s a go,” and forthwith he proceeded to unbuckle his six-shooter belt, and pouring out 10 big Mexican silver dollars, handed them over to me. Suddenly the spirit of economy was awakened in me, and I proceeded to negotiate with “*burrero*.” After a sharp wrestle with words and gestures I managed to cut the \$20 down to \$16, and then told the man to make out a bill of sale, according to the law, meanwhile giving him a pencil and a leaf from my note book.

The boy had risen to his feet and was driving the burros along, every little while looking dubiously over his shoulder at us; evidently badly frightened. The idea of being sold to 2 “*gringos*” was to him most awful, notwithstanding his present hard lot.



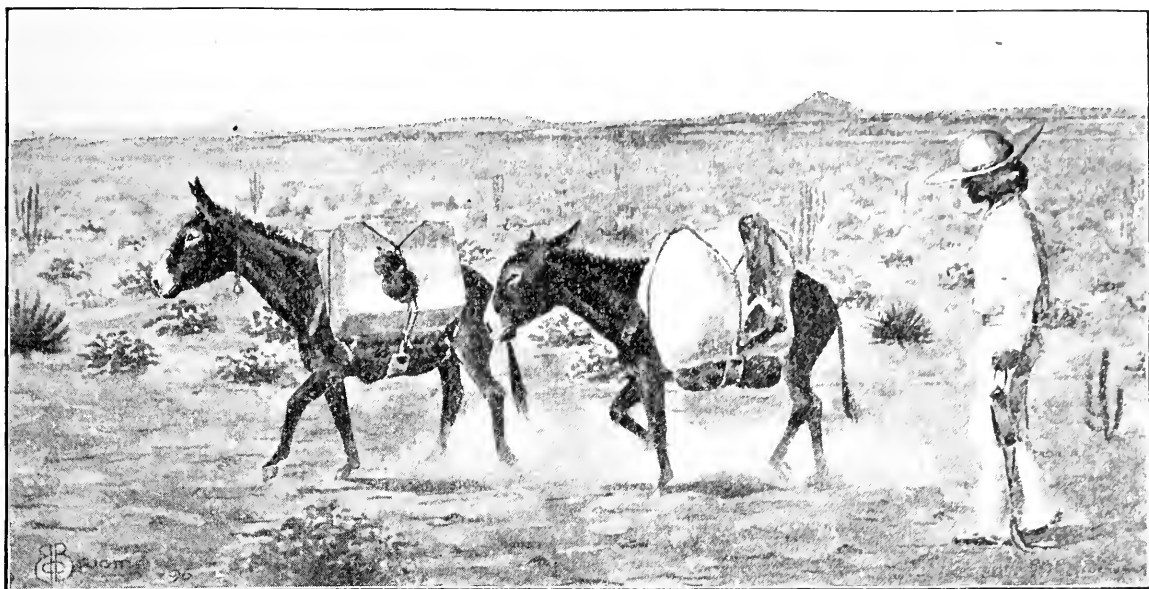

“OR A MEXICAN DRIVING A PAIR OF PACK BURROS.”

The bill finished, I looked it over and found it correct, and that it bound us to treat the child as our own; to clothe, feed and educate him, and to teach him to be a good citizen of the country. Carl and I signed it, and the *burrer*ro signed the release to his ownership. Then the money was paid over, and Chico was ours.

“Now, what shall we do with him?” Carl asked. I was stumped, and had to admit that I didn’t know. The *burrer*ro evidently understanding our situation, came to our rescue and suggested that, as the outfit was going to Las Cruces, if the *señores* would trust him, we could go ahead, and he would bring the boy to us “right side up with care.”

I called José, told him of our purchase, made him promise to see the *burrer*ro kept his word, and that the boy be sent to the superintendent’s office as soon as the outfit arrived.

“*Muy bien*,” he said, and then—“but why did you buy him?” I turned to Carl, who merely shrugged his shoulders and said, “*quien sabe*.”

Pulling to one side of the trail, we put spurs to our ponies and loped on to make up lost time. What to do with our little Indian was the question that now constantly forced itself on our minds. At last, in despair, I told Carl he must suggest some plan; and after some minutes of sober thought he said the only thing he could think of was to let him keep our rooms clean, and run errands for his wife. She could, in turn, look after the boy’s welfare.

“All right,” I replied; “but I’m afraid it will be no small task to look out for that kid.” I thought of Carl’s dainty little wife, but recently from the “States,” and who, though loved by everyone in the camp,

seemed strangely out of place surrounded by the rough airs of a mining camp. The idea of burdening her with the uncouth little stranger to “look after,” seemed to me to savor of incongruity.

We arrived at Las Cruces just as the night hands were going to the mill, and, riding up to the main office, dismounted, and gave our ponies over to the care of 2 Mexican boys, who led them away to the *corralls*. Carl went up to his rooms while I, after removing my six-shooter and *chaps*, washed up, in the kitchen, and went in to supper.

Later I strolled to my room, from which I hauled a chair out on the veranda, and sat down for a quiet smoke. The valley was extremely beautiful, in the soft moonlight, with here and there a light from a miner’s cabin, and I thoroughly enjoyed its restfulness. Meanwhile I wondered when our new human chattel would show up.

The next day I was busy getting my men and mules together, as the Company was to make a shipment of silver bullion to the railroad in a day or 2. Once I saw Carl’s wife, and she asked me what kind of a looking boy we had bought. I could only say he was simply a half-starved Yaqui Indian youngster, about 10 or 12 years old; “but,” I added, “he will be handy to run errands, and bring water and wood. Beside he will be safe from the cruelty of the Mexicans.”

The next day several of us were in the office, waiting for the opening of the weekly mail that had just come in. Carl and his wife, the manager, the superintendent and some of the bosses were there, all eager for news from the states.

One of the men remarked that a burro outfit had just come in, and that there was

"a half-starved Yaqui kid" with it. "Then," said Carl, "we may expect to see our 'Chico' at any moment."

Suddenly a smothered exclamation from Mrs. Carl startled us, and, looking up, I saw in the open door-way our \$16 boy, his face wreathed in smiles.

"*Aqui estoy señor* (here I am sir), he calmly announced.

Some of the men grinned, and a few of them laughed outright. It struck them as something queer to see—that thin, childish figure, clothed in course "*manta*" (native cotton cloth), that had once been white, with a pair of rude "*hurachos*," or raw-hide sandals, on his feet, and a big, ragged palm leaf hat, crushed over a thick shock of black hair, the whole outlined against the bright sunlight without.

"Is this the boy you promised to treat as a son, and take into our home, Carl?" "Yes, dear," in rather uncertain tones, which gave us an impression that Carl, at that moment, would just as soon have been elsewhere. "Oh Carl!" was all she could say.

In spite of his vociferous protests, we had Chico washed, and then dressed in a new suit of boy's clothes, from the Company's store. The "*hurachos*" were supplemented by a brand new pair of shoes, and last, but not least, a new straw sombrero, and a hair cut.

We kept Chico a year or more, and he proved a very convenient article to have

about the house; for a more faithful little worker I have never found—that is—when he wanted to work; which, by the way, was not infrequently the case.

He soon learned to speak a few words of English, and, after much patient work, Carl's wife managed to teach him to worry through "*Daisy Bell*," and "*Two Little Girls In Blue*." I smile, even now, at the mere remembrance of how he looked, standing there and singing those American

songs. He was thin, always, in spite the enormous quantities of food he tucked into the most capacious mouth I ever saw on a boy. When he quavered through "*Two Little Girls*," his mouth reminded me of an accordeon—spread to its widest at "girls" and brought back into a little bunch at "blue." And all the time his small, black, beady eyes snapped and sparkled.

Shortly after his advent, on my way to the railroad with the bullion, we went through the village, and passing a *cantina* (saloon), I saw Chico's former owner seated at a table, with a glass of *mescal* in his hand, and overheard him telling the store-keeper how he had gotten rid of that little Yaqui for the truly vast sum of \$16.



CHICO.



"I SAW CHICO'S FORMER OWNER SEATED AT A TABLE WITH A GLASS OF MESCAL IN HIS HAND."



BUFFALO WAR CANOE.

See letter from O. H. Williams, in the Canoe Department.

## HUNTING WITH A CAMERA.

W. E. CARLIN.

Among real sportsmen this form of sport is steadily growing in popularity. It requires infinitely more skill and patience to obtain a good picture of a wild bird or animal than to hunt and kill it.

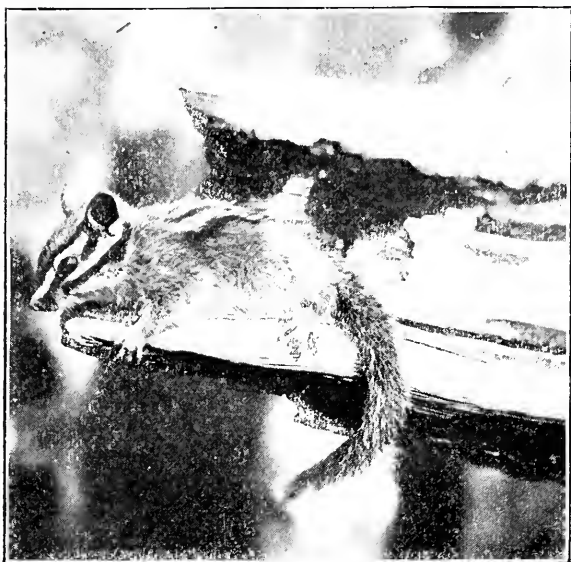

TO JUMP OR NOT TO JUMP?

Anyone starting out to photograph live animals—especially the smaller birds and mammals—will be disappointed in the results obtained with the usual hand camera of short focus and wide angle short focus lens. Mr. Wright and I have worked steadily for 2 years, during which time we have made some 400 good negatives, of about 40 varieties of living birds and mammals, and our experience leads us to believe it is a mistake to depend on a small plate, in the hope of subsequent enlargement to a size suitable for framing or for the album.

A small, compact camera is a convenient and often useful instrument to have at hand; but the picture you get with it is by no means comparable to one giving a large primary image, on a large plate. We should never use a plate smaller than 5 x 7 and prefer the 6½ x 8½. This is decidedly the best all around size.

The camera should be arranged for both hand and tripod use; and if taken on rough trips, in the woods or mountains, should be thoroughly bound with metal. The bellows cannot be too long.

Any good long focus lens, of ordinary intensity, say 7 x 8, fitted with shutter and long pneumatic tube, will answer. The less noise the shutter makes the better.

A good telephoto is a most useful adjunct to an outfit and you can get many

pictures with it that it would be impossible to get without it.

Of those I have used, my favorite is Dallmeyer's portrait combination. This is capable of making slow instantaneous exposures, in good light. For a shutter we use the Thornton-Pickard. An accurate focussing scale and a large, brilliant finder will often be useful for snap shots, at large game; but if used on nearby small animals will result in many failures.

The more carefully you study the habits of animals the easier you will find it to photograph them; and subjects and attitudes which at first seemed impossible are easy to get when one goes at it in the right way.

The subject for illustration, this month, is the highly colored little chipmunk, that is found in the higher ranges of the Rocky mountains, in Montana and Idaho.

When Mr. Wright and I first undertook to photograph this little fellow, we made small pictures of him, with a telephoto lens; but later got sufficiently near to get good sized images, in several instances. No. 1 was taken by focussing on one of his favorite resting places. The shutter was sprung with a 50 feet tube. The camera used was a Long Focus Premo, fitted with



COMING DOWN.

Bausch and Lomb Zeiss lens series vii., working at F. 12.5. Exposure ½ second, on a Carbutt No. 27 ortho plate.

No. 2 was gotten one day when we found the chipmunk up an old burnt stump. I set the camera on one side, and Wright rapped on the stump, with a stick, standing on the opposite side from the camera.

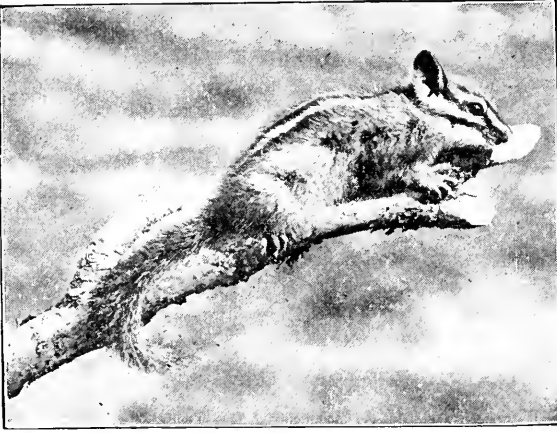

WHERE IS MY DINNER?

The chipmunk gave me a chance for a snap shot as he descended.

No. 3 was gotten by baiting a little bush

until the little rodent got to going there regularly. This picture is chiefly interesting in showing the manner of holding on to a limb with his feet.

It required, in the aggregate, several days to get these 3 pictures. We were in permanent camp, near Elk Summit lake, and baited the various birds and animals of that region regularly. We did not shoot near camp, at any time, and in fact did everything possible to get acquainted with our native neighbors, and to encourage them to visit us in our camp. In future issues of RECREATION I shall tell you how we cultivated the acquaintance of other denizens of the hills, and shall show you many beautiful portraits of them.

Gentle reader, you will never know all the pleasures of the chase until you learn to leave your gun at home; to hunt solely with your camera, and to allow your subjects to live after you have shot them.

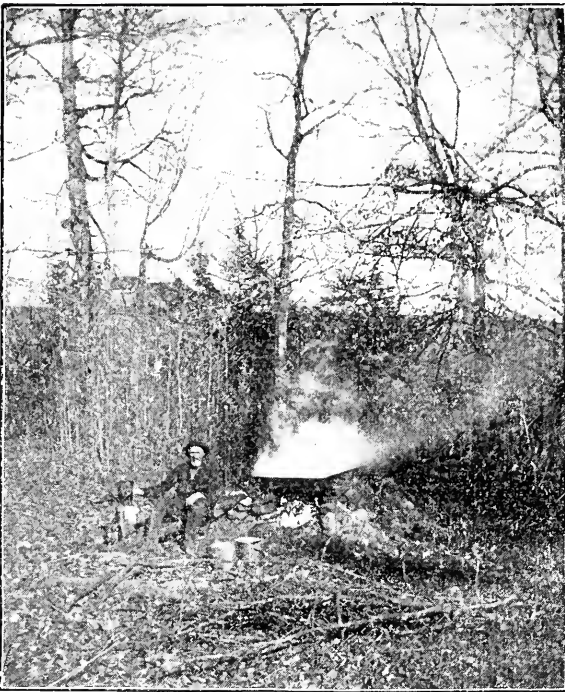

AMATEUR PHOTO BY W. C. SLEIGHT.

SUGARING OFF.

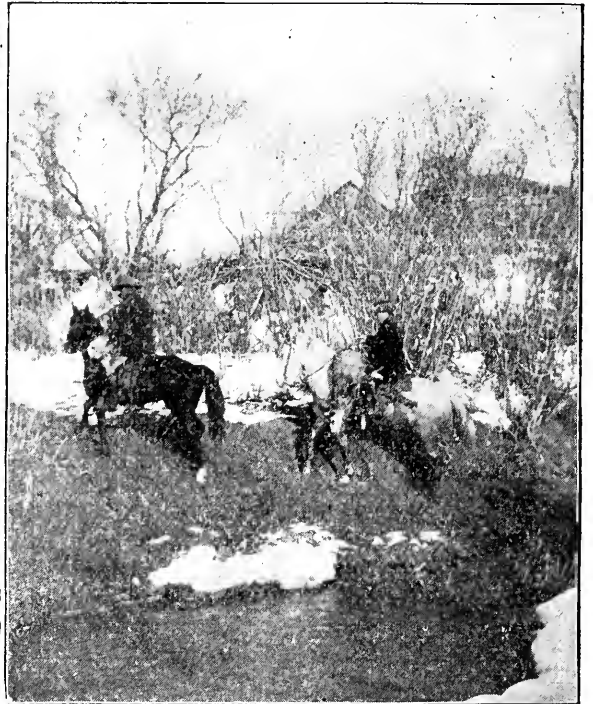

AMATEUR PHOTO BY B. C. PACKER.

RETURNING TO THE RANCH.

Bull's-eye camera, Eastman film.

Mildred—Jack said he saw us on the street together one day, and I looked perfectly lovely.

Clara (sweetly)—I can't imagine what day it could have been.



OUT OF MEAT.

AMATEUR PHOTO BY G. W. LEARD.

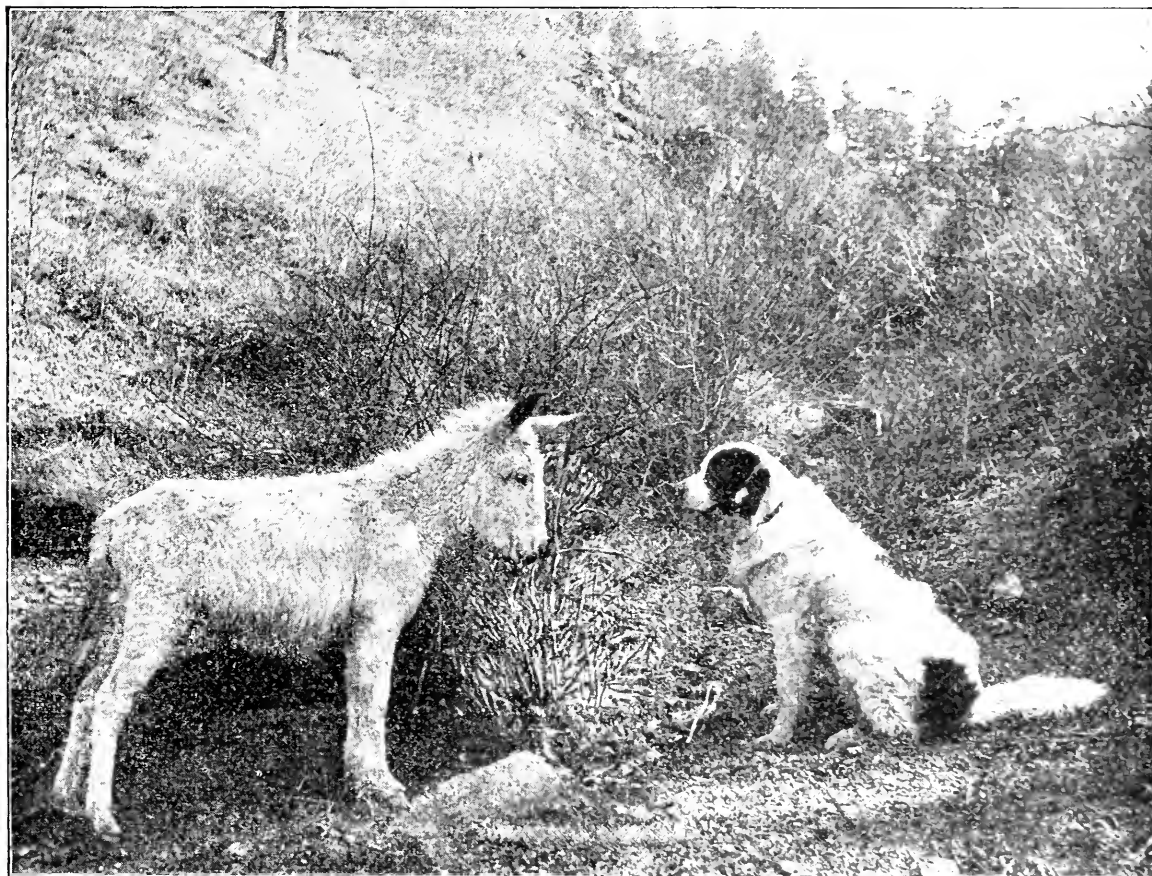

WHEN SHALL WE THREE MEET AGAIN?

PHOTO BY W. A. TRACHT.



COMMODORE F. L. DUNNELL, A. C. A.  
A Memory of the '97 Meet, at Grindstone Island.

## THE TIMMER-DOODLE.

ERNEST SETON THOMPSON.

"Say boss, I reckon thar's a pair o' timmer-doodle in yore swamp, this year."

"A pair of what?"

"Timmer-doodle!"

"What the deuce is that?"

"Wal' I dunno; reck'n it's a doodle what lives in the timmer."

"What are they like?"

"They ain't like nuthin', an' thar ain't nuthin' like 'em. I reckon you'll have a

"Hunt timber-doodle."

"Was he riz to it?"

"No; he's only a year old."

"He ain't that nuther; an' he's good stuff. He's got a birdy look. Goin' to break him yerself?"

"Naw; haven't time. Must hunt up some trainer."

"Ever hear o' Bill Bylo, the spaniel sharp?"

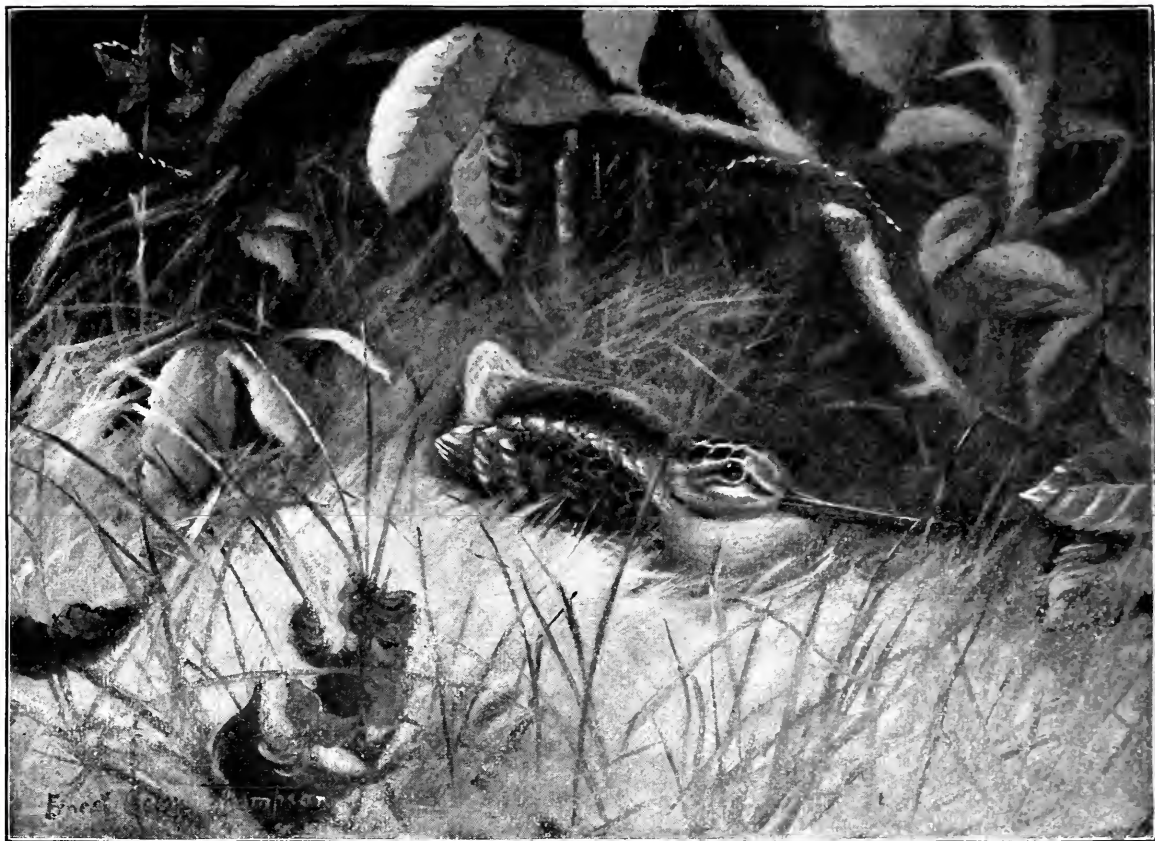

"EF HYER AIN'T A HEN TIMMER-DOODLE A-SETTIN'!"

mess uv 'em nex' August if ye knows how; fur I've heerd the cock er warblin' this 3 nights."

"Oh! you must mean woodcock."

"Yep, pears to me that's what they's called by the dudes, what comes out an' hunts an' don't get none. Whar 'd ye steal the purp?"

"You must think I'm a native of these parts."

"Humph, reck'n ye ain't. Could 'a' tole that a mile off. Ye ain't got the stuff in ye. But mebbe the purp has. He looks purty good. Ye don't want to swop him, do ye?"

"No."

"What are ye fur doin' with 'im?"

"Some."

"Good un, ain't he?"

"They say he's sharp enough."

"Wall that's me, an' I'll break yer purp fur a pair uv X's."

"Don't know you."

"That's my brand on the gun stock—'B.B.'; and thar it is again on my arm. 'B.B.' Some folks thinks I invented the B.B. cap; an' some thinks I didn't. I reckon one or other gang is right."

"You look right. I guess you are the man."

"I *am* right! are ye dealin'?"

"You'll break my dog to woodcock for \$20?"

"Yep."

"When?"

"This fall's shootin'."

\* \* \*

"Mornin' boss. Brought the purp, for fust exam. Les' go trou yore swamp. Thar, see that? See him range? Hyo, Spanker! See that? Ain't he a dandy? Look thar! Lord, now, see him set!. Now how's that? Broke, ain't he? Durn good dog; an' well broke. Say boss, that's wuth an extry V, eh?"

"Let's go up to the point and see."

"His heart 'll be broke that thar ain't no gun along. Fur gawd's sake! if hyer ain't a hen timmer-doodle a-settin'. She must 'a' lost her fust outfit. Les' put her up."

"No, no, don't disturb her. I'll make a sketch of her as she is."

"Ketch her. The law ain't off."

"No, I mean take her picture."

"Oh, I see. Her fortygraf. H'm, that won't hurt her."

\* \* \*

"Wall I be gol-swashed if it ain't her breathin' image. Most as good as a book picture. I didn't know ye follered that trade. Wall I be darned! Say boss! I'll give you a March muskrat fur the fortygraf. No? I guess it ain't for sale."

"No."

"Say, I'll make you a frame fur a dollar. Bill Simms larned me to make the purtiest frames you ever seen, out of pine cones an' sawed butternuts; an' I beat him at it, now. I pain't mine red. You could hang it up. I've seen pictures framed that warn't no better 'n that."

\* \* \*

"Wall boss, to-morrow mornin' the law's off. Hyar's the purp. He's a good 'n. Better not start in before the dew's off. The birds won't har'ly be up to sport."

\* \* \*

"Come Spanker, now we're off. No hurry, we'll easily get there by 9 o'clock. Heel, Spanker. Good dog. Why! who the deuce is this coming out of our swamp? It's Bill Bylo, and the infernal thief has some woodcock. Some? Why he's killed them all; the old birds and the 4 young—all there were on the place. You low-down dirty sneak! To serve me a trick like that when I paid you \$25 to train my dog."

"Ho, ho. Ya, ya, ya. An' I dun it too. He's a good un. He's well broke. But Lor' I warn't paid for trainin' his boss."



AMATEUR PHOTO BY AN UNKNOWN CONTRIBUTOR.

A 2.18 CLIP?

Highly Commended by the Judges in RECREATION'S Second Annual Photo Competition.

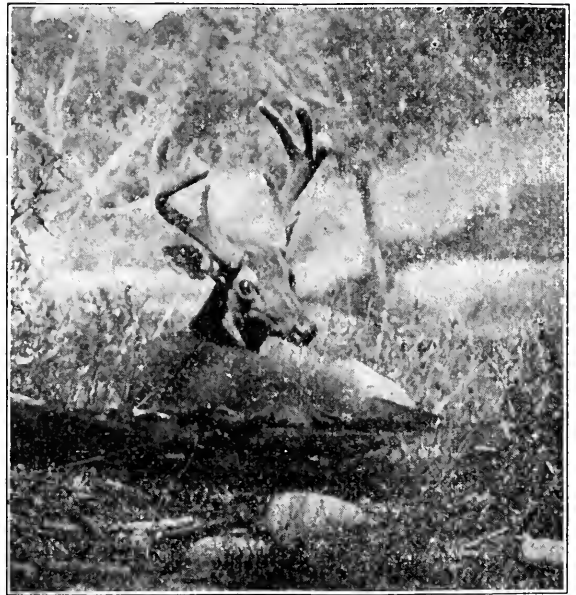

AMATEUR PHOTO BY S. F. GACHES.

LOOKING FOR DANGER.

"Is your new clergyman progressive?"

"I suppose so. He attends funerals on his wheel."—Chicago Record.



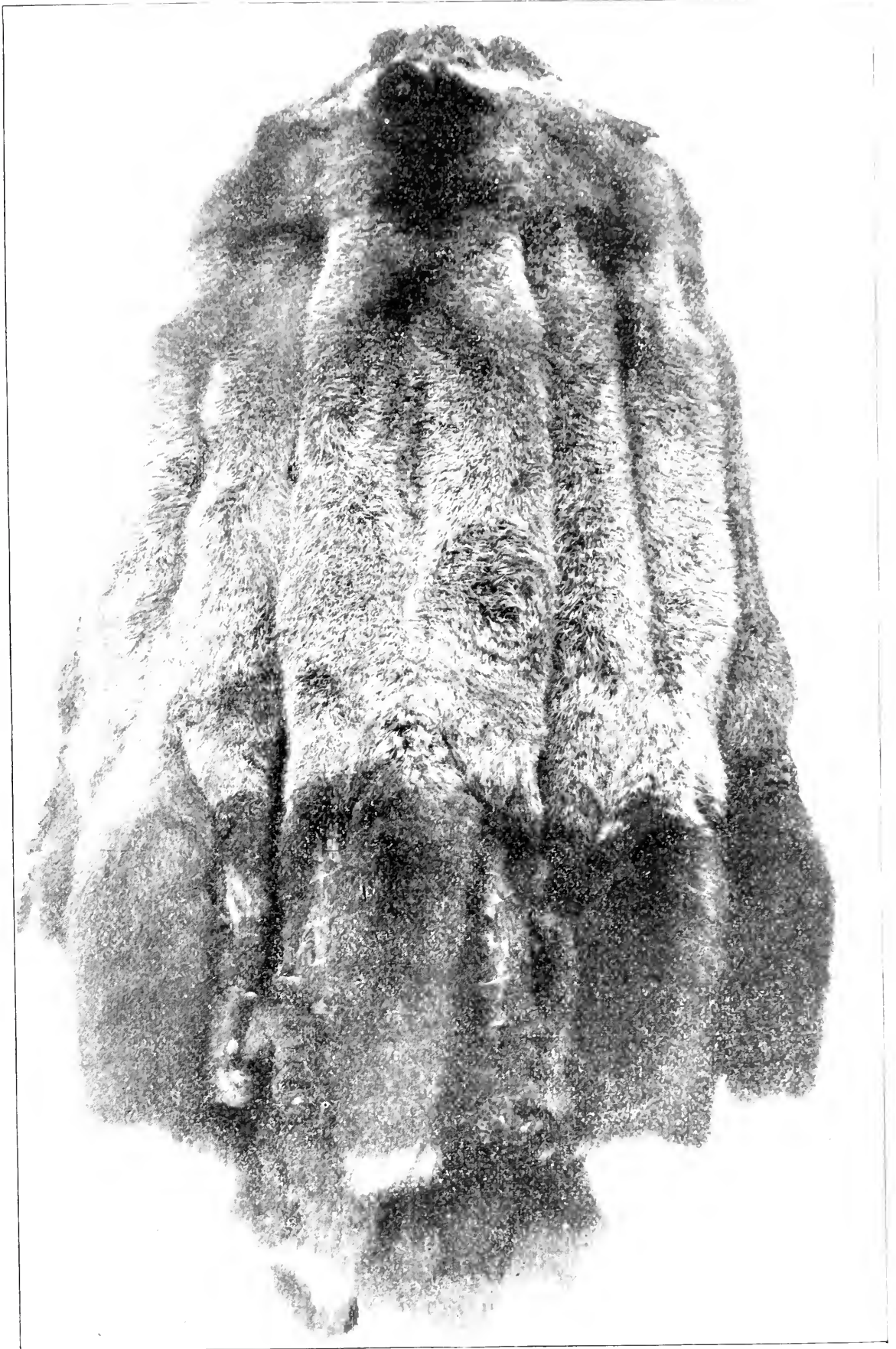

THIRTY SILVER FOX SKINS--VALUED AT \$2,500.

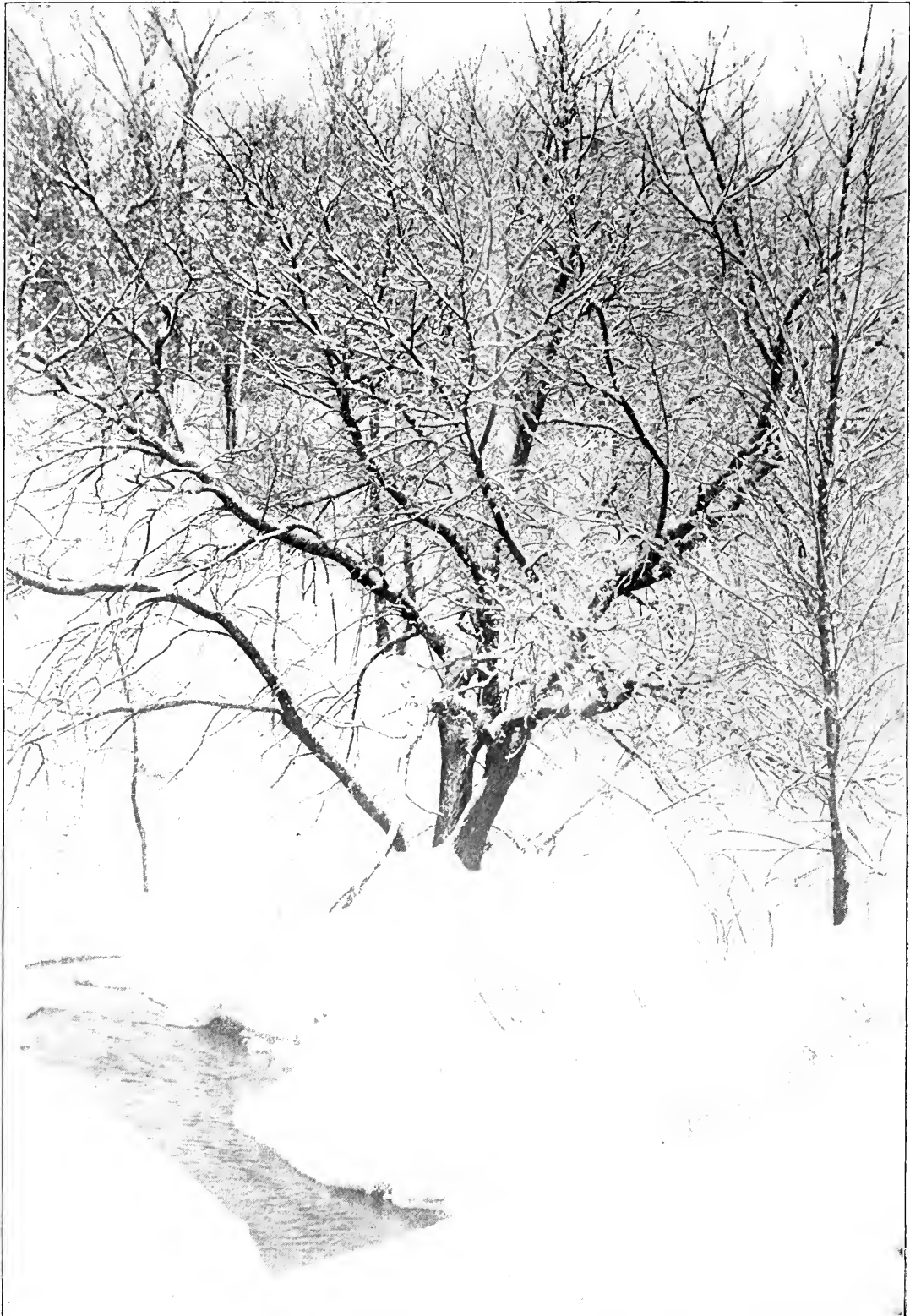

AMATEUR PHOTO BY ROBERT WALSTROM.

THE FIRST DAY OF WINTER.



AMATEUR PHOTO BY H. C. EBERHART.

NED COLVERT'S LOGGING TEAM. BLUE RIVER, INDIAN TERRITORY.



AMATEUR PHOTO BY A. R. ORDWAY.

ARE GIRLS A NECESSITY?

Highly Commended by the Judges in RECREATION'S  
Second Annual Photo Competition.



AMATEUR PHOTO BY F. H. HOLMES.

THE ONLY MOOSE IN CALIFORNIA.

Highly Commended by the Judges in RECREATION'S  
Second Annual Photo Competition.

### THE SWEET, OLD SONG.

“O, come where my love lies dreaming,”  
She hummed in accents low,  
And across the strings of her instrument  
She lightly drew the bow;  
“O, come where my love lies dreaming”—  
And out through the bedroom door  
There floated upon the atmosphere  
The sound of her husband's snore!  
—Cleveland Leader.



PIGEONS.

## WHERE ARE THE WILD PIGEONS?

STANLEY WATERLOO.

No more in Spring, when smelling things awake  
And thin ice silvers yet the shallow pools,  
And all is youth and strength and buoyancy,  
The upper vaults reveal wild visitors.  
No more the flocks show clear against the sky,  
Proclaiming Air, like Earth, alive again;  
No more the beech woods, brownly carpeted,  
Resound with rustle of the busy wings,  
No more, in Autumn, mighty stubbles change  
From yellow to the shifting mass of blue.  
The skies are still, the stubble tenantless;  
There are no Pigeons come in countless flight;  
They are all gone as is the Buffalo;  
Leaving the broad plains tenantless and dead  
Save for the smaller and less noble game,  
All the result of man's rapacity.  
Where are the birds? From equatorial fields  
Now fly they Southward to Brazilian wilds?  
Or were these living things swept from the earth,  
This type of hopefulness and daring guest?  
Did Man, the butcher, do his work so well  
That nowhere wing their way Wild Pigeons now?

Talk about a wild goose chase! Never did wild goose chase compare with the chase of the passenger pigeon, which has been going on for the last 15 years. We all know the story of the wonderful bird; the bird whose enormous numbers and striking characteristics made it rank, in one sense, with the buffalo, among the marvels of animal life on this continent. It was part of the great life of the spring and one of the features of the autumn, throughout the temperate zone, from the Atlantic coast to the Rocky mountains. It is a delightful memory to every man over 30 years of age, who was born in this country. Its existence made rural American life, throughout a vast area, different from life on any other part of the globe.

It was the wild pigeon that developed the sporting instinct in thousands of boys. As a game bird it became famous next to the turkey, and "pigeon pie" became one of the recognized American dishes. But the passenger pigeon was migratory. It nested in such manner that it became the easy prey of slaughterers, as did the buffalo, and it has gone, as has the buffalo. It was exterminated by degrees, territorially. It was formerly as abundant on the Atlantic coast as in the states of the Mississippi valley. New York, Virginia, and Pennsylvania, were among its favorite nesting places. In those states began the first scientifically conducted work of extermination, and with the instinct which God had given the bird it disappeared absolutely from that region, while still appearing in enormous flocks, and having nesting places in Michigan, Wisconsin and other inland states.

It is scarcely worth while to call attention to the magnitude of the flights which came in early spring from the equatorial regions, where the birds wintered. This

story has been told and retold from the time of Audubon. Almost every man, of middle age, can remember when the sky was darkened by the flights of flocks containing millions. They were the attractive feature of the upper world in spring time, and when a flock alighted to sweep the beech woods of the nuts which lay beneath the leaves of the preceding autumn, they afforded the first sport of the year to the average country boy, with the old muzzle-loading shot-gun, and the first delicious game pies of the season to the family. In autumn, the returning myriads made blue the yellow and brown stubble of the fields, and the farmers found, in the young pigeons, even better food than had come to them in spring.

In some as yet unsettled districts the birds had selected a forest in which the millions nested together, and a "pigeon roost" became the synonym for something vast. Great branches were torn away by the weight of the nests and the offspring; and wild cats, foxes and other carnivorous beasts fattened on the squabs which fell to the ground. Those, relatively to the millions above which lived to develop and make the Southern flight, were, until men came, an insignificant factor. Audubon, telling of a scene near a roost on Green river, Kentucky, says:

"The noise they made reminded me of a strong sea breeze among the cordage of a ship. When they passed above my head I felt a current of air which astonished me. Thousands were already struck down by men armed with poles, but they continued to arrive without intermission. Fires were lighted. The birds precipitated themselves in masses and pitched where they could, one upon the other, in large heaps like barrels. Then the branches gave way under their weight, cracked and fell, bringing to the ground and crushing the closely packed flocks which covered every part of the trees. It was a scene of tumult and confusion. In vain I tried to speak, or even to call the person nearest me. It was with difficulty I could hear the guns fired, and I only perceived the men had fired, by seeing them reload their arms.

"Pigeons continued to come, and it was past midnight before I noticed any diminution. The uproar continued all night. At last the day approached, the noise began to abate a little, and long before we could distinguish objects the pigeons commenced to start. At sunrise all that could fly had disappeared. Now it was the wolf's turn, the howls of which saluted our ears. Foxes, lynxes, cougars, bears, rats, opossums, and

martens, bounding, running, climbing, pressed to the quarry; while eagles and falcons, of different species, flew down to take part of such rich booty. The sportsmen then in their turn entered into the midst of the dead, the dying, and the wounded. The pigeons were piled in heaps. Each took what he wished and the pigs were left to satiate themselves on the remainder."

So said Audubon. When man came in a business way to the nesting grounds it was worse. He butchered where the wild beasts only ate, and so one great nesting place after another was deserted by the welcome visitors, and one state after another was totally abandoned.

After the remorseless system of extermination was inaugurated the birds disappeared from the East. They abandoned New York, Pennsylvania, and Ohio. In Michigan and Wisconsin they nested some years later. Then they went, and came back no more. Man's rapacity was too deadly for them. Their last attempt, of any magnitude, at habitation in the United States, was made in the Indian Territory nearly 20 years ago. Their enormous nesting there was made the subject of traffic, and the birds were shot from their nests, and were shipped, by car-loads, through the country, selling in the St. Louis market as low as 25 cents a dozen.

Spring came again, after the autumn of that great slaughter, and men looked into the upper depths for the pigeon flight, but saw it not, and never will see it again. What became of the passenger pigeon? Even the butchers, of the last year of the pigeons in the United States, must have left millions of them alive. Where have they gone? To learn what has become of them has been a subject of my research and the cause of no little correspondence, for several years. The result has not been altogether satisfactory; but a brief summary of what has been done may not be uninteresting.

First, search was made to learn whether or not the passenger pigeon had ever reappeared in the Northern Middle States after its last great nesting. There was much correspondence with naturalists and hunters and it was discovered that some of the birds had really come back again, in a pitiful, seeking way, and had continued to do so even up to as late as 4 or 5 years ago. In Illinois a close lookout has been kept for them. A leading Chicago naturalist, Mr. Edward B. Clarke, in April some 4 years ago, saw one in Lincoln park, Chicago. He says of the now novel spectacle:

"He was perched on the limb of a maple tree, and was facing the rising sun. I had never seen, in any cabinet, a more perfect specimen. The tree on which he was resting was at the Southeast corner of the park. There were no trees between him and the

lake, to break from his breast the fulness of the glory of the rising sun. The pigeon allowed me to approach within 20 yards and I watched him through a powerful glass that permitted as minute an examination as if he were in my hand. I was more than astonished to find here, close to the spires of a great city, the representative of a race which always loved the wild woods, and which I thought had passed away from Illinois forever. But then bird observation excursions are always full of pleasant surprises.

"The sun made the bird's every feather shine. Tennyson needed no special poetic license to speak of this traveller of his kind as a 'burnished dove.' Not a single feather was misplaced, and about the neck there was the brilliancy of gems. I was joined, during my watching of the pigeon, by a man 50 years old who confessed that while he had heard of the birds, frequently, he had never seen one. That man, during the first 25 years of his life, must have been afflicted with blindness. He thought it would be a good idea to get a gun and shoot the pigeon. He had no soul above pigeon pie.

"It was a low limb on which the bird perched, and when I had satisfied my eyes I wanted to flush him, that I might once again see the graceful, rapid flight familiar to me as a boy. I approached the pigeon slowly. As I neared him he began moving his head, first to one side and then to the other; though with a half forward movement, as is the custom of his tribe. I diminished the distance by 5 yards. He still clung to his perch. Five yards more; I was within 30 feet of him. Then he launched outward from the limb, and, to my dismay, winged his arrowy flight straight down the Lake Shore Drive, toward the heart of the city.

"Within 2 years a pair of these birds appeared at Lake Forest. They perched side by side on a tree, in the grounds of one of the handsome residences of the suburb. Both were killed, with a single discharge of a gun, and were thus sacrificed to a mistaken idea of science."

A year or 2 later hunters, in one of the preserves on the Illinois river, stumbled on a group of perhaps a dozen, where a cock and hen were shot. Other groups, not large enough to be called flocks, have been met with in Missouri and in the Indian Territory; but there is no record to the effect that any have been seen in quantity within the last 10 or 15 years, though inquiry, wide and exhaustive, has been made and has been cordially assisted in by those who could aid most.

Early in the spring of the present year a newspaper paragraph went the rounds, to the effect that the wild pigeon—that is, the passenger pigeon—had appeared again in the United States, this time West of the

Rocky mountains, and in Shasta County, Cal. Correspondence was at once begun with T. J. Houston, Sheriff of Shasta County; Alexander T. Vogelsang, of the California State Board of Fish Commissioners, and with Governor Budd and others of the authorities. All responded readily and kindly, and the query was referred by the Governor to the California Academy of Sciences. The result was just what I had anticipated. It is shown in the following letter:

San Francisco, Cal., June 17, 1897.

Dear Sir: Your letter of June 2, addressed to Gov. Budd, asking for information regarding the Shasta pigeon-roost, has been referred to the Academy for a reply.

We have heard of no such roost in the locality mentioned, and the pigeon referred to is probably the Band-tailed Pigeon (*Columba fasciata*) as the Passenger Pigeon (*Ectopistes migratorius*) is not a California bird.

Yours truly,  
E. A. M. Illriach,  
Assistant Secretary.

So one dream of the return of the Passenger Pigeon was soon dissipated. The band-tailed pigeon of California is a fine bird, but of quite another nature. It is thus described by T. W. H. Shanahan, of Anderson, Shasta Co., Cal.:

Anderson, Shasta Co., Cal.,  
July 21, 1897.

Dear Sir: Your letter of June 2d, to Governor Budd, relative to the wild pigeon in this county, was referred to Professor Le Conté, and by him to me.

It is true there was a somewhat larger flight of the wild pigeons in this county, than usual, this year, but not to the extent the papers would lead one to believe. Every year we have a few, and in those years in which the acorn is produced in greater abundance, the pigeons materially increase in numbers. This pigeon is of a slaty blue color, with an iridescent ring  $\frac{1}{2}$  to  $\frac{3}{4}$  of an inch wide, and headed by a narrow white circle, around the neck. The wings are wide and pointed and darker toward the tips, and the tail, square. They are similar to the English wood-pigeons in marking, size, and habits. These birds are of great vitality, and are able, when shot, to carry a great deal of lead. When torn almost to pieces, they are able to fly to quite a distance. When they fall, it is in a slanting manner, with wings outspread.

Hoping this will be of service to you, I am

Very truly yours,  
T. W. H. Shanahan.

Oddly enough, there is still a flock of passenger pigeons in Wisconsin, though it is an abnormal one. A flock of 14 escaped

from confinement, in Milwaukee, toward the end of last winter, and since then some of the birds have been seen in Lake Park in that city. Mr. Frederick Wahl, of 591 Frederick Street, Milwaukee, contributes the subjoined details.

"Dear Sir: Your letter in reference to Wild Pigeons at hand. Mr. Whittaker, who formerly had what was supposed to be the only specimens of these once numerous birds in captivity, lives at North Avenue Bridge, this city. I learned from Mr. Whittaker that the pigeons got away from him, while he was making alterations in his house, last winter. He says he was told by an attendant at Lake Park that his pigeons were nesting in the park and that they had been seen there, at various times, by the said attendant. Mr. Whittaker informs me he had 14 in all, the same being raised from one pair of old birds.

"Mr. Whittaker took great pride in showing interested persons the pigeons and I took a good look at them during last summer. They were, without a doubt, the genuine article, the wild or passenger pigeons. . . . They were in a space open on one side and fed on grain, like other pigeons. They were also fond of angleworms, which were sometimes fed to them in summer."

This is unimportant save as showing the interest men feel in the great passenger pigeon, that was and is not.

But of more importance, perhaps, than any information yet obtained, regarding the present existence of the Passenger Pigeon, is the testimony of Mr. A. Fugelberg, of Oshkosh, Wis., who says he has seen different flocks of them during the present year. He writes like a man who knows, thoroughly, what he is talking about. His letter is as follows:

"It was I who saw the flights concerning which inquiry has been made. I saw the pigeons August 14th, between 6 and 7 o'clock a.m. They flew from Fisherman's Point across the bay to Stonybeach, on the West side of Lake Winnebago, and as I live half way between the 2 points, which are only about  $1\frac{1}{2}$  miles apart, I had the pleasure of seeing them very plainly. It was a pleasure, for I had not seen any for a number of years. It reminded me of those years from '58 to '76 when I saw them by thousands fly over this same bay, and shot many of them. These pigeons of the 14th of August flew in flocks of 20 to 75. I saw only 7 flocks, but others may have passed before I noticed the flight. Two flocks came within gunshot of me; the others were from  $\frac{1}{4}$  to  $\frac{1}{2}$  mile away. I called my boys, that they might see the pigeons, as they had never seen any before. One boy said it was no wonder I had shot so many, in former years, if they came like that!

"These are all the facts I know, person-

ally, regarding the flight. I saw a man coming from the country, the same day, who said he saw some of them.

"In the early part of September I was hunting prairie chickens when I came across a farmer who told me he had seen a flock of pigeons a few days before. This was on the North shore of lake Butte des Morte.  
A. Fugelberg."

\* \* \*

The search has but begun. What became of the few millions of pigeons left after the ruthless demolition of their last great roost, in the Indian Territory? The flock, if one remained, of course returned, for the winter, to its Central American home. With the instinct of knowing when a territory had become uninhabitable it decided to return no more to the United States. What then became of it? Is it not now annually flying Southward, and making its great roosts in the vast wild region forming the central part of South America and having for its food the nuts and berries of the vegetation lying between the Andes and the peopled area along the Atlantic coast? This is a portion of the problem yet unsolved. It is a matter of extreme difficulty to reach, by mail, or to find in any way, in-

telligent observers in any portion of the region over which, in theory, the passenger pigeon may now be flying.

It is on one point that information is earnestly desired. There must be, among the thousands of readers of RECREATION some men who have greater facilities than I for ascertaining what may be the natural facts as to the interior of South America. Assuredly the search should be maintained. The wild pigeon is a thing of delightful memory to many of the living, and has become, and will remain, not merely in natural history, but in song and story, throughout all the great region it once traversed, a creature of importance.

If an excuse be needed for the length of this article it is that its substance must appeal to all who remember the country as it was; who miss the note of the flail, or the scythe-stone, and, above all, the overhead thunder and flutter of wings, in the spring time and in the autumn.

What is here told is truth, not guesswork. It is the result of some years of inquiry, with all the enthusiasm of a boy who once killed 14 wild pigeons at one shot, but who would to-day make an effort to preserve the life of even one of these romantic and mysterious birds.

---

## HOG KILLIN'.

W. H. NELSON.

Come over, Bill, t' our house;  
We're goin' to kill the hogs.  
Pap's heatin' of the worter now,  
On a big fire o' logs.  
He's got the hogs'ed tilted down  
To scald 'em in, you see;  
And gamblun' sticks all made and piled  
'Long side the apple tree.

Mam's flyin' round the kitchen like  
A kitten in a fit,  
A'cookin' cakes and bakin' bread,  
And scoldin' fit to split.  
There's mince pies in the pantry,  
And cookies in the churn,  
And there'll be swads o' gravy, 'less  
She ups and lets it burn.

Me 'n' you 'll be the company;  
We'll jist be everywhere;  
We'll watch 'em shoot 'nd stick the hogs  
'N' scald, 'n' yank the hair,  
'N' Pap 'n' Jone, 'n' Uncle Bill,  
'Ll hang 'em high 'n' dry,  
'N' rip 'em down, 'n' 'en, by jing,  
You'll see the insides fly.

We'll steal the bladders, me 'n' you,  
'N' blow 'em with a quill,  
'N' kick 'em 'round, 'n' belt the gals,  
'N' laugh jist fit to kill.  
We'll cut off all the tails, 'y gum  
'N' roast 'em on the coals,  
'N' stuff till we jist purt' nigh bust  
'Th pies, 'n' cakes, 'n' rolls.

We'll set up late 'n' watch 'em grind  
The hunks o' sassage meat,  
'N' split 'n' scrape the heads, 'n' see  
Mam trim 'n' clean the feet.  
So, come fer sure to-morrer, bright  
'N' early fer the fun;  
'N' stay all night, 'n' sleep 'ith me  
When butcherin' day is done.



## A CART LOAD OF GEESE.

J. F.

"Dreaming again, old man?"

"No; hardly dreaming; just wandering back about 20 years; thinking of the grand times I used to have with old Jock; and especially of the night we shot the snow geese, just before our wedding."

"Write the story of that hunt, for RECREATION."

And no sooner said than done.

Poor, dear old Jock; a faithful friend; truthful to the letter; an expert hunter, a good shot, one of nature's noblemen, and yet a half breed Indian. May we meet on the other side of the range.

For 11 years we lived side by side, and hunted together in the wild muskegs, on the untrodden prairies and in the forests of Manitoba.

The old man had crossed the country with Dr. Rae, and other celebrated men, when it was known to only a few Hudson Bay employees, and when it was overrun with Indians and buffaloes. As a natural consequence he had an unlimited fund of anecdotes and reminiscences to draw on, such experiences and adventures, in fact, as fall to the lot of few men. But while thinking of that dear, honest old friend I'm wandering from the hunt I was going to tell you of.

More than 20 years ago old Jock came up to my bachelor establishment, one evening, with his usual cheery salutation, "Hello, boy." I knew by his smile he had good news.

"How'd a wavey hunt go, boy? They're flying some to-day, and to-morrow they'll all go North."

"I'm your huckleberry, Jock," I said.

"All right, boy; come along. Bring lots of shells. I'll have old Blue in the cart by the time you get down."

I rolled up a blanket, 200 shells, and the little 16 gauge gun; some newspapers, for decoys, and away I went to Jock's house. Old Blue was harnessed in the regular old "shaggi nappi" harness and hitched to the Red river cart, used by the plains hunters in the palmy days of the buffalo.

The harness was made of rawhide, generally buffalo hide, about 3 inches in width, and sewn with deer skin thongs.

The cart—all hand made, without a single nail or a piece of iron in it—had wheels some 6 feet in diameter. The shafts formed the body of the cart, by extending them some 3 feet back of the wheels. A few stakes on each side and a rail on the top formed the sides. A raw buffalo hide covered the bottom and made side boards.

This was just the rig to cross the boggy marshes with. It furnished both music and

exercise, for its occupants. Its old hubs, worn by years of hunting had abundance of play, and squealed and wailed in every key, as it jolted from hummock to hollow in a vain endeavor to dislodge the passengers. Old Blue was blind in one eye, and he was as honest as his owner. He required no driving. Once hooked in Jock walked ahead and old Blue's nose was at his back. When Jock pulled something had to come.

The 21st of May, 1875, saw 2 happy men wending their way slowly into the big marsh that extends from the Red river a distance of 25 miles due East, and is several miles wide.

A few geese were flying North as we reached the hunting ground; so we hustled old Blue into some willows and in 10 minutes had our blinds up, on either side of a burned strip of grass. A second growth had sprung up green, making a great contrast to the dry hay on either side.

About 70 yards to windward we set up some paper decoys and soon the ball opened. The wavies (snow geese) would come falling over each other at Jock's perfect call. They would sweep away past us, and then turn, sailing gracefully up to the decoys, against the wind. On they came between the blinds, "kuk, kuk, kuk."

"Now, boy!" And old Jock's little 20 gauge and the trusty 16 speak, and we have some more decoys to put out.

As the sun sets the flight increases. The full moon rises as old Sol dips in the Western horizon, and still they come. "Quoh, quoh," as far as we can hear, the chattering is going on. Flock after flock comes in to the decoys and the dead flock grows apace.

Suddenly the wind changed and came from the North; oh, such a cold blast! The wavies felt it too, and began to light. There were miles of them, like long snow banks.

We shot, and called till we were hoarse, and they fluttered about our blinds almost at the very muzzles of our guns. The reports only brought more birds, and we got more shots. We gathered none till morning. It was impossible to mark them down, in the moonlight.

At last we got hungry, made a cup of coffee, and then took our blankets and curled in the blinds to await the coming of daylight. But it was no use. The geese kept coming and squawking over our blinds, and gave us no rest.

We would get up and fire a few shots and then a lull would come. We would try to sleep, but scarcely would we close an eye before new flocks would come and the pandemonium would be turned loose again.



"SO WE LOADED THE CART WITH GEESE AND WALKED HOME."

At the earliest streak of dawn they began their flight and for about 4 hours the fun was fast and furious. By 10 a.m., only a few scattering flocks were seen and the warm spring sun was making us very sleepy; so we loaded the cart with geese and walked home. Jock's boy returned for the rest of them, next day, and the goose hunt of my life was a memory.

Slaughter? That's right, Coquina; but

this was before the day of game laws, game wardens, RECREATION Magazines or advanced sentiment in favor of game protection. It was in the buffalo days. It was when everyone thought the game would endure forever, against all comers, and no one thought of saving any for seed.

The geese were dressed and smoked and the half breeds ate the last mother's son of them.

## ELKLAND.

### IV.

#### FLIES AND WEATHER.

ERNEST SETON THOMPSON.

Before coming here I heard a vulgar person intimating, in a slangy way, that the little creatures known as flies did not exist in this region. To-day, especially, I

ples, picked off my face and neck while sketching.

Each is provided with a steel pointed drill, a suction pump, a bag of lunar caus-



have been revelling in disproofs of the assertion. It was over 85 degrees in the shade; there was no breeze and the number of different kinds of flies at large was painfully extensive. Here are a few sam-

ple, a hungry belly and a song like that of a saw mill—at least all but second and seventh. They do not sing, for they have no wings and do not seem to need them. They belong to the interesting group

which "ultimately arrives, notwithstanding." That last fellow, too, is as silent as the grave, and just about as good company. He always lands on the point of his beak and when he strikes your horse you might as well let him take the reins and drive; for he is master of the situation and everyone concerned knows it. But there is one advantage about this species when you do hit one, be it ever such a little tap, you make everlasting smash of him. He's



a total wreck, and he drops at once and forever. Within one minute of his downfall an ant, about one-tenth his size, is sure to find the remains and, hoisting

them on his energetic little shoulders, goes tramping off merrily through the grass, out of sight. I usually kept the ants busy removing such remains whenever I sketched; and in fact they soon learned to gather about me, in an expectant circle, as soon as they saw me set up my white umbrella.

Now, while we are talking about flies, a curious question arises in zoölogy. If horses thrive so well on the plains, why did the indigenous American horse die out, as it certainly did, over 1,000 years ago? I can readily believe it was killed by flies, or perhaps by some especially virulent horse-fly, which by killing its host, condemned itself to extinction.

We know the tse-tse, in Africa, can clear its region of domestic animals in a month. We know the *Cestrus* can exterminate the caribou in a given district; that

the buffalo gnat is worse than a plague on the New Mexican and Texan cattle ranges, and that the very note of the *Tabanus* is enough to drive horses over a cliff. It is also probable the prehistoric American horse was less capable of resisting the attacks of these pests than the Asiatic horse we have introduced; for the latter is well known to be the thickest-skinned and hardiest of the group.

You will notice that so far I have not alluded to the weather; and I might still refrain but for the fact that while you, in New York, are stricken by terrible heat we have been having a remarkably cool season, with several falls of snow, during June and early July.

One remark made was "We are having a fine open winter, this summer." This much, at least, is always true of the Yellowstone Park region: However hot the day, the nights are cold. Such lovely sleeping nights! There is no such thing as tossing about, unable to sleep. Here every night in the year is served on glacier ice.

Each night, after sundown, we are glad to gather around the huge, log fire. The insect pests are gone and we enjoy the blaze as in an old-fashioned winter evening. Then we write up our notes and toast our shins until the hour, quite early, arrives for us to accept the yawning invitation of the Kenwood sleeping bags; for in shanty or in camp we cannot do without them; and, surrendering ourselves gladly, we are swallowed alive into their capacious but cozy maws, safe from damp, safe from cold, and safe from the "pestilence that walketh in darkness."

---

## CAYUGA LAKE COONS.

LOU SMITH.

The shores of Cayuga and the ravines through which many streams trickle merrily down to the lake, have been inhabited since the memory of man runneth not to the contrary by that nocturnal prowler, the raccoon. As long as he confines his wanderings to the vicinity of the rocky ledges that line the lake and its feeders, he is safe from his pursuers. However, cunning as the 'coon is, he often wanders back into the interior, and once away from the cliffs, he can be captured by aid of "'coon dogs."

During the last week of September, a party of 4 Ithacans saw 3 young 'coons cross the road, just at sundown. This was some 5 miles West of Ithaca, and as many miles from the lake. If found in this locality again, and pushed by a trusty dog,

these coons would have to take to accessible trees instead of inaccessible rocks. With this happy climax in view, a party was organized, consisting of 5 congenial souls. Our jolly landlord, who, by virtue of the tempting menu at the "Oriental," tips the scales at 250 pounds, is known to all Cornell men as "Jay." Walter Franks, of race horse fame, sat beside Jay, and gave him pointers on reining cobs: which the driver declared uncalled for and wasted entirely, for had he not handled the ribbons over a buck-skin pacer recently, that finished fourth in a matinee race? Franks admitted this, but insinuated that there were but 4 starters in the race. Franks stands 6 feet 5 inches with his stockings off, and weighs about 130 pounds, so

we had a little side show of our own on the front seat.

The second seat was occupied by Mr. Stanton—an instructor in Cornell University—and his famous "'coon dog," Lead. The last seat of our surrey held Mr. Stanley, a student from California, who is the hero of a thrilling adventure in the Rockies. Stanley claims to have routed a band of robbers; but his companion told me, confidentially, Stanley pulled his gun and looked for desperadoes after he had been relieved of his watch and purse, and when the train was under way and well rid of the highwaymen. Beside the hero, I sat, a quiet, unpretentious fellow, who does not boast much, but knows a few things about 'coons and dogs, nevertheless.

This was our party, and we arrived in due time at a farm house, near the grounds where the game had been sighted. Here the hound was loosed, and he soon found a trail, which led us a merry chase for half an hour; and if there was one brier-patch or wind-fall through which this coon did not take us, the county map does not show it.

The fat man and the skeleton fought for second place to me, for I led the chase and carried the lantern. Our California friend brought up the rear, with Stanton a length ahead of him. Though the pace was a killing one, all went well until the Skeleton got his feet tangled in a hole, and the fat man fell squarely on top of poor Walter, who set up such an unearthly wail that our

friend from the woolly West imagined a panther was after him, and crouched in fear, with gun at full cock, ready to defend himself if necessary. A halt of 2 minutes brought the lean man around, so he could join the chase.

We soon caught up to the dog, barking at the foot of a half-grown hemlock. A careful search revealed a dark object, away up near the top of the tree. Everybody wanted to see the fat man climb, but he complained of a sore stomach, from his fall on Walter; so it was decided Stanley should shoot at the dark object, to see if it were alive. He aimed his little 16-bore Ithaca hammerless, and with the report, down came a 23-pound 'coon.

Another hour passed, without a find, when suddenly Lead struck a hot trail, in a buckwheat field. Away he went, filling the air with the music so sweet to the hunter's ear. The chase was a short one, and we soon recognized the old dog's "bark up." He was in an adjoining pasture, trying to climb an elm tree, in which the full moon showed us 3 small, round objects. With 3 cracks of the Ithaca, as many young 'coons bit the dust.

These, we were sure, were the ones we had seen a few days before, and the game we were after. Now, out of pity for the fat man, who was pretty well warmed up and blowing hard, we turned toward town. The following evening we all met at the "Oriental," and enjoyed a bountiful spread, in which baked 'coon was much in evidence.

---

## PIERRE'S STRATAGEM.

H. D. LEADBETTER.

"'Twas one dark night on Lack Champlain, an' de win' she blow, blow, blow;  
An' de crew o' de wood-scow, Julia Le Plant, got scare an' run below.  
For de win' she blow like a hurrican; bam-bye she blow sum more.  
Dat scow buss up on Lack Champlain, 'bout half male from de shore."

As the words of the old song rang out, in the peculiar accents of the French Canadian, over the blue waters of Missisquoi bay (an arm of Lake Champlain extending into Canada), the flat bottom of a fishing-boat grated on the sandy beach, and the singer, a tall, well-built young fellow, sprang lightly to the shore. Carefully pulling his boat out of reach of the waves, he removed the oars and hid them in a clump of pines.

He was evidently dressed in his "Sunday best," and he carefully adjusted his

high celluloid collar and sky-blue tie. Then taking a pair of yellow kid gloves, wrapped in a paper, from the boat, he laboriously put them on.

"I wonder w'at Marie will t'ink of dem glove," he murmured, holding up his hands and gazing at them admiringly. "G'ess she t'ink Pierre Le Clair some punkin now."

Throwing up his head, he settled the flat-topped derby hat more to one side, twisted his mustache to a wisp at either end, walked rapidly to the little cottage on the hill, and knocked at the door.

"How do, Pierre," said the little, withered old woman who opened the door; "come rat in. Dere's man here w'at wants hunt de duck on de lack. She's go-in' board here an' wants mans to row de boat. I tole him dat Pierre he know all

'bout de duck. Tink you git good job; make quite lot money for row dat boat."

"Where's Marie?" asked the young man, more interested in the girl than in the prospect of rowing for the duck hunter.

"She's up de stair fix de room for dat man. Oh, he's gran' gen'l'man, from de cety; nace lookin' young mans!" she ran on.

"I don't lack dat young man be here," muttered Pierre, shaking his head as he reluctantly pulled off the gloves he had hoped would make such a favorable impression on the girl. Soon Blake, the young sportsman who had so excited the little household, entered the room and arranged with Pierre to row him up the bay, the following morning.

"I dunno 'bout git many duck," said Pierre. "No big black Canadaw duck come Sout' yet; but t'ink we git sum dem 'il brown duck, in ricks, by de m'ash."

Next morning the decoys were packed into the boat and Pierre rowed to the mouth of a small creek, which flows into the bay. The young Frenchman placed Blake behind a screen of willows, on a point of land near the mouth of the creek, and anchored the decoys in the stream, a short distance away. "Now, I go up in t'udder creek, by de ma'sh, and drave de duck out; den day cum in line and you shoot him," he said, as he rowed away.

In about an hour, Blake heard the boom of Pierre's muzzle-loader; and soon a pair of blue-winged teal came in, swooping down as they saw the decoys. Firing both barrels of his little 12 gauge hammerless, he brought down one duck, but made a clean miss with the second barrel. At intervals, during the afternoon, the birds came in, sometimes singly and again in pairs, until nearly a dozen lay on the water, among the decoys.

"I t'ink you got some duck," said Pierre, as he rowed around the point. "Guess we go home now. To-morrow I put you in nudder place, and drave de duck in dere."

Day after day they hunted ducks in the creeks and marshes, always getting enough birds to satisfy Blake, who enjoyed every day of his outing as he had never enjoyed life before. They varied the sport by shooting ruffed grouse, on the hills. Pierre had a spaniel which, he proudly assured Blake, "was de bess dog in Canadaw. He bark de bird up in de tree, den we shoot him."

"Shoot the dog?" innocently inquired Blake.

"Naw! naw! de bird," said Pierre. He was much surprised when Blake insisted on letting the birds fly out of the trees before shooting them. "I doan' see no sense in dat way—jus well shoot him when he set still," he grumbled.

Possibly part of Blake's enjoyment was due to plump, bright-eyed Marie, who

cooked the game in a way that seemed perfect to him. She was young, pretty and vivacious, and Blake was so different from the young men of her acquaintance, that, when he made love to her, as of course he did, Pierre, her old lover, was forgotten, much to his discontent. Each day she grew colder to Pierre, and cast more languishing glances at Blake, until the young Frenchman was half mad with jealousy.

One day, near the end of Blake's vacation, the hunters had returned after dark, from a trip up the lake. As Blake was going back to the boat for his shell case, he heard a voice, and stopped a moment, to listen.

"Tain't no use," said Pierre, who was sitting on the boat, soliloquizing, after his peculiar manner. "'Tain't no use. She lack dat man. Prob'ly she marry up along wid him and go to de city. Dam' dat man! I wish he doan come here." There was a trace of tears in his voice, then he continued: "Dat win' she blow from de Sout' to-night. T'ink she blow hard to-mow. S'pose I tell dat man I can't go hunt to-mow. Tell him he teck my l'il boat and go to dat crick udder side dat p'int. He's dam fool 'bout boat—like all city mans. S'pose he get drown. Pierre don't be blame. He be gone St. Arnaud. By *Sacre!*" he said after a long pause, "I t'ink I do dat t'ing!"

Almost bursting with laughter, Blake hurried back to the house. "Pierre," he called, loudly, "are you down there!"

"*Oui, M'sier*, w'at you want?"

"Bring up my shell-case; it's in the boat."

"Say, *M'sier* Blake," said Pierre, as he handed him the case, "I got go St. Arnaud to-morrow. You can teck my l'il boat and go to dat crick t'udder side dat p'int, and I t'ink you got some duck."

"All right," returned Blake, "I'll show you, when you return, I've learned something about duck shooting; so look for a big bag to-morrow night." Unable to conceal his smiles, Blake entered the house.

In the morning Blake took his lunch, as usual, and although a strong wind was rolling the angry, white-crested waves into the bay, he started out in the little boat; for he had managed the cranky Saranac boats, used by the guides in the Adirondacks, and had no fear for his safety. Holding the boat bow on to the waves, he rowed out of the bay; but as he doubled the point, it looked for a moment as if Pierre's hopes would be realized. A huge wave, striking the boat nearly broadside, half filled it with water, and the wind caught his cap and carried it away. He managed to make a landing on the point, out of sight of the house. Then he hid the oars in the bushes, turned the boat bottom up, and pushed it out on the water, beyond the point, where the waves would carry it into the little bay near the house. He watched it drift slowly

toward the shore, then shouldered his gun and started on his tramp around the bay.

It was evening when Blake returned to the house, and rain was falling. He paused for a moment beside the kitchen window, and looked into the room. On the table lay his cap, dripping with water. In a chair near by sat Marie, her face buried in her apron, sobbing bitterly. Beside her stood the old woman, wringing her hands, while tears were running down her wrinkled cheeks. Near the table stood Pierre, the picture of guilt and misery. For a moment Blake wondered if any of his city friends would more sincerely mourn his loss than did these 2 women. Somehow their sorrow spoiled his enjoyment of the joke he had played on Pierre.

The door was ajar, and forgetting he was hatless and dripping with rain, Blake pushed it open and entered. With a wild yell, Pierre fell on his knees, behind the old woman, his eyes bulging and his teeth chattering with fear.

"Mon Dieu! Mon Dieu! dare he is! tack him away! tack him away!" he cried. "He dead, and I make him git drown. I give myself up and be hung, af you tack him away!" The women were staring with astonishment at Pierre, for they had not

seen Blake. "Doan you see his ghost dare on de door?" he cried, pointing his trembling finger at the dripping sportsman.

The ludicrous appearance of the tall Frenchman, cowering behind the old woman, was so comical Blake leaned against the door and burst into laughter. Slowly Pierre arose to his feet, and as the truth dawned on him, he came forward, trying to smile.

"We's ver' glad dat you doan' get drown, *M'sier* Blake. I fin' dat boat and you hat, and we t'ink you drown," he said. "I doan' fin' de oar, but I s'pose you pay for dem if we doan' find him." The rapid change, from the terror-stricken, cowering wretch to the smiling, self-assured young man, anxious to get a good price for his oars, only increased Blake's mirth.

"Your oars are all right," he said, when he had recovered himself; "they're hidden in the bushes, on the point—but I heard what you said about trying to drown me; and if you don't get Marie to marry you before I come again next year, I'll have you arrested, as sure's my name is Blake."

"I dunno if I do or I doan'," said Pierre, looking shyly at Marie. "I lack to got marry up along wid dat girl, an' I do ver bess I can."

---

## THE WOLF QUESTION.

FROM SOUTHEAST MONTANA.

Stacey, Custer Co., Mont.

Editor RECREATION: Replying to your questions regarding the wolf pest:

1. Where are you located?

In the Southeastern part of Montana, about 40 miles due South of Miles City.

2. Are gray wolves troublesome in your region?

Gray wolves do a vast amount of damage in this section of country.

3. What do they destroy? Horses? Cattle? Sheep?

They destroy cattle, sheep, and horses. Most damage is to cattle and colts on the range. The wolves do not have so good a chance to kill sheep, as there is always a herder with them, though they occasionally raid them, too; not hesitating to go into the corrals at night. Many people do not use corrals but simply "bed them down," i.e., bunch them on a small piece of ground and hold them till they lie down for the night. It is then that Mr. Wolf gets in his best work; for he will stampede them from the "bed ground," killing numbers of them and scattering the remainder over the range.

4. About what amount of damage should

you estimate they do in a year, in your county or range?

It is a difficult matter to form an estimate of the damage done by wolves; but I feel safe in saying that in each county of this State the stock killed annually by them amounts to many thousands of dollars. My individual losses, in the last 4 years, amount to upward of \$500, and my losses have been small compared with those of some of my sheep raising brethren, owing to the fact that I always put my sheep in corrals, at night.

5. Did you ever *know* of a gray wolf killing or harming a human being?

No, I never heard of a gray wolf attacking a human being in this State, or in any of the grazing States. They are very cowardly.

6. Are wolves increasing in numbers?

They are increasing here, though the State pays a bounty of \$3 on each wolf killed.

7. Have you any reason to believe wolves can signal across country, and so tell each other what parts are dangerous or where the hunting is good?

Yes, I believe they can and do signal to each other. Three years ago I called one up to within 30 paces of me. I was work-

ing, about a mile from my ranch, and for more than 2 hours, in the morning, heard a wolf howling, about  $\frac{3}{4}$  of a mile away. He kept it up so long that my curiosity was aroused, and I concluded to investigate. I accordingly went to the top of a small hill, about  $\frac{1}{4}$  of a mile from where I was working, and in the direction of the wolf. I crouched down behind a rock and began to howl, as nearly like the wolf's howl as I could. I must have given a good imitation of the genuine howl; for at my first outburst I got an answer. I returned the compliment and he replied. After howling a few times I found he was coming nearer. In a short time I saw him coming up a long draw, and heading for the hill I was on. Occasionally he would stop and howl and I would answer. He would then come on again, in a long, swinging trot.

When he got quite close I ceased answering, and he slackened his pace. I could hear him making a noise something like that of a dog whistling, or whining, through his nose. When he got to the foot of the hill he sat down, like a dog, and gave one long mournful howl. As he lifted up his voice, and his nose too, I could see that his cheeks were covered with the fresh blood of some animal he had lately killed.

He then began to circle around the hill and as he did so I crawled around the rock pile so as to keep it between us. Finally he came to my trail where I had gone up the hill. He took one sniff of my tracks, tucked his tail between his legs and ran as if old Satan were after him. Unfortunately I had no gun with me, so he got away. I think his howling was a signal for other wolves to come and eat with him.

On still nights, in the winter, we often hear them calling to one another.

8. What is the average and the greatest weight and measure of a wolf, according to your certain knowledge?

I never weighed or measured one. Should judge a large one to weigh about 100 pounds. Perhaps 70 to 75 would be an average weight.

9. Do you consider the coyote a nuisance; or do you consider the harm done in killing lambs, etc., more than balanced by the good they do in keeping down gophers, ground squirrels, etc.?

To the sheepman I know, for a certainty, the coyote is a great pest, as well as the gray wolf. He is a sneak thief and many a lamb and sheep he gets. Cattlemen tell me the coyotes also kill many calves. The good they do in killing gophers, etc., is trifling compared with the damage they do to stock.

10. What do you consider the best means—legislative and practical—of dealing with the wolf question?

The most practical, and the best plan, for

their extermination, I believe, is for Congress to come forward and offer a bounty on scalps, no matter where killed, and make it large enough to be an inducement for hunters to get out and "rustle" for wolves. A \$10, \$15, or \$20 bounty would not be too high.

If Congress does not take up the matter, then I believe the next best thing would be for the States that are most affected or interested to come to some understanding whereby the bounty law of each should be alike, and high enough to exterminate the pests. I do not believe any \$3 or \$5 bounty will ever do it. It ought to be at least \$10.

It is almost useless for any one State to pay a bounty on scalps, as they will come into it from other, adjoining States, either on foot, or unscrupulous persons will bring in their pelts and swear they were caught within the confines of the bounty paying State. W. A. Cameron (Sheep raiser).

---

FROM NORTHWESTERN MONTANA.

Rosebud, Mont.

Editor RECREATION: Here are my answers to Mr. Thompson's wolf questions:

1. Where are you located?

On Otter creek, Custer Co., Mont.

2. Are gray wolves troublesome in your region?

Very.

3. What do they destroy? Horses? Cattle? Sheep?

Cattle and horses.

4. About what amount of damage should you estimate they do in a year, in your county or range?

The amount of damage done by each wolf is very hard to estimate, here, where the cattle range through the rough hills; but I am certain each bunch, of 3 or 4 to a dozen wolves, kills more than one animal a week, and often one each night, for many successive nights. These bunches do not hesitate to kill even 3 and 4 year old cows, steers and horses, when they do not happen to see fat young animals that are easier game. In many cases the wolves do not return to an animal they have killed. I am therefore conservative in estimating that each wolf destroys at least \$100 worth of stock each year of his life. They are also very prolific, one she wolf often raising 8 or 9 strong, healthy pups.

5. Did you ever *know* of a gray wolf killing or harming a human being?

No. There are too many cattle and horses here, to kill, for wolves to ever get hungry enough to attack people. All the wolves killed here are fat.

6. Are wolves increasing in numbers?

Three years ago they had become so thick the stockmen, in order to keep them from destroying all their stock, were com-

pelled to keep men on wages who did nothing but "wolf" all the time. These men thinned out the wolves so that the loss was, for a time, comparatively light. Many of the stock men accordingly withdrew their wolfers; and now the wolves have again increased to perhaps one-half what they were 3 years ago. They are also much more cunning than formerly, and harder to kill.

7. Have you any reason to believe wolves can signal across country, and so tell each other what parts are dangerous or where the hunting is good?

I have often noticed that when a beef had been killed wolves, smelling the fresh blood, would begin howling. Answering howls would be heard in the distance, but I do not attempt to assign any definite meaning to these howls.

8. What is the average and the greatest weight and measure of a wolf, according to your certain knowledge?

I never weighed one.

9. Do you consider the coyote a nuisance; or do you consider the harm done in killing lambs, etc., more than balanced by the good they do in keeping down gophers, ground squirrels, etc.?

When compared with the wolves the coyotes do very little damage to cattle; but I understand they are troublesome among sheep. They do kill calves, occasionally. I think they do very much more damage than good.

10. What do you consider the best means—legislative and practical—of dealing with the wolf question?

A good cash bounty, of not less than \$3 or \$4, should be placed on wolves, and after they had become somewhat thinned down, the bounty should be raised, occasionally, until at last \$10 should be paid.

Every stock owner should devote time enough to wolfing to keep the wolves entirely killed out, on his own range. The large outfits would need to keep a man out wolfing, all of the time. The granger has not so large a range; but he should keep plenty of poison on what he has, during the entire year.

If all stockmen would do this the wolves would be soon thinned out so that the damage would be slight. But, unfortunately, a great many either fail to realize the importance of the subject, or else have too little faith in the methods of destroying the wolves. The result is that united and systematic work is not done. Although some outfits expend large sums of money on these lines, the results are not what they should be.

A bounty of enough consequence to call out wolfers, would make every one stand his proportionate share of the expense. The worst objection to it would be that wolfers would not want to kill unless they found their wolves, and, therefore, the

most effective methods of poisoning would be little used. As a result of a wide personal experience, and a long, careful study, I append here some hints on

#### HOW TO POISON WOLVES.

I recommend this method mainly to stockmen, who desire merely to get rid of the wolves, and who do not care about the bounty. The poison I have used with the best results is that in the form of tablets, each containing 2 grains of strychnia. These tablets may be obtained from any of the leading druggists.

Whenever a beef is killed the wolfer should save all of the tallow, to make baits of. The best part, for this purpose, is the fat around a cow's bag, as it contains more tissue and does not crumble easily. The kidney fat, and the other inside fat, may be used with ease if the wolfer will make his baits while the tallow is fresh, and before it has cooled and hardened; but if this fat, once gets cold it is so brittle it will crumble in handling.

The tallow should be cut into pieces a trifle larger than the last joint of a man's thumb and one tablet should be inserted in each piece. The baits should not be made too large, or the wolf will chew them too much, before swallowing, and then, tasting the strychnia, will spit out the bait. Neither should the bait be made too small, or it will not then sufficiently cover the tablet, and the wolf will strike it with his teeth, crushing it and tasting it, with the first bite. Furthermore, the small bait will not so readily attract his attention.

Having made the baits the next thing is to prepare the same number of sticks on which to set the baits. These sticks should be made from round twigs of not over a quarter of an inch diameter, and having the bark on them, so they will not attract attention. They should be about 8 inches long, and sharpened at both ends, so that one end may be pushed into the ground and the bait stuck firmly on the other end. An excellent material from which to make these sticks is the stem of the buck brush, so common in the West. These sticks should be cut while green and allowed to dry a day or two, when they will be strong and tough. If this wood is not readily obtained, dead twigs of willow, or choke-cherry, will answer.

A handy way to carry these baits and sticks is to place the baits on the end of a piece of canvas, fold in the sides, roll up a short way, then lay in the sticks and finish rolling. The bundle can then be easily tied on the saddle.

The wolfer now rides along the cattle trails and watches for places where all the trails converge into one or 2 principal trails. Then he selects a point where this big trail is well worn and has distinct



edges, and places 3 to 5 of the baits, on sticks, along the edges of the trail, about 10 paces apart. If placed nearer together they will show too plainly, and will frighten the more cunning wolves.

You will notice the grass is heaviest close to the large trail, say about 4 or 5 inches from the edge. All animals walk either in the trail or several inches to one side of it. The bait should, therefore, be placed on a stick, stuck up in this row of grass along the edge of the trail, for otherwise cattle or horses would strike the sticks and knock them down.

It is well to put the bait near a tuft of grass, or a small weed, or something of the kind, as the stick will not then attract too much attention. It is better to place 3 or 4 baits in a place, then go a mile or 2 along the same trail and put up more, than to put them all in one place, as there is less danger of one wolf's eating so many baits.

The wolfer should always place a few of the baits around any old carcasses he may find, for a wolf will often go to them and smell of them. It is better, in hot weather, to put several tallow baits on sticks near a freshly killed victim of the wolves, leaving the carcass undisturbed, than to poison the carcass. In fact this makes the surest bait of which I know.

Great care should always be taken to make as little sign as possible, and to arrange the baits so they will not make too great a display and thus frighten the wolves.

It is well for the wolfer to return to his baits about 4 or 5 days after putting them out; and if they have been taken, to replace them. It is of little use, when the baits are placed along the trail, to hunt for the dead wolves, for the following reasons: First, the wolf is travelling when he picks up the bait; and as it often takes at least 2 hours for such a bait to kill, he will usually die many miles from the place where he took the bait. Second, I am convinced the wolf naturally endeavors to hide, when he feels the poison acting on him. If he is a pup he will try to go to his den. If an old wolf, he will hide in a gulch, or a brush patch.

For these reasons the wolfer may become discouraged, at first, as he will find few dead wolves; but if he persist in his work he will soon notice a marked diminution in the number of tracks, and in the damage to stock.

Some of my reasons for believing in this method are: First: Whenever I have tried it, in a given section where it had not been tried, I have found that wolves would almost never pass the baits without eating them.

Second: In several cases where I have found an animal fresh killed, and have put up a few tallow baits around the carcass, leaving it undisturbed, I have found, on my

return a few days later, that the baits have been taken, and a part of the animal eaten. In such cases I have usually found one or more dead wolves within 100 yards of the bait. The reason for their dying so close to the bait, in such cases, is that they eat the baits first, and then spend enough time in eating at the carcass to allow the tablet to be dissolved and to take effect. Then, before the wolf realizes his condition, he is so far gone he can not travel far. In such cases they will often be found in a creek that may chance to be near by.

Third: Every time I have used this, faithfully, for a period of a few weeks, I have found the number of wolf tracks diminished, rapidly, until only a comparatively few would be seen. I will give one instance of this. In the summer of '94, the wolves had become so thick, on our range, that every important cattle trail would be filled with the tracks of large bunches of wolves that had passed along, the previous night. They were doing so much damage it seemed something had to be done immediately, although it was the general impression that effective poisoning could not be done in hot weather.

It was then I adopted the above method, and obtained remarkable results. The belt of country I worked in was about 20 miles long by 10 wide. After having worked on these lines 3 weeks I found very few tracks; and nearly all the baits I had put out, about 600, had been eaten by wolves, as I had been able to tell by the tracks I had seen, in many cases. It then chanced that 2 other men and I rode, in different directions, through this belt of country on the same day, thus seeing all the principal trails (which dry weather had made very dusty) on the same day. All were looking for wolf tracks and we found only some 5 or 6 tracks, all told. Scarcely any wolves were found in that section for some weeks; but of course before long they began to come in again, from the neighboring country.

During that 3 weeks I saw only 10 dead gray wolves that the baits had killed; but I have every reason to believe I killed more than 100, and that I would have found many more, had I looked for them. I had one good chance to watch the effect of the poison on a bunch of about 10 wolves that were killing colts and calves in the pasture, nearly every night.

By watching their tracks I found that this bunch spent the days in a gulch, near the ranch. I put out a few baits along the trail leading to the gulch, and around the last colt they had killed, also about their last calf. Three days later I found that the baits had all been eaten and one dead wolf was lying not far away.

I put up more baits and returned a few days later, to find them all gone and one more dead wolf. On examining the trail that led into the gulch I found there were

not more than 5 wolves in the bunch. I put up more baits and soon returned again, finding several baits had been taken and that only 3 wolf tracks now led to the gulch. Again I put up my baits and when I came back, a few days later, several were gone. There were now no fresh wolf tracks to be found. For several weeks after that no wolves were in that section of the range.

The reader may have his doubts as to whether the wolves were all killed or whether many left the country; but even if the latter were true the fact remains that the destruction of live stock was stopped, and therefore the object of the work attained.

The one great advantage of this method is that it enables one to successfully poison the wolves in the early summer, when the pups are just large enough to kill stock. At this age they are much easier to poison than when older.

There will always be a few wolves too cunning to take poison, in any way; but if the wolfer is careful to pick out good places to put up the baits, and to make as few tracks, and as little sign as possible, he can get most of them. He should always go on horse back, when putting out baits, as he does not then need to make many tracks.

R. HOWES.

---

## A REMARKABLE SHOT.

HON. W. A. RICHARDS, GOVERNOR OF WYOMING.

In 1873 I was hunting on Sheep Mountain, in Southern Wyoming. On its summit, near the Little Snake river, there is a well defined crater, now closed, at the bottom, and overgrown with grass.

Here I came on a small band of mountain sheep, which immediately disappeared over the farther rim of the crater. Crossing over after them and looking down the side of the mountain, which was a mass of broken rock, without any timber, I saw the sheep strung out, working their way around the mountain side, about 200 yards below me. The last in the line was a young buck, who stopped and gazed up the mountain with an evident desire to come back. Resting my gun across a large bowlder I took deliberate aim, just behind the knuckle of the shoulder, and fired. To my great surprise he fell as though electrocuted. There was scarcely a struggle, and I could not imagine where I had hit him. If shot through the heart he would have darted forward a few yards, at least. With a broken back he could still struggle; but he lay perfectly still. It was no easy task to get down to him, for he lay on a slide of shale which was just about as steep as a man could travel on.

At last I reached him and took hold of a hind leg, when it seemed the whole side of the mountain had started for a lower altitude. Naturally I at once sat down. I retained my hold on the leg of the sheep, with my left hand, while I had the gun in my right hand, and was therefore unable

to protect myself much. Some of the rocks were exceedingly sharp.

In the toboggan race the sheep was ahead, part of the time, and the other part I was ahead. The inevitable precipice lay before us, but the grade changed somewhat, in our favor, and we stopped, just in time to escape a plunge that would have been disastrous.

I was not hurt, to speak of, but some portions of my clothing were decidedly the worse for wear. The sheep was considerably skinned up, and had left quite a trail of hair down the mountain side.

My first thought was to see where he had been hit. He had stood with his left side toward me, and examination showed he had been struck just where I had aimed. The ball, from a 50 calibre needle gun, had not only gone through his heart but entirely through his body; yet that should not have killed him instantly. On examining his horns, which were not unusually large, the secret was revealed. The bullet had gone through his head, just above the eyes, but had entered at the right side and had gone out at the left.

It was evident that just as I fired he had thrown his head around, on his side, exactly in the line of sight, and the ball had first gone through his brain, then through his heart.

No wonder he dropped dead. Probably few animals have ever been shot sidewise, through the head and through the body at one shot, with one bullet.

---

## FOR A LEAGUE OF AMERICAN SPORTSMEN.

Scranton, Pa.

Editor RECREATION: In your October number I note an interesting letter proposing a "League of American Sportsmen." The idea is good, and I should like to see such an organization in the field as soon as it can be effected. It would be a most effective means of preventing the taking of game out of season, and would make an end to the wanton slaughter of game by alleged sportsmen.

One great difficulty in securing convictions, for violations of game laws, is the apathy of local sportsmen in making complaints. They dislike to prosecute those known to be guilty, because they happen to live in the same neighborhood.

Such an organization as is proposed would take the place of private individuals, as prosecutors, and would be far more of a terror to evil-doers than any machinery that now exists. Game hogs, and violators of game laws, would be careful not to let their doings be known in communities where numerous members of such an association were known to live.

Besides aiding in the enforcement of present laws, the L. A. S. would be a power in the framing of better laws, and in looking after the more effective preservation of game.

Devotees of the rod and gun need little to engender a fraternal feeling. No class of men meet more nearly on a level than true sportsmen; yet such an organization would be valuable even in this respect. Considered from any stand-point, business, pleasure, fraternity or game protection, such an association would be beneficial. Let us get together and organize, as soon as possible.

W. A. Ballard.

---

Editor RECREATION: Mr. Lydecker's plan for a L. A. S., as outlined in the October RECREATION, forcibly appeals to me. Nothing is more effective than judicious organization, based on co-operation. Private capital is doing much for fish and game preservation; but the Corbins and the Vanderbilts cannot do it all, even with legislative aid. Here is a scheme whereby personal interest may be commuted into the equivalent of capital.

There are several reasons, why this proposition, in its general aim and scope, is to be most warmly commended. In the first place, it is comprehensive. Not very much can be accomplished by desultory, or mere sectional, work. Then, it is based on the correct principle—that, in order to get your statutes properly enforced, you must first

get general public sympathy with their purpose, if not with all that they carry in individual cases. In the next place, but right in this connection, it would have a stimulating effect on public sentiment, and would elevate the "honor" watchword among sportsmen. An *esprit de corps* would be established that would be far more powerful in results than most legislation. Finally, it would tend to unify legislation on broad lines of experience, rather than of experiment.

Edward W. Wild, Keene, N. H.

---

Passaic, N. J.

Editor RECREATION: I have read with interest, the paper in October RECREATION regarding a League of American Sportsmen, and it seems to me the suggestion is worthy of careful consideration. Anything which will help to protect the game, and to strengthen the growing sentiment in that direction, is sure to meet with the approval and support of all thoughtful sportsmen.

A movement of this sort, once started, would be carried along by its own momentum. The community of feeling among sportsmen is proverbial, and many, even from selfish motives, would probably identify themselves with it.

If the plan were also to include the preservation of our song birds, the general public would also contribute their moral and material support. The gun clubs, all over the country, would most likely lend their aid, and, in fact, there seems no limit to the possibilities of such an organization.

No better medium than RECREATION could be suggested for spreading the gospel of game protection. Its stand on that question has already been taken and it reaches a great and growing class of intelligent readers.

I am in favor of the plan, and ready to enlist in the ranks.

Arthur F. Rice.

---

Editor RECREATION: I heartily endorse the proposition of Mr. Lydecker for a League of American Sportsmen. In view of the prevailing passion for the destruction of all living creatures, every movement calculated to promote the preservation of our native fauna should be hailed with delight, by every lover of nature. Such a League as is now proposed could, and assuredly would, accomplish important results in the line of protection and preservation; and my only wonder is that such a movement as is now proposed was not in-

augurated long ago. There are sections of this country where game laws are almost unknown, and many highly interesting colonies of birds are in imminent danger of destruction.

A thoroughly alive and business-like L. A. S. is greatly needed. The materials for it are abundant on every hand. Its work is cut out for it by the bird and game destroyers, and when once in the field it will never be out of a job! I wish the movement God-speed, with all my heart, and will gladly contribute time, labor and money toward its success.

William T. Hornaday,  
Director New York Zoological Park.

Editor RECREATION: Your October number to hand and I have read it through carefully. It is needless to say RECREATION is good. That is something that is thrown up to you every day in the week. I shall never deprive myself the extreme pleasure I get from its perusal, so long as I am able to raise the \$.

I was much interested in the article by Mr. Lydecker, on the forming of a L. A. S. A world of good could be accomplished by an organization of this kind; and I believe every true sportsman in the land would put his shoulder to the wheel and help such a movement.

There is great need of such a power, right here. Our woods are full of settlers who live, year after year, by the unlawful killing of game, and if something is not done, in the near future, to stop their slaughter one of the finest deer, grouse and trout grounds in the Northwest will soon become a desert, so far as fish and game are concerned. We have game wardens, but of what use are they? They are wardens merely in name. What we want is an organization that will make a crusade against law breakers and game hogs, from the Atlantic to the Pacific.

Chas. F. Hickok, Grand Marais, Mich.

I have read with great interest an article by Mr. R. D. Lydecker, in October RECREATION. The plan he outlines should meet with the hearty approval of all true sportsmen; for unless we bestir ourselves to properly protect the game and fish, little will be left 5 years hence.

Such a National Association would be of the utmost service in co-operating with state officers for the protection of the game of the whole country.

No private citizen likes to file an information against a neighbor for violating the game law; but organize a National Association, in connection with the various state and local associations and every member would feel in honor bound to see the law enforced. Not only this, but the various

states could co-operate and thus stop all spring shooting of wild fowl. Unless this is prevented they will soon be exterminated.

I most heartily concur in Mr. Lydecker's plan, and if I can be of any service in promoting it count me in.

W. M. Kennedy,  
Pres. Board of Game Commissioners of Pa.

Olympia, Wash.

Editor RECREATION: I endorse the suggestion of R. D. Lydecker, in October RECREATION, proposing a League of American Sportsmen. I believe such a national organization would soon show a membership of 250,000. Certainly all lovers of rod and gun would enroll as members. Think of the good that could be accomplished! With members of such a league scattered throughout the land, backed by a strong central organization, the pot hunters and fish hogs could be looked after, and wholesome and beneficial legislation could be much more easily secured than otherwise. By all means, let us have a L. A. S., and when the initiative is taken, I want to be enrolled among the first.

I hope RECREATION will push this work. Even though the initiative is taken now, it will require 2 to 3 years to properly establish the League, in the various states.

Will D. Jenkins, Secretary of State.

With deep pleasure I read Mr. Lydecker's proposal to form a L. A. S. If something is not done in the near future to protect our fish and game, good sport will soon be a thing of the past. Idaho and Wyoming afford the best fishing and hunting grounds in the United States, to-day; but even here the game is being driven farther and farther back into the mountains, and killed off more and more, each year; while you are now in luck to get a rise, in streams which, a few years ago, abounded with trout.

By all means let us have the L. A. S., and by concerted action and a wise and well-administered set of laws insure, to ourselves and to posterity, an abundance of the sport which we now enjoy.

M. A. Bates, Star, Idaho.

I wish to raise my voice in favor of a L. A. S. I am with Mr. Lydecker and RECREATION, heart and hand, in the protection of our fish and game.

I can say truly, that in 16 years spent on the frontier, or in Texas, and that at a time when the noblest of all American animals, the buffalo, were being so indiscriminately slaughtered, I saw nothing that would compare with the destruction now being

wrought on our fish and game, here in central New York. And this is not being done by market hunters, but by gentlemanly game hogs, who would think it beneath them to sell a grouse, a rabbit or a squirrel; yet they kill to extermination, simply to appease their appetite for blood.

Give us a universal game law, and a national association of sportsmen to assist us and to see that the laws are enforced.

B. F. Bennett, Prest. Fish and Game Association, Maryland, N. Y.

I am emphatically in favor of the L. A. S. It will meet the hearty approval, and will have the earnest support of all the sportsmen, in this city and vicinity.

If I can assist, in any way, in this work, I shall be only too glad to do so, and I know several others, who will do all they can to help the cause along.

Our deputy state game warden, Mr. L. W. Watkins, has been doing splendid work; but he cannot be everywhere at once, and needs just such aid as the L. A. S. could render in ferreting out law breakers and bringing them to justice.

All of the members of the Central City Canoe Club, of this city, are in favor of Mr. Lydecker's plan.

W. S. Allen.

Please place my name on the list for membership in the L. A. S., with RECREATION as the official organ. A ticket in such an organization would be better than a king's passport. With the fee fixed at \$2 a year, including the official organ, there would be nothing to lose, as the said organ is fully worth that amount, alone.

The L. A. S. should enroll every sportsman's organization in the United States, and in co-operation with the L. A. W. would be a power behind the throne, for the common good of both organizations. Jointly they would be capable of adjusting every grievance thrust upon either.

H. C. Wilcox, Friendship, N. Y.

I have read Mr. Lydecker's article advocating a L. A. S. It is good and I shall help to push the work. If the sportsmen of the U. S. and Canada don't do something in that line, to check the work of the fish and game hogs, all kinds of game, and game fishes, will soon be extinct.

The L. A. S. could accomplish as much good in protecting fish and game as the L. A. W. has in behalf of good roads, and RECREATION is just the journal for an official organ, to push the L. A. S. to success.

S. M. Perrigo.

Here is my dollar for another year of RECREATION. The cause has become a crusade, and I hope we may all be enrolled in the League of American Sportsmen,

which strikes me as being the best scheme yet advanced for game protection. I think every gun club could be induced to go into the League, if organized on the plan of the L. A. W. This would give every member a working interest in a national movement, and good must result when sportsmen are gathered under one banner, irrespective of location, or previous condition of servitude.

W. R. Chadwick, Port Huron, Mich.

I have read with great interest the article by Mr. Lydecker on A League of American Sportsmen. It is a most excellent suggestion, and one which I should be pleased to see carried out.

We are in great need of such an organization, in the Northwest, and I am sure if such a movement was started our sportsmen would take hold of it with a vim and push it. We need a national organization, and one that will frame laws and see they are enforced. Count me in as a charter member of the L. A. S.

E. Shelley Morgan, Portland, Ore.

Enclosed find \$1, for one year's subscription to RECREATION, the best sportsman's journal on the earth. Let my subscription go toward swelling the list to 50,000.

Why can't we have a League of American Sportsmen, as Mr. Lydecker suggests? It would be a grand thing. *Of course* RECREATION would be the official organ. What other paper could be?

Give it to the game and fish hogs for all you are worth. They need it bad.

Earl Barber, Swarthmore, Pa.

I heartily approve any measure that will result in properly preserving our game, and a L. A. S. would be of undoubted benefit. With a nominal membership fee, as suggested, a fund would be established with which to secure common sense legislation in regard to open seasons, etc.; also to handle the question of spring shooting, which is surely a burning one, to every right thinking sportsman.

Wilmot Townsend, Bay Ridge, N. Y.

Every thoughtful person realizes the need of some adequate force to act in the line indicated by Mr. Lydecker, in your October number, for the protection of game. Every year the demand grows more urgent and imperative. United action on the part of sportsmen, in all sections, is what is required. Keep up the agitation.

L. H. Sargent, North Chelmsford, Mass.

I have read that most excellent suggestion made by R. D. Lydecker, in RECREATION, am ready to join the L. A. S. at once, and I know of a good many sportsmen who will do likewise. Such an organi-

zation would stop some of the game hogs and law breakers.

RECREATION is all right, only I wish it would come oftener.

John A. Tumwall, Lynn Centre, Ill.

Regarding the suggestion of a L. A. S., I think it is about time something of the kind was done to protect the fish and game. I do not see how the laws of the states can be enforced without some such organization. I heartily indorse the proposition and if a league is formed count me a member.

Robert C. Fletcher,  
382 Elmwood Avenue,  
Providence, R. I.

Editor RECREATION: I have read Mr. Lydecker's suggestion as to the formation of a National League for the protection of fish and game. The idea is an excellent one and I am confident will receive the support it deserves. It is the most effective thing that has been suggested yet.

J. C. P. Leck, Sec. Marysville Fish and Game Protective Assn., Marysville, Mont.

I am in favor of forming a L. A. S. and hope the movement may be successful. I spent my vacation on a wild goose (chicken) chase in Northwestern Iowa last fall, and such an association as Mr. Lydecker outlines could do much good in that section as well as elsewhere.

O. B. Johnson, Orion, Ill.

I have read with great interest the letter from Mr. Ralph D. Lydecker in October number of RECREATION in behalf of the protection and propagation of game and think his idea a good one. I am willing to take it up and help push the good work along.

W. S. Mead, Woodstock, N. Y.

That is a good idea of Mr. Lydecker's. The L. A. S. would be a great power for the protection of our game; and if every reader of RECREATION would join, it would certainly take no longer to effect the needed reforms than it took the L. A. W. to get its demands recognized. I hope you will continue to roast the game hogs.

F. A. Musser, Witmer, Pa.

I have read the article of Mr. R. D. Lydecker, and am pleased with it. I heartily agree with him in every particular. What the L. A. S. wants is some good live men to push it along, and who will never rest until it is a sure go.

Dr. A. J. Marling, Greenville, O.

The L. A. S. is the proper thing. I heartily indorse the idea and will be one of the first to join.

M. L. Miner, Brooklyn, N. Y.

I heartily indorse your scheme for L. A. S. and hope it may be established at once.  
F. B. Guion, New York City.

The foregoing are only a few of the hundreds of letters I have received, speaking in the same general terms as these. As may be readily inferred from the preceding letters, all good sportsmen are in favor of the L. A. S., and none are against it. I have received but one negative response to the proposition, and the gentleman who wrote it, after hearing further as to the proposed plans of the L. A. S., cordially indorsed it and says he will be one of the first to join.

Among the many other prominent sportsmen who have written me approving, in unmeasured terms, the proposition for the L. A. S., are:

Col. C. W. Dimick, Gen. Mngr., New England Sportsmen's Exposition, Boston.  
A. F. Crossman, No. Clarendon, Pa.  
Dr. J. N. Hall, 1517 Stout St., Denver, Colo.  
Ralph H. Hendrick, Wolcott, N. Y.  
Meriden S. Hill, Sec'y, Ferry Museum, Tacoma, Wash.  
F. S. Hyatt, Cashier, Clinton Bank, New York City.  
J. Elmer Pratt, Adv. Mngr., Grand Rapids Cycle Co., Grand Rapids, Mich.  
Dr. R. D. Pratt, Shelbyville, Ky.  
W. L. Simpson, Jackson, Wyo.  
Clinton A. Smith, East Albany, N. Y.  
F. J. Huntley, Oneida, N. Y.  
T. G. Bredington, Cranford, N. J.  
Samuel Lowry, Johnstown, Pa.  
W. W. Coleman, Carson City, Nev.  
W. Scott Jones, Akron, O.  
Dr. M. L. Tyler, Chebanse, Ill.  
Fred W. Moffett, Brooklyn, N. Y.  
M. M. Elliott, Detroit, Mich.  
D. H. Eastman, Little Falls, N. Y.  
Otto C. Rottsted, Cattatank, N. Y.  
Paul W. Gardner, Honesdale, Pa.  
C. E. Butler, Salina, Kans.  
W. S. Bates, Chicago, Ill.  
J. C. Young, Sec'y., Madison Square Garden, N. Y. City.  
E. J. Breeze, Forestport, N. Y.  
F. B. Guion, New York City.  
M. L. Miner, Brooklyn, N. Y.  
R. Newton Finck, 32 Nassau St., New York City.  
Ernest Seton Thompson, N. Y. City.  
A. Clinton Wilmerding, N. Y. City.  
Hon. L. A. Huffman, Miles City, Mont.  
B. C. Broome, Jersey City, N. J.  
A. W. Dimmock, 66 B'way, N. Y. City.  
J. H. Seymour, 35 Wall St., N. Y. City.  
L. W. Walker, Pasadena, Cal.  
L. C. Whiton, Times Building, N. Y.  
F. A. Musser, Witmar, Pa.  
Dr. A. J. Marling, Greenville, O.

A call for a national convention to organize a League of American Sportsmen, to elect officers and to frame a constitution and by-laws will be published in January RECREATION. The meeting will be held in the latter part of January or the early part of February, and it is hoped that every sportsman who can possibly arrange to come to New York at that time will be on hand. I should like to see 1,000 men at the initial meeting, and to see at least 20 States and territories represented. All decent and respectable sportsmen will be eligible to membership in that convention, as delegates and as voters. Will you be one of them? Let me hear from you.

## ARREST OF A NAVAJO INDIAN MURDERER.

LIEUT. E. H. PLUMMER.

The San Juan river forms the Northern boundary of the Navajo Indian reservation, for a distance of about 150 miles. Scattered along the valleys of the San Juan and its tributaries, North of the reservation, are the villages of Farmington, Olio, Fruitland and Jewett, N. M. Besides the usual village stores there are a number of "Indian trading stores," so called because the principal business of the owners is to trade with the Indians.

The agency for the tribe is at old Fort Defiance, Arizona, on the South side of the reservation, more than 100 miles, by wagon road, from the San Juan valley. Naturally, then, on account of the distance from the agency, the Northern part of the reservation became the resort of outlaws and those of the tribe inclined to be independent of, and rebellious under, Government control. Then, too, the situation led as naturally to the ever increasing boldness of these Indians in their petty thefts and depredations against their white neighbors on the opposite side of the river. White settlers were not allowed on the reservation, so an Indian might commit a depredation on the North side of the river and return to the reservation without the least danger of being pursued by whites.

This state of affairs was brought to the notice of the authorities in Washington, by the Governor and the Legislature—also by the Grand Jury of San Juan county, New Mexico; but when I took charge of the Agency, in April, 1893, nothing done by the agent had mitigated the evil, which, it may be said, culminated in the murder of L. S. Welsh, an owner of one of the Indian trading stores. At this time I had been in charge of the agency only a few days, and had not visited the Northern part of the reservation.

While sitting in my office, at the agency, one afternoon, I noticed an Indian standing in the road near by, at a loss which way to turn, and, evidently, the bearer of important news. I sent for him, and when he came in he handed me a letter from Mrs. Whyte, of Jewett, N. M., the "field matron" for the Navajos, telling me of the murder of Welsh, and urging me to come at once, for there was danger of a conflict between the Indians and the white settlers. The courier, I ascertained, had come through in the night, for fear of being stopped. I started the next morning for Jewett, arriving on the third day.

The reservation at Jewett extends North of the river, embracing a small triangular tract, in the Southeast corner of which a mission is located. At that time Mrs. Mary

L. Eldridge was, the missionary, and Mrs. Mary R. Whyte the field matron. Mrs. Whyte's husband kept a trading store just off of the reservation, North of the river, where Mrs. Whyte lived; Mrs. Eldridge lived in the mission house. Jewett consisted of little farms strung for a mile or more along the North bank of the San Juan river. The scene of the Welsh murder was about a mile from Whyte's store.

We crossed to Whyte's store, where I learned the particulars of the killing of Welsh. Late in the afternoon I returned to the reservation side, accompanied by James Francis, a Government employee of the agency, the only employee located on the reservation in the vicinity of the San Juan river. His position was officially known as "farmer," his duties being to assist and instruct Indians in farming. His home was on the reservation, about 10 miles above Jewett; and will be frequently mentioned as "the Farmer's residence."

We moved up stream about a mile, and camped nearly opposite the scene of the murder. I was accompanied by the regular interpreter for the agency. After supper, Indians gathered about our fire, forming a circle. While the murder and plans for the arrest of the murderer were being discussed, the interpreter muttered, "I think he's here."

Before I could ask for further information, an Indian broke through the circle, crossed quickly to my side, threw an arm impulsively about my neck and commenced a plaintive confession of how and why he had killed Welsh; mingling with his confession a pitiful appeal for mercy. To feel the embrace of a red-handed murderer, a desperate Indian at that, gives one a rather peculiar sensation; but the importance of obtaining the confession and custody of the murderer induced me to appear undisturbed. He was known as Nesh-kai-hay. His wife soon joined the group and also made an appeal for mercy, sitting beside me, holding my hand, while pleading for her husband. Nesh-kai-hay said he would give himself up to me, to do with him whatever I thought best. The following day I had Nesh-kai-hay repeat his confession. It was, in substance, as follows:

"I went to Welsh's store to pay him some money on some beads I had pawned to him. I looked into the window. There was no one in the store. I went into the field near the house and saw Welsh at work with a shovel. I had gotten \$1 on the beads and I wanted to pay him 50 cents toward redeeming them. I got into a dispute with Welsh about paying the money. Welsh

struck at me 4 times with his shovel, missing me every time. After the last time I ran to my gun and picked it up. When Welsh saw me pick up my gun he started to run toward his house; then I shot him in the back. He fell and my wife and I ran away and went back to the reservation. I had no intention of killing Welsh when I went to see him. I do not know why I did it. I lost my head. I am sorry I did it."

Nesh-kai-hay expressed his willingness to accompany me to the agency, or to any place I designated. I told him that, before deciding what to do with him, it would be necessary to move my camp to the Farmer's residence, about 10 miles farther up the San Juan, to enable me to get supplies and forage for our animals. He expressed his willingness to go; nevertheless, instructions were given to the Indian police to keep a sharp lookout to see that he did not get away.

While the team was being hitched to the buckboard and the police were saddling their ponies, a great many Indians crowded about us, and when we were ready to start it was discovered that Nesh-kai-hay had escaped. Though the Indian police were immediately sent in pursuit they soon returned, saying they could neither see him nor find any trace of him; for he had concealed himself in the breaks near the river, where there were so many trails it was impossible to follow him.

I subsequently learned that, not only had his escape been planned, but that a large party of his friends were gathered, under shelter of a bluff, presumably, to resist my party and assist him, if an effort should be made to detain him by force, or to re-arrest him.

I held a council with the Indians present, urging them to secure the murderer and to bring him to me, knowing as well as they it would be impossible, under the circumstances, for the 2 or 3 Indian police, with the Farmer and myself, to find the man, much less arrest him, unless assisted by the neighborhood Indians. After advising and coaxing, I tried threats, but was met with an impudent: "Pooh! We have heard agents talk before. You can't do anything. You can't get troops to come here to help you; that's all talk.

I ceased talking at once and made preparations to go to the Farmer's residence, to send telegrams to the War and Interior Departments, asking for the assistance of troops. From what I had seen and heard from reliable sources, as well as from the character and disposition of the Indians, I knew that, to accomplish anything without bloodshed, it would be necessary to have a force of troops sufficiently large to settle decidedly the question of whether United States authority over these Indians was to be maintained.

The nearest telegraph office was at Du-

rango, 45 miles distant. I sent 2 messages by courier, and remained at the Farmer's to await developments. They were dated April 26, 1893.

The first was to the Assistant Adjutant General, Department of Arizona, Los Angeles, Cal., stating the existing conditions fully, and asking for at least 4 troops of cavalry. The other was to the Commissioner of Indian Affairs, Washington, D.C., advising him of the requirements at the reservation, as I saw them.

About 2 o'clock on the following afternoon, a courier, apparently badly frightened, came to the Farmer's residence and told us Whyte's store was surrounded by Navajos, who threatened to burn the building and to commence killing white people. Accompanied by the Farmer, I hastened to Whyte's, but the excitement was over. The trouble and alarm grew out of the Indians believing one of their tribe had been killed by whites, in revenge for the murder of Welsh. (It is still believed by Indians in that vicinity that the other traders put down the price of wool, and have kept it down, on account of the murder of one of their number by the Indians.)

This Indian left the reservation late in the afternoon, leaving his pony with friends, telling them he would soon return, that he was going across the river to trade. During the evening his friends heard a shot in the vicinity of the store where he had gone. He failed to return to the reservation during the night and the Indians concluded he had been killed. A large party crossed the river in the morning and, going to the store, told Whyte and others if the white people had commenced killing, the Indians were going to commence too, right there, and no white person should get away from the store or the mission alive.

In the excitement a boy escaped to the river bank, and made his way to neighboring houses, giving the alarm as he went. The whole valley was aroused, all the way to Durango, and by sun-down some 200 armed men were on their way to Whyte's store.

In the meantime Capt. Daugherty, a retired army officer, who happened to be at Whyte's, prevailed on the Indians to allow him to go to the store, where the killing of the Indian was supposed to have taken place, to make inquiries about the missing Indian. On entering the store, Capt. Daugherty saw the Indian and immediately returned with him to Whyte's. When his bloodthirsty friends were convinced of their mistake, they sullenly dispersed. Sheriff Dustin, of San Juan county, New Mexico, with a large party, remained at Whyte's all night, fearing the Indians might return, under some pretext, and not again be so easily restrained. There was now wild excitement throughout the San Juan valley and the adjacent country, and exaggerated ac-



counts reached the newspapers. The settlers felt a climax had been reached.

At a place known as West Water, 15 miles from Whyte's store and about 25 from the Farmer's residence, there was water in springs and holes, the only watering-place for stock in the vicinity. The Navajos had, for years, claimed the water. The whites, knowing it was some 5 or 6 miles outside of the reservation, disputed the claim. Several Navajo families, whose heads were notorious cattle thieves, were in the habit of wintering near West Water.

Sheriff Dustin's party, numbering about 30 of the best men of the San Juan valley, had armed themselves and hastened to the assistance of Whyte. From what had occurred they believed the time had come when they should take affairs into their own hands, regardless of Government authorities, and drive all the Navajos in the vicinity back to the reservation. Accordingly, on the morning of April 28th, they started for West Water, with this intent, sending word to me, that I might know what steps they were taking.

Accompanied by the messengers as guides, I rode as rapidly as possible toward West Water, but, through unavoidable delay in crossing the river, it was long after the hour appointed by Dustin for the work to begin, before we got near West Water. We pressed forward as rapidly as our horses could travel, but on arrival found no disturbance had yet occurred. After some argument with the men I convinced them it would be better to leave the driving of the Indians to the regular soldiers; for then the Indians would have no ill-feeling toward the settlers, always accepting anything done by regular troops as ordered by "Washington."

When notified of the trouble at Whyte's store I had renewed my appeal for troops. In the meantime the Indians sent word to me they wanted to "talk." I replied I was through talking until the troops came. Later they sent a message, asking to know whether the troops would be kept away, if the murderer should be given up. My reply to this was that it was too late to prevent the coming of the troops, but, I assured them, if the murderer was given up, no one who had not misbehaved would be disturbed by the troops.

The Indians sent out spies, to find where the murderer was hiding, and finally sent word to me that they would try to catch him and bring him toward where I was,

provided I would meet them with a party sufficiently strong to resist any attempt of his friends to rescue him. I promised to meet them when sent for, and, as the troops had not arrived, asked a United States marshal to hold a party in readiness to go with me.

About 2 o'clock, Sunday morning, April 30th, an Indian runner aroused the Farmer to tell us Nesh-kai-hay was being brought in, and that the Indians who had him wanted us to come at once to meet them. There was neither time nor opportunity to send word to the marshal to join us, so we set out at once. We met the party about 5 miles from the Farmer's residence.

Nesh-kai-hay was securely bound with ropes to another Indian, who rode in front of him on a pony. The Indians were still fearful of being overtaken by friends of the murderer. It was too dark to recognize persons readily and while making some inquiries as to who was in the party, the Indians cautioned "silence and hurry." We travelled along at the foot of a bluff indented with ravines, or arroyos, expecting momentarily a rescuing party might rush out. Once we were startled by the sound of hoofs rapidly approaching, from the rear. A solitary Indian, undoubtedly a spy, rode up, evidently to ascertain the strength of the party. We then numbered about 14, which was probably considered too large a party to attack. We reached the Farmer's safely.

The jail, at Aztec, the county seat, was 40 miles distant. We crossed the river, procured a conveyance and by 5 o'clock started for Aztec, arriving there at 9 o'clock. A few minutes later the murderer was safely lodged in the county jail. I returned to the Farmer's the same day.

Nesh-kai-hay was subsequently tried and sentenced to 20 years' imprisonment in the penitentiary at Santa Fe, N. M., where he is now serving sentence. At the preliminary trial my evidence was explained to him by the interpreter, and on being asked if he had anything to say he replied, "No, the Agent told it all, just as it happened. I can not tell any more."

At the trial a lawyer was assigned, by the Court, to defend Nesh-kai-hay, and every effort was made by Seeds, the U. S. Judge presiding, to have the Indian understand his rights and to give him as fair a trial as if he were white.

The troops I had asked for came, though too late to assist in the capture.

---

"Our janitor was sick all summer."

"What was the matter?"

"It prostrated him to see us getting all the hot air we wanted without appealing to him."—Chattanooga News.

## MY FIRST BUFFALO

CONRAD HANEY.

It was in 1879, I think. Certainly it was away out in Western Texas. The cowboy was still in his glory. Indian uprisings were not infrequent, and it was still an insult to ask a man why he came to Texas.

From the time when this vast empire of mesquite grass and jack rabbits had been "acquired" by our government, it had been a favorite refuge for the worst classes of criminals, who found ample security in its lonely villages and trackless prairies. Indeed, it was so popular a refuge for all classes of outcasts from society, that the inquiry just noted was likely to be extremely embarrassing, as well as an insult.

I once heard of a group of Texas gentlemen—good fellows, all of them—and on terms of intimate friendship, who agreed to entertain each other with a narration of the particular circumstance which induced each to settle in the "Lone Star State."

One explained that he had been a bank cashier. Another confessed a violent attachment to his neighbor's wife. A third admitted he had been a good judge of horse flesh. And the fourth—well, he had neglected to build a church.

All this was intelligible to the parties concerned; but it may be well to explain, at this late day, that the bank cashier had been too free with the funds; the sentimental man had brought the woman with him; the lover of horse flesh had been carried away, not only by his predilection for that noble animal, but by another man's steed, and the last man had collected the funds for the church which he had neglected to build. So, they were all in Texas, and woe betide any other man who might ask any of them why!

Silk hats were at a big discount. A friend of mine had the temerity to appear on the street, with one, about the time of which I write. He told me he had not walked a block when he was startled by the crack of a 6 shooter; and almost simultaneously his shiny tile, perforated by a bullet, rolled into the gutter as a gruff voice said:

"Come out-er that!" Having "come out" the tenderfoot never re-entered.

It was always wise to accept an invitation to drink, in those days. You might be a "teetotaller," of the most virulent type, but you could recover from a glass of even Texas whiskey, which is more than I would venture to say of a Texas bullet.

It was at this time I concluded to go buffalo hunting. There was still an occasional small herd of these noble animals to be found in the far West, and I had reliable news of some on that vast table land,

known as the Staked Plains. There were 5 of us in the party; Jack and Bill Bell (I never knew but that they had been thus christened); Dr. Miller, who would have scorned to answer to any name but Doc; Mr. Sampson, the only man I ever knew whom Texans invariably addressed as "Mister," and I.

We bought a wagon and a stout span of mules to transport our baggage, as well as Doc and Mister Sampson; for these men preferred to ride in this fashion. The rest of us chose riding ponies. We had, of course, an ample supply of flour, bacon and beans, together with such fluids as experience taught us were necessary.

But the feature of our outfit, as he was the mainstay of the whole expedition, was Duke, who served as guide, body guard, teamster and cook, and who was fully equal to any other duty that might have been imposed. Perhaps I should make an exception to this statement—just one. He would hardly have made a creditable Chaplain, although he would doubtless have undertaken the duties of that sacred office with the same unwavering confidence and breezy profanity with which he fried our antelope steaks and made our bread. He had been hunter, freighter, cowboy and gambler, in Texas (I do not remember that he ever said what he had done or been, in "the States"); and could drink, or shoot, or ride, or swear with a proficiency that was little short of marvellous. With all he had a fund of good humor and kindness that endeared this turbulent son of violence to us all before he had been with us a week.

Of course we were amply provided with arms of the approved pattern, and had plenty of ammunition, all except Mr. Sampson. He was equipped with a formidable camera, that was always getting out of order at the critical moment. He also had a little 22 revolver. I shall not soon forget the night when he displayed this sanguinary weapon. There were some cowboys about our fire. I can see them as I write; tall, brown, muscular, and wonderfully picturesque, with their broad sombreros, jingling spurs and huge 6 shooters. It was to them that Mr. Sampson submitted his shooting iron for inspection; and at the first glance, everyone of them, as if in mortal terror, scrambled out into the darkness. Nor would they return until they had extracted a promise from Mr. Sampson not to "flash" that exterminating engine of war on them again. It reminded one of a cowboy, who, being confronted by a man with just such a revolver, said, "Look here, Pardner, if you shoot me with that thing, and I ever

find it out. I'll mop up the dirt with ye!" We started from Sherman, at that time a most prosperous little city in Northern Texas, and pushed West to Henrietta, the frontier town. Up to this point the journey would have been without interest but for Jack Bell. Artemus Ward used to say his kangaroo was an "amazon hole boss." Some way this occurs to me as I think of Jack. He was afflicted with an insupportable itching to trade horses, in spite of the fact that he was always worried, and thus it came to pass that before we were half way to Henrietta Jack's fine pony, his watch, one of his revolvers and most of his ready money were invested in a debilitated old chestnut saddle stallion that could only be gotten to move by the combined efforts of the party and the work mules.

We were discussing this animal one day at dinner, when we were interrupted by the appearance of a native who rode up on the meanest looking broncho I ever saw. It was Jack's chance, however, and there followed such a horse trade as one sees only once in a lifetime. Either of the men could have given Ananias cards and spades and then beaten him at his own game. It was a beautiful combat of unblushing and exuberant mendacity that finally resulted in an exchange, and the Texan mounted the stallion. A dig of the bare heels failed to develop motion.

"Get up!" Not an ear budged. "Down in, get out'en this." The chestnut saddle still meditated. "-----" The stallion was like bronze. Finally we handed the stranger a club, and thus re-enforced by some vigorous efforts on the part of Jack, got the animal under way. The Texan only had breath enough left to remark, by way of farewell, "God bless a lart out'en the other side of yonah mouth when yer sees another feller try to start his hoss."

And we did. Or to keep strictly within the bounds of historical accuracy, Jack did. Darby, for so we christened the broncho, proved a confirmed bucko. When a horse bucks, he is inscrutable, bewildering, kaleidoscopic. He starts by springing several feet in the air, regaining terra firma with legs stiff, back bowed, and feet almost touching each other. He then indulges in some high leaping, desperate attempts to vault an imaginary hurdle. This done his hind feet shoot upward and outward like concentrated lightning, and when at the greatest height are replaced by the fore feet. After 3 minutes of these gymnastics, he is likely to conclude the performance by lying down and rolling over.

And the rider? It is only necessary for him to hold on. True he has a vague sensation of being far from home. He is awfully "churned" and sees more stars than astronomers have dreamed of, but if he holds on, the broncho will transform him-

self into the best seat, the trough, the earthen galled seat, or whatever you like. He makes no promises about the future of you. A bucko in the face of some unarmamented object, or even some talking thing, is likely to start him at any time, and you may expect to see our horse a step or two off.

Jack was a man that started out best on, and had the satisfaction of getting the best pony in the outfit afterward.

But I started out on a horse that was a buffaloe. After leaving the last effects game was played, and as for the buffalo, the trophy, although at a distance, we were after something larger, and pushed readily Westward on, at least we were rewarded by the hunt of a mammoth. The Staked Plains are level as a billiard table. Our game was the exception of Darby were failed. There was something wrong but to stick our game and fortunately for us the wind was light. But at last our luck was Jack and Darby in team a lot a time with the first shot in case we should fail to bag our game.

During our rides we traveled unlike Indians in the direction of the herd. They were lying down with the exception of a big bull who stood sentinel and with a vigilance that made our progress extremely slow, for whenever he looked in our direction we were compelled to be prone and still. Bill said on several occasions he had never been able to start a word in this before, and as a recent prairie fire had left nothing but sharpened spines of burnt grass the haunting specter was painful. In fact long belts we had covered the mile or so which separated us from the herd our clothing was torn, our hair matted and blood oozing from many little punctures and scratches. But we hardly noted these in the excitement of the moment.

I think it was my first, and among my last experiences with that mysterious melody the buckague. For although I have killed a great deal of big game and have been in one or a pretty close place, I never shook as I did that afternoon. I would have missed a haystack had I been compelled to shoot when we first discovered the buffalo.

But the lapse of time, the winds from the grass stacks and above all, my regard for the alertness of the old bull who was responsible for every mishap wrought a complete cure. It was about this time that his watch was over and after one long suspicious glance in our direction which apparently reassured him, he lay down and another old fellow rose up to continue the vigil. He was on the other side of the herd, however, and apparently had no apprehension of danger, so we were soon within easy range and ready to open on them.

Bill was a practical man, and had always manifested a tender regard for his stomach. Glory was vanity to him in comparison

with a good meal, and so he selected a nice plump calf.

In those days I differed from Bill, in these things. I was ambitious. Nothing short of the biggest bull in the herd could satisfy me. I did not care how tough he was; and beyond all this I had a grudge against the old bull that could be wiped out only in blood. Furthermore he was only about 75 yards away, and was an easier mark in case of buck ague, than the smaller animals. We sighted carefully.

"One, 2, 3." Bang! and the whole herd went thundering over the prairie!

Bill looked at his calf; I looked at my bull. Then we looked at each other. Words were inadequate. Even Duke could not have met the exigency of the case.

Suddenly we were aroused from our stupefaction by a yell from Jack, who was tearing over the prairie at full speed toward us, and on glancing up, we saw a sight that really took away all taste for buffalo hunting.

A big old fellow had left the herd, and

was charging down on us, with the evident intention of doing a little hunting on his own account.

This change in affairs impressed me with the wide difference between hunting and being hunted. I confess there was something in that shaggy head, those distorted nostrils and bloodshot eyes that made my hair stand on end; and I would then have given all I possessed to have been anywhere else in the world.

We grasped our rifles with some sort of a vague idea of "selling our lives dearly" or "dying with our faces to the foe" or "quitting (if we could have 'quit' the buffalo) like men;" but fortunately we were not compelled to do any act of heroism. While we looked, the bull staggered and fell to the earth. My shot had gone home.

We carved him as well as we could and made desperate efforts to eat some of him; but no matter what portion we tried, or how long and well Duke cooked it, we always devoutly wished Bill hadn't missed his calf.

---

## WOODCOCK AND SNIPE IN NOVA SCOTIA.

H. AUSTEN.

On a certain autumn day my wife and I and good old "Jack Diamond" (my Irish setter) boarded a train for — where we were to have a day's sport on woodcock.

I took along my new 12 bore hammerless, built to order by the Ithaca Gun Co., of Ithaca, New York. The gun was made specially for woodcock, snipe and grouse shooting. It has 28 inch barrels, 2 inch drop, left barrel cylinder, and right modified choke. It weighs 7 pounds, but is so beautifully balanced that it does not appear to weigh over 5. It drops into place so neatly that the bird must be lively who keeps out of its way.

We arrived at friend Law's at noon, and soon after lunch started out to look up some of our old covers. As soon as we reached the ground, Jack began to take scent, and to show that game of some sort was near. The ground was rather open, with alder patches scattered about—a good place for an odd snipe or cock to lie.

I was enjoying my cigar, and keeping an eye on Jack, who was some 40 yards ahead, when he swung about, and came to a stop. We knew that somewhere, close in front of his keen nose, a snipe was hugging the ground. "Steady, Jack, steady." We took a few steps forward, and up jumped the bird, coming up wind, straight toward us. Letting him pass, we swung about; the left trigger was pressed, a report rang out, and first blood for Ithaca was recorded.

On picking up the bird I was surprised at its weight and size, and remarked to Mrs. A. I thought it the largest snipe I had ever killed. We weighed him afterward, and he weighed 6 ounces. I have no doubt that, like the big fish we catch, he lost considerable in carrying him home.

While discussing this weighty subject with Mrs. A. I had allowed Jack to roam into the cover. His bell stopped tinkling and I knew he was standing a bird. We moved up within shot, sang out "steady; up, up;" when the bell tinkled and, with a merry whistle, out burst the king of all game birds, a noble woodcock. Once more the "Ithaca" spoke, a few feathers floated back on the air and the bird was cut down. Gently picking him up we smoothed out the rumpled feathers, tucked his pretty brown head under his wing, and stowed him carefully away, with his cousin, the snipe, in the recesses of my game pocket.

"Well," said Mrs. A., "your Ithaca appears to shoot all right. That's 2 shots, and 2 birds."

"Yes, that's so; but both these were easy shots. Just wait, until I get some real hard, tangled up shots, in thick cover, and then I shall be better able to judge as to how she will shoot. It depends largely on how quickly I can pitch her on a bird."

On we went with Jack ahead, working to and fro, over the ground. He made quick, sharp turns, from side to side, like a snake

crossing a road. Now he holds up; looks around to see where we are, moves on 2 or 3 steps, then stops again; takes one or 2 more quick, cat-like strides, and then holds up solid.

"There you are, wife; just gaze on that, for a picture. Great Scott! Is it not worth coming all this distance, just to see that?"

"Yes, but look out; he may flush the bird," answers the better half.

"Now Jack, steady; up, up."

Just half a step he makes, and stops with one paw in the air, when "scaipe" goes the snipe. Up goes the gun, another victim down, and the Ithaca takes all the credit.

Once more forward. Now Jack stops, again, but what with his splashing through the water, and the noise of his bells, the snipe rises wild, and with a "scaipe" goes darting away, in search of a new hiding place. Two reports ring out, in quick succession, but the bird keeps on. All right, we don't hanker for a reputation, of "sudden death" every time.

Another start and Jack soon straightens out his neck, curves his back slightly, takes one or 2 sniffs, with that never failing nose, and then, with head and neck straight out, he walks deliberately forward about 30 yards, stops, moves back a few paces, swings over a little to the left, and then stands stiff and immovable. This time I walk quickly toward him, saying, "steady, boy, steady," until I get within shooting distance. Then "up, Jack," and he makes a step forward. "Scaipe, scaipe" goes a relative of the chap that went before; but unfortunately this songster, had loitered too long by the way side, and the Ithaca had no trouble in calling him down.

Gathering him in, we swing about and make off toward some high alders, on our left. Jack works back and forth and soon shows, by his quick, nervous action, that more game is lingering near. Soon the dog stops, raises his head, and looks straight on. I follow the line, and am just in time to see a brown object burst over the hill. I throw up the gun, but fail to connect, and do not press the trigger.

Mrs. A— wants to know what it was. She had not heard or seen anything.

"It was a cute old woodcock. He got up ahead of the dog, and sneaked off without a sound. It might be his outer, or 3 alternate primaries, have not yet been fully developed; or the unfortunate bird, might still be moulting. Consequently, not having any vocal powers, he was unable to make that peculiar whistle. Possibly that was why you did not hear him."

Then we moved on to investigate the subject of so much discussion. Arriving at the point where I had seen the bird disappear, I looked the ground over, and said:

"Do you see that thick clump of alders, down there to the left? Well, that woodcock is in them. You stay here and watch,

and if I shout 'mark' you look out. The chances are that if I don't get a shot he will come back this way. Come, Jack." And down we went. I put Jack in the back of the patch and, making him "charge down," I hurried around to the front. "Now Jack, put him up."

The bell tinkled merrily as the dog worked through the cover toward me. Finally it stopped. Then it sounded again. Once more he paused. Then another tinkle and then a dead silence. I knew Jack had him. "Up, Jack."

The bell tinkled. "Up." Another tinkle. I waited a while and then said, "Come, Jack, put him up." Another tinkle is heard, and with a merry whistle, out comes the cock. The gun drops quickly on to his line of flight, and the bird is smashed out of existence.

I picked him up, and walking back to Mrs. A., we noted his 3 outer primaries were perfect; that he was not moulting, to any considerable extent, and we concluded he did not whistle the first time, because he had sense enough to keep quiet; which is more than I can say of some people I know. However, we did not wish to go into this vexed question, and decided the bird could whistle, or not whistle, as he chose.

Now, let us swing back toward the house. The afternoon is speeding away, and it is time to turn homeward.

"Now, old doggie, hie, on. Look 'em up." On we go; but no more birds obstruct our pathway, and with the exception of an odd grouse, that gets up, now and again, and goes bustling off, we find nothing worth noting until we come out of the cover, close to the house. As we drew near a corner of the field, Jack, who had been working ahead on the edge, suddenly held up, and with body half swung round, nose and neck slightly curved, tail drooping, eyes fixed, paw raised, stood motionless.

I knew there was a bird under his nose; so stepped ahead, when up it jumped. Ithaca spoke, and down he came, all in a heap. Calling Jack to heel, and slipping in another shell I walked forward to pick up the bird, when up from the very spot where I had marked the bird, sprang a cock. It was a surprise party, but the gun leaped into place; the safety was shoved forward, the trigger was pressed, and a charge of No. 7 laid him low, just as he was slipping out of sight around the corner.

I picked him up and then came back to where the first bird had fallen, but could not find it, and concluded the 2 birds, were one and the same, that the first barrel, with No. 10 shot, had simply knocked him down, but that he had recovered and was making off, when the second finished him.

Then we put up the game, called in the dog, and wended our way to the house, fully satisfied with the afternoon's sport.

# OUR ALASKAN EXPLORING EXPEDITION.

## IN THE ETSEZA MOUNTAINS.

A. J. STONE.

After waiting almost 2 days for my Indian, "Dennis," to say good-by to his sweetheart, we finally made a start, and although it was past 4 in the afternoon, I was determined to get out of the village while Dennis was ready to go.

Packs, for ourselves and 2 dogs, were already made up and we soon had them in the boat and were pulling across the river. Dennis forgot something and we had to go back for it; but I had it brought to the boat for I was not willing to trust him to go for it.

It was almost 5 o'clock when our boat was made fast on the other shore and our dogs packed and ready for the start. Heading in the direction of the Etseza mountains, we travelled rapidly, considering the long, steep climb we had to make on leaving the river. When we pitched camp it was late, but we were all feeling good, and even Dennis seemed glad to be on the trail. He proved good help on the entire trip.

We travelled 5 days with heavy packs, through a terribly rough country, across deep canyons, fording ice cold streams and climbing over fallen timber.

Most of the time we kept up a good, swinging gait; but one morning, just after starting out, we ran into a wind-fall. We did not try to skirt it for we thought we would soon pass through it. In this we were doomed to disappointment; for night came on when we emerged from the wilderness of fallen timber. We had put in a long day, at hard work, and had put no more than 4 miles behind us. This was really trying for our scanty supply of grub diminished just as rapidly, when making 4 miles a day as when making 20, and we had only taken what we could put on the dogs. We had packed them light. One carried 20 pounds of flour and one pound of baking powder, while the other carried 10 pounds of bacon, 5 pounds of rice,  $\frac{1}{2}$  pound of tea and our kitchen.

During the exasperations of this day's work we were many times compelled to get down, loaded as we were, and crawl under fallen logs. Then we travelled on top of others, stepping from one to another, until we would often find ourselves 20 feet above the ground. We had constantly to assist the dogs, with their packs, through rough places.

Our greatest trouble came on the evening of the fourth day out, when we undertook to descend a slide, into a deep canyon. We were compelled to seek the canyon in order to find water.

The walls were so steep everywhere, that it was impossible for us to descend except by going down the slide. This looked steep and bad, but the thought of a dry camp, where we were, drove us to make the trial.

The slide was very narrow. In fact it was simply a trough, with steep walls, that kept crumbling off, keeping a mass of decomposed lava always sifting down. Down this we went, little realizing the task before us. We supposed a drop of 300 or 400 feet would take us to the bottom of the canyon; but it proved nearer half a mile and took more than 2 hours to travel. We soon found, after starting, that had we once lost our footing we would have made the trip in a few seconds. The short curves in the narrow slide enabled us to brace ourselves. This was our only means of safety; for had we encountered any long stretch, that was straight, it would have been impossible for us to have maintained a footing.

Our packs here were a serious burden and often threatened our destruction. The dogs followed, after a great deal of coaxing, whining pitifully and showing great fear. I felt sorry for the poor brutes, although their packs were now very light. We could not get them to go ahead, and in their scrambles they would often start some of the soft stuff going, making it all the worse for us.

At last we could hear the running water below, but it was some time before we came in sight of the stream. What a welcome sight when we did reach it! Worn, tired, nervous, hungry and thirsty we at last stood on a little shelf not more than 100 feet from the water we had endured so much hardship to reach, with all danger behind us.

We found a little level rock, large enough for camp, in the bed of the canyon, and enjoyed a hearty and well earned supper. After eating, an inventory of our food supply disclosed the fact that but about one pound of bacon and one pound of flour remained.

The flour was carefully tied up and voted a reserve. For breakfast one small strip of bacon each, and tea, was all we could afford, and we were not yet in the hunting country. The canyon walls stared us in the face and behind empty stomachs our hearts sank into our boots.

We finally assaulted the opposite wall, and while it proved tough enough it was not nearly so steep as where we came down.

Noon found us in a high country, traversing an immense stretch of willows. By 2 o'clock we passed out of these on to a

high, moss covered plain, from which, some distance ahead of us, rose the Et-seza range in full view. It was a grand sight. These mountains are not high but we could see the shapely peaks from head to foot. They appeared as if the Creator had cut their base perfectly smooth and had then set them down on top of the rear edge of this level plain; covering them with ice and snow to gradually melt and nourish the mosses and grasses of this vast plateau.

The country was covered with spongy moss but otherwise the travelling was fair and we made good time. Five ptarmigan lost their heads, that afternoon, so we were not yet on the verge of starvation. We would have had quite a feast but had no fuel with which to cook our birds. We camped in the only timber in sight, a small patch of willows, 12 to 18 inches high.

We managed to make tea, but the birds only turned white on the surface, from the heat of the water in the frying pan and then the fire of twigs went out; so we drank tea and ate raw birds, dividing with our faithful dogs.

After supper, the sun being about half an hour high, I took my glasses and went to the top of a little knoll, about a quarter of a mile distant, and looked the country over, hoping I might be able to sight game, or possibly some small timber ahead of us. Dennis picked up his gun and went with me. After scanning the country in every direction and failing to locate anything of special interest, I was about to return to camp, when Dennis started on, saying he was going farther to see if he could not find game. I insisted on his returning with me; for I thought any effort on his part, so late in the evening, must be futile. Besides, I had determined to retire early and to be off early the next morning.

We were now practically without food, and 5 days hard travel from our base of supplies; but we had made this trip for the purpose of getting specimens and I was determined to continue farther into the mountains, the next day, food or no food. Dennis was bent on making a short hunt and I finally told him to go. Then I returned to camp.

It was long after dark when he returned, and Ed and I had almost given him up for the night. We had been busy almost 3 hours, gathering little branches of willows and bunches of dry moss to keep a blaze going, that Dennis might be able to locate us; for the country for miles about was all alike. At last we saw the outlines of his form, looming up in the twilight. Dennis came swinging into camp, with a long easy stride, seeming not in the least tired.

I asked what he had found:

"Well," he said, "me find wood."

"How much wood?"

"Plenty."

"What kind?"

"Pine, cedar."

"What else?"

"Water."

"Much water?"

"Yes, plenty."

"See any game?"

"Yes."

"What kind?"

"Sheep."

"Dennis, you don't mean it. You're lying to me."

"No; me no lie. Me find sheep."

"How many?"

"Three."

"Did you get a shot?"

"Yes, me get shot."

"Did you hit any?"

"Yes, one."

"Now Dennis I know you're lying."

"No; me no lie. Me kill one sheep."

Thus he told in his stoical, indifferent fashion, that he had found a canyon filled with wood; that he had killed a sheep which had rolled down into the canyon and that our day of deliverance was at hand.

He told of his success as coolly and as laconically as he would have reported a failure.

Neither Ed nor I believed the story, for we thought it too good to be true. Still I prepared a little toddy—the last we had—and gave it to Dennis.

We were up early the next morning and without breakfast, even tea, we took our packs and started for the canyon, Dennis leading the way. After a tramp of about 3 miles and when I was becoming still more sceptical, we suddenly came upon the very brink of a deep, square cut canyon, that led from one of the glaciers, back in the mountains, down through this high table land.

Passing down the side of the canyon for some distance, we came upon fairly fresh sheep tracks, and later on the tracks made by Dennis the evening before. A little farther on Dennis pointed down the side of the canyon wall, and, sure enough, there lay the sheep he had killed. It had rolled down about 300 feet and lodged between 2 rocks.

Leaving our packs we descended, by very careful work, to where the carcass lay. While we were at work securing the head and the meat a rain set in; and when we undertook to climb out, with our loads, the steep, rocky wall had become so slippery it required our best effort to gain the top. When we finally did so we felt greatly relieved.

Only a short distance farther we found a small clump of stunted pines, growing on a little bench just under a hill, and within a few feet of a small stream, which came from a field of snow farther up. Here we pitched camp and prepared to make a hunt. We levelled off a small patch of ground on which to sleep, and stretching our 8 x 10 fly,

brought our traps in out of the rain. In the meantime Dennis had a fire going and some choice steaks and tender loins in the frying pan.

All day the rain poured down, and all day we cooked and ate and drank tea.

We were deeply grateful to Dennis for his perseverance and determination, for although in a game country we should have been in this dismal storm several days without food, but for his skill.

For 3 days the storm raged, and then came cool, bright weather and we left camp for our first hunt in the Etsezas.

Climbing a high ridge that skirted the main canyon, we sat down to take a short rest and to look over the country with my field glass; for in hunting big horn your eyes are as useful as your legs. I was sweeping a high, level stretch of country, on the opposite side of the canyon, when I caught the faint outlines of a moving object. Watching closely I saw it was the game we were after. In another moment a second animal came in sight, and handing Ed the glasses he discovered a third.

It was impossible to cross the canyon, at this point and we decided to go farther up and at the same time to get the wind in our favor.

The route was a long one, the task a hard one, and although we sighted the game at 9 a.m., it was 2 p.m. when we reached the high levels on the opposite side and we yet had some travelling to do.

Supposing the game had worked back from the canyon, we made a long detour in a direction I thought most likely to locate them. We finally sighted the 3 sheep feeding leisurely, about a half mile away.

Making another circuit, we approached a ledge of rock that was several feet above the ground. I was just a little surprised when I peered over the ledge and saw our sheep not more than 100 yards from us, in a little green basin. Two of them were feeding and the other one was lying down.

We decided to each select an animal and to fire at a given signal. This is the most awkward and unpleasant position a hunter

can occupy; but we had travelled a long way; I wanted the specimens badly, and there seemed no way out of it; so I gave the signal.

The other 2 guns cracked simultaneously but mine failed to go, and I was not really sorry, for I preferred to shoot alone.

I knew the missfire was owing to the weakness of my main spring. My cartridges were made by the U. S. Cartridge Co., and I knew they were good; for though I had carried them all summer, and they had been wet dozens of times, yet not one of them had ever refused to go.

I hastily drew a second bead on the big ram, just as he wheeled to run, and this time when I pulled the trigger I saw him go down in a heap.

Ed's animal ran about 200 yards and fell; but not so with the one Dennis fired at. It kept going, apparently unhurt.

Poor Dennis! He was mad, and "heap ashamed."

"Me catch em anyhow," he said, and away he went after the ram, that was now almost a mile away. What a sight! And how Ed and I laughed as we watched the race! Over the country they went, first the sheep in sight, on some high knoll, and then Dennis. We stood and watched them until they finally disappeared and while we could see the sheep had slackened its pace, evidently not knowing it was being followed, and that Dennis was keeping up a good run and was evidently gaining ground, yet we did not believe, for a moment, he would overtake the old chap.

A long, hard journey brought us to camp, after dark, and when we came in sight of our bivouac we saw a fire. Tea was soon ready and we ate a good supper, while Dennis told us all about it. He had really overhauled and killed the ram and one other, making 4 sheep for the day.

We now had 5 specimens—all we could carry—and we did not hunt any more; but spent the next 2 days preparing the skins and heads for carrying out of the mountains. And so ended one of the most enjoyable hunts of my life.

---

## CANVASBACKS AND TERRAPIN.

COL. FRED MATHER.

An article on "The Texas Game Market," in a recent issue of RECREATION, moves me to remark that unless the Texas canvasback has access to beds of wild celery, *Valisneria spiralis*, it "classes with the mallard," as the writer says.

The fact is that in New York and Washington the game dealers discriminate in buying canvasbacks and redheads, paying

larger prices for birds from Chesapeake bay than from any other locality. When the ducks first come to the bay, from the North, the 2 species named are thin, and are no better than mallards, if as good; but a week's diet on the roots of wild celery gives a plumpness and flavor possessed by no other duck. On this reputation thousands of redheads and canvasbacks are sold,



which come from other parts, and which are really inferior to that good table bird, the mallard. They are not even to be compared with teal.

Then we must consider the cooking of these birds. The ordinary housewife, or even the rural hotel cook, may fill them with some dressing, flavored with herbs, and cook them as thoroughly as she would a domestic fowl. The epicure, who "does not hesitate at paying for a pair of canvasbacks a price that would buy a yearling steer, in Texas," will have no such cooking. There must be no "stuffing" and the bird must be served as rare as a beefsteak. Twelve to 15 minutes in a hot oven, and served immediately on hot plates, with only squares of fried hominy, is the correct thing. This would horrify the average housewife, who would call the bird raw. It is nearly raw, but is truly delicious and this is the only way in which any dark meated game bird should be served, in order to preserve its individuality.

To cook a prairie chicken as thoroughly as you would cook a ruffed grouse, a quail, or other white meated bird should be cooked, is to destroy its flavor. Stuff and roast your tame ducks to a crisp, if you like them so; but serve the dark birds rare and hot, just as a beefsteak should be served. Then it is that the epicure's mouth waters as he slices the breast of the expensive duck, and enjoys each morsel of it served in only its own juices.

If the market gunners of Texas wish to make a name, and consequently a price, for their canvasbacks and redheads, let them plant the wild celery in their deep lakes. In Chesapeake bay the canvasbacks, owing to their power of remaining under water a long time, dive and bring up this plant from depths where no other duck can get it. Then, when the exhausted diver comes to the surface, it is often robbed by a waiting redhead or widgeon, who reaps the reward of the canvasback's industry. It is a matter of doubt if the latter can be distinguished from the redhead, when both are served on the table by a competent cook.

"These same houses are paying \$8 a dozen for canvasbacks for their New York trade," says the Texas writer. Think of that, you jolly old fellows, who pay the same amount for a pair of ducks and consider yourselves lucky to get them. A New York game dealer said to me:

"We get an order from a hotel or restaurant which will pay first class prices and we send first class birds, from Chesapeake bay, that cost us first class prices; but if they don't care to pay more than \$4 a pair we send them birds from other places, which are really no better than

black ducks or mallards that we can sell at \$1.50 a pair." These second grade canvasbacks may, perchance, come from Texas.

It is nearly the same with terrapin. In Washington they demand the Chesapeake bay animals, as they also do in Philadelphia; but New York dealers say the farther North the terrapin are caught the better they are, and that those from Long Island are best of all. This is about the Northern limit of the range of the diamond back terrapin, of the salt marshes, which is "the" terrapin of the epicures.

In each of the three cities named it is believed that in no other than their own can terrapin be properly served. Baltimore epicures smile when they hear that cooks in any other city pretend to serve the dish; while New York claims precedence in cooking it, and Washington sneers at the cooks of both.

The diamond back is being hunted so persistently that the price has risen, greatly. Only females bring the long prices, for they are larger and a "count" terrapin must measure 6 inches on the under shell. They rarely exceed 8 inches. All others are sold by the dozen, and at a low figure. Twenty years ago I have known "counts" to sell for \$15 a dozen, and within a year have known them to bring \$80 to \$100; while little bulls would bring only \$1 a dozen. Of course the latter, as well as the "sliders," or pond turtles, from the South, are used to mix with the regal diamond back, if they do not furnish the whole stew.

Personally I have failed to enthuse over terrapin stew. It is good; but that word would not satisfy the epicure who tastes, rolls his eyes and thinks he is in the seventh heaven of Mahomet. I once said as much to Mr. E. G. Blackford, the banker and fish merchant.

"Probably you never tasted it when it was properly cooked," he replied.

"That is possible," said I. "The last time I ate it was at your house, and you said it came from Delmonico's."

Col. F. G. Skinner, one of the old-time sportsmen, from the region of Chesapeake bay, used to tell this story: He was in New York and, with 2 friends, invited an inland sportsman to dine at a restaurant, famous for its terrapin. After the appetizers had been served the terrapin came on, but the stranger did not understand the "Ahs" and "Ohs" of his friends, and reached for a bottle of Worcestershire sauce.

"What are you going to do?" asked the horrified Colonel.

"Going to put some Worcester in it."

"Here waiter," said the indignant man, "take this terrapin away, and bring this man some fried oysters or something he can put Worcestershire sauce on."

# THE SUCCESSFUL REARING OF ENGLISH PHEASANTS.

PERCY SELOUS.

Given a favorable locality and a good start, combined with a considerable amount of systematic attention, there is no reason why pheasants should not eventually obtain as good a foothold here as in England and other parts of Europe. Although these birds have been thoroughly acclimatized in Great Britain for many centuries, they do not really thrive like the indigenous game birds—as the partridge, red grouse, etc.; without some extraneous supervision.

In my younger days I had much to do with pheasants, and have reared many hundreds. I was also thrown in close contact with English gamekeepers, a class of men that have, for generations, made the successful rearing of game their study. Indeed their livelihood is obtained from it.

The pheasant being not only polygamous but the cock birds being also amorous to a marked degree, they fight desperately for the harem, and during these conflicts destroy numerous nests and eggs, especially if too many males are allowed to remain. The proportion of males hatched, as to females, is usually large. It has been found necessary to control this preponderance by killing many of the male birds, but never a hen. There is an unwritten law among game preservers on the other side the water which deals most unpleasantly with any person who deliberately shoots a hen pheasant.

There is small probability that a sufficient number of cocks will not be left remaining, ordinary protection being afforded; and one cock pheasant will serve many hens. The natural enemies of the bird, fourfooted and winged vermin, would about be on a par, or perhaps a little worse here than in England, where the keeper has his "per capita" grant. These the trapper controls, to an extent. It is owing to these drawbacks, especially, that a mere go as you please policy has not proved satisfactory in pheasant preserving, across the pond; and the same rule, in all probability, holds good here, the greater extent of country notwithstanding. In England it is usual to hatch large numbers of pheasants' eggs under domestic hens; and it must not be understood that the advocates of the battue stand alone there. To the credit of all concerned such exhibitions are markedly on the decrease.

A few pheasant runs, containing each a cock and 5 or 6 hens, are necessary. In the wild state a hen seldom lays more than 12 eggs. In captivity she will lay 4 times that number. The runs should be covered with tarred twine netting, never wire, overhead; and it is preferable not to cut

the pinion feathers at all; so that after the laying season is over the hens may be turned down, the cocks being kept for exchange.

Pheasants soon become accustomed to those who attend to them, and behave like fowls, but let a strange person appear and up they go like rockets; hence the necessity of twine netting. There should be some bushes in the runs, for the hens to lay under; and if you want to succeed, never have the run twice—that is, 2 years in succession—on the same soil.

Never allow one of the caged hen pheasants to sit. For the first few days after the chicks are hatched, they should have groats, chopped egg and finely chopped onion tops. A great element of success in the rearing of the chicks is the judicious addition of a little maw (poppy) seed to the food. The chicks are then more likely to sleep, after feeding; for it must be remembered that a pheasant is not a domestic fowl; and, on the slightest alarm, instead of running to its foster mother, will rush off in any direction and hide in the herbage.

Ants' eggs are greatly relished by young pheasants and where these are hard to get it is a good plan to hang up a few beef hearts, at intervals of a few days. When full of maggots cut the lower end and allow the larvæ to fall into a box of bran, to clean. If this is not done, the chicks are apt to scour. Some animal food is necessary, and such things fill the bill.

Clean water is of the greatest importance. As the young chicks grow, the portable coops, containing the hens, should be placed near the woods, so that the surroundings may become familiar. They should never be fed without a whistle, kept for this purpose, being first blown. By this means you can always keep track of the birds, until such time as they may finally be left to their own devices.

It by no means follows that because a man can raise poultry he will succeed with pheasants. They are very difficult to rear, even with the best attention. After the young birds are left to themselves it is better they should be fed, for a while, each day distributing the maize or wheat farther into the cover.

The pheasants roost, preferably, in trees of the fir kind. This is unfortunate, for it makes the bird a conspicuous mark, on a moonlight night; a fact the pot hunter is not slow to turn to account. To remedy this evil, somewhat, keepers place dummy pheasants about, in likely trees, and this tends not only to a waste of ammunition,

but demoralizes the poacher to such an extent, that he often gives himself away.

Another matter in connection with a successful pheasant preserve is the frequent introduction of fresh blood. These birds are prone to atrophy; and in almost every instance the cause can be traced to interbreeding. Every individual, or sportsmen's club, having in prospect the stocking of woods with pheasants, must keep this in view, or disappointment will follow.

Those interested should always keep a few cock pheasants on hand, to exchange with others working along the same line. A good plan is to keep sufficient hens back, for breeding, before the chicks get too old to catch.

The aviary should be a *sine qua non* for several years, at least. If Bob White can stand the severe winters of some sections of the country, the pheasant can do so. All the same, occasions may arise when it would be advisable to feed them. Acorns are plenty, and a *bonne-bouche*, and many a sack of them could be laid by, through the agency of the small boy and a "wee bit o' siller."

With regard to the severe winters: I happened to be in England during the season of 1890-'91, when the canals and lakes were frozen so that vehicles could be driven on the ice. The snow lay for months, deep on the ground. The foxhounds were not out for many weeks; yet the cold did not seem to affect the pheasants at all, notwithstanding the indigenous birds perished in large numbers. Blackbirds, thrushes and rooks were lying about everywhere.

Some of the suggestions here advocated may be difficult of adoption in this country. I merely give them as based on a wide personal experience, as well as on that of others of like experience, in the hope that those who are interested in the introduction of this magnificent bird may find a hint that may be of service. I don't believe the pheasant will introduce itself here, any more than in England, without help from human hands. It will take time, perseverance, some money, and that reciprocity, which should exist between all sportsmen and sportsmen's clubs. All such should assist the game wardens, in their endeavor to enforce the laws.

I question the wisdom of a law which prohibits, absolutely, the killing of Mongolian pheasants, up to a specified date. Much study of the habits of the bird points to the conclusion that such a law will largely defeat its own end. It should rather make it an offence to kill a hen pheasant. At no period after the first moult is there any possibility of confusing the sexes, unless it be in extreme age, when the hen may, in rare instances, don the garb of the male, and vice versa. Evasion of such a statute would therefore not be easy. There are 2 most essential rules to follow, in order to succeed in rearing pheasants: First, you must first keep down an undue proportion of cock birds. Second, you must infuse, year by year, fresh blood, through the introduction of cocks from a distance, by exchange, purchase or other means. The game hog must be squelched.

All honor to men like the Editor of RECREATION, who so determinedly sets the pace in this warfare.

---

## CANOE SKETCHES.

### II.

E. L. COLE.

"What's the matter with taking your canoe and going up on the sand bar to-night, after ducks," said Frank, one afternoon in September of '92, as he was passing my window. I was busily engaged taking off a balance, but dropped my pen, thought a moment and replied:

"All right, when shall we start?"

"Any time after 5 o'clock," answered he; and accordingly at that hour I had my work done, the bank locked and Frank and I were standing in the shed where my canoe was stored, debating as to whether it would be easier to carry it to the lake on our heads, a distance of about a mile and a half, or paddle up the river, which would be

nearly 3 miles, against a stiff current. The canoe was one of the lightest I have ever seen. It was made by the Chippewas, of birch bark. We decided to carry it, Indian fashion, and after carefully stowing our guns, ammunition, etc., under the thwarts, and tying them securely, so they could not fall out when we turned the canoe bottom up, we hoisted her on our heads, and began the march.

The boys made a good deal of sport of us, as we started out of town, yelling "Bushoo Neche" and other Indian phrases.

Once, on the road we heard ahead of us a feminine cry of "Look out! Look out!"

and hastily taking the canoe from off our heads we saw a woman seated in a buggy, drawn by an old white mule. The beast had planted his feet firmly, stuck his ears forward in the most comical fashion, and had refused to budge another inch. I took him by the bit, and, with difficulty persuaded him to move on. Then we did likewise.

The lake reached it was a short task for a pair of brawny young arms, well trained to the business, to shoot the light shell across the quiet waters of Prairie lake to the North end, where a point or bar extends Southeasterly nearly across the upper end of the lake, and nearly encloses, on the North, a fine bed of wild rice. This had, in years gone by, furnished food for numberless flocks of mallard and teal. Of late years the place had been overlooked, the hunters taking it for granted that there could be no shooting so near town.

It had, however, been reported to us, a day or 2 previously, that the ducks, being shot at so much on other lakes, were now in the habit of coming in there to feed nights, and to "roost" on the sand bar where, along the edge, in the shallow water, plenty of wild celery is to be found. Our plan was to build a blind out of rushes and cane brake, which grew there in abundance, and, putting our blankets inside this cover, to pass the night there and be ready to round them up as soon as the "Aurora of morn should illuminate the oriental horizon."

We hid the canoe, up on the shore; found a nice location on the edge of the bar, near where the wild celery grew, and there erected our blind. We filled it up, inside, with dead rushes, took our guns and, wrapping our blankets around us lay down—but not to sleep.

It was a perfect evening, cool and clear. There was no moon but the stars kept it from being dark. We curled ourselves up, on our bed of rushes, and lay listening to the different sounds that came floating out to us across the water. Yonder the plaintive good-night notes of a Wilson's thrush, from his retreat in the brush land across the lake. Back of us, on the meadow, the "clink"—"clink"—"clink"—of a cow bell as its owner lay chewing her cud—keeping time with the bell as perfectly as the beat of a metronome. Down at the foot of the lake, the occasional rumble of vehicles could be heard, as they crossed the bridge.

The cackle of mud hens, right near our nest, irritated Frank and he couldn't sleep. Every few moments he would let out an ejaculation that would make the atmosphere inside our blind smell decidedly sulphurous; but it did not disconcert Miss Mud-hen a bit—she kept right at it. I fell asleep about midnight, and had just gotten nicely to dreaming of ducks, flying at me

from all quarters, and I dropping them right and left, when I felt a punch in my ribs which brought me to my senses and angered me too. Then Frank growled,

"Come, let's get out of this — hole!" "I'm getting wet."

I rolled over on my elbow and asked him if he was crazy or if he had been walking in his sleep and had fallen into the lake?

"By Gosh," said he, "you don't have to go outside this blind to get wet; there's water right here under us, and I am lying in it!"

"Oh come off!" said I, "we are more than 20 feet from the water's edge, and at least 6 inches higher up. Lie down and go to sleep. Or if you don't like this place to sleep go where you like it better!" And mad as a hornet at being thus awakened, for nothing, when I was having such good luck (in my dream) I dropped back into my nest resolved to sleep in spite of my unruly neighbor.

Presently a wet sensation about my shoulder became apparent. I said nothing, at first, but quietly passed my hand up there, and—sure enough it was water. I felt around and found that there was water on all sides of us, and that it was soaking up through our bed of rushes. Frank was sitting up, now, and muttered something about its being a wonder I didn't lie there and sleep till I floated away—that he told me it was getting wet. I scrambled around, got my gun and rolled up my blanket.

"Frank," said I, "where in thunder did this water come from? There was none near us when we lay down; and now it is 2 or 3 inches deep all over the bar."

Frank said he didn't know unless Frazee had opened his dam. That proved to be the cause of the flood. Mr. Frazee, who owns the water power below, had, the year before, built a dam between this lake and the next above, to hold back the surplus water during the rainy season and this very afternoon he had driven out and opened his head-gate, as his supply of water was getting short. It took but a few hours' time to raise the water, around this bar, a foot, and it was still rising.

"What shall we do?" asked Frank. "Stay here?"

"I guess we might as well," I replied. "It is getting so late we had better wait, now, until daylight. What time is it any way?"

Frank pulled out his watch, and my spirits dropped when he announced that it was but half past one! We made up our minds to stay, however, and after gathering up our things and putting them in the canoe, we sat there, shivering, until daylight.

We had not heard the first sign of a duck flying into the lake during the night, but somehow we hoped that when day light came we should get some shooting.

We were, however, doomed to disappointment. The rising water had entirely submerged the wild rice and the few flocks that came in, circled around, at a distance, and, seeing the aspect so changed, went away without stopping. Just as the sun began to peep over the woods, in the East, I proposed that we give it up. Frank was only too glad to do so, and we pulled down across the lake, feeling rather "down-in-the-mouth."

The beauty of the scenery, on lake and river, in the rosy light of the morning, brightened our spirits somewhat, and before we reached town we were singing. Frank seemed to have forgotten the misery of the night, and to be as good as new.

Some incidents of this life look better in retrospect than when we face them, and though we didn't enjoy that night, we laugh now when we remember how we got floated off the sand bar.

---

## ON WHITE RIVER.

J. M. CAMPBELL.

The weather was cold, and almost every day the wind whistled through the trees, blowing the snow off hill-sides and piling it up in the gulches. We had been waiting many days for these White river zephyrs to cease their continual moaning. Finally, as necessity knows no law, we were compelled to get some elk; for, as in the case of all guides and hunters, meat was a large part of the provisions found in our larder.

On the morning of December 20, the sun shone dimly through a veil of clouds; so my partner, Chas. Smith, and I thought we would better start before the sun hid his face altogether. We went to a cabin between the South Fork of White river and Elk creek.

On the first day we saw plenty of tracks, but no fresh ones. Although the wind was drifting the snow so at times we could see only a short distance, we hunted faithfully all day, coming in at night, without having seen an elk.

On returning to camp, we found 2 other hunters, who joined us in the hunt on the following day. The snow was deep, reaching to the horses' sides, but, by taking turns riding in the lead, to break a trail, we managed to get along.

About noon we saw a bunch of 12 elk. On seeing us, they ran over a hill, toward Elk creek, but as we knew they would hesitate before going through a lot of fallen timber directly ahead, we followed. One of the strangers, a German, was in the lead.

Just as we reached the crest of a hill he dismounted and began to shoot. We could not fire for fear of hitting him. He was excited and was moving from side to side, which brought him directly in line with the

elk. Finally, 2 cows ran to the left, and we shot them. The main bunch moved off. We went to dress the cows, while the German followed the band.

After we had looked at the tracks, to make sure none of the others had been wounded, we struck across to some hills, where the snow was not so deep. Tracks were plentiful, but we traveled fully 3 miles before seeing any game. Then we saw an elk run into a grove. Shortly afterward 4 more were seen. They were some distance off, but after firing 3 shots each, one dropped and another went off, wounded.

Away went the dog on his trail. Every now and then we could hear the dog baying, but before we could get close enough to shoot the elk would run. We had to get off our horses occasionally, to break trails through the drifts. About dusk we killed the wounded elk, and started for camp.

Arrived there, we found supper ready, and while we were doing justice to that, our German friend entertained us with a story of his adventures.

After leaving us, the first thing he did was to get into a lot of fallen timber. Extricating himself from that, he followed the elk until he got within range, when he fired a few shots, but killed nothing. In making his horse jump a log, a branch caught him under the chin, knocking him out of the saddle. One of his feet stuck in the stirrup and the horse dragged him a short distance through the snow. Although his back was lame, and he complained of a "crick in the neck," we all went down to the river together, the following day.

---

## UP MOUNT KATAHDIN.

F. S. CRABTREE.

We went to Milo, Me., on the Bangor and Aristook Railway, where we took a small steamer running from Lake View to Schoodic. At Norcross we loaded our canoes and other truck on a scow, when the steamer took it in tow and started up the lake. After leaving the lake we had 5 carries to make and a good deal of quick water to pole up.

We finally reached our destination and pitched camp on Katahdin, or, as the map has it, Abotjackamat.

After dinner I went over about a mile to another stream and found where a big moose had wandered along the bank a few days before. His tracks looked like those of an ox. We hunted hard but did not get a thing for 4 days. Then Cole went out, on the Katahdin trail, sat down, and had been there but a few minutes when a doe came along and stood up to be shot; so we had venison from that time on.

There were plenty of deer, but the leaves and weeds were as thick as in summer and it was almost impossible to see them. I wounded one deer but failed to get it. Then another member of our party killed 2, another killed one, etc. We started some caribou but did not see any. One night a big moose came down to the stream, right across from our camp, and not liking the looks of things turned and went away again.

On October 4th we started for the foot of Mount Katahdin, 5 miles from our camp on the river. It was very cloudy, as it had been all of the time. We climbed to the foot of the landslide; made a brush lean-to and stayed there till morning. We breakfasted at daylight and started on the long climb. The labor was terrific. Think of going straight up a hill 3 miles long, at an average angle of 40 degrees, in a narrow road, with no chance to beat from side to side to get an easier grade, and you can get a faint idea of what it was. In many places the grade is 50, 60 and even 70 degrees.

Near the top, where it is very steep, we could go only about 75 to 100 feet without stopping to rest, and our hearts were beating like trip hammers. We had to be very careful not to start any stones down on those behind us, as the slide is covered with them, of all sizes, and all loose.

Within about 1,500 feet of the summit we reached the top of the slide, and from there up it is about as near perpendicular as it can be and have the stones stick on the side of the mountain. We called the grade here a good 70 degrees or more, and this was where we had to get down to business. It is one mass of rocks of all sizes, and it looked as though there was danger of pulling some over on us. Sometimes when I would come up under a big rock, weighing

some thousands of tons, with nothing, so far as I could see, to hold it up, I would get out from under it as soon as consistent with dignity.

Finally, after about 2 hours of hard work, we reached the summit, and it was just like going up over the edge of a table. The top, or table-land, as it is called, is an immense boulder-strewn plateau, of many hundreds of acres; and to get on the highest peak we simply walked off to the North side, something over a mile away.

I forgot to say that when we had gone up about 2 miles we got through the heavy clouds, into the sunshine, and the top of the mountain was as clear as could be. From the summit we looked out on the clouds, far below, and it was a most beautiful sight. It looked like a great ocean, with waves rolling on it. Far away we could see the blue tops of several mountains, showing above the clouds, exactly like islands in the ocean. Of course the view was shut out below, but it was beautiful as far as we could see. On the North side is an almost perpendicular cliff, 3,000 feet high, which is wild and rugged in the extreme.

Nearly 350 lakes can be seen from the top of Katahdin, on a clear day, and the view must then be magnificent.

It is remarkable and fortunate, too, that there is a spring of excellent water on the top of the mountain. We were all half dead with thirst when we got up, and all stampered for the spring like a drove of cattle.

We saw the skeletons of 2 caribou that some wretch had shot, sometime in August I should say. The legs had dried, but the eagles had picked the bones quite clean. Cole said last year they saw 6 or 7 carcasses that someone had shot and left, in the same way.

Doctor Ford, a large, heavy man, did not get to the top for more than an hour after the others. One man stayed behind with him to locate the remains in case he should fall down the mountain. The Doctor was a total wreck when he finally landed.

We stayed up there 3 hours and then started back. When we got to the edge and looked straight down, about 1,200 feet, and saw where we had to go to get to the upper end of the slide I could feel my hair rise. The slide, all the way down to where it disappeared in the clouds, looked like a great road and a fearfully steep one too.

It was very hot, going down, and the sun almost burned our feet. We were glad when we got down into the clouds again, where it was cool. About 2 miles down we came through the clouds and could see the country below. We reached camp on the river just before dark, tired and foot-sore, and I don't think the Doctor is thoroughly rested yet.

## FROM THE GAME FIELDS.

### THEY KILLED A COW MOOSE.

Dover, Me.

Editor RECREATION: Your magazine is as interesting as ever; and that is saying enough. I came from Moosehead lake not long ago. The large game is as plentiful there as ever. Saw more moose this summer than ever before. Deer are about the same as usual; and that is enough. A year ago I spent some time in Northern Wisconsin, in that part of the state which they claim has the best hunting; but the large game is so scarce there as to seem to me to offer no hunting at all. It is very scarce, compared with Moosehead.

In all this vicinity the ruffed grouse seem to have nearly disappeared, for the season. I cannot account for it. Have talked with some men who have been about the woods all summer and who say they have not seen a single specimen. No doubt one reason is the great number of foxes. At Moosehead lake foxes might almost be said to swarm. To see 5 in a clearing, at one time, is nothing strange. Not only do these kill small game, but some of the best guides are confident they kill very young deer. And think of it! At our last legislature there was an effort made to protect the rascals.

I have talked with a large number of intelligent sportsmen and guides, and there seems a consensus of opinion that there should be a bounty on reynard. There may be an effort to enact that opinion at our next legislature.

No doubt the buzz of the "moose case" has reached your editorial sanctum. I refer to the case where 2 young men, from out the state, shot a cow moose, up beyond Chesuncook lake; or report is to that effect. With us it is much more than "town talk." It is state talk. At present there is in the minds of most people, great fear that there may be an abortion of justice.

As you know, the penalty for killing a moose, in close time, has lately been changed from a fine to imprisonment. That was done so that wealthy men, from out the state, who would not stop at a fine, but who would fear imprisonment, should not slaughter the moose. It was expressly intended to meet the rich class. The very first case under the new law was one of that class—the wealthy—if report be true.

At or about the time of the preliminary hearing of the case, it is said, one of our high officers had an interview with the father of one of the young men who is charged with the killing of the aforesaid moose. Soon after an article appeared in many of our papers in which this officer stated, over his signature, that he would rather resign his position than see the law executed, in this case.

It may be that great injustice has been done the officer. If so an adequate explanation would be good for himself, the law, and the public. It is to be hoped the sequel may prove a sufficient explanation. If it does come, let that be as widely scattered and believed as has the accusation; but if no such explanation comes, he could resign, "by and with the advice and consent" of the people; and that is putting it mildly.

I say this, not in order to in any way injure the game commissioner, but that the public, elsewhere, may know what the public, here in the immediate vicinity, thinks of this case. I hope that the affair may be cleared up, to the vindication of the position of the officer. Personally I shall be only too glad to assist, in any reasonable way to do that. But there is an immense amount of public opinion abroad, on this question. I have yet to hear more than 2—from a large number—speak of the case without demanding a reason for the officer's lack of action.

It now appears there is danger that those who are accused of a violation of the law may go free without a trial, or imprisonment, or fine; even without so much as the forfeit of bail; as they say that the bail was "straw."

Our faithful county attorney proposes to take steps for a requisition, so that a fair trial may yet be had; for those charged with the violation are no longer within the limits of this state. We wait for the end.

What a difference of opinion there is as to the killing quality of the new 30 calibre nitro rifle cartridge. This difference of opinion is expressed not only in print, but in private interviews. I am anxiously waiting to have that question settled.

H. B. Tilden.

### HOW LONG WILL IT TAKE TO KILL ALL THE GAME?

New Haven, Conn.

Editor RECREATION: It amuses me to read your editorials, under various hunting and fishing notes, regarding excessive bags of game and fish. Of the hard knocks you give (deservedly) some of the contributors, the one under the heading, "What constitutes a reasonable bag?" is especially good.

While I am glad game can be found in such quantities as to allow of such bags, it strikes me the make-up of a man who will allow himself to kill game in such quantities, is largely selfishness.

What is the motive that takes a true sportsman into the woods or fields? Is it merely a desire to kill? Not at all. It is a love of nature. Why then should we abuse this privilege? Let us remember there are

others in the world who are entitled to a share of its good things. Let us also consider the great number of game birds falling, each year, to the guns of even reasonable sportsmen.

These run into the thousands, as the following figures, based on the circulation of RECREATION, alone, will show. Supposing 75 per cent. of its 30,000 subscribers are active shooters, and I am under the impression this is a conservative estimate.

At the rate of one day's shooting each week, during the open season, October, November and December, and at the rate of 15 squirrels, or 15 birds, ruffed grouse, quails, woodcock or wild fowl, or 15 birds made up from all these varieties, there would be killed over 4,000,000 birds.\* Think of it. Even at this reasonable rate how long will it take to destroy all the game birds in the country?

Answer this for me fellow sportsmen.  
"Horizontal Axis."

#### A BRUTAL SIDE HUNT.

Here is a report from the Leominster, Mass., Daily Enterprise:

Interest in the hunt of the Gute Zeit club increases with each day. Members of the teams will be permitted to hunt all day Saturday with or without dogs, but all game to count must be shot Saturday and must be in the club rooms before 8 o'clock, to count.

The game will be counted as follows: Fox, 100 points; coon, 60; owl, 75; blue heron, 50; partridge, duck (wild), hen hawk and black squirrel, 50 each; woodcock and crow, 40 each; gray squirrel, 30; rabbit, 20; red squirrel, 20; chipmunk, 10; skunk, 60; woodpecker, 10; blue jay, 10.

Captain Weston's team is made up as follows; H. E. Weston, A. L. Jobes, L. C. Jobes, J. E. McClaren, H. T. Baillie, Dr. Wiley, E. E. Hutchins, Will Tanner, Joseph Dews, Erva Ames, A. S. Paton, Banks Trumbull, J. J. Scanlon, D. W. Garland, G. E. Sanderson, A. C. Hosmer.

Captain Bicknell's side is composed of H. B. Bicknell, C. T. Foster, Herbert Carter, Allen Way, Charles Jobes, Walter Baker, Ernest Meekham, William Kailey, Dick O'Brien, J. H. P. Dyer, Marvin Sherwin, J. L. Miller, Clayton Bates, Archibald Woods, Edward Robinson, Herbert Litch, E. F. Patterson, Samuel Haskell.

I am astonished to learn that in a state containing so many true sportsmen as are to be found in Massachusetts, there could be mustered 33 men of such brutal instincts as to engage in so wholesale a slaughter as is indicated by the above announcement! These side hunts have long since been condemned by all respectable sportsmen everywhere; yet here in Massachusetts, the centre of refinement, the home of culture, of advanced thought, a body of 33 men start out and wage a competitive warfare—a war of extermination—on such game as ruffed

grouse, squirrels and woodcock! Yea, these butchers even include in their list of subjects for the slaughter, such beautiful and harmless creatures as blue herons, red squirrels, chipmunks, woodpeckers, and blue jays! A heron is to count 50 points; a red squirrel 20; a chipmunk, woodpecker and a blue jay 10 each; so it is safe to say not a single specimen of either will be allowed to live if these bloodthirsty butchers can have their way.

Are not woodpeckers and blue jays protected by the laws of Massachusetts? The game warden of that district is advised to investigate.

These Leominster slaughterers are a disgrace to the noble Bay State and should be driven out of it.—EDITOR.

#### DOGGING GAME IN WYOMING.

Dubois, Wyo.

I find, in reading the September number of RECREATION, that a former guide, from Colorado, has cast his lot in the wilds of the Green river mountains, with the avowed intention of running the game animals of that country, with dogs. This man may be sincere in saying he intends to use these dogs for hunting bear, mountain lions, and wolverines, only; but let me ask him: If these dogs were turned loose in the timber, even on the trail of a bear, and if a band of elk or deer were jumped, during the run, is it at all probable that the dogs would continue on the bear trail, with nothing in sight? Would they not at once turn their attention to the animals in view? Even if they caught and crippled none, would they not run them out of the country?

Most assuredly they would. It is just as natural for a dog to run a deer or an elk as it is for him to run a bear or a lion; and the chances are the dogs could not be called off.

The law forbids this form of hunting, in Wyoming, not mentioning bear or lions; but, as I have said, if they run one they will run the other.

The law, in this as in all respects, will be enforced, in this county, and Mr. Wells may find himself in trouble if he undertakes to run his dogs in this state.

I fully agree with him, in regard to the "noble red man," and sincerely hope the day is not far off when these curses of the community can be made to obey the laws, as white men are required to do.

Chas. G. Poole,  
Deputy State Game Warden.

#### HIS FIGURES ARE LAME.

I read with much interest Mr. Leavenworth's "defence," in your October issue, and am curious as to his arithmetic. He

\* This correspondent says in a private note, that he figures my circulation at 35,000 by post-office receipts published in September RECREATION. In addition to my large mailing list, the American News Company handles 12,000 copies a month. Each copy of this magazine is read by at least 4 people; so that RECREATION has 175,000 readers instead of 35,000 as Horizontal Axis computes. Therefore the destruction of game birds must be 4 to 5 times greater than his figures would indicate.—EDITOR.



says he and his wife, together, killed 296 squirrels. He says, farther on, that 12 was the largest number killed in a day, and that it took exactly 15 hunts to kill the 296. Now  $12 \times 15 = 180$  and  $296 - 180 = 116$ , will Mr. L. please account for the discrepancy?

Deer and bear are very numerous at this place this season, but as they confine themselves strictly to the swamps and no one in this vicinity has any good dogs, but few bear are killed.

Such as are killed about here, are generally shot while "lapping." In the latter part of October and November gum berries are ripe and bears come out on the edges of the creeks, at night, to eat them. Two men generally go, one to paddle and the other to shoot. The boat is pushed or paddled as noiselessly as possible up the creeks until a bear is seen, and then the shooter gets in his work.

Many bears are shot this way, but only a few killed, as a bear can carry off a good many buck shot. Besides, the uncertain light does not tend to good shooting.

Quails are very numerous here and in the adjoining counties and everybody expects fine sport this season. The summer has been dry and the young birds have done well.

Some ducks are arriving here, principally teal and sprigs, but no red heads so far.

Do you call the author of "On Croatan" a game hog? Twenty-six geese and a swan, for a day's gunning, looks a good deal like it.

A. S. Doane, Coinjock, N. C.

#### THE MAYOR PLEADS NOT GUILTY.

A report was published in a Michigan newspaper some weeks ago, and was widely copied, to the effect that Mayor Harrison, of Chicago, had caught 82 fish and killed 67 woodcock in one day, in Michigan. Several of my good friends clipped this item, from as many different papers, and sent it to me, suggesting that I roast the Mayor. I replied to them, that I did not believe the story, because I did not think a locality could be found in Michigan where 67 woodcock could be killed in one day, by one man, even if he shot all day. As the Mayor was credited with a string of 82 fish, in the same day, he could not well have had more than half the day left for shooting.

I wrote Mayor Harrison, asking him whether or not the report was true, and here is his reply.

Dear Sir: Your letter received, and contents duly noted. The statement that I caught 82 fish and killed 67 woodcock in one day, in the State of Michigan, was not made by me and is not true.

This yarn, and the story that I was arrested as a tramp, probably originated in

the same fertile brain. I am sorry to say I have never killed a woodcock. In fact have never seen one except at \$1 each.

Yours truly,

Carter H. Harrison.

#### A SPORTSMAN'S PARADISE.

Hope, Idaho.

Editor RECREATION: Far up in the Rocky mountains, in Idaho, is Lake Pend d'Oreille which, with its great expanse of water and its numerous tributaries, forms a veritable Eden for sportsmen.

Not only is the angler's love of sport gratified here but the adjacent mountain fastnesses furnish bear, deer, moose, elk, wild-cats and cougars, with a fair number of grizzlies.

Lake Pend d'Oreille is about one day's journey from Portland, Ore., and 2 from St. Paul. It is easily reached, as the Northern Pacific railway skirts its rugged shores; crosses and recrosses its long, octopus-like arms, and follows the banks of Clark's Fork for many miles, thus reaching a large territory for stream fishing.

High, almost perpendicular, mountains jealously guard the rippling waters of the lake, on one side, while on the other is the town of Hope, where there is a good hotel.

There is no temptation to break the third commandment, while fishing in the Lake Pend d'Oreille region, for there is no underbrush to annoy the angler.

With our present luxurious system of travel, Lake Pend d'Oreille can be reached with as much comfort as may be enjoyed at any eastern hotel.

The varied scenery, along the railway, prevents the journey from becoming monotonous or tiresome. Those in quest of game, and lost appetites, can find no better place for an outing than this region affords.

Mrs. F. Cauthorn.

#### THE KEYSTONE STATE'S NEW GAME LAW.

New York City.

Editor RECREATION: It would interest many of your readers to read a digest of the new Pennsylvania game laws; so I give you same.

The sale of any and all game is prohibited. Use of ferrets, on rabbits, also prohibited. Daily limit, for shooting, 10 woodcock, 10 grouse, 15 quails, 2 wild turkeys.

Deer may be killed during November only, and but 2 may be taken by any one man in one season.

Woodcock may be killed during July; also October 5th to December 15th.

Rabbits, November 1st to December 15th inclusive.

Ducks, reed birds, snipe, plover, pigeons, no change.

Grouse, squirrels, quails, and turkeys may be killed October 15th to December 15th.

Mongolian and English pheasants not to be killed for 5 years.

No game can be taken out of the State, by any one.

What a model game law! I would there were more like it. But what will become of the poor game hog? I, as well as every true sportsman, long for the glad day when his blighting hand shall be pinioned by the majesty of the law; or else when there shall be an open season, the year round on game swine, with no limit on the bag. Orrin D. Bartlett.

#### GOOD GAME IN MAINE.

No wonder people like to come to Maine in the fall. Here's the report of how 2 visitors to West Casco spent a week:

Monday they went to the mouth of Songo river fishing. Caught a pickerel that weighed 11 pounds and 3 ounces; 3 black bass, the largest weighing 9 pounds; and killed a water snake 9 ft. 9 in. long.

Tuesday, went trout fishing. Caught 206 brook trout.

Wednesday went to Raymond Cape; caught 250 white perch, 90 pickerel, 60 hornpouts.

Thursday, went hunting; shot 36 gray squirrels, 8 woodcocks, 7 black ducks, 5 bluejays, 2 crows and 3 polecats.

Friday went fishing in Long lake; caught 31 black bass, 47 pickerel and shot a mink.

Saturday went to Harrison. Shot 2 black coons. In the afternoon went fishing; caught 73 black bass, 4 pickerel, largest 5¾ pounds.

Sunday went to Mount Pleasant. Saw the Devil's Den; killed 4 black snakes, the largest 6½ feet long.—Narragansett Sun.

For several years I have been a constant reader of RECREATION, and of late have noted, with much interest, your "straight from the shoulder" blows at the game hogs who pose as sportsmen. I clipped the above from the Boston Globe of to-day. It was evidently copied from a Maine paper. If these 2 "visitors" are not the biggest game hogs that ever escaped from the pen I don't know where you would them.

L. C. Shepard, Somerville, Mass.

If the report were true these men would be entitled to wear the champion hog collar, by turns; but it is evident the report emanates from some expert liar. Game and fish and snakes are not running at "visitors" in this generous fashion, even in the great State of Maine.—EDITOR.

#### OLD DOMINION GAME,

Richmond, Va.

Editor RECREATION: You may say to the boys though old Virginia is noted for her hospitality she cannot throw her gates open as wide to sportsmen this fall as she is wont to do. Our game has been protected, for 2 years, by law and by the true sportsmen, and not for 10 years have we had such an abundance of quails. A like report comes from North Carolina.

The law expires here in January. The Virginia sportsmen's association's representative will appear before the General Assembly, in December, at its convening, and

ask that this law be repealed, thereby giving us at least one month's shooting.

The sora season opened September 1st and we had fine sport.

Richmond has organized a new Gun Club, known as "The Pass Time Gun Club," with Mr. H. B. Hunter as secretary and treasurer. Shoots each Tuesday afternoon.

Messrs. T. W. Tignors' Sons, of this city, are displaying a handsome silver punch bowl, in their sporting goods establishment, valued at \$75, which they have presented to the member of the West End Gun Club, of Richmond, for best season score of '97. The contest is very close and a hard fight is being made for the coveted trophy.

Virginius.

#### A RELIABLE GUIDE.

Denver, Colo.

Editor RECREATION: I still read your magazine and wish to congratulate you on the wonderful improvement you have made in it, in the last year. It is certainly the only magazine of its kind, with a striking individuality that is beyond imitation.

To the old sportsman it appeals especially; as he can readily see that its editor is not a theorist, but that he has "been there" and knows whereof he writes. It is a rare accomplishment to be able to tell, on paper, your experiences in the field, and "ye editor" of RECREATION certainly "slings a lively quill," in that line.

I notice the name of Richard Tregoning, of Laramie, Wyo., in your list of guides, and, unsolicited, I want to recommend him as one of the best and squarest of men. He is a genuine sportsman and can be depended on in any emergency. I have known him, personally, for nearly 10 years; have hunted with him often, and in all kinds of weather, and he has never been other than a true man and a genial companion. Recommend him whenever you can, as such men are seldom met. He is a living illustration of the motto of the Laramie Gun Club: "The true sportsman never repines."

D. L. Mechling.

#### THE WORK OF A GRIZZLY.

French, Wyo.

Editor RECREATION: I have lately been reading Mr. Hornaday's book, "Two Years in a Jungle," and have learned a great deal from it about dissecting animals and preserving skins, for mounting; and about the customs of the different tribes of India. In fact, I have learned much in this book I could not have learned from any other.

There are lots of bear sign near the ranch but I have not had time to hunt or trap.

We have had trout for breakfast every morning for 2 months, mostly out of French creek. There are no large rainbows except in the river. Those in the small streams are brook trout, which are better eating than the large rainbow.

I saw a 2 year old steer, the other day, up at the ranch where I used to stay, that had been attacked by a bear and had got away from him. The owners sent me word to take up some tar to keep the flies from blowing the wounds. The steer had been struck on the top of the shoulders, with one foot, and skinned down. Take a broad shingle and you have the size and shape of the piece of skin that was hanging down, and which had to be cut off. I do believe the bear was my old fellow with one foot off, or that steer never would have got away alive. The bear had failed to get hold with his mouth, and the steer had bounded away from him.

Ralph Anderson.

---

NOTES.

I spent a lovely summer in a houseboat, on Georgian bay. There were plenty of fish to be had, and we had black bass nearly every morning, for breakfast. One day when my brother and father were out in a boat, on Miner's lake, father happened to look around, and there was a deer just entering the water. It had not seen them; so when it got out a little way they rowed around and got behind it, on the side nearest land. It then tried to swim across, but they got on the other side and kept it from returning. It again tried to swim on across but they got on that side, and kept chasing it up the lake for mother to see, as she was just around the point. As they got near the point the deer made a final effort and passed the boat. It was so near that my brother leaned over the bow of the boat and caught the deer by the tail; but had to let go or the deer would have kicked the bottom out of the boat. The animal was, of course, greatly frightened and made lively time getting into the woods.

G. S. Beatty, Brimfield, Mass.

---

York, Neb.

My Dear Coquina: I have often thought it strange that prominent gun, fishing tackle and powder makers, such as Colts, The Hunter Arms Co., The Hazard Powder Co., Laffin & Rand, Mills & Son, Abbie & Imbrie and others do not advertise in RECREATION. This is certainly short sighted business policy on their part. They must know they are losing thousands of dollars, every month, by not being in RECREATION. I have heard at least a hundred sportsmen say they would not buy goods of any house that would discriminate against this, the

leading sportsmen's periodical in the country, while patronizing its competitors.

I know a great many men in the West who say they would not shoot a gun, or a revolver, or a brand of powder, or use a fishing rod or a reel, that is not advertised in your magazine, especially while such goods as DuPont's powder, Lefever & Ithaca guns, Marlin revolvers, etc., are advertised there.

M. W. Miner.

---

Your reply to criticism on the use of numerals is right to the point and I think nearly all your readers will agree with you.

The law opened on deer the 1st of September, in New Brunswick. It is too bad; for many does and fawns are being shot. The 1st of October is soon enough for any true sportsman to go deer hunting; and even then you get more does than bucks. Law or no law, I do not want to go after my deer until October. Then I want to get a good pair of horns. I got a doe last fall. She was about 135 yards away and she was looking around a small tree. The branches, overhead, made her look like a buck. My bullet struck in her forehead,  $\frac{3}{4}$  of an inch from the centre, and she dropped right in her tracks. When I came up and saw it was a doe I was sadly disappointed. No true sportsman should kill more than 1 doe on any one trip, and that only to save him from coming home empty handed.

J. M. Kerr, Milltown, N. B.

---

I am glad to see your note at the foot of page 303, in October RECREATION. Mr. Jaques surely does not appreciate what game protection signifies, when he says a reasonable bag of game is all one can get with a gun, and make good use of. I am sorry Mr. Jaques was ever permitted to set forth such a doctrine in RECREATION. We are advocating game protection and that includes moderation in the taking thereof. Game may be plenty in some places; but that does not justify any man in killing all he can.

Game is scarce here. Rabbits are increasing some, since the law protects all kinds of game, and I hope the laws may be more stringent than ever, until the country becomes better stocked with all kinds of game.

D. Wogaman, Quincy, O.

---

We are getting fair trout fishing in some of the small streams, here in Northwestern Nebraska. Both brook and rainbow trout are taken. The streams have been stocked from the State hatchery. The trout do well, for the small streams are fed by springs of cold water. Pine creek is the best stocked and contains the largest fish. Rainbow trout have been taken that weighed 6 and 7 pounds.

Grouse and chickens are scarce this fall, for the pot hunters' cleaned them out in previous seasons. Duck shooting is always good in spring and fall.

Major Clapp, Indian Agent at Pine Ridge Agency, did a good thing by stopping spring shooting on Pine Ridge reservation, and should have the commendation of every true sportsman.

J. P., Valentine, Neb.

Enclosed you will find a clipping from one of our morning papers, which I think will interest all true sportsmen. In my estimation RECREATION is the best magazine in that line of business, and my wife and I anxiously await its arrival, for we both are devotees to the rod and gun and are naturally fond of such reading matter.

A. L. G., Denver, Col.

The clipping reads as follows:

J. T. McLean, as-istant commissioner of fish, forestry, and game, while at Sapinero, caused the arrest of the hotel proprietor there, on a charge of serving game to his guests. The hotel man was convicted and fined \$50 and costs.

"Fishing was never better than it is in the Gunnison country just now," said Mr. McLean. "A few days ago a party of 3 went out on the Gunnison river not more than a mile from Gunnison City, and came back with 3 rainbow trout, weighing respectively 8, 8½, and 9½ pounds. On the same day Dr. Sanford, of Gunnison, landed a 10½-pound rainbow. All the fishermen report an abundance of big rainbows in the Gunnison this season, and general trout fishing is good all over the State."

We have just organized the Grayson County Pheasant and Game Protective Association, at this place, with 40 charter members; and hereafter we intend to see that our game laws are not violated. We have ordered 68 Mongolian pheasants, which, with those we have on hand, will give us 75 to start with. We shall divide these up into coops of 5 or 6 each, and distribute them among the sportsmen and others. The eggs will be hatched by domestic hens, and we shall not turn out any pheasants until about March, '99. We think by that time we will have enough to stock the Northern part of the county and a portion of the Indian Territory. Pheasants are protected, in Texas, for 5 years from last August.

Levi Lingo, Denison, Tex.

Enclosed find \$1 for RECREATION, for one year. Have been reading it for several years. Like it better than any sportsman's journal I ever saw, and I have read them all.

Kansas is blessed with an abundant quail crop, which is not the least of our blessings, this year, thanks to the protection law for past 5 years. Ducks are coming in fast, on the swamps and lakes in McPherson Co., 40 miles North of here, and I shall have some fun with them in about 2 weeks. Rabbits have become so numerous in this vicin-

ity they are a nuisance. Two country boys killed 300 in two days, last spring. I suppose this sounds fishy, to Eastern people, but it is a fact. Newton is reached by the A. T. & S. F. Railway.

F. R. Swartz, Newton, Kans.

I have 4 guns, 2 good rods and a lot of sport while travelling. My favorite is hunting gray squirrels, with a 22 calibre Winchester.

I admire your work on the hog shooters, and pot-hunters. Keep it up; nothing is bad enough for them.

Sea trout and blue-fishing is good here, at present, and any number of small fish may be caught, even from the docks.

May some day write you a few little sporting episodes, which I think would prove interesting.

Chas. Cooper, Old Point, Va.

Should be glad to have them.—EDITOR.

The quail law opened in Arkansas October 1st and quails are there by the hundreds. They have never been known so plentiful before. Squirrels are also abundant. It is just 156 miles from here to Tulsa, I. T., where there are plenty of deer and where wild turkeys are found by the hundreds. Sportsmen wanting to visit these points can get rates from Mr. G. T. Nicholas, General Ticket Agent of the St. Louis and San Francisco R. R., at St. Louis. Dogs and tents carried free.

We have some crack shots here and RECREATION is read by almost all of the boys. They all think it is O. K.

Lou Jewett, Monett, Mo.

Rev. Evan P. Hughes, pastor of the First Congregationalist church of Hillsboro, Ore., was arrested for shooting game, out of season, in violation of law. He was arraigned before the justice and convicted. In his defence he pleaded the biblical injunction, "Rise Peter, kill and eat;" but the justice did not recognize that kind of law and fined the minister \$50.

This is tough on the cloth, Brother Hughes, but hereafter you must keep your gun corked up until the legal season opens. Game laws are made for saints, as well as for sinners.

The slaughter of deer has begun, the law having ceased to protect them, from October 1st to November 1st. This seems almost cruel, for the deer have become very tame, in this part of the state. Recently a doe and 2 fawns were seen on the campus of the University, of this place, wandering off at their leisure. On the hills about here deer are often seen, manifesting no fear at the close approach of the farmers.

We have good shooting and fishing, ruffed grouse and squirrels being plentiful.

RECREATION has many friends in this vicinity.

G. E. Dunham, Northfield, Vt.

I am well pleased with your magazine. It is the best sportsmen's and game protective journal in the country, and you seem to be the right man in the right place, to expose the game hogs. We have a good many of them here, but I think they are a little worse than the ordinary game hog. These are the genuine razor backs, who hunt in and out of season; killing everything as they go. They are like the other razor back swine of this country—hard to catch.

H. B. Beidler, Chuluota, Fla.

Here is a new game law that will meet with general approval: Book agents may be killed from October 1 to September 1; game hogs and fish hogs January 1 to December 31; spring poets from March 1 to June 1; scandal mongers, April 1 to December 1; umbrella borrowers, August 1 to November 1, and February 1 to May 1; while every man who accepts a paper 2 years, but when the bill is presented says "I never ordered it," may be killed on sight, without reserve or relief from valuation or appraisal laws, and buried without benefit of clergy.

On the second day after the opening of the season for gray squirrels, C. Hanver, D. Lewis and I started early, for a day with the grays. Mr. Hanver got 14, Mr. Lewis 5 and I 3. I had an old muzzle loader that had to be doctored up after each shot. Still we felt we had more than our share.

Give it to the game hogs.

RECREATION is a lot better than some of the \$3 and \$4 sportsmen's journals, and I read them all.

C. McToms, Foxville, Md.

Woodcock and grouse are fairly plentiful this fall, and many deer have been seen, but the game law protects them, in this county, for 3 years longer. Our legislature, last winter, passed a law requiring every one acting as a guide to answer certain questions, subscribe to rules and to purchase a license of the fish and game commissioners. It created a big fight, and already one trial has been held, but the commissioners won, and are generally upheld throughout the state.

I. T. Monroe, North Livermore, Me.

A Tacoma, Wash., paper says:

"Several parties of Tacomans have been enjoying Chinese pheasant shooting, across

the Oregon line during the past few days. Woodbury, 14 miles this side of Salem, is the favorite hunting ground, and the sport is reported excellent. Everett Griggs and G. W. Crow killed 30 birds; Richard Vaeth and Marshal K. Snell 46 birds, and Percy Sinclair and P. V. Caesar made a large bag."

Oregon is the banner state in the matter of pheasant propagation.

The quail shooting was good here, this season, and a great many birds were left over for next year. I thank you for the good you are doing, for the sportsmen, and wish you could devise some scheme whereby spring shooting could be abolished, from the Gulf to Canada.

Frank G. Shoemaker, Maryville, Mo.

It should be, and will be, some time; but possibly not until the game is all killed off.—EDITOR.

The contracts for a new wagon road, from here up the West Gallatin river, to connect with the Yellowstone National Park road, on the Upper Madison river, have been let by the County Commissioners of Gallatin county, and the road will be open for next year's tourist travel. The scenery is splendid; there are good camping places, and excellent hunting and fishing are to be found along this road. In these respects it far surpasses the route up the Yellowstone river.

August Gottschalck, Bozeman, Mont.

Philip S. P. Randolph, a Philadelphia millionaire and society leader, was arrested at Narragansett Pier, R. I., for shooting woodcock in the closed season.

He pleaded guilty to the charge and paid a fine of \$106.45 and says he is glad the law has been vindicated, even though he was the sufferer. He says he is perfectly willing to refrain from shooting, in close season, if others are required to do the same.

You deserve success and will achieve it. The firms who do not advertise in RECREATION will do so sooner or later; for at the rate the circulation is growing your magazine will become a power they cannot resist.

It is on sale at 4 book stores, here, and a year ago nobody had ever heard of it.

O. A. Pattison, South Bend, Ind.

My friend, B. Long, and I have just returned from a 2 weeks' trip on the Chain lakes, Western Iowa. Ducks and chickens are plenty. We killed in the neighborhood of 200 birds. The fall duck and goose shooting was fine. Snipe shooting was elegant. RECREATION was our best companion, in the evening.

J. J. Schell, Mason City, Ia.

W. B. Bradley, John Askey, Douglas Somerville, William Pollock and Richard Spier, of Lonaconing, Md., claim to have killed 400 squirrels while hunting along Patterson's creek, West Virginia.

These men are now included in RECREATION's herd of game hogs. Let all decent sportsmen shun them.

E. J. Hill and F. Thompson, of Prophetstown, Ill., were caught shooting prairie chickens before the opening of the legal season and were fined \$10 and costs, each. The men had shot 2 chickens, which cost them \$20 each. Next year they won't commence shooting until the law says they may do so.

I notice, page 298, of October RECREATION, Mr. Leavenworth's defence in which he gives us a kind of puzzle that I should like to know how to unravel. He says: "My wife and I did kill 297 squirrels last season, 12 being the most bagged in one day, and it took just 15 hunts to get them." If this is fact how were 298 killed? Fifteen multiplied by 12 makes 180, supposing 12 had been killed each day.

D. G. C. E., Orlando, Fla.

I take every sportsmen's paper I know of, but for realistic stories of gun and rod, and for other intensely interesting narratives of sport, of all kinds, I must say RECREATION takes the cake, bakery and all. It is the duty of every true sportsman to assist you in enlarging your circulation.

John M. Durst, Austin, Tex.

An Alliance, O., correspondent reports quails plentiful in that vicinity, and that rabbits are so numerous as to be a nuisance to the farmers, who would gladly see them exterminated.

We have but little game here; only a few red or pine squirrels, and a very few fox and gray squirrels, some rabbits, and quails.

E. E. Ewing, Wabash, Ind.

I go, every fall, to the Wapsipinicon, a small stream near here, and bag a duck or 2 occasionally, but they are none too plentiful.

J. B. Quimby, Bremer, Ia.

The dove season is on, in this vicinity, and the birds are in large numbers.

W. H. Young, Sacramento, Cal.

I enjoy RECREATION very much. The black duck is about all we find here good to shoot. Ruffed grouse are plentiful, but wild.

E. A. Keene, W. Poland, Me.

Quails were never before so abundant, in Nebraska, and prairie chickens are more numerous than they have been for 3 years.

H. S. C., No. Platte, Neb.

A Pocket Camera, listed at \$1, for 2 subscriptions to RECREATION. Makes a picture 1½x1½ inches. Send for circular.

Have just returned from the woods of Maine, where I saw over 100 deer, 5 moose and 2 caribou.

Dr. J. Seymour Emans, New York City.

A party of 4 of us, and a guide, went out late last fall, and in 3 days got 2 bear and 2 deer.

A. J. Merrill, Jay, N. Y.

Every person who subscribes for RECREATION, or renews his subscription, this year, can get a copy of Mr. W. T. Hornaday's delightful book, "The Man Who Became a Savage," for 50 cents extra. The book sells in the stores at \$1.50; but you can get RECREATION one year and the book for \$1.50.

An Australian Mosquito-Proof Tent for 10, 15 or 25 subscriptions to RECREATION—according to size of tent. Send for circular. This tent is light, compact, waterproof and *insect-proof*.

"When a woman won't, she won't," they say,

Which means that she starts out that way. But, later on, as you will find, She's pretty sure to change her mind.

—Chicago Record.

If you have sent in a club of subscriptions to RECREATION, and have gotten your premium, and if it be satisfactory, please tell all your friends about it and advise them to do likewise.

Is there not a guide; a farmer, or some one else who has done you a good turn, and whom you would like to reward? Then give him a yearly subscription to RECREATION, as a Christmas present.

Please send me the names and addresses of all your friends who are sportsmen, in order that I may send them sample copies of RECREATION.

A Pocket Camera, listed at \$1, for 2 subscriptions to RECREATION. Makes a picture 1½x1½ inches. Send for circular.

## FISH AND FISHING.

### IS THE OUANANICHE A FRAUD?

New York City.

Editor RECREATION: Your correspondent, Dr. French, in the September number of RECREATION, says the Ouananiche is greatly "overrated," because it does not rise to the fly, as the trout does.

All this is true, but still I have found the ouananiche the gamest fighter of any fish I know, for its size. The repeated leaps of a ouananiche excel anything in that line I have ever seen. He excels the bass, or the rainbow trout: for the brook trout seldom leaps after it is hooked. Of course, the ouananiche cannot be compared with the salmon or the muskalonge.

I made my first trip to Lake St. John in August, 1889, when I heard, in Quebec, most marvellous stories of the strength and ferocity of the ouananiche. I then went up the Mistassini, for the fish had left the Grande Décharge, on their spawning trips up the rivers. I camped for a week at the foot of the first fall, and went daily to the foot of the fifth fall, in my canoe: for there were no fish found below. I took many ouananiche, both at the foot of and just above the fifth fall. These fish were mostly large—3 to 4 pounds, several even 5 pounds. They took the fly badly except when deeply sunk, or aided by a bit of "*ouitouche*" (roach). However, for fighters, they left nothing to be desired.

On my second visit, in 1893, and on my third visit, in 1896, I fished only in the Grande Décharge, around and below the Island House, and found the fish numerous but much smaller than up the Mistassini: getting none above 3 pounds, and these mostly trolling in the lake, above the Island House. I took several fine fish just North of Gull island; but all these were on the spoon. The fly was taken only in rapid water. Below the great fall in the Grande Décharge, I took 6 fish out of 8 hooked, 2 at a time, each weighing 2 pounds, trolling with 2 flies.

The Ouananiche I found a delightful fish when hooked, but disappointing and capricious as a taker of the fly—just like the rainbow trout we have in the brackish water of the river into which our brook empties, at the South Side Club, on Long Island.

If anglers who visit Lake St. John would confine their catches to fish weighing 2 pounds and over, and would not bring in baskets of 19 fish weighing 30 pounds, or about 1½ pound each, the ouananiches would have a chance to grow, and the large fish would rapidly increase. I have seen many strings of ouananiche brought in, numbering 50 or more, running from ½ to one pound each.

The grandeur and expanse of the fishing waters about the Island House, together with the rivers emptying into Lake St. John, add greatly to the enjoyment of a trip to that region.

Your correspondent complained of the limited fishing area. I had no such trouble, for everything was free to a guest of the Roberval or Island Hotels, except the waters owned by a Mr. Griffiths, who very kindly offered them to me, in 1893. Mr. Beemer (not Beanwar, as your correspondent has it—perhaps a misprint) as proprietor of the hotels, controls all the other waters. "Scott's" is an old, now disused, camp below the Great Fall. The trip to, and fishing at, Lake St. John are expensive—\$7 a day for guides, canoe, board, etc., as your correspondent states; but I found it paid me to go all the way from New York, which is farther by a few miles than from Quebec, where your correspondent lives.

In conclusion, the ouananiche is not all the railroad and hotel people claim for it, but still it is a grand fish, well worth the trouble and money it costs to get it. This is my opinion after 3 trips to Lake St. John.

Paul F. Munde, M.D.

---

### ABOUT THOSE PERCH.

New Bedford, Mass.

Editor RECREATION: In a recent number of RECREATION I read an article on red and white perch. I don't know who wrote it, as it is not signed, but whoever did write it has much to learn regarding "white perch."

In the first place he says they are a salt-water fish, and that they ascend our coast-wise streams. There never was a white perch known to be caught or even seen in salt water. They are strictly a fresh water fish and descend our coast wise streams into brackish water to feed, preferring shrimp and small herring to any other kind of food. I admit it is commonly understood that the "white perch" is a salt water fish; but how it ever came to be supposed I do not understand.

I reaffirm that there never was one known to be caught or even seen in salt water; and I defy anyone to gainsay it, or to prove the contrary. It is easy to make a statement: but another thing to prove it.

The habits of the white perch, in descending our streams into brackish water, are identical with the habits of our brook trout in that respect. They are often found together, but not always.

Again, the writer in question says that the white perch are easily caught, with any kind of bait; they biting at anything. That is another great error. They are one of the

daintiest of fish; being next to the black bass. In order to catch white perch, you must have for bait something to tempt them, and the thing coming the nearest to always being acceptable is shrimp. It is the red perch that bites anything, and always, and not the white.

Harry M. Church.

I sent Mr. Church's rather vehement criticism to Professor B. W. Evermann, Ichthyologist of the U. S. Fish Commission, who wrote the article on the perch, and who replies as follows:

Mr. Church seems to have read very carelessly the article in September RECREATION concerning the 2 species of perch. He speaks of an article on "red and white perch," evidently having in mind the article on page 178.

Nothing is said about red perch. The white perch and the yellow perch are the only fishes named.

Furthermore it is not stated, or even intimated, that the white perch is a salt-water fish. If Mr. Church uses the same method in observing the habits of fishes that he does in reading, I fear we shall be compelled to ask that his observations be verified, before accepting his conclusions as final.

The white perch seems to be as truly a salt-water fish as is its near relative, the striped bass, or rockfish. Neither is a salt-water fish in the sense that the mackerel is; for each is found, at times, in fresh and brackish waters, as well as in salt-water. It is even landlocked in some fresh-water ponds. Mr. Vinal Edwards, of Woods Holl, who has spent many years collecting the fishes of that region, and studying their habits, says this of the white perch of that vicinity: "Abundant in all the fresh-water ponds which have streams emptying into the salt-water. Spawn in May and June. Seen from one to 10 inches long, in the ponds, but are taken, in October, in Vineyard Sound and Buzzard's Bay. These measure 8 to 10 inches."

These waters are within easy reach of Mr. Church, and if he will call on Mr. Edwards, in October, that gentleman can probably show him some white perch in salt-water.

B. W. Evermann.

#### THE KINGFISHERS CLUB.

Friendship, N. Y.

Editor RECREATION: This Club is duly incorporated, and has a club house one mile South of Dresden, on Seneca lake. The lake is 5 miles wide here, and has a total length of 40 miles. Black bass, perch, pickerel and lake trout, can be had in fair numbers, and of excellent flavor. The water is pure and very cold, and it never freezes in winter. Ducks winter there, after other lakes are frozen, affording good

shooting. We have yet to see a musquito on the grounds, or to experience any uncomfortable temperature. Fruit is plentiful, and cheap, while butter, eggs, milk, etc., can be had at near by farm houses at reasonable prices.

The names of the present members of the Kingfisher Club, are as follows: Hon. C. A. Farnum, president, Wellsville, N. Y.; H. C. Wilcox, vice-president, Friendship, N. Y.; Claude R. Scott, secretary and treasurer, Wellsville; E. W. and Chas. Barnes, Wellsville, Editors of the "Reporter;" Wm. Opp, and Wm. Bellamy, Wellsville; Newell Philips and Riley Allen, Allentown, N. Y.; Elba Reynolds, Belmont, N. Y.

The club house is 4 miles from this village by the Erie and Fall Brook R.R. Grouse and quail shooting, in the vicinity, is reported good.

H. C. Wilcox.

#### SOME ALABAMA RAZOR-BACKS.

Talladega, Alabama.

Dear Coquina: I enclose you clipping from the "Birmingham State Herald," which I trust may arouse your righteous indignation, and that of all other real sportsmen, against the fish hog, of high or low degree. I often fish in the fruitful Florida waters and have had ample opportunity to do as these men confess to having done; but my hands are clean.

One good thing you are doing in RECREATION; and that is, you are not only building up public sentiment against such wanton destruction of our sport; but are bringing the trespassers, themselves, to their senses and making them ashamed of their work.

I read RECREATION, regularly, and only voice the general sentiment in saying it is the cleanest, purest sportsman's journal published. Nothing in American literature can take its place. Long may you live to carry out your own idea of a true sportsmen's magazine.

Wm. E. Henkel,  
Publisher "News-Reporter,"

Talladega, Ala.

The clipping referred to is as follows:

The fishing party consisting of Messrs. B. B. Conner, T. T. Hillman, G. B. McConnell, J. D. Moor, Dr. R. M. Cunningham and M. B. Conner, Jr., of this city, and Hon. S. B. Trapp, of Montgomery, and Alf Truitt, of Anniston, who left for Fort Myers, Fla., on June 2, returned yesterday morning, Messrs. McCormack and Truitt having returned Saturday.

They report splendid success: following is the catch; Hon. S. B. Trapp, tarpon 6; sharks 4; and small fish, aggregating in all, 950 pounds. Mr. B. B. Conner, tarpon, 4; several sharks; small fish, aggregating 900 pounds. Mr. T. T. Hillman, tarpon, 3; several sharks; small fish, aggregating 950 pounds. Dr. R. M. Cunningham, tarpon, 3; sharks, 4; small fish, aggregating 800 pounds. Mr. J. D. Moor, tarpon, 1; several sharks; small fish, aggregating 70 pounds. Mr. G. B. McCormack, tarpon, 1; small fish, aggregating 200 pounds. Mr. Alf Truitt, tarpon, none; sharks and small fish, 500 pounds. M. B. Conner, Jr., small fish, 10 pounds. Total for whole party, 5,100 pounds.



RECREATION will soon have to enlarge its branding corral if the shipments of swine keep coming in at this rate.—EDITOR.

---

IN MARYLAND WATERS.

The present fishing season is said, by the knights of the angle, to be the best Maryland waters have had for several years. As a result of the efforts of the Maryland Game and Fish Protective Association seining and trot-line fishing, for bass, has been broken up, in the Potomac river; and the sportsmen are having good times there, whenever the water is clear enough to fish. Bass are also being caught in large numbers in the Susquehanna river.

In this stream rockfish, or striped bass, are also biting well, the average catch being 40 to 90 to a boat, in a day. The fish run from 4 to 16 pounds. The waters for these fish are above Port Deposit; trolling with eel-tail bait is the popular method. The rockfish are so plentiful on the seining grounds that the fishermen are not making any money, the supply being greater than the demand.

At Kent Island Narrows peeler crabs are used for bait, and rock weighing from 4 to 25 pounds are being caught.

Perch are plentiful at Betterton, just below the Sassafras river, in Kent county. Mr. E. A. Maull reports that 10 fishermen caught 1,500 perch and rock, in 4 days, at Betterton.

Fishing is also good at Fort Carroll, but citizens can only fish there after securing a permit from the United States engineer's office. Perch and rock feed about the fort. The largest rock caught there, this season, weighed 33 pounds.

August and September are the best months for fishing. Persons who have fished at the capes, at the mouth of Chesapeake bay, have had grand sport with big bluefish, trout, drumfish, and occasionally a shark. At slack water sea trout can be caught as fast as the fisherman can handle them.

Shooters predict that there will be great numbers of ducks on the Susquehanna flats this fall. They base their prediction on the fact of there being so great a run of rockfish in the river. They do not attempt to explain the connection between the run of fish and the flight of ducks; but say it always follows that there are plenty of ducks after a big run of fish.

Frederick City (Md.) "News."

---

WISCONSIN NOTES.

John Waite and A. J. Hawes, 2 guides on Pelican lake, secured for the month, for the parties they guided, a total of 63 muskalonge weighing 716 pounds. In addition to this they caught many smaller fish.

C. M. Cleary, of Antigo, and Mr. Todd, of Texas, caught nearly 100 pike in less than half a day.

J. C. Smith and Chas. Roemer, of Clintonville, took about 200 pounds of pike and perch, on Pelican lake.

T. F. Kane, Chicago, caught 100 wall-eyed pike and several pickerel and black bass at Pelican lake.

Robert Karms, C. J. Maes, S. P. Morse and C. Drumm, of Kaukauna, caught 40 pike, 5 pickerel, 6 black bass, one 15 pound and one 12½ pound muskalonge, and 50 perch.

E. P. Reynolds, of Antigo, caught one 12 pound muskalonge, 5 wall-eyed pike and 1 perch.

Chas. Roemer and J. C. Smith, of Clintonville, Wis., caught 44 pike, bass and pickerel.

During a month's stay at Pelican lake, Dr. E. C. Williams and W. H. Sterling, of Chicago, caught 48 muskalonge, averaging about 13 pounds each in weight.

Mr. Harry Burt and H. French, of Rhineland, caught, in the Manitowish waters, in 3 days, 14 muskalonge and 40 pike, all good sized.

On Tuesday July 13, A. Mehlman and Herman Lindner, of Oshkosh, went to Lake Poygan and in a few hours hooked 17 black bass and any number of pike, pickerel and sun fish.

A recent day's catch at Green lake is reported thus:

Bryant of New York, 29 pickerel; Brooks of Chicago, 29 pickerel; G. W. Matthor of Chicago, 50 pickerel; Follensbec, of New Orleans, 19 pickerel, and many small catches were made, of 5 to 15 pickerel.

---

A HOG ATTACKS THE PERCH.

Editor RECREATION: The following was taken from a leading city daily: "Dr. Fred H. Evans of the Chester Board of Health, with 3 lady companions, caught 260 perch, with hooks and lines, in the Delaware river, on Wednesday." In looking over this paper these "fish swine" thus came to my notice, and I cannot content myself until I express my opinion of them in RECREATION.

What a shame to have to allow such men to run at large! They should be branded, and turned in a corral, to root like other hogs. The doctor should have been arrested as soon as he came ashore with his perch. What about our future supply of fish if such hoggishness is allowed to go unpunished. Suppose every angler should go out and catch 200 or 300 perch a day. How long would the supply last?

What are your sentiments on this slaughter, Mr. Editor? Did they not catch 200 too many?

Game Protector, Chester, Pa.

At least that; and if all the Doctor's neighbors should express their condemnation of him, as vigorously as you have expressed yours he would probably be more reasonable in future.—EDITOR.

#### BIG CATCH OF TROUT.

On last Saturday evening I saw the results of 2 days' fishing by Sidney Williams, of Renton. There were 3 fishing baskets of trout which had been caught by him in Cedar river, near Danville, all of which were taken by hook and line, baited with salmon eggs. He and his brother never fish any other way. There were 571 fish, some of them quite large; all suitable for the table. Owing to the success of the 2 brothers, which from time to time has been reported, being so far beyond that of others who have visited this stream, doubts have been expressed, by some, in regard to the truth of the reports. Others have insinuated that such numbers of trout could not be legitimately taken; and that powder or some other explosive was used. Such a charge is unfounded. An eye witness was present, fishing with Sidney all the time, and can testify that these fish were caught as above stated.

Geo. F. Whitworth, in Seattle, Wash., "Times."

It is really wonderful how widely this *Swinus ictus* is distributed. The range of most other animals is limited to some certain zone, or latitude, but the fish hog seems to be everywhere.—EDITOR.

#### NOTES.

The Helena, Mont., "Independent" says the dynamite fiend is abroad in that state, and that nearly all her mountain streams are being depleted of their trout supply. There is a state law prohibiting this infamous practice but the last legislature neglected to make any provision for wardens or for money to enforce it, and so the vandals can simply go on with the work unmolested. I would suggest a vigilance committee, armed with repeating rifles, as a good substitute for the missing game and fish wardens. That's the way Montana formerly dealt with horse thieves, and a horse thief is a gentleman, any day, as compared with a man who will dynamite trout.—EDITOR.

C. F. Taylor and J. S. Sacker have fished in Hazelhurst, Wis., says the Warren "Sentinel" Their smallest catch for any one day was 111 bass, pickerel, pike and perch, and they estimate they caught, in all, between 700 and 800 fish.

And if they were gentlemen they would now be so heartily ashamed of themselves that they would sneak off and drown themselves, in some swill barrel.—EDITOR.

Anglers are considerably excited over the big catch of black bass, made by Jerome E. Emerson and Burt Ferguson, at 4 mile Point last Saturday. In eight hours they landed 91 fine black bass, aggregating 210 pounds. The lucky anglers had a photograph of the fine catch taken yesterday. They placed the fish in three rows, on a barn door, one row consisting of 17 bass, averaging 3½ pounds each, the second of 2½ pound bass and the third of 1½ or under. Lockport, N. Y., "Union."

If this photograph includes their own mugs, as it probably does, they should send a copy of it to the Police Gazette and have it published in conjunction with those of other murderers, thieves, and vandals, of all sorts.—EDITOR.

Judge Cummings, A. L. Mills, Mr. Huston, and Mr. Fred Geddes returned recently from a fishing trip in Michigan. They spent 4 days on the Au Sable river and in that time hooked 735 beauties. Judge Cummings says it was one of the most delightful fishing trips he ever had.

These animals need never take off their coats to show their bristles. Everyone who reads the above will know they are well supplied.—EDITOR.

When I was at King and Bartlett, somebody there told me of 4 men who went out on Spencer stream to see how many trout they could catch in a given time. They caught 1,000 in 18 hours!

My remarks were not suitable for print, excepting the last, which was to the effect that lynch law only was applicable to such a case.

I trust RECREATION will continue in the good work. A welcome awaits the coming of each number.

Howard F. Butler, Boston.

The following catches were made at Camp Sherman, near Three Lakes, Wis., by Miss Clark and William Kearns, of Chicago, June 6 to 13: 93 pickerel, largest, 15 pounds; 13 black bass, largest, 5½ pounds; 37 pike, largest, 6 pounds; 3 muskalonge, largest, 37 pounds, smallest, 13½ pounds. Miss Clark caught the largest muskalonge.

There are 21 lakes here that can be fished without making a portage, and as many more by making short portages; good fishing in all the lakes.

M. Peck, Three Lakes, Wis.

An Indiana man has invented an electric fishing rod which, if he could get sportsmen to use it, would undoubtedly play havoc with the finny tribes. It is so contrived, with conducting wires, that when a fish strikes the hook the pressure of a button, in the hands of the angler, completes the circuit and death instantly follows. The beauty of the whole thing, as the inventor describes it, is that the fish can then be taken from the water without difficulty.—Exchange.

And some one should stick the tip of this rod in the inventor's ear and then press the button.—EDITOR.

What else can you give a man for a Christmas present that will give him so much pleasure, at so small a cost, as a yearly subscription to RECREATION?

In remitting for RECREATION please send P. O. or Ex. Money Order, or New York Draft. Checks on local banks cost me 10 to 20 cents each, for collection.

## GUNS AND AMMUNITION.

### AS TO 22 LONG RIFLE CARTRIDGES.

G. L. LEHLE.

Having noticed several inquiries in RECREATION, concerning the selection of 22 calibre rifles, I believe some account of my experience with these may be of use to the young tyro who wishes to procure the weapon best adapted to his needs.

Experience has taught me that the 22 calibre long rifle cartridge should be used only in single shot rifles, if accurate shooting be required. The shell of this cartridge is not crimped around the bullet, and the bullet extends into the shell only a short distance, so that it is easily withdrawn or displaced. When the shooter who uses the 22 long rifle cartridge in a repeater forgets if there is a cartridge in the chamber of his rifle, and withdraws the bolt in order to dispel doubt, the shell is extracted without the bullet, which remains in the barrel, and the powder is spilled into the action to clog and generally render it useless until cleaned. If the bolt be withdrawn but a short distance the shell is pulled away from the bullet very little but when the action is closed the shell and the bullet do not occupy the same position, with regard to each other, as before, and the result is a wild shot.

Again. The pressure of the magazine spring, and the unavoidable jolting which the cartridge receives in a repeater render it unfit for accurate shooting because the bullet is loosened and displaced in the shell; so that its axis, when it enters the rifling, does not coincide with the axis of the rifle barrel.

These objections to the use of repeating rifles, in connection with the 22 calibre long rifle cartridge, are not founded on theory, but on the results of actual experience with the cartridge, and the 22 calibre Marlin rifle. Much better work may be done with this cartridge if it be used in a good single shot rifle, and the small game hunter loses nothing by discarding the repeater.

Consider, for a moment, the Winchester single shot rifle. If the shooter cannot remember whether a cartridge has been placed in the barrel or not he depresses the lever until the breech block drops down enough to show the chamber without operating the shell extractor. Hence a 22 calibre long rifle cartridge, in the barrel of this rifle [and most other single shot rifles] is not injured by an examination to determine if the rifle is loaded.

The Winchester 22 calibre single shot is light, handy and may be loaded quickly enough for any kind of small game shooting. The lever, after a shot, is depressed; a new cartridge placed in the chamber and

the lever restored. The rifle is now ready for firing. It is not necessary to cock the hammer, or to handle the empty shell with the fingers, because the arm is self cocking and is provided with a spring ejector that throws the empty shell far from the breech. In hunting small game the hunter's life does not depend on his putting 3 or 4 shots into an animal, in as many seconds, and this rifle will be found quick enough to meet all requirements.

The rifle is also very readily cleaned, as a rod may be inserted at the breech end of the barrel without taking apart the action. All 22 calibre rifles should be cleaned from the breech instead of from the muzzle. This is a matter of great importance if the fine shooting qualities are to be retained.

There is one very sensible objection to the use of a single shot rifle, in connection with the 22 calibre long rifle cartridge; but it is easily overcome. The lubricant on this cartridge is exposed and this renders the cartridge unfit for use if carried in a dusty pocket or bag. It should be carried, in the woods, in a carrier made as follows:

Select a sound piece of any wood, which may be easily worked. Cut it in the form of an arc of a circle, to fit your waist, and let it be about 8 inches long, 2 inches wide and 2 inches thick. Bore into the top of it, with a small gimlet, 48 holes, neatly spaced, one inch deep. Now take a piece of iron wire, of same diameter as body of the 22 calibre shell; heat it to a red, and with it burn out each hole. Fasten the little block to a belt and secure it around your waist.

You now have a cartridge carrier which keeps your 22 calibre long rifle cartridges free from knocks, jolts and dirt, and delivers them to you clean and perfect, no matter how much running or jumping you may do.

Some riflemen may smile when reading this, but experience has taught me that this cartridge is delicate, and must not be exposed to knocks, or to dirt, if accurate shooting be desired.

Many cartridges may be carried in a dirty pocket, or bag, jammed into a repeater and discharged with good results. Not so the 22 calibre long rifle, however.

Those who take exception to the preceding may be glad to learn that, in connection with another 22 calibre rim fire cartridge, I can see no objection to the use of a repeating rifle. The cartridge known as the "22 rim fire Winchester" contains a 45 grain bullet and 7 grains of powder. Its bullet is placed well into the shell, so that the lubricant is not exposed. This cartridge has proven very accurate. In fact, it is almost as accurate as the 22 long rifle. Owing to its larger charge of powder

and lead the 22 R. F. Winchester is superior to the 22 long rifle, as a small game killer, and, for this reason, I use it in preference to the latter.

On account of its inside lubrication, and the good hold which its shell has on its bullet, the 22 R. F. Winchester may be carried in bag or pocket with impunity, and fired in the repeater made for it, with excellent results.

---

#### THE NEW SMALL BORE RIFLES.

Editor RECREATION: As all big game hunters are interested in the new smokeless rifles, I will, through RECREATION, give my experience with them.

The first one I used was an 8 m.m. Mannlicher, and the bullets gave uneven results. The lead core, of the soft nosed bullets, seemed too hard. In some instances the bullet would pass through the body of a deer without upsetting, and would have no more effect than a full jacketed ball would. At other times the bullet would go all to pieces as soon as it struck, and, while making a terrible wound, gave but little penetration. I once shot a bull elk, with this rifle, at about 10 yards, aiming at the back bone, and though the shot knocked him down, it failed to break his back. The bullet went all to pieces on striking. Right then I made up my mind I did not want any smokeless small bores in mine when after bear, and nothing I have since learned about them has changed my opinion.

I used the Mannlicher about 18 months and while I found it accurate, at all distances, up to 800 yards, and its flat trajectory a great help in game shooting, yet I do not consider its effect on game equal to that of any of the large calibre sporting rifles using black powder.

Of course, when the bullet upset just right both shock and penetration were ahead of those given by black powder ammunition; but this did not happen with any reasonable degree of regularity.

Last fall I began using another 30, and am not so well satisfied with it as I was with the Mannlicher.

I think the core of the soft nosed bullet, used in the Savage, is altogether too soft. At short range it upsets too much, and the penetration is about what one would expect from a 44-40-200.

It is all right to shoot a deer or antelope in the ribs, and have the ball lodge under the skin on the other side, provided there be plenty of shock and bloodletting; but when you stand in front of a big bear, or try to smash the shoulder of a bull elk, your bullet must not only shock but must go deep and smash everything it hits.

For instance, the other day 4 of my hounds had a big cougar at bay on the ground. I took a shot at the brute, with

my Savage, as the animal was quartering away from me, at about 30 feet distance. The jacket came off the soft nosed bullet, as it struck the cougar in the short ribs, and the core lodged just under the skin, the jacket penetrating into the lungs, butt end foremost. As the result I had but a small fraction of a second in which to stop him, and I do not like to think what would have happened if I had been depending on that first shot to stop a big grizzly, at close quarters.

In my opinion the new rifles are all right for that class of sportsmen who use express rifles, cover their game any way, as they would with a shotgun, and depend on the bullet to so mutilate the animal, no matter where hit, that he cannot escape. But for the man who hunts large and dangerous game, and who depends on quick shooting and on placing his bullet in the right place to bring him out on top, black powder and lead bullets are good enough yet.

I have never used any of the Winchester smokeless rifles, and know nothing of their work but what I have read; but I do not think the right combination has yet been hit, in the new ammunition, for a good big game cartridge. I have found that the Savage powder is seriously affected by cold, 24° below giving a high trajectory and uneven shooting. No doubt the new rifles have great possibilities; but they are not fully developed yet, and a great many of the claims made for them do not stand the test of practice.

Wm. Wells, Meeker, Colo.

---

#### AGAINST THE 30 SMOKELESS.

Pleasantville, N. Y.

Editor RECREATION: I greatly admire RECREATION, and believe its contributors to be all good fellows; yet am moved to utter a jeremiad against their apparent craze for the latest high velocity smokeless powder rifles. The rifles of our daddies were good enough to practically exterminate the game of a continent. What will our sons hunt? Clay birds?

What is the great advantage of shooting a hole clear through a buck, with the prospect of also killing a man in the next county, before the bullet stops? I have played with firearms 20 years, and consider any man who uses a rifle larger than 32 calibre, in a settled country, a dangerous character and a poor marksman. If you must use a Savage rifle, Brethren, take it to the wilderness; and if you chance to pot a stray Indian or trapper, you will at least have a chance to skip out, ahead of the sheriff's posse.

A friend of mine lately bought a Savage rifle, and, calling on me, with his pockets full of long-range cartridges, invited me to try the gun with him, on squirrels. Not

caring to risk an indictment for manslaughter, I declined, and besought him to inform me, in advance, whenever he intended to fire that gun within 3 miles of town, that I might retire to the cellar until the trouble was over.

The man who wants a more deadly arm, in skilled hands, than a Marlin repeater with black powder shells, should contract with the Almighty for a supply of chain lightning.

What many shooters most need is a gun that will hold and aim itself.

I know a man who shot the tail off a fox, and complained that his gun was no good anyway—yet he got all he aimed at. With a Marlin 22, long rifle shells and Lyman sights, I can score 9 kills out of 10 shots at woodchucks, coons or foxes, within 100 yards; and have dropped a chuck stone dead at 180 measured yards. What more can you ask of a gun. The man who isn't smart enough to get within 180 yards of any animal, should quit hunting and turn congressman.

Even the little 22 has a range greatly in excess of that claimed for it. I once shot a crow, through the body, at 75 yards, and the bullet continuing, hit a cow, peacefully grazing, more than 300 yards beyond. I had no idea before, that a cow was so agile and melodious. Didn't stop to inquire how badly she was hurt, but when I reached the tall timber, half a mile away, that cow was still cavorting around the pasture, testifying loudly to the range and penetration of the toy gun.

I never shoot even a 32 without a calculation as to where the bullet would drop if I missed my mark.

The ideal rifle would be one that would throw a ball, with the utmost accuracy, 200 yards and have it stop there. Instead of increasing the range of the modern rifle, inventors would do well to turn their attention to providing us with something worth shooting at with any old gun.

G. A. Mack.

#### LARGE OR SMALL BORES?

Chicago Ill.

Editor RECREATION: The best parts of your magazine are "The Game Fields" and "Guns and Ammunition."

These departments are read with profit by many a city dweller who has vainly sought, elsewhere, to obtain the information which they contain. It is true that game is becoming scarcer every year; and without news from many states who can select new fields when the old grounds are depleted by game hogs, or other vermin?

The sales of the new 30 calibre smokeless powder rifles are constantly increasing in this city. Many of these new rifles are taken by persons of limited experience, into the forests of Wisconsin and Michigan,

where most deer are killed within a range of 150 yards; and I expect to read of many accidents in these states, during the open season, which will be traced directly to the use of 30 calibre rifles.

These new small bore smokeless powder rifles, charged with metal jacketed bullets, are selected by sportsmen because of their light weight, and flat trajectory. When shooting at deer or other large game, within 150 yards, however, the trajectory of a 45 or 50 calibre bullet, propelled by 70 to 120 grains of black or low pressure nitro powder, is flat enough to avoid missing the game, if the sights be held "on;" and the danger of shooting an unseen or unnoticed object, beyond the animal fired at, is much less than if a 30 calibre rifle were used. To illustrate: Suppose that, at a range of 150 yards on level ground, a hunter shoots at a deer, with a 30-30 or a 30-40 modern rifle. Assume that the bullet passes just above the deer's back, describing at first a horizontal line. Now, unless the bullet is stopped by a tree, or some other obstacle, it will, at a distance of 300 yards beyond the deer, be high enough above the ground to mortally wound a man of ordinary size, by passing into his abdomen.

If the deer had been shot at with a 45-90-300 rifle, the bullet would, when 300 yards beyond the deer, be too near the earth to strike a man above the feet.

Again, a small tree will check the flight of the 45 calibre 300 grain bullet; whereas the 30 calibre metal jacketed bullet will pass through a tree of considerable size, even though it have an exposed lead point.

Sportsmen who hunt in a brushy or thickly wooded country, where game is shot within 150 yards, and where an unobstructed view of the country beyond the game cannot be had, would, therefore, do well to select a 45 or 50 calibre express rifle, of the older pattern, in preference to a 30 calibre smokeless.

In a mountainous country, or on the prairies, where an unobstructed view may be had beyond the game, there can be no objection to the use of the 30 calibre rifles.

G. L. Lehle.

#### THAT LONG RANGE SHOT GUN.

Orient Point, Suffolk Co., N. Y.

Editor RECREATION: I admire your model journal as much as ever. The "Guns and Ammunition" portion of it is especially interesting to me. I have been under the impression I knew something about good guns, as I have bought, sold and used them for 40 years. I am acquainted with a number of different makes, and have used most of them. Among these are the Remington, Ithaca, Parker, Richards, Hemmingway, etc. I believe many of your readers will agree with me, fully, when I say these are good guns.

I do not, however, claim that any of them will kill game at 127 yards, with No. 8 shot and  $3\frac{1}{2}$  drams of powder. Mr. Bert Paige, of Antrim, N. H., claims he kills hawks, with a Baker, at that distance, and wishes some one to come and see him do it. I wish very much to be one of the party to visit him and see this wonderful performance. A Baker (or any other 12 gauge gun) that will shoot No. 8 shot hard enough to kill at 127 yards, is a gun I would very much like to own, and I suspect a thousand more of my brother shooters would like to be in it, with me. A gun that is a sure killer at 60 yards (either rabbits or ducks) is a good one. While one that is sure at 25 rods is a marvel. I want that gun! What say you—boys? Don't you?

I contend that a big gun (all things else being equal) will kill farther than a little gun; and it ought to.

D. T. Tuthill.

---

IN FAVOR OF THE MARLIN.

Lima, O.

Editor RECREATION: I have noticed a great deal of correspondence in RECREATION, as to which is the best rifle. I have owned nearly all kinds of repeaters and single shots, both large and small bore; but have never found anything to equal the Marlin repeater. I have a '92 model, 22 calibre, which is as accurate a gun as any man ever shot; and it gives wonderful penetration. I hand you herewith a target I made, and into which I put 7 bullets, at 40 yards, using ordinary open sights, and shooting off hand.

In view of the fact that I had not fired a gun for 2 years, until to-day, I don't believe you will call this wild shooting.

You will notice all the shots are above the centre line which I think shows that the shooting would have been closer had I placed the target at 50 yards, instead of at 40.

I have never done much shooting with the larger calibre Marlin repeaters; but if they are as accurate and as perfectly made as their 22 calibre is, no sportsman need look farther for a gun that will fill all his requirements. Long live RECREATION.

W. F. Packard.

---

EXPLOSIVE BULLETS.

I should like to ask your readers if they ever tried making explosive bullets for a 40-65 (or larger) rifle, by setting a 22 calibre short cartridge in the mould, bullet up, and then pouring the lead around it? When it is cold nothing will show but the butt end of the 22 shell, in the point of the larger slug.

A friend and I have tried this and the bullets work well, at short distance. Being

lightened by the process they have a tendency to fall, and are not so good at long range.

My friend shot a coyote, at 150 yards, with one of these bullets. It hit him in the shoulder, and he looked as though he had been shot with a howitzer.

If any sportsmen have tried other forms of explosive bullets I should be glad to hear from them.

We have as good grouse and goose shooting here as can be had anywhere on the Pacific coast.

If RECREATION should fail to come, one month, I would not be the only mad person in town; "there are others."

Ronimus, Pendleton, Ore.

---

SOFT OR CHILLED SHOT?

The Baker people and some other gun makers advise the use of chilled shot, with smokeless powder, to avoid leading the barrels, and soft shot with black powder. Is this right? If so why are all factory loaded nitro shells put up with soft shot, unless otherwise ordered, if the chilled shot are the better?

F. C. Doane, Knoxville, Pa.

ANSWER.

I referred this letter to Captain J. A. H. Dressel, of the U. M. C. Co., who replies as follows:

We do not think Baker and others, who advise the use of chilled shot on account of leading, are right. Chilled shot is principally used because of being so much harder that it does not become deformed in the loading. Therefore it leaves the gun in perfect shape and makes a more regular pattern. Some people think soft shot has more killing power, as it spreads to a certain extent, on impact, and thus gives more shock, when used on live birds.

Furthermore, we do not believe that the ordinary term "leading" in gun barrels, when applied to shot, is exactly correct. The so-called leading is probably caused by the condensation of the gases in the barrel, which are packed continually by the shot passing through the barrel, and the coating thus becomes hard. There is in reality little if any lead in the matter.

Furthermore, chilled shot, in loaded shells, costs \$2.00 a thousand more than soft. This is one reason why some people prefer to use soft shot. In selling loaded shells, of the lower grades, it certainly would not do for us to use chilled shot, as the price would be entirely too great; and we could not sell them at the regular price, without doing so at a greater loss than we are now incurring.

---

What else can you give a man for a Christmas present that will give him so much pleasure, at so small a cost, as a yearly subscription to RECREATION?

## NOTES.

Will you kindly tell me whether, in cleaning rifle cartridges that have been used, it will spoil them, for reloading, to boil them? Will it anneal them?

RECREATION is the best sportsmen's journal I ever read, or heard of. Every man, woman or child, who has any love for sport should read RECREATION.

Thos. Trebilcock, Houghton, Mich.

## ANSWER.

It would not injure rifle shells to boil them; but that is not at all necessary. Simply place them in cold water, soon after firing, and let them lie half an hour. Then clean with a brush and wipe them dry, and they will be all right.—EDITOR.

I noticed in RECREATION the inquiry of J. M. M., Beloit, Wis., about the 25-20 rifle. I have used one and find it large enough for any kind of small game. I first owned a 25-20 Marlin; but now have a Winchester of same calibre; 34 inch barrel, set triggers, and Lyman combination rear and globe front sight; weight  $9\frac{3}{4}$  pounds.

A truer shooting gun I never saw. There are others just as good, but I flatter myself that I have one of the best rifles the Winchester people ever made. It was made to special order and if J. M. M. ever comes here I should be glad to have him call and examine it.

Jno. J. Schell, Mason City, Ia.

I wish some of your readers would give me some information, through RECREATION, about nitro powder loads for shot guns, in field use; also as to best charge of nitro powder for duck shooting. I have been using 44 grains nitro, in a Forehand hammerless gun (32 inch barrels, and both full choked), and find that all birds shot inside of 30 yards are almost invariably ruined for food. What charge will do effective work in the field?

J. S. Estill, Savannah, Ga.

I have been shooting a 30-30 Winchester smokeless, this season, and am thoroughly converted to the small bore for future use. I have shot 6 bucks, so far, and not one ran 30 yards. Three fell dead in their tracks. The soft pointed bullet makes a terrible wound. Also the gun will carry 250 yards and hit a deer without elevation.

A. G. Allen, Ontario, Cal.

I would like to ask some of the readers of RECREATION what they fill their rifle shells up with, when using short range loads. Would like to load my 32-40 Marlin shells with 10 grain bullet and 15 or 20 grains of powder.

Hoffman Livingston, Galatin, Kans.

Will some of you rifle cranks please tell me what kind and calibre I want for all around use, at target and for rabbits, squirrels, and large game.

RECREATION is ahead of them all.

L. E. Morris, Bethlehem, Ia.

Will some of the shooters who have used either a 12 or a 16 gauge Ithaca shot gun, let me know, through RECREATION, how they like them.

E. R. Wilson, Cannon Falls, Minn.

## TO COQUINA.

W. H. NELSON.

Dear friend: the spirits of the woods  
Are calling unto thee,  
And Autumn has a thousand wiles  
To lure thee to be free.  
The mountains breathe through every cleft  
Their invitation strong,  
And every sparkling lake and stream  
Breaks into liquid song.

Thy rifle, rusting in its rack,  
Stirs through its twisted heart;  
The trigger "creeps" to feel again  
Thy finger do its part.  
Thy rod, wrapped in its mildewed case,  
Sighs for the winding streams;  
Thy birchen boat turns in its sleep  
And yawns in blissful dreams.

And I, thy friend, while Autumn tunes  
Her thousand-stranded lyre,  
Long for thine ear to drink the song  
Beside my hunter's fire.  
Here while the silent mountains sleep  
And stars keep watch and ward,  
To share the blanket, and the cup,  
And "briar" of the bard.

And thou art here. When twilight falls  
And by my fire I lie,  
Thou art beside me, and I gaze  
Down straight into thine eyes,  
My soul wide open throws her door,  
And in thy voice I hear  
The sigh of winds and lapse of waves  
By some wild Western mere.

Accept a hunter's grateful thanks  
For joy that thou hast brought,  
An hundred thousand other hearts  
Echo the self-same thought.  
The minstrel's harp is worn and frail,  
And frayed its feeble strings,  
And yet he dares to hope that thou  
Wilt hear the song he sings.

## NATURAL HISTORY.

### THREE LARGE SHELLS.

C. M. DRAKE.

No more delightful recreation than shell hunting can be found for those who love to wander along the sea shore. Shells are the admiration of the savage and the learned, and one can learn something new of them every day.

Let us go down to the water of Puget sound, at low tide; and fortunately the best tides come here, in summer, in the daytime. Owing to the peculiar shape of the sound the tides fall nearly 20 feet, in places, but a fourth less than that near Tacoma, the head of deep sea navigation.

Puget sound is one of the most wonderful inland seas in the world. It has more than a thousand miles of coast, many beautiful islands and sheltered bays, and surrounding hills covered with magnificent fir trees. Last, but not least, for the pleasure hunter, there is scarcely a rod of the shore on which some shells cannot be found.

Perhaps the most valuable of these are the clams, which are abundant, in places, and of fine flavor. You can find them of all sizes, from the almost microscopic up to huge fellows weighing many pounds. The most curious of these is what is known as the goeduck (*Glycimeris generosa*) which is buried one to 2 feet in the ground.

Far down in his sandy bed the goeduck (not geoduck, as Webster has it) rests secure from all enemies except man. His long neck contains two siphonal tubes, one to take in his food, from the water, and one to spout out what he rejects. Unlike nearly all other clams his shell does not begin to cover his body, and, in the place of the foot with which most clams dig, there is a hole through which water can be forced to enable the goeduck to sink.

From the neck around the front to the hinge is a strip of tender meat, sometimes 2 pounds in weight, which can be cooked like beefsteak. It is delicious eating, though quite sweet and a little bitter, as its name, *Glycimeris*, signifies. But, indeed, after you clean out the large stomach, all the meat of the goeduck is eatable, even the rather tough neck making good chowder.

The shells are handsome, the inside looking like porcelain.

Almost as big as the goeduck is the great Washington clam (*Schisothaerus Nuttallii*), which, like the goeduck, thrusts a long neck up through a hole in the sand. Their shells are the largest and heaviest of any mollusk here, often weighing one or 2 pounds.

They do not burrow as deep as the goeduck, seldom going beyond a foot deep, and the Siwash Indian women dig them

out by the hundreds, with sharp sticks. The Indians eat only the gills and mantle.

Our common commercial clams are carpet shells (*Tapes staminea*) and several species of *Saxidomus* (rock-house). These clams are dug by the ton, mostly for local markets, though many are exported. Some of the carpet shells are quite handsome, being curiously marked, on their white shells, with patches of brown.

Larger around even than the great Washington clam is a member of the Pecten family which is called the large fan-shell (*Amusium caurinum*); but this big fellow is not so thick as the others, being quite flat though almost a foot across, in the very largest specimens.

The Pectens are very pretty shells—almost the prettiest on our coast; and this big member of the family is handsome, too, though not so pretty as the smaller fan shell (*Pecten hastatus*) found here.

Their common family name is scallop and all the scallops are edible. Generally, only the large muscle, which pulls the shells together, is eaten; but the whole of this giant is good eating, of course excepting the shells. Unlike most bivalves, the Pectens are good swimmers, and dart through the water, or leap from the ground, by opening and shutting their shells.

While young they weave themselves fast to sticks, stones, or old shells, with coarse threads called a byssus. This shell lives in 20 or 30 feet of water, and prefers the upper edge of a steep bank, so it can jump into still deeper water when danger comes.

Although quite flat, the shells are strengthened by a score of strong ribs and are not easily broken, except on their knife-like edges.

Barnacles often grow on the upper valve, as they also do on what we may call the nose of the great Washington clam. The shells of the large fan, and of the goeduck, are not common, and even here they sell for 25 to 50 cents a pair.

### THE BUFFALO-HEAD QUESTION.

Evidently my note of protest against judging buffalo heads by their horns alone has roused the ire of the owner of the sheared head shown on the cover of RECREATION for May. Mr. Sheard says that head "has extremely long hair!" Will the reader please refer to the picture, and thus get the correct measure of Mr. Sheard as a judge of hair. For my part, I am amazed at the man's audacity in making such a statement.

Instead of meeting argument with argument, he beclouds the real issue by throwing a shower of mud at my "bad-lands



bull;" which is all right, and no offence whatever. The bull can stand it if Mr. Sheard can.

Nevertheless, is it not strange that during all these 10 years our "eminent naturalists" and equally "eminent taxidermists" could have been dancing a continuous waltz on the reputation of that old bull, and no word of it should have reached me until now? Yet, if Mr. Sheard tells the truth, that is exactly the case; and it is very sad.

I have lived along in the belief that after having studied that particular animal, and sketched his outline as he stood wounded and at bay; after having killed him, and made 2 elaborate series of measurements of his dead body (one before skinning and the other after), and that having mounted him, at my leisure, according to those measurements, even the most jealous of my rivals would allow me to know something about him. If there are any naturalists or taxidermists, eminent or otherwise, who really believe they know more about the form and size of that animal than I did when I mounted him, I can only accept this as proof that the fools are not all dead, even yet.

The statement that this animal "has excited as much hostile criticism as any specimen in the National Museum" deserves to be classed in the same category as Mr. Sheard's declaration regarding that "extremely long hair."

If things are as my Western friend says they are, it is a great pity the truth has not been published in time to stop the reproduction of the numerous portraits of that bull that have appeared in scientific books and periodicals, since 1887. Evidently some good men have been deceived. J. Carter Beard, Ernest Seton Thompson and Miss Palmer have used him as a model. So have other artists. Sir William Flower, Director of the British Museum of Natural History, and Dr. Lydecker published his portrait in their "Mammalia, Living and Extinct" (page 363). This same portrait has been published in "Nature;" and Dr. Shufeldt reproduced it, with strong expressions of approval and admiration, in "Scientific Taxidermy" (page 422).

Mr. Sheard asks me to "make it an object" for him to show a picture of a finer head than that of the mud-covered bull in the National Museum. Money bets, on natural history questions are, so far as I know, never decided, and are merely a form of bluff of which the public has grown weary. If the exponent of sheared buffalo heads does not find the honor of owning a finer head than any in the United States National Museum a sufficient "object" to repay him for mailing a photograph to RECREATION, he will have to go objectless, so far as I am concerned.

William T. Hornaday.

## WINTER BIRDS IN A BIG CITY.

JOHN BOYD.

In this city of Toronto, with over 200,000 people, we have not the advantages of studying nature as we would wish; yet there occur many opportunities of learning the ways of our feathered friends, and not the least of these chances come in winter.

The period between December 1st and March 15th is generally looked upon as the ornithological holiday; but we, in Canada, regard it as the season when we find the rarest of our birds. I say our birds, for at that time those we come across are Canadian in the truest sense of the word, being born and raised to maturity within the confines of the Dominion, and few of them ever venture so far South as Ontario.

The winter of 1896-1897 was not productive of many surprises to the collector or student of ornithology; yet it furnished many interesting studies of the birds that live here, or that pay us a visit, from their far off Northern homes. I will jot down, from my field note book, some items about birds that came under my observation.

Snow Buntings (*Plectrophenax nivalis*), were fairly numerous on Toronto Island, as well as North and West of the city. There seemed to be in each flock an unusual number of specimens which were abnormally large and in the most splendid plumage.

Horned Lark (*Otocoris alpestris*). The familiar shore larks are everywhere. There were hundreds in every field and by the roadside, on the frozen bay and in the streets. Their pleasant voices do much to enliven a walk when the temperature is hovering around the zero mark.

Redpoll (*Acanthis linaria*) are the ever active little fellows we look for among the dried and frozen weeds, picking out their scanty fare; but just as often do we find them on the higher trees calling to each other in a way that much resembles the notes of American goldfinch.

Evening Grosbeak (*Coccothraustes vespertina*). A specimen is reported to have been taken from near Weston, about 5 miles from Toronto, but I am not able to vouch for the accuracy of the report. The bird is rare in this locality, and very erratic in its visits.

Bohemian waxwing (*Ampelis garrulus*) are not so numerous as last winter, but a number have been seen throughout the city.

Pine Grosbeak (*Pinicola enucleator*) like the former, has not been plentiful; still in the Northern and Western suburbs they have been seen. They are a robust, sociable gregarious family.

Northern Shrike (*Lanius borealis*). I secured one of these in the act of devouring a shore lark. They are not numerous, dur-

ing the winter, and it is well for the smaller birds that such is the case, for enough perish through this butcher's rapaciousness. If they would confine their attacks and slaughter to thinning out the number of *Passer domesticus*, we would be inclined to protect *lanius* from the small boy with a gun.

Black capped chickadee (*Parus atricapillus*) is a hardy little fellow who is equally at home in the city orchard as in the deep woods. He is a general favorite, and his work for the fruit grower is of incalculable value.

Hairy woodpecker (*Dryobates villosus*) is often found inside the city limits; and while not plentiful they are not by any means rare to the student of winter ornithology.

American goldfinch (*Spinus tristis*) may be considered a resident here; for although the greater number migrate, we find some of them frequenting the sheltered groves and hollows, around the outskirts, where they appear to brave the cold, with but little if any hardship.

This is not a varied list of midwinter residents, but, considering the crowded city, and the densely settled country adjoining it, we think we are favored in having even these to cheer us when the woods are still and everything is under a mantle of snow and ice.

We are looking forward to the time when the lengthening days and the warmer sun will start the migrations North, that we may watch our feathered friends winging their way through storms and fogs, with an irresistible desire to reach the place where a year previous they were perhaps hatched and reared.

It is a question hardly explainable, as to why these birds should leave a land of abundant fare, in the South, to move to a place, which they, in a few short months, must again quit; thus exposing themselves twice to a fatiguing journey of thousands of miles. They have done it from the creation of the world, and no doubt the change becomes a matter of necessity.

We admire the courage that prompts such an undertaking, and would respect it still more if we only knew why the change was necessary; but as to this we are in the dark. All the reasons advanced, so far, are pure conjecture, and it remains for the new school of scientists to clear up what is at present in doubt on the subject of migrations.

#### IN DEFENCE OF THE BLACK BEAR.

Dr. W. A. Croffut, of Washington, has entered a protest, with the Interior Department, against the suggestion of Superintendent Young that the black bear in the park be diminished in number by being captured and given to museums. Dr. Croffut says:

"A good many will think Colonel Young's report premature. But black bear are by no means numerous in the park. One may wander all over it, for a fortnight, and not see a bear. In the immediate vicinity of the hotels, and permanent camps, these half-tame wild beasts make frequent appearances, and their playful antics and gambols are the delight of tourists. If a vote were taken of those most interested it would certainly be in favor of increasing, rather than diminishing, the number of bears. Unless their cubs are injured they will run from anybody who faces them, and women, and even children, have been known to capture a cub and carry it away from its mother, without serious resistance. An old trapper told me he had never known a bear in the park to injure a human being unless first wounded by him. A black bear will run from any kind of dog, and is just about as harmless as a cow. The bear in the Yellowstone rival the geysers and the canyons, as entertainment for the tourist, and I would as soon think of filling up Morning Glory Spring as allowing these good-natured and playful creatures to be carried away."

#### A BIG MOOSE-HEAD.

I killed a moose in New Brunswick that is said to be the largest ever killed in that province. It is certainly the largest I have any record of; but I should be pleased to hear from any of your readers who may know of one comparing with it. Here are some of the dimensions: He weighed 1,500 pounds and as he lay dead he measured 11 feet long. That is the only measurement I made then, but since the head was mounted it shows the following: a girth of neck, at shield, of 5 feet; length from shield to end of nose 4 feet; neck girth, in smallest place, 4 feet. The bell is 14 inches long, and is a split or double bell. Girth of head 4 feet 5 inches; width between the eyes 10 inches; circumference of horn, close to head, 11¾ inches, and 9¾ inches 2 inches from the head; spread of antlers 4 feet 6 inches. They have 39 points, 19 on one side and 20 on the other.

I am sorry I have not the width of the web, but it is very wide. Neither can I give length of antler. The head is symmetrical, and the antlers very large, extending back over the neck with a long, graceful sweep.

The head was confiscated by the New Brunswick government and hangs in the crown land department, at Fredericton, where it can be seen and these measurements verified.

Can anyone beat it? I have tried in vain to get the head.

Harry M. Church, New Bedford, Mass.

## AS TO GROUSE AND QUAILS.

Please tell me the difference between pheasants, ruffed grouse and partridges.

E. M. Loeffler, Keokuk, Iowa.

## ANSWER.

The only one of the 3 birds you name, that is a native of this country, is the ruffed grouse. This is called, in various localities, pheasant and partridge; but both are erroneous. We have no native pheasants or partridges in this country. Some English, Mongolian and Chinese pheasants have been introduced and are being extensively bred. In most cases they are confined to game preserves or private lands; but in a few cases they have been turned out, as in the Willamette Valley, Oregon. In October RECREATION you will see a picture of 2 men, each of whom is holding a bunch of these birds that have been killed.

The quail or bob white is also called a partridge, in the South; but this appellation is wrong. The partridge is an English bird which, in size, is between our quail and our prairie chicken, and is darker colored than either.

A correct drawing of the ruffed grouse appears on page 188 of September RECREATION.—EDITOR.

## NOTES.

Referring to measurements of game, as quoted in RECREATION, I give dimensions of a grizzly bear we killed in the Wind river country, in 1891. Length from tip of nose to tip of tail, 9 feet 8 inches.

Breadth between ears 16 inches.

Around forearm 24 inches.

These figures are from memory. I have lost the record of exact measurements but the figures are impressed indelibly, on my memory. We estimated his weight at 1,000 pounds, comparing him with the biggest horse in the outfit, which weighed 1,200.

An old trapper (B. Baker), who lived in that vicinity, said this was the largest bear he ever saw.

I have the hide mounted, here in Denver.

D. L. Mechling, Denver, Colo.

In June RECREATION Mr. E. S. Thompson asks if any reader of your magazine has ever observed the habit the wolf has of rolling in carrion. I have never had the pleasure, or displeasure, of seeing a wolf do this, but I have often seen a hound, belonging to a friend of mine, perform himself in this way.

It was about 2 years ago that I first noticed him smelling of a dead horse that lay near the edge of a bit of woods.

The dog did not eat any of the decayed flesh, but satisfied himself by rubbing both sides of his body wherever the flesh of the horse seemed the most decayed.

The second time I noticed it, the hound rolled in carrion of the worst kind. That is, the remains of a dog, as nearly as I could make out, that had been dead for some time.

P. G., Chicago.

As the question, "why do dogs roll in carrion" is up, I will give what I believe to be the reason.

A year ago last spring I took up a stray dog which I thought looked like a good one, and he has proven such, though no one else seemed to think him worth feeding. He was very thin; had mange and was covered with lice. In fact he was a regular tramp.

This dog would roll in carrion, at every opportunity, and I believe he did it for no other reason than to rid himself of lice. Since getting rid of those pests he has quit the habit all together.

O. B. Johnson, Orion, Ill.

I had the rare good fortune to get bitten by a rattlesnake, some weeks ago, and feel the effects of it yet. I say good fortune; but between you and me, I would not have a similar experience for a good round sum, again. All the same, I am glad it happened. You see, I have kept rattlesnakes, as pets, for years; have bred them, handled them, and can do almost anything with them. It was entirely due to my own carelessness that I was bitten, and the snake that did it is now my favorite pet.

I have some individuals which have been in my possession many years. Am afraid you will think me a crank, but I like to take up the less usual, without in any degree losing interest in natural history, at large.

Percy Selous, Greenville, Mich.

Where can I get some ideas on how to mount birds? What is the best for a beginner?

F. D. Levens, Fort Edward, N. Y.

## ANSWER.

The best book ever published, on this subject, is "Taxidermy and Zoological Collecting," by Wm. T. Hornaday. You will find an ad of this book on page xxxi of October RECREATION. It is published by Chas. Scribner's Sons, 153 Fifth Avenue, New York City. Price \$2.50.—EDITOR.

Please send me the names and addresses of all the sportsmen of your acquaintance, in order that I may send them sample copies of RECREATION.

"I see you have had your last winter's sealskin made over."

"Yes. It cost more than a new one, you know."—Cleveland Plain Dealer.

SUBSCRIPTION RECEIPTS FOR 2  
YEARS AND 10 MONTHS.

Read the deadly parallel columns:

|                 | 1895.   | 1896.    | 1897.          |
|-----------------|---------|----------|----------------|
| January .....   | \$379   | \$723    | <b>\$2,146</b> |
| February .....  | 256     | 693      | <b>2,127</b>   |
| March.....      | 300     | 1,049    | <b>2,215</b>   |
| April.....      | 342     | 645      | <b>1,921</b>   |
| May.....        | 292     | 902      | <b>1,596</b>   |
| June .....      | 507     | 770      | <b>1,402</b>   |
| July.....       | 345     | 563      | <b>1,101</b>   |
| August.....     | 306     | 601      | <b>1,906</b>   |
| September ..... | 498     | 951      | <b>2,223</b>   |
| October .....   | 438     | 969      | <b>2,586</b>   |
| November .....  | 586     | 1,054    |                |
| December .....  | 652     | 1,853    |                |
|                 | <hr/>   | <hr/>    | <hr/>          |
|                 | \$4,671 | \$10,773 |                |

Some of my readers will remember that in November RECREATION I predicted the month of October would yield 2,700 subscriptions. It did not do so. However, it came within 114 of it; and the showing is a good one as compared with the corresponding months in '95 and '96.

PHOTOGRAPHS OF LIVE BIRDS AND  
ANIMALS.

Mr. W. E. Carlin, who has been photographing and collecting natural history specimens for RECREATION, in Idaho and Montana, during the past summer, has lately returned to New York and has brought with him about 400 negatives of living wild animals, birds, reptiles, insects, plants, etc., many of which are among the finest ever made. Mr. W. H. Wright, of Spokane, Wash., has been with Mr. Carlin, all summer, and has rendered him material and valuable aid in this work.

These photos will be published in future issues of RECREATION, as fast as room can be found for them, with notes relating to the manner in which each picture was made. These articles will bear the general title of "Hunting with a Camera."

Probably no man has ever done a more thorough and systematic piece of work in this line than this of Mr. Carlin's. Though surrounded by big game and game birds, all summer, he tells me he fired but one shot during the entire season, and that at an elk which his party needed for meat.

Mr. Carlin is an enthusiastic sportsman and an expert rifleman, and every man who has ever been in a big game country can appreciate the devotion he must have felt for his art, when he could deny himself the privilege of killing game, for the higher purpose of photographing and studying it, alive.

Mr. Carlin's work is of untold value to science and will prove deeply interesting to every sportsman and every lover of nature. The first instalment of his new stock of pictures is published in this issue. They treat of the mountain chipmunk.

This little animal was pursued and caught, in the various positions and poses shown here, at the cost of untold patience and days of valuable time. In many other instances Mr. Carlin spent several days in order to get just such pictures as he wanted, of a single small animal or bird. There is a rare treat in store for the readers of RECREATION, during the coming year.

THE LEAGUE IS A CERTAINTY.

As will be seen by correspondence published on pages 465, 6, 7, 8, of this issue of RECREATION, Mr. Lydecker's suggestion for a League of American Sportsmen has met with general and hearty approval. There has long been urgent need for such an organization as is now proposed, and several efforts have been made in this direction. None of these has, however, been as successful as it should have been. This is mainly due to the fact that sportsmen in general have not heretofore been ready for them; but the time is now ripe for action. The game hogs and the fish hogs have done their dirty work so effectually, and have flaunted it in the faces of sportsmen so persistently, that every decent man in the country is now ready to call a halt on them.

Many good men have heretofore rested secure in the hope that the game and fish would outlast the work of the butchers; but all such have been awakened, within the last year or 2, to the fact that this warfare cannot be longer endured, and that the fish and game will be practically extinct, everywhere, within a few years, unless drastic measures are taken, at once, to protect them. It is now time for all decent sportsmen to combine and to work, day and night, for the protection of fish and game and for the extinction of the hogs.

A League of American Sportsmen is a foregone conclusion. A call will be published in January RECREATION, for a convention to meet in this city, to organize this movement; to adopt a constitution and by-laws; to elect officers and to plan a campaign, not only for '98, but for all time to come. Due notice will be given of the exact time and place of the meeting; and it is earnestly hoped that every friend of game protection, who can possibly reach New York at that time, will be present.

In January RECREATION Mr. W. F. J. McCormick tells a most delightful story of canoeing and ouananiche fishing, on the upper Mastassini river, in Canada; Profess-

or B. W. Evermann, of the U. S. Fish Commission, writes entertainingly of a trip to the wonderful Crater lake, in Oregon; Mr. Ernest Seton Thompson, the eminent artist-naturalist, tells a most amusing bear story; Mr. W. T. Hornaday, Director of the New York Zoological Park, contributes a beautiful poem on the mountain sheep; Mr. Carlin writes of hunting with a camera, and many other able writers tell good stories. The January number will be unusually rich in pictures, and in its various departments. This is a good time to send in your subscription, and that of your best friend, in order to begin with the new year.

---

RECREATION now has over 25,000 actual paid subscribers. If each one of these should induce one friend to subscribe, this would give it over 50,000 subscribers. The American News Co. is handling 13,000 copies a month. If each man who buys RECREATION, at a news stand, would induce a friend to buy a copy, each month, this would give me a news trade of 26,000 copies a month.

RECREATION is a great power for game and fish protection. Think how much greater its influence would be if its circulation were doubled. How many men will do their part, toward this work, within the next 60 days? Will you be one of them?

---

Nearly 500 grizzlies have been killed in—September number of RECREATION. The names of the hunters who put the 3 shots in the right places, according to the diagram on file in this office, will be published in January RECREATION, together with another picture of the bear, showing where these shots were placed.

---

All persons are warned against paying money to Geo. Roessler, who has been canvassing for subscriptions to RECREATION, in Buffalo, Niagara Falls, Troy and other points in this State. He is a swindler and is not authorized to take subscriptions for RECREATION, anywhere.

---

With this issue my circulation reaches the 50,000 mark. Now I start out for the 100,000. I shall have it by December '98. Make a note of this and see if this prediction proves correct.

---

**I am now offering** a \$750 upright piano for 200 yearly subscriptions to RECREATION, at \$1 each. Here is an excellent opportunity for some energetic woman to get a high grade piano for a few days' work. In any city of 5,000 inhabitants, or more, a club of this size can be enrolled in a week. Write for particulars.

## PUBLISHER'S DEPARTMENT.

The Eastman Kodak Co., Rochester, N. Y., has issued a book entitled "Kodak Works" which contains 25 full page cuts, illustrating the Eastman factory and the branch stores. This book contains a lot of valuable information and food for reflection. Nothing ever before published has shown, in a more forcible way, the great hold which amateur photography has on the American people. Here are millions of dollars of capital and thousands of people employed, in one institution, to manufacture cameras and photographic materials, nearly all of the output being used by amateurs. Yet this is only one of a dozen large concerns, in this country, whose product is absorbed by this class of people.

A prominent business man asked me, a year ago, if I did not think the taste for amateur photography was declining. If he or any other thinking man will examine this new book of Eastman's, he will not, for a moment, entertain such an idea. Amateur photography never had so strong a hold on the people as now, and it is growing as the days and years multiply. The art is yet in its infancy and the time will come when thousands of people will practise it, where now only dozens do so.

## HANDSOME AND MAGNIFICENT.

"The Black Diamond Express" of the Lehigh Valley Railroad—rightly termed "The handsomest train in the world," has been reproduced in miniature, in the shape of a toy train which is an exact fac simile, so far as outward appearance is concerned, of the famous Black Diamond Express, operated between New York, Philadelphia and Buffalo. It is 5½ feet long, weighs 20 pounds, and consists of engine, tender and cars, representing the cafe, library and parlor cars of this magnificent moving palace. This ingenious and unique toy is on sale at the principal hardware stores, along the Lehigh Valley, whose addresses may be obtained by communicating with Chas. S. Lee, G. P. A. L. V. R. R., Philadelphia, Pa.

---

The Union Metallic Cartridge Co. advises me that the notice of its book of the game laws, published in October RECREATION has brought such an avalanche of orders for the book that the first edition is already exhausted. Another edition is in press which will be out within a few weeks, when all pending orders will be promptly filled.

---

Friends of RECREATION will render valuable aid to this magazine by buying goods advertised therein, in preference to those that are not.

## BICYCLING.

### THE BEST BICYCLE.

Long Island City.

I am not selling, praising or criticising any bicycle. I have simply an idea that after 6 years experience as a rider and having owned 3 different mounts I can at last conglomerate a strong, durable and perfect bicycle, for touring and general riding.

My first wheel was a Crescent; my second a Syracuse and my third a '96, 26 inch, truss frame Fowler. In my judgment there is no "best" wheel on the market; so I will take parts of several wheels and construct my perfect bicycle. All the bicycles from which I take parts are good.

Now to the building. I take my '96 roadster, 26 inch Fowler, with an 11 inch steering-head, the crank hanger having about a 1 inch drop, the lines of which are good and the rake of the fork as yet unsurpassed. Instead of the present crank hanger I have brazed in its place a '96 Columbia crank hanger and shafts. The reason for this change is that the Columbia does not have the troublesome cotter pins.

In the place of my present fork I substitute, on the same lines and rake, a '97 Lyndhurst fork, which extends to the top of the steering-head. This adds safety and strength to what I believe to be the vital point on a bicycle; but instead of the Lyndhurst fork crown I use one on the arch principle, as at present employed in the '97 Fowler and Remington.

Next come the wheels. I believe the present number of spokes employed, 32 front and 36 rear, too small and so would use, as I had on my Syracuse, 40 front and rear. I never had, in 2 seasons riding, one of these spokes snap or become loose or get out of true. I next add Fowler sprockets, '97 Columbia chain, and gear case.

You can use whatever tire you like best. I use Volt tires, made in New Brunswick, and have never yet had a puncture. Their diameter is  $1\frac{5}{8}$  inches.

Each rider must satisfy himself as to the best saddle. Record pedals, '96 pattern, are my choice. Use metal handle bars, with not more than  $4\frac{1}{2}$  inches drop, and as wide as your shoulders, so as to permit the arms to be parallel, in riding, which will prevent your becoming round-shouldered and will enable you to keep your chest inflated.

The grips, on the bars, should be bisected by the steering head.

Have your saddle on a level with the handle bars; the peak of the saddle to be on a perpendicular line through the middle of the crank axle, to the floor. The peak of my saddle is 14 inches from the handle bars.

Such is my idea of the "best wheel," and I will gladly answer any inquiries.

Let us hear from others and thus we may be able to get at what constitutes a perfect bicycle.

Harry S. New.

P.S. Received RECREATION (October) to-day and it is something great.

H. S. N.

### THE CHAINLESS BICYCLE.

ORRIN D. BARTLETT.

The coming of the chainless wheel is the topic of the day, in cycling circles. Whether the change in driving mechanism will be successful remains to be seen, after the numerous models shall have been thoroughly tested by many riders. It is to be hoped the bevel gear can be constructed and applied to wheels, in a satisfactory manner; for if so it would have many advantages over the chain.

Chief among these would be cleanliness. The machine would look neater and the danger from catching the clothing in sprockets or chain would be entirely obviated. I have seen 2 accidents, from this cause, within the past week.

We must await, patiently, the result of the tests which are to be made, before growing enthusiastic on the proposed change, for there are many difficulties to overcome, and the bevel gear may never be generally used on bicycles.

In all former attempts it has been found that no bicycle frame could be built stiff enough to hold the gear teeth in perfect alignment. A bevel gear, no matter where applied, must be firmly secured, in a perfectly rigid frame, else the gear teeth will not mesh properly. Any lack in this direction would cause undue friction and the teeth would break off. This would, of course, ruin the gear. Repairs in such a case, of a temporary nature, would be impossible. New teeth could not be put in, even by the best machinist, to say nothing of the average repair man whom you run across in the rural districts, and who usually knows about as much of fine mechanics as a school boy does.

An entirely new sprocket would be necessary and you would probably be compelled to walk home. Another serious drawback would be the difficulty in adjusting the gear, after having had the rear wheel off to mend the tire, or for cleaning. Even a difference of  $\frac{1}{16}$  of an inch, in the set of the cogs, would make the gear run badly.

It is also impossible to take up the slack, or wear, on a bevel gear. There is absolutely no way of remedying wear except to

put in a new set of cog wheels as soon as the old ones become even slightly worn.

It is a well known fact that in all kinds of shops or mills, wherever a bevel gear can be replaced with a belt it is done, because the belt economizes in power, and reduces the percentage of loss from repairing. If this be true of heavy machinery it must prove equally true as to bicycles.

There is much less friction from the use of the chain than from the bevel gear, notwithstanding the many contradictions.

The model chainless wheels, made up by various factories, for the coming season, are all too heavy to ever become popular as against the chain wheel, even were it possible for them to run as well. In order to get even a fair degree of rigidity a bevel gear machine must be several pounds heavier than the average road wheel, propelled by the chain.

Several chainless models will be shown the coming season; but their success cannot yet be predicted. They are all built practically on the lines of the old "League Chainless," which made a fruitless effort to gain public favor, a few years ago, and was finally consigned to the junk pile.

The manufacturers make a desperate effort, each year, to bring out some radical change in construction, in order to stimulate trade; but it can be safely said the few who bite on the bevel-gear bait, next year, will soon return to the good old reliable chain wheel and will stay with it a long time. Of course we *may* be happily disappointed in the working of the new machine; but the chances are indeed small. Better let the other fellow try it, first, and see how he comes out.

You may break, you may shatter  
His bones if you will,  
But the scorcher will hang o'er  
The handle bars still.

—Cleveland Leader.

#### HOW TO TIME YOURSELF.

Brooklyn, N. Y.

Editor RECREATION: I recently worked out a simple method of finding how fast a bicycle is travelling. A watch must be held in the hand or attached to the handle bar. Also the gear of the wheel must be known. The rule gives the number of seconds during which the revolutions of the pedal shaft are to be counted; the number of revolutions being the number of miles the wheel is travelling, in an hour. The number of seconds is found by the following rule:

$$\frac{\text{Gear of wheel}}{5.875} = \text{seconds to count.}$$

In the case of a wheel geared to 76 this would be  $\frac{76}{5.875} = 12.92$ ; or, say 13 seconds.

Commence to count the revolutions when the second hand is 13 seconds before the minute, and stop just on the minute.

If during 13 seconds the pedal shaft has made 12 revolutions you are travelling at the rate of 12 miles an hour.

For greater accuracy the revolutions might be counted for 26 or 39 seconds, and then divide the result by 2 or 3.

TABLE.

Gear. Seconds to count.

64—10.9

68—11.57

72—12.25.

76—12.92.

80—13.6.

84—14.3.

B.

She took my heart, the cruel girl,  
And crushed it 'neath her wheel,  
But it might be worse,  
So I shall not curse—  
It might have been my wheel.

#### YOUR FOURTH LESSON.

MARY A. DICKERSON.

What exuberance you feel  
When you mount your shining wheel  
And go dashing down the smooth as-  
phalted street;  
While your teacher runs behind  
Till with dust he's almost blind  
And his unexpressed reflections can't be  
beat.

Then you think you're looking swell,  
And you're learning extra well,  
And you get an over confidential jag;  
Then the next thing that you know  
There's an awful, crashing blow  
And you find yourself reposing on a flag.

But it's not a flag of glory,  
And you never tell the story  
When your neighbors ask you how you  
learned to ride;  
But you'll find they never press you—  
They know too much—for bless you!  
Every one of them has done that very  
slide!

The largest prize winners of the year, among the amateurs, are Earl Peabody, of Chicago, who is credited with 79 firsts, and Fred Schade, of Washington, who has won 61 firsts. Ray Dawson and I. A. Powell, of the new York Athletic Club, follow close on the heels of Schade.

Mark Twain tells a story of a minister who was once driven over a road that was so bad he declared that if he ever went to hell he wanted to go over that road, because he would then be glad when he got there.

## CANOEING.

### AMERICAN CANOE ASSOCIATION

1897-98.

*Commodore, F. L. Dunnell, Brooklyn, N. Y.*

*Sec'y-Treas., C. V. Schuyler, 309 Sixth Avenue, Brooklyn, N. Y.*

#### PURSERS.

*Atlantic Division, Wm. Carpenter, Sing Sing, N. Y.*

*Central Division, Laurence C. Woodworth, Gouverneur, N. Y.*

*Eastern Division, F. J. Burrage, West Newtown, Mass.*

*Northern Division, Edgar C. Woolsey, 37 Charles St., Ottawa, Can.*

*Annual dues, \$1; initiation fee, \$1.*

*Date of meet for 1898, Aug. 5th to 19th, Stave Island, 1000 Islands, N. Y.*

#### A. C. A. MEMBERSHIP.

Applications for membership may be made to the purser of the division in which the applicant resides on blanks furnished by purser, the applicant becoming a member provided no objection be made within fourteen days after his name has been officially published in RECREATION.

The fifteenth annual meeting of the American Canoe Association was held at the Clarendon Hotel, Brooklyn, N. Y., October 16, 1897. Commodore Frank L. Dunnell presiding.

The meeting was called to order at 10.30 a.m. The roll was called by Secretary-Treasurer Schuyler, 21 Officers and Members of the Executive Committee being represented out of a possible 24; as follows:

Commodore, F. L. Dunnell; Secretary-Treasurer, C. V. Schuyler; Librarian, W. P. Stephens.

Atlantic Division: Vice-Com. Thos. Hale, Jr., Rear Com. F. M. Pinkney, Purser W. M. Carpenter, Executive Committee, F. C. Moore (proxy J. B. Mowrey), G. P. Douglas.

Eastern Division: Vice-Com. L. S. Drake, Rear Com. R. H. Hammond (proxy L. A. Hall), Purser F. J. Burrage, Executive Committee, P. C. Wiggins, A. W. Dodd (proxy R. A. Polonno).

Central Division: Vice-Com. J. R. Stewart, Rear Com. A. H. McNabb (proxy H. Williams), Purser L. C. Woodworth, Executive Committee, H. C. Morse, F. G. Mather.

Northern Division: Vice-Com. D'Arcy Scott, Rear Com. G. A. Howell (proxy J. W. Sparrow), Purser E. C. Woolsey.

This was an unusually large attendance, a record which we believe has never been equalled.

Heretofore annual meetings have been held later in the season, when it is generally cold and disagreeable, especially for traveling, and the result of this year's meeting

shows that it is advisable to hold same earlier than has been the custom.

The full Board of Governors was also present as follows:

R. J. Wilkin, president; C. V. Winne, recorder; Pau Butler, J. N. McKendrick.

The reports of each division, Secretary-Treasurer, Regatta Committee, Camp Site Committee (the Camp Site report being as complete and comprehensive as any ever presented by any officer or committee of the American Canoe Association, thanks to Mr. H. C. Morse, Chairman), Transportation Committee, Librarian and Board of Governors were read and accepted as published below.

The following were elected associate members:

Mrs. M. T. Bennett, Mrs. C. W. Lansing, Mrs. E. S. Towne, Mrs. C. V. Schuyler, Mrs. J. W. Sparrow, Mrs. Louis S. Drake, Miss Libbie Pearsall.

RECREATION was adopted as the official organ of the association, and a contract has been signed with Mr. Shields to send to each member a copy every month, also to print the Year Book for 1898 and to give the Association 2 pages each month for official notices.

Changes were made relative to the limit of paddling canoes as follows:

To be eligible to the paddling races, canoes must be within the following limits:

One and 2 men (Single and Tandem)—Maximum length, 16ft.; minimum beam, 30in.; minimum depth, 10in.; minimum weight, 50lbs. A deficiency of weight to an amount not exceeding 5lbs. may be made up by ballast.

This limit also applies to the canoes used in the trophy paddling race.

4 Men—Maximum length, 20ft.; minimum beam, 30in.; minimum depth, 12in.; minimum weight, 70lbs.

War Canoes—Maximum length, 30ft.; minimum beam, 36in.; minimum depth, 17in.; minimum weight, 120lbs.; maximum crew, 9 men.

These limits shall not apply to war canoes built prior to Oct. 1, 1897.

Stave Island was selected as the place for the 1898 Meet (this was the site of the 1889 Camp), and the date, August 5th to 19th, selected.

Considering the short time in which the Association had to transact practically a year's business certainly a large amount of work was turned out, and in a very satisfactory manner.

A dinner was given at the Crescent Club, which was attended by about 50 members, and while no formal speeches were made, Commodore Dunnell gave the members a hearty welcome in his opening address. Ex-Commodores Winne, Wilkin, McKendrick and Lawson gave the members some good advice in reference to the affairs of the Association. Mr. Hogan, Chairman of the Regatta Committee, told in a humorous manner how he would sail the course around the contestants if they refused to sail over the course. The party broke up



about midnight, all voting it thoroughly satisfactory from a business standpoint and that a pleasant evening had been spent.

C. V. Schuyler, Sec.-Treas.

CAMP SITE COMMITTEE REPORT, 1897.

Camp Grindstone, August 26.—John N. McKendrick, Com. A. C. A.—My Dear Sir: As chairman of the camp site committee for 1897 I beg to present the following report:

*Expenditures.*

|                                             |          |
|---------------------------------------------|----------|
| Material as per exhibit A, attached.....    | \$185.76 |
| Labor as per exhibit B, attached.....       | 221.75   |
| Decorations as per exhibit C, attached..... | 22.02    |
| Miscellaneous as per exhibit D.....         | 79.82    |
| Total .....                                 | \$509.35 |

*Receipts.*

|                                                             |          |
|-------------------------------------------------------------|----------|
| J. J. Delany, as per exhibit E, attached.....               | \$14.75  |
| W. L. Delany, as per exhibit E, attached.....               | 3.90     |
| From tent floors and labor, as per exhibit B, attached..... | 282.80   |
| Total .....                                                 | \$301.45 |
| Expenditures in excess of receipts.....                     | 207.90   |

\$509.35

In view of the probability that the meet for 1898 will be held upon Grindstone Island or in that vicinity, the following property of the Association was stored with J. J. Delany for future use—see exhibit F: One commodore's tent, fly and poles; 1 secretary-treasurer's tent, fly and poles; 1 camp site committee's tent, fly and poles; 1 surgeon's tent, fly and poles; 8 floors for headquarters tents, 1 mess tent floor, 1 dock, 1896; 1 dock, 1897; 2 square tables, 1 long table, 1 post-office, 1 signal flag rack, 1 signal gun platform, 2 "Private Grounds" signs, 5 benches, 5 flag-poles and blocks, 3 barrel buoys, 2 megaphones, 1 carpenter's bench (without screw), 2 tournament wands, 1 bundle  $\frac{5}{8}$  inch rope for buoys, 1 bundle No. 12 annealed wire, 4 boxes candles, 2 boxes tent pegs, 1 barber's chair, 57 lantern globes assorted colors, 72 lantern frames, 5 w. c. fixtures, 4 rolls toilet paper,  $\frac{1}{2}$  barrel copperas.

In addition to the Association property all of the tent floors belonging to the individual members (unless in charge of Mr. Delany by special arrangement) were brought to headquarters, snugly and securely piled up, subject to the owner's order and at his risk. All of which is respectfully submitted.

Henry C. Morse,  
Chairman Camp Site Committee.

TRANSPORTATION COMMITTEE REPORT, 1897.

*Receipts.*

|                           |          |
|---------------------------|----------|
| Passengers and duffe..... | \$163.48 |
| Balance.....              | 221.02   |
|                           | \$384.50 |

*Expenditures.*

|                                                |          |
|------------------------------------------------|----------|
| Advertisement for steamer.....                 | \$ 1 50  |
| Scows for duffe, 2 days.....                   | 0.00     |
| Passage, steamer, charter, seventeen days..... | 374.00   |
|                                                | \$384 50 |

In addition to the above receipts, there were further boat earnings, amounting to about \$25, collected by the camp site committee. The steamer was chartered for one day before the opening of the camp, and one day after the close. The first day, while being of considerable use to the management, was not a financial success, but the last day netted considerable profit to the Association. The receipts were reduced considerably through members chartering the steamer for trips later than the regular schedule time, and thus depriving the Association of earnings anticipated in carrying them to and from camp.

We believe that a less frequent service would be found satisfactory on all days except those when the members arrive in considerable numbers, and would suggest to our successors that, if it is found necessary to charter a steamer during the meet, the time schedule be so arranged that the A. C. A. steamer may be placed at the disposal of the regatta committee for certain portions of each day during the last week, and for charters for short trips of members of the Association in camp.

The details of the receipts from the steamer are as follows, for each day from August 5 to 21 inclusive: \$7, \$10.30, \$12.02, \$3.45, \$7.37, \$5.95, \$9.55, \$12.35, \$11.45, \$6.60, \$6.55, \$16.60, \$4.70, \$25.15, \$24.44. Respectfully submitted.

(Signed) R. Easton Burns, Chairman.

J. G. Fraser.  
J. K. Hand.

REGATTA COMMITTEE FINANCIAL REPORT,  
1897.

*Expenses.*

|                      |          |
|----------------------|----------|
| Launch, charter..... | \$6.00   |
| Prizes.....          | 137.50   |
| Prizes, express..... | 1.00     |
| Rope for buoys.....  | 2.50     |
| Cloth for buoys..... | 78       |
|                      | \$147.78 |

After recording in detail the races of the meet, the report concluded: "In order to correct misstatements regarding the trophy race, the regatta committee beg to state that on the evening of August 17 the trophy race was posted, to take place the next afternoon. At the stated time a strong puffy wind from the West was blowing, with a moderate sea running, and the weather was not considered by the regatta committee as unsuitable for moderately canvased canoes. But as only one contestant appeared at the starting line, the race was postponed to the next day, with the result as given above.

No protests were entered against the various rulings of the regatta committee. We wish to thank Commodore F. L. Dunnell for acting as clerk of the course.

The regatta committee beg to submit the following recommendations:

First—That the executive committee supply a suitable book in which all entries for the various races shall be made by the members; and the last half of the same book be ruled and headed suitably for the entry of the results of the various races.

Second—That the executive committee provide a small steam launch to be placed at the disposal of the regatta committee during the last week of the meet, in order to properly carry out the races and render assistance to contestants if necessary.

Third—That the unclassified sailing race be dropped from the programme.

Fourth—That open canoe sailing races be encouraged in future programmes, and that regulations as to sail area and lee-boards be made.

Fifth—That all the paddling races except the trophy race be made with a turn on account of the increased interest in the contests and the convenience of the contestants and officials.

Sixth—That the regulations regarding the paddling canoes be remodelled. We beg to submit the inclosed reports on the question, which have been published in the official organ. Respectfully submitted,

J. W. Sparrow, Chairman.  
C. V. Schuyler,  
H. D. McVean.

#### BOARD OF GOVERNORS' REPORT.

|                             |                                                                                            |                   |  |
|-----------------------------|--------------------------------------------------------------------------------------------|-------------------|--|
| 1896.                       |                                                                                            |                   |  |
| Nov. 11th.                  | Balance in Brooklyn Savings Bank.....                                                      | \$1,236.99        |  |
|                             | Interest on deposit .....                                                                  | 38.14             |  |
|                             |                                                                                            | <u>\$1,275.13</u> |  |
| 1896.                       |                                                                                            |                   |  |
| Nov. 20th.                  | Paid to J. N. McKendrick, Commodore, amount loaned under resolution of November 21, 1896.. | 250.00            |  |
|                             | Amount now on deposit                                                                      | \$1,025.13        |  |
|                             | Respectfully submitted,<br>Robert J. Wilkin, President.                                    |                   |  |
| Audited and found correct : |                                                                                            |                   |  |
|                             | John C. Mowbray,<br>Nat. S. Hyatt.                                                         |                   |  |

#### LIBRARIAN'S REPORT.

To the Commodore and Executive Committee of the American Canoe Association.—Gentlemen: As the librarian of the Association, I have to report that the property intrusted to me has been properly cared for during the year. The flags were put in good repair and forwarded to the camp in August, as usual. It will be necessary to spend a small sum on their further repair after the wear and tear of this season, and I would suggest that authorization be given for this work so that it may be done during the winter. No additions have been made to the A. C. A. library during the past year.

Respectfully submitted,  
(Signed) W. P. Stephens,  
Librarian, A. C. A.  
Bayonne, N. J., October 1.

#### COMMITTEES FOR 1898.

Regatta committee, Percy F. Hogan, Chairman; Raymond Appolonio, C. H. Williams; camp site committee, H. L. Quick, H. C. Morse; transportation committee, W. E. Barlow, C. V. Winne; auditing committee for report of board of governors, J. C. Mowbray, N. S. Hyatt.

#### SECRETARY-TREASURER'S REPORT, 1896-7.

##### Receipts.

|                                    |                   |
|------------------------------------|-------------------|
| Board of Governors, advanced ..... | \$250.00          |
| Atlantic Division .....            | 68.40             |
| Central Division .....             | 83.10             |
| Eastern Division .....             | 94.30             |
| Northern Division .....            | 140.00            |
| Postage on Year Book .....         | 50.93             |
| Camp site committee .....          | 301.45            |
| Year Book .....                    | 386.50            |
| Camp dues .....                    | 169.00            |
| Office expenses account .....      | 10.00             |
| Camp site committee, 1896 .....    | 11.04             |
| Transportation account .....       | 163.48            |
|                                    | <u>\$1,727.77</u> |

##### Expenditures.

|                                        |                   |
|----------------------------------------|-------------------|
| Office expenses .....                  | \$83.36           |
| General camp expenses .....            | 68.42             |
| Camp surgeon .....                     | 4.10              |
| Signal officer—powder .....            | 6.50              |
| Year Book .....                        | 386.50            |
| Postage on Year Book .....             | 56.68             |
| Cruiser's guide .....                  | 14.50             |
| Camp site committee .....              | 509.35            |
| Regatta committee .....                | 147.78            |
| Transportation committee .....         | 384.50            |
| Librarian, insurance on property ..... | 2.60              |
| New flags .....                        | 13.07             |
| New membership book .....              | 5.40              |
| Membership certificates, 500 .....     | 16.50             |
| Accounts, 1896 .....                   | 6.17              |
| Balance .....                          | 79                |
|                                        | <u>\$1,727.77</u> |

There are, to the best of my knowledge, no unpaid debts of the Association. There has been turned over to the Association the property stated in the camp site committee report, also West Shore R. R. transportation of 1896, to the amount of \$40. Uncollected Year Book postage, \$5.75. Uncollected Year Book advertisements, \$30. In looking through the membership and address books, I notice that the entries have not been kept up. I would suggest that the Association employ some one to do this work. I would also suggest that in replacing books from time to time, new books of sufficient size to obviate the need of microscopic penmanship be purchased.

All of which is respectfully submitted,  
(Signed) John R. Blake,  
Sec'y-Treas., 1896-7.

#### DIVISION REPORTS.

Oct. 1, 1896, to Oct. 1, 1897.

#### ATLANTIC DIVISION.

##### Receipts.

|                                |          |
|--------------------------------|----------|
| Balance from H. M. Dater ..... | \$284.62 |
| Dues for 1898 .....            | 1.00     |
| Dues for 1897 .....            | 180.00   |
| Dues for 1896 .....            | 15.00    |
| Dues for 1895 .....            | 2.00     |

|                               |          |
|-------------------------------|----------|
| Dues for 1894 .....           | \$1.00   |
| Entrance fees .....           | 19.00    |
| Sale of Code Books.....       | 1.30     |
| Interest on bank account..... | 5.00     |
|                               | <hr/>    |
|                               | \$517.92 |

*Expenditures.*

|                                                     |          |
|-----------------------------------------------------|----------|
| Thirty per cent. Division receipts .....            | \$68.10  |
| Office expenses.....                                | 30.22    |
| Sundries—room at Astor House and expressage... 3.30 |          |
| Division cruise and meet .....                      | 70.95    |
| Postage on Year Book .....                          | 15.90    |
| Balance in bank .....                               | 329.45   |
|                                                     | <hr/>    |
|                                                     | \$517.92 |

*Membership.*

|                            |        |
|----------------------------|--------|
| Members, Oct. 1, 1896..... | 237    |
| Members new .....          | 19     |
| Members reinstated .....   | 9      |
|                            | <hr/>  |
|                            | 265    |
| Members resigned .....     | 4      |
| Members died .....         | 2      |
| Members dropped .....      | 70— 76 |

Sept. 29, 1897, total membership..... 189

Harry W. Fleischmann, Purser.  
Sept. 30, 1897.

Audited and found correct. Oct. 1, 1897.  
(Signed) Alvin S. Fenimore,  
Maurice D. Wilt.

CENTRAL DIVISION.

*Receipts.*

|                                       |          |
|---------------------------------------|----------|
| Balance from Purser Geo J. Keyes..... | \$411.13 |
| Interest on account.....              | 6.00     |
| Dues for 1892 .....                   | 1.00     |
| Dues for 1893 .....                   | 1.00     |
| Dues for 1894 .....                   | 1.00     |
| Dues for 1895 .....                   | 2.00     |
| Dues for 1896 .....                   | 2.00     |
| Dues for 1897 .....                   | 202.00   |
| Initiation fees.....                  | 68.00    |
|                                       | <hr/>    |
|                                       | \$694.13 |

*Expenditures.*

|                                                            |          |
|------------------------------------------------------------|----------|
| Central Division Trophy.....                               | \$250.00 |
| Sundry expressage and postage .....                        | 7.41     |
| Stamps .....                                               | 10.00    |
| Printing and stationery .....                              | 15.40    |
| Sec'y-Treas. J. R. Blake, 30 per cent. of receipts.. 83.10 |          |
| Sec'y-Treas. J. R. Blake, postage on Year Books.. 14.65    |          |
| Balance transferred to incoming Purser .....               | 313.57   |
|                                                            | <hr/>    |
|                                                            | \$694.13 |

*Membership.*

|                                 |       |
|---------------------------------|-------|
| Members as per last report..... | 172   |
| New members .....               | 68    |
| Reinstated .....                | 2     |
|                                 | <hr/> |
|                                 | 242   |

Dropped for non-payment of dues..... 40  
Deceased..... 2— 42

Present membership..... 200

Laurence C. Woodworth, Purser.

Audited and found correct:  
Edward D. Taitt.  
Robert C. Dodge.  
Committee appointed by Vice-Com. H. M. Stewart.  
Oct. 7.

EASTERN DIVISION.

*Receipts.*

|                                 |          |
|---------------------------------|----------|
| Balance from former purser..... | \$238.16 |
| Dues, 1896.....                 | 6.00     |
| Dues, 1897 .....                | 288.00   |
| Initiation fees .....           | 19.00    |
|                                 | <hr/>    |
| Total.....                      | \$551.16 |

*Membership.*

|                            |        |
|----------------------------|--------|
| Members, Nov. 5, 1896..... | 326    |
| New members, 1897.....     | 19     |
| Reinstated .....           | 6— 25  |
|                            | <hr/>  |
| Total .....                | 351    |
| Died.....                  | 1      |
| Resigned .....             | 11     |
| Transferred.....           | 1      |
| Dropped .....              | 50— 63 |

Total membership, Oct. 1, 1897 .....

*Expenditures.*

|                                                                                 |          |
|---------------------------------------------------------------------------------|----------|
| Stationery, printing and postage.....                                           | \$75.63  |
| Postage, year book .....                                                        | 20.35    |
| Sundry office expenses .....                                                    | 11.25    |
| Subscription to <i>Forest and Stream</i> .....                                  | 4.00     |
| Transportation of War canoe to represent Eastern Division at general meet ..... | 31.98    |
| Prizes for Division meet.....                                                   | 43.06    |
| Expenses of Division meet.....                                                  | \$401.67 |
| Less amount collected .....                                                     | 249.00   |

Net expenses of Division meet..... 152.67  
30 per cent. due A. C. A. Secretary-Treasurer..... 94.20  
Balance Oct. 1, 1897 .....

Total..... \$551.16

Francis J. Burrage, Purser.

Audited and found correct.  
F. R. Kimball, { Auditors.  
H. C. Holt, {  
Boston, Sept. 29, 1897.

NORTHERN DIVISION.

Oct. 1, 1897.

*Receipts.*

|                            |          |
|----------------------------|----------|
| Oct. 1, 1895, balance..... | \$113.38 |
| Initiation fees .....      | 44.00    |
| Dues, 1897.....            | 76.00    |
| Dues, previous years.....  | 20.00    |
|                            | <hr/>    |
|                            | \$253.38 |

*Expenditures.*

|                                              |        |
|----------------------------------------------|--------|
| Printing (1896 account).....                 | \$7.50 |
| Stamps .....                                 | 7.00   |
| Printing.....                                | 5.25   |
| Freight and cartage .....                    | 1.75   |
| Expenses <i>re</i> war canoe .....           | 13.62  |
| Expenses incurred in camp.....               | 12.15  |
| Sundries.....                                | 1.55   |
| Repairing A. C. A. flag .....                | 3.00   |
| Amount paid Secretary-Treasurer A. C. A..... | 140.00 |
| Balance.....                                 | 61.56  |

\$253.38

*Membership.*

|                      |        |
|----------------------|--------|
| New members .....    | 23     |
| Renewals .....       | 76— 99 |
| 1896 membership..... | 74     |

Gain..... 25

(Signed) F. H. Macnee, Purser Northern Division.

Audited and found correct.  
(Signed) W. C. Kent, A. C. A. No. 1996.  
C. G. Shannon, A. C. A. No. 2329.

APPLICATIONS FOR ASSOCIATE MEMBERSHIP.

Miss Maude Stewart, Rochester, N. Y.; proposed by J. R. Stewart, same address.

APPLICATIONS FOR MEMBERSHIP.

William D. Cram, Haverhill, Mass., Pemigewasset Canoe Club.  
Richard J. Plaskett, Toronto, Ont.  
Geo. W. Begg, " "  
John Harmer, " "

The following letter contains some interesting data concerning the cut on the lower half of page 440, this issue of RECREATION:

Buffalo, N. Y.

Editor RECREATION: Your letter to Captain F. S. Thorn, has been handed me for answer. The name of the Buffalo War Canoe is "Quid Pro Quo." The crew was in no sense a Buffalo crew. As you will see by the names it was gathered hastily and at random, and represented various clubs. The members of the crew were as follows, commencing at the bow:

|                   |                    |                           |
|-------------------|--------------------|---------------------------|
| J. N. McKendrick, | Galt, Ont.,        | Ubique Club.              |
| C. P. Forbush,    | Buffalo, N. Y.,    | Vice-Com., Buffalo C. C.  |
| J. G. Bissell,    | Rome, N. Y.,       | Deowainsta C. C.          |
| J. R. Robertson,  | Auburndale, Mass., | Puritan C. C.             |
| S. B. Hughes,     | Pittsburg, Pa.,    |                           |
| S. R. Upham,      | Claremont, N. H.   |                           |
| H. C. Morse,      | Peoria, Ill.,      | Peoria C. C.              |
| E. B. Nelson,     | Rome, N. Y.,       | Deowainsta C. C.          |
| W. H. Huntington, | Rome, N. Y.,       | " "                       |
| T. N. Stryker,    | Rome, N. Y.,       | " "                       |
| L. T. Coppins,    | Buffalo, N. Y.,    | Buffalo C. C.             |
| E. B. Edwards,    | Peterboro, Ont.,   | Peterboro C. C.           |
| F. S. Thorn,      | Buffalo, N. Y.,    | Coxswain, Buffalo [C. C.] |

Please state that this was a "scrub crew," although a Buffalo boat, steered and stroked by Buffalo men; but containing 2 ex-commodores of the A. C. A., and the '97 commodore. Can the name "scrub" be properly applied to a crew containing so many prominent A. C. A. men?

Please find enclosed \$1 for one year's subscription to RECREATION commencing with October number which please send to "Mrs. Chas. Van Bergan, Asheville, N. C."

Yours very truly,

C. Howard Williams,

1898 Mem. Regatta Com. A. C. A.

#### THE PROPOSED MEMBERSHIP COMPETITION.

The Commodore and Secretary-Treasurer of the A. C. A., after reconsidering their offer of a prize for a membership competition, as published, have decided to withdraw it.

In explanation of the above, it is only necessary to say that a number of the old members of the A. C. A. have expressed their disapproval of the competition; so we have decided to withdraw the offer.

We trust this will not prevent all members of the A. C. A. from trying to induce all good canoeists, and those interested in canoeing, to join the A. C. A.

Frank L. Dunnell, Commodore.

C. V. Schuyler, Sec'y-Treas.

The Wawbewawa Canoe Association, of Newton, Mass., intends to keep the members together during the winter months, the form of attraction being a series of "smokers" and concerts to be held at the new club house, on the Charles river.

The house is easy of access and the facilities for having good times are of the best.

A large open fire-place, in the spacious club room, gives opportunity for the "camp fires" so popular among all A. C. A. members, and there is every prospect of a most enjoyable season. In all probability a whist tournament will be given, in connection with the smokers. The committee in charge of the club's affairs is composed of Louis S. Drake, Francis J. Burrage, Wm. V. Forsaith, Louis A. Hall and L. G. F. Hoffman.

The Central City Canoe Club was organized here, September 27th, with the following officers:

W. S. Allen, Com.; J. C. Moyer, Sec.; R. W. Smith, Treas.

At present the Club has 7 canoes, but we expect to add to that next spring.

W. S. Allen, Jackson, Mich.

Why not join the A. C. A.? The dues are but \$1 a year, including a subscription to the Official Organ.—EDITOR.

The breezes  
Through the treezes  
Make the geezes  
Sneezees.

A member of the Brooklyn Canoe Club, sends this in and says it is his first poem. He hopes, however, it will not be his last.

#### THE FISH THAT GETS AWAY.

W. W. K.

A funny thing is always true  
Of those who, from day to day,  
With rod and line the waters haunt,  
Whether for sport or pay;  
This funny thing you'll hear from them,  
Find them where'er you may,  
The biggest fish they ever catch,  
Is the one that gets away.

No matter how long the string they've caught,  
Or how much the biggest may weigh,  
Or whether they've fished for a little while,  
Or been at it all the day;  
No matter where the fishing's been done,  
Or when, or whatever the way,  
The biggest fish they ever catch,  
Is the one that gets away.

So unfailing is this story given,  
This excuse for failure made,  
That it's recognized by those who know,  
As a part of their stock in trade;  
And when any other tale is told,  
Of this you may be sure:  
The fellow's too green to know how to fish;  
He is only an amateur.

## BOOK NOTICES.

## A REMARKABLE BIRD-BOOK.

Even to those who are familiar with the literature of our native birds, "Bird Neighbors," by Neltje Blanchan, must come as a genuine surprise. How it is possible to produce so fine a book and sell it for \$2 is to me a mystery, despite the fact that I know a thing or two about book-making.

There are 50 large colored plates (6 x 8 inches), 234 pages of text, beautifully printed on heavy paper, and a binding both pleasing and substantial; all sold at a price which would seem barely sufficient to pay for the printing of the plates alone.

The plain duty of a book reviewer is to give the reader an idea of the book under treatment, and to be just, both to the author and the publisher. The most valuable review is that which brings the reader nearest to the thing reviewed; neither gushing unduly, nor setting down aught in malice. There are books which I am not willing to waste time and space in noticing; but "Bird Neighbors" is not one of them.

This book is a bold effort to place before the public, at a merely nominal price, a book which will bring the general reader in close touch with 150 species of our smaller birds. All the well-known game birds, the water birds, the herons and the birds of prey have been omitted, and the work is devoted wholly to the smaller species that, in size, range from the humming-bird to the crow. In order that even the dullest person may get these 150 species well within his mental grasp, they are classified 5 times, in 5 different ways, as follows: (1) the regular scientific classification; (2) by the places they inhabit; (3) by the seasons when they are seen; (4) by size, and (5) according to their colors. It is their treatment under the last arrangement which constitutes the body of the work; the others being merely lists.

In treating each of the species chosen, the author gives its scientific name and the name of its family; all its English names, its length, description of male and female, geographical range and migrations. Following this is about a page of breezy, well-written text, which really introduces the bird to the reader, and sizes up its moral character and social standing in a most refreshing way. In this the author has caught and reflected the delightful literary spirit of her "guide, philosopher and friend"—John Burroughs. The proof of it is that after having read the page, you feel that you know the bird, personally.

But the pictures! Unless I am mistaken they will be, to the public, a pleasing surprise. They have been produced in colors, by a new process, the basis of each plate being a large photograph—often life size—of an actual bird. In many cases the nest and

eggs are shown. In most cases the background of each plate is a pleasing landscape, accurately representing the favorite haunts of the bird.

Unless I am greatly mistaken, the appearance of this book will mark an era in the making of zoological illustrations for books. Although it cannot be said that every plate is perfect, as to the colors of its birds, it is only the best and most costly lithographs that surpass them. Whatever a few of them may lack of strict accuracy, in color, is amply made up, to the reader, by the photographic details of the form and plumage, the value of which cannot possibly be denied.

Another novel feature about this book is that the publishers propose to send it, on approval, to any reader of *RECREATION* who may send them his name and address, with the privilege of returning at the publishers' expense, if not found satisfactory. If after examination he decides to keep the book, he can remit them the \$2 instead.

I cordially recommend this book as one which will be of solid value and lasting pleasure to its possessor. There is one book now on the market, at 10 times the price of "Bird Neighbors," which is of less intrinsic value. This latter book is a marvel of value and cheapness combined, and I predict that no one to whom it may be sent, or inspection, will either return it to the publishers, or find fault with its price.

*BIRD NEIGHBORS*, an introductory acquaintance with 150 birds commonly found in the woods, fields, and gardens about our homes. By Neltje Blanchan, with an introduction by John Burroughs, and 50 plates of birds in natural colors. New York. Doubleday & McClure Co., small quarto, pp. xii-234. Plates 50 in colors. \$2.00.

Stanley Waterloo's imagination runs in unusual directions, and in "The Story of Ab" he takes his readers back to the days of the cave men. In this story he pictures real men and women, too. These very great grandfathers and grandmothers of ours, with their long, flexible toes and their prehistoric ability for climbing trees, their fierce, primitive passions, and their beginnings of evolution, seem wonderfully human and interesting under the magic of Mr. Waterloo's pen. You rub your eyes and wonder if you are really living in the 19th century, or if Ab will presently swing down from the branch of some huge tree and stand before you, stone ax in hand.

Being the story of a man, it is also the story of a lover, and a slim brown maiden lends a charm to the tale.

Scientists will be interested in what Mr. Waterloo has to say of the transition from the Paleolithic to the Neolithic age; and all lovers of the fields and the woods will enjoy his wonderful pictures of ancient conditions.

"The Story of Ab" is published by Way & Williams, Chicago; price \$1.50.

# Folding

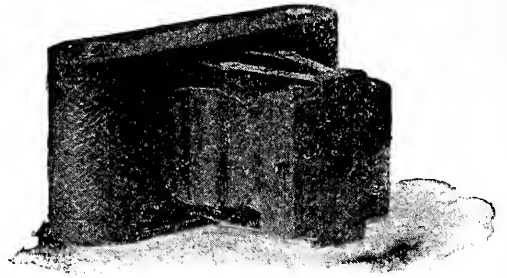

1½ INCHES THICK.  
MAKES PICTURES 2¼ X 3¼ INCHES.

# Pocket Kodak

So shaped as to go into the pocket without inconvenience, so light as to be no trouble when there, using light-proof film cartridges with which it can be loaded in daylight and withal capable of making beautiful pictures 2¼ x 3¼ inches, the Folding Pocket Kodak is the embodiment of photographic daintiness and utility.

The shape of the picture is artistic and the quality perfect, because the lenses are perfect. These lenses have a fixed focus, are strictly achromatic, have wonderful depth and definition, and every one must undergo the most rigid tests by our own inspector. Every lens with the slightest imperfection is unhesitatingly discarded.

The shutter is a marvel of simplicity. It is always set and snap shots are made by a simple downward pressure on the exposure lever; time exposures are made by touching another lever once to open and again to close the shutter. The shutter has a set of three stops and there are two finders, one for vertical and one for horizontal exposures.

Made of Aluminum, covered with fine black morocco with buffed brass fittings.



PUT A  
KODAK  
IN YOUR  
POCKET.

Price, Folding Pocket Kodak with fine achromatic lens, \$10.00  
Light-Proof Film Cartridge, 12 exposures, 2¼ x 3¼, .40

**Put a Kodak on your Christmas List.**  
**\$5.00 to \$25.00.**

Catalogues free at agencies or by mail.

No Camera is a KODAK  
unless manufactured by  
the Eastman Kodak Co.

**EASTMAN KODAK CO.**

Rochester, N. Y.

## AMATEUR PHOTOGRAPHY.

### HOW WE PHOTOGRAPHED THE BABY.

The photographer fastened the baby in a suspicious looking mechanism which he averred would hold the baby comfortably, and at the same time be invisible. I could not help thinking what an admirable wife and mother such a machine would make. Then he stepped back and looked inside the camera to see if its insides were all right. Failing to discover a fit of indigestion or other weakness in the machine he shook himself free from the mantle of cloth, stepped to one side, ran his fingers through his hair, grabbed the rubber vermiform appendix, that opens the eye of the instrument, and remarked, in a weary sort of a way, as though he anticipated a struggle: "Now look pleasant, please."

I gazed at him pityingly. No need to ask that man whether he was married, and the father of children.

"You don't suppose that baby understands such language as that, do you?" said my wife, witheringly.

"I always thought I spoke fairly good English," the photographer answered. "However, perhaps the baby will understand you better."

"Well, I should hope so," answered the little lady. Then she smiled on her infant and said: "Didn't its cutesy wootsey litley bitsey soulsum woulsum want to smiley wilesey sumsum wumsum for its momsum womsum?"

Our heir apparent gave one look of disgust, curled the Northeast corner of her mouth up into her Southwest ear, closed her eyes, turned red and yelled bloody murder in choicest baby talk.

"Doesn't seem to work any better than mine, does it?" said the photographer, with a sneer.

"Humph!" ejaculated the little lady. "She's afraid of you—and no wonder!"

Then the photographer tried again. He put a pet cat on top of the camera and a canary bird on the chair beside it. Then he stirred up a sleepy monkey that reposed in a corner, wound up a mechanical bug and started it across the floor, tooted on a tin horn, beat a toy drum and danced a jig. No use. The baby simply looked more disgusted still, and yelled the louder.

Then the little lady sang a song, but without effect. Perceiving that a variety show was in order I did a turn then, and rendered my inimitable imitation of a man trying to recite a poem. Then the photographer performed some clever juggling tricks, the most wonderful of which was extracting \$3 dollars, on account, from my own pocket. I had hoped to get the photographs charged; but this did not work. The little lady followed with "Curfew Shall Not

Ring To-night." On this I made an impromptu parody entitled "Baby Will Not Smile To-day," and then the little lady suggested that we give her the legitimate. We did. First we gave the dagger scene from "Macbeth," then the sword scene from "Richard III." We closed with Antony's oration, with the little lady as *Antony*, myself as the populace, and the photographer as the corpse. He said he felt like one. The baby "lent us her ears" all right, but look pleasant she would not. Every alternative having failed, I at length turned to what I call my "last resort." I got down on my hands and knees and let the youngster toy with my hair and mustache. Then she smiled.

Our friends say it is a splendid picture of the baby, but an awfully poor one of me.—T. Winthrop in *Truth*.

---

### THE RAY FILTER.

The following interview with Mr. Pirie MacDonald which recently appeared in the Albany, New York, Argus, should set every photographer thinking, coming as it does from a man who is so thoroughly in touch with every advance in photographic matters.

"What is, to your mind, the most interesting topic of the day? I mean in relation to the amateur."

Please don't make that distinction. When it is a question of interesting topics, the amateur and professional should be equally interested in everything photographic; and they are. It seems to me that ortho-chromatic photography is the most interesting problem we have ever had to tackle; and to-day it is being worked on to a greater or less extent by all photographers, high and low, amateur and professional. You know, of course, that in the ordinary dry plate the blue and violet rays have a proportionately greater actinic than those from the other end of the spectrum, the greens, yellows and reds. Actinism is defined, by Webster, as a property in the solar rays which produces chemical changes, as in photography. When an exposure is made on a subject having a great range of colors, such as, for example, the ordinary landscape, the blues in the sky are exposed so rapidly, that they are overdone, when sufficient exposure is given to get the detail in the greens and yellows.

The ortho or iso-chromatic plates (from the Greek *ortho*—meaning right, and *iso*—meaning equal and chromatic color), is particularly sensitive to orange (yellow and red), and exposes them more rapidly than the plain plate; thereby giving the blues

and violets less opportunity of becoming overdone in a normal exposure.

The apparatus made by Bausch & Lomb, of Rochester, and known as the Ray filter, is a cell fitted with a collar which fits over the lens. It is filled with a solution of bichromate of potash, which is orange in color. Its mission is to control the blue and violet rays which have an exalted actinic action, and it does this by coloring the picture, that you see on the ground glass, uniformly yellow. Then expose on iso-chromatic plate (that is particularly sensitive to yellow) and you have a picture that is in harmony.

---

#### PHOTOGRAPHING HORSES IN MOTION.

Editor RECREATION: If you will allow me to add a few words to your reply to F. D. Fowler, Denver, Colo., on p. 336 of October RECREATION, I would advise him to use as large a portrait lens as he can get, to photograph horses in motion. The portrait type of lens has a shorter focus than the rapid rectilinear, and is therefore a quicker type, other things being equal. I would prefer a Voigtländer Euryscope (portrait) to the Dallmeyer, for out door work. Both are excellent, but the Voigtländer gives a finer atmospheric rendering. The use of a large lens, one of large diameter, gives great gathering power as regards light-rays. A medium stop will give sufficient sharpness, on a small plate.

I fear the shutters you recommend are hardly fast enough to get pictures without blur. A running horse will move his feet about 100 feet a second, at parts of the movement. A shutter must work at  $\frac{1}{500}$  of a second to get even approximate sharpness, which can be so modified, by retouching, as to be satisfactory. However,  $\frac{1}{800}$  of a second is much more desirable, and in good light, with a large lens and a well contrasted background, this will be time enough. I know of but one shutter that will do this, and that is the Focal Plane shutter, an English contrivance. Prosch's Athlete shutter is next, with a speed of  $\frac{1}{400}$  of a second.

I offer these suggestions as the results of some practical experience in this line. With every possible precaution even an expert misses many pictures of this sort.

R. Ferris, Shokan, N. Y.

---

#### FOCUSING.

The idea of many photographers, some professionals as well as amateurs, is that the proper thing to do, always, is to get the image or view sharp. But to the scientific worker, and to one who knows something of art as well as of photography, this is by no means an invariable rule. The *Photographisches Notiz-buch* gives a method adopted by one of its readers. In order to

make the best of the depth of focus in the lens, the most distant object that is desired to be sharp must be got into focus before all else, without using a diaphragm. After this has been secured put in the stop selected as being the proper one to use on the occasion; then observe the point (nearer than the one taken at first) where the sharpness ceases. Then remove the stop and focus this point; again replace the stop and focus this last point; place the stop again in the slot, and the result will be satisfactory. But in photographing portraits the reverse method should be adopted; the nearest object must be first focused, afterward dealing with those points the most distant.—*Photography*.

---

#### WARM-TONE GOLD INTENSIFICATION FOR PLATINOTYPES.

When a platinotype is weak, and a rather warmer tone than that of the normal platinotype print is desired, Mr. Dollond's method may be adopted. The wet print is laid face upward, on a glass plate, and after the excess of moisture has been blotted off, glycerine is spread over the surface, with the finger or with a Blanchard brush. By mixing a few drops of weak chloride of gold solution, say 1 grain to a drachm, with 2 or 3 parts of glycerine, and spreading this over the surface of the print, the image gradually becomes intensified and toned. When a stronger action is desired, here and there, a few drops of the chloride of gold solution may be poured on the print and incorporated with the glycerine already on the paper. As soon as sufficiently toned and intensified, both front and back should be freely sponged with water, after which the print should be washed by several soakings. Subsequent treatment with a reducing agent has been recommended, but may be dispensed with.—*The Amateur Photographer* (British).

---

Ruskin says, "Art is that in which the hand, the head and the heart go together." Those people who use only their heads and their hands had better keep out of photography.

---

I note you offer a 4 x 5 Cyclone camera for 5 subscriptions. You need not be afraid to recommend it. They are giving the best of satisfaction here.

L. G. Torrey, Leslie, Mich.

---

I will esteem it a personal favor if you will send me the names and addresses of all the sportsmen you know, who are not yet readers of RECREATION.

---

In making up your list of Christmas presents put down a yearly subscription to RECREATION, for each of your best friends.



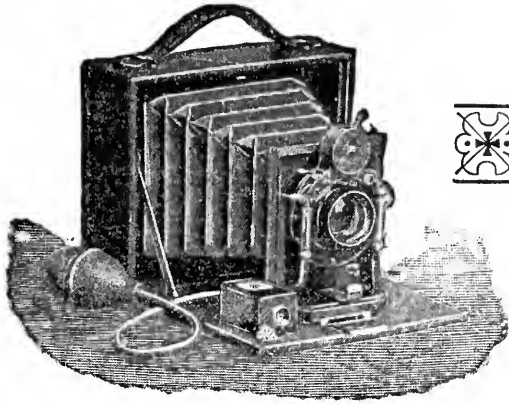

PREMOS  
PRODUCE  
PERFECT  
PICTURES

# Premo Cameras

Have achieved an enviable reputation the world over. Their PERFECT construction and ease of manipulation, combined with grace, beauty, and superb finish, have placed them in the front rank, and they are to-day the Favorite Camera with the foremost Amateur and Professional Photographers.

MADE IN

20

DIFFERENT STYLES  
AND SIZES

Special Designs for the Sportsman and Tourist

CATALOGUE MAILED FREE

Rochester Optical Co., Rochester, N. Y.



## HOLIDAY BOOKS

**Marchesi and Music.** Passages from the Life of a Famous Singing Teacher. By MATHILDE MARCHESI. With an Introduction by MASSENET. Illustrated. Post 8vo, Cloth, Ornamental, Deckel Edges and Gilt Top, \$2.50.

**Jerome, A Poor Man.** A Novel. By MARY E. WILKINS, Author of "Jane Field," "Pembroke," etc. Illustrated by A. I. Keller. 16mo, Cloth, Ornamental, \$1.50.

**Paste Jewels.** Being Seven Tales of Domestic Woe. By JOHN KENDRICK BANGS, Author of "Coffee and Repartee," "A House Boat on the Styx," etc. With One Illustration. 16mo, Cloth, Ornamental, \$1.00.

**Unkist, Unkind!** A Novel. By VIOLET HUNT, Author of the "Maiden's Progress." Post 8vo, Cloth, Ornamental, \$1.25.

**By W. D. Howells:** "An Open-Eyed Conspiracy." An Idyl of Saratoga. Post 8vo, Cloth, \$1.00.

"The Landlord at Lion's Head." A Novel. Illustrated by W. T. SMEDLEY. Post 8vo, Cloth, \$1.75.

**The Martian.** A Novel. By GEORGE DU MAURIER, Author of "Peter Ibbetson," "Trilby," etc. Illustrated by the Author. Post 8vo, Cloth, Ornamental, \$1.75; Three-quarter Calf, \$3.50; Three-quarter Crushed Levant, \$4.50. A Glossary of the French expressions is included.

*Édition de Luxe*, on Hand-made Paper, with Deckel Edges—the Illustrations in Sepia and the Text in Black. Large 8vo. Bound in Vellum. Limited to 500 Numbered Copies. \$10.00.

**Outlines in Local Color.** Stories. By BRANDER MATTHEWS, Author of "Vignettes of Manhattan," "Tales of Fantasy and Fact," etc. Illustrated. Post 8vo, Cloth, Ornamental, \$1.50.

**From a Girl's Point of View.** By LILIAN BELL, Author of "The Love Affairs of an Old Maid," "The Under Side of Things," etc. With a Photogravure Portrait. 16mo, Cloth, Ornamental, \$1.25.

**The French Revolution.** By JUSTIN H. MCCARTHY. Vol. II. completing the work. Post 8vo, Cloth, \$1.50.

**Stuart and Bamboo.** A Novel. By Mrs. S. P. MCLEAN GREENE, Author of "Vesty of the Basins." Post 8vo, Cloth, Ornamental, \$1.25.

**Jimty, and Others.** Stories. By MARGARET SUTTON BRISCOE. Illustrated. Post 8vo, Cloth, Ornamental, \$1.50.

**Lin McLean.** By OWEN WISTER, Author of "Red Men and White," etc. Illustrated. Post 8vo, Cloth, Ornamental, \$1.50.

**White Man's Africa.** By POULTNEY BIGELOW, Author of "The German Struggle for Liberty," "The Borderland of Czar and Kaiser," etc. Illustrated. Crown 8vo, Cloth, Ornamental, Uncut Edges and Gilt Top, \$2.50.

**Lorraine!** A Romance. By ROBERT W. CHAMBERS. Post 8vo, Cloth, Ornamental, \$1.25.

**Ars Recte Vivendi.** Being Essays Written for "The Easy Chair." By GEORGE WILLIAM CURTIS, Author of "Prue and I," etc. Post 8vo, Cloth, Ornamental, Uncut Edges and Gilt Top, \$1.25.

**Celebrated Trials.** By HENRY LAUREN CLINTON, Author of "Extraordinary Cases." With Nine Portraits. Crown 8vo, Cloth, Uncut Edges and Gilt Top, \$2.50.

**School-Boy Life in England.** By JOHN CORBIN. Illustrated. Post 8vo, Cloth, Ornamental, Uncut Edges and Gilt Top, \$1.25.

**A Legend of Camelot.** Pictures and Verses of English Society. By GEORGE DU MAURIER, Author and Illustrator of "The Martian," "Trilby," etc. Large 4to, Cloth, Ornamental, \$5.00.

**Alan Ransford.** A Story. By ELLEN DOUGLAS DELAND, Author of "Oakleigh." Illustrated by HARRY C. EDWARDS. Post 8vo, Cloth, Ornamental, \$1.50.

**John Leighton, Jr.** A Novel. By KATRINA TRASK. Post 8vo, Cloth, Ornamental, \$1.25.

**Harper's Contemporary Essayists:** Post 8vo, Cloth, Ornamental, Uncut Edges and Gilt Top, \$1.50 each.

"The Personal Equation." By HARRY THURSTON PECK.

"Certain Accepted Heroes, and Other Essays in Literature and Politics." By HENRY CABOT LODGE.

"How to Tell a Story," and Other Essays. By MARK TWAIN.

"Book and Heart": Essays on Literature and Life. By THOMAS WENTWORTH HIGGINSON.

"The Relation of Literature to Life." By CHARLES DUDLEY WARNER.

"Impressions and Experiences." By W. D. HOWELLS.

"Aspects of Fiction," and Other Ventures in Criticism. By BRANDER MATTHEWS.

**A History of Methodism.** By JAMES M. BUCKLEY. In Two Volumes. With over 100 Portraits and Views. 8vo, Cloth, \$5.00.

Harper & Brothers, New York and London

# Just the Thing for Xmas

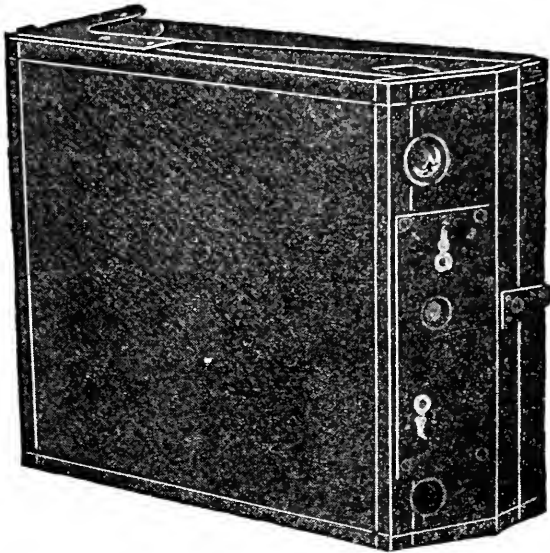

WHEN CLOSED MEASURES  
2x5x6 INCHES

WEIGHS BUT 16 OZS.

IMPROVED  
NO. 2

## KOZY

CAMERA

TAKES A PICTURE

3½ X 3½

JUST THIS SIZE

The most compact and smallest high-grade camera made, taking 12 film pictures.

### FOR TOURISTS AND BICYCLISTS IT SUPPLIES A LONG-FELT WANT

The KOZY has a fine achromatic lens—"peek hole"—three-speed shutter—Eastman daylight films—strongly made—beautifully finished and guaranteed or *Money refunded*.

THE PRICE **\$10.00**

If your dealer doesn't keep them, upon receipt of price, we will send one express paid to any address in United States.

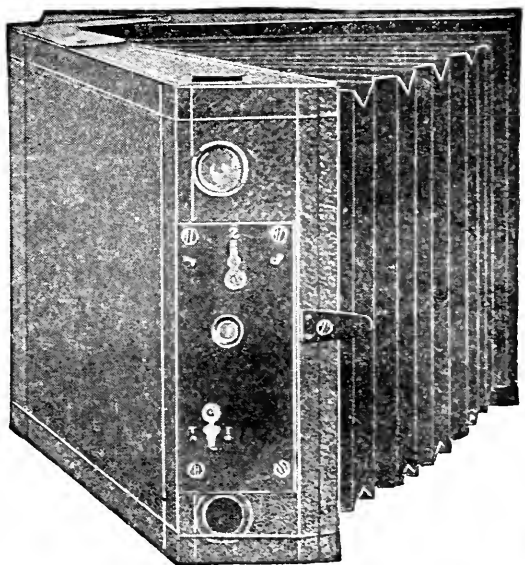

The **KOZY CAMERA CO.**,  
40 BEDFORD ST., **Boston, U.S.A.**

Send for Catalogue



(Taken on a Carbutt Orthochromatic Plate.)  
By ALOIS BRER, Photographer to Emperor of Austria

## To Obtain Artistic Results

as much care must be used in the selection of the Plates or films as the Camera.

### CARBUTT'S PLATES AND FILMS

(STANDARD FOR 20 YEARS)

Give Universal Satisfaction

Also J. C. DEVELOPING TABLOIDS, put up in 3 sizes, price 25c., 40c., 75c.

If you intend competing for prizes let us assist you in winning by the aid of our Plates, Films, and Developer. For sale by all dealers. Catalogue free.

JOHN CARBUTT, <sup>WAYNE</sup>JUNCTION Philadelphia, Pa.

## THE MARLBOROUGH CAMERA

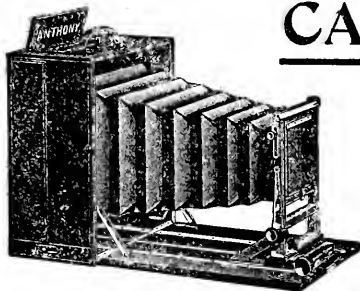

Reversible  
Swing  
Back,  
Rising and  
Swing  
Front

|                                                                                      |      |               |
|--------------------------------------------------------------------------------------|------|---------------|
| 5x7, fitted with the Rapid Rectilinear Lens, B. & L. Shutter and two Double Holders, | \$60 | Send for Free |
| 8x10, without lens and shutter,                                                      | 50   | Illustrated   |
| 6½x8½,                                                                               | 45   | Booklet       |
| 5x7                                                                                  | 35   |               |

Send for Free Pamphlet of \$5 and \$8 Cameras

We recommend the New American Films for hand-camera work.  
Try Metacarbol, the most powerful developer known.

Catalogue of all kinds of Cameras and all requisites for photography mailed on application. Free

We recommend to amateurs CLIMAX DRY PLATES They are quick and reliable

The INTERNATIONAL ANNUAL, Vol. X. Full of valuable articles, and profusely illustrated by the best photographic workers in this country and abroad. Price, 75 cents; postage, 15 cents.

E. & H. T. ANTHONY & CO.  
591 Broadway, New York  
45, 47 and 49 E. Randolph Street, Chicago.

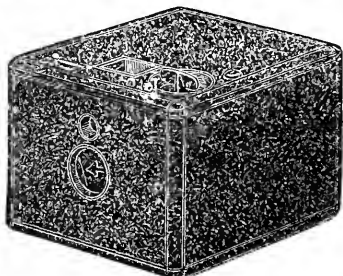

The Baby, \$6

Size, 2 1-2 x 3 1-2 x 4 in.  
Photo, 2 x 2 1-2 in. Weight, 7 oz.  
Loaded with 12 exposures

## Success in Photography

is only obtained by using an outfit well made, with high-grade lens, and reliable shutter.

### The Hawk-Eyes

manufactured in various styles and sizes from the "Baby" up, can be loaded and unloaded in broad daylight, can be used with film or glass plates and warranted to prove just as represented.

## Why not make your Own Photographs?

A Guide-Book is furnished with each camera that will enable the novice to produce good results from the start

THE BLAIR CAMERA CO., Mfrs.  
22 Randolph St., Boston, Mass.

Send for Illustrated Catalogue which tells everything

**QUANTITY IS NOT QUALITY**

This is More True Regarding  
Cameras than Any-  
thing Else



Some unprincipled manufacturers will send you a picture taken out of the center of an exposure made with a \$25.00 Camera and claim it is made with the instrument they have for sale, but *OUR SAMPLES are actually made with*

**The "QUAD," Price \$5.00**

*Other points to be considered are Weight and Length*

The "QUAD," loaded, weighs less than 1½ lbs. Others loaded, weigh from 5 to 10 lbs. The "QUAD" measures 6 inches in length. Others measure from 8 to 12 inches in length. The "QUAD" makes a picture 3½x3½ inches.

*No Slides to Draw! No Fumbling in a Coat Sleeve! No Opening the Box! It is all done from the Outside, consequently no chance to spoil plates.*

**NO EXTRA CHARGE FOR PLATEHOLDERS**

The "QUAD" with Four Holders, \$5.00. Everything photographic can be done with the "QUAD." I manufacture and sell all kinds of Amateur supplies. Catalogue for the asking. Sample picture *actually* made with the "QUAD" for 5 cents in stamps. Send direct to

**EDWARD G. CONE, Manufacturer**  
804 Champlain Building, CHICAGO

California Camera Co., Pacific Coast Agents, 22 Geary St., San Francisco, Cal. E. & H. T. Anthony & Co., 591 Broadway, N.Y.. Eastern Agents.

**JUST OUT 8¼ Inch Acme Amateur Rotary Burnisher**

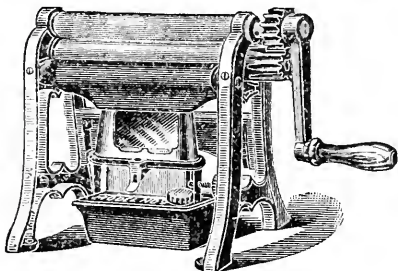

Heats Evenly and Quickly  
Full Nickel Finish  
Fully Guaranteed  
Price, \$10.00

**ACME BURNISHER CO.,** Fulton, N. Y.  
Mention RECREATION.

I am now offering a \$750 upright piano for 200 yearly subscriptions to RECREATION, at \$1 each. Here is an excellent opportunity for some energetic woman to get a high grade piano for a few days' work. In any city of 5,000 inhabitants, or more, a club of this size can be enrolled in a week. Write for particulars.

In making up your list of Christmas presents put down a yearly subscription to RECREATION, for each of your best friends.

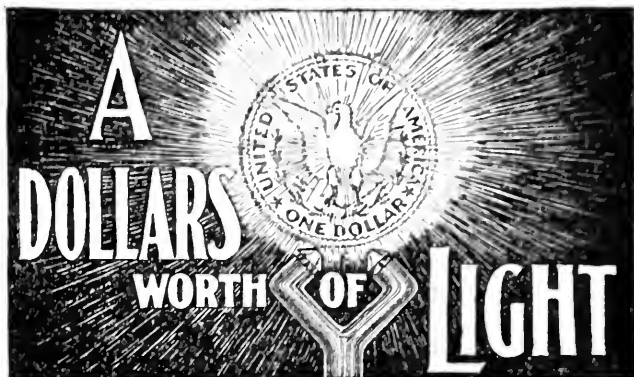

|                                                   |     |  |                    |
|---------------------------------------------------|-----|--|--------------------|
| <b>CANDLE POWER HOURS FOR \$1.00 (One Dollar)</b> |     |  |                    |
| Incandescent electric light,                      |     |  | <b>1600 C.P.H.</b> |
| Illuminating gas,                                 | - - |  | <b>2560 C.P.H.</b> |
| Gasolene gas,                                     | - - |  | <b>3200 C.P.H.</b> |
| Acetylene,                                        | - - |  | <b>6700 C.P.H.</b> |

**"Acetylene is the coming illuminant."**

**NAPHEYS' ACETYLENE GAS GENERATOR** makes a private gas plant absolutely practicable, safe and reliable. The only "dry" generator, and consequently the only one for domestic lighting. Approved, adopted by the U. S. Government.

**J. B. COLT & CO.**

SOLE AGENTS. ALSO MANUFACTURERS OF **STEREOPTICONS** and all paraphernalia for LIGHT production and projection.

New York. Chicago. San Francisco. Buffalo.  
Acetylene Gas Show Rooms at N. W. Cor. Broadway and 37th St., New York City. Full particulars from Dept. 4  
Main Office, 115-117 Nassau St., New York.

**Life is too Short**



to bother with slow, tedious, and difficult printing processes. That's why you should use our Velox papers. They can be used at any time, day or night.

It takes an **INCREDIBLY SHORT TIME** for turning out **LOTS** of prints.

**NO PROCESS SO EASY and SIMPLE** gives such

**Artistic and Permanent Results**

**SAMPLE PACKAGES** of two dozen Cabs., or 4x5, two Sample Prints, and Developer, will be sent on receipt of 50 cents.

We manufacture **ALL** kinds of photographic papers, gelatine, collodion, matt, glossy, Bromide, etc.

**NEPERA CHEMICAL CO.**

Works and Head Office, NEPERA PARK, N. Y.

BRANCH OFFICES {Chicago, Ill., 21 Quincy St.  
Paris, France, 8 Rue Martel

Order from your dealer, and if he does not fill your order, we **WILL**.

# The Baby Wizard Camera

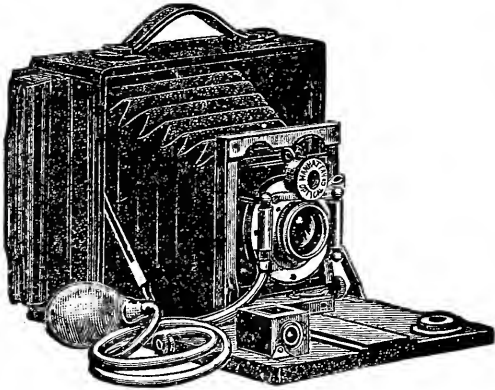

Only  $2\frac{3}{8}$  x  $5\frac{5}{8}$  x  $6\frac{3}{8}$  inches

*Is the  
Ideal Camera*

FOR TOURISTS, WHEELMEN  
OR SPORTSMEN GENERALLY

*Fitted with our Extra Rapid Rectilinear Lens (unequaled in this country), and the Bausch and Lomb Optical Company's Iris Diaphragm Shutter.*

Complete with Carrying Case

**\$25.00**

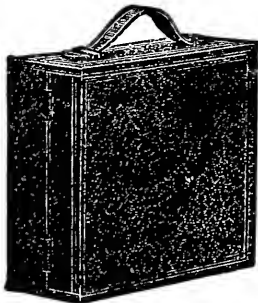
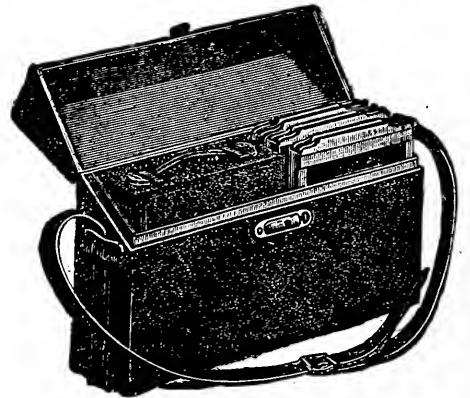

Same without rack and pinion, for focussing, and swing back

**\$20.00**

SEND FOR CATALOGUE

Manhattan Optical Co., Cresskill, N. J.

IT HAS SIMPLIFIED PHOTOGRAPHY.

A ROYAL GIFT for the HOLIDAYS,

# The ADLAKE CAMERA

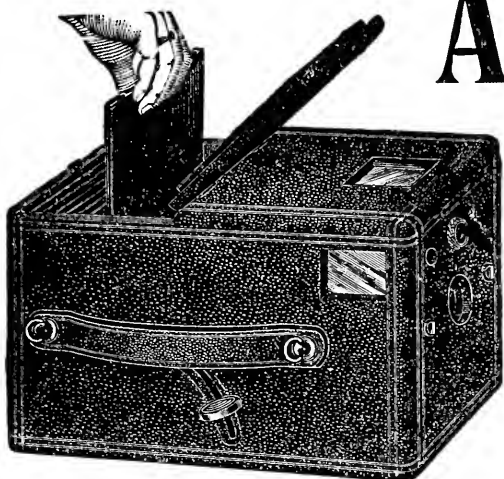

IT IS A PERFECT INSTRUMENT FOR TAKING  
INTERIOR VIEWS, HOME PORTRAITS,  
AND FAMILY GROUPS.

The Adlake has the finest single achromatic Lens that money will buy. The Shutter is adjustable for time or instantaneous work; is simple and certain in action and cannot get out of order. The diaphragm has three stops and there are two View Finders that find. The ADLAKE takes 12 pictures on glass plates at one loading. Standard size 4x5. No Extras. Get your plates anywhere.

Send at once for our free "ADLAKE CAMERA BOOK." That tells all about it. Sample mounted photograph, 5c.

COMPLETE WITH 12 METAL  
PLATE HOLDERS. Prepaid to any  
part of the United States for

**\$12.00**

The Adams & Westlake Company  
122 ONTARIO ST., CHICAGO.

New England Agents; Andrew J. Lloyd & Co., Boston.

## ANIMATED PICTURES

FOR HOME AMUSEMENT, CHURCH OR  
SOCIETY ENTERTAINMENTS

The only projecting apparatus ever offered at a low price that will give in perfection this latest and most popular form of amusement, pictures life-size and life-like in movement. Can be easily operated and is ready for immediate use, with powerful lamp, continuous films, and screen. *Send for descriptive circular.*

G. NUTTING & CO., 83 Nassau St., N. Y.

### CYCLING PROVERBS.

Strong language never filled a tire.  
Better a cycle to-day than a brougham  
to-morrow.

Never talk as if you had swallowed an  
inflator.

Give your tongue more holiday than  
your legs.

A bicycle and health are man's best  
wealth.

The good cyclist is known in bad weath-  
er.

Women are the poetry of the wheel;  
men the prose.

Is there not a guide, a farmer, or some  
one else who has done you a good turn, and  
whom you would like to reward? Then  
give him a yearly subscription to RECREA-  
TION, as a Christmas present.

# Trigestia

In this preparation are combined the rem-  
edies which above all others have been  
established as invaluable in the treatment of  
the various forms of digestive disorders—  
Pepsin, Bismuth, and Nux Vomica. The  
Pepsin used is concentrated and of the  
highest digestive power. The Bismuth is  
the purest the market affords. The Nux  
Vomica is the best English extract. The  
efficacy of this combination lies in its triple  
effect—that of the actual solvent action of  
the Pepsin on all articles of food, the preven-  
tion of fermentation and formation of gases  
by the Bismuth, and the stimulant effect of  
the Nux Vomica (which is undoubtedly the  
best-known tonic for nervous dyspepsia) on  
the secretion of the digestive fluids.

A Remedy for Dyspepsia, Indigestion, Headache,  
Heartburn, and Sour Stomach

Will Restore Rosy Cheeks, Elastic Step,  
and Happy Spirits

PRICE, 25 and 50 cents PER BOTTLE, POSTPAID

A. J. DITMAN, Chemist

2 Barclay Street, New York

Mr. J. H. MELROSE, Manager.

Dear Sir:--I am in receipt of your remittance of \$12.00 and beg to thank you for the same. I must say that in all my experience I never saw anything to equal your work, and I feel I shall never be able to repay you for your kindness in giving me such pleasant employment.

I am very respectfully yours,  
A. HARRIS, 2620 P Street, Washington, D. C.

Mr. J. H. MELROSE, Manager,  
Standard Art Manufacturing Co., New York.

Dear Sir:—I acknowledge receipt of your esteemed favor with check for \$18.00, for which please accept my sincere thanks. I am now a little over a year in your employ and must say that you have honorably fulfilled your promises and agreements in every respect. I will say that I have tried several kinds of home employment in my time, but never had much success until I took up your work. Indeed, it will be a pleasure to me to recommend your work wherever I can, feeling confident that those who engage with you will never regret it.

Yours very respectfully,

MRS. MINNIE PICARD,  
418 East 44th Street, Chicago, Ill.



# HOME WORK

## FOR MEN AND WOMEN

### \$9 TO \$18 WEEKLY

We will send work to any reliable person in any part of United States or Canada, and a written guarantee for steady employment the year round.

**EXPLANATION.**—We do a very extensive wholesale and retail business in Portraits, Religious Pictures, Artists' Supplies, and Art Novelties. We have over 5,000 agents in United States and Canada, taking orders for pictures and art novelties. We do a larger picture and art novelty business than any two houses in the Union. Our novelty pictures are in great demand. The work is very neat and fascinating.

Our employees earn from \$9.00 to \$18.00 a week, making them at their homes. Experience is not necessary.

Any one who can read can make them after a few hours' practice. If it is not convenient for you to work the whole day, you can earn \$5.00 or \$6.00 a week by working an hour or two of an evening. Another branch of our work is making Crayon Portraits. We have the latest and a very simple method. Any one who can read can learn it in a very short time and make reasonable wages at it. If you will engage with us in this line, we will instruct you, free of charge. We have several other lines of work to give out, some of which requires no experience whatever. If you wish to devote your time to something profitable, write at once for our book of instructions. It will fully explain our different lines of work, how they are done, and the price we pay for each, etc. We will send you a portrait of yourself or any friend, as a sample of our work, and also as a guide for you to go by, with all the necessary instructions, entirely free of charge. This is a bona-fide and legitimate offer. You can see (when you get our book) what we are doing and how our home work is recommended by many of New York's most prominent bankers and business houses. Address

**STANDARD ART MFG. CO., Dept. R. 142 West 23d Street, New York**

We answer all correspondence the same day as received.  
Write your name and address plainly to avoid mistakes.



**Order Flies Now.**

If you care to use the **CHATFIELD** fly this coming season, place your orders now. These are **good** flies and are sold at a fair price. Sample and particulars for 10 cents, stamps or silver.

F. G. CHATFIELD,  
Not Oswego. 49 Front St., Oswego, N. Y.

**T**HE BEST sport to be found in Florida; Creek Navigation, from the Lake Region to the Everglades.

Write, and come to  
**CARSON BROS.,** Frostproof, Florida



**LYMAN'S RIFLE SIGHTS.**

Send for 95 Page Catalogue of  
**Sights and Fine Shooting Rifles.**  
WILLIAM LYMAN, Middlefield, Conn.

**F**INE MOUNTED GAME HEADS,  
BIRDS, ETC., for sale at unheard-of prices.  
Send 10 cents for photos.  
JOHN CLAYTON, Taxidermist, Lincoln, Maine.



The Standard of  
the World.



**Dr. Jaeger's**

**SANITARY UNDERWEAR**

allows the skin to breathe freely,  
at the same time absorbing its  
exhalations, leaving the body  
dry and warm.

**Dr. Jaeger Underwear gives  
greatest warmth with the  
least weight.**

Send for Illustrated Catalogue.

Main Retail Store  
**16 W. 23d St.**  
NEW YORK

Branches | 166 Broadway  
| 248 W. 125th St.



**Popular Pease Pianos**

NEARLY 60,000 IN USE

*Unequaled  
in  
Tone*

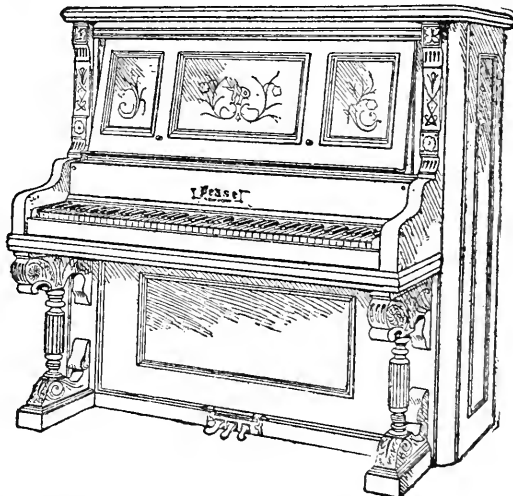

*Beautiful  
in  
Finish*

SEND FOR SOUVENIR CARD PIANO—FREE

**PEASE PIANO CO.**

316-322 West 43d Street  
New York City



CHRISTMAS EVE IN A BEAR DEN.



Don't let Whisky get the best of you!  
Get the Best of Whisky!

Which is the **Genuine Distillery**  
**Bottling of the . . .**

# Old Pepper Whisky

## And Old Henry Clay Rye

**OLD PEPPER** and **OLD HENRY CLAY** are Perfect Whiskies, and the Genuine are only bottled and distilled by **JAS. E. PEPPER & CO., Lexington, Ky.,** under the same formula for more than 100 years, is guaranteed absolutely the purest and best in the world.

**Sample Case, \$15.00, sent on trial**

which, if not perfectly satisfactory, can be returned and money will be refunded.

*Every Sportsman will Appreciate these Whiskies*

The Genuine has Patented Coupon—Read it.



HIGH JINKS ON THE SLIDE.

## Direct from Distiller to Consumer

**\$3.20**  
FOUR  
FULL QUARTS  
Express Paid.

Saving Middlemen's Profits,

Preventing Possibility of Adulteration.

We are distillers with a wide reputation of 30 years standing. We sell to consumers direct, so that our whiskey may be pure when it reaches you. Adulterated whiskey is dangerous, abominable, yet it is almost impossible to get pure whiskey from dealers. We have tens of thousands of customers who never buy elsewhere. We want more of them, and we make this offer to get them:

We will send four full quart bottles of Hayner's Seven Year Old Double Copper Distilled Rye for \$3.20, Express Prepaid. We ship in plain packages—no marks to indicate contents (which will avoid possible comment). When you get it and test it, if it isn't satisfactory return it at our expense and we will return your \$3.20. Such whiskey can not be purchased elsewhere for less than \$5.00.

We are the only distillers selling to consumers direct. Others who claim to be are dealers, buying and selling. Our whiskey has our reputation behind it.

Our References—Dun or Bradstreet, Third National Bank or any business house in Dayton.  
Hayner Distilling Co., 267 to 273 W. 5th St. Dayton, O.

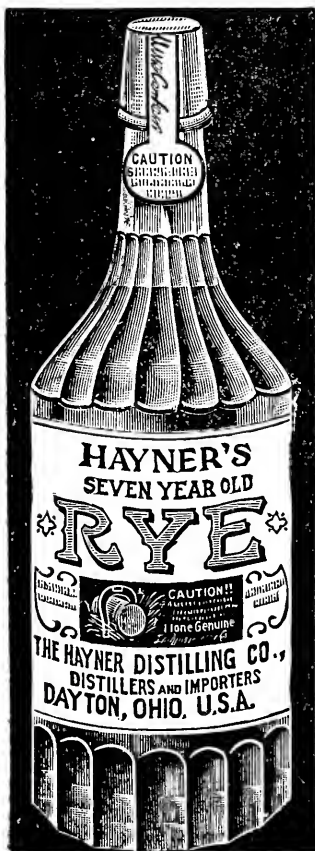

[We guarantee that the above firm will do as agreed.—EDITOR.]

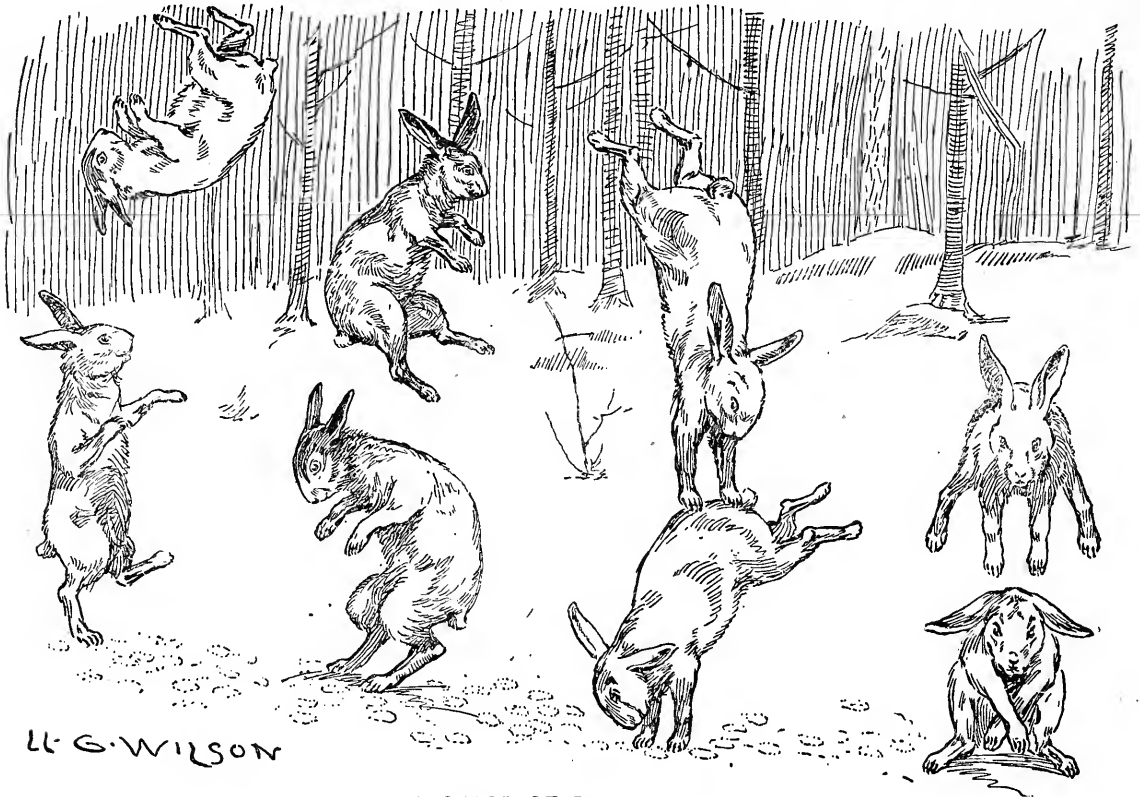

A GAME OF LEAP FROG.

FOR YOUR XMAS CANDIES

*Kuyler's*  
**BONBONS  
 CHOCOLATES**



QUALITY and FLAVOR  
 UNEXCELLED.

863 BROADWAY,  
 NEW YORK.

LARGE ASSORTMENT of IMPORTED & DOMESTIC NOVELTIES  
 in FANCY BOXES & BASKETS. suitable for

**PRESENTS.**

CANDIES SENT EVERYWHERE BY MAIL OR EXPRESS.

ORDERS CAN BE PLACED NOW FOR GOODS  
 TO BE PACKED & SHIPPED ON ANY DESIRED DATE.

MILLEN'S  STANDARD  
 Photographic Specialties

**THE NORMAL**  
 PHOTOGRAPHIC  
 DEVELOPER for Dry Plates,  
 Films and Bromide Paper

 PRODUCES the most exquisite detail  
 with good strength and printing qualities.  
 Does not stain either the plate or the  
 fingers, and may be used over and over.

 IS IN ONE solution requiring only to  
 be diluted with water to be ready for use.

 PRICE FORTY CENTS, delivered  
 to any Express Office in the United States.

Send for full descriptive circulars of our  
 Photographic Specialties

 J. C. MILLEN, M. D.,   
 Manufacturing Chemist  
 DENVER, COLORADO, U.S.A.

**THE GREAT WESTERN BRAND OF CHAMPAGNE**

MADE BY THE  
Pleasant Valley Wine Co.

OF RHEIMS, N. Y.



IS THE FINEST PRODUCTION IN AMERICA AND EQUAL TO ANY

**THERE IS HEALTH IN EVERY DROP**

FOR SALE BY ALL WINE MERCHANTS, AND  
H. B. KIRK & CO., New York S. S. PIERCE & CO., Boston

**WINSLOW'S ICE SKATES.**

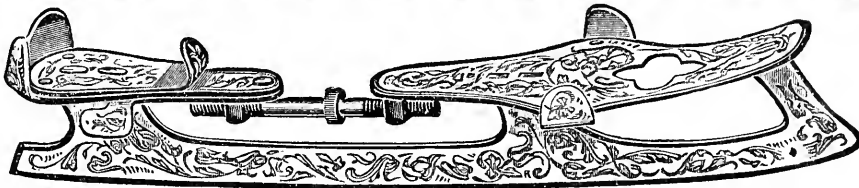

Highest Grade in the world.

Send for Free Lithographed Illustrated Catalogue

which tells you about the

**St. Nicholas Skating Club Hockey Skate**, the combined judgment of the most celebrated ice hockey players.

Also, the **St. Nicholas Skating Club Rink Skate**, which have the hardest possible runners, concaved, nickel plated. The catalogue also tells of the **National Club Skate**, the **"Antique" Speed Skate**, **Winslow's Ankle Brace** for weak ankles, and everything of interest to skaters. Send for the Catalogue, it is free and worth a postal.

Sharpen Your Own Skates. Winslow's Skate Sharpener sent postpaid for 25c.

**THE SAMUEL WINSLOW SKATE MFG. CO., Worcester, Mas.**

**Violinists** Send for Our  
**Book of OLD VIOLINS (FREE.)**  
It contains historical sketches of the old masters of Cremona and Brescia from 1540; illustrated; with fac-simile labels, also a descriptive list of old violins possessing the pure mellow tone, costing from \$25 to \$5,000. A formal Certificate of Genuineness with each violin. Several Violins sent on selection when desired.  
**LYON & HEALY, Adams & Wabash Sts., Chicago.**

PUZZLE CORNER.

HIDDEN LETTER PUZZLE.

My first is found in How, my second, sixth and seventh in Portrait, my fourth in Novelty, my third in Man, my fifth in Week and my eighth in York.

My whole is contained in 2 words that suggest a pleasing occupation.

Guess me, name the page on which I am advertised and you will get, in return, a photograph of a well known actor or actress.

Is there not a guide, a farmer, or some one else who has done you a good turn, and whom you would like to reward? Then give him a yearly subscription to RECREATION, as a Christmas present.

A Grand Upright Piano, listed at \$750, for 200 yearly subscriptions to RECREATION.

Bicycles can be rented in Canada for 50 cents a day.

A friend and I, in a day's hunt, in the Hills of Bridgeport and Addison, found game plentiful. We brought in 12 gray squirrels. The prospect for deer is good. I nearly ran into one with my wheel a few days ago.

R. F. P., Middlebury, Vt.

**A Strong Stomach will Save Your Life**  
Therefore use **Bayle's Horseradish Mustard**. All sauces are valueless as tonics, and no other condiments compare with this. Ask for it. For sale everywhere. **Geo. A. Bayle, St. Louis, Sole Maker.**

SOCIETY  
SMOKE

PACKETS  
OF TEN  
10 CENTS.



ALL  
TOBACCO  
CIGARETTES.

L. MILLER & SONS,

543 Broadway,  
NEW YORK.

U · S · A ·

Boxes of 50  
Mailed Post-Paid  
Upon receipt of 50c.

**AGENTS WANTED BOTH SEXES TO SELL RICHARDSON'S Magneto-Galvanic Batteries**

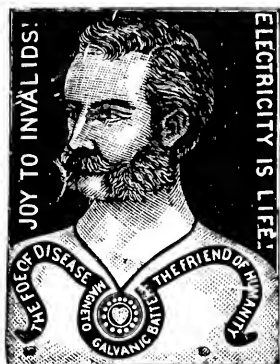

The crowning medical and scientific triumph of the 19th century. One man sold 20,000. You can do same, and also do good for suffering humanity.

Prof. Richardson's sell for only \$1.50 each, which brings within means of humblest sufferer. Five hundred thousand in daily use, which is its best endorsement.

**CURES**

*Rheumatism, Sick Headache, Liver and Kidney Complaint, Neuralgia, Gout, Lumbago, Malaria, Dyspepsia, Nervousness, Constipation, and all Blood Impurities; also every form of Female Weakness.*

*"The Blood is Life; Electricity is the Life-Giving Current."*

Sent carefully packed and by registered mail, prepaid, for \$1.50. Write for agent's circular and testimonials. Money refunded if not as represented. Address

**A. M. RICHARDSON & CO.**

Dept. B 106 W. 42d Street, N. Y. City

**Captain Jack Crawford**

Alaska Prospecting and Mining Corporation

CAPITAL STOCK \$250,000

Incorporated under New Jersey Laws.

Shares \$10 each. Full Paid. Non-assessable  
There are only 25,000 Shares

PAYABLE IN FULL AT TIME OF SUBSCRIPTION OR IN INSTALMENTS IF PREFERRED

Who has not heard of Captain Jack? An expert mining prospector and developer through all parts of the West and the Cariboo Placer Mines of British Columbia,—being one of the original discoverers of Gold in the Black Hills in 1876,—first bringing before the public the immense mineral wealth of New Mexico, and drawing capital to its development.

Loved and honored by Army men for his uprightness and integrity, high in the regard and trust of the newspaper profession, he can count among his friends most of the prominent men in the country, beginning with President McKinley.

A master pioneer; experienced, vigorous, and shrewd, he will lead and direct under this Corporation an expedition of practical and expert miners in the new Alaskan Gold fields. Mother lode claims will be taken up for this Company, to be sold at enormous profits, often without expending much capital in their development.

Stockholders can rest assured that reports from the field of operation, over Captain Jack's signature, will be authentic and trustworthy.

Write for prospectus or call for further information at the offices of the Company,

American Tract Society Building  
150 Nassau Street, New York City

Captain JACK CRAWFORD, President and Gen'l Mgr.  
General HORATIO C. KING, Vice-President.

There are no promoters' shares  
Every share issued will be paid for in cash

**A Great Offer for the Holidays**

BY GERMANIA WINE CELLARS  
Hammondsport and Rheims, N. Y.

We are determined to introduce our goods among the very best people in the country, and we can see no better way of doing this than by selling them a case of our goods, containing eleven bottles of wine and one bottle of our extra fine, double-distilled Grape Brandy, at one-half its actual cost. Upon receipt of \$5.00, we will send, to any reader of RECREATION, one case of our goods, all first class, and put up in elegant style, assorted, as follows:

- 1 Quart Bottle Grand Imperial Sec Champagne
- 1 Quart Bottle Delaware
- 1 " " Riesling
- 1 " " Tokay
- 1 " " Sweet Catawba
- 1 " " Sherry
- 1 " " Elvira
- 1 " " Niagara
- 1 " " Angellea
- 1 " " Port
- 1 " " Sweet Isabella
- 1 " " Imperial Grape Brandy



This offer is made mainly to introduce our Grand Imperial Sec Champagne and our fine double-distilled Grape Brandy, without which no Sportsman or Hunter should start on an expedition, as it is very necessary where such exercise is taken. This case of goods is offered at about one-half its actual cost and it will please us if our friends and patrons will take advantage of this and help us introduce our goods.

All orders should be in before Dec. 15.

Friend—What did you tell that sick chap to do for himself?

Christian Scientist—I told him he must shake off the idea that he was ill.

Friend—Did he agree to try it.

Christian Scientist—Yes; he said, he had chills and fever, anyway.—Cincinnati Commercial Tribune.

I am now offering a \$750 upright piano for 200 yearly subscriptions to RECREATION, at \$1 each. Here is an excellent opportunity for some energetic woman to get a high grade piano for a few days' work. In any city of 5,000 inhabitants, or more, a club of this size can be enrolled in a week. Write for particulars.

What else can you give a man for a Christmas present that will give him so much pleasure, at so small a cost, as a yearly subscription to RECREATION?

Count that day lost  
Whose low, descending sun  
Views no poor wretch  
O'er whom thy wheel has run.  
—Cleveland Leader.

# Where to Go for Good Shooting and Fishing



The Best Game Country  
in the Mississippi Valley to-  
day is along the line of the

## IRON MOUNTAIN ROUTE

### In Missouri, Arkansas, and Louisiana

**Small Game** is very abundant, and has been shot at very little. **Deer** and **Turkeys** are plentiful, and the fishing, for black bass and other game fishes, of the very best. **This Line** also reaches, direct from **St. Louis** or **Memphis**, by double daily through car service, the famous hunting and fishing grounds on the Gulf.

#### SPECIAL FEATURES OFFERED

**Reduced Rates to Sportsmen**    **Side Tracking Cars On or Near the Grounds**  
**Hunting Cars Fully Equipped**    **Carrying Free of Dogs, Guns, and Camp Equipment**

WRITE for copy of **Ideal Hunting and Fishing Pamphlet** (descriptive and illustrated) of best locations, and other information, to Company's Agents, or to

C. G. WARNER  
Vice-President

W. B. DODDRIDGE  
General Manager  
ST. LOUIS

H. C. TOWNSEND  
General Passenger and Ticket Agent

## Some Rare Opportunities

...YOU CAN GET...

- A \$75 Bicycle for 75 yearly subscriptions to *Recreation*.
- A \$35 Hammerless Breech-Loading Shot Gun for 35 yearly subscriptions.
- A \$25 Camera for 25 subscriptions.
- A \$20 Gold Watch for 20 subscriptions.
- A \$14 Repeating Rifle for 20 subscriptions.
- A Good Single Barrel Shot Gun for 15 subscriptions.
- A Single Shot Rifle, or
- A Bristol Steel Fishing Rod, or
- An Automatic Reel, or
- A Kenwood Sleeping Bag  
For 10 subscriptions.

WHY DON'T YOU GET THEM?

Write for premium list and sample copies of RECREATION

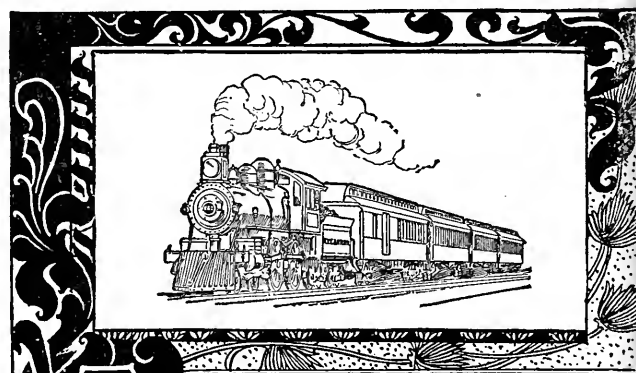

## THIS IS THE EMPIRE STATE EXPRESS.

About which all know, more or less;  
It runs from New York to Buffalo,  
Every day in the week, but Sunday, you know;  
At a speed so great,  
Through the Empire State,  
As to earn for its line  
The title sublime ---- of

"AMERICA'S GREATEST RAILROAD."

"The New York Central leads the world"

Leslie's Weekly.



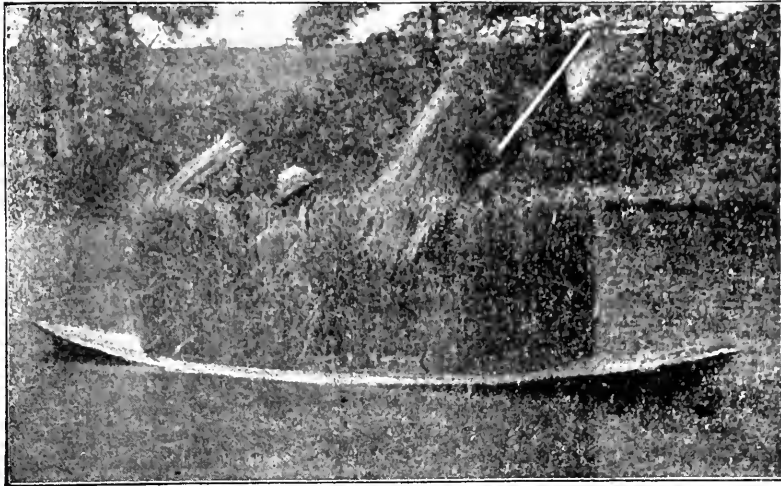

Place your order at once for a Mullins' "Get There" Safety Ducking Boat.

Orders filled promptly now—may be delayed later on, as stock is rapidly going down. The "Get There," made in Galvanized steel; price

## Twenty Dollars Net

is the best boat for the money on the market. No repairs. Always ready. Will last a lifetime.

Catalogue, with sizes, weights, and full description, will be sent to you on application.

Let us hear from you.

W. H. MULLINS

228 Depot Street, Salem, Ohio

# You Want a Canvas Folding Boat Or None

Any other kind is "A step backward." It's as practicable, subject to infinitely less strain per square inch, wears longer, and is easier mended than a pneumatic bicycle tire. It's the only kind in which **Compactness** or **Lightness** is possible; in short, it's the only kind worth considering. Ours are best. Perfect in construction. Equal in model to the finest wooden craft. Fifteen styles to select from.

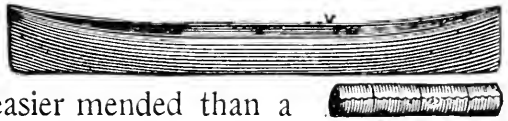

Send NOW for our catalogue, which, with a special offer we will make, may interest you

ACME FOLDING BOAT CO., Miamisburg, Ohio

ESTABLISHED 1875  
TELEPHONE 2591

ELLWOOD E. HUEBNER

15 John R Street  
DETROIT, MICH.

# FURS

PRACTICAL  
FURRIER and  
DESIGNER

FASHIONS LATEST  
PRICES LOWEST  
PERSONAL ATTENTION  
TO ALL ORDERS  
WORK GUARANTEED

Write for prices      Mention RECREATION

BUILT FOR UTILITY.

"Madge says she can never hold up her head in public again."

"What has chagrined her so?"

"Why, it became known that when we had that lake disaster, she bailed out the boat with her shoe."

Send me \$1.50 for RECREATION one year and Mr. W. T. Hornaday's great book, "The Man Who Became Savage." The book alone sells at \$1.50 in the stores. Renewals are included in this offer.

An Australian Mosquito-Proof Tent for 10, 15 or 25 subscriptions to RECREATION—according to size of tent. Send for circular. This tent is light, compact, waterproof and *insect-proof*.

I received the Willsie pocket camera and thank you very much for same. It is a dandy.  
George Kalmbach, Shreveport, La.

Received the Bristol rod. Please accept my thanks for same. Am very much pleased with it.  
J. Prentiss, Valentine, Neb.

I have received my camera, and it is a beauty. I am very well satisfied and thank you very much for your kindness, and promptness in doing business. I shall continue hustling for you.  
Arthur Dorman, Sioux City, Ia.

The Marlin rifle you sent me as a premium shoots well. I like it better every time I use it.  
Albert K. Mueller, Cleveland, O.



**Highest  
Award  
WORLD'S  
FAIR.**

**SKATES**

**CATALOGUE FREE.**

**BARNEY & BERRY, Springfield, Mass.**

IT SAVES DOLLARS

Our **Annual Catalogue** no. 49

Will come from the printer about October 20th. 120 pages, 9 x 12. We illustrate 200 and odd styles of watches; 30 pages are devoted to "Sterling Silver for Table and Toilet"; Rings require 14 pages to show our assortment, etc., etc. No reader of RECREATION, expecting to buy goods in our line, can afford to be without it. Sent **FREE** upon request.

**J. U. Ridgway & Co.** MANUFACTURING  
TRADE JEWELERS  
167 Dearborn Street, CHICAGO, ILL.

Mention RECREATION.

FROM THE WIND RIVER COUNTRY.

Captain Hiram W. Chittenden, U. S. A. Engineer Corps, of St. Louis, recently returned from an outing in the Wind river mountains, Shoshone reservation and Jackson Hole, Wyo. He reports some splendid trout fishing.

On every hand, he said, the skeletons of elk and deer gave evidence of the severe weather last winter.

A party of 4 hunters from Iowa, just returning from Hahn's Peak, Col., reports game plentiful in that section. The hunting grounds can easily be reached by wagon from Rawlins, Wyo. This party said trout fishing there was a disappointment. The hide of a monster grizzly was one of their trophies.

An Englishman named Nelson, having in his employ 3 hunters and trappers, with complete outfit, is now hunting in the Northern part of the Saw-Tooth mountains, in Idaho, for heads to adorn his home in England. Two pack horse loads of bear traps was a part of his outfit.

In making up your list of Christmas presents put down a yearly subscription to RECREATION, for each of your best friends.

L. L. Bates, General Delivery, Seattle, Wash., offers his services as guide for hunting, exploring, and prospecting parties in Alaska. He has lived in that Territory 8 years, has travelled many thousands of miles through the interior, and is prepared to give accurate and reliable information concerning it.

References: Lieut. G. T. Emmons, U. S. Navy, Naval Dept., Washington, D. C.; Will D. Jenkins, Secretary of State, Olympia, Wash., and the editor of RECREATION.

Correspondence promptly answered. Will return to Alaska in March, '98.

About December 20, I expect to kill one of the largest and finest buffaloes in the United States, and dispose of the meat for the Christmas holidays. The head and hide will also be for sale. The purchaser of the head (whoever he may be) can have the privilege of killing the animal. The buffalo has been fattened on his natural food (buffalo grass) and is fat and fine. His coat is in the best condition, and he has an exceedingly large, fine head. This is a chance to obtain some royal game that is now almost extinct; and those who wish to secure some, should write at once. Address Chas. Payne, Box 913, Wichita, Kan.

**For Sale:** A vertical steam engine, 3 x 4, 2 to 3 horse power, in first-class condition. A side feed lubricator. Also a 30 foot belt, 3 inches wide, all complete. Cost \$75. Will sell at \$45; or will trade for a 12 gauge hammerless gun, of equal value. Or will take a 12 gauge Winchester repeating shot gun as part payment; or a first class setter or pointer.

George Burkhardt,  
14 Baitz Avenue, Buffalo, N. Y.

**Wanted,** for cash, or good exchange, 22 calibre rifles, single or double B. L. shot guns, and second-hand tents; camping and fishing outfits. Hunting goods. Write if you have anything to sell or trade. Dougherty & Page, Muscatine, Ia.

**Pheasants, Call Ducks, Etc.**

**Prices Reduced.** Golden, Silver, Reeves, Versicolor, Lady Amherst, Swinhoe, Peacock, and Ringneck Pheasants; also White Call. Mandarin and Wood Ducks for sale.

**JAMES MORRISON**  
Mr. Schieffelin's Place, Tarrytown, N. Y.

**To Exchange:** Fine 40-70-330 Ballard rifle, with complete reloading outfit; for a hand camera.

E. F. Pope, Colmesneil, Tex.

**LITTLE GIANT TYPEWRITER** Price \$100  
 INTERCHANGEABLE TYPE PLATES. WILL WRITE IN BOOK, ON PAPER, PACKAGE, ANYTHING. Send for Circular

ADJUSTABLE FEED. WILL WRITE ON THE SIDE OF A HOUSE. FOR SALE IN STATIONARY AND DEPARTMENT STORES. SENT BY MAIL OR EXPRESS ON RECEIPT OF \$1.15

Simplex Typewriter Co. 26 East 13th St. New York

**ASHLAND HOUSE** FOURTH AVE. and 24th ST.  
 Two blocks from Madison Sq. Garden  
 ...HEADQUARTERS FOR SPORTSMEN

American and European Plan

**RATES:**

|                       |                           |          |
|-----------------------|---------------------------|----------|
| Rooms, with board,    | \$2.00, \$2.50 and \$3.00 | per day  |
| Rooms, without board, | \$1.00 and upwards        |          |
| Breakfast,            |                           | 75 cents |
| Lunch,                |                           | 50 "     |
| Table d' Hote Dinner, |                           | 75 "     |

**How to See the Point and Place It:**

Punctuation Without Rules of Grammar.

A book of forty pages which teaches punctuation rapidly by example. Many people who have studied English, Latin and Greek Grammar are very careless and slovenly punctuators. This book is indispensable to all writers. Memorizing rules and exceptions wastes time and they are soon forgotten.

By mail, 20 cents. **LACONIC PUBLISHING CO.,** 123 Liberty St., New York.

**PLAYS** and other Entertainment Books  
 Send for 120-page catalogue free. Dramatic Publishing Co., Chicago

**KAREZZA** ETHICS OF MARRIAGE.

A bold, brave book teaching ideal marriage, rights of the unborn child, a designed and controlled maternity. Union Signal: Thousands of women have blessed Dr. Stockham for Tokology, thousands of men and women will bless her for Karezza.

Arena: Karezza is worth its weight in gold. Sample pages free. Agents Wanted. Prepaid \$1.00. **ALICE B. STOCKHAM & CO., 277 MADISON ST., CHICAGO.**

**TRY IT FREE**  
 for 30 days in your own home and save \$10 to \$25. No money in advance.  
 \$60 Kenwood Machine for \$23.00  
 \$50 Arlington Machine for \$19.50  
 Singers (Made by us) \$8, \$11.50, \$15 and 27 other styles. All attachments FREE. We pay freight. Buy from factory. Save agents large profits. Over 100,000 in use. Catalogue and testimonials Free. Write at once. Address (in full), **CASH BUYERS' UNION** 158-164 West Van Buren St., B559 Chicago, Ill.

High Arm  
 Warranted Ten Years.

Send me \$1.50 for RECREATION one year and Mr. W. T. Hornaday's great book, "The Man Who Became a Savage." The book alone sells at \$1.50 in the stores. Renewals are included in this offer.

There are still some unfortunate sportsmen who are not readers of RECREATION. If you know any such send in their names, and greatly oblige them and

THE EDITOR.

**For Sale:** Living wild animals and game, for scientific and propagating purposes. Elk, deer, jack rabbits, quail, etc.  
 Chas. Payne, Wichita, Kan.

Do you read or write?  
 If so, do your eyes ever get tired?  
 Then you need the services of an Oculist  
**GALL & LEMBKE** 22 Union Square New York  
 will fit you with a pair of glasses so perfectly that you will scarcely know you have them on.  
 Ten per cent. discount to all readers of RECREATION. Mention this magazine when you call.

**ALASKAN VIEWS**

Take a look at the country, and the methods of travel, before you start for the gold fields.

A full series of views of Juneau, Dyea, Skaguay, Chilkat Pass, Miners and outfits, along the route, etc.

50 cents each. An assorted doz. \$5.00

**GEO. G. CANTWELL, Taxidermist, Juneau, Alaska.**

**WANTED.**—LIVE ELK, MOOSE, CARIBOU, BLACK-tail deer, wild turkey, European roebucks, fallow deer, etc., for Litchfield Park, Adirondacks. Address, with particulars, **EDWARD H. LITCHFIELD, 59 Wall Street, New York.**

**Blair's Pills**  
 Great English Remedy for **GOUT and RHEUMATISM.**  
 SAFE, SURE, EFFECTIVE.  
 Druggists, or 224 William St., New York.

IN ANSWERING ADS, IF YOU WILL KINDLY MENTION RECREATION YOU WILL GREATLY OBLIGE THE EDITOR

## TAXIDERMIST AND SCULPTOR



**GEO. H. STORCK**  
123 FIFTH AVENUE, NEW YORK

### HIGH ART IN TAXIDERMISTRY

I have, by my new method of mounting animals, by combining Sculptury with Taxidermy, obtained results that by no other method have ever been attained.

**J. B. CROOK & CO.** Established 1837

1180 Broadway, Cor. 28th Street

Manufacturers and Importers of NEW YORK CITY, U. S. A.

HIGHEST GRADE **FISHING TACKLE** HIGHEST GRADE

SPECIALTIES FOR 1897

**Featherweight Rods, Aluminum Reels  
Trout and Salmon Flies**

The only Waterproof Fly Lines: The London Black or Trout, Salmon, and Black Bass.  
Send 7 cents for catalogue. Mention RECREATION.

**A Practical Common Sense Camp Stove.**

In 6 Sizes. Patent applied for.

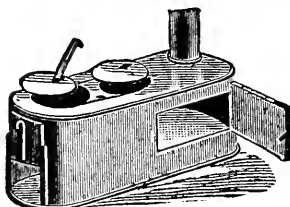

Burns largest wood, keeps fire longest of any stove made. For full particulars address

D. W. CREE, Manufacturer, Griggsville, Ill.

## Taxidermists' Supplies

WHEN you get a good specimen of bird, fish, mammal etc., that you would like to get mounted, send it to us. We will do it right and also make the price right.

Send five cents for new 'Taxidermists' Catalogue.

Artificial  
Glass Eyes

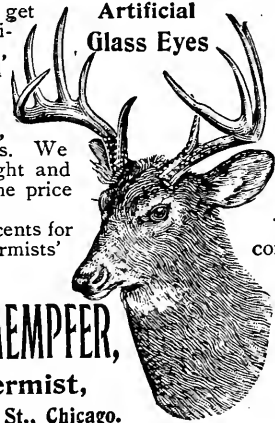

WE prepare and mount all specimens of natural history true to nature, in the best style of the Taxidermist's art, at reasonable prices.

We also keep a complete line of

**Oologists' and Entomologists' Supplies**

**FRED. KAEMPFER,**  
Taxidermist,  
217 Madison St., Chicago.

## Sportsmen, Hunters

Get your hunting trophies mounted true to nature, at Prof. G. Stainsky's Institute of Scientific Taxidermy, 1180 Cascade Avenue, Colorado Springs, Colo.

Dealer in Game Heads, Fur Rugs, Robes, Navajo Blankets, Horn Chairs, etc.

Medals awarded at  
World's Columbian Exposition, Paris, Vienna and Berlin

GAME HEADS AND RAW FURS BOUGHT



Ernest L. Brown  
The Minnesota  
Taxidermist

Does true and artistic work at reasonable figures.

WARREN, MINN.

## Moosehide Moccasins & Slippers

METZ & SCHLOERB, Oshkosh, Wis.

PRICE: MEN'S - - - \$2.75  
LADIES' AND BOYS' 2.25

Sent, prepaid, on receipt of price.

Write for our illustrated circular and price-list of hand made hunting shoes and moccasins of every description.

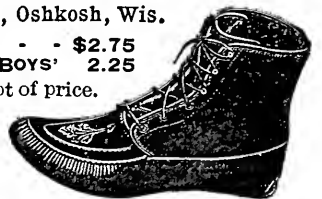

## BROOK TROUT

We have a large number of extra fine yearling trout for sale at **Extremely Low Prices.** For particulars address

**The Blue Hills Trout Preserve Co.**  
Box 1373 MERIDEN, CONN.



# THIS FRIENDLY FACE

is PLEASED to ANNOUNCE to  
**ALL SHOOTERS**  
 of RIFLES, PISTOLS or SHOT GUNS  
 that the **Ideal Hand-Book No. 9** is just out. 116 pages of solid in-formation about Nitro, Smokeless and Black Powders, how to use them in various arms to get the best results. It is the recognized authority on all matters relating to Shooting. You can't afford to be without it. Mailed to any part of the world. Your address with two 2 cent stamps to **IDEAL MANUFACTURING CO., New Haven, Conn., U.S.A.**  
 WHEN YOU WRITE KINDLY MENTION "RECREATION"

Sectional View

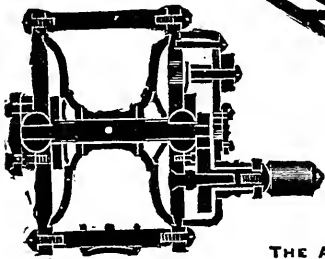

Globe Bearing.



Don't believe imitators of "**HENDRYX**" standard goods when they say their Fishing Reels "are **NOW** as good as **HENDRYX**". The fact that they imitate proves the "**HENDRYX**" is the recognized standard line of Fishing Reels. Ask your dealer for them.

THE ANDREW B. HENDRYX CO., NEW HAVEN, CONN., U. S. A.

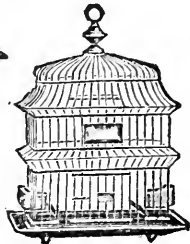

This is a picture of Sewell Newhouse, inventor of the celebrated

## NEWHOUSE STEEL TRAPS

known the world over as the best traps made for catching fur-bearing animals. Send to

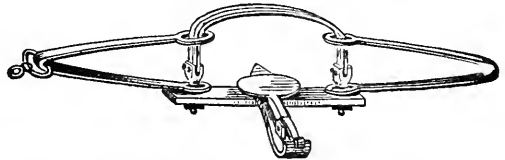

**ONEIDA COMMUNITY, Ltd., Kenwood, N. Y.**

for catalogs, prices and discounts.

# RUPTURE ABSOLUTELY CURED . . . . .

My method of treatment is known only to myself, and I object to long letters explanatory thereof. An interview is positively necessary for those requiring information.

Complete cure effected in 6 to 8 weeks; one treatment each week, with no detention whatever from business.

## SAGREDO

Care F. C. PRESTON, 98 Hudson Street, New York

**Web Snow Shoes:** Made of best raw caribou skin, and the best hickory that grows.

Thongs thoroughly twisted and carefully woven. I make the best snow-shoe in the market. They look well, wear well, hang well and will not bag, in wet snow.

A. M. Dunham, Norway, Me.

**For Sale:** Twelve gauge hammer shot gun \$10; bethbara, agate mounted trolling or salt-water rod, \$12 (usual price \$25). Other G. S. mounted rods for \$3 and \$5. Opera glasses \$2. Might exchange for good rifle, ladies' gold watch or hammerless gun.

M. L. Miner,  
 124 Rockaway Avenue, Brooklyn, N. Y.



# FOURTH ANNUAL Sportsmen's Exposition and Bicycle Show, Madison Square Garden, New York,

UNDER THE AUSPICES OF THE  
National  
Sportsmen's Association.

JANUARY 13 to 22, 1898.

Educational Exhibit of Sportsmen's Equipments and Appliances.  
Bicycles and Bicycle Sundries. Fly Casting, Shooting,  
Bowling and other Contests. Live Specimens of  
Wild Game, Birds and Fish.

Apply at once for diagrams, application blanks, and particulars, to

SECRETARY,  
P. O. Box 2325, N. Y. City, or  
377 Broadway.

FRANK W. SANGER,  
Manager Madison Square Garden Co.,  
New York.

**SPECIAL NOTICE.**—For \$2.00 any gentleman may become a member of the NATIONAL SPORTSMEN'S ASSOCIATION, membership entitling him to free admission to the Sportsmen's Exposition, reduced rates at Association hotels, one year's subscription to the Official Bulletin, and other privileges, which can be learned of by addressing the Sportsmen's Association, P. O. Box 2325, N. Y. City, for application blank and prospectus.

## SOME GOOD GUIDES.

### FLORIDA.

C. L. Farnham, Avon Park, bear, deer, turkeys, quails, ducks, black bass, etc.  
Oliver Tinny, Ozone, Hillsboro Co., deer, bear, turkeys, quails, ducks and salt-water fishing.  
E. M. Reynolds, Fort Myers, ditto  
Wm. Webb, Osprey, Manatee Co., "  
Frank Guptill, Osprey, Manatee Co., "  
W. J. Meyer, Tarpon Springs, "  
Frank Carson, Ft. Meyers, "  
E. T. Robinson, Keuka, "  
Carson Bros., Frostproof, "  
J. L. Sandlin, Punta Gorda, "  
Oliver Archer, Clearwater, "  
L. W. Scroggins, Homeland, "  
Capt. Jas. Argo, Oviedo, "  
F. J. Adams, Sanford, "  
C. B. Bailey, Winter Haven, "  
W. H. Steacy, Pt. Tampa City, "  
Wm. J. Lyon, Interlacken, "  
L. L. Sutton, Sutherland, "  
M. B. Carson, Frost Proof, Polk Co., "  
W. D. Isler, Eagle Lake, "  
George W. Hawthorn, Hawthorn, "  
C. H. Hill, Maitland, "  
J. E. Bowen, Laughman, "  
Morgan Bass, Kissimmee, "  
B. C. Lanier, Leesburg, "  
John Hunter, Winter Park, "

H. Shipman, Haskell, deer, bear, turkeys, quails, ducks and salt-water fishing.

Robert James, Emporia, ditto  
Alex. Brown, Martin, "  
W. J. McCullough, Boardman, "  
Frank Smith, St. James City, "  
Jinks McCreary, Higly, "  
Baldwin Cassady, Lisbon, "  
W. H. Howell, Centre Hill, "  
Ed. Brown, Dunedin, "  
G. B. Lawson, Lake Maitland, "  
J. H. Maddox, Wauchula, "  
Will Montgomery, Arcadia, "  
T. E. Fielder, Calvinia, "  
W. F. Hays, Webster, "  
John Beidler, Gabrielle, "

### NORTH CAROLINA.

Fenner S. Jarvis, Haslin P. O., deer, bear, turkeys and quails.  
Robert Waterfield, Knotts Island, ditto  
Jas. Tooly, Belleport, "  
W. C. Halsted, Currituck C. H., deer, turkeys, quails, ducks, salt-water fishing.  
Fred. Latham, Haslin, ditto

### VIRGINIA.

M. Corbel, Virginia Beach, geese, brant, ducks, shore birds, quails, salt-water fishing.  
Captain R. E. Miles, Machipongo, ditto  
C. A. Spencer, Buckingham, "  
M. A. Earner, Clarksville, "

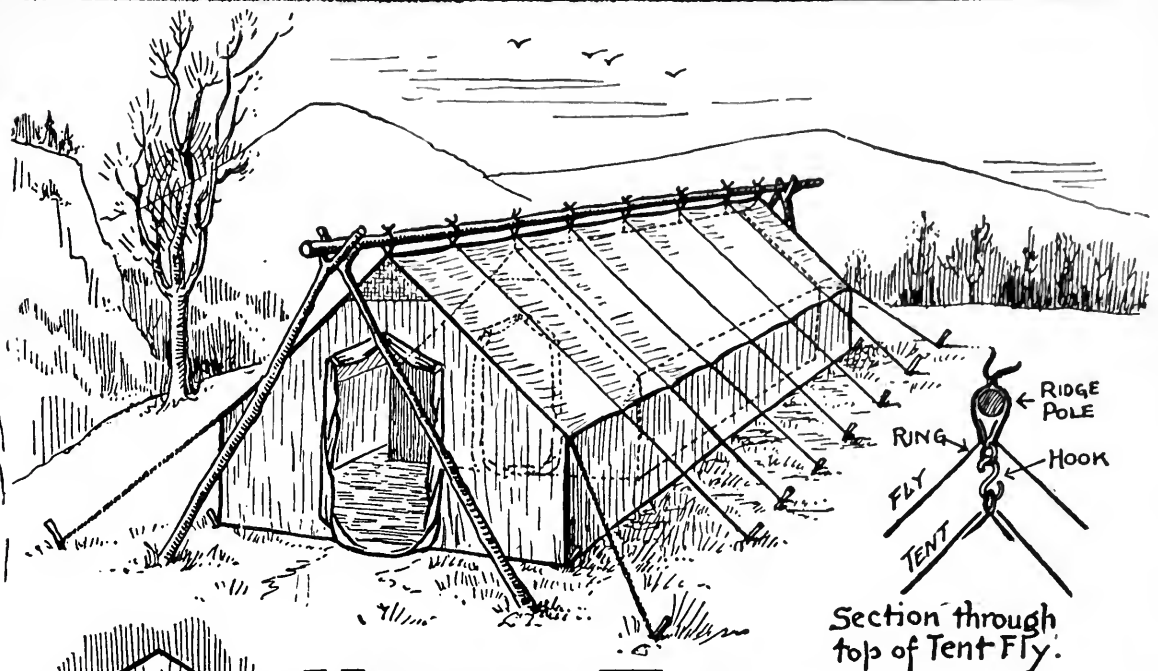

Section through top of Tent Fly.

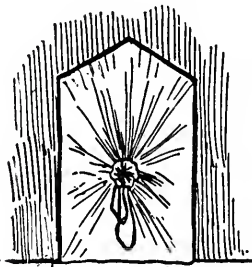

Doorway Closed.

MOSQUITO-PROOF COLD  
**KLONDIKE TENT**  
 WIND and WATER-PROOF

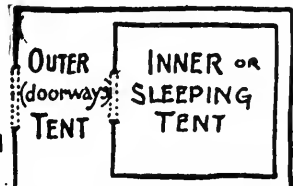

Ground Plan of Tents.

In the above diagram the dotted lines indicate the position of the inner or sleeping tent, within the outer or storm tent.

**PETROFF** says (speaking of Alaska)—*There is a feature in this country which, though insignificant on paper, is to the traveler the most terrible and poignant infliction he can be called upon to bear in a new land. I refer to the clouds of bloodthirsty mosquitoes, accompanied by a vindictive ally in the shape of a small poisonous black fly, under the stress of whose persecution the strongest man with the firmest will must either feel depressed or succumb to low fever. Language is simply unable to portray the misery and annoyance accompanying their presence.*

**DR. FOSS** (132 COURT ST., BOSTON), after using one of our Tents in mosquito and midge infected country says, "Your Tent is absolutely perfection, not a skid or midge could invade our privacy, and at daybreak, when they get in their most deadly work on man, we could lie in peace and defy them." So much for mosquitoes, now as to

**COLD** By means of one of the now famous PRIMUS Stoves (weight 2 lbs.) the temperature of the inner or sleeping Tent may be kept comfortably warm in the very coldest weather. It gives off neither smoke nor smell, hence needs no chimney.

**DR. NANSEN** enthusiastically of it: "We took with us rather more than four gallons of petroleum for the PRIMUS, and this quantity lasted us 120 days, enabling us to cook two hot meals per day and melt an abundance of water."

With a Klondike Tent and a Primus Stove, the two worst evils of the Klondike may be defied, and life, otherwise a misery, made comfortable.

**PRICE:** A 12 x 10½ Tent, with a 7½ x 7½ inner chamber, accommodating from 3 to 5 sleepers—weighing about 25 lbs.—will be supplied at \$20.50; larger tents, or tents of heavier material (which we do not advise), at proportionate prices. **\$25**

IF INTERESTED PLEASE CORRESPOND WITH

**MOSQUITO-PROOF TENT Co.**  
 Successors to T. W. HICKSON

OFFICES  
 433-434 AND 450  
 BOWLING GREEN BLDG.  
 BROADWAY,  
 NEW YORK, U.S.A.

MANUFACTURERS OF UP-TO-DATE TENTS AND TENTING EQUIPMENTS

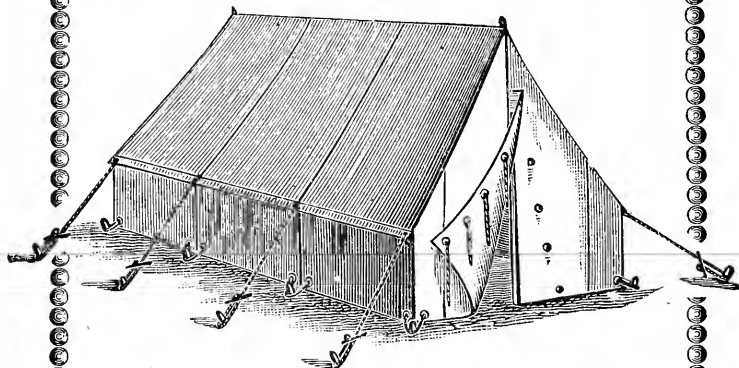

Every  
Sportsman  
Should  
Have a

# WATER-PROOF TENT

A camper knows the advantages of a tent that is an absolute protection against rain and dampness. We secure this advantage by **OUR** water-proof **PROCESS** and avoid the extra bulk and weight of a fly.

We make tents of all sizes, shapes and materials, suited to the needs of hunters, campers, travellers, canoeists; also

## Water-Proof Sleeping Bags

**CANVAS BUCKETS, AMMUNITION, PROVISION,  
CLOTHING AND SADDLE BAGS, POUCHES,  
PACKS, BICYCLE COVERS, FLOOR CLOTHS,  
and many other Canvas Specialties**

**Our Sleeping Bag** is unique, excellent in pattern and finish, and has been highly approved.

SEND FOR CIRCULAR R, SAMPLES OF MATERIALS AND PRICE-LIST TO

# DERBY, ABERCROMBIE & CO.

36 South Street, New York



# KENWOOD SLEEPING-BAGS

are right for every possible condition  
of climate or weather found from

## Alaska to Mexico

Members of the Peary expedition have them. Professor Libbey, of Princeton College, used one while exploring in Mexico. Many mem-



bers of the noted Mazamas Society of mountain-climbers used them in their ascent of Mount Rainier. Hundreds of Klondike gold-seekers have already purchased the Kenwood Sleeping-Bag, and sportsmen everywhere know them well.

Consists of outside water-proof, wind-proof canvas cover, a thick, warm, seamless, woolen bag, and a soft, fine, seamless, woolen inner bag. Used separately or together.

**Price, \$6.00 to \$16.00.**

Lighter, warmer, more durable, and more convenient than any other form of covering.

**The Kenwood Storm-hood** used with the bags or without them, will be found a great comfort and a perfect protection against cold and wind.

**The Kenwood Hunting-cape** is particularly suitable for this season. It is an ideal garment for the sportsman. Unusual warmth with lightness and perfect freedom of motion.

*Every Camper, Hunter, Angler, Prospector, or Military Man should send for our samples and FREE illustrated circular about these articles.*

**THE KENWOOD MILLS, - - Albany, N. Y.**

Copyrighted 1897, by Woman's World Pub. Co. Beware, imitations are illegal and infringements.

# \$20 for Every Answer

IF FULL AND CORRECT AS PER CONDITIONS PRINTED BELOW.

## CAN YOU FILL OUT THE MISSING LETTERS?



\*\*\*\*\*  
**A \* \* \* \* \* L \* N C \* L N**  
\*\*\*\*\*

**YOU ARE TO MAKE WORDS** that apply clearly to the picture printed at the left of this paragraph. You are to allow the letters A, L, N, C, L and N to stand as they are placed, but supply letters in places of stars so as to make full answer that fits the picture. We furthermore state that the complete solution can be found in this advertisement.

### Twenty Dollars for Your Answer!

The Picture represents the face of a famous man who was killed by an assassin. Somewhere in this advertisement you will find words that fit so as to enable you to give the answer. Our great idea is to induce you to read every word of our advertisement so that you will learn all about our **Charming Magazine, WOMAN'S WORLD,** which we intend shall attain the highest circulation ever reached by any publication. From the day of Abraham of biblical fame, until the present date, there has been no commercial enterprise of such character that has attracted so much attention. It was Columbus that discovered this country, and the publishers of **WOMAN'S WORLD** have discovered the art of pleasing the people of this country.

By the marvelous reward of **\$20.00** for every **COMPLETE SOLUTION** to the above "missing letters" riddle, we mean exactly what we say. Make no mistake, you needn't bother to search any encyclopaedia or dictionary, you will find the applicable words in this advertisement. In making words, go by the letters that appear, and put letters in place of stars. **AS WASHINGTON WAS AHEAD OF LINCOLN** so are we ahead of our imitators as America's Triumphant Literary Leaders. In searching for the words that will properly fill the requirements you will find the letters of each word appear consecutively to make a word applicable to the picture of the man, and the complete answer is so clear and comprehensible that you cannot raise any question of doubt.

**WE PAY \$20.00 IN MONEY** Now respected reader, all you need do is to study this advertisement and win the **\$20.00**. We have the cash capital and are prepared to pay out **\$200,000** to winners. We only ask you to allow us to publish in **WOMAN'S WORLD** that we have paid you **\$20.00**, and we also want you to answer the letters of sceptical people who may write and ask you if you have really won the money. We also request that you keep your answer a secret after you have won as it would not be fair to tell

**SURE CASH AND NO TRASH.**

others. **THIS RIDDLE IS THE BEST** ever printed as you can solve it to a mathematical or alphabetical certainty. It is as certain as the fact that 100 cents make a dollar. We will pay you by bank cheque, money order or cash in registered letter. It makes no difference whether you are man, woman or child, you are allowed to answer and we will ask not your age. You must send 25 cents with your reply to pay for **WOMAN'S WORLD** three months on trial. If you are already a subscriber notify us in your letter and we will continue your subscription from present limit. **WE ARE THE ORIGINATORS** of "Missing Letters" advertisements and our offers are being imitated by many frauds. We are thoroughly reliable and will return your subscription money instantly if you are not well satisfied. **THE CORRECT ANSWERS** are sealed in an envelope and deposited in the great Nassau National Bank. Cash prizes of \$20 will be promptly paid. How can we pay such prizes you ask! We can do it because we want to vastly increase our circulation, after which we can get high rates for advertising medicines, soaps, dry goods, etc.

### Money Will Be Sent You Promptly

You Must Send 25 Cents With your answer or it will be thrown in the waste basket. As to our reliability write to C. E. Ellis, Temple Court, New York, Clarke's Bank, 154 Nassau St., New York, H. B. Humphrey, 45 Milk St., Boston, N. Chesman & Co., 125 Franklin St., Chicago, C. H. Fuller's Advertising Bureau, Ellicott Sq., Buffalo, N. Y., or any publisher in America. The picture at the right shows the **WOMAN'S WORLD** establishment. We are financially as solid as the granite in the building. Send your answer with 25 cents silver carefully wrapped, or 26 one-cent stamps to

**WOMAN'S WORLD PUB. CO.,**

22-24 North William St., New York, N. Y.

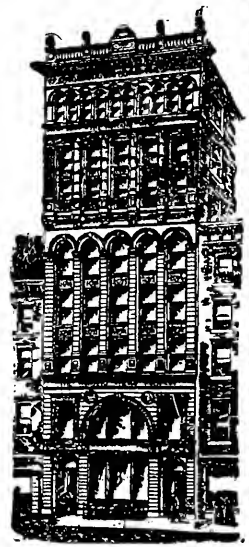

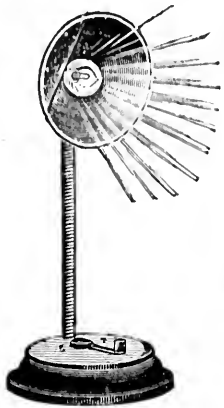

Battery Table Lamp  
\$2.75 complete.

## The 4 Leading Electric Novelties



Necktie Light.



Dollar Motor.

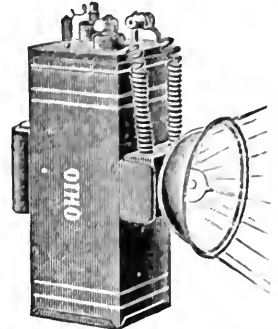

\$6.00 Bicycle Lights, \$2.50

We undersell all on Everything Electrical  
**OHIO ELECTRIC WORKS, CLEVELAND, O.**  
HEADQUARTERS FOR ELECTRIC NOVELTIES  
AGENTS WANTED

SEND FOR 1898 CATALOGUE, JUST OUT

... A BOX OF ...

### "Ensign Stogie Cigars"

Looks Like this;



They Cost **\$2.00** } Per Box of 100 Delivered.  
Light or Dark Color, as you wish.

They contain no Drugs or Artificial Flavor whatever; only PURE TOBACCO, CAREFULLY SELECTED. You will find them a SMOOTH, WELL-MADE, MILD CIGAR, in the Stogie shape, and REASONABLE IN PRICE.

If they don't suit you, let us know what is wrong with them, and we will return your money, no matter whether you have smoked one cigar or the whole box.

Sample box of 25 mailed on receipt of 60c. These are very convenient when traveling.

**Crescent Cigar Co., Wheeling, W. Va.**

**To Exchange:** Fine Maynard rifle, peep sights, Swiss butt, 32 calibre special shells, full set loading tools, 25 shells; for 28 or 30 inch 12 gauge double barrel hammerless shot gun, any good make. Must be in good condition.

W. H. Reightmyer,  
Richmondville, N. Y.

"Did you ever get even with that girl who took your job, in the office?"  
"You may judge for yourself. I married her; she holds the job, and there is only one of us that ever does a stroke of work."  
—Detroit Free Press.

### Always Bright!



**WILL  
NOT  
JAR  
OUT**

ALL RIDERS  
SAY  
IT IS  
The Best.

For Sale Everywhere.

**BRIDGEPORT BRASS CO.,**

BRIDGEPORT, Conn.

Send for Circular.

### 1897 High Grade Bicycles



for Men, Women, Girls & Boys. Complete line at lowest prices ever quoted.  
\$100 'Oakwood' for \$45.00  
\$85 'Arlington' " \$37.50  
\$55 " " \$25.00  
\$20 Bicycle " \$10.75

\$75 'Maywood' Simplest, Strongest Bicycle on Earth " \$32.00  
Fully guaranteed. Shipped anywhere C.O.D. with privilege to examine. No money in advance. Buy direct from manufacturers, save agents and dealers profits. Large illustrated catalogue free. Address (in full)  
**Cash Buyers' Union, 162 W. Van Buren St. B 359 Chicago**

## THE SPORTSMEN'S SHOW.

The Fourth Annual Sportsmen's Exhibition and Bicycle Show, which will be held in Madison Square Garden, January 13th to 22, 1898, both days inclusive, promises to be a record breaker.

The General Manager of the Exhibition is Mr. Frank W. Sanger, General Manager of the Garden. Captain J. A. H. Dressel is Secretary and Treasurer of the Sportsmen's Association, with headquarters at 377 Broadway. The Press Agent is Mr. Allen S. Williams, at Madison Square Garden.

All the arrangements for the great combined show have been completed, and the success of the exhibition of 1898 is now fully assured. When the doors of the Garden are opened, on January 13th, the public will be treated to a unique display showing the most wonderful kaleidoscopic effects of color and light, formed by the intermingling of electric lights with more sombre articles of the chase.

The uniting of sporting goods and the results of the hunter's prowess with a display of cyclist's requisites was a happy thought, and there is every indication that the resulting display will excel anything of the kind ever before produced in New York. Aside from the hunting, fishing and cycling exhibits, the management has arranged for a number of novel and decidedly attractive features, among which may be noted gymnastic displays, billiard contests and other feats of skill.

One of the most attractive features of the show will be a number of new models of the chainless bicycle, which is now the subject of so much interest in the wheeling world. In short, trappers, horsemen, anglers and sportsmen of every class, will be attracted to the Garden during these 10 days in January.

From the number of entries already received the indications are that, both in extent and novelty, the exhibits next January will surpass those of any previous year.

There is no longer a doubt as to the ultimate success of the Fourth Annual Sportsmen's Exposition, to be held in January, at Madison Square Garden. At first there was a hesitancy on the part of some of the trade to take space; but the popular feeling was too strong to withstand, and as the leaders in both the sporting goods and cycle industries have secured their positions, many of the others have followed suit. It is too early to announce the special features that will go to make this a truly great exposition, but plans are being formulated that will be sure to attract the attention of the many thousands who are interested in outdoor and in-door sports. The Committee having the Exposition in charge is leaving nothing undone toward making it a success, and within a short time the special features will be announced. Application for space, and for other information, should

be made at the office of the Sportsmen's Association, 377 Broadway.

Considering all the difficulties in the way of making a satisfactory light for the wheel, the Ohio Electric Works are certainly to be congratulated on their recent success in their 4 and 3 cell outfits. These lights cannot be jolted out; they throw a light 200 feet, and will run 4 hours on a charge costing 2 cents. The best advertisement is a satisfied customer. Here is an extract from a recent letter, received by the manufacturers:

"Your 3-cell light is fine on a dark night. It throws a light 200 feet. Every one who has seen it says it is the coming light. I cannot say too much in praise of it." Hundreds of other letters, just as strong, are on file.

This is the way users of the Ohio electric bicycle light are talking. New catalogue, for 1898, now ready. Address, Ohio Electric Works, Cleveland. Mention RECREATION.

Wm. W. Hart & Co. have recently added a great curiosity to their already fine collection of buffalo heads. It evidently belonged to a 4 or 5 year old bull, and was cured and mounted in some unknown way, by Indians. The head was simply cut from the animal, close to the jaws, and was never skinned off; but by some process was cured, dried and preserved, meat and all. Eyes were set in the lids, and though, of course, it is somewhat reduced in size, by the drying up of all muscles and cartilage, it presents a fair appearance, aside from being a great curiosity.

The head was preserved over 10 years ago, and although exposed to damage by moth, it has remained in perfect condition, proving that some poisoning process has been used. The head is valued at \$200.

Let me express my thanks for the Syracuse gun you sent me, as a premium for a club of subscribers for RECREATION. The gun is a dandy, and as fine a shooter as I ever shot. I have used it constantly this fall, whenever time would permit, and am very much pleased with it. It is gratifying to me to think I got so good a gun for a few hours' extra work.

John G. Randall, Ishpeming, Mich.

Every person who subscribes for RECREATION, or renews his subscription, this year, can get a copy of Mr. W. T. Hornaday's delightful book, "The Man Who Became a Savage," for 50 cents extra. The book sells in the stores at \$1.50; but you can get RECREATION one year, and the book, for \$1.50.

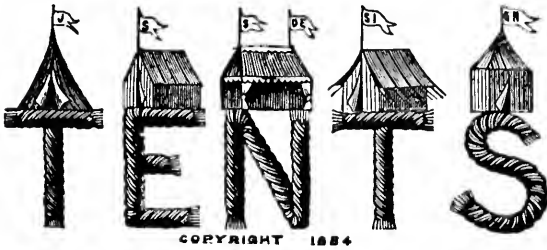

## AND CAMP OUTFITS

We manufacture the largest and most complete line of tents in the country, and our goods are celebrated for their wearing and waterproof qualities.

Send 4 cents in stamps for our new 40-page illustrated catalogue showing all styles of Tents and Camp furniture.

**GEO. B. CARPENTER & CO.**

202 to 210 S. Water Street, CHICAGO

Established 1840.

**WM. W. HART & CO.**

## Leading Taxidermists

(New School)

5 West Third St., near Broadway, New York

WE HAVE NO COMPETITION  
ON ARTISTIC, LIFELIKE MOUNTING

Moose, Elk, Caribou, Deer, and other Game  
Heads a Specialty

Animals, Birds, Fish and Reptiles Mounted true  
to Nature and Full of Action

Skins dressed and mounted into Rugs. Best work.  
Reasonable prices

Highest Award  
Columbian Exposition

Send two postage stamps  
for Catalogue.

ALL WORK GUARANTEED  
MOTH PROOF

## JAMES McCREERY & CO.

### MEN'S FURNISHINGS

Bicycle and Golf Hose,  
Silk, Wool, and Merino Underwear,  
Gloves for Walking and Driving,  
Hosiery in all Grades,  
Shirts, Ready-made and to Order,  
Sweaters, Leggings,  
Silk Mufflers.

### LADIES'

Golf Capes,  
Sweaters, Plain and Fancy,  
Bicycle Suits, Bicycle Corsets,  
Shirt Waists, Tam O'Shanter Caps,  
Cloth and Cotton Outing Suits,  
Blazers, Belts, Ties, Gauntlet Gloves.

**801 BROADWAY**

**NEW YORK**

## THE KLONDYKE COUNTRY.

L. L. BALES.

The Klondyke region is a succession of high, rolling hills that reach Eastward to the snow covered Rockies, nearly 100 miles away. There are more or less swamps and meadows on the larger tributaries, back from the rivers. The large rivers have dry silk and gravel banks, with many islands, large and small, and more or less timbered. The timber consists of spruce, cottonwood, birch, black alder and willow, and there is some timber on all of the streams. We often find birch 6 to 8 inches, and spruce and cottonwood 1 to 2 feet in diameter.

The wild pea vines have an edible root, 6 to 8 inches underground. It is dark in color on the outside, white inside, is  $\frac{1}{2}$  inch to 1 inch in diameter, and tastes like a sweet potato vine. The wild pea vine is usually about a foot high, with pods one inch long, and has 5 or 6 beans inside, which are green and gray speckled. There is also a bunch grass, a red top, a blue joint and plenty of slough grass, in the meadows.

There is a cranberry in that country, similar to the Norwegian cranberry, that grows all over the hills at the heads of creeks and ravines. The berry is dark red and about the size of the small cranberry of the States. They grow on a bush about a foot high, in clusters, and, cooked with sugar, are all right. There is also a moss cranberry, which is fairly plentiful in certain localities. There is a dwarf blue berry, above timber line, that grows on a low bush, one to 2 inches high. These berries also grow in clusters. The red currant grows on a vine, is tart in taste and of excellent flavor. There is also another berry, similar in appearance to the red currant, that has one flat seed. The berry has a sour, bitter taste. The natives gather large quantities of them, and let them ferment until they have a froth or foam on them that looks like ice cream. They put a finger in this, and draw it through the mouth with a gusto that is childlike. There is also a sort of a wild raspberry, red in color, that grows on a bush, 2 inches high, with 2 leaves.

The king salmon ascends the Yukon river and some of its tributaries, as does also the red salmon. They run from July until September. There is also a large black or Arctic trout in the lakes, that can be caught by deep trolling. The grayling is found in all the rivers and creeks. They take bait readily and rise to the fly. The best bait is either salmon eggs or large, black ants. These fish run about one pound in weight, and can be easily seen on the riffles. They run up those streams, in the Rockies, that have glaciers at the head, to spawn.

Game is more or less scattered, and migrates from one locality to another. On the Klondyke, Indian, Stuart and Pelly rivers can be found the moose and caribou,

with mountain sheep on the highlands. Mountain goat are found more on the coast ranges. Blue and ruffed grouse are found on the many islands in the river, and in the cover near the streams; also porcupines. The marmot, commonly called the ground hog is also found in the higher altitudes. There is the spruce squirrel, similar to the common pine squirrel; also a squirrel like the "picket pin" ground squirrel of the Flat Head valley, Montana. There are plenty of mice, which are very destructive. As you approach the coast range, from the interior, ptarmigans, or white grouse, are plentiful. Of small birds there are the moose bird, blue jay, and the Indian robin. Then come crows, ravens, eagles, and buzzards, with gulls on the main Yukon; ducks, geese and cranes in endless variety. There are a few woodland caribou, also of the smaller variety, that look like the tame reindeer at Orca station, on Prince William sound. These latter have a white mark behind and a short tail. Mountain sheep are plentiful at the head of the Hootalinqua, Pelly and Stuart rivers. The large black wolves are found near the other game. Foxes are scarce except on the high divides. Lynx are plentiful, with a few wolverines, martin, mink, beaver and land otter. Snow shoe rabbits were scarce in the interior, last summer. At times they are very plentiful. Bear are found near the streams. These are the common black bear, and the different varieties of the cinnamon.

The river valleys are all the way from a few yards in width, to several miles. The tributaries of the Klondyke are 15 to 40 miles in length, with many "pups," or small creeks, coming in. It is generally brushy along the streams, and where it is open, the ground is covered with loose rocks of all sizes, which, in turn, are covered with moss. In summer time, the moss is full of water and the walking is bad.

The ground thaws from 1 to 2 feet in summer. Bed rock is all the way from 10 to 40 feet deep, and gets deeper as you approach the main stream. There are 5 to 25 feet of black muck above the pay gravel.

There are no regular glaciers in the country, except in the Coast range and far up in the Rockies; yet there are places in the valley where, directly under the moss, you can find pure, solid ice. Small glaciers form every winter at the head of the smaller creeks, and disappear in summer. The water in the small streams is not over plentiful, and freezes dry in winter. There is from 1 to 2 feet of snow, with no high winds to speak of, except in the Yukon valley.

White or grass quartz is found everywhere. The country is rich in gold, and a brother guide, Frank T. Damstrom, who is one of the latest arrivals over the Dalton trail, from the Klondyke, tells me he saw, in one day's run, on McDonald's claim, with half a head of water, 1,200 ounces of gold taken out.

# A Superb Christmas Gift!

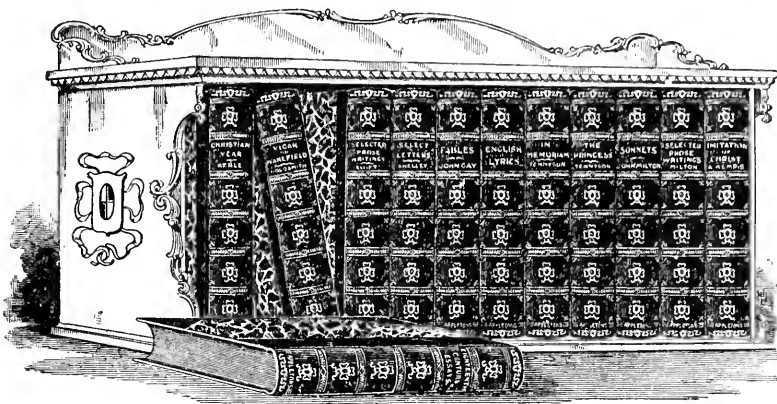

## “Appleton's Library of the English Classics”

A magnificent collection of the great masterpieces of English literature, including Tennyson, Milton, Thos. a Kempis, Chas. Lamb, Dean Swift, Shelley, John Gay, Keble, Goldsmith, Scott, Bacon, Johnson, Byron, etc., etc.

12 artistic volumes; half morocco; gilt top; uncut edges; illustrated in photogravure—an ideal edition of the great masters.

**\$1.00 secures you complete set.**

—balance payable \$1.00 monthly for 14 months, and as a SPECIAL HOLIDAY INDUCEMENT we will send to each subscriber

**Ten Famous Paintings FREE.**

REPRODUCED IN PARIS BY GOUPIL & CO.

in photogravure. Each plate 14 x 17 in., matted for framing. The retail price of this exquisite art collection would be at least \$15.00.

The coupon below secures you the magnificent 12 vol. Library, with the Cabinet of Art Plates complimentary—only \$1.00 monthly. This special introduction proposition is limited strictly to the first edition. Send coupon today!



D. Appleton & Co.,  
72 Fifth Ave., New York.

\$1.00 DISCOUNT FOR  
CASH IN ADVANCE.

Gentlemen—

Please send me C. O. D. \$1.00 (charges prepaid) set of APPLETON'S LIBRARY OF THE ENGLISH CLASSICS and PORTFOLIO OF ART PLATES for framing. I agree to pay balance at rate of \$1.00 monthly for 14 months.

Signed \_\_\_\_\_

Address \_\_\_\_\_

RECREATION.

Art Collection and Library sent by express at our expense.

**D. APPLETON & COMPANY, 72 Fifth Avenue, New York.**

# An Ideal Christmas Gift!

\$1.00 with coupon secures you IMMEDIATE POSSESSION of



## APPLETON'S STRATFORD-ON-AVON SHAKESPEARE

issued in 12 ARTISTIC VOLUMES BOUND IN HALF-MOROCCO WITH GILT TOPS, UNCUT EDGES, and a gallery of illustrations of famous Shakespearian players reproduced in photogravure.

A limited number of sets will be distributed to readers of this magazine to advertise this matchless edition.

**NO ADVANCE PAYMENT REQUIRED NO EXPENSE FOR DELIVERY**

The magazine "coupon" entitles you to the immediate possession of the 12 artistic volumes on these extraordinary terms: Only \$1.00 after delivery, and then only \$1.00 monthly for 14 months.

### A MAGNIFICENT PORTFOLIO ...OF... ART PLATES

made in Paris by Goupil & Co., reproducing famous oil paintings, will be sent

**FREE**

to magazine subscribers—a superb collection of photogravures, with portraits of the artists and descriptive text.

In itself a royal Christmas Gift—complimentary to Stratford-on-Avon subscribers.

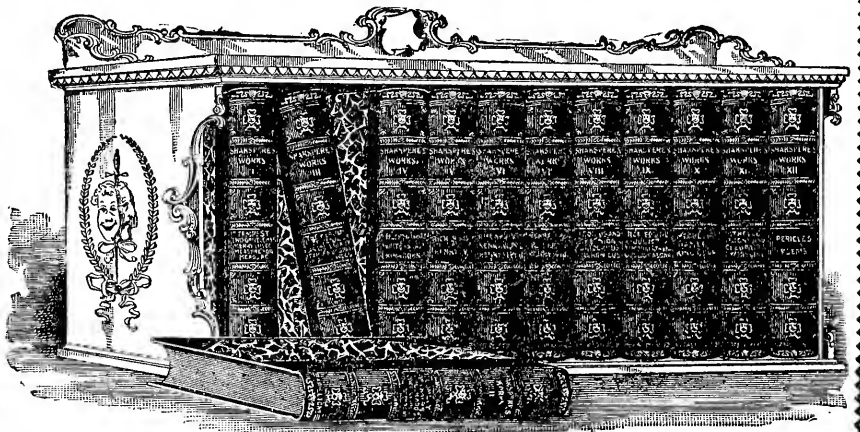

To Messrs. D. Appleton & Company,  
72 Fifth Avenue, New York

Gentlemen—

Please send me C. O. D. \$1.00 (charges prepaid), set of STRATFORD-ON-AVON SHAKESPEARE, and ART PORTFOLIO. I agree to pay balance at the rate of \$1.00 monthly for 14 months.

\$1.00 DISCOUNT IF YOU  
REMIT CASH IN ADVANCE

Signed \_\_\_\_\_

RECREATION

Address \_\_\_\_\_

**D. APPLETON & CO., - 72 Fifth Ave., New York**



# "THE LITTLE FINGER DOES IT"

## The Fisherman's Automatic Reel

SEND FOR  
CATALOG

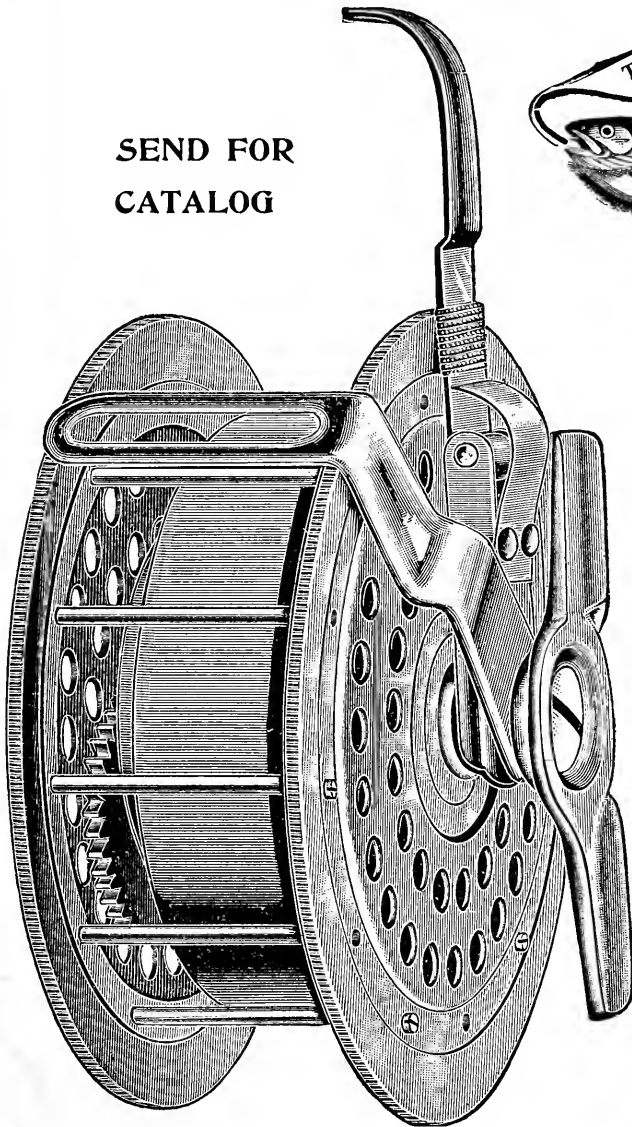

### What we claim for the Automatic Reel

**FIRST**—It will wind up the line a hundred times as fast as any other reel in the world.

**SECOND**—It will wind up the line slowly if the angler chooses.

**THIRD**—No fish can ever get slack line with it.

**FOURTH**—It will save more fish than any other reel.

**FIFTH**—It will prevent tips, lines, and snells from being broken by large fish.

**SIXTH**—The reel is manipulated entirely by the hand that holds the rod.

**SEVENTH**—It enables the angler and makes it desirable to use lighter tips.

Manufactured by  
**YAWMAN & ERBE**  
344 No. ST. PAUL Street,  
ROCHESTER, N. Y. U.S.A.

**Every Sportsman  
Should Have One**

Mention RECREATION.

# The Press Button Knife

Can be Opened Instantly with One Hand by Slightly Pressing the Button :: ::

## FOR Hunting, Fishing and Camping

Our 4-inch or 5-inch jack-knife is invaluable in emergencies when you need a strong knife quickly. Press button and blade is open for use.

- Four-inch Blade, Stag Handle. . . . . \$1.00
- Five-inch Blade, Stag Handle, . . . . . 1.25

SENT POSTPAID

### LOTT & SCHMITT

112-114 Walker Street  
NEW YORK

### LADIES' AND GENTLEMEN'S POCKET KNIFE

AS CUT

- In Sterling Silver, . . . . . \$1.75
- In Pearl, Plain, . . . . . 1.50
- In Ivory, Plain, . . . . . 1.25
- In Stag, Plain, . . . . . 1.00
- In Ebony, Plain, . . . . . 1.00

SENT POSTPAID

SEND FOR ILLUSTRATED CATALOG

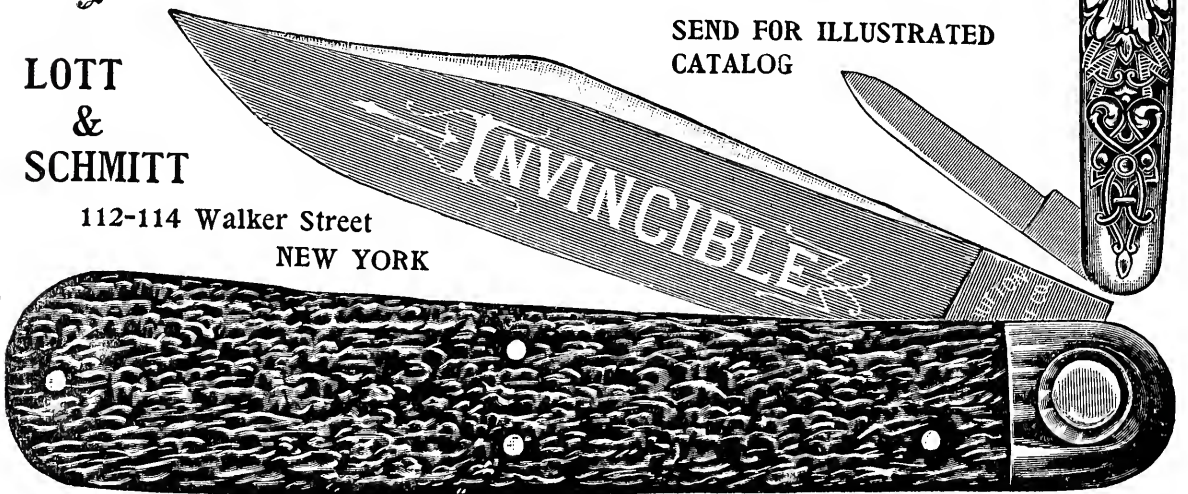

Mrs. Hautton (maliciously)—You were such a charming debutante, my dear, fifteen years ago.

Mrs. Inglefe—Was I? I only remember you made such a lovely chaperon for me when I came out.—Tid Bits.

The fish that bites and gets away may live to bite another day.

Getting subscriptions for RECREATION is easy. The magazine does its own talking. Turn to the premium list, on page lix., and see what you can get by sending in a club.

I am more than pleased with the Yawman & Erbe automatic reel you sent me. Please accept my sincere thanks. I also thank you for your more than fair treatment, and for your liberal offer.

William L. Campbell, Blackfoot, Idaho.

A Trial will Convince You that  
**GOLDEN SCEPTRE**  
 SMOKING TOBACCO  
 Is Almost Perfection. We will send on receipt of 10c. a sample to any address. Prices of Golden Sceptre, 1 lb., \$1.30; ¼ lb., 40 cts., postage paid.

— CATALOGUE FREE. —  
**SURBRUG, 159 Fulton Street, New York City.**

# The Wing

# Piano

STYLE 7



You do not have to pay an extravagant price for a first-class piano



In justice to yourself write for prices of the Wing Piano before you buy

## The Instrumental Attachment

imitates perfectly the tone of the Mandolin, Guitar, Harp, Zither and Banjo, giving the effect of an entire orchestra of these instruments playing in concert with the piano

**SENT ON TRIAL** We will send this piano, or your choice of four other styles, to any part of the United States *On Trial* (all freights paid by us), allow ample time for a thorough examination and trial in the home, and, if the instrument is at all unsatisfactory, we will take it back at our own expense. No conditions are attached to this trial. We ask no advance payment; no deposit. We pay all freights in advance.

**OLD INSTRUMENTS EXCHANGED  
EASY PAYMENTS**

OUR BOOK should be in the hands of every one who intends to buy a piano. It contains many valuable hints and instructions, and tells a great many things every buyer ought to know. We will send it free with our catalogue to any one who writes us.

**WING & SON,** 443 and 445 West 13th St., N. Y. City  
ESTABLISHED 1868

# The Muskoka and Midland Lakes Resorts

Reached only by the

## Grand Trunk Railway System

Is the Paradise for not only hunters, fishermen, and canoeists, but also those in search of health, where comfort and pleasure can be obtained economically.

The woodland and lake scenery would satisfy the most critical tourist.

Camping outfits can be purchased cheaply, or guides, thoroughly acquainted with this region, fully equipped for camping, can be secured readily.

Parties can be furnished with names of guides, and by communicating with them, make all necessary arrangements in advance.

The following fish and game, in season, are to be found in abundance, the variety of which is not surpassed by any other sporting region in the world:

**Fish.**—Bass, pickerel, brook trout, lake trout, whitefish, perch, sunfish, salmon, trout, sturgeon, catfish, herring, and muskalonge.

**Game.**—Deer, partridge, rabbits, pigeons, ducks, geese, plover, bear, woodcock, snipe, grouse, and moose.

**A few of the other Principal Resorts.**—Andros-coggin Lakes, the White Mountains, the salmon resorts of Quebec, New Brunswick, and Nova Scotia, Lake St. John region, the River St. Lawrence, the Thousand Islands.

For descriptive book showing routes and rates, apply to M. C. DICKSON, D.P.A., Toronto, Ont.; D. O. PEASE, D.P.A., Montreal, P.Q.; L. R. MORROW, C.P.A., Chicago, Ill.; R. McC. SMITH, S.P.A., Cincinnati, O.

CHAS. M. HAYS, GEO. B. REEVE, W. E. DAVIS,  
General Manager, Gen. Traffic Manager, G. P. & T. A.,  
Montreal, P. Q. Montreal, P. Q. Montreal, P. Q.  
FRANK P. DWYER, E. P. Agent, 273 Broadway, New York.

# ...To "the" Pleasure Resorts of... Texas and Gulf of Mexico

TAKE



Via CHICAGO, KANSAS CITY, or  
ST. LOUIS

WAGNER BUFFET SLEEPERS  
FREE "KATY" CHAIR CARS

For further information, address

W. S. ST. GEORGE, Gen. East. Agt.  
309 Broadway, New York

2,000  
Miles



OF

varied scenery; mountains, hills, valleys, rivers, lakes, parks, canyons—found between St. Paul and Portland, Oregon.

All the best cities of the north-west reached via this line.

Pullman sleeping cars, both first-class and tourist, and through dining-cars, on all overland trains.

**FINEST HUNTING AND  
FISHING RESORTS**

Send six cents for our new book  
*WONDERLAND '97*

CHAS. S. FEE  
General Pass. Agt. St. Paul, Minn.

## UNEQUALED ATTRACTIONS

ON THE LINE OF THE

# Union Pacific

FOR TOURISTS

It traverses the Grandest Scenery of the Rocky Mountains, and reaches all the Health and Pleasure Resorts of the Mid-Continent.

**Sportsmen** will find in scores of localities along this line game worthy of their skill, such as Bear, Mountain Lion, Coyotes, Elk, Deer, Antelope, Mountain Sheep, Feathered Game of all kinds. And everywhere are Beautiful Streams well stocked with Trout.

For Gun Club Rules, Game Laws, and any information relative to localities for Hunting, or for information in regard to the UNION PACIFIC SYSTEM, call on or address any General or Traveling Agent of this Company.

R. TENBROECK, Gen'l Eastern Agent,  
287 Broadway, New York City

E. DICKINSON, Gen'l Manager, E. L. LOMAX,  
Gen'l Pass. & Tkt. Agt.  
Omaha, Neb.

**BO**  
**BEST LINE**  
 TO  
 Pittsburg  
 Cincinnati  
 St. Louis  
 Chicago  
 Indianapolis  
 Toledo

## 20 BOOKS ❁ ❁

ON 20 DIFFERENT SUBJECTS,  
 BUT ALL RELATING TO SOME  
 DELIGHTFUL PHASE OF  
 AMERICAN TRAVEL, VIA  
 "AMERICA'S GREATEST RAIL-  
 ROAD."



ILLUSTRATED CATALOGUE SENT  
 FREE, POST-PAID, ON RECEIPT  
 OF A 1-CENT STAMP BY GEORGE  
 H. DANIELS, GENERAL PASSENGER  
 AGENT, NEW YORK CENTRAL &  
 HUDSON RIVER RAILROAD, GRAND  
 CENTRAL STATION, NEW YORK.

## Winter Resorts

are many, and summer resorts, and health resorts, and pleasure resorts; but Atlantic City, N. J., is all of these in one. It is famous the world over. To get the most out of it, much depends on one's hotel, and this suggests our new booklet. Can we send it to you?

J. D. SOUTHWICK, Manager

## The Shelburne

### THE U. S. WHEEL.

If Boston really is "the Hub,"  
 We think, then, to be frank  
 That Philadelphia is the tire,  
 And Kansas is the crank.

Chicago must the pedal be  
 Because the feet are there,  
 And New York is the handle-bar  
 That steers the whole affair.

—Life.

Miss Allington—How old do you think a man ought to be before he marries?

Mr. Benham—Forty, at least.

Miss Allington—Oh, dear! Why would you have him wait so long?

Mr. Benham—Because he is pretty sure to know better by that time.—Cleveland Leader.

A Grand Upright Piano, listed at \$750,  
 for 200 yearly subscriptions to RECREATION.

# “See That Other Feller?”



“Well, he smashed three rods during the two weeks we were down East together—and he’s no ‘chump’ fisherman, either. You see, he used his regular wood rods—bamboo and lance-wood—and the weather happening to be wet and the fish running heavy, the rods went to pieces. I had two Bristol Steel Rods along and lent him one to help out, and now we both swear by the ‘Bristol.’”

Any angler wishing to learn about the Bristol Steel Fishing Rods can find the whole business in our Catalogue “R” —other things too.

The Horton Manufacturing Co.

Bristol, Conn.

For nearly 50 Years the name

**"Davenport"**

has been identified with  
the manufacture of

**Guns...**  
and **Rifles**  
+++++

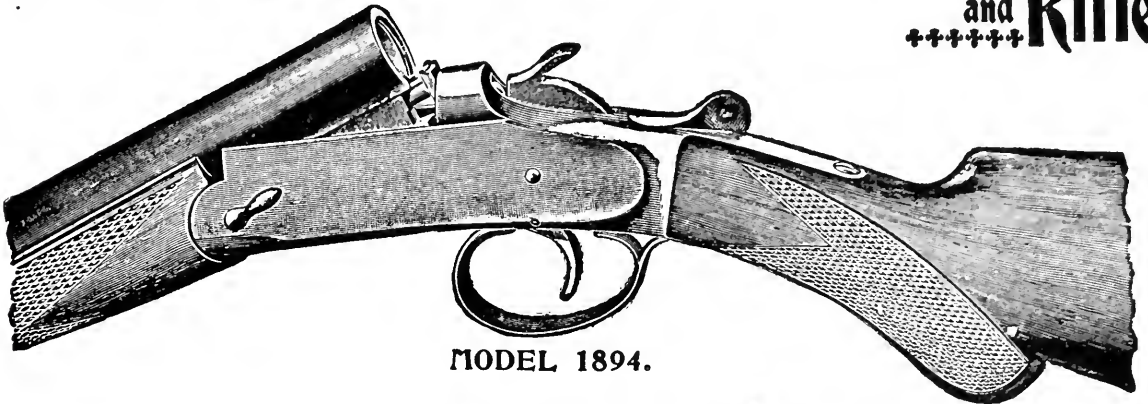

MODEL 1894.

**AUTOMATIC EJECTOR**

Our present line is complete and varied and shows the result of years of experience.

For catalogues and information address

**THE W. H. DAVENPORT FIRE ARMS CO.**

**NORWICH, CONN., U. S. A.**

Mention "RECREATION"

*Ejector Guns  
no longer a  
luxury*

**Good News for Sportsmen**

Lefever Automatic Ejector Guns at a price  
within the reach of every sportsman.

OUR NEW EJECTOR MOVEMENT

*Has only two pieces: One in the  
Hammer, One in  
the Frame.*

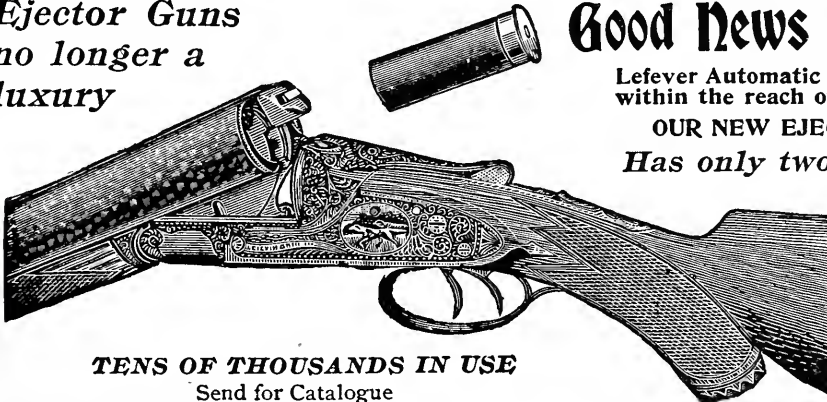

We have decided to meet  
the demand for *medium*  
price Ejectors, and are now  
prepared to accept orders  
for all grades of our ham-  
merless guns fitted with  
Ejectors.

**TENS OF THOUSANDS IN USE**  
Send for Catalogue

**LEFEVER ARMS CO. - - Syracuse, N. Y.**

(Mention RECREATION.)

Date,.....1897.

G. O. SHIELDS,

Editor and Manager of RECREATION, 19 West 24th St., New York:  
Herewith find One Dollar, for which please send me RECREATION  
for one year beginning with..... number.

Name,.....

Remit by P. O. or Express Money Order, or New York Draft.

**DETACH THIS, FILL OUT, AND SEND IN.**

# New Ithaca Guns

Self compensating,  
taking up wear  
at every point

Bored  
**FOR BLACK AND  
NITRO POWDERS**

Close and Hard Shooting Guns  
at long range a specialty



Price but a little more than one-half that of any other good gun, and warranted in the most positive terms, shooting included

**ITHACA GUN COMPANY, ITHACA, N. Y.**

Send for circular  
Mention RECREATION

Manufacturers of fine Hammer  
and Hammerless Guns

FOR FIELD OR FOR TRAP,  
FOR POT HUNTING OR FUN,  
NO SPORTSMAN IS EQUIPPED  
WITHOUT A SYRACUSE GUN

“MORE TRUTH  
THAN POETRY”

We do not say that **SYRACUSE HAMMERLESS GUNS**

“Are as Good” as any gun in the market.



Their simplicity of construction and superiority of finish stamp them “BETTER” for practical all-round work than any gun in the market. The “old, old story” but, nevertheless, substantiated by every man who ever drew a Syracuse to his shoulder.

**SYRACUSE ARMS CO., SYRACUSE, N. Y., U. S. A.**

Sole Agents, HERMANN BOKER & CO., 101 Duane Street, New York City



---

# Read this Testimonial of the Forehand Gun

---

---

GALLOWAY BROTHERS  
WHOLESALE DEALERS FLOUR  
114 S. FREDERICK ST.  
BALTIMORE, MD.

BALTIMORE, OCTOBER 30, 1897.

FOREHAND ARMS CO.

GENTLEMEN : I purchased from your factory, October, 1893, a new Hammerless Double 12 gun. On receipt of same there was a little trouble owing to the imperfect knowledge of one of our gunsmiths in this city. You were kind enough to adjust the spring that was strained by said gunsmith and return the gun to me free of charge. It is a rather late day to express my thanks, but the gun has proved such a valuable one to me that I think it no more than right that you should be acquainted of the fact. I have been shooting regularly since, in bird season, and have been in the field with sportsmen who shot Greener, Parker, and a number of other first-class makes. I beg to say to you, not in flattery but in fact, that the gun I purchased of you is the finest I have ever seen. It will outshoot any gun I have yet found. The most remarkable circumstance is that I have used it in duck and turkey shooting and have used heavy charges. If I point it straight it will kill with just as much regularity at same distances as any 10 or 8 gun I have yet run up against. Since the first trouble, which I have already explained, I have never expended a cent for repairs, and I think the weapon as good to-day as when I first received it. I could not be tempted to sell it for double the purchase price, for fear I could never secure another like it. As this is a compliment to your works, wholly unsolicited on your part, I thought it might give you some pleasure to know of it.

Yours very sincerely,

BALLARD J. GALLOWAY.

## 1898!

The first edition of the 1898 calendar (an unusually interesting one) will be ready for delivery early in December. Copies mailed on receipt of stamps or currency, at the rate of 7 cents a copy.

SPRATTS PATENT LIMITED  
245 EAST 56TH STREET, NEW YORK CITY

EVERY SPORTSMAN should have a pair of our

# “C” Quality Hunting Shoes

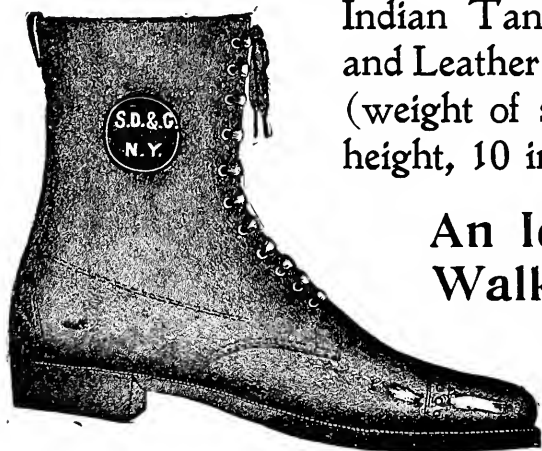

Indian Tan Horsehide Uppers, Horsehide and Leather Sole, with or without hob nails (weight of shoe, size 7, only 20 ounces) height, 10 inches. Very soft and pliable.

**An Ideal Hunting, Golfing, or Walking Shoe...**

We have sold over 500 pairs this year, and can guarantee them waterproof and to remain soft.

Will ship a pair on receipt of \$6.50, and if not satisfactory will refund money

**SCHOVERLING, DALY & GALES**

.....302 Broadway, New York

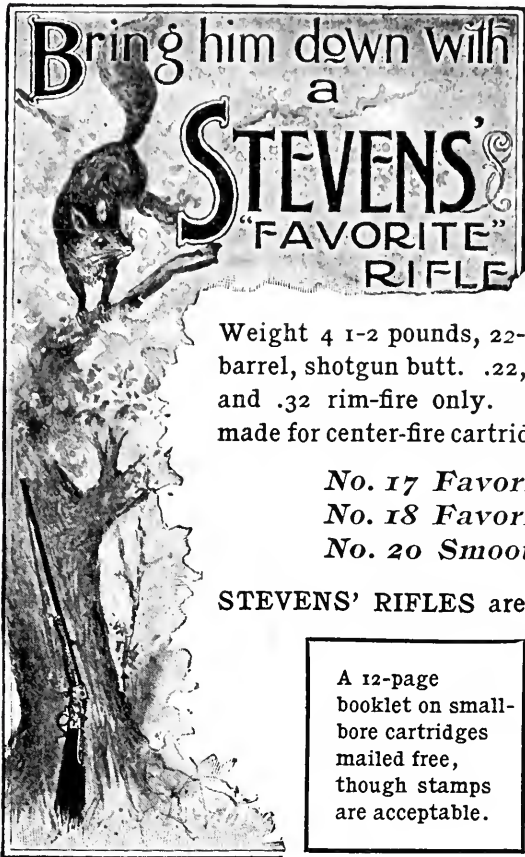

Weight 4 1-2 pounds, 22-inch barrel, shotgun butt. .22, .25, and .32 rim-fire only. Not made for center-fire cartridges.

- No. 17 Favorite, plain open sights, - \$6.00
- No. 18 Favorite, target sights, - - 8.50
- No. 20 Smoothbore, for shot .22 and .32, 6.00

STEVENS' RIFLES are ALL "Take Down" Model. No Extra Charge.

A 12-page booklet on small-bore cartridges mailed free, though stamps are acceptable.

For 34 Years.....

STEVENS' RIFLES have been celebrated for their accuracy. There must be some good reason for this!



No. 17 Favorite



Where our arms are not sold by dealers, they will be sent, expressage prepaid, on receipt of list price.

J. STEVENS ARMS AND TOOL CO.  
P. O. Box 444  
Chicopee Falls, Mass.

# MR. FRED GILBERT

In the Contest for the  
**E. C. Cup**

Made the following score:

**48 out of 50**  
UNKNOWN ANGLES

**48 out of 50**  
EXPERT RULES

**46 out of 50**  
DOUBLES

HE USED

**DuPont  
Smokeless  
Powder**

**E. I. DUPONT DE NEMOURS & CO.**  
WILMINGTON, DEL.



# What's the Use

of walking when you can get a first-class, high-grade bicycle for nothing?

## How?

By getting 75 subscriptions for

## Recreation

If you live in a town of 3,000 or more, and if you are a hustler you can get these in 2 days.

I can give you the names of 20 people who did this in 1896, and who now have their wheels.

Write for particulars.

## RECREATION

19 West 24th Street  
New York



**Wanted:** A Ballard rifle, 22 rim fire; 32-20, 32 W. C. F. 32-40, 32 short and long, or 38-55, centre fire. Plain or fancy rifle, double set or single trigger. Would prefer a "No. 5 Pacific," 32-40 or 38-55 calibre. Will pay 25 cents for an old Marlin (or other) catalogue, with illustrations of Ballard rifles. State price and give description of rifle.

Louis K. Ervin,  
Bear Creek, Hinds Co., Miss.

**Wanted:** The name of a good live town in Texas, with good shooting, fishing and climate, ripe for an up-to-date sporting goods and bicycle store, with first class machine and repair shop in connection.

Address D. Sport, c/o RECREATION.

**For Sale:** Fine elk head, handsomely mounted, 14 points; spread 46½; length of main beam 48½; perfectly even set of antlers. Can furnish photo. Price \$100.

Peter Lepp, 122 N. Baum Avenue.  
Saginaw E. S., Mich.

**For Sale:** Vive camera No. 1; 4¼ x 4¼, plates or films; 36 holders. Complete printing and developing outfit good as new. Sent C. O. D. with privilege of examination, if charges are guaranteed. Price \$4.

Address L. B., 156 Elwood, Ind.

## BOOKS BY G. O. SHIELDS (COQUINA)

### THE BIG GAME OF NORTH AMERICA

Its Habits, Habitat, Haunts and Characteristics. How, When and Where to Hunt it. 8vo, 600 pages, 80 illustrations. Cloth, \$3.50; Half Morocco, \$5.00; Full Morocco, \$6.50.

### CRUISING IN THE CASCADES

A Narrative of Travel, Exploration, Amateur Photography, Hunting and Fishing, with Special Chapters on Hunting the Grizzly Bear, the Buffalo, Elk, Antelope, Rocky Mountain Goat, and Deer; also on Troutling in the Rocky Mountains; on a Montana Roundup; Life Among the Cowboys, etc. 12mo, 300 pages, 75 illustrations. Cloth, \$2; Half Morocco, \$3.

### AMERICAN GAME FISHES

How, When and Where to Angle for them. 8vo, 400 pages, 50 illustrations. Cloth, \$2.50; Half Morocco, \$4.

### HUNTING IN THE GREAT WEST

(Rustlings in the Rockies)

Hunting and Fishing Sketches by Mountain and Stream. 12mo, cloth. Over 300 pages. Illustrated. Price, 75 cents.

### THE AMERICAN BOOK OF THE DOG

The Origin, Development, Special Characteristics, Utility, Breeding, Training, Diseases and Kennel Management of all Breeds of Dogs. 8vo, 650 pages, 100 illustrations. Cloth, \$3.50; Half Morocco, \$5; Full Morocco \$6.50.

### CAMPING AND CAMP OUTFITS

A Manual of Instruction for Young and Old Sportsmen. 12mo, 200 pages, 30 illustrations. Cloth, \$1.25.

### THE BATTLE OF THE BIG HOLE

History of General Gibbon's Engagement with the Nez Perce Indians in the Big Hole Basin, Montana, August 9, 1877. 12mo, 150 pages. Profusely illustrated. Cloth, \$1.

These books will be mailed, post-paid, on receipt of price, by the author.

G. O. SHIELDS

19 West 24th St., New York

# Some Rare Opportunities

These goods are all new, and will be shipped direct from factory. Prices named are those at which manufacturers and dealers usually sell. Here is a good chance to get

|              |                      |
|--------------|----------------------|
| A BOOK       | } FREE<br>OF<br>COST |
| A GUN        |                      |
| A CAMERA     |                      |
| A TYPEWRITER |                      |
| A BICYCLE    |                      |

Subscriptions need not all be sent at once. They can be sent in installments as taken and credit will be given on account. When the required number is obtained the premium earned will be shipped.

**"Recreation"** 19 West 24th Street  
New York

## To any person sending me

TWO yearly subscriptions to RECREATION at \$1 each, I will send a copy of *Hunting in the Great West*, paper; or a Czar Camera, or a Gem Camera, each listed at \$1; or an Ingersoll Watch or Cyclometer, each listed at \$1.

THREE subscriptions at \$1 each, a copy of *The Battle of the Big Hole*, cloth.

FOUR subscriptions at \$1 each, a copy of *Camping and Camping Outfits*, cloth.

FIVE subscriptions at \$1 each, a copy of *Cruising in the Cascades*, cloth; or a Willsie Pocket Camera, valued at \$5. It makes a picture  $2\frac{1}{8} \times 2\frac{3}{8}$  inches and can be loaded with 24 cut films.

SIX subscriptions at \$1 each, a copy of *American Game Fishes*, cloth; or a Baby Hawkeye Camera, listed at \$6.

SEVEN subscriptions at \$1 each, a copy of *The Big Game of North America*, or of *The American Book of the Dog*, cloth; or a Cyclone Camera, listed at \$10; or an Australian Mosquito-proof Tent, listed at \$7.

EIGHT subscriptions at \$1 each, a Pocket Kodak, made by the Eastman Kodak Co., and valued at \$5; or a Water-proof Wall Tent,  $7\frac{1}{2} \times 7\frac{1}{2}$ , and listed at \$7.50.

TEN subscriptions at \$1 each, a single-shot Davenport Rifle; or a Fishing rod, or a Yawman and Erbe Automatic Reel, worth \$9; or a Kenwood Sleeping Bag, worth \$10; or a No. 10 Gramophone, worth \$10.

TWELVE subscriptions at \$1 each, a Manhattan Improved Hand Camera, made by the Manhattan Optical Co., and listed at \$12; or an Australian Mosquito-proof Tent, listed at \$12.50; or a Stevens Diamond Pistol, listed at \$7 to \$8.

FIFTEEN subscriptions at \$1 each, a Davenport Single-barrel, breech-loading Ejector Shotgun, listed at \$10; or a Camera, worth \$6 to \$10; or a Kenwood Sleeping Bag, complete with canvas cover, worth \$16; or a No. 2 Bullet Camera, listed at \$10; or a Stevens Diamond Pistol, listed at \$10 to \$11.

TWENTY subscriptions at \$1 each, a 14-karat Gold Hunting-case Watch, with Elgin Movement, worth \$20; or a Marlin Repeating Rifle, listed at \$14 or less; or an Improved Night-hawk Hand Camera, made by the Manhattan Optical Co., and listed at \$25; or a No. 4 Bullseye Camera, made by the Eastman Kodak Co., and listed at \$12; or a No. 23 Stevens Sure Shot Rifle, with open sights, listed at \$10.

TWENTY-FIVE subscriptions at \$1 each, a No. 4 Bullet Camera, made by the Eastman Kodak Co., and listed at \$15; or a Gramophone, listed at \$25; or an Australian Mosquito-proof Tent, listed at \$25; or a Marlin Repeating Rifle, listed at \$18 or less; or a Shattuck Double-barrel Breech-loading Shot-gun, listed at \$25; or a No. 24 Stevens Sure Shot Rifle, listed at \$12.50.

THIRTY subscriptions at \$1 each, a New Haven Arms Co.'s Double-barrel Breech-loading Shot-gun, listed at \$30; or a Marlin Repeating Rifle, listed at \$21 or less; or any Stevens Rifle or Pistol, listed at \$20 or less.

FORTY subscriptions at \$1 each, a Syracuse, Grade O, or an Ithaca, quality, No. 1 plain, Double-barrel Hammerless Breech-loading Shot-gun, worth \$35; or a Camera, worth \$25; or a Marlin Repeating Rifle, listed at \$24 or less; or any Stevens Rifle or Pistol, listed at \$28 or less.

FIFTY subscriptions at \$1 each, a Marlin Rifle, with fancy curled walnut stock, pistol grip, checkered fore-end, handsomely engraved, half octagon, half magazine, with take down, listed at \$50.

SEVENTY-FIVE subscriptions at \$1 each, a Safety Bicycle, listed at \$85 to \$100.

ONE HUNDRED subscriptions at \$1 each, a fine Lefever Hammerless Gun, worth \$85; or a Bo-peep Camera, for  $6\frac{1}{2} \times 8\frac{1}{2}$  plates, made by the Manhattan Optical Co., and listed at \$120.

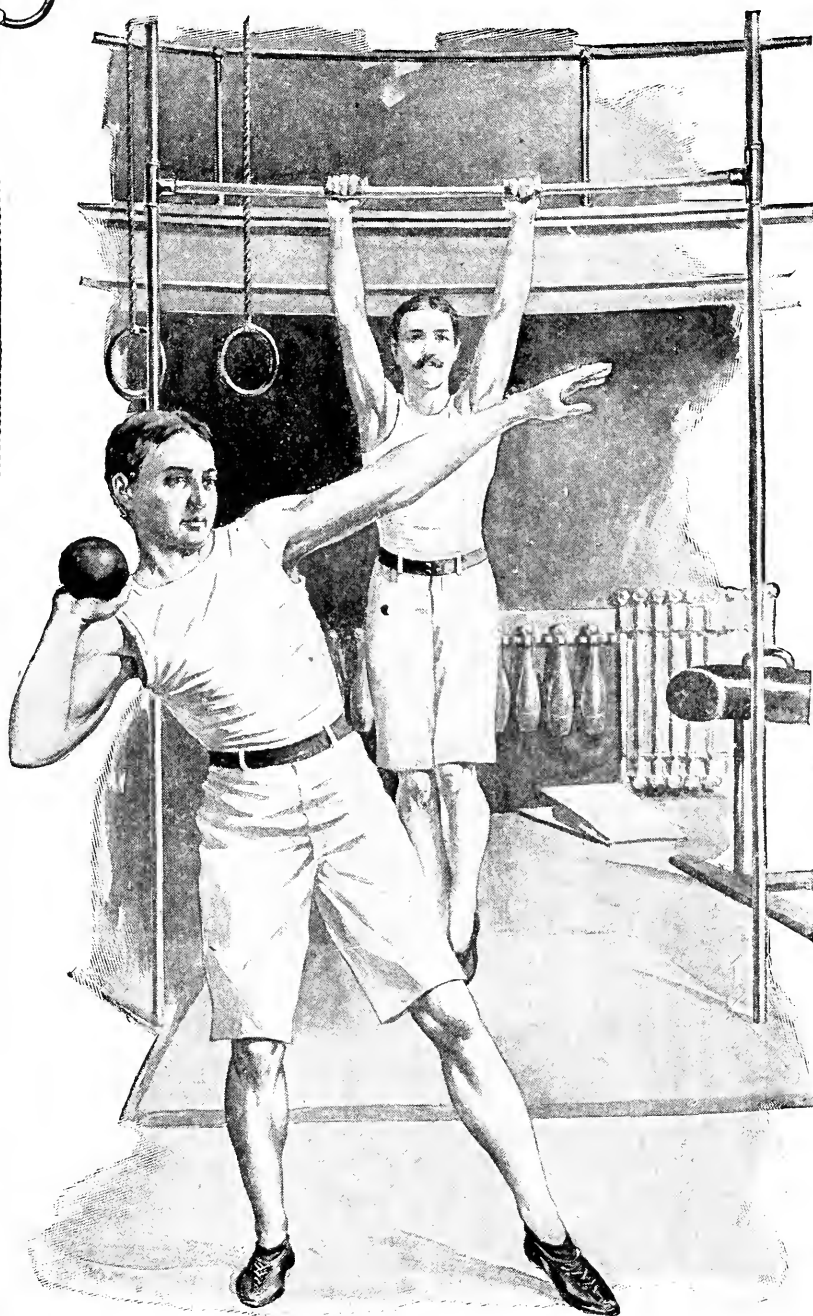

Strength  
from  
Strength-  
*Vigoral*

is the  
concentrated nutriment  
of prime lean beef  
further strengthened in  
muscle-forming consti-  
-uents by the addition of  
powdered beef, the whole  
being appetizingly spiced  
and seasoned and ready  
for immediate use with  
hot or cold water.

*Vigoral* is both meat and drink.— a foe to fatigue  
which gives added strength and vitality to all who use it.

To be had of all grocers and druggists.

The interesting little pamphlet "Various Views on Vigoral" is mailed for the asking.

Armour & Company  
Chicago.

From Primer to Crimp

# U. M. C. LOADED SHELLS

Are Beyond Adverse Criticism



In every kind of tournament, including The Grand American Handicap, they have stood by the winner. Send for new Catalogue, which gives all varieties and all combinations of load.



The Union Metallic Cartridge Co.

313 Broadway, New York

Bridgeport, Conn.

---

## Remington Hammerless



*Diana's Triumph*

*Perfect in Balance*

*Strong in Workmanship*

*Simple in Action*

---

*The invaluable result of nearly a century's mechanical experience. New illustrated catalogue mailed free.*

---

*Remington Arms Co.*

*Ilion, N. Y.*

425 Market St., San Francisco

313 Broadway, New York



## The Man Who Shoots \_\_\_\_\_

Is Easy to Select a Christmas Gift for. A

# WINCHESTER

### Repeating or Single Shot Rifle, or Repeating Shot Gun

Will Surely Please Him. They Are Used By Two Million Shooters

*Winchester Arms And Ammunition Are Sold Everywhere*

FREE—148 Page Illustrated Catalogue.

**WINCHESTER REPEATING ARMS CO., New Haven, Conn.**



## BICYCLES

**M**ADE by a reliable concern, who for 10 years has devoted its entire time and attention to the art of bicycle making, ought to be worth more than those offered by makers of less experience, many of whom are old makers of other products, and whose experience is limited to the building of furniture, wagons, plows, sewing machines, etc.

## The Clipper Special

is a "top notcher." No bicycle has been offered at any price worth as much; none at a less price anywhere near as good. The wheel you ought to buy at the price you ought to pay.

MADE BY **THE CLIPPER PEOPLE**

M-64-'98

GRAND RAPIDS, MICH.









*Acme*

Bookbinding Co., Inc.  
300 Summer Street  
Boston, Mass. 02210



3 2044 106 226 319

