



THE HORSE

ITS TREATMENT IN
HEALTH & DISEASE





JOHN A. SEAVERNIS

TUFTS UNIVERSITY LIBRARIES



3 9090 014 531 830

Webster Family Library of Veterinary Medicine
Cummings School of Veterinary Medicine at
Tufts University
200 Westboro Road
North Grafton, MA 01536

THE HORSE

ITS TREATMENT IN HEALTH AND DISEASE



POISONOUS PLANTS. I.

A. *Yucca elata*, (M. & L.) Engelm. Fruct.
 B. *Aconitum napellus*, L. Fruct.
 C. *Cannabis sativa*, L. (M. & L.) Fruct. 1. Flower with fruit. 2. Fruct. 3. Male flower.
 D. *Adonis vernalis*, L. Fruct.

ITS TREATMENT IN HEALTH AND DISEASE

WITH A COMPLETE GUIDE TO BREEDING
TRAINING AND MANAGEMENT

Edited by

PROF. J. WORTLEY AXE, M.R.C.V.S.

Ex-President of the Royal College of Veterinary Surgeons
Late Lecturer at the Royal Veterinary College, and at the Agricultural Colleges of Downton and Wye
Chief Veterinary Inspector to the Surrey County Council
Consulting Veterinary Surgeon to the British Dairy Farmers' Association

Author of "The Mare and Foal" "Abortion in Cattle" "Anthrax in Farm Stock"
"Examination of Horses as to Soundness" "Glanders, its Spread and Suppression" "Swine Fever"
"Lithotomy or the Removal of Stone from the Bladder of the Horse"

DIVISIONAL VOLUME VII

LONDON

31 SOUTHAMPTON STREET, STRAND

CONTENTS

DIVISIONAL-VOLUME VII

SECTION IV.—HEALTH AND DISEASE (*Continued*)

23. MEDICINES (<i>continued</i>)—		Page
DRUGS AND THEIR USES	- - - - -	1
DRUGS AND THEIR DOSES	- - - - -	9
Weights and Measures	- - - - -	11
MEDICINES AND THEIR THERAPEUTICAL ACTION	- - - - -	12
PRESCRIPTIONS	- - - - -	15
Horse Balls	- - - - -	15
Powders -	- - - - -	16
Draughts -	- - - - -	18
ADMINISTRATION OF MEDICINES	- - - - -	18
Balls	- - - - -	19
The Drench or Draught	- - - - -	21
Electuaries	- - - - -	21
Intra-tracheal Injections	- - - - -	21
Subcutaneous Injection	- - - - -	22
Intra-venous Injection	- - - - -	22
24. NURSING - - - - -	- - - - -	23
THE NURSE - - - - -	- - - - -	23
THE SICK-BOX - - - - -	- - - - -	23
Clothing—Water	- - - - -	24
INVALID FOOD - - - - -	- - - - -	25
The Laxative Foods—The Green Foods--Bran Mash—A Bran and Linseed Mash	- - - - -	26
Linseed Tea—Hay Tea—Linseed Oil—Roots—Gruel -	- - - - -	27
Boiled Barley—Pearl Barley	- - - - -	28
POULTICES AND POULTICING	- - - - -	28
To make a Bran Poultice	- - - - -	29
The application of Poultices or Cataplasms -	- - - - -	30

	Page
The Heel—The Fetlock - - - - -	31
The Hock—The Head—The Withers—The Sides of the Chest and Belly—The Breast - - - - -	32
MUSTARD PLASTERS - - - - -	33
The Throat—The Wind-pipe—The Sides of the Chest—The Belly -	33
The Liver - - - - -	34
BACK-RAKING - - - - -	34
WASHING - - - - -	35
BANDAGES AND BANDAGING - - - - -	36
Preparation and Application of Bandages - - - - -	36
Starch Bandages—Plaster of Paris Bandage - - - - -	38
BLISTERING - - - - -	38
SLINGS AND SLINGING - - - - -	40
GARGLES AND MOUTH-WASHES - - - - -	41
SUPPOSITORIES - - - - -	41
LINIMENTS AND EMBROCATIONS - - - - -	42
LOTIONS - - - - -	42
OINTMENTS - - - - -	42
PLASTERS OR CHARGES - - - - -	42
25. POISONING—	
INTRODUCTION - - - - -	43
General Symptoms of Poisoning - - - - -	43
What to do in Cases of Poisoning - - - - -	44
Antidotes - - - - -	45
Poisonous Food and Water - - - - -	46
CORROSIVE OR IRRITANT POISONS - - - - -	46
Arsenic - - - - -	48
Antimony - - - - -	50
Lead - - - - -	51
Oxalic Acid - - - - -	51
Acetic Acid - - - - -	52
Caustic Alkalies - - - - -	52
Nitrate of Potash - - - - -	53
Nitrate of Soda - - - - -	53
Iodine - - - - -	53
Phosphorus - - - - -	53
NARCOTIC POISONS - - - - -	54
Yew - - - - -	55
Rhododendron - - - - -	56
Foxglove (<i>Digitalis purpurea</i>) - - - - -	56

CONTENTS

vii

	Page
Nux Vomica and Strychnia - - - - -	57
Indian Pea—Dog-tooth Pea - - - - -	58
Cantharides or Spanish-Fly - - - - -	60
Turpentine - - - - -	60
Poisoning by the Stings of Bees and Wasps - - - - -	61
Hay - - - - -	62
Aconite Poisoning - - - - -	63
26. VETERINARY HYGIENE - - - - -	64
ORDINARY CONDITIONS OF HEALTH - - - - -	66
STABLES - - - - -	69
Construction - - - - -	69
Lighting - - - - -	70
Ventilation and Air-Space - - - - -	71
Contamination of Air - - - - -	76
Organic Impurities - - - - -	77
Cubic Air-Space - - - - -	78
Drainage - - - - -	82
FOOD - - - - -	87
Nutrition—Constitution of the Body - - - - -	87
The Functions of Foods - - - - -	88
Digestibility of Foods - - - - -	90
System of Feeding - - - - -	92
Quantity and Quality - - - - -	92
Food and Work—Arrangement of the Diet - - - - -	93
Green Food - - - - -	95
Methods of Calculating the Nutritive Value of Different Articles of Diet - - - - -	96
Food as a Cause of Disease - - - - -	101
Excess of Food - - - - -	101
Insufficient Food—Quality of Food - - - - -	102
Selection and Preparation of Food - - - - -	106
Grains—Maize - - - - -	108
Wheat—Bran - - - - -	109
Hay - - - - -	110
Straw—Peas, Beans, and Lentils - - - - -	112
Linseed - - - - -	114
Roots - - - - -	115
Ensilage - - - - -	115
Digestion - - - - -	118
Water - - - - -	119
Natural Processes of Purification of Water - - - - -	126
Examination of Water - - - - -	129
EXAMINATION OF AIR - - - - -	132
INDIVIDUAL HYGIENE - - - - -	133
Grooming - - - - -	134
Clipping - - - - -	137

	Page
Clothing—Bedding - - - - -	138
Management of the Feet - - - - -	139
Vices - - - - -	140
HYGIENICS APPLIED TO DISEASED ANIMALS - - - - -	140
Isolation—Food - - - - -	140
Air—Light—Temperature - - - - -	142
Grooming—Exercise - - - - -	143
Signs and Symptoms of Disease - - - - -	144
General Symptoms of Disease - - - - -	145
Special Character of Infectious Diseases - - - - -	150
Prevention and Suppression of Infectious Diseases - - - - -	152
Prevention - - - - -	152
Suppression - - - - -	153
27. OPERATIONS - - - - -	156
MEANS OF RESTRAINT - - - - -	156
The Twitch - - - - -	157
The Travis - - - - -	158
The Side-line—Hobbles - - - - -	159
NEUROTOMY, NEURECTOMY, UNNERVING - - - - -	161
Methods of Operation - - - - -	161
Sequelæ - - - - -	165
FIRING OR THE ACTUAL CAUTERY - - - - -	166
TENOTOMY - - - - -	168
CASTRATION - - - - -	171
Age - - - - -	172
Methods of Operation - - - - -	172
Torsion - - - - -	174
Ligature—Caustic Clamps - - - - -	175
Standing Operation - - - - -	176
PASSING THE CATHETER - - - - -	177
OVARIOTOMY IN TROUBLESOME MARES - - - - -	180
CASTRATION OF RIGS OR CRYPTORCHIDS - - - - -	184

ILLUSTRATIONS

DIVISIONAL-VOLUME VII

FULL-PAGE PLATES

	Page
POISONOUS PLANTS—I (<i>colour</i>) - - - - -	<i>Frontispiece</i>
MEDICINAL PLANTS—III - - - - -	6
POULTICING - - - - -	32
SIMPLE SLINGS - - - - -	40
PATENT SLINGS - - - - -	42
POISONOUS PLANTS—II (<i>colour</i>) - - - - -	58
FOOD PLANTS—I (<i>colour</i>) - - - - -	94
FOOD PLANTS—II (<i>colour</i>) - - - - -	112
HORSE HOBbled—HORSE CAST - - - - -	156
VINSOT'S OPERATING-TABLE - - - - -	158
NEURECTOMY—THE HIGH PLANTAR OPERATION - - - - -	164
HORSE CAST FOR FIRING - - - - -	166
HORSE CAST FOR CASTRATION - - - - -	172
CASTRATION - - - - -	176

TEXT ILLUSTRATIONS

	Page		Page
Administering a Ball - - - - -	19	A Simple Apparatus for Rolling Bandages - - - - -	36
A Horse-Gag - - - - -	20	Bandaging a Fore-leg, showing the method of applying the bandage over a pad of cotton-wool - - - - -	37
Balling-Gun - - - - -	20	Bandaging a Fore-leg, showing the bandage completed and tied - - - - -	37
Syringe and Needles - - - - -	21	Neck Cradle - - - - -	40
Making a Subcutaneous Injection in the Neck - - - - -	22	Yew (<i>Taxus baccata</i>) - - - - -	55
Poultice-Boot - - - - -	30	Rhododendron (<i>R. hybridum</i>) - - - - -	56
Poulticing the Head - - - - -	30	Foxglove (<i>Digitalis purpurea</i>) - - - - -	57
Poulticing one side of the Head - - - - -	30	Indian Pea (<i>Lathyrus sativus</i>) - - - - -	59
Poulticing the Throat - - - - -	31	Spanish-Fly (<i>Cantharis vesicatoria</i>) - - - - -	60
Poultice applied to the Withers - - - - -	31		
Poultice applied to the Breast - - - - -	32		
Method of Rolling a Bandage - - - - -	36		

	Page		Page
Sting of Bee - - - - -	61	Twitch applied - - - - -	156
Wasp Sting - - - - -	61	Fore-leg strapped up - - - - -	157
<i>Colehicium autumnale</i> - - - - -	62	The Travis - - - - -	158
Alfalfa (<i>Medicago sativa</i>) - - - - -	62	Side-line - - - - -	159
Starwort (<i>Stellaria Holostea</i>) - - - - -	63	Hobbles - - - - -	159
Aconite (<i>Aconitum Napellus</i>) - - - - -	64	Cross Hobbles - - - - -	159
Direction taken by Air-currents with the Windward Windows open - - - - -	72	Spring Hook for Hobbles - - - - -	160
Direction taken by Air-currents with Windward and Leeward Windows open - - - - -	72	Tenotomy and Neurectomy—Localities of the various Operations - - - - -	162
Double Currents from opposite Win- dows - - - - -	73	Neurotomy Needle - - - - -	163
Direction taken by Air-currents when opposite windows are half-open - - - - -	73	Neurotomy Needle and Knife combined	163
Direction taken by Air-currents when Doors and Windows are closed - - - - -	73	High Plantar Neurectomy by Trans- verse Incision - - - - -	163
Section from Upper Lobe of a Collier's Lung - - - - -	77	Low Plantar Neurectomy—Raising Digital Nerve by Aneurism Needle threaded with Carbolized Silk or Gut - - - - -	164
Wrought-iron Open Gutter - - - - -	84	Low Plantar Neurectomy—Severing Digital Nerve held out by Carbolized Silk or Gut - - - - -	164
Covered Surface Drain - - - - -	84	Median Neurectomy - - - - -	165
Brick with Drainage Channel for Stable Floor - - - - -	84	Neurectomy of the Ulnar Nerve - - - - -	165
Drain-pipe with Flap - - - - -	85	Firing Irons - - - - -	166
Iron Gully - - - - -	85	Spavin-punch - - - - -	167
Stoneware Gully - - - - -	85	Cunean Tenotomy—Scalpel inserted, forceps holding away fascia - - - - -	168
Underground Drain for Stable - - - - -	86	Tenotomy. Tenotomy knife inserted beneath Tendon—Skin cut away to show position of Blade beneath Ten- don—Forceps holding Sheath - - - - -	169
<i>Actinomyces Bovis</i> - - - - -	103	Tenotomy Knife - - - - -	169
A Sewage Fungus, <i>Beggiatoa alba</i> (Sulphur Bacterium) - - - - -	126	Tenotomy of the Perforans Tendon, showing position of Hands and Knife - - - - -	170
Blanket-weed - - - - -	127	Castrating Knife - - - - -	173
Blue-green Algæ - - - - -	127	Castrating Iron - - - - -	173
Chlorophyll-green Alga (<i>Vaucheria ses- silis</i>) - - - - -	128	Clamp for Castration by Firing - - - - -	173
<i>Volvox globator</i> (colony) - - - - -	128	Fixing Forceps for Castration by Tor- sion - - - - -	174
Stonewort (<i>Chara fragilis</i>) - - - - -	129	Torsion Forceps - - - - -	174
Curry-comb - - - - -	134	Clamps, and Forceps for holding the same - - - - -	175
Scraper - - - - -	134	“Reliancee” Castrator - - - - -	176
Dandy Brush - - - - -	135	Éraseur - - - - -	177
Barton-Gillette Clipping Machine - - - - -	137	Retention of Urine—Catheter inserted	178
Horse-clippers - - - - -	138	Insertion of Female Catheter - - - - -	179
Clippers for Trimming Legs - - - - -	138	Guarded Knife - - - - -	182
Toe-tip for Horses turned to grass - - - - -	139	Cystic Ovary - - - - -	183
Clothing for Sick Horse - - - - -	143	Dressing Forceps and Artery Forceps -	185
Points for Feeling the Pulse - - - - -	146		
Feeling the Pulse - - - - -	147		
Sphygmograph Diagrams of the Pulse (after Sanderson, Dudgeon, and Steell) - - - - -	148		

SECTION IV.—HEALTH AND DISEASE—*Continued*

23. MEDICINES—*Continued*

DRUGS AND THEIR USES

Acetate of Lead.—A powerful astringent, given with benefit in dysentery, and to arrest bleeding from the lungs. In solution it is applied to “wrung” shoulders, and as a dressing in skin eruptions, such as eczema and pruritis.

Acetic Acid.—Astringent, corrosive, and vesicant. Used for removing warts, &c.

Aloes.—Purgative; useful in constipation of the bowels and colic. As an alterative it is given in swelling of the legs and general unthriftiness.

Aloin.—See Aloes.

Alum.—Astringent, antiseptic, caustic. Antidote in lead-poisoning. Given in diarrhoea. Externally applied to wounds, and as an injection is employed in fetid discharges from the vagina and rectum.

Aniseed.—Stomachic, carminative, and aromatic stimulant. Given with saline and other purgatives it prevents griping. In conjunction with ginger it causes the expulsion of gas from the stomach and bowels in flatulence, and assists digestion.

Arnica.—Mostly employed as an application to bruises and sprains. It stimulates the skin and increases the activity of the circulation, but it possesses no special advantage over other stimulants.

Arseniate of Iron.—An excellent tonic and restorative for horses in low condition. Useful also in obstinate skin diseases associated with debility.

Arsenious Oxide.—Internally it is a tonic astringent and alterative. Given in indigestion, general debility, and some of the more troublesome skin diseases, as eczema, psoriasis, impetigo, &c. It is mostly administered in the form of “liquor arsenicalis”.

Arsenic, even in medicinal doses, if administered regularly over a long period, may accumulate in the system and prove injurious.

An interval of a week should be allowed after each course extending over a fortnight.

Outwardly it is a powerful caustic and antiseptic. As the former it is sometimes applied to morbid growths and fistulous wounds, as quittor, poll evil, &c., but its employment for these purposes requires the greatest care and judgment, or serious injury may result to parts beyond those to which it is applied.

Asafoetida.—Useful as an expectorant in chronic bronchitis, and as a carminative in flatulent distension of the stomach.

Bael Fruit.—In combination with alkalies and aromatics it arrests diarrhoea in foals.

Belladonna.—As a local sedative it is applied to surface parts in the form of a liniment to relieve itching, and the pains arising out of rheumatism, inflammatory action, &c. It checks lacteal secretion when applied to the udder of the mare. A few drops of the solution dropped into the eye causes dilatation of the pupil.

Benzoic Acid.—Stimulant to wounds, antiseptic and diuretic. Externally applied in the form of “Friar’s Balsam”.

Bicarbonate of Potassium.—Useful in rheumatism, and, combined with vegetable bitters, relieves flatulence and promotes digestion. As an outward application it is employed to suppress itching in irritable skin diseases.

Bicarbonate of Sodium.—See Bicarbonate of Potassium.

Black Pepper.—Chiefly given as a condiment in virtue of its stimulant stomachic properties.

Bluestone.—Externally, sulphate of copper is a mild caustic and astringent; applied to the edges of indolent wounds it promotes healing. It also checks the formation of proud flesh, and in weak solution arrests mucous discharges from the vagina and other surfaces. Internally it is given as a tonic and astringent in chronic nasal gleet, &c.

Borax.—As a disinfectant it destroys low organisms and prevents their reproduction. Applied to the skin it allays irritation in urticaria, pruritis, and other forms of skin disease. As a mouth-wash it is useful in aphtha in foals.

Boric Acid.—Antiseptic. Used either in solution of 1 part to 20 of water or as an ointment. Cotton-wool, when soaked in a saturated solution and dried, forms antiseptic cotton-wool.

Bromide of Potassium.—A powerful sedative, whose special action is on the nerve centres. Used to suppress cerebral excitement, and convulsive movements due to irritation of the spinal cord.

Camphor.—In combination with other agents it is applied as a stimulant to sprained tendons, ligaments, and joints. Internally it is used to arrest catarrh and cough, to check diarrhoea, and to relieve gaseous distension of the abdomen.

Cantharides.—As a counter-irritant and vesicant it is applied to the skin over the region of joints, tendons, and ligaments to remove chronic enlargements, and to the throat, sides of the chest, and other parts in acute disease of internal organs.

Carbolic Acid.—Destroys low organisms; antiseptic, disinfectant, and deodorizer. Used in the treatment of wounds and the disinfection of stables, stable utensils, surgical appliances, &c. Inhaled from a nose-bag, it proves serviceable in nasal catarrh, strangles, and influenza.

Carbonate of Ammonia.—As a stimulant, combined with vegetable tonics, it is useful in influenza, strangles, and other specific fevers. As an expectorant it is given in bronchitis and broncho-pneumonia. It is also serviceable in indigestion, flatulence, and colic.

Carron Oil.—This is a mixture of lime-water and olive or linseed oil. It is used as an application to burns or scalds.

Catechu.—A powerful astringent. Very efficacious in diarrhoea when combined with chalk, opium, and aromatics.

Chalk (Precipitated).—Useful as an antacid in indigestion, and as an astringent in diarrhoea. Usually combined with opium and aromatics.

Chloral Hydrate.—As an antiseptic it destroys low organisms and prevents decomposition, but its chief action internally is exercised on the brain and spinal cord, by which it produces sleep and arrests convulsions. It is given in tetanus, chorea, spasmodic asthma, and colic.

Chlorate of Potassium.—Used mostly as a gargle or wash in aphtha and superficial ulceration of the month, and as an electuary in catarrhal sore-throat. It is sometimes given in strangles, purpura hæmorrhagica, and other specific fevers, under the idea that it destroys the poison in the blood by giving up its oxygen.

Chloric Ether.—Stimulant; antispasmodic and anodyne, useful in chills, colic, asthma, shock, &c.

Chloride of Ammonium.—Administered internally in bronchial catarrh, congestion of the liver, and in rheumatism. Dissolved in water with saltpetre and alcohol it forms a cooling application to the legs of horses.

Chloride of Mercury (Calomel).—Calomel is used as a cathartic in combination with aloes. It should, however, be given with care, lest super-purgation be induced. It is also given in small repeated doses as an alterative in chronic skin diseases, and in long-standing enlargement of

the hind legs due to lymphangitis or "weed". As a dry dressing to "thrush" it sometimes proves serviceable.

Chloride of Zinc.—A powerful caustic, used for the purpose of destroying warts and other morbid excrescences, and as an application to fistulous wounds and unhealthy sores. In weak solution it hastens the healing of indolent wounds.

Cinchona Bark.—See Sulphate of Quinine.

Cocaine.—This drug is used as a local anæsthetic, to destroy sensation in the part to which it is applied and allow of operations being performed without exciting pain. It is used in solution of the strength of 2 to 20 per cent, according to the part operated upon.

Cod Liver Oil.—Useful as an alterative and tonic in debility affecting young rapidly-growing foals, especially in cases where there is a tendency to diarrhœa or looseness of the bowels. In combination with iron it hastens convalescence from influenza and strangles, and sustains the strength and vigour of old stallions.

Corrosive Sublimate.—Corrosive, antiseptic, and disinfectant, applied externally as a caustic to indolent wounds, especially quittor and poll evil, and to fungating sores. In weak solution it is employed as an antiseptic dressing in the treatment of surgical wounds, and for the purpose of disinfecting surgical instruments and the hands of the operator.

Creasote.—Useful in diarrhœa in foals resulting from fermentation, which it prevents. Externally it is astringent and antiseptic, and is sometimes used in weak solution as a parasiticide in mange, and as a dressing for lice.

Digitalis.—Heart tonic and stimulant, as well as diuretic. Useful in heart diseases. Given in conjunction with salines it promotes the absorption of dropsical swellings and effusions into the chest and belly.

Epsom Salts.—Given to the horse in two- to four-ounce doses, it exercises a gentle action on the liver and kidneys, and is useful in regulating the bowels in the course of an attack of influenza or strangles or other specific fever. Given once a week to hard-worked horses, it prevents weed (lymphangitis) and azoturia.

Gentian.—Much used in horse practice as a general tonic and stomachic in dyspepsia, loss of appetite, and general debility.

Ginger.—Ginger, acting as a carminative, causes the expulsion of gas from the stomach and bowels. Mixed with aloes and other purgatives, it prevents griping.

Glycerine.—As an emollient glycerine is used to soften and lubricate the skin in chapped heels and mud-fever, sore teats, &c. It is also useful in

aphtha and superficial ulceration of the mouth when combined with borax or tannic acid.

Gum Acacia.—Used as a demulcent in coughs and sore throats, also in cases of irritation of the stomach and the intestines.

Hydrochloric Acid (Diluted).—Useful in indigestion where the acid secretion of the stomach is deficient. Given in combination with quinine, it arrests discharge from the nose in chronic nasal gleet, and is an excellent tonic and astringent.

Indian Hemp.—May be used in painful neurotic affections to deaden pain and produce sleep.

Iodide of Mercury (Red).—Counter-irritant and vesicant. Used in the proportion of 1 part to 8 of lard as a blister to the legs of horses for splints and other ossific diseases, as well as chronic sprains to tendons, ligaments, and enlarged joints. Milder preparations are also employed as applications to glandular enlargements and other chronic swellings.

Iodide of Potassium.—When administered in full doses it causes glandular tumours to disappear, and arrests the formation of exostoses, such as splints, ring bones, &c. In acute and chronic rheumatism it is sometimes beneficial, and as a diuretic it disperses dropsical effusions.

Iodide of Sulphur.—Sometimes used as a dressing in chronic skin eruptions in the proportion of 1 part to 10 of glycerine or lard.

Iodine.—In solution it is applied externally for the removal of chronic enlargement of the joints and glandular swellings. It is also used as a parasiticide in the treatment of ringworm, and inhalation of the vapour of iodine has been successfully used in chronic nasal catarrh.

Ipecacuanha.—In the form of Dover's powder it is sometimes used as an expectorant and diaphoretic.

Jaborandi.—In small doses it causes the removal of dropsical effusions into the chest and abdominal cavity. It also produces sweating, and sometimes gives relief in bronchial asthma. It has not been employed to any considerable extent in the treatment of the lower animals.

Lime-water.—Mixed with olive oil or glycerine it is applied to skin eruptions and abrasions to allay pain and soreness. Injected into the vagina it is beneficial in leucorrhœa. Given to foals in small doses three or four times a day it arrests diarrhœa. Mixed with linseed or olive oil it forms "carron oil", commonly used for burns and scalds.

Linseed Oil.—It is aperient, laxative, and emollient. Two tablespoonfuls given in the food is an excellent alterative when given to poor, unthrifty animals, and to horses after an attack of influenza, strangles, &c.

Morphia.—The salts of morphia are derived from opium, and possess very much the same therapeutical properties. As an efficient dose of the

former does not exceed a few grains, it is in some circumstances more convenient to inject it under the skin than to give it by the mouth. Moreover, when administered by subcutaneous injection, it is more rapidly absorbed into the circulation and more prompt in its action than when given by other means.

Mustard.—Mustard is a counter-irritant, sometimes rendered more active by the addition of turpentine or ammonia. It is useful in sore-throat and laryngitis, or as an application to the sides of the chest in pleurisy, bronchitis, and pneumonia.

It is sometimes used as a condiment with aniseed, coriander seed, turmeric, &c., but otherwise it is seldom prescribed in veterinary practice.

Myrrh.—In the form of tincture, myrrh is sometimes applied to wounds to facilitate their healing, but beyond this it is of little practical use.

Nitrate of Potassium.—Febrifuge, diuretic and alterative. Useful in influenza, strangles, purpura, and other specific fevers.

It removes temporary enlargement or "filling" of the legs, and, combined with sulphur and antimony, forms an efficient alterative.

Nitric Acid.—A powerful caustic, used to destroy warts and other abnormal growths, and to bring about a healthy action in spreading ulcers.

Nitric Acid (Diluted).—Astringent. When combined with dilute hydrochloric acid it is an excellent liver tonic, especially after an attack of hepatic congestion in the course of influenza, or in fat and idle horses.

Oil of Turpentine.—Given fasting, turpentine is a valuable remedy against intestinal worms. It is also useful as a diuretic, and to check bleeding in capillary hæmorrhage. In conjunction with opium, it is given in spasmodic and flatulent colic.

As an outward application it is usually employed as a counter-irritant, for which purpose it is sometimes mixed with mustard, or with ammonia and linseed oil. In both these forms it is serviceable as an application in sore-throat, or as a counter-irritant in diseases of the organs of the chest and belly.

Opium.—Internally administered, opium is one of the most useful antispasmodic and anodyne medicines employed in veterinary practice. It overcomes the spasm of tetanus and colic, affords relief in enteritis and pleurisy, and arrests the course of diarrhoea and dysentery. In combination with ammonia and squills, it is also useful in bronchitis. Externally, it is applied to sprains and bruises.

Nux Vomica.—A powerful nerve tonic. Specially stimulates the motor centres of the nervous system and restores muscular power in paralysis. Combined with bicarbonate of potash or soda it is useful also

MEDICINAL PLANTS--II

1. Aniseed (*Pimpinella Anisum*):
 - a. Flower enlarged.
 - b. Fruit enlarged.
 - c. Section across fruit
 - d. Star Aniseed (*Illicium verum*) partly open
 - e. Carpel.
2. Ipecacuanha (*Cephaelis Ipecacuanha*):
 - a. Corolla enlarged.
 - b. Calyx and pistil enlarged.
 - c. Piece of root.
 - d. Section of root enlarged
 - e. Section of stem enlarged.
3. Aloes, Barbados (*Aloe vulgaris*):
 - a. Flower.
 - b. Section of flower.
 - c. Anthers.
 - d. Section of ovary.
4. Red Pimento (*Pimenta officinalis*):
 - a. Bud enlarged
 - b. Flower enlarged.
 - c. Fruit.
 - d. Bottom and top and seed.
 - e. Cross section of fruit enlarged.
 - f. Bottom, top, and seed of Gray Pimento (*Pimenta acris*).
5. Catechu (*Acacia Catechu*):
 - a. Flower enlarged.
 - b. Pod.
 - c. Seed.

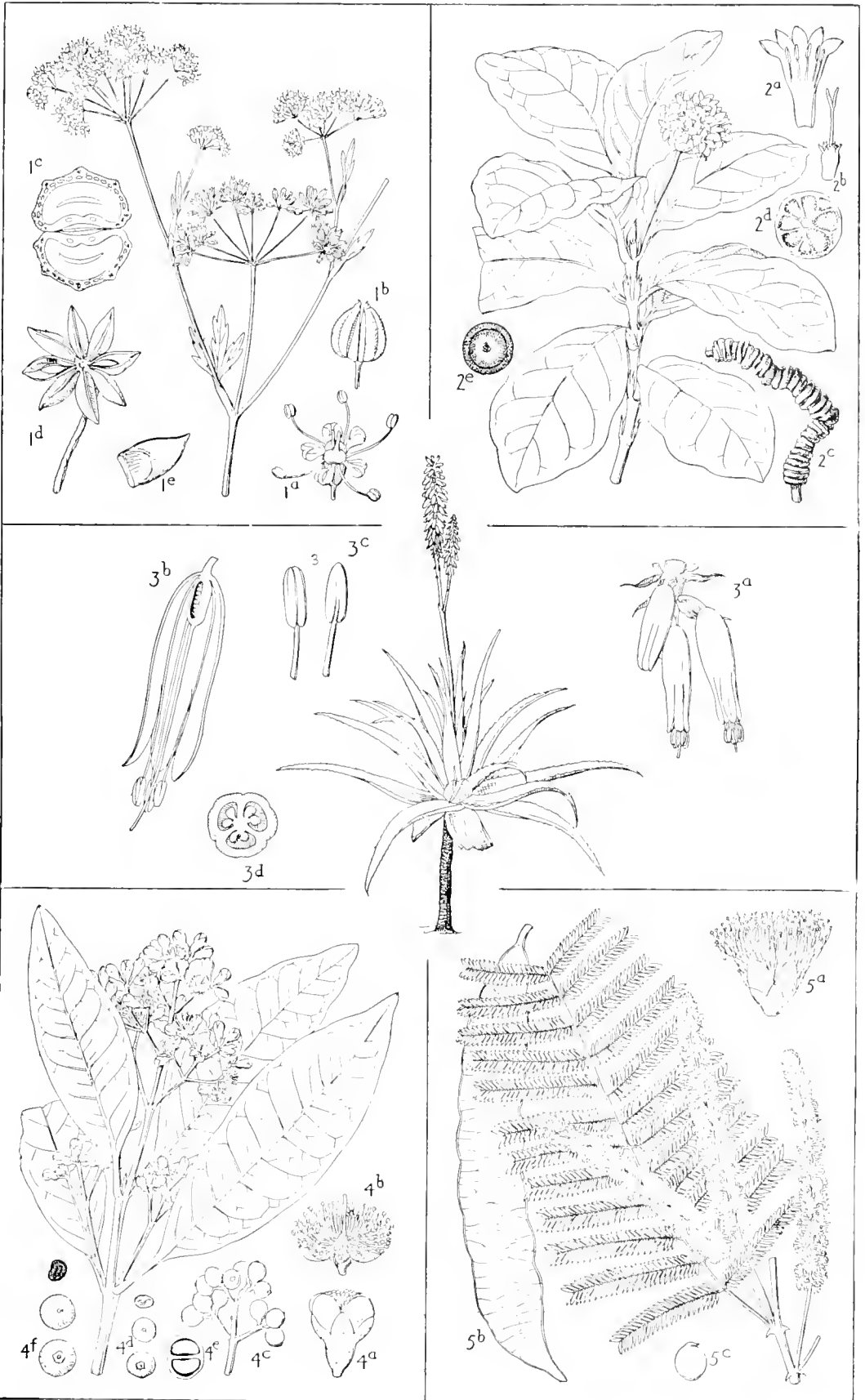

in imparting tone to the stomach and bowels in general debility from age or disease. Old stallions are benefited by a short course of nux vomica and nitro-muriatic acid at the commencement and during the service season.

Pepsin.—Given to foals in ten- to fifteen-grain doses, pepsin assists digestion and arrests diarrhoea and looseness of the bowels.

Pimento.—As a stomachic and carminative it is useful in slight derangements of the function of digestion, and especially so when combined with capsicum.

Prussic Acid.—Allays irritation of the skin in prurigo and eczema. Has been largely used to subdue spasm in tetanus, but with no lasting result.

Salicylate of Sodium.—See Salicylic Acid.

Salicylic Acid.—Lowers the temperature in fevers, strangles, and influenza, and as salicylate of soda it is found useful in acute rheumatism.

Solution of Acetate of Ammonium.—Combined with spirit of nitric ether it promotes activity of the skin, and with plenty of clothing induces sweating. It is useful at the outset of infectious fevers, and in the course of colds, bronchitis, &c.

Solution of Ammonia (Strong).—Counter-irritant. Commonly used in conjunction with turpentine and oil as a dressing for sore-throat and sprains to tendons, ligaments, and joints. It is administered in flatulence, and as a stimulant in debility. Neutralizes the poisons of some insects, and allays pain and swelling resulting from sting.

Solution of Chloride of Zinc.—See Chloride of Zinc.

Solution of Chromic Acid.—Disinfectant. Deodorizer and caustic. Sometimes employed locally to destroy morbid growths and dress fungating wounds and indolent ulcers on mucous surfaces. It is also useful in solution as an application to greasy legs, and mixed with tar is beneficial in thrush and canker of the foot.

Spirit of Nitrous Ether.—A diffusible stimulant, antispasmodic and diuretic. Serviceable in chills, fevers, colic, and œdematous swellings of the legs following upon debilitating diseases.

Sublimed Sulphur.—Useful as an alterative in conjunction with nitrate of potash and antimony. Mixed with linseed oil and oil of tar, or formed into an ointment with lard, it destroys lice and other skin parasites.

Sulphate of Iron.—Tonic, astringent and styptic. Given in debilitating and wasting disease it enriches the blood and imparts tone to the general system. It arrests mucous discharges in nasal catarrh, and suppresses bleeding in capillary hæmorrhage.

Sulphate of Magnesium.—See Epsom Salts.

Sulphate of Quinine.—As a tonic quinine is administered in general debility, following upon an attack of one or other of the specific fevers of the horse. Given in large doses during the course of the fever, it acts as an antipyretic and reduces temperature.

Sulphate of Sodium.—Administered as a preventative against contagious diseases, but with doubtful efficacy.

Sulphate of Zinc.—It is only as an external application that sulphate of zinc is used in veterinary practice. In this connection it is applied to wounds and ulcers to keep proud flesh down and promote the healing process. It is also useful as an injection in leucorrhœa in mares.

Sulphocarbolate of Sodium.—Sometimes used in flatulence arising out of indigestion.

Sulphurated Antimony.—As an alterative it is serviceable in some skin diseases, swelling of the legs, and general unthriftiness.

Sulphurated Potash.—Chiefly employed as a remedy against skin parasites and some chronic skin diseases. In weak solutions (1 grain to the ounce) it has been used as an injection to destroy ascarides in the rectum.

Sulphuric Acid.—A powerful caustic. Useful in the removal of warts and proud flesh from wounds.

Sulphuric Acid (Diluted).—Useful as an antidote to lead-poisoning. Sometimes given as a tonic in combination with vegetable bitters.

Sulphuric Ether.—Inhaled in the form of vapour, it reduces sensibility to pain. Given internally, it is a powerful diffusible stimulant and antispasmodic. Useful at the outset of a chill, and as a remedy in colic in conjunction with opium.

Sulphurous Acid.—In solution in glycerine it is useful for ring-worm. In its gaseous condition it is employed for disinfecting stables, &c. For this purpose sulphur is burnt on charcoal with closed doors and windows.

Tannic Acid.—Astringent. Used as an outward application in skin diseases, impetigo, and eczema. Internally in diarrhœa and intestinal hæmorrhage, and in catarrhal affection of the larynx.

Vinegar of Cantharides.—Useful in splints, spavins, and chronic sprains to tendons, ligaments, and joints, and for other purposes.

DRUGS AND THEIR DOSES

Name.	Dose.
Acetate of Lead	$\frac{1}{2}$ to 1 dram.
Acetate of Morphine	3 to 10 grains.
Acid, Carbolic (Liquid)	10 to 40 grains.
Acid, Hydrochloric (Diluted)	$\frac{1}{2}$ to 2 drams.
Acid, Hydrocyanic (Prussic Acid)	20 drops to 1 dram.
Acid, Nitric (Diluted)	1 to 2 drams.
Acid, Sulphuric (Diluted)	1 to 2 drams.
Aloes	2 to 8 drams.
Aloin	1 to 3 drams.
Alum	2 to 4 drams.
Aniseed	1 to $1\frac{1}{2}$ ounce.
Areca Nut	$\frac{1}{2}$ to 1 ounce.
Aromatic Spirit of Ammonia	1 to 2 ounces.
Arsenate of Iron	5 to 10 grains.
Arsenic, Solution of	1 to 2 ounces.
Asafetida	3 to 4 drams.
Benzoic Acid	1 to 3 drams.
Bicarbonate of Potassium	$\frac{1}{2}$ to $1\frac{1}{2}$ ounce.
Bicarbonate of Sodium	2 drams to 1 ounce.
Black Pepper	1 dram.
Boric Acid	1 to 2 drams.
Bromide of Potassium	$\frac{1}{2}$ to 1 ounce.
Calumba Root	2 to 5 drams.
Camphor	1 to 2 drams.
Cantharides	5 to 10 grains.
Capsicum Fruit	10 to 40 grains.
Caraway Seeds	1 to $1\frac{1}{2}$ ounce.
Carbonate of Ammonium	2 to 4 drams.
Carbonate of Iron	1 to 8 drams.
Carbonate of Lime	1 to 2 ounces.
Castor Oil	10 to 30 ounces.
Catechu	1 to 4 drams.
Chloral Hydrate	1 to $1\frac{1}{2}$ ounce.
Chlorate of Potassium	1 to 4 drams.
Chloride of Sodium	$\frac{1}{2}$ to 1 ounce.
Chlorinated Lime	1 to 2 drams.
Chloroform	1 to 2 drams.
Cinchona Bark, Red	2 to 4 drams.
Citrate of Iron and Ammonium	1 to 2 drams.
Citric Acid	1 to 2 drams.
Cod-Liver Oil	1 to 4 ounces.
Colchicum Seeds	$\frac{1}{2}$ to 1 dram.
Copaiba	1 to $1\frac{1}{2}$ ounce.
Creasote	10 to 40 minims.
Croton Oil	10 to 20 minims.
Cubebs	2 to 4 drams.
Digitalis	10 to 30 grains.

Name.	Dose.
Ergot	$\frac{1}{2}$ to 1 ounce.
Ergotin	10 to 20 grains.
Ether	1 to 2 ounces.
Ether, Chloric	1 ounce.
Ether, Nitrous (Sweet Spirit of Nitre)	1 to 2 ounces.
Ether, Sulphuric	1 to 2 ounces.
Extract of Aconite	3 to 10 grains.
Extract of Belladonna	1 to 2 drams.
Extract of Gentian	1 to 2 drams.
Extract of Hemlock	1 to 2 drams.
Extract of Henbane	1 to 2 drams.
Extract of Indian Hemp	$\frac{1}{2}$ to 4 drams.
Extract of Jaborandi	20 to 70 grains.
Extract of Male Fern	2 to 6 drams.
Extract of Nux Vomica	3 to 10 grains.
Gallic Acid	$\frac{1}{2}$ to 2 drams.
Gentian Root	$\frac{1}{2}$ to 1 ounce.
Ginger	2 drams to 1 ounce.
Gum Acacia	2 to 3 ounces.
Hydrated Peroxide of Iron	1 to 2 ounces.
Hydrochlorate of Morphine	3 to 10 grains
Iodide of Potassium	2 to 6 drams.
Iodine	10 to 50 grains.
Ipecacuanha	1 to 2 drams.
Linseed Oil	10 to 20 ounces
Mercury with Chalk	1 dram.
Nitrate of Potassium (Saltpetre)	2 to 8 drams.
Nitrate of Silver	5 to 10 grains
Nux Vomica	$\frac{1}{2}$ to 2 drams.
Oak Bark	2 to 4 drams.
Oil of Juniper	1 to 2 drams.
Oil of Peppermint	20 drops.
Oil of Turpentine	$\frac{1}{2}$ to 2 ounces.
Opium	$\frac{1}{2}$ to 2 drams.
Oxide of Zinc	1 to 2 drams.
Perchloride of Mercury	2 to 8 grains.
Phosphate of Calcium	1 to 3 drams.
Pimento	2 to 6 drams.
Potassio-Tartrate of Antimony (Tartar Emetic)	1 to 2 drams.
Rectified Spirit	1 to 2 ounces.
Resin	2 drams to 1 ounce.
Saccharated Carbonate of Iron	1 to 2 drams.
Salicine	$\frac{1}{2}$ to 1 $\frac{1}{2}$ dram.
Salicylate of Sodium	2 to 6 drams.
Salicylic Acid	1 to 3 drams.
Santonin	15 to 60 grains.
Soda, Hyposulphate	1 to 2 ounces.
Solution of Acetate of Ammonium	2 drams to 1 ounce.
Solution of Ammonia	2 drams to 1 ounce.
Strychnine	$\frac{1}{2}$ to 3 grains.
Subchloride of Mercury (Calomel)	$\frac{1}{2}$ to 1 dram.

Name.	Dose.
Sublimed Sulphur	1 to 4 ounces.
Sulphate of Atropine	$\frac{1}{2}$ to 1 grain.
Sulphate of Copper	1 to 2 drams.
Sulphate of Iron	1 to 2 drams.
Sulphate of Magnesium (Epsom Salts)	1 to 4 ounces.
Sulphate of Quinine	15 to 60 grains.
Sulphate of Sodium	1 to 2 ounces.
Sulphate of Zinc	1 to 2 drams.
Sulphurated Antimony	1 to 3 drams.
Sulphurous Acid (Solution)	1 dram to 1 ounce.
Tannic Acid	$\frac{1}{2}$ to 2 drams.
Tincture of Aconite (B.P.)	20 to 50 minims.
Tincture of Aconite (Fleming's)	5 to 15 minims.
Tincture of Belladonna	$\frac{1}{2}$ to 1 ounce.
Tincture of Cantharides	1 to 4 drams.
Tincture of Capsicum	2 to 6 drams.
Tincture of Cardamoms (Comp.)	1 to 2 ounces.
Tincture of Cinchona	1 to 2 ounces.
Tincture of Colchicum Seeds	1 to 4 drams.
Tincture of Digitalis	1 to 4 drams.
Tincture of Ergot	1 to $1\frac{1}{2}$ ounce.
Tincture of Gentian (Comp.)	1 to 3 ounces.
Tincture of Ginger	4 drams to 1 ounce.
Tincture of Hemlock	$\frac{1}{2}$ to 2 ounces.
Tincture of Henbane	$\frac{1}{2}$ to 2 ounces.
Tincture of Indian Hemp,	$\frac{1}{2}$ to 2 ounces.
Tincture of Iodine	1 to 6 drams.
Tincture of Nux Vomica	2 to 6 drams.
Tincture of Opium	$\frac{1}{2}$ to 2 ounces
Tincture of Perchloride of Iron	2 to 6 drams.
Vinegar	1 to 3 ounces.

WEIGHTS AND MEASURES

FLUID MEASURE

60 minims	one fluid dram.
8 drams	one fluid ounce.
20 ounces	one fluid pint.
8 pints	one gallon.

For all practical purposes a minim may be regarded as the equivalent of a drop, although the latter is liable to slight variation according to the nature of the material dealt with and the form of that part of the vessel from which it is made to fall.

GRAINS IN AN OUNCE AND A POUND

1 ounce	437 $\frac{1}{2}$ grains.
16 ounces	7000 grains or 1 lb.

SPOONS AS FLUID MEASURE

A tea-spoon holds	one fluid dram.
A dessert-spoon holds	two fluid drams.
A table-spoon holds	half an ounce.
A wine bottle holds	1½ pint.

DOSES ACCORDING TO AGE

For a yearling	$\frac{1}{2}$ that for an aged horse.
For a two-year-old	$\frac{1}{2}$ that for an aged horse.
For a three-year-old	$\frac{2}{3}$ that for an aged horse.
For a four-year-old	$\frac{3}{4}$ that for an aged horse.
For a five-year-old	Full dose.

COINS AS WEIGHTS

A threepenny piece	weighs one scruple (20 grains).
A sixpence	weighs two scruples (40 grains).
A shilling piece	weighs 80 grains.
3½ sovereigns	weigh one ounce.
Three penny pieces and a threepenny piece	weigh one ounce.

The above are approximately correct, but should not be used for active drugs as strychnine or morphine.

MEDICINES AND THEIR THERAPEUTICAL ACTION

Class of Medicine.	Action.	Examples.
Alteratives.	Improve the general condition of the body without exercising any perceptible local action.	Arsenic, iodine and its salts, linseed oil in small doses, antimony, chloride of sodium.
Anæsthetics.	Destroy sensation.	1. <i>Locally.</i> Cold, cocaine, carbolic acid, ether spray. 2. <i>Generally.</i> Chloroform, ether.
Anaphrodisiaes.	Diminish the sexual appetite.	Bromide and iodide of potassium, camphor, digitalis, purgatives.
Anodynes.	Subdue pain.	1. <i>Locally.</i> Cold, warmth, aconite, belladonna, opium. 2. <i>Generally.</i> Belladonna, chloral, hyoscyamus, opium.
Antacids.	Neutralize excessive acidity in the stomach and bowels.	Potassium bicarbonate, sodium bicarbonate, chalk.
Anthelmintics.	Destroy or remove intestinal worms.	1. <i>Those infesting the rectum.</i> Injections of solution of common salt, infusion of quassia, eucalyptol, catechu, &c. 2. <i>For Nematodes or round worms.</i> Santonin.

Class of Medicine.	Action.	Examples.
Anthelmintics.	Destroy or remove intestinal worms.	3. <i>For tape-worms.</i> Male fern, koussou, areca-nut, turpentine.
Antihydrotics.	Diminish secretion of sweat.	Mineral acids, belladonna, hyoseyamus, nux vomica, quinine, strychnia.
Antiperiodics.	Prevent the recurrence of certain diseases whose nature it is to return periodically.	Quinine, cinchonine, arsenic, salicylic acid, &c.
Antipyretics.	Lower the temperature of the body in fever. Also called <i>Febri-fuges</i> .	Salicylate of soda, camphor, quinine, alcohol, nitrous ether.
Antiseptics.	Destroy the organisms of decomposition, or so far weaken their vitality as to arrest putrefaction.	Carbolic acid, calcium chloride, chinosol, oil of eucalyptus, thymol, &c.
Antispasmodics.	Prevent or cause muscles when in a state of spasm to become relaxed.	Alcohol, ether, bromide of potassium, camphor.
Aphrodisiacs.	Increase sexual appetite.	Cantharides, strychnine, alcohol.
Astringents.	Diminish the secretion from mucous membranes and excite contraction of the tissues to which they are applied.	Acids, alum, ferric chloride, copper sulphate, chalk, gallic acid, tannic acid.
Carminatives.	Increase the peristaltic movement of the stomach and bowels and drive out superfluous gas.	Aniseed, capsicum, caraway seeds, mustard, pepper, oil of peppermint.
Caustics.	Destroy morbid excrescences on the skin and other free surfaces, and impart a healthy action to fungating sores.	Silver nitrate, mineral acids, the hydrates of potash and soda.
Chologogues.	Effect the removal of bile from the body.	Aloes, calomel, podophyllin.
Demulcents.	Soothe and guard parts to which they are applied against irritation.	Linseed tea, starch, glycerine, oil, Fuller's-earth, cotton-wool.
Diaphoretics.	Increase the secretion of sweat in the form of vapour. They are called <i>sudorifics</i> when perspiration appears in distinct drops.	Warmth, spirit of nitrous ether, solution of acetate of ammonium, tartar emetic, ipecacuanha, camphor.
Disinfectants.	Destroy the virus of contagious diseases.	Carbolic acid, thymol, mercuric chloride, boracic acid, sulphurous acid.
Diuretics.	Cause the removal of water and worn-out material from the body by stimulating the action of the kidneys.	Potassium nitrate, potassium chlorate, sodium chloride, alcohol, turpentine, and cantharides.
Ecbolics.	By exciting the action of the uterus cause expulsion of its contents.	Ergot, savin.
Emmenagogues.	Stimulate the return of æstrum.	Iron, strychnine, ergot, cantharides, savin, quinine.

Class of Medicine.	Action.	Examples.
Emollients.	Give suppleness and softness to the parts to which they are applied.	Poultices, oil, glycerine, paraffin, lard, vaseline.
Expectorants.	Cause the free discharge of secretions from the air-passages.	Iodide of potassium, tartarized antimony, ipecacuanha, ammonium chloride, squill.
Febrifuges.	See Antipyretics.	
Hypnotics or Soporifics.	Induce sleep.	Opium, morphia, chloral hydrate, bromide of potassium.
Irritants and Counter-irritants.	Irritants increase the circulation in a part and restore it to a normal condition. When applied to one part of the body with the object of arresting disease in another part they are called counter-irritants.	Liniments of ammonia, turpentine, croton, iodine, biniodide of mercury, caustharides.
Laxatives.	Soften the fæces and cause a more frequent evacuation of the bowels.	Bran mashes, linseed and linseed cake, green food, small repeated doses of castor oil, linseed oil.
Mydriatics.	Cause the pupil to dilate.	Atropine, belladonna.
Myotics.	Cause the pupil to contract.	Calabar bean, eserine, jaborandi, morphine, opium.
Purgatives.	Increase the action of the bowels, promote secretion of intestinal fluid and cause intestinal evacuation.	Aloes, croton oil, linseed oil, castor oil, sodium sulphate, magnesium sulphate, calomel.
Rubefacients.	Produce slight congestion and redness of the part to which they are applied.	Soap liniment, &c.
Sedatives.	Diminish the sensibility of a part, or of the entire body.	<i>Local sedatives.</i> Aconite, belladonna, carbolic acid, chloral, opium, and morphia. <i>General sedatives.</i> Hydrocyanic acid, aconite, belladonna, chloral, opium, and morphia.
Sialogogues.	Stimulate the salivary glands and increase the secretion of saliva.	<i>Local.</i> Mustard, ginger, mineral acids. <i>General.</i> Compounds of iodine and mercury.
Soporifics.	See Hypnotics.	
Styptics.	Stop the flow of blood from divided vessels.	Mineral acids, alum, ferric chlorides, tannin, actual cautery.
Tonics.	Strengthen the body as a whole, or parts composing it.	Salts of iron, strychnia, mineral acids, quinine, nuxvomica, &c.
Vermicides and Vermifuges.	See Anthelmintics.	

PRESCRIPTIONS

HORSE BALLS

ALTERATIVE

Nitrate of Potash 1 dram
 Sublimed Sulphur 1 dram
 Powdered Aloes 1 dram
 Linseed Flour 3 drams
 Soft Soap, sufficient to make a Ball.

or

Powdered Fenugreek 1 dram
 Chloride of Sodium 1 dram
 Black Sulphur 2 drams
 Linseed Flour 3 drams
 Soft Soap, sufficient to make a Ball.

ASTRINGENT

Powdered Cassia Bark 1 dram
 Powdered Opium ½ dram
 Powdered Catechu 1 dram
 Linseed Flour 3 drams
 Soft Soap, sufficient to make a Ball.

or

Powdered Catechu 1 dram
 Powdered Cinchona Bark 1 dram
 Prepared Chalk 2 drams
 Powdered Aniseeds 1 dram
 Linseed Flour 2 drams
 Soft Soap, sufficient to make a Ball.

BROKEN WIND

Calomel 20 grains
 Powdered Digitalis Leaves 20 grains
 Powdered Opium 20 grains
 Powdered Camphor 20 grains
 Linseed Flour 3 drams
 Soft Soap, sufficient to make a Ball.

To be given once or twice a week.

CORDIAL

Powdered Aniseeds 1 dram
 Powdered Gentian Root 1 dram
 Powdered Pimento 1 dram
 Linseed Flour 3 drams
 Soft Soap, sufficient to make a Ball.

or

Powdered Ginger 1 dram
 Powdered Gentian 1 dram
 Powdered Fenugreek 1 dram
 Powdered Caraway Seeds 1 dram
 Linseed Flour 2 drams
 Soft Soap, sufficient to make a Ball.

COUGH

Powdered Squill 1 dram
 Powdered Liquorice 1 dram
 Powdered Ipecacuanha 1 dram
 Powdered Aniseeds 1 dram
 Linseed Flour 2 drams
 Soft Soap, sufficient to make a Ball.

or

Powdered Gum Ammoniacum 1 dram
 Powdered Belladonna Leaves 1 dram
 Powdered Caraway Seeds 1 dram
 Powdered Camphor 1 dram
 Linseed Flour 2 drams
 Soft Soap, sufficient to make a Ball.

or

Nitrate of Potash 2 drams
 Powdered Digitalis Leaves 10 grains
 Linseed Flour 3 drams
 Soft Soap, sufficient to make a Ball.

DIURETIC

Nitrate of Potash 1 dram
 Powdered Resin 2 drams
 Oil of Juniper 30 drops
 Linseed Flour 3 drams
 Soft Soap, sufficient to make a Ball.

or

Venice Turpentine ½ oz.
 Aloes 1 dram
 Linseed Flour, sufficient to make a Ball.

FEVER

Powdered Camphor 1 dram
 Powdered Epsom Salts 1 dram
 Nitrate of Potash 2 drams
 Powdered Liquorice Root 1 dram
 Linseed Flour 2 drams
 Soft Soap, sufficient to make a Ball.

or

Emetic Tartar	1/2 dram
Bicarbonate of Potash	1 dram
Powdered Camphor	1 dram
Linseed Flour	3 drams

Soft Soap, sufficient to make a Ball.

PHYSIC

Barbados Aloes	5 drams
Ground Ginger	1 dram
Linseed Flour	1 dram

Soft Soap, sufficient to make a Ball.

TONIC

Powdered Sulphate of Iron	2 drams
Powdered Gentian	1 dram
Powdered Aniseeds	1 dram
Linseed Flour	2 drams

Soft Soap, sufficient to make a Ball.

or

Powdered Nux Vomica	1 dram
Powdered Ginger	1 dram
Powdered Caraway Seeds	1 dram
Linseed Flour	2 drams

Soft Soap, sufficient to make a Ball.

or

Quinine	15 grains
Powdered Gentian	1 dram
Powdered Caraway Seeds	1 dram
Linseed Flour	3 drams

Soft Soap, sufficient to make a Ball.

WORM

Barbados Aloes	1 dram
Powdered Sulphate of Iron	2 drams
Santonine	12 grains
Linseed Flour	3 drams

Soft Soap, sufficient to make a Ball.

or

Tartarated Antimony	1 dram
Powdered Gentian	2 drams
Powdered Sulphate of Iron	1 dram
Linseed Flour	3 drams

Soft Soap, sufficient to make a Ball.

Worm balls should be given in the morning on an empty stomach.

POWDERS**ALTERATIVE**

Powdered Gentian	1 dram
Black Antimony	1 dram
Nitrate of Potash	2 drams
Powdered Aniseeds	1 dram

Mix: for a dose.

or

Chloride of Sodium	1 dram
Black Sulphur	1 dram
Powdered Epsom Salts	2 drams
Powdered Aniseeds	1 dram

Mix: for a dose.

ASTRINGENT

Prepared Chalk	3 drams
Powdered Cassia Bark	1 dram
Powdered Catechu	1 dram
Powdered Calumba Root	1 dram

Mix: for a dose.

or

Powdered Opium	1/2 dram
Powdered Charcoal	2 drams
Tannic Acid	10 grains
Powdered Gentian	1 dram

Mix: for a dose.

or

Powdered Sulphate of Copper	1 dram
Powdered Oak Bark	2 drams
Powdered Cinnamon Bark	1 dram
Powdered Aniseeds	1 dram

Mix: for a dose.

CONDITION

Nitrate of Potash	1 dram
Chloride of Sodium	1 dram
Black Sulphur	1 dram
Powdered Caraway Seeds	1 dram

Mix: for a dose.

or
 Powdered Fenugreek ... 1 dram
 Powdered Resin ... 2 drams
 Nitrate of Potash ... 1 dram
 Flowers of Sulphur ... 1 dram
 Mix: for a dose.

or
 Powdered Liquorice Root ... 2 drams
 Black Antimony ... 1 dram
 Powdered Caraway Seeds ... 1 dram
 Quinine ... 15 grains
 Mix: for a dose.

CORDIAL

Powdered Aniseeds ... 1 dram
 Powdered Coriander Seeds ... 1 dram
 Powdered Pimento ... 1 dram
 Powdered Gentian ... 1 dram
 Mix: for a dose.

or
 Powdered Liquorice Root ... 1 dram
 Powdered Gentian ... 1 dram
 Powdered Ginger ... 1 dram
 Powdered Cinnamon Bark ... ½ dram
 Mix: for a dose.

COUGH

Powdered Camphor ... 1 dram
 Powdered Squill ... 1 dram
 Powdered Aniseeds ... 1 dram
 Powdered Belladonna Leaves ... ½ dram
 Mix: for a dose.

or
 Powdered Fenugreek ... 1 dram
 Powdered Gum Ammoniacum ... 1 dram
 Powdered Squill ... 1 dram
 Powdered Liquorice Root ... 1 dram
 Mix: for a dose.

DIURETIC

Nitrate of Potash ... 2 drams
 Powdered Resin ... 1 dram
 Powdered Juniper Berries ... 1 dram
 Mix: for a dose.

FEVER

Powdered Camphor ... ½ dram
 Nitrate of Potash ... 1 dram
 Tartarated Antimony ... ½ dram
 Powdered Liquorice Root ... 1 dram
 Mix: for a dose.

or

Powdered Epsom Salts ... 1 ounce
 Powdered Belladonna Leaves ... 1 dram
 Nitrate of Potash ... 1 dram
 Powdered Aniseeds ... 1 dram
 Mix: for a dose.

TONIC

Quinine ... 10 grains
 Ground Ginger ... 30 grains
 Powdered Gentian ... 2 drams
 Mix: for a dose.

or

Powdered Sulphate of Iron ... 1 dram
 Powdered Nux Vomica ... ½ dram
 Powdered Aniseeds ... 1 dram
 Powdered Liquorice Root ... 1 dram
 Mix: for a dose.

WORM

Santonine ... 15 grains
 Powdered Sulphate of Iron ... 2 drams
 Powdered Aniseeds ... 1 dram
 Mix: for a dose.

or

Emetic Tartar ... 1 dram
 Powdered Calumba Root ... 1 dram
 Powdered Sulphate of Iron ... 1 dram
 Powdered Coriander Seeds ... ½ dram
 Mix: for a dose.

DRAUGHTS

ASTRINGENT

Tincture of Catechu	$\frac{1}{2}$ ounce
Tincture of Opium	1 ounce
Powdered Cinnamon Bark	1 dram
Prepared Chalk	2 drams
Powdered White Sugar	2 drams

Mix as a draught in a pint of warm water.

COLIC

Laudanum	$1\frac{1}{2}$ ounce
Compound Tincture of Cardamoms	$\frac{1}{2}$ ounce
Tincture of Aconite	15 drops

Mix. To be given in a pint of cold water.

or

Spirit of Turpentine	1 ounce
Oil of Peppermint	15 drops
Tincture of Ginger	1 ounce
Glycerine	$\frac{1}{2}$ ounce

Mix. To be given in a pint of warm linseed gruel.

CORDIAL

Compound Tincture of Cardamoms	$\frac{1}{2}$ ounce
Compound Tincture of Gentian	1 ounce
Tincture of Calumba	$\frac{1}{2}$ ounce
Tincture of Ginger	$\frac{1}{2}$ ounce

Mix. To be given in a pint of warm ale.

DIURETIC

Spirit of Turpentine	$\frac{1}{2}$ ounce
Sweet Spirit of Nitre	1 ounce
Oil of Juniper	10 drops

Mix. To be given in a pint of linseed tea.

FEVER

Spirit of Nitrous Ether	1 ounce
Aromatic Spirit of Ammonia	1 ounce

Mix. To be given in a pint of cold water.

PURGATIVE

Linseed Oil	1 pint
-------------	-----	-----	--------

or

Barbados Aloes	5 drams
Tincture of Ginger	$\frac{1}{2}$ ounce
Oil of Peppermint	10 drops

Dissolve the aloes in a pint of warm water and add the other ingredients when cool.

TONIC

Compound Tincture of Gentian	1 ounce
Tincture of Calumba	1 ounce
Tincture of Cinchona	$\frac{1}{2}$ ounce

Mix. To be given in a pint of cold water.

or

Compound Tincture of Cardamoms	1 ounce
Nitric Acid	1 dram
Tincture of Nux Vomica	$\frac{1}{2}$ ounce

Mix. To be given in a pint of cold water.

ADMINISTRATION OF MEDICINES

The action of medicines will be found in another part of this work (pp. 1 and 12 of this volume), and it is proposed in this chapter to deal with the various methods of administering them which custom or convenience requires in the treatment of our patient the horse.

Medicines are conveyed into the body by one of several channels.

They may be given by the mouth as draughts, boluses, or electuaries, or by the rectum in the form of enemata, or they may be injected beneath the skin (subcutaneous injection), or directly into one or another of the superficial veins (intra-venous injection). In the form of vapour they are also inhaled, and in particular instances are injected into the trachea or wind-pipe (intra-tracheal injection).

Balls.—The practice of giving medicines in a ball or elongated pill is a very old one, and has much to recommend it. Many nauseous agents, as for example aloes, are thus conveyed to the stomach without causing annoyance and disgust to the patient. They are usually wrapped in paper or enclosed in gelatine capsules. The paper wrapper is the more

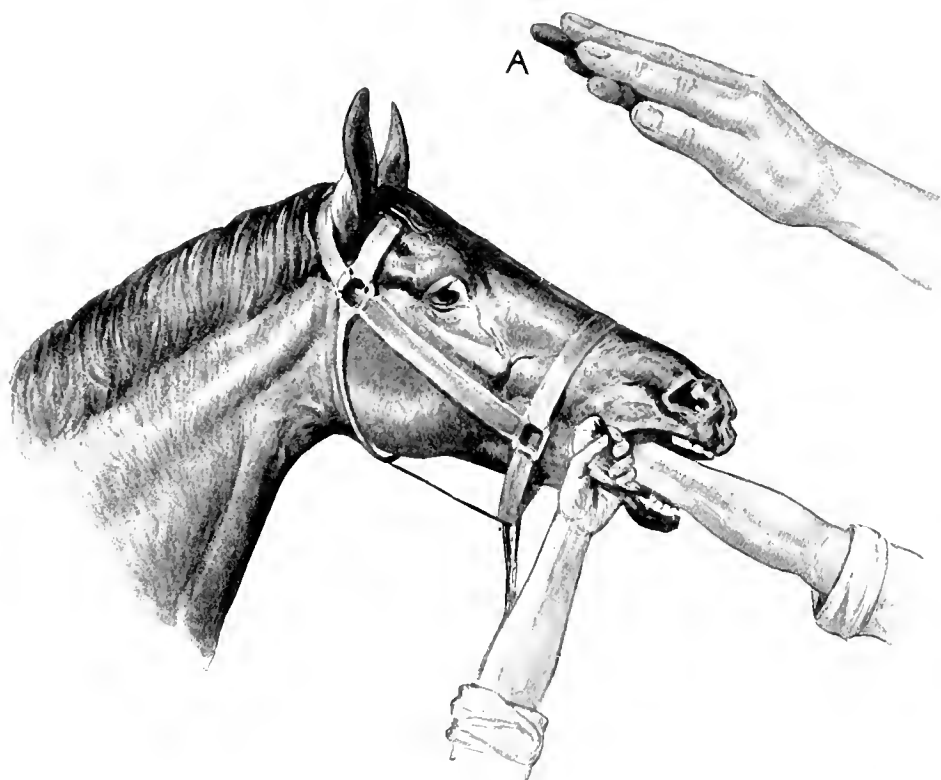

Fig. 437.—Administering a Ball. The manner of holding the ball is shown at A

convenient to hold, and the gelatine capsule the less likely to be broken in the act of being administered.

A ball weighing from one to two ounces is more convenient to administer than one smaller or larger.

It is a matter for regret that so few stablemen and others in attendance upon horses acquire the comparatively simple art of giving a ball. In the absence of this qualification there are several instruments recommended for the purpose, but none so good as the human hand properly directed.

To give a ball, the animal should be turned round in the stall and quietly approached with the bolus between the thumb and two first fingers of the right hand, which may be placed on the face to steady

his head, while the left is employed in seizing the tongue firmly but gently across its middle (fig. 437). Two or three inches of tongue should project beyond the hand and be turned up to the tush on the horse's right side. The ball is then quickly carried along the mouth and

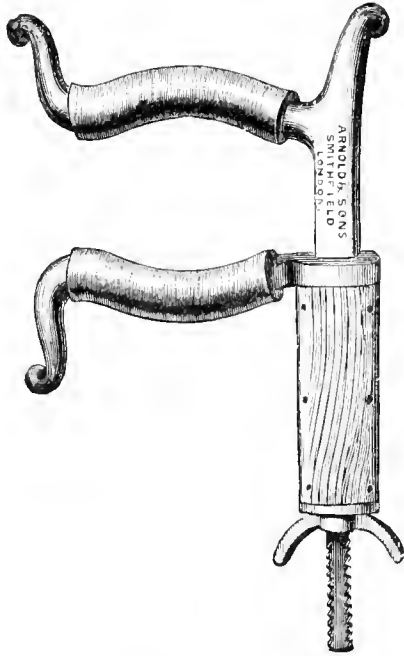

Fig. 438.—A Horse-Gag

dexterously placed high upon the back of the tongue, and the hand withdrawn; the tongue is then released, and the free end of the balter quickly wound round the jaws, while the operator takes a step to the right to watch the downward course of the ball along the channel of the neck. If it is not seen to pass, it is well to wait for a moment or two, as some old stagers will appear quite quiet until released and then cough up or quietly drop the ball from the mouth when unobserved. If it does not appear to have been either swallowed or ejected, water may be offered, and, if taken, one may be pretty sure that the bolus has reached the stomach.

A gag (fig. 438) or "balling iron" is sometimes used to fix the mouth open. If the reader will try to swallow with his own mouth open, he will realize that it is not

a desirable instrument to employ for this purpose, although it has its uses, as will be seen elsewhere.

The same difficulty of deglutition applies when the improved mouth-gag or speculum of Mr. Huish is used.

A simpler and safer instrument is the balling-gun (fig. 439), made on the principle of a child's pop-gun, with an enlarged end to contain the



Fig. 439.—Balling-Gun

bolus. Another, with a spring and a trigger, sometimes forms a mural ornament in the veterinary surgeon's establishment, but is rather a dangerous implement in the hands of a novice, while unnecessary in the case of the expert, who is satisfied to wear a leather glove on his right hand and secure himself from injury by holding the tongue in the manner already described. Where malignant disease is suspected, but not

determined, the use of instruments is desirable to avert risk to the attendants.

The Drench or Draught.—Liquid medicines are commonly given in the form of drenches or draughts, so diluted with water, oil, or gruel as to exercise no baneful influence upon the structures over which they pass to reach the stomach.

Persons accustomed to give medicine in this form often prefer to do so without any assistance or restraint beyond holding the head up by placing the left hand under the chin, but where the patient cannot be controlled by this means he must be subjected to restraint by one of the methods prescribed elsewhere. (See Means of Restraint.)

A horn is a safe and suitable means of administering a drench so far as the patient is concerned, as it may come in contact with his grinders without being broken. The tin bottle with a long neck and flat sides is more easily grasped, but the contents cannot be seen in either of these vessels, and perfect cleanliness is not so well assured as

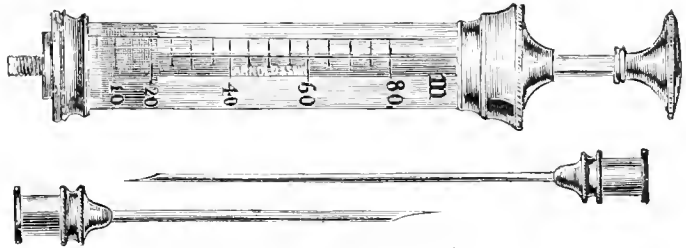

Fig. 140. —Syringe and Needles

when using glass bottles of the champagne type. These being strong at the shoulder, and conveniently tapered at the neck, are generally preferred, the risk of breaking in the mouth when properly handled being very slight.

Draughts should be given slowly to horses, and if a disposition to cough is observed, the head should be immediately lowered, and, although some of the medicine may be lost it is better than forcing it the "wrong way".

Liquid medicine should never be given with the horse's head towards the manger, as some of it will almost certainly fall into that receptacle and give the patient a distaste for his food.

Electuaries.—In cases of sore-throat, where there is difficulty in swallowing, or of injuries to the mouth, where it is not desirable to open it forcibly, medicines may be made up to the consistence of ordinary jam and smeared upon the back parts of the tongue by means of a paper-knife or smooth, flat piece of wood.

These are known as electuaries, and are several times referred to in the section treating of diseases of the respiratory system.

Intra-tracheal Injections.—Remedies intended to have immediate contact with the lining membrane of the bronchial tubes are administered by the hypodermic syringe (fig. 440), by puncturing the windpipe at a

convenient spot about half-way between the throat and the chest, and propelling the contents of the syringe into the passage.

The skin over the portion selected should be rendered tense with the fingers of the left hand, while the right is employed in inserting the needle and directing it in a forward and downward direction. Horses commonly submit to this operation without much restraint, the slight pain caused ceasing when the needle has passed through the skin.

Subcutaneous Injection.—The instrument alluded to in the foregoing paragraph is also employed to introduce medicines into the circula-



Fig. 441.—Making a Subcutaneous Injection in the Neck

tion by injecting suitable solutions of active agents into the loose tissues beneath the skin (fig. 441). The position chosen for the purpose is of no great importance, but safety to the operator and convenience alike suggest the loose folds behind the elbow.

Intra-venous Injection is another method occasionally employed, and consists in injecting medicines directly into one or another of the superficial veins of the body. The vessel most commonly used for this purpose is the jugular vein. The operation, however, is one which should only be performed by the expert veterinarian.

24. NURSING

THE NURSE

The medical attendant anxious to enlist the good-will of the unpaid nurse may often be heard to say that the welfare of the patient depends largely upon her good offices. If this is so with the patient who can and does freely express complaints in respect of these "ministering angels", how much more necessary is it that sick animals, unable to voice their wrongs, should have in an attendant an individual at once faithful and assiduous in his duties. There is nothing more disheartening to the veterinary practitioner than to feel that he has heedless and incompetent persons to carry out his instructions; and such are the majority of persons to whom sick animals are entrusted. In a work dealing with the ailments of the horse it will therefore be well to consider a few of the conditions that make for recovery, and the means used in the treatment of the sick and lame.

THE SICK-BOX

With few exceptions a loose box is recommended for a horse that is ill, and for several reasons. To begin with, it should be light and cheerful, and a temperature of about 55° Fahr. will in most cases be sufficiently high. It should be well ventilated, but free from draught.

Where the ménage will permit, the sick-box should be wholly detached from all other stables, as a disease about which there may have been doubt at first even to the expert, may at any time prove to be contagious. It should, of course, be properly drained. Horses are of necessity kept in some places where these conditions cannot be provided. In such circumstances special attention should be given to ventilation, and the sanitary state of the stable should in every particular be made as complete as possible.

In cases of lameness or injury, where no possible harm to others can result, a horse may remain in sight and sound of his usual companions with advantage, as his gregarious instincts are offended when condemned to solitary confinement unless he is too ill to care about his surroundings. In a state of nature a sick animal leaves the herd, an instinct which may be accounted for in several ways, but the injured one tries to keep up with his fellows. The door of the sick-box should always open outwards, or the attendant may be unable to enter when the patient is prone and cannot rise.

There should be as little furniture as possible, and that should be capable of easy removal for cleansing and disinfection; after recovery or death of the patient the whole of the stable should be whitewashed before introducing another animal into it, while other and more effectual measures of sanitation must be resorted to where an infectious disease has been treated. (See Disinfection.)

Special circumstances will have to determine the bedding to be employed for invalid horses. For example, a case of laminitis, in which poultices or wet swabs are not still in use, may be benefited by the employment of peat-moss rather than straw, which, when not frequently turned and changed, soon becomes offensive; or saw-dust obtained from deal or pine.

In pulmonary diseases, where dust is objectionable, peat-moss and saw-dust are both unsuited to the sick-box.

In cases of paralysis, long straw gets heaped up or scraped together by the patient's ill-directed movements, and the skin covering the most prominent points is liable to injury from the bare floor. Straw in trusses may be cut through with a hay-knife in these cases, and when short is less liable to be collected about the animal's legs. Whether straw, hay, or ferns are used, the bedding should be constantly forked over, and if the patient is unable to rise, he should be made comfortable by being turned over at least once in the twenty-four hours, and assisted to maintain a reposeful attitude by suitable packing placed under the withers and elsewhere. A convenient posture is of course conducive to sleep, the necessity for which appears to be too often overlooked in regard to equine patients, because it is well known that in health they require comparatively little of "nature's sweet restorer".

Clothing.—Where practicable it is desirable to keep up the temperature of the stable by artificial means rather than overload the patient with clothing, which may become a burden and annoyance if he is not accustomed to it. Exception may be taken to this in cases of pulmonary congestion, where a pure cool air is desirable. Here the surface warmth must be kept up by rugs, bandages, and hoods. The clothing chosen should be light and warm, frequently changed, shaken, and, if necessary, dried before replacing it. All clothing worn by an animal suffering from a contagious disease should be well washed and disinfected, after which it may be dried in the open and then baked.

Water.—With a few exceptions elsewhere mentioned, the sick horse should have an abundant supply of pure water, which should not be warmed as is sometimes done by allowing it to stand in the stable, but, if the season is such as to require it, by adding to it some that has

been artificially heated. Horses will seldom drink water that approaches the temperature of the animal body, and when the word "warm" is mentioned, a temperature of about 80° Fahr. is understood.

INVALID FOOD

One of the most important duties, and probably the least understood by the average groom, is the preparation of food out of the usual routine. As with human patients, so with horses, recovery may be often said to date from the first tempting meal the sufferer can be induced to eat. It is a matter of common knowledge that horses in health are often fastidious about food, and will reject it when offered in a bucket or other vehicle that is not perfectly clean; much more is this the case in sickness, and we have too often seen cooked food offered that has been burned or otherwise spoilt in the preparation. The invalid should be tempted by variety, no great quantity offered at one time, and what is left should be scrupulously removed before the patient has "blown" over it and become disgusted.

Where no food whatever is voluntarily taken it is sometimes necessary to introduce aliment in other ways, as by drench and enemata, and this should be done as quietly and gently as possible; a golden rule, to be observed in all dealings with sick horses, as unnecessary noise and excitement is at all times prejudicial to an animal so highly nervous as the horse.

The food used for sick horses should always be of a nourishing or sustaining character, and in some instances it is an advantage if it possesses laxative properties.

In the first class we include eggs, milk, biscuits, bread, meals, beef-tea, and the popular forms of alcohol, as wine, spirits, and malt liquors. Some of these the patient may be induced to take voluntarily, and others will have to be given with more or less coercion. In the second class are included some foods that are of nutritive value, but whose chief characteristic is their effect in keeping the bowels in a lax condition and reducing the tendency to constipation and fever.

Eggs and milk are frequently given together, by whipping both the yolks and the whites, and adding the milk gradually. If the patient can be induced to drink such sustaining and easily assimilated food, it may be mixed in the proportion of half-a-dozen eggs to a gallon of new milk, but some horses will be found to take separated or skim milk though refusing the "whole". If it has of necessity to be given in the form of a drench, it is desirable to reduce the bulk and give as much as

three eggs whipped with a quart or less of new milk, and at shorter intervals than would be allowed where a greater quantity of nutriment is taken at one time.

It is always more or less distressing to the patient to be coerced with food either in liquid or solid form, and when this becomes necessary the temperament of the individual should be considered. One horse will take a fluid from a bottle more readily than in the form of a ball, while another that has been carefully handled may be sustained with balls made of oatmeal and treacle, or linseed, or capsules containing concentrated foods, as bovril, Brand's essence, or hard-boiled eggs carefully minced.

The Laxative Foods include green meat of all kinds, as grass, lucerne, vetches, sainfoin, clover, carrot-tops, green maize, wheat, oats, barley and rye, parsnips, beet, mangolds, turnips, kohlrabi, apples, linseed gruel, oatmeal and linseed mashes, linseed oil, linseed tea, bran mashes, and hay tea, sugar, molasses, and boiled grain.

The Green Foods cut and carried to the sick-box should not be cast down in a heap to ferment and become stale, but a small quantity only should be given at a time; neither should such fodder be served with a heavy dew upon it, but should be spread out for a little while in the fresh air until the surface moisture has been for the most part removed.

If rye grass and clovers have been grown very fast and are of a watery nature, they should be chaffed with a little hay, which serves the double purpose of ensuring perfect mastication and correcting its too laxative action.

In the tropics, bamboo and sugar-cane are used as green fodder, and boiled moong, urud, and kulthee.

Bran Mash.—No one connected with horses could be found who would admit his incapacity to make bran mash, yet how often do we find it given scalding hot on the top, and dry and cold at the bottom, sometimes causing an impatient horse to paw, and maybe strike his knees against the manger. In this way an invalid "put off his fancy" for the time often declines to eat when the food has sufficiently cooled. The proper way to prepare a bran mash is to scald the vessel in which it is to be mixed, pour into it three pints of boiling water, add three pounds of bran and a dessert-spoonful of salt, stir well with a clean stick, cover over for half an hour, and offer it to the animal when cool enough to place one's naked elbow in it.

A Bran and Linseed Mash should be prepared by boiling slowly—simmering, as cooks describe it—for two or three hours. Half a pound of linseed, one pound of bran, a dessert-spoonful of salt, and three quarts

of water thus treated will make a jelly-like mash more acceptable to the majority of horses than if made sloppy by the addition of a greater proportion of water.

Linseed Tea.—Here the seed should be “simmered” for a long time, in order to extract the full value from it. In some well-ordered establishments the tea intended for evening consumption stands in readiness on the hob all day. Half a pound of linseed to a gallon of water is a suitable proportion. It is, of course, a misnomer to speak of boiled foods as “tea”, but we may with propriety use the term when making an infusion of hay.

Hay Tea.—A perfectly clean bucket being chosen and warmed by pouring in boiling water and throwing it away, we choose the best old hay and pack it quickly and tightly into the vessel, fill the latter with boiling water, cover closely, and allow it to remain until cold. The tea should then be carefully decanted, so that the seeds do not pass over.

Linseed Oil is spoken of as a food as well as a medicine, and is frequently prescribed as such. As a laxative it is given in quantities of two or three table-spoonfuls in the food morning and evening, and so employed is the best substitute for green meat. The majority of horses will take it, but some prefer linseed cake, which is more nutritious and fattening than it is laxative, but may serve as a bait to enable the animal to acquire a liking for the expressed oil.

Roots, of which the carrot and beet are the most nutritious, the turnip and mangold the most laxative, are usually given raw. The sick horse may be tempted sometimes by scraping a carrot under his nose and cutting slices of a convenient size; in this way he is afforded a certain amount of amusement, and the appetite which has been in abeyance may be reawakened. The chaff-cutter may be utilized for these vegetables, and oatmeal or other sustaining food sprinkled over the slices and made appetizing by the addition of salt or some of the many condiments now in the market.

Boiled or cooked roots are sometimes prescribed for sick animals, but they are found to be undesirable in health, having a tendency to produce flatulence and dyspepsia generally. For the same reason potatoes are not included in a sick diet.

Gruel.—This food is often recommended without any specific instructions as to *what* gruel, and unless linseed or other descriptive name is used, oatmeal is understood. It is best prepared by adding the meal to cold water in the proportion of one pound to the gallon. It should be placed over a quick fire, and continually stirred to prevent dry particles from adhering to the bottom and sides of the sauce-pau. As it approaches boiling-point

the cook should be more assiduous than ever with his wooden spoon, as there is no food more easily spoilt. As soon as it begins to thicken it should be removed from the fire and emptied into another vessel, and allowed to cool before being offered to the patient. Oatmeal and water is sometimes spoken of as gruel, and is given to horses when severely taxed, or on long journeys when time cannot be spared for a "square" meal. It is both sustaining and stimulating, and when properly prepared very acceptable both to the sick horse and to others when fatigued with a hard day's work.

Boiled Barley.—When barley or other grain is boiled, the bulk of water should be twice that of the grain, unless it has been previously swelled up by soaking for many hours. Cooked in this way it absorbs nearly all the water, and comes out plump but not broken up. Salt is always recommended with cooked foods as rendering them more digestible.

Pearl Barley.—This is employed to make a cooling drink, the grain itself being usually rejected. A pound may be allowed to each gallon of cold water, and it should be permitted to remain at a gentle heat for several hours, as recommended for linseed tea.

POULTICES AND POULTICING

Although not a fine art, there is a right way and a wrong one in the apparently simple operations of making and applying poultices in the treatment of disease.

Poultices are made of a variety of materials, and require a certain amount of care if not skill for their proper preparation, and still more in their application to different parts of the body and limbs. To maintain them in position is often a matter of some difficulty, and requires of the attendant a considerable amount of tact and nice judgment, as we cannot look to our patient for assistance in these matters, but may expect more or less opposition. He will tread them off his feet, and often enough eat them, if in any convenient position to be got at.

The materials in most general use are bran, linseed meal, ground linseed, and bread, but any substance that will hold water and retain its temperature may be employed so long as it contains no objectionable properties. In country districts poultices are often prepared from turnips, potatoes, carrots, or other roots, Swedes being specially favoured in some parts.

The custom of using cold poultices has so far fallen into desuetude that we need only consider those employed to maintain warmth and moisture, with others to which certain medicaments are added for special purposes.

In this latter connection it is sometimes found necessary to employ such agents as mustard, carbolic acid, charcoal, chlorinated lime, belladonna, opium, &c. &c., and the prescriber who may desire to use them will, of course, give precise instructions, not only as to the agent to be used, but also as to whether it is to be mixed with the poultice, or merely placed upon it so as to rest upon a particular spot, as in the case of certain wounds requiring special agents in application with one part and not the whole.

When it is intended to apply a poultice, the necessary materials should first receive attention; the novice too often finds himself with a mass of hot bran or linseed and nothing to hand with which to apply it, or he has prepared too much or too little for the purpose.

To make a Bran Poultice.—A clean bowl or basin is always to be preferred to a stable-bucket, unless a very large quantity has to be dealt with. The amount of bran required is put into the bowl, and boiling water added by slow degrees and with constant stirring. Unless it is done in this way there will be portions almost dry or caked together, and the remainder too thin and sloppy. Bran takes up a large amount of water, and with each stirring will receive more until thoroughly saturated. It is better to squeeze out the superfluous moisture through a cloth than to apply your poultice too wet. The rapid evaporation and tendency on the part of bran to become sour is an objection to its use alone, and it is for this reason very commonly combined with an equal portion of linseed flour, or, what is still better, crushed linseed which has not been deprived of the oil.

A linseed-and-bran poultice prepared in the manner referred to is probably the most serviceable of any, as it has the merit of retaining its warmth and moisture for a long time, while the oil it contains renders it emollient and comforting to the patient.

Crushed linseed is used alone as a poultice where it is particularly desired for its softening and emollient effect, but it does not retain heat so long as when mixed with bran, and fails to adhere so well.

Bread is a convenient substitute for meals, and can be more quickly prepared than any other cataplasm. It has just the opposite objections to linseed, in that it sticks to the skin too persistently, easily dries, and is with difficulty removed.

Bread is improved by the addition of glycerine, the effect of which is to keep it moist for a longer time and prevent it becoming sour.

Treacle mixed with linseed makes it more adhesive, and what is known as more "drawing", in its effects.

Turnips and other roots are boiled until thoroughly soft, mashed, and squeezed in a cloth to get rid of superfluous moisture. When first prepared they are very much too hot to be applied with safety, and cool down

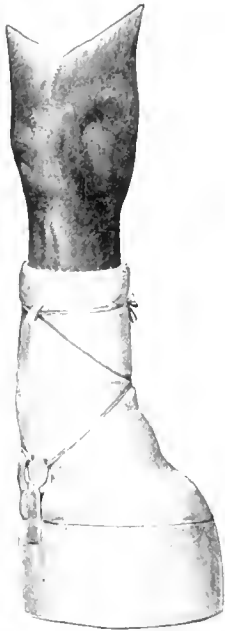

Fig. 442. Poultice-Boot

so rapidly that they are at best poor substitutes for bran and linseed meal. They are, however, useful substitutes when the latter are not to hand.

The Application of Poultices or Cataplasms.—

Since these may be required on any part of the animal, from the sole of his foot to the top of his withers, and from his face to the end of his tail, it follows that many and diverse methods must be adopted to retain them in the desired position. The first-named part is perhaps the easiest of all on which to fix them securely.

If the whole foot has to be included in the treatment, a considerable amount of material is required, and a poultice-boot (fig. 442) or leg-bucket is to be preferred to anything else; but as this is a luxury not in the possession of the average horse-owner a substitute must be sought for, the most suitable material being a piece of sacking or old rug. The pieces intended for use should be formed into a bag sufficiently large to receive the foot, and long enough to reach the middle of the cannon-bone. Some of the poultice should then be put into the bag, which is now drawn over the foot, and the remainder packed well

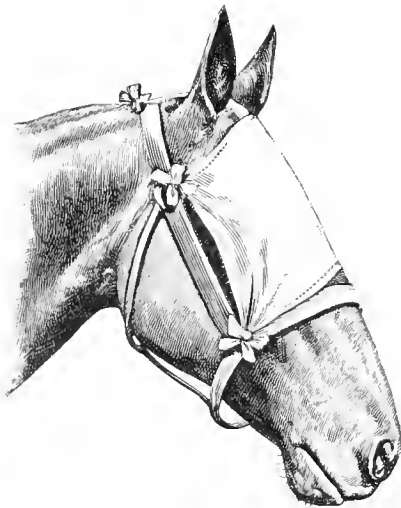

Fig. 443.—Poulticing the Head



Fig. 444.—Poulticing one Side of the Head

round the outer side of the foot as high as the pastern. Whatever may be the disease for which the application is made, it should be borne in mind that the inflammatory action will extend beyond the seat of the

injured part, and the greatest benefit will be obtained by thoroughly enclosing the foot in the poultice.

To secure the bag to the limb, tape or strong cord may be used.

The importance of having plenty of material under the binder should be impressed upon the beginner, so that he may make the poultice perfectly secure without the danger of excoriating or otherwise injuring the skin beneath.

A more workmanlike plan of retaining a poultice on the foot is that of bandaging over it from the coronet upwards.

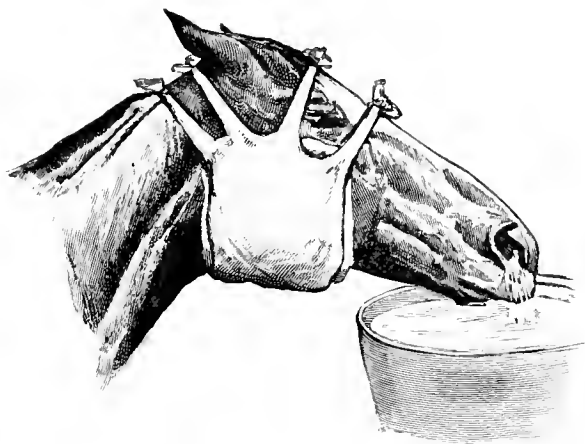

Fig. 445.—Poulticing the Throat

The Heel is perhaps as convenient a situation as any for adjusting a poultice, nothing but a bandage being needed to keep it in position, but it is a highly sensitive portion of the horse's skin, and a good nurse will support his cataplasm on some soft material. A piece of tow spread out to the desired breadth serves the purpose well. It has been elsewhere remarked, and its importance permits of repetition here, that no application to the integument of the horse should be hotter than will be found comfortable to the bare elbow of the attendant. Many bad heels are made worse by neglect of this precaution, and the same remark applies to those cases where poultices are allowed to become stale before being changed.

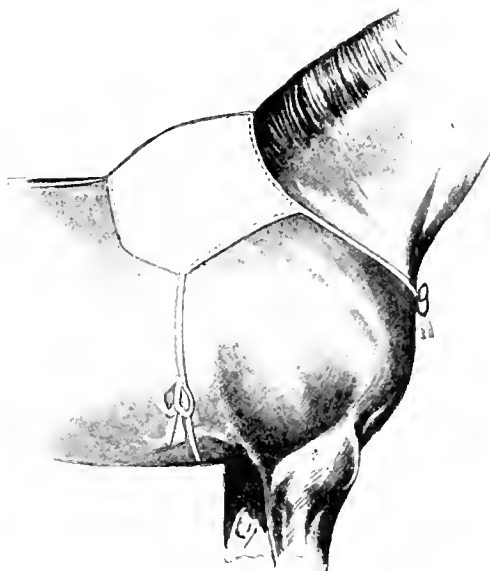

Fig. 446.—Poultice applied to the Withers

The Fetlock presents but one difficulty in the retention of a poultice, and that is its roundness, and the tendency of the latter to slip down. To prevent this a long bandage is first rolled round the pastern below to form a support, and then continued lightly but firmly over the poultice.

Any other portion of a front leg, including the knee, may be dealt with in the same manner. In the absence of a bandage, an old stocking from which the foot has been removed may, by being drawn over the leg, serve the purpose, but it fails to keep in the heat as does a flannel bandage.

The Hock is a most difficult joint upon which to retain a poultice. The movements of this joint are so extensive, that a special bag must be made of such a size and form as to embrace the whole of the joint and allow of its being securely fastened above and below. In adjusting the

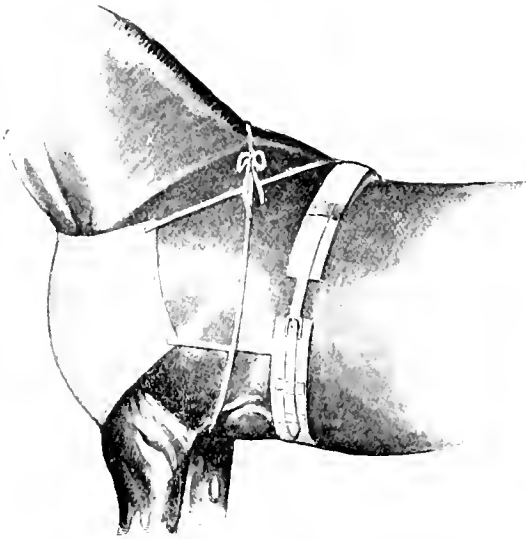

Fig. 447.—Poultice applied to the Breast

poultice, the stocking should first be drawn into position, then tied below with tape or bandage, and, lastly, the material composing the poultice should be introduced and well packed round the joint.

The Head.—When poultices have to be applied to any part of the head or face, it is usual to make the leather head-collar serve as a support, while a hood may also be utilized to retain them in such positions as the poll, the eye, the face, &c. In poulticing the throat, nothing serves better for adjustment than a couple of flannel bandages;

but if it is required to embrace the space behind the jaws, the throat bandage (fig. 445) must be employed.

The Withers and back can be poulticed by means of portions of strong flannel, or, what is better, old rugging, cut to suitable shapes and tied as illustrated in fig. 446.

The Sides of the Chest and Belly.—Nothing serves the purpose of adjusting a poultice to these parts better than the arrangement depicted in Plate XLVIII, where a broad sheet of rugging is suspended by six bands, two of which from either side are tied over the loins and back respectively, and two others to a collar-band in front. A seventh may be employed to attach the collar-band to the sheet between the fore limbs, to prevent its backward movement.

The Breast.—A suitable bandage for this region is that given in fig. 447.

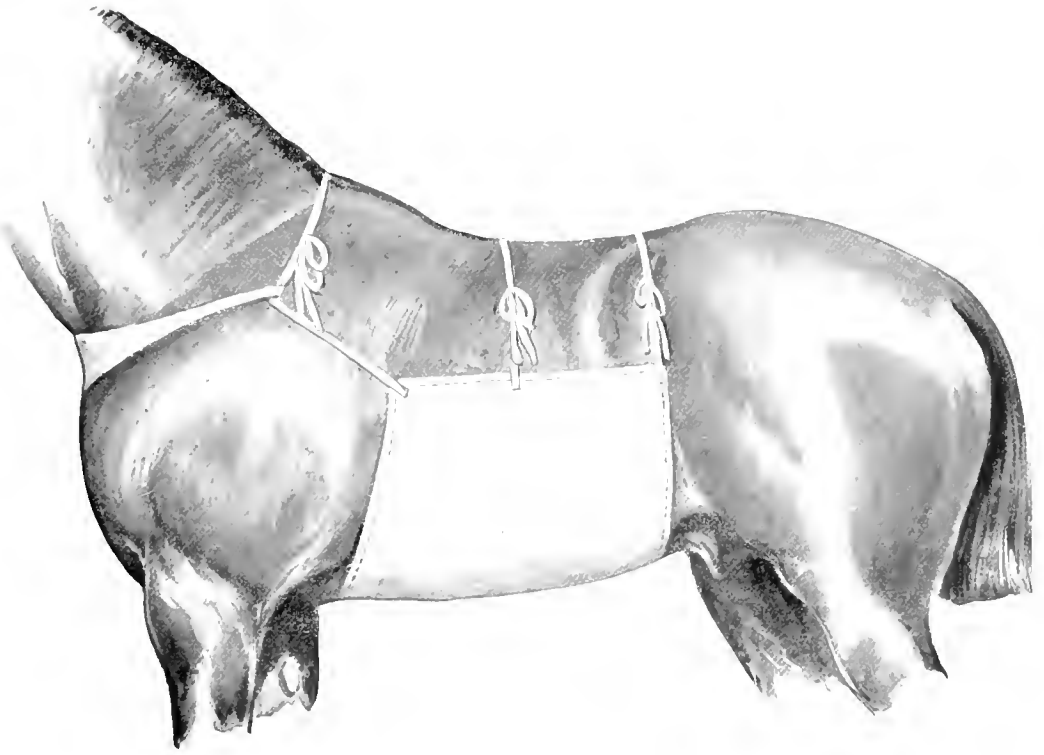

Method of applying a Poultice to the Abdomen

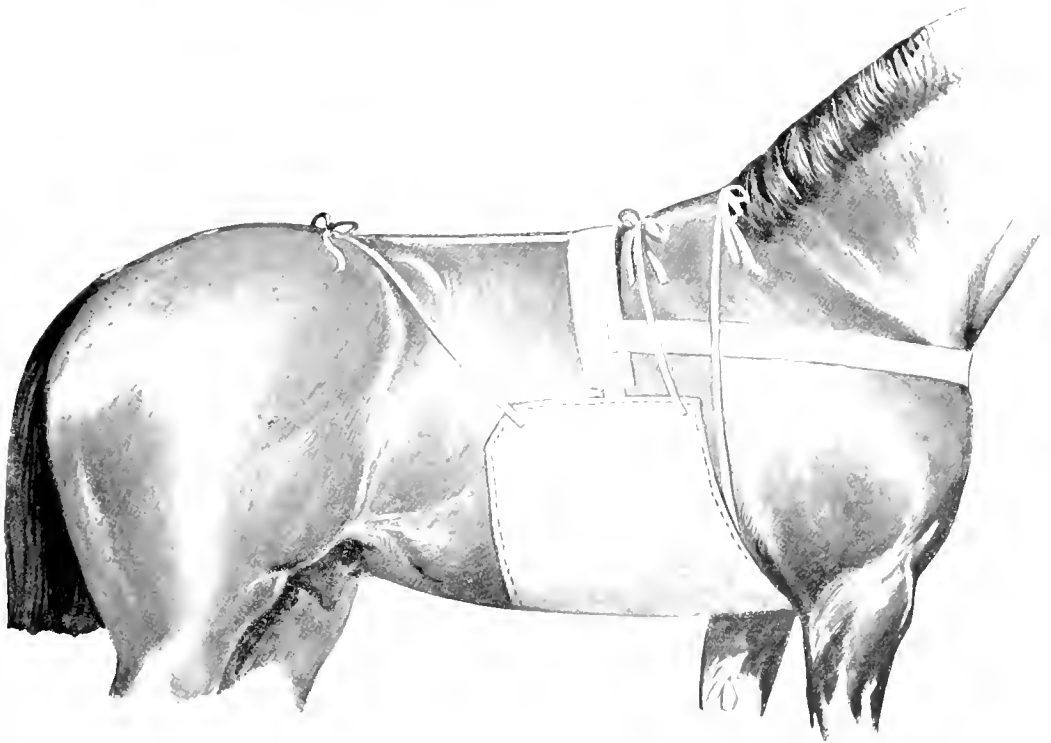

Method of applying a Poultice to the Chest

MUSTARD PLASTERS

The parts to which mustard plasters are most frequently applied are the chest and abdomen, the throat, the windpipe as far down as the breast, and the sides over the surface of the ribs.

A bowl or basin, a wooden spoon, and a jug of warm water are all the accessories required. Boiling water is not only unnecessary in the preparation of a mustard plaster, but positively objectionable on account of its driving off the active principle and reducing the potency of the mustard. Unless the patient has a long coat, mustard may be mixed with water in the proportion used for the table, but where much hair exists it must either be removed or the plaster must be made thinner, and more time expended in rubbing it in.

Coarse-bred horses are usually less susceptible to the stimulating influence of mustard, and its effects may be increased by using vinegar instead of water, or, where a severe application is intended, a table-spoonful of turpentine may be added to every quarter pound of the dry powder.

The Throat.—When this part has to be treated, the basin should not be held immediately under the animal's head, and the head should be gently elevated by an assistant while the plaster is steadily rubbed in. Whatever degree of friction is used should be equal on all the parts. It is commonly prescribed for a throat already very sore within, and care should be taken to use no unnecessary force, either in restraining the patient's movements or in making the application.

A horse thus treated should not be immediately left to his own devices, one of which is to rub his throat on the manger or other convenient fitting, and perhaps cause a lasting blemish. When the mustard is seen to be taking effect, as evidenced by the animal shaking his head, swishing his tail, and perhaps striking with his front feet, he should be spoken to in terms of compassion, and prevented from doing himself any injury. When his manner has become calm, and not until then, should he be left.

The Wind-pipe.—The directions given above apply equally to this part.

The Sides of the Chest.—A standing position favours the application of mustard to the sides, which should be applied equally all over the intended surface, avoiding the loose thin skin immediately behind the elbow; neither will it serve any useful purpose to go above the arches of the ribs in an upward direction, or down to the breast-bone below.

The Belly.—In some inflammatory diseases affecting the organs of the belly, mustard or some other counter-irritant is applied over the greater part of the abdomen. Here, care should be exercised to avoid the loose

skin of the flank, the sheath of the horse or gelding, and the teats of the mare, as the inclusion of these parts causes unnecessary pain at the time of application, and possibly obstinate sore places afterwards.

The Liver.—Where an application of mustard is advised over the region of the liver, it is understood to refer to the right side, to which the organ is more especially inclined, and it will be most effective if applied for a space of four or five inches behind the back ribs.

BACK-RAKING

Among the many services the attendant on the sick is called upon to perform may be mentioned such minor operations as the administration of clysters and enemata. These are often preceded by the operation of unloading the rectum with the hand, vulgarly known as “back-raking”. It may be as well to describe the process first.

Very little knowledge of horse ailments will be necessary to convince the reader of the importance of this performance. There are many cases in which this operation is followed by relief, especially in colic, impaction of the bowels, and in diseases of the urinary apparatus; in inflammation of the testicles in stallions, parturition in mares, and in those febrile and other conditions in which the animal is too languid, or enduring such pain as to preclude the necessary posturing and exertion to defecate. We might enumerate a great many other cases in which such aid would prove valuable, but the examples quoted will be sufficient.

To perform this task it is required that the fingers of the operator should be free from rings, and the nails closely paired. The horny hand of a person accustomed to manual labour should be previously softened by washing in hot water. Although the majority of horses submit to this performance without display of temper, it is well for a right-handed man to have the left fore-leg held up by an assistant, while the operator stands somewhat to the near side of the quarter, or, if the left arm is used, the reverse order will best serve to protect from a kick. There is practically no danger so long as the tail is held firmly erect, as a kicker always depresses the tail before “lashing out”. As a preliminary, the hand and arm should be well smeared with some vaseline, lard, or butter (free from salt), and a little may be introduced with the finger into the rectum before proceeding to unload it. In introducing the hand into the rectum the fingers are gathered together, and by gentle and persistent pressure made to enter the anal opening. At first a good deal of resistance will be met with from the muscle encircling the orifice (sphincter muscle), but by steady perseverance it will soon be overcome, and the hand and arm allowed to enter.

The contents should now be removed with no more than sufficient force necessary to accomplish the end in view, and the operation may be repeated from time to time, as may be required.

WASHING

When washing is undertaken as a curative measure in skin diseases, or as a sanitary process, there are certain precautions to be observed to make it effectual, and others to prevent the animal from taking cold.

Parasitic diseases, as mange, may have to be treated with greasy applications to the skin, which must be afterwards removed by soap and water for appearance and comfort, or washing may be prescribed to cleanse the skin preparatory to the application of remedial agents.

An abundant supply of warm water should be secured before commencing the operations—a “water” or “dandy” brush, a sponge, scraper, straw wisps, and a sunny morning should be selected if possible. In nearly every case it is well to begin with the face and head, as in any skin affection due to living parasites it is essential that no “cities of refuge”, such as the ears and eyelids afford, should be left unassailed. If the washing begins at the head, the parasites are forced backwards and are effectually cut off, or they are washed off the body. The forelock and mane require to be well soaked and brushed down to the roots of the hair, as there is always, even in well-groomed animals, a good deal of desquamated cuticle and other debris accumulated here to harbour the offender. Soft soap, with its excess of alkali, more readily “lifts” this material than the ordinary soaps. If, for this purpose, the soap is rubbed in first, there must be very copious rinsing with warm water afterwards—and a free use of the brush. The same remarks apply to the tail. The neck, shoulders, and front legs are partially washed during the time the mane is receiving attention, the back and loin being wetted last to avoid unnecessary exposure of the body to cold. The belly and legs require the least manual labour, as they have become saturated by the lather running down them from other parts. When the cleansing process has been efficiently performed, a cold douche should be given and the scraper freely applied, to relieve the coat quickly of the greater part of the fluid; then the sponge should continue the work. Exercise should then be given to establish a glow, and the dry wisps should finish the operation when the horse is brought back to the stable. Clothing should not be replaced until the skin feels warm as well as dry.

BANDAGES AND BANDAGING

Bandages are used for a variety of purposes: to give support to or restrain a limb, to maintain splints and dressings in position, to restrain bleeding, exert pressure, promote healing, and remove swelling. To effect the three last-named purposes a good deal of pressure may be necessary, and while the bandage has to be applied tightly, a considerable amount of care should be exercised to make the pressure even and avoid interference with the circulation.

Preparation and Application of Bandages.--There is no small amount of art in the proper applica-

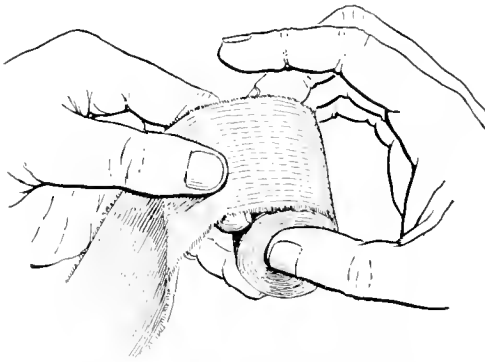

Fig. 448. --Method of Rolling a Bandage

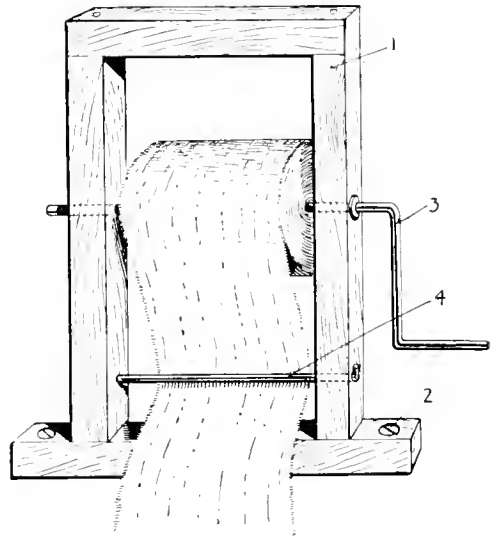

Fig. 449. A Simple Apparatus for Rolling Bandages
1, Wood framework. 2, Screw fixing to table or weight. 3, Bent stout wire crank. 4, Wire to guide and flatten bandage.

tion of bandages, as the reader may see for himself if he will compare the performance of the novice, whose bandage will not remain in position on a horse at rest, with the work of the expert which will continue intact when galloping and jumping have put it to every test.

Both woollen and linen bandages are employed for horses, the latter being suitable only in those cases where evaporation from their surface and cooling of the part is the chief object desired.

Woollen bandages are used for a very great variety of purposes, and practice alone can render the attendant expert in their application. A few hints may here be given that will be found to bear fruit.

In preparing a bandage for application to the limb, the tapes attached to one end will require to be gathered together and the bandage rolled round them so as to make a small cylinder, which is to be held between the thumb and middle finger of the right hand, whilst the free portion of the bandage rests upon the index finger of the left hand (fig. 448). Thus held

and supported it is rolled up into a firm regular cylinder. The most common position in which a bandage is required to be applied is below the knee and hock, and very little practice is needed to render a person efficient in the performance of this simple operation. With the patient standing still, and a free end of about twelve inches of the bandage unfolded, we may proceed to make a cast round the limb. The free end is first placed upon the leg and the bandage unrolled over it. The bandage held in



Fig. 450.—Bandaging a Fore-Leg, showing the method of applying the bandage over a pad of cotton-wool



Fig. 451.—Bandaging a Fore-Leg, showing the bandage completed and tied.
A, End of bandage with tapes

the right hand is then carried round the limb again and again until the whole is payed out. It is then secured by means of the tapes which are now set free. The chief point to be observed in going down the limb is to keep the top edge of the bandage tight, while permitting the lower edge to be slack; the reverse conditions being necessary in coming up again. In this manner the hollows and the eminences receive equal pressure, and the tapes are tied upon a double portion where their pressure is not likely to be objectionable. If bandaging the leg of a dog we should begin at the toes, but the horse having an unyielding hoof (so far as the pressure of a bandage goes) we do not do so, and for convenience usually begin above

the fetlock, but do not put any great pressure on until we reach the pastern and begin to ascend the leg.

Starch Bandages.—To give support in cases of fracture, starch or glue bandages are sometimes employed. The former are either dipped in a basin of freshly-made warm starch and then loosely rolled before being applied, or spread upon a table and pasted over with a brush. Glue may be employed in the same manner, but the fingers need to be dipped in warm water to prevent them from sticking, as the liquid quickly cools. A starch bandage is more easily dealt with when the time comes to remove it, but glue sets more quickly at the time of application and may be preferred with a restless patient.

A better bandage than that formed of either starch or glue may be made by mixing the white of eggs with flour in such proportion as to form a paste that will readily spread upon a strip of calico or other suitable material. It requires no heat and quickly sets, remaining firm until softened by warm water when it is desired to remove it.

Plaster of Paris Bandage.—This form of bandage affords a greater degree of support than any other, but its rigidity necessitates more precautions against the production of sores when it has to be retained for a long period on the limb. It is essential that the plaster should not have been exposed to the air, and tins containing it should be sealed or it may be found to have lost its "setting" power when required for use. To carry the plaster a loosely-woven material is to be preferred. When this has been unrolled, dry plaster of paris is rubbed into it by an assistant. It is then slowly rolled again and each fold carefully filled. Before wetting it, the part of the animal to be bandaged should be covered by a plain bandage, or be padded with cotton-wool, wood-wool, tow, or spongio-piline. Everything being ready, the plaster bandage is dipped in water, and as soon as it is wet through, applied as quickly as possible, consistently with uniformity and neatness. The outside is smeared all over with more plaster of the consistence of cream. A dry roll of bandage is made to cover the whole, and the patient restrained from all movement for half an hour, by which time it should be set and quite hard.

BLISTERING

Blistering is an operation frequently resorted to in the treatment of horses, and many permanent blemishes result from the use of improper materials and the neglect of simple after-precautions. As a preliminary measure the hair on the part to be blistered should be first closely clipped and the scurf brushed out of the skin.

If a front limb is to be treated, the animal should be turned round in the stall and secured to both pillar-reins in such a manner that he cannot bring his muzzle into contact with an uplifted leg.

When a hind limb is to be blistered, the animal should be racked up short. Even in this position some irritable horses will injure themselves in front when suffering pain behind, and it may be necessary to keep such a one under observation for a few hours after the application is made. If only one limb is operated upon, its fellow may be enveloped in a soft bandage for the protection of both, for the patient is sometimes disposed to rub the suffering member against the other leg.

Only sufficient bedding should be used to prevent the patient from slipping down, long loose straw causing unnecessary annoyance when brought into contact with the blistered surface. Damp used straw is to be preferred to moss litter or saw-dust, which gets upon the blistered surface and is very objectionable.

Horses disposed to "filling" of the legs, and mares "in season", are specially susceptible to the action of vesicants, and these should be modified in strength if other reasons prevent the postponement of the application. An unnerved horse should on no account be blistered. The hollow of the heel should in no case receive any portion of the blister, and the space should be filled up with lard previous to the application being made.

About ten minutes of hand rubbing is usually sufficient to produce the desired effect, and the morning should be chosen for this operation, as affording opportunities to watch the patient and keep him out of trouble, besides which, the more acute stage will be past before leaving him for the night.

If the application has proved effectual, there will be vesicles or bladders upon the part next day, with some swelling of the limb though abatement of the pain. On the third day it is usual to bathe with warm water and soap, and when dry apply some emollient ointment or sweet-oil.

It may be doubted whether this is a desirable course to pursue. Better results, we think, would be obtained by allowing a hardened scale to form and remain, but humane considerations make most of us desire to relieve the suffering beast as soon as possible and give him the opportunity to lie down.

To prevent the patient from gnawing the member when released, an apparatus known as a "cradle" (fig. 452) is put on his neck in such a manner as to give him the maximum amount of liberty without the power to injure himself. If a horse is turned out to grass with a cradle on, the pieces of wood of which the cradle is composed should be held together with nothing stronger than "fillis", as fatal accidents have occurred through an

animal getting a hind foot caught up when trying to scratch the parts covered, a risk which is increased if the shoes have not previously been removed.

SLINGS AND SLINGING

Horse life is frequently saved by the timely use of slings. These differ in construction, and are often extemporized out of very crude appliances. Country veterinary surgeons, accustomed to all sorts of shifts and ex-

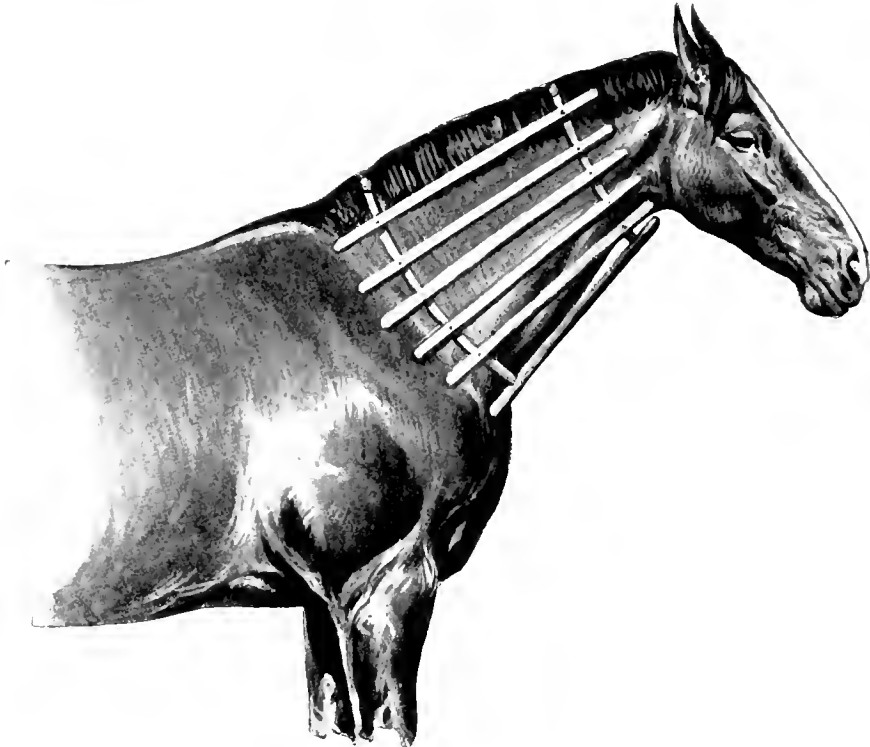
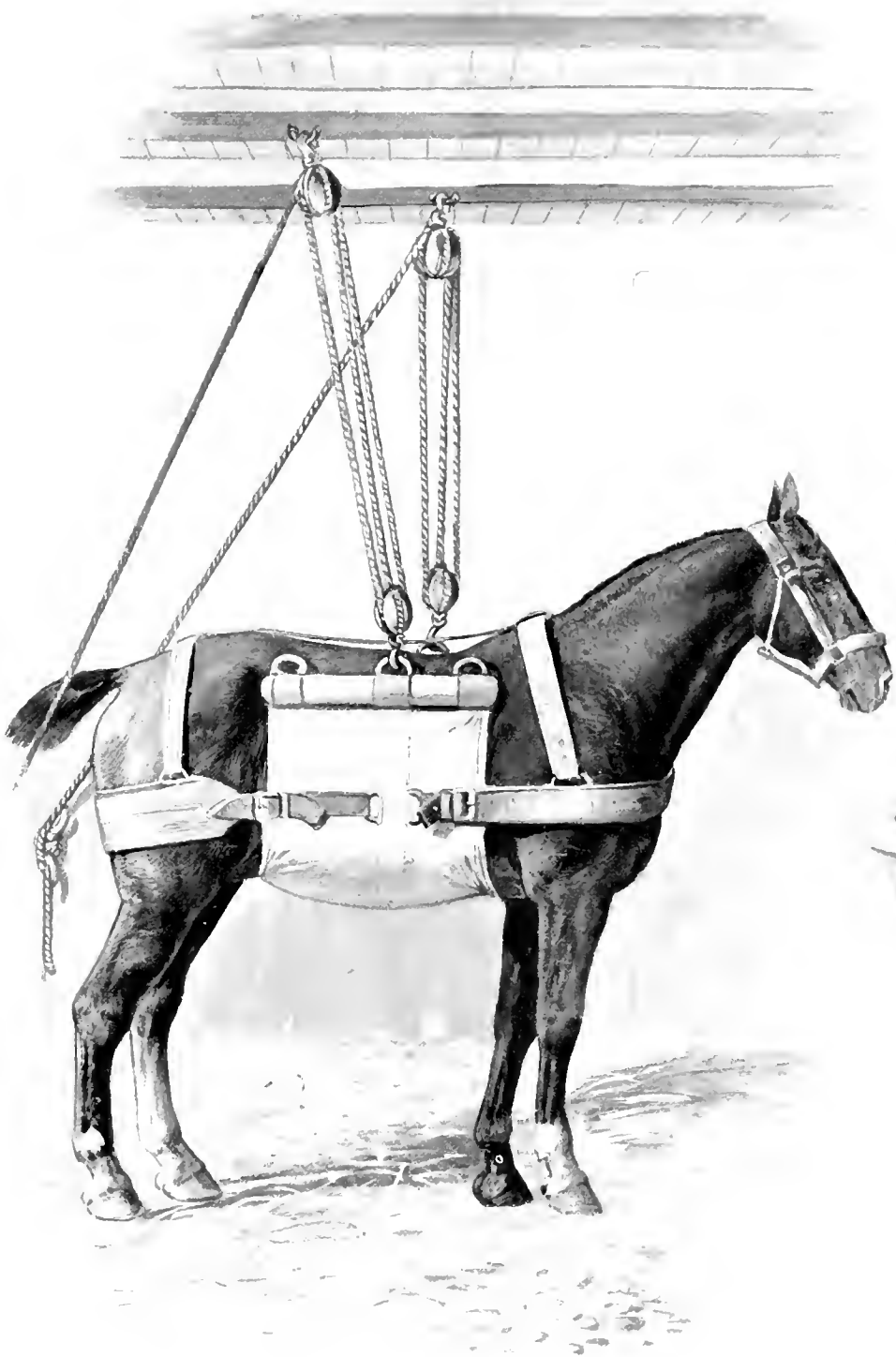

Fig. 452.—Neck Cradle

pedients, will make a farm cart or a pair of wagon shafts serve the purpose in the absence of more suitable means. The improved slings (Plate L), by their great strength and the endless chain and pulley, make it possible to raise a heavy horse from the ground with the assistance of but few men, while the old-fashioned ropes and pulleys need much more power. The method of adjustment, presuming that the patient is down, is to get the middle piece or *suspender* first under the body. To accomplish this, one or two men will elevate the head and neck, while two others are employed in passing the suspender as far as possible under the shoulder. The fore limbs are now raised by means of a cord applied to the under one, and while in this position the sling is forcibly drawn in a backward direction



SIMPLE SLINGS

towards the middle of the body. The pulleys are now hooked on to the suspender, and the body being slightly eased off the ground, the breastplate and breechings are buckled on by raising the legs in the manner above described.

Horses in slings require constant vigilance to prevent undue pressure and the production of sores on particular parts of the body with which they are brought into contact. A careful survey of the apparatus should be made two or three times a day, and, if necessary, a hole or two should be let out here, and one taken up there, so as to distribute the weight as equally as possible. If the animal, owing to the nature of his injuries or from other causes, persist in resting heavily upon one particular portion, that part should be padded or stuffed with hay, or a sheep-skin or pieces of rug may be interposed between the body and the suspender; but hay will, as a rule, be found the best stuffing, since it permits of more or less circulation of air.

GARGLES AND MOUTH-WASHES

Liquid preparations intended to act upon the mucous membrane of the throat by contact are commonly spoken of as *gargles*, although it is not supposed by anyone that horses can perform the act known to human patients as gargling. Advantage, however, is taken of the horse's reluctance to swallow, and small quantities of the medicine are poured into the back of his mouth, and when it has been retained there for a short period the head is lowered and the fluid allowed to escape. It may be remarked that gargles are seldom composed of any ingredients that would be hurtful if carried into the stomach.

Applications intended to produce their effect upon any part of the mouth are frequently described as mouth-washes, and the directions generally require the affected parts to be dressed with a soft sponge. If the back of the mouth has to be so treated, the sponge may be attached to a flexible cane.

SUPPOSITORIES

These are substances introduced into the rectum for medicinal purposes. They usually take the form of a cone-shaped mass, and are compounded with such agents as cocoa-butter. This substance is solid at ordinary temperatures outside the body, but slowly becomes liquefied by the heat of the part. Suppositories are more particularly employed as anodynes and antiseptics, and occasionally for their astringent properties.

LINIMENTS AND EMBROCATIONS

These are prescribed for application to certain parts with different degrees of friction—according to their strength, and the purpose for which they are employed. There are few medicaments more often *mis-*applied by the amateur than popular embrocations, which unscrupulous advertisers recommend with equal confidence for a broken knee or an inflamed tendon. When used, the friction to be applied over the surface to be healed should be equally distributed, and not applied vigorously at one part and lightly at another.

LOTIONS

Under this term is included almost any outward application that is not used with friction. The methods of application differ according to the purpose to be served. An eye lotion may have to be simply dropped on the affected part, a wound lotion to be applied on lint, an evaporating lotion may be most useful when freely and repeatedly applied to the surface either by simple irrigation or by means of a bandage. The full effect of an anodyne bandage is best obtained under oiled silk, and the value of remedies prescribed in this form very largely depends upon the intelligent use of them by the nurse.

OINTMENTS

There are many agents of value in medical treatment which by their nature are unsuitable for application except in the form of unguents. These, however, are much less in vogue now than was formerly the case, and the bases used by the advanced pharmacist are no longer the same: lard and goose-grease have given place to vaseline and lanoline, which do not become rancid.

Whenever an ointment is prescribed, except for application to a wounded surface, it is generally understood to require gentle but continuous inunction for several minutes.

PLASTERS OR CHARGES

Mustard plasters or poultices have been already spoken of under the heading of poultices. Plasters or charges are either simple or medicated. The former are used to afford support to an injured or weakened part.

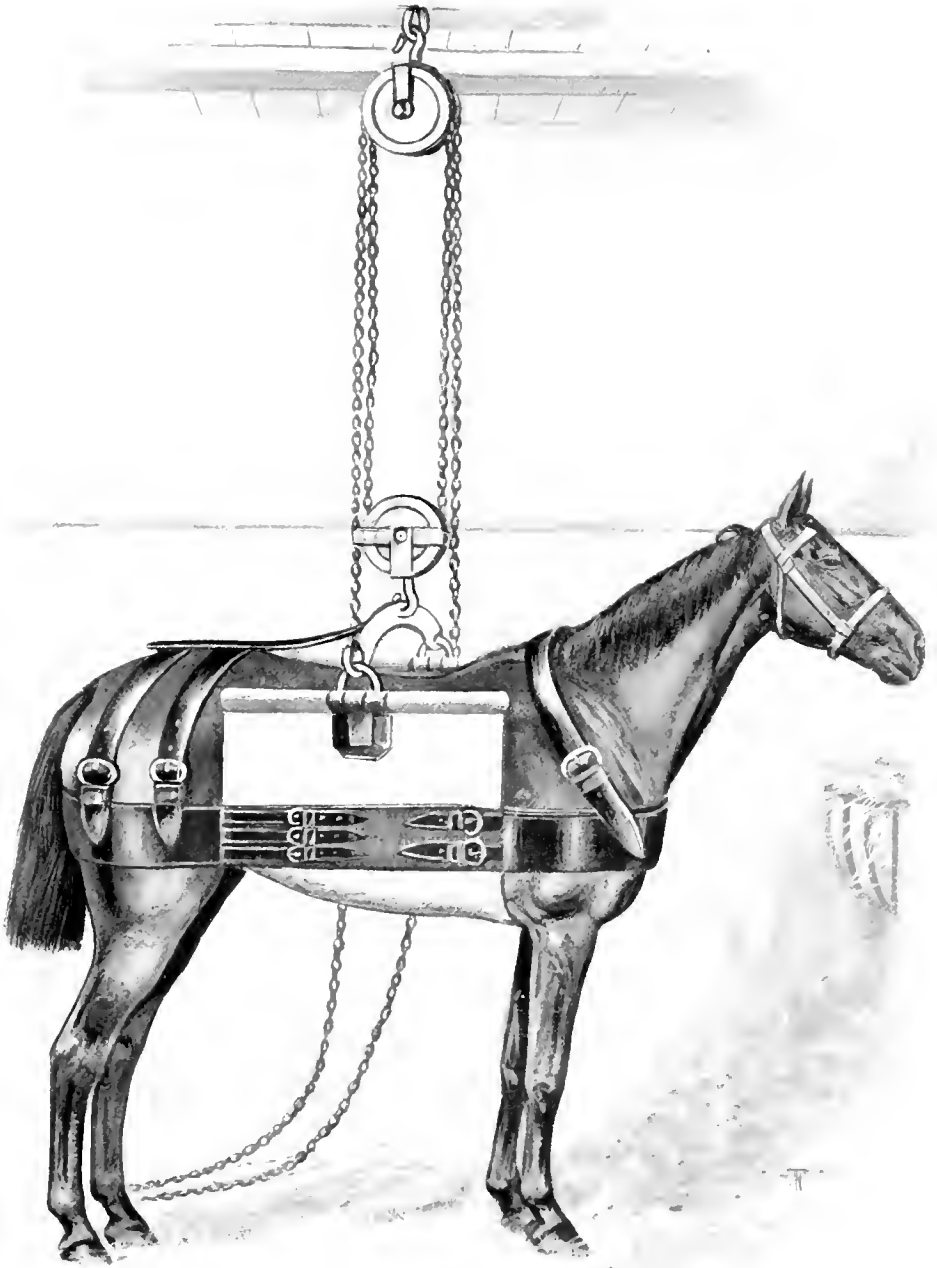

PATENT SLINGS

The latter, besides performing this service, are intended to effect the removal of enlargements, especially in connection with the legs.

Chamois-leather adapted to the leg, and neatly sewn on with stitches known to ladies as "herring-bones", are often called plasters in racing stables, but they do not properly belong to that order of applications.

The medical plasters employed in veterinary practice have a base of pitch, resin, wax, or a mixture of these substances, with which the drugs to be used are incorporated by first melting the former and stirring in the latter until the whole is cool enough to be applied to the skin. Instead of being spread on leather, as is often done in human practice, they are directly applied to the part by means of a spatula or knife, and then tow is cut into lengths of about half an inch and stuck on to the plaster while warm. They may be employed upon any part of the body, but their use is for the most part confined to the limbs, where they are used for the purpose of giving support to sprained and weakened tendons, joints, and ligaments, or to fractured bones.

25. POISONING

INTRODUCTION

A poison is a substance which in small quantities is capable of impairing health and destroying life. Animals in the feral state would appear to be largely endowed with an instinct which teaches them to avoid poisonous plants and other deleterious substances. The fox, lynx, and all the members of the feline tribe are suspicious to a degree in all that concerns their safety, and by the highly-developed sense of smell and taste they readily detect poison when introduced into flesh; though it be the "kill" or carcass they have reserved for a future meal.

Ages of domestication would appear to have so blunted these senses in horses that they will voluntarily take in their food many medicines which we are accustomed to regard as extremely nauseous. (See Methods of Administration.) It occasionally happens, therefore, that horses are poisoned, either by accident or personal malice, by the consumption of some toxic agent to which they have access in the stable or pasture.

General Symptoms of Poisoning.—Sudden and serious illness, with symptoms rapidly increasing in severity and without obvious reason, in animals apparently in good health up to the moment of seizure, is inconsistent with the majority of well-defined diseases, and affords sufficient cause

to suspect some extraordinary or poisonous influence at work. Taylor, Stevenson, and others, famous by their special study of poisons, warn us that, though indicating a direction in which to make enquiry and search for the cause, such acute illnesses are not inconsistent with certain rare, but nevertheless well-known, causes for sudden and painful disease and death. The rupture of some large blood-vessel or abdominal organ, as the stomach, may lead to symptoms very similar to irritant poisoning.

Suspicious of poisoning may be justly entertained, and investigation pursued, although it might be unwise to express them, and at the same time calculated to defeat the object in view, especially where foul play has been practised. Wilful poisoning is happily infrequent in the present day, and its rarity tends rather to disarm suspicion. Moreover, sudden deaths among horses without previous "complaint" are quite common in large studs.

What to do in Cases of Poisoning.—A comparison is again forced upon us, and we have to lament that as horse doctors our opportunities of combating fatal doses of drugs are very much fewer than those of a medical man. Our patients do not commit suicide, or drink carbolic acid by mistake, and seldom indeed do they get drenched with a poisonous liniment intended for outward application. The mistake is seldom discovered in time when accidental poisoning takes place in horses, and the wilful poisoner has less to fear from the dying depositions of the patient, who can only tell his wrongs by symptoms which may be difficult to distinguish from those of disease otherwise induced. For a variety of reasons the veterinarian has not the same chances of counteracting poisonous doses as the medical man. The human patient can tell his attendant the mistake, and the most suitable treatment may be instantly adopted, while the veterinary surgeon has to wait for the effects before he can ascertain the possible cause.

In nearly all cases the poison is taken into the stomach, and thence passes into the circulation. If we are fortunate enough to be early on the scene we may employ a stomach-pump and evacuate the contents of the organ, in the hope of removing the remaining unappropriated poison therein contained. As such an instrument is not likely to be found in possession of the ordinary horse-owner, it is the more necessary to seek the aid of a qualified veterinary surgeon.

Again, we are at the disadvantage in regard to this animal that we cannot freely excite vomition, as in the dog or cat, so that it nearly always happens in cases of poisoning that reliance must be placed upon chemical or physiological antidotes, and such general measures as may be indicated in order to combat particular conditions.

Since we can scarcely hope to evacuate the contents of the stomach either by a pump or vomition, we have usually to begin the treatment by an effort to arrest the action of the toxic agent upon the walls of the stomach. If poisoning is due to an acid irritant, copious draughts of alkaline bicarbonates are administered, those of potash, soda, magnesia, and lime being most suitable; and in the absence of such pharmaceutical products we may give chalk or whiting, or the scrapings of whitewashed ceilings or walls. Where caustic alkalies have produced the mischief, we resort to dilute acids, as vinegar or lime-juice in small but oft-repeated doses. In addition to those agents calculated to neutralize chemically acids or alkalies, we administer copious draughts of bland fluids in the shape of milk, linseed-tea, whipped eggs, oil, butter, gum, barley-water, &c. While these measures are calculated to save the mucous membrane and walls of the stomach from destruction by an irritant poison, and retard its effects, they will not influence that which has already entered into the circulation of the blood. We have said that in the case of horses, the poison has usually entered the body by means of the mouth and stomach, but there are other gates by which toxic agents may have gained access. The skin, as has been pointed out in connection with the subject of kidney diseases and local applications, may have been the means by which the body has suffered injury. The deleterious agent may have been absorbed by a wound, or passed into the circulation by subcutaneous injection, while the lungs may have inhaled the poisonous gas of mine or factory.

From the foregoing remarks the importance will be seen of ascertaining, if possible, the actual poison to be dealt with.

Antidotes (*antidotus*, a remedy) are agents which neutralize and arrest the action of poisons. In the stomach and some portion of the intestinal canal this effect may be counted on where the nature of the poison is known and a suitable antidote soon enough administered. In the case of chemical antidotes, their action on the poison frequently results in its decomposition and the formation of a harmless compound. As an example we may mention white of eggs as forming an insoluble albuminate when given to an animal whose stomach has been the receptacle of an overdose of bichloride of mercury (corrosive sublimate). Arsenic may be made insoluble in like manner by dosing the poisoned patient with freshly-prepared hydrated peroxide of iron. Other chemical antidotes convert destructive poisons into harmless salts, as in the case of sulphuric acid (oil of vitriol), which may be decomposed by an alkaline carbonate producing a harmless sulphate and liberating carbonic acid gas.

Examples of physiological antidotes may be seen in strychnia and chloroform or chloral. The tetanic spasms resulting from the former are

allayed by the directly opposite effect upon the spinal cord which the two last-named drugs are so well known to produce.

The veterinarian is at a disadvantage throughout the treatment of poisoning, as he cannot evacuate the stomach of the horse at first, as has been already mentioned, and is further unable to get rid of any new compounds formed by the administration of antidotes: they must pass through the intestinal canal. He cannot provoke vomiting, and repeated washings of the stomach are scarcely practicable, except in a few instances and under specially favourable circumstances.

In addition to the use of antidotes there are other aids to restoration from the shock and particular symptoms resulting from poisoning: suitable hygienic conditions, fresh air, cold douches, friction to the skin, bandaging and clothing, bedding and protection of the patient from his own violence by bolsters of straw, and the usual methods of restraint. In a case of narcotic poison it may be necessary to rouse the animal to muscular effort and compel him to walk about.

Suitable treatment in cases of poisoning by each of the chief toxic agents known to affect horses will be found briefly stated farther on in this chapter.

Poisonous Food and Water.—On the question of ptomaine poisoning in horses we have no experience as yet, but disease and death from the ingestion of food and water in certain unwholesome conditions are by no means rare events.

CORROSIVE OR IRRITANT POISONS

To this group belong many symptoms in common, and it is therefore convenient to consider them together. The following list comprises all of the class of substances whose compounds are likely to be the cause of poisoning in horses:—

Arsenic.	Lead.	Antimony.	Mercury.
Copper.	Silver.	Carbolic Acid.	Phosphorus.
Croton Oil.	Zinc.	Creosote.	Gamboge.
Caustic Potash or Soda.	Spanish-fly.	Caustic Ammonia.	Elaterium.
Hydrochloric Acid.	Oxalic Acid.	Nitric Acid.	Sulphuric Acid.

Symptoms common to this class of poisons are the result of their irritating or caustic action upon the membranes of the digestive tract, in some cases beginning with the lips, and in the majority affecting the stomach and intestines. The mouth and gullet, although first (after the lips) to have contact with the irritant, are frequently less affected, as it will be remembered that some parts of the digestive tract are provided with

thick and comparatively resistant coverings. The tongue on its upper surface is protected with a dense membrane of epithelium, and the œsophagus or gullet is likewise lined with a thick and tough membrane capable of resisting puncture from such prickly or spinous plants as gorse and comfrey. The fauces, being less guarded, more frequently suffer irritation, and the bowels, with thinner and more highly vascular walls, are more readily acted upon by poisons of the class we are considering.

While the symptoms are the result of pain, the tissues are damaged or destroyed by chemical action.

Though our equine patient is not able to state in words the burning anguish he feels, there is a language of pain which it is the veterinarian's business to learn. It has a large vocabulary, with many shades of meaning to him who understands it by intimate association with the objects of his solicitude.

The common symptom—loss of appetite—will hardly be observed, as poisons of this class are so rapid in their effects that the last meal may have been partaken of in perfect health.

Amongst the earliest symptoms are rigors and fidgetiness, staring coat, colicky pains, evinced by stamping and scraping the feet, crouching and looking round at the flank, trembling of the body and shaking of the tail, sweating profusely over scattered patches, staggering, and either falling or going down recklessly. The lips are sometimes swollen, and from between them may issue great quantities of frothy saliva, which hangs in ropes from the corners of the mouth. Inside, the tongue may also be swollen, the lining membrane discoloured, the gums and mouth generally being of a purple hue, with, in certain cases, patches of sloughing tissue and a most offensive odour. The cavity seems filled with sticky mucus, and the animal can with difficulty close his mouth owing to the swelling of the tongue.

The blood-shot eyes and anxious countenance bespeak intense pain and fear. There is an agonized look of such intensity as is seldom observed as the result of ordinary illness. Respiration is hurried, nostrils dilated, the pulse small and almost indistinct, the extremities having an icy coldness. Vomition, so rare in the horse, is sometimes effected, the stomach contents passing through the nostrils. The bowels may be either purged or constipated, urine very high-coloured, and evacuated with groans.

Such are the symptoms common to this group of poisons, but they vary with the particular agent as well as in individuals.

Some poisons declare themselves by their odour, as in carbolic acid, or the lesions of the mouth may point to corrosive sublimate or a mineral acid as the particular poison.

Irritant poisons are not all corrosive, in the sense of quickly destroying and perforating the tissues. Ammonia is an example of an intense irritant, and corrosive sublimate the most immediately destructive of living tissues. The mineral acids show some difference in their local action. A yellow staining results from nitric acid, sulphuric acid whitens the membranes, and hydrochloric acid imparts a whity-brown appearance to the injured parts. Carbolic acid, we have said, leaves a tell-tale odour, but it and the caustic alkalies also make a white, drawn, or puckered surface of the membrane with which they come in contact. Patches thus injured become presently detached, or slough, leaving a raw surface and the expectoration of blood-stained mucus. In dogs and other animals the vomit indicates to some extent the amount of mischief in the stomach, but with the horse vomition is uncertain and accomplished with so much difficulty that we are unable to place any great reliance upon the appearance of ingesta ejected via the nostrils, and probably stained in the effort to get rid of it.

If death does not follow irritant poisoning in a few hours, the animal may pass into a condition of fever with variable results. If the toxic agent was of the corrosive class the patient may die of perforated stomach or intestine when a general improvement in his condition has raised false hopes of recovery in those interested. Gradual recovery is probable when a week has passed, in the case of merely irritant poison, but not in those of a corrosive nature.

Permanent constrictions in the œsophagus, stomach, or bowels may result from the healing scars where large areas of tissue are destroyed.

ARSENIC

This drug is employed in agricultural operations of various kinds, and is a frequent cause of poisoning in horses and other animals. Ignorant carters and grooms persist in using it to destroy worms and produce a glossy coat, with little regard to its dangerous properties. Teamsters often give it with antimony, and without causing any mischief at the time. Arsenic, however, is one of the cumulative poisons, and ill consequences may follow long after its habitual use has been discontinued.

Cases of wilful poisoning by the drug are found recorded in veterinary literature, but many occur also from the careless employment of sheep-dipping compounds and "weed-killers", which in various ways gain entrance to the food and drink of animals.

These preparations, composed of arsenic, with caustic alkalies to facilitate their solution, have a saline taste attractive to horses, and particularly to cattle, which will lick an open packet of arsenical powder with evident

relish, and no season passes without deaths resulting from such compounds being left within their reach. Weed-killer is poured upon garden-paths and carriage-drives, and animals have been known to succumb after eating the weeds before wet weather has washed it into the soil. Refuse paints, containing emerald green, Scheele's green, Brunswick green, when cast upon pasture land in manure, are sometimes followed by fatal results. The death of some valuable horses was caused in one instance by a tin of this fluid being upset and becoming mixed with the corn. Arsenic is used also as a dressing for wheat, and a poison for vermin, and less frequently as a cure for warts and foot-rot.

Symptoms.—Although there is much difference in the susceptibility of animals, as proved by the experiments of Hertwig, Percival, Gerlach, and others, the action of this poison is largely governed by the condition of the stomach as to the presence or absence of food. The quantity of food in the stomach has also a great influence in delaying the toxic effects of the drug. In one of Percival's experiments upon a glandered horse an increasing daily dose was given with food until, on the seventeenth day, it had reached 380 grains, making a total of 7 ounces in all. Even this large quantity failed to produce any physiological effects. On the other hand, the fatal effects of much smaller quantities were seen in the case of eleven cart-horses which were poisoned at Edgware by drinking out of a bucket that had previously been used for sheep-dip, one of the animals dying in ten minutes, and several more within the hour. The quantity taken by each horse in this case must have been small, but there is reason to think that the empty condition of the stomachs had rendered them more susceptible of its action.

Poisoning by arsenic is sometimes very sudden, and at others slow and progressive; the one being spoken of as acute poisoning, the other as chronic or cumulative. In the chronic there may be an appearance at first of improved tone, shiny coat, strong pulse, and good spirits; these being maintained by what would be called the "arsenic habit" but for the fact that it is involuntary on the part of the animal. After using it for a time it fails of effect, and the carter is tempted to increase the dose, until presently appetite fails and is ultimately lost, the coat stares, shivering-fits follow, colicky pains set in, and are succeeded by purging, prostration, imperceptible pulse, staggering, falling, and death. In the acute form of the disease there is sudden and desperate illness without premonitory signs, those even who are quite unaccustomed to animals recognizing the rapid approach of death by the haggard countenance, quick breathing, and violent trembling of the body, and general distress. The skin is bathed in sweat, the ears and legs are very cold, the eyes are protruding and bloodshot;

tears run down the face, the lining membrane of the nostrils is intensely red, and a watery fluid or vomited matter flows from them. In some instances the lips may be greatly swollen, the gums inflamed, and the tongue so enlarged as to be contained in the mouth with difficulty; frothy saliva of a ropy consistence and offensive odour hangs from the lips. The patient will frequently throw himself down in his agony, but towards the end he will endeavour to stand, and when no longer able to keep his feet he falls and dies with a few painful struggles.

Treatment and Antidotes.—In the chronic or accumulative form of arsenical poisoning not much can be hoped of antidotes, as the drug is already absorbed or out of the reach of chemical agents which might counteract it. Attention should therefore be directed to minimizing its effects and sustaining the patient with suitable nourishment until the poison is eliminated from the system. Milk and eggs, gruel, linseed, barley-water, and alcoholic stimulants may all be employed to support the animal until the *vis medicatrix nature* can assert itself. Iron in combination with nuxvomica, given in small repeated doses, will aid in bringing about this much-desired result. In the acute form of the disease a dose of the peroxide of iron should be promptly administered. This agent is most effectual when precipitated from a solution of persulphate of iron by the addition of ammonia, and afterwards washed with warm water and given at frequent intervals until enough has been taken to neutralize the poison. The proportion of peroxide of iron required to produce this effect is estimated by Mr. Finlay Dun to be twelve times the amount of the arsenic taken.

Epsom salts in solution, mixed with liquid caustic potash (liquor potasse), produce a gelatinous hydrate of magnesia, which greatly retards the solubility of arsenic, and may therefore be given with advantage. The yolk of eggs, linseed and other fixed oils, charcoal, clay, and starch all help to hinder mechanically the effects of arsenic upon the walls of the stomach and intestine. Long and careful nursing is needed, and the temperate use of diuretics is calculated to assist nature in getting rid of the poison by the natural channel of the kidneys.

ANTIMONY

This potent drug, which has played so great a part in ancient and modern times as a poison to human beings, is comparatively innocuous to horses. Its uses are referred to in another chapter (see Alteratives, page 12), but poisonous doses have rarely been given, and when this has happened it has been from drenching by mistake with the liquid chloride

or "butter" of antimony, as it is called. The effects then are of a corrosive character, hydrochloric acid being the active ingredient.

Symptoms.—Those of corrosive poisoning, sweating, purging, and prostration being the most marked.

Treatment.—Should be the same as for corrosive or irritant poisons.

If a sufficient dose of antimony were taken to prove poisonous to a horse, the treatment would consist in giving tannin and gallic acid, which would form with it insoluble and harmless compounds. Decoctions of oak or elm bark, which contain tannin, may be used in the absence of the active principles themselves.

LEAD

Lead poisoning in animals is usually the result of feeding on tainted pastures, or inhaling the fumes of chemical works, and manifests itself in impaired digestion, capricious appetite, colicky pains in the bowels, followed by constipation. After a variable lapse of time, the diagnostic symptom appears, a greyish or blue discoloration along the margin of the gums. It is deposited lead, which becomes more or less blackened by hydrogen sulphide in the mouth, or by the administration of sulphur in the food. Cramp and paralysis of the muscles, followed by wasting, choreic movements, and convulsions, ending in blindness (amaurosis), commonly precede death.

Treatment.—If lead poisoning or plumbism is diagnosed before any very serious wasting has occurred, an effectual antidote will be found in dilute sulphuric acid, and sulphate of magnesia, given in repeated small doses, as these have the effect of converting the lead into harmless insoluble sulphate. The sulphate of magnesia assists also in regulating the bowels, which, as we have seen, are disposed to constipation and to cramps; sulphur and potassium iodide are also employed as eliminants, given separately and at short intervals. An occasional laxative dose of oil is advised when the sulphate of magnesia is not being administered, as this hastens the removal of lead salts excreted into the bowels.

OXALIC ACID

Death has been caused by the wilful administration of this acid, and by horses eating the leaves of mangel-wurzel, in which it is generated by fermentation while lying in heaps. The symptoms are similar to those produced by corrosive mineral acids (p. 46), and it is besides a powerful cardiac depressant.

Treatment.—Frequent doses of saccharated carbonate of lime, lime-water, or whitewash. These are chosen because they form insoluble salts

with oxalic acid, while those alkaline bicarbonates recommended for poisoning by other acids are forbidden because combining to form soluble oxalates, which are little less injurious than oxalic acid.

Oleaginous aperients and alcoholic stimulants to counteract symptoms of collapse are desirable. Friction, bandaging, and clothing to keep up the superficial circulation should be resorted to.

ACETIC ACID

Concentrated lotions containing a large proportion of this acid have been given in error, with poisonous results.

Symptoms.—Unless somewhat dilute, the symptoms are those of corrosive acids (p. 46), when colicky pains, inflammation of the tongue and buccal membranes, sore lips and gums are manifested, and occasion inappetence and refusal of food, and discharge of saliva from the mouth.

Treatment.—Solutions of alkaline bicarbonates should be given internally, and a soothing wash of glycerine, myrrh, and borax applied to the mouth three or four times a day.

CAUSTIC ALKALIES

Of these ammonia, in the form of strong liquid, given in mistake for aromatic spirit or solution of acetate, is the only likely form of poisoning to occur in horses. This mistake has frequently happened in the careless dispensing of ammonia compounds.

Symptoms.—Blistered lips and mouth, patches of epithelium sloughing off in ragged shreds. Ropy and offensive mucus dribbling from the mouth and from the lips, and hanging in ropes more or less straw-coloured or tinged with blood, swelling of the tongue, sore throat, difficulty of deglutition, coughing, and dyspnoea. Intestinal disturbance with loose eructations and apparent soreness throughout the canal. Pained expression and listlessness.

Treatment.—Copious draughts of dilute vegetable acids, as lime-juice, citric or tartaric acid, vinegar and water. These should be given at frequent intervals to neutralize the caustic ammonia, and form harmless combinations. Inhalation of steam to relieve the irritated air-passages and soothe the inflamed mouth; where suffocation threatens, tracheotomy will require to be performed. Linseed-tea, barley-water, thin gruel, bran mashes, and soft food only for several days should be allowed, as any dry, hard substance is calculated to injure the abraded surfaces of the mouth. Where the patient refuses all sloppy food, he may be cautiously drenched

with eggs beaten up in milk. If constipation follows, aperients must not be given, but reliance placed on the nature of the diet, and at most, a glycerine enema administered from time to time.

NITRATE OF POTASH

Although in such general use among stablemen, nitrate of potash is nevertheless an active irritant poison in excessive doses.

Symptoms.—Trembling, more or less abdominal pain, restlessness, convulsions, and collapse.

Treatment.—The same as for irritant poisons generally.

NITRATE OF SODA

This substance is not used in equine medicine, but has occasioned the death of several animals through being injudiciously spread over the pastures as a manurial agent, and given in mistake for salt, and allowed to get into drinking-water.

Symptoms are those of irritant poisoning, and the same line of treatment should be adopted (p. 46).

IODINE

Iodine poisoning usually occurs by the accidental administration of compounds, prescribed for external application, as a medicine.

Symptoms are those of an irritant poison, with sighing, trembling, convulsions, and collapse.

Treatment.—There is no direct antidote to this drug. Starch and white of egg retard absorption, while an oily purge may be given to expel the offending material through the bowels.

PHOSPHORUS

The employment of this element for the destruction of vermin has led, in careless hands, to horses being seriously injured. A very small quantity of phosphorus paste concealed in forage may be taken into the mouth by a gross feeder, although it is such an offensive substance that most horses would detect and reject it.

Symptoms.—Abdominal pain, simulating ordinary colic, is followed by ineffectual efforts at vomition, and subsequent purging. There is a tendency to hæmorrhage from the natural outlets of the body, either nose, mouth, rectum, or urethral canal. The liver is invariably more or less deranged.

Treatment.—Although this drug is of the nature of an irritant poison, we are precluded from giving oily substances, phosphorus being readily soluble in fixed oils. Solutions of gum-arabic or tragacanth and small doses of turpentine are reputed to have beneficial effects in alleviating suffering from this form of poisoning.

Post-mortem Appearances.—These are fairly constant, but differ in degree. A large amount of foul-smelling gas is released when the abdomen is opened, and the stomach, especially in its villous portion, is reddened, much softer than when the organ is healthy, and considerably thickened. Inflamed patches and areas of extravasation are observed extending into the small intestine, and maybe into the large bowel.

The air-passages and lungs are congested, as are the urino-genital organs. It is remarked that in phosphorus poisoning a lardaceous or fatty infiltration of the liver, brain, and other organs appears to take place in a short time after administration of the drug, a pathological condition usually associated with other causes of an enduring nature. Rodents and other small animals do not, when killed by phosphorus, undergo the ordinary processes of putrefaction, but dry up. Whether such effects would follow with horses is not at present ascertained.

NARCOTIC POISONS

The next group of poisons are spoken of as narcotic, but there are toxic agents having both irritant and narcotic effects, the classification being more or less arbitrary, and followed only as convenient for reference.

General Symptoms.—Some of these are common to the class, and such as are occasioned by Indian hemp may be taken as typical. With this drug, given in excessive quantity, there is often some nervous excitement, but not invariably. This is followed by drowsiness, which passes on to stupor, and the standing posture is maintained with difficulty, the knees and hocks giving way from time to time.

The animal under its influence becomes dead to external objects, and can only be awakened with difficulty. Sudden noises rouse him with a start, but he lapses into a state of lethargy again the next moment. The head hangs low, the eyes are half-closed, and the ears pendulous. Snoring sounds are emitted in breathing, the extremities are cold, altogether indicating the effects of a poisonous dose of a narcotic drug, of which further evidence may be found in the reduced force and frequency of the pulse. A symptom peculiar to Indian hemp is a galloping movement when compelled to walk; the power of controlling the muscles of locomotion is

partially lost, and the patient uses his limbs, as Captain Rutherford has said, like an animal "going upstairs".

Opium and belladonna in poisonous doses may be followed by delirium, but the condition of intoxication, the staggering gait, and final stupor are common to all drugs of this class.

YEW

Having regard to the number of animals killed by this evergreen, one might ask if its place in arboriculture could not well be taken by some equally beautiful and less deadly plant.

No season passes without fatalities to horses or cattle as the result of eating it. A tree may have been left untouched for years by animals pastured in its vicinity, until the stock-owner is lulled into a sense of security, and finally forgets its presence; or animals may be thought safe in a paddock, free from noxious plants, when a neighbour sets about lopping his overgrown yews, and the fatal branches fall within reach of animals, whose curiosity prompts them to eat the leaves. There is reason to believe that in certain conditions and circumstances yew may be partaken of with impunity, while at other times its effects are rapidly fatal. The green shoots have been

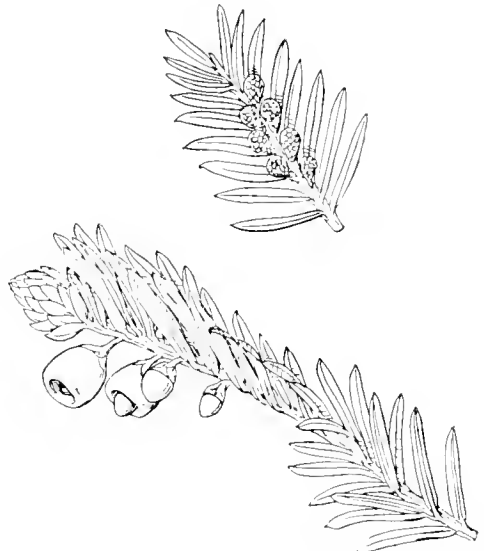

Fig. 453.—Yew (*Taxus baccata*)

experimentally fed to animals, and the results were very indefinite. If taken upon a full stomach, its toxic influence would seem to be more or less neutralized, while hungry animals have rapidly succumbed. Whether this latter result has come about from the larger quantity consumed, or from the empty state of the stomach, or from both causes combined, cannot be definitely stated.

Symptoms are those of a narcotic irritant poison. The animal is found dazed, and stumbles when made to move, falling down and showing the ordinary signs of intoxication. Respiration is shallow, the pulse oppressed, and the extremities are cold. Digestion would appear to be disordered or arrested, and, as a result, more or less tympany is present. Post-mortem examination is satisfactory only in so far that it reveals the

presence of twigs and leaves of the plant; there is, however, invariably more or less congestion of the stomach and bowels, sometimes more especially marked in the former, at others in the latter. Beyond this there is seldom any noticeable change referable to the poison.

Treatment.—No direct antidote is known, but the symptoms of collapse may be combated by diffusible stimulants, as alcohol and ammonia, while friction to the skin, bandages to the legs, clothing to the body, and every effort to restore the circulation should be attempted.

An aperient is essential to get rid as quickly as may be of any portions of undigested poison, linseed- or castor-oil being the most suitable.

Liability for yew poisoning has been tested in the High Court of Justice, and Mr. Justice Charles decided that it is the business of an owner to prevent his animals from eating yew when growing on a neighbour's land.



Fig. 454.—*Rhododendron (R. hybridum)*

RHODODENDRON

The effects of this plant (*Rhododendron hybridum*) are much the same as those of yew (see Yew Poisoning), save that attempts at vomiting are a prominent symptom, and slight colicky pains are also evinced by striking at the belly with the hind-limbs.

Treatment is more likely to be attended with success here than is the case in yew poisoning, since the action of rhododendron is more irritant than narcotic, the pain being more under control by opium and alkaline carbonates, while an aperient of linseed-oil may be employed to clear out the bowels and expel the offending matter.

FOXGLOVE (*DIGITALIS PURPUREA*)

This well-known drug is largely used in equine practice, and toxic effects occasionally follow on the administration of excessive doses. When

growing it has been cut in mistake for comfrey and given to horses, with fatal effect. The death of horses from digitalis is recorded by Mr. Pauer of Exeter in the summer of 1896. In this case the animals were led by natural instinct to refuse the plant while it was whole, but readily partook of it when chopped and mixed with corn.

Symptoms.—These are general stupor, swelling of the eyelids, dilatation of the pupil, enlargement under the jaw, dry mouth, and loss of control over the hind extremities. The pulse increases up to 60 or 70 beats per minute, but the heart sounds become more or less indistinct, or one becomes inaudible or merged into the other. The breathing is hurried and difficult. There is swelling of the head and tongue, which latter cannot be contained in the mouth. In some cases the body temperature rises three or four degrees, while in others it is normal. The visible mucous membranes are red and injected. Post-mortem examination shows the lungs to be filled with dark venous blood, the right auricle of the heart is also distended, and a gelatinous fluid fills up the loose connective tissue under the throat. The kidneys are noticeably congested.

Treatment.—In this disease aconite is the most suitable physiological antidote, as its action upon the heart is opposed to that of digitalis. Alcoholic stimulants, as the aromatic spirit of ammonia, freely diluted, are also recommended.



Fig. 455.—Foxglove (*Digitalis purpurea*)

NUX VOMICA AND STRYCHNIA

When horses are poisoned by strychnia it is either the result of malicious administration, or brought about by an overdose, or by the accidental admixture of some preparation with food, which was intended for the destruction of rats and other vermin on infested premises. Horses

vary in their susceptibility to strychnia, some being acted upon by very small doses, which others take with impunity; this being so, the greatest care should be observed in its use, and none but the professional man should undertake to prescribe it. Again, indifference to plainly printed instructions or written labels is so common, and not confined to the wholly illiterate, that entire packets of "vermin-killer" have been given in a mash in lieu of alterative powders, some of which are very similar in colour and appearance.

Symptoms.—Unless the stomach is quite empty, and the drug taken in solution, its effects are not manifest for some twenty minutes. Restlessness and excitement, with an exalted sense of hearing and vision, are observed in the first instance, the movements of the animal are spasmodic and involuntary, suddenly terminating in fits of tetanic spasm, in which the animal falls to the ground and becomes perfectly rigid; relaxation of the spasm and a state of quiet may follow, but if touched ever so lightly a new paroxysm is commenced. After a variable period, according to the amount and intensity of the poisoning, the spasm is relaxed, and beyond the hurried breathing and appearance of having undergone some recent extraordinary excitement, the patient appears to be nearly well. The remission is, however, but temporary, similar seizures follow again and again, and in one of them the animal may die, or, the intervals between them becoming longer, and the paroxysms less violent, recovery follows.

Treatment.—The most potent antidote to this form of poisoning is chloroform, inhaled to the point of insensibility, and repeated with the recurrence of each spasm. It may be truly said that there is absolutely no danger of overdoing it until complete relaxation of the spasm indicates its withdrawal.

In the intervals, if practicable, large doses of animal charcoal and tannic acid may be given in the form of a drench, with water, and alternated with bold doses of chloral and bromide of potassium. It is quite possible with these remedies at hand to effect a cure even when a fatal dose has been taken, but it seldom happens that skilled professional assistance can be soon enough obtained. Soot and water may be used in place of charcoal, and absolute quiet enjoined until a veterinary surgeon arrives.

INDIAN PEA. DOG-TOOTH PEA

We have employed the popular term for this dangerous food-stuff, but it is not a pea; it is a vetch, and its botanical name is *Lathyrus sativus*.

In India this seed has been used as a food-stuff among the lower-caste



POISONOUS PLANTS II

- A. Nux Vomica. 1. Section of fruit. 2. Seed.
- B. Rhododendron.
- C. Belladonna. 1. Fruit.
- D. Indian Pea. 1. Fruit.

natives, among whom it has produced from time to time considerable mortality; but when thoroughly cooked it is consumed in moderation without producing any deleterious effects.

It does not appear to have been known in this country until the year 1889, but is now generally recognized by veterinary surgeons as a highly dangerous grain to form any part of a horse's diet. In shape it somewhat resembles a tooth without the fang, having two flat sides and a serrated edge, hence the name "dog-tooth" pea. Very serious losses among large studs of horses have occurred in Glasgow, Liverpool, Bristol, and other places as a result of mixing this Indian vetch with oats and other horse food.

Symptoms.—The injurious effects of this grain are not immediately apparent, and this has frequently led to the real cause of the malady being overlooked. In the case of the Bristol tramway horses the drivers were at first blamed for the number of horses that fell and broke their knees, the real cause being vertigo produced by the food. Where the poisonous grain had long been in use, some of the animals fell in their stalls, but, as a rule, they appeared to be well until taken out, when they were seized with paroxysms of difficult breathing and threatening suffocation, roaring, staggering and falling, some few dying on the spot, while others became paralytic and the subjects of chronic roaring. The effects in some instances were not observed until eight weeks after the food was discontinued.

Treatment.—The cause being discovered will of course suggest a discontinuance of the grain, but no antidote or even palliative has been so far discovered. Many of the horses referred to above were only saved from immediate suffocation by opening the windpipe and inserting a tracheotomy tube.

Laxative food and medicine to clear the bowels, and rest in a loose-box,



Fig. 456.—Indian Pea (*Lathyrus sativus*)

followed by a run at grass, have in some cases effected a cure. In others, however, permanent paralysis or want of control of the muscles has resulted, rendering the animals worthless.

The heavy damages given against vendors of this poisonous grain will, it is hoped, deter shippers in the future from importing it into this country.

CANTHARIDES OR SPANISH-FLY

This substance was formerly in more general use by veterinarians than is the case at the present day, and many horses have shown symptoms of poisoning through its agency, both by internal administration and through absorption by the skin when injudiciously employed in the form of blisters.

(See Kidney Diseases.)

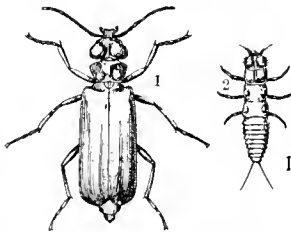

Fig. 457.—Spanish-Fly (*Cantharis vesicatoria*)

1. Fully-developed insect.
 2. Larva, much magnified.
- The measuring line at side shows natural size.

Entire horses entrusted to ignorant leaders are sometimes made ill by the administration of this drug with the intention of exciting the sexual instinct. Mares refusing service have also been injured by its use.

Symptoms.—Purging and bloody urine, arching the back, and nausea; colicky pains, frothing at the mouth, restlessness, and fever. In the case of stallions and of geldings, frequent protrusion of the penis, and with mares, erection of the clitoris and elevation of the tail. Fatal

doses may be preceded by delirium, convulsions, or paralysis.

Treatment.—Mucilaginous drinks, as a solution of gum-arabic, or tragacanth, barley-water, white of eggs, milk, and linseed-tea may be given. Poultices over the loins, injections of warm water with belladonna extract, and repeated small doses of opium in the shape of draughts are also beneficial.

TURPENTINE

Turpentine, although sometimes administered in large doses without any bad effects, may also become a poison when given in excess.

Symptoms.—The effects of a poisonous dose of turpentine are intoxication and those more generally described under the head of narcotic poisoning. (See Opium.)

Treatment.—Mucilaginous drinks, eggs, milk and barley-water, and a saline purgative.

Pain may be relieved by poultices over the loins, and some of the irritant effects upon the kidneys mitigated by belladonna. (See Cantharides.)

POISONING BY THE STINGS OF BEES AND WASPS

By the accidental upsetting of, and disturbing of, nests of wasps or hives of bees, horses are occasionally attacked by the rudely-evicted tenants, and there are several instances on record where death has resulted from this cause. The face, head, and neck are chiefly selected by the infuriated insects, and the pain and shock resulting from the attack may be very great.

Treatment.—Where possible the stings should be removed with fine pointed forceps, but this is very difficult of accomplishment on the hairy

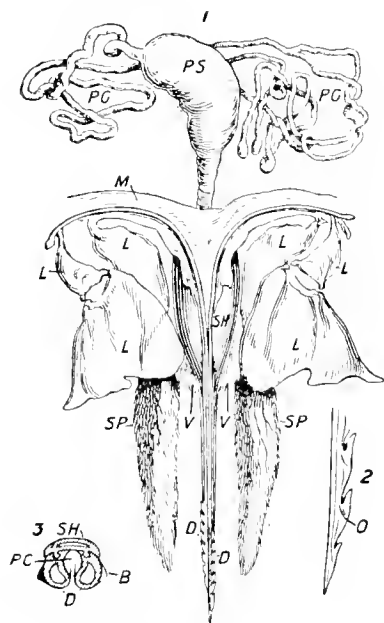

Fig. 458.—Sting of Bee

1, General view. 2, Extremity of dart. 3, Section through sheath and darts. PG, Poison gland. PS, Poison sac. M, Membrane joining sting to abdomen. L, Levers to remove darts. SH, Sheath. V, Vulva. SP, Sting palpus. D, Darts. B, Barbs. PC, Poison channels. o, Opening for poison to escape into wound.

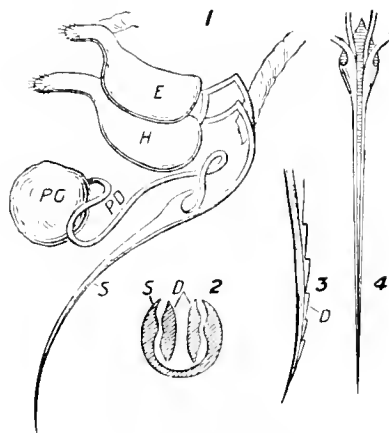

Fig. 459.—Wasp Sting

1, General view. 2, Section of sheath to show situation of darts. 3, Extremity of sheath with darts. 4, Front view of sheath. E, Eppygium. H, Hypopygium. PG, Poison gland. PD, Poison duct. S, Sheath. D, Dart.

parts of animals. Bearing in mind the chemical reaction of the poison, the best antidote is to be found in alkaline bicarbonates. A wash of carbonate of soda or ammonia may be repeatedly applied to the injured part, and in the intervals, soothing applications of glycerine, belladonna, and borax. Much of the suffering is caused by the inflamed and tense state of the skin where it most closely adheres to bony prominences, and some relief may be afforded to these parts by the free use of oily applications.

The symptoms of shock are best treated by diffusible stimulants and removal of the patient to a quiet, dark box. In one or two instances the nostrils and lips have been so much swollen that death from suffocation

has only been averted by the introduction of a tube into the trachea (see Tracheotomy). The stings of most poisonous insects have an acid reaction, and treatment on the lines above indicated will usually be found successful.

HAY

Cases of poisoning due to hay feeding, crop up from time to time. Now it is Dutch, and next Canadian, but mostly foreign fool-stuffs that cause illness in horses in this country. The deleterious ingredient has not always been traced, but it would seem that animals bred upon a particular pasture gain im-



Fig. 460.—*Colchicum autumnale*



Fig. 461.—Alfalfa (*Medicago sativa*)

munity from the effects of herbage which causes illness in others, or else develop a power of selection which enables them to reject certain poisonous plants even when compressed in form of hay.

In the low pastures of Flanders we have seen much *colchicum* (fig. 460) growing, and observed that native stock carefully avoid it, but when made into hay and imported into this country it may be that animals in our great cities, drawn from all sorts of sources, are not able to distinguish it. The dry, hard grasses, chiefly *alfalfa* (fig. 461), upon which American

horses are fed, are not acceptable to home-bred animals until the taste is acquired, but horses imported from the United States and Canada eat it and thrive upon it. The presence of a large portion of Starwort (*Stellaria Holostea*) (fig. 462) in imported hay has been said to occasion poisoning in a number of cases of horses fed upon it.

Symptoms.—There is much resemblance in the symptoms of poisoning arising out of deleterious legumes or grasses, the commonest being staggering or want of co-ordination of the muscles, particularly of the hind-limbs, weakness amounting to prostration, swelling of the lower portions of the limbs, fever, redness of the membranes, sweating, and an inability to walk straight or endure any exertion.

Treatment.—Beyond change of diet there is little to be done in these cases, as we have to deal with an unknown quantity and can only attempt the amelioration of symptoms. It is good practice to give a mild aperient, with the object of getting rid of the offensive matter contained in the alimentary canal, and to follow it up with stimulants and tonics. In this connection nux vomica is especially indicated when inco-ordination persists after appetite returns and febrile symptoms have disappeared.

In these cases the hay in use should be subjected to the closest scrutiny in order to determine, if possible, the actual ingredient giving rise to the trouble.



Fig. 462.—Starwort (*Stellaria Holostea*)

ACONITE POISONING

Preparations of the plant *Aconitum Napellus*, or Monkshood, are much used in veterinary medicine, both internally and for outward application, and mistakes occur now and again in consequence of an overdose being given, or a liniment intended for external application is administered in mistake for a draught, with fatal consequences to the patient. The plant grows freely in wayside gardens, and has produced poisonous effects on horses nibbling the leaves and flowers even in small quantity.

Symptoms.—Frothing at the mouth from excitation of the salivary glands, champing and movements of the head suggesting the burning sensation in the throat which is a well-known effect on human sufferers, purging, frequent and violent attempts at vomiting. The heart's action is so depressed as to make the pulse almost imperceptible, paralysis of the hind extremities supervenes, and the animal reels and falls about until he abandons the attempt to stand or an amelioration of his condition follows.

Treatment and Antidotes.—

Perfect quiet and freedom from all causes of excitement should be provided. Digitalis, the action of which is directly counter to that of aconite, affords a valuable antidote, and should be promptly administered. Diffusible stimulants, as for example alcohol and ammonia, may be given alternately with the above, and a laxative of linseed-oil early in the attack, despite the usual symptom of purging. Linseed-oil is said to allay the violent attempts at vomiting above mentioned.



Fig. 463 —Aconite (*Aconitum Napellus*)

26. VETERINARY HYGIENE

Everything which relates to the maintenance of health in the animal body is included in the word "Hygiene", or in the term which the late Dr. Chas. J. B. Williams preferred, "Hygienics". A perfectly accurate definition of health can hardly be formulated in words, at least, which will convey the exact idea existing in the mind of the physiologist. A sufficiently clear view of the condition is, however, present to the common

intelligence without the verbal formula. Every horse-owner, for example, knows whether his animals are well or ill, and usually he will be able to give an intelligent explanation of his reasons. In general terms health may be said to consist in the regular performance of the functions which are relegated to the various structures and organs of the body; these are simple or complex according to the position which the living being occupies in the animal world, and it is interesting to note that a vast number of organisms only visible with the aid of optical appliances live in a condition of ceaseless activity and perform their functions of respiration, circulation, nutrition, and locomotion—in fact everything which contributes to the completeness of organic life—in the most perfect way by the aid of very simple apparatus, so long as the conditions in which they are placed remain favourable to their existence. For example, myriads of living organisms, animals and plants, are found in stagnant water, and so long as the medium in which they live remains unchanged their activity continues. Should any serious alterations occur in the conditions of the medium on which their life depends, they become inert, all their functions cease, and the simple tissues of which they are composed become shrivelled, and the once active, living creatures are to all appearance dead. It is only necessary, however, in a large number of instances, to supply, to apparently dead creatures, the medium, water, which is favourable to their life, to enable them to resume their form and functions. The illustration is one of the most simple that can be offered of the physiological maxim that life depends upon the correspondence of the organism with its environment; when the correspondence ceases, either from failure on the part of the organism, or on the part of the environment, then life or health, or both, can no longer be maintained.

The science of Hygienics may be shortly defined as the maintenance of the relation which exists between the organism and its surroundings, and the important question arises in the case of the higher animals: What are the conditions which have to be maintained in order that the organism may perform its functions?

In considering the surrounding circumstances or environment in which an animal lives, it has to be borne in mind that the organism itself may be at fault, while the conditions of life may be in perfect order. When, therefore, it is assumed that if the conditions of life are maintained in perfect order the organism will remain in health, it must also be possible to affirm, with equal reason, that the organism was in a perfectly normal state to begin with. It is hardly necessary to add that in the greater number of cases this perfect correspondence does not

exist, and, to use a common expression, there may be faults on both sides. It becomes necessary, therefore, to take into consideration the fact that what may be called perfect surroundings absolutely adapted for the preservation of health in one animal may prove to be quite insufficient to secure the same results in the case of another. Indeed, the favourable conditions in the first case may have a tendency to induce disease in a subject which, from previous habit, or as a consequence of the influences of heredity, may be predisposed to contract certain disorders. A single illustration will make this proposition clear. In the case of one animal, the power to sustain extreme cold or extreme heat without suffering may be developed in a high degree. In another animal the system may be particularly obnoxious to cold or heat, and such an animal may suffer from catarrhal diseases which the first animal would entirely escape.

ORDINARY CONDITIONS OF HEALTH

Hygiene, although especially concerned with the maintenance of health, by a liberal interpretation may be made to include the means of prevention of certain diseases. It is, however, considered to be more convenient to apply the word "prophylaxis" to the science of prevention, although it is impossible to escape the conviction that every care that is taken to keep an animal in a healthy state necessarily includes the adoption of precautions to prevent the inroads of disease, whether common or specific.

Starting with the presumption that the science of Hygiene is to be applied to animals in a healthy condition and with the object of preserving health—in other words, prolonging the animal's life and keeping it in the highest state of efficiency for the work it is called upon to perform,—the question arises: What are the ordinary means by the agency of which this desirable end may be secured? The first thing which suggests itself relates to the function of nutrition. Even in a state of perfect animal idleness the ordinary physiological processes continue; oxidation, that is to say destruction, of tissues is always going on. Every movement of the animal, whether voluntary or involuntary, causes an appreciable amount of tissue waste; the waste products have to be excreted, as many of them are of a poisonous character, and the waste has to be replaced by new material. This repair of tissue demands a regular supply of solid and liquid food, containing the necessary materials for purposes of nutrition. Pure food and pure water in appropriate quantities are among the first essentials for the maintenance of life and health.

Closely connected with food and water, both being free from impurities as far as possible, is the air which the animal breathes. Even for the life of the most simple organisms air is necessary, and in the case of the higher organisms its withdrawal would be immediately fatal. And even when supplied in sufficient quantity it is capable of carrying with it deleterious constituents, some of them quite inappreciable by the senses under ordinary circumstances, but deadly in their influences to the animal's vital functions. The supply of a sufficient quantity of pure air at a proper temperature, and at the same time the elimination of stagnant air, is absolutely essential to the maintenance of health. Because, just as the process of nutrition implies the deposit of new material in place of the worn-out structures, which, if they had been allowed to accumulate in the system, would have poisoned the animal; so, on the other hand, the function of respiration is associated with the introduction into the system of fresh vitalizing air, and excretion of effete materials in a gaseous form, which, mixed with the air in the lungs, are exhaled at every expiration and discharged into the external atmosphere. These products of the respiratory process are poisonous, and if, owing to the absence of any means of escape from the building in which an animal is kept, they were permitted to accumulate, they would soon render the air contained therein effete and incapable of maintaining life and health. So it appears that food, water, and air, in proper quantity, and, so far as possible, in a state of purity, are the three primary conditions for the healthy environment.

It must be evident that the conditions above referred to are essentially concerned with the functions of organic life, and for the purpose of keeping a horse in the state of usefulness it may be further necessary that certain special organs should receive particular attention. The animal is required for purposes of locomotion. It is, therefore, indispensable that the feet should be kept in perfect condition; in other words, they cannot be left, as other parts of the organism may, to be maintained in a normal state under the influence of the ordinary reparative processes, because in domestication they are subjected to an excessive degree of wear and tear, from which in a state of nature they would be exempt.

The feet are protected by a covering of dense, but elastic, horny substance, which grows in proportion to the amount of wear which takes place under natural conditions, when the animal's movements are under its own control. In domestication, however, the experiment, which has been repeatedly tried, of working horses without some additional protection to the hoof has invariably failed, and the early practice of protecting the soles of the feet, or some portion of them, with iron plates or

rings, is still continued with certain modifications, or, as they may be called, improvements. Still, the admitted value of the artificial protection is vitiated by the necessity for the use of nails as the means of fastening. The feet of the horse are, therefore, placed at a disadvantage in comparison with the rest of the organism, in consequence of the unavoidable application of artificial protection in the form of shoes which are attached to them by nails driven through a considerable portion of the hoof.

Added to the necessarily injurious consequences of shoeing are those which arise from the hardness of the roads; and the two adverse conditions will account for the failure, to a greater or lesser extent, of the feet during some period of the horse's life, in spite of all the care exerted for their preservation.

Under exceptional circumstances it has not unnaturally been considered that the feet require exceptional treatment, and numerous devices in the form of "stoppings" and hoof-dressings have been employed at various times for the purpose, it is alleged, of keeping the feet in a healthy condition. Of most of these appliances it may be said that the feet may be very much better without them. Moisture is very necessary for the maintenance of a healthy condition of the horn, and this is naturally absorbed by the horn tubes, of which the hoof is composed, when they are kept in a natural condition. But if the tubes are blocked by sticky or greasy substances, they cease to be able to absorb the moisture on which their elasticity depends. The hygienics of the foot demands that the organ should be left, as far as may be, in a natural state; the evils which are attendant on the application of shoes are in some measure unavoidable, and under the present improved state of the farrier's art they are reduced to a minimum. For the rest, it can only be said that the less the horny covering of the foot is interfered with the better.

Next to the feet the legs, or, as they are termed, lower extremities, as far as the knees and hocks, deserve consideration. These parts are exposed more than other parts to contact with irritating grit and dust and mud in the ordinary course of travel. Cracked or chapped heels or "grease" and other eruptive diseases are the consequences of this exposure, and some animals are susceptible in a high degree to influences which would leave other less-susceptible subjects untouched.

The skin over the whole of the body requires special attention in the horse to keep it in a healthy state, and the difference between a sensitive and insensitive skin has to be recognized in relation to a horse as much as in the case of the human subject.

Peculiarities of temperament have also to be taken into account as

predisposing causes of disease of the nervous system, the digestive organs, and, in fact, the organs of the body as a whole.

Some kinds of food, again, tend to induce disorders of the integuments, and others to disturb the kidneys.

To detect and remove the various and often unsuspected causes which act in upsetting the balance of health in various ways is a task which necessitates close observation, and generally an amount of energy which is exhibited constantly by sanitarians in regard to the public health, but is rarely exerted for the benefit of the lower animals.

STABLES

CONSTRUCTION

The owner of the horse has often no voice whatever in the structure and general arrangements of the stable in which his horse is to be kept. In those cases, however, where the owner of the horse builds the habitation for the animal, he may select, within certain limitations, the site on which the stable is to stand and the materials which are to be used in its construction. The principal points to be observed are dryness and cleanliness. To secure dryness the building must not only be weather-tight, but damp must be prevented from rising through the walls and floors; an impervious damp-course must therefore be laid in the walls at the floor-level, and it is a good plan to spread a layer of brick or stone rubble under the flooring. The use of iron for stable fittings, and, as far as possible, in the construction of the partitions between stalls and boxes, in substitution for timber, is certainly desirable. The material is non-absorbent, and lends itself readily to processes of cleansing and disinfection. The timber which is absolutely indispensable should be well-seasoned, hard material, and be rendered as little absorbent as possible by being saturated with some of the tar products, or by a coating of paint or varnish. Bricks should be of the best quality, and for the inside of the walls bricks with a salt-glazed or with an enamelled surface are to be preferred. The salt-glazed bricks, which are of a reddish-brown colour, are more suitable for those walls which may be liable to damage, but at the heads of stalls, and above the level of the mangers in boxes, enamelled bricks or tiles may be used. Bright colours and pronounced patterns must be avoided; a grayish-green colour is the best, and an "egg-shell" glaze is better than a bright glossy surface. The question of material for the flooring is rather a difficult one. It is easy to see that certain conditions must be complied with—the flooring must be sufficiently hard, non-absorbent, and, above all things,

of a kind to afford a good foothold. Blue Staffordshire bricks, and buff adamantine clinkers, grooved in various ways so as to assist in the drainage of the surface, are commonly used for the purpose, but a good floor can also be made with Portland cement and granite chippings laid by expert workmen on a bed of brick or stone rubble.

The division of the stable into stalls or boxes will be arranged according to the number of animals to be kept, and the necessity which may arise from the limitation of space. There is no doubt at all of the advantages of boxes where space and cost are not paramount considerations. From 12 to 14 feet square are the ordinary dimensions, but smaller boxes down to about 10 feet square are often used; they must be large enough to allow the animal to alter its position as much as it chooses. The animal may be tied by the head, as in a stall, whenever necessary. Stalls from 6 to 7 feet wide and 10 to 11 feet long are economical in space and cost, and it is usual in the case of small stables to have one or two boxes for special use, and three or more stalls, as may be required. One or more sick-boxes, enclosed with walls and entirely disconnected from the other stalls and boxes, are necessary in all large stables.

In connection with the construction of stables, lighting, ventilation, and drainage are matters of supreme importance.

LIGHTING

The arrangements for lighting will depend upon the aspect of the stables and their surroundings. Stables which are built on to houses, or in proximity to them, commonly have very little choice in the matter. When it is possible to choose, the south would generally be preferred, but some authorities prefer east, and others west, and certainly there are many very good stables with a northern aspect. In arranging the windows, care should be taken that every portion of the stable is well lighted; means of cutting off the light from any part to some extent may be considered necessary, but nothing can be lost by having sufficient light to commence with, and windows are supplied now with special arrangements for ventilation, on which subject more has to be said in another place. (See chapter on Stable Architecture.) Probably the best position for stables is one in which the front of the building has an aspect between south-west and south-east; the back wall forming the heads of the stalls will thus face between north-east and north-west, and the amount and brilliance of the sunshine admitted through the windows over the mangers will be very small, and will not injuriously affect the eyesight of the horses. An ample measure of sunlight will be admitted through the windows

in the opposite or front wall, and will assist in keeping the stable bright and sweet. The importance of having windows on both sides of a range of stables cannot be overestimated.

VENTILATION AND AIR SPACE

It will not be questioned that a supply of pure air is absolutely essential to health, and accordingly the subject of ventilation has always attracted a large amount of attention from sanitary authorities. In theory nothing can be more simple; it is only necessary to provide openings through which pure air may pass in at one point, and other openings, in a different position, out of which the contaminated air may escape. This is, undoubtedly, the true principle of ventilation, but in practice it has been found extremely difficult to attain the results which are desired. The pure air is commonly found to enter with sufficient rapidity, and often in sufficient quantity, not only at the point through which it was intended to enter, but also at the opening which was intended for the escape of the contaminated air. The down-draught, as it is called, is the great trouble of the sanitary engineer, and it has not up to the present time been found possible to avoid this and to create an upward current with perfect certainty and regularity except by the use of machinery, or the employment of heat to rarefy the air at the intended point of exit, so that the air contained in the building may be induced to rise and escape as required.

Some interesting experiments were performed by Veterinary Major Fred Smith of the Army Veterinary Department, and described by him in his work on *Veterinary Hygiene*. The object was to ascertain the direction of currents, after entering a building by the means of windows, tubes, shafts, perforated bricks, or holes in various parts of the walls. The first thing which was noticed was the diminution in the rate of motion of a current of air in the act of passing through a shaft or tube, owing to the friction against the sides of the passage. It follows, therefore, that the loss of motion in the air will be considerably less in a wide than in a narrow passage. A further cause of diminution of velocity and interference with escape of air exists in the bends or angles in the passage, and it is important to remember that in such bends accumulation of dust is inevitable, and that when bends are unavoidable some method must be devised for the purpose of keeping them clean.

A very common device for ventilating a building is that of the shaft divided into two by a diaphragm running down the centre. By this method it is presumed that one side of the shaft will act as an inlet, and the other side as the outlet; but in practice the operation is by no means always satis-

factory. The same may be said of a somewhat similar arrangement, the double tube: a large one for the outside, and a small one passing through it. In this plan the larger tube is intended to act as an inlet, and the smaller one as the outlet. But it is very commonly found that the result is a down-draught always in full action, while the outlet either has the opposite to the intended effect, contributing to the down-draught, or otherwise does not act at all.

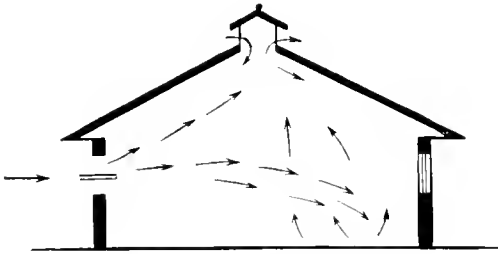

Fig. 464.—Direction taken by Air-currents with the Windward Windows open

another a scarcely calculable quantity will pass in. To meet this difficulty, to some extent, the author of *Veterinary Hygiene* is in favour of openings being made on opposite sides of the building; and he insists that to get the full benefit of such an arrangement the buildings must not be more than from 25 feet to 30 feet wide. He found that a current entering through an inlet will cause the air in the stable to set in towards it in a direction more or less at right angles; and if the velocity of the incoming current is great, it may pass out again at the opposite opening before it has properly mixed with the air in the stable. The results of the experiments made by the author of *Veterinary Hygiene* will be best understood with the aid of the accompanying diagrams, which are taken from his work.

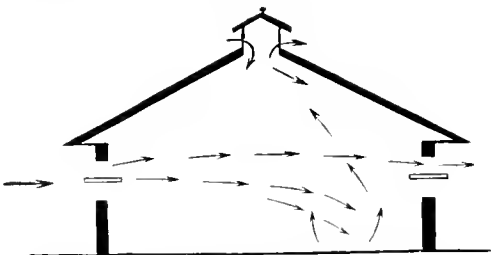

Fig. 465.—Direction taken by Air-currents with Windward and Leeward Windows open

In the first illustration the wind is supposed to enter at a window which is opened to windward (fig. 464). Soon after entering, the current is described as spreading out fan-shaped and passing towards the ground; and in the case of a powerful current it may be measured 18 or more feet from the point of entry, but under ordinary conditions its speed rapidly decreases owing to the pressure of the air in the stable at about 6 or 8 feet from the inlet. The current is further described as striking the ground on the opposite side of the stable, much of it escaping by the leeward side of the ridge, or by the

opening by which it entered. The windward side of the ridge opening is also presumed to act as an inlet. In the next illustration (fig. 465) the windows on opposite sides of the building are shown open. With this arrangement the air which rushes in at the windward side was observed to proceed very much in the same way as in the first instance. Some of it, however, is driven straight across to the leeward window and escapes at once.

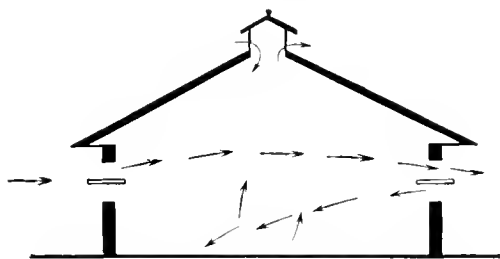

Fig. 466.—Double Currents from opposite Windows

Sometimes the movements indicated in fig. 465 are disturbed by a backward current suddenly coming in through the outlet window, meeting the current which comes from the windward window (fig. 466). The two currents then spread out towards the centre of the stable, strike the ground, and then rise to escape at one side of the ridge. This condition is one which, as a matter of course, depends on a change in the direction of the wind, and is, therefore, only temporary.

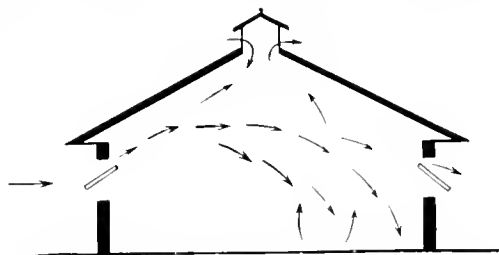

Fig. 467.—Direction taken by Air-currents when opposite Windows are half-open

A different set of movements occurs when the opposite windows are half-open in such a way (fig. 467) that the current of air is directed upwards. By this arrangement the entering air is delayed sufficiently long to allow it to mix with the air in the stable before it escapes from the leeward window. It was observed that if the windward window remains half-open, and the leeward one fully open, the air escapes from the stables without mixing properly.

A further change was noticed when the windward windows were half-open and the leeward entirely closed. The current passed upwards to the ceiling, and then descended and mixed with the stable air—the ridge in this case constituted the outlet.

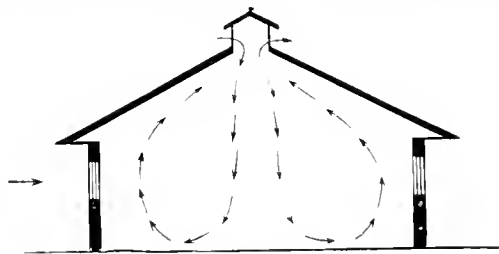

Fig. 468.—Direction taken by Air-currents when Doors and Windows are closed

When all the windows were closed, and the door opened, the ridge appeared to act as a regular outlet; with both the doors and windows shut the ridge openings acted as inlets and outlets, as shown in fig. 468.

This summary of the description given by Major Fred. Smith will

convey to the reader a fair idea of the influence which the opening of doors and windows can be made to exercise upon the distribution of air throughout a stable. The great value of these observations lies in the fact that they refer to the very simple appliances which are at everyone's command, consisting merely of ordinary doors and swing windows, placed opposite to each other in walls not more than 30 feet apart.

Writers on ventilation describe artificial ventilation as distinct from the "natural" ventilation obtained by ordinary appliances such as doors, windows, and holes in buildings. Artificial ventilation may be arranged to operate in one of two ways, namely, (1) by "extraction" of the air which is already in the building, and (2) by "propulsion", which consists in the driving out of contaminated air by the forcible introduction of fresh air. Extraction is effected by heat, by steam-jet, or by fan or screw. The most simple instance of "extraction" by heat is that of the common fireplace, with its open chimney, in which the upward current is in proportion to the amount of heat and the area of the chimney.

Dr. Parkes refers to a room which he frequently examined where the area of the chimney was 1.5 square foot. There was no down-draught, but a constant upward current of 4 feet per second; the discharge per second was then 6 cubic feet, or 21,600 cubic feet per hour. The capacity of the room was 2000 cubic feet, so that a quantity equal to the total air in the room passed up the chimney nearly eleven times per hour. Notwithstanding this, the room became close when shut up with two or three persons. The explanation given is, that when the windows were shut the fire was chiefly fed with air which entered below the doors, and, flowing near the ground to the chimney, was never properly diffused through the room. It was found that the current near the ground moved from 1.6 foot to 2.6 feet per second, and chilled the feet. A few feet above the ground no movement could be discovered. No better example than this could be given of the great importance of arranging for the proper entrance and distribution of air as well as for its exit.

When a fire is lighted, all places in the room through which air can pass act as inlets, and as the necessary result currents in various directions come from places which were meant to be outlets, causing what are so very much dreaded by people in general, so-called draughts. The common remedy for this state of things is the blocking up of all the cracks in doors and windows which can be reached, and the plugging of any ventilating tubes or shafts by the aid of dusters or any other material at hand. In a stable a mass of hay forms a convenient plug for any hole through which the air passes too freely for the comfort of the persons employed about the stable. In a room so treated, it is noticed that when all the openings through

which air can enter are plugged, the chimney itself becomes an inlet at intervals, and consequently sudden rushes of downward currents occur, bringing with them a quantity of smoke; but when the inlet of air is properly regulated and provided for, the open fireplace with its chimney is undoubtedly a very useful method of ventilation. It may be urged that the method is not generally applied to a stable, but in the case of new constructions there certainly is no reason why it should not be, provided that a suitable wire screen is placed around the hearth to prevent any risk of straw, &c., catching fire.

Extraction of air by a steam jet requires apparatus not in common use, and is not likely to be employed for the ventilation of stables.

Extraction by means of fans is a method which has been employed successfully in the ventilation of mines, and to a smaller degree in buildings, but the plan involves cumbersome machinery, and can hardly be called a practical method of ventilation for stable use. The place of the fan may be, to some extent, supplied by means of different forms of cowls, the chief objection to which is their uncertainty, owing to changes in the direction of the wind, and in perfectly calm weather the absence of any currents in the outside air. These appliances, however, form part of the apparatus used in so-called "natural" ventilation.

Ventilation by propulsion, although a powerful method of delivering a quantity of air, is not one which is likely to be generally used in stables. According to Dr. Parkes, the plan is an old one, invented indeed by Desaguliers in 1734. The machinery consisted of a fan or wheel, enclosed in a box. The air passed in at the centre, and was driven by the vanes of the fan into a conduit leading from the box to the building to be ventilated. The principle of this system, which is now generally known as the "Plenum" system, is that of pressure from behind, the external air being forced in at a pressure proportionate to the speed of the revolution of the fan, thus driving out the fouler air through the openings provided for the purpose. Where expense is no object the plan is no doubt an effective one, as air can be passed through water and thus washed, or through heated tubes and thus raised to any temperature which may be desired, but in practice its use has hitherto been confined to very large establishments, town-halls, hospitals, &c. Where electric current is available, an electric fan, which can be installed at a trifling cost, is the simplest method of applying the system.

It must be admitted that all methods of ventilation which necessitate the use of special apparatus are encumbered by the objections that they are costly and in various ways inconvenient. Among others is the very important one, that skilled attendance is necessary.

For practical purposes the method of ventilation which has been described, by the aid of openings at opposite sides of the building and at the ridge, is the most simple, and, if properly arranged, the most effectual.

A certain quantity of fresh air is absolutely indispensable for the maintenance of life. A horse requires something over 15,000 cubic feet of air per hour. But the question is not one of quantity only; there can be no doubt at all that the exact amount of air which a horse requires may be fully provided and yet be in such a condition as to destroy the animal in a short time.

The difficulty of ventilating a stable is increased by the objection which the groom entertains to a current of cool air, which, however pure, will make his horse's coat rough, or cause the warmly-clothed animals, which have been habitually kept in hot stables, to shiver. This is a fact which the groom will demonstrate without any difficulty, to ensure conviction in the mind of his master, by opening a window behind one of his horses and causing the animal to shiver forthwith as soon as the unaccustomed cool current touches its skin. After this demonstration, with which stablemen are perfectly familiar, the question is settled at once, without any further argument, and the owner of the animal, if not convinced, is at least silenced.

The demonstration, although utterly fallacious, contains a valuable suggestion, to the effect that the air of the stable should, by some means, be properly regulated to a moderate temperature, so that the horses should not be subjected to either hot or cold currents of air.

If open fire-places with warm-air chambers are not provided, perhaps the most satisfactory way is to heat the stables (or the air entering them) by means of a low-pressure hot-water heating apparatus.

Contamination of Air.—A very large number of causes of contamination of air by physical and chemical agents are given by Dr. Parkes in his work on practical hygiene.

Among the mineral substances which are suspended in the atmosphere are particles of coal, sand, steel or other metal, and everything which is included in the term dust, flocks of cotton, flax, hemp, all of which may be either inhaled or swallowed. It is perfectly well known that many trades are distinguished as unhealthy in consequence of the inevitable mixture with the air of various products which are connected with manufacturing processes. The effect of the air of mines appears to be particularly deleterious to the health of the miners. It was stated many years ago, by the chief medical officer of the Privy Council, that 30,000 miners in England break down prematurely every year from pneumonia and bronchitis. At that time one exception only was given: the colliers of Durham and Northumberland, where the mines were well

ventilated, and the miners did not suffer from pulmonary affections, excepting in an ordinary degree. The evidence of the extent to which the air of mines is contaminated with coal-dust is of a very emphatic kind. In the next illustration a specimen of a miner's lung is given, showing the enormous accumulation of coal-dust in the lung structure.

Stone-masons and metal-workers, also workmen in potteries, grinders, button-makers, cotton-spinners, match-makers, and others have all been mentioned as suffering from the effects of the contaminated air which they habitually breathe.

Horses are often looked upon as animals which, to a great degree, are exempt from the action of air contaminated in the manner described, but the evidence in proof of this belief is extremely meagre, in fact it is mainly negative; indeed it does not seem to have occurred to anybody that the condition which we have just illustrated of the coal-miner's lung would be found in the lungs of the horses working in the same pits if it were looked for, and there cannot be any doubt whatever that horses working in positions where the air is largely mixed with dust, or otherwise contaminated with mechanical impurities, would exhibit traces of injury from these causes in their pulmonary organs on post-mortem examination.

Occasional outbreaks of disease have occurred among horses grazing in the neighbourhood of brick-kilns and smelting-works, and chemical investigation has demonstrated the existence of poisonous products in the air which the animals had to breathe, and also in the pasture on which they were feeding, and it is quite possible that in many instances of unexplained outbreaks of affections of the respiratory organs the cause might be found in the condition of the atmosphere, the presence in it of either mechanical or chemical matters.

Substances of a much more deleterious character than ordinary dust undoubtedly obtain an entrance into the air; these come under the head of organic impurities.

Organic Impurities.—Contamination of the air constantly occurs, and to some extent at least is inevitable; the process of respiration, for example, has the effect of charging the atmosphere with carbonic acid



Fig. 469.—Section from Upper Lobe of a Collier's Lung

A. Deposits of coal dust in the air-vessels
(highly magnified).

(carbon dioxide), as well as various organic impurities or products of decomposition given out with the expired air. How deadly these mixtures of the products of respiration may become is illustrated by the constantly-quoted case of the Black Hole of Calcutta, in which, out of 300 men who were imprisoned, 260 died very quickly from the poison which they breathed from their own lungs. Carbon dioxide, which is one of the products of combustion, is extremely poisonous, and contamination of the air with more than 1 per cent is rapidly fatal to animals. Sulphuretted hydrogen, a gas set free in the decomposition of organic matter, is highly deleterious to animals.

Ammoniacal vapours, which are constantly present in badly ventilated stables, exercise an irritating effect on the sensitive membrane of the eyes, and the comparative rarity in the present day of ophthalmia and other serious diseases of the eyes among horses is ascribed to the improvement which has taken place in the methods of construction and ventilation.

Admixture of sewage gas with the atmosphere is probably responsible for the occurrence of many forms of derangement of the digestive organs which may often be attributed to other causes.

Emanations from marshes were for a long time regarded as being the immediate cause of certain specific fevers in man and animals, but while marsh lands are undoubtedly unhealthy, it has now been demonstrated that malaria is caused by inoculation with the germs of the disease through the agency of mosquitoes. A somewhat similar case is that of the disease following upon the bite of the tsetse fly in South Africa.

The most dangerous forms of organic contamination are undoubtedly the minute organisms, which under certain conditions produce specific diseases when introduced into the bodies of animals, including man. The different disease germs are active in different ways; thus, the germs of phthisis (pulmonary consumption) may produce disease when inhaled; the bacillus of enteric (typhoid) fever when swallowed; and the tetanus (lock-jaw) bacillus when received into a wound or scratch. Pure air and water, cleanliness and sunshine, are important weapons against these invisible foes.

It may be observed that while air charged with disease germs may be inhaled with impunity by the perfectly healthy animal, it may prove fatal to the animal which is in bad condition.

Cases of the injurious effects of contaminated atmosphere might easily be multiplied, but enough evidence has already been advanced to prove the necessity for a sufficient supply of pure air as one of the factors in a condition of perfect health.

Cubic Air-Space.—It has already been stated that each horse will require something over 15,000 feet of pure air per hour, but this by no

means implies the necessity for large cubic space in the stable, as any quantity of air may be passed into and out of a space which is only sufficient to allow the animal to stand in it. Major Fred. Smith remarks that a very common error is made in considering that cubic space will supplant ventilation, and consequently too much stress has been laid on the importance of a large cubic capacity. In illustration of the error included in this assumption he takes examples of two stables—one of 600 cubic feet, and the other of 1500, a variation which is by no means uncommon. Obviously a horse stabled in each of the two spaces would require the same amount of air; and, in order that this might be supplied to each of the animals, it would be necessary that the whole of the air in the former should be changed a little over fifty-four times per hour, while in the 1500-cubic-foot space the air need not be changed more often than a little over twenty-one times per hour. The advantage, therefore, of a large cubic space is that it does not necessitate so frequent a change of air. So far as the contamination of the atmosphere included in either space is concerned, the value of a large cubic capacity is comparatively trifling, being only the difference of time which will be necessary for the contamination of the air it contains in each case, and it is hardly necessary to observe that when the air is equally contaminated the effect would be precisely the same on the animal organism, whether the stable contains 600 or 6000 cubic feet.

The following table is given to illustrate this point, and shows exactly, at a glance, the result of the mixture of the products of respiration with the air in cubic spaces of different dimensions:—

Breathing space for one horse in cubic feet.	Ratio of CO ₂ per 1000 at the end of first hour, if there has been no change of air.	Amount of air necessary during the first hour.	Amount necessary every hour after the first.
600	5.03	14,400	15,000
700	4.38	14,300	15,000
800	3.75	14,200	15,000
900	3.33	14,100	15,000
1000	3.00	14,000	15,000
1100	2.72	13,900	15,000
1200	2.50	13,800	15,000
1300	2.30	13,700	15,000
1400	2.13	13,600	15,000
1500	2.00	13,500	15,000
1600	1.87	13,400	15,000
1700	1.76	13,300	15,000
1800	1.66	13,200	15,000
1900	1.57	13,100	15,000
2000	1.50	13,000	15,000
3000	1.00	12,000	15,000

The cubic space for army stables has been fixed at 1605 cubic feet per head, and for infirmary stables at 1900 cubic feet per head; these dimensions render it necessary, in order to provide the horse with the 15,000 cubic feet of air per hour, to change the air in the first stable (1605 cubic feet per head) about nine and a half times per hour. These dimensions suggest the necessity for very complete and perfectly controllable means of ventilation.

It is not probable that a space of more than 1000 cubic feet will be allotted to each horse in ordinary stables when only a few horses are kept, and this, with proper ventilation, will prove to be quite sufficient. Where new stables are being built under the control of the owner, the common plan of placing living rooms or lofts over the stables may advantageously be abandoned. Great height is not at all desirable, and where the roof is carried up, and ventilators are put in the ridge, a height of 10 to 12 feet to the eaves may be taken as a standard height.

The most violent advocate of fresh air and free ventilation will not deny the stableman's assertion that in a warm stable the animals' coats are rendered fine and glossy, and the horses do better on a smaller amount of food than they would in a large, cold stable, in which, whatever is done to protect them, they always put on a half-starved appearance, as the groom will designate it. The problem of how to provide a sufficient quantity of pure air in a reasonable cubic space, without keeping the animals too hot or too cold, is one that cannot be solved without incurring the expense of a somewhat elaborate system of warming and ventilation.

Where the cost of warming the air required for ventilation is prohibitive, the best method is to provide windows on opposite sides of the stables and perhaps also in one end, the windows themselves being of the "hopper" type, so that the air enters the building with an upward current. Triangular side-pieces or checks should be fixed to the frames so that, when the windows are open, the air cannot enter except at the top. The windows at the rear should be well above the horses' heads. As windows are provided on opposite sides of the stable, it will always be possible to open some of them, without creating excessive draughts, whatever the direction of the wind may be. If the ceiling is flat, these windows will in many cases serve adequately for inlets and outlets, but where practicable it is better to provide one or more outlets at a higher level. The continuous ventilator along the ridge, with louvre boards on both sides, is certain to prove draughty, and cannot fail to admit air when the wind is blowing strongly against it. There are many different cowls or exhaust ventilators which are more suitable for the purpose.

Much of the coldness complained of in stables is due to defective

construction; for example, the roof tiles may not be laid in mortar or "torched" with mortar underneath, and the ceiling may be neither plastered nor boarded. The result is that the warmth given off by the horses is rapidly dissipated, and in winter the stable is much too cold while in summer it may be too hot. Tiles laid in the way described above do indeed allow a constant passage of air, and are therefore useful for ventilation, but the ventilation is not (as it ought to be) under control. The windows which have been recommended can be opened and closed at will, and the exhaust ventilators are fitted with valves, operated with cords and pulleys, and by these means the inlet and outlet of air can be controlled.

According to the table, 15,000 cubic feet of air are required by each horse per hour. If the velocity of the air entering the stable is 2 feet per second, the size of the inlet opening must be $\frac{15000}{2 \times 60 \times 60} = 2\frac{1}{2}$ sq. feet. This area would be provided by a window 3 feet wide, opening to the extent of about 8 inches. If the windows on the opposite sides of the building—that is to say, two for each horse—are of this size, the required amount of air will be admitted when only one is open. To prevent excessive velocity in the inflowing air, the top of the opening of the hopper is sometimes covered with finely-perforated zinc, but this necessitates a larger opening, as the effective area is reduced about one-half by the metal gauze.

A higher velocity may be allowed for the air escaping through the exhaust ventilator (say) 5 feet per second, and on this basis the area required for each horse will be $\frac{5}{6}$ sq. foot. A ventilator with the internal circular shaft 20 inches in diameter would, therefore, serve for three horses.

In practice the areas of inlets and outlets are often less than those given above, as a certain amount of ventilation takes place through the walls and roofs and through open doors, and somewhat higher velocities are considered to be admissible.

When all is done, however, there are many days in our variable climate when it is impossible with safety to provide by the system of "natural" ventilation the full amount of fresh air which is theoretically required. The cold draughts which would follow the attempt would be dangerous to many animals, and the choice must be made between the two evils of cold draughts and insufficient ventilation. In nine cases out of ten the latter will be considered to be the less of the two.

DRAINAGE

In applying the principles of drainage to the habitations of the domestic animals there are on the whole fewer difficulties to be overcome than in the case of the human being. The effectual removal of solid and liquid excreta is the object sought in all cases; but while the sanitarian, in dealing with houses inhabited by human beings, is compelled to devise some method, not only for the removal of excreta, but also for destruction or disposal of it in such a manner that no nuisance may arise from its accumulation, the solid and liquid excreta of the horse have a commercial value as fertilizing material or manure, and are not therefore destroyed or deliberately allowed to pollute rivers and water-courses, as it pays better to store them for use. The difficulty in dealing effectually with solid and liquid excreta from the lower animals arises from the fact that the quantity voided by the larger quadrupeds is considerable, and, in respect of the solid manure, the act of excretion or expulsion is frequently performed, rendering it almost impossible to keep a large stable in a condition of even moderate cleanliness.

Emanations from animal excreta are not likely to contaminate the air of a stable or cow-shed to any serious extent while in a fresh state, but both solids and fluids rapidly undergo decomposition, the result of which is to set free certain compounds of hydrogen and other gases, which are not only offensive, but, some of them at least, poisonous—sulphuretted hydrogen, for example, arising from the solid excreta chiefly.

Urine very quickly changes its state, and sets free a quantity of ammonia in a gaseous condition. Ammoniacal gas has an intensely pungent character, and causes severe irritation of the mucous membranes of the eyes and nostrils, to an extent which can only be appreciated by those who have entered a badly ventilated or unventilated stable in which a large number of horses are habitually kept, or the holds of cattle-ships immediately after the cargo has been landed. A little experience of this kind should suffice to convince a horse-keeper of the great importance of making proper arrangements for the removal of excreta from the stable at once, no matter how often it may be necessary, to some convenient place of storage at a distance from the stable, so that the gases from the manure-heap may not be driven by winds into the stable or shed.

Stables in large towns are generally situated in rows in a long mews, and the dirty straw, with the excreta, often form a conical heap outside the stable door. Usually the sanitary authorities insist on the removal of the heaps at short intervals, so that very little opportunity is allowed for putrefactive fermentation to go on; but the same system is often adopted in the open country, where there is ample space for proper storage. The real

difficulty is that the space outside the stable door is the most convenient spot for the attendants to heap the manure temporarily, or until enough has accumulated to justify the use of a cart or wagon for its removal.

In London the regulations concerning receptacles for dung are now somewhat stringent. The capacity of the receptacle must not exceed 2 cubic yards, unless "the whole of the contents . . . are removed not less frequently than every forty-eight hours"; the bottom must not be below the level of the ground; one of the sides must be readily removable to facilitate cleansing; and the receptacle must be so constructed as to prevent rain or water from entering it, and the escape of the contents, or any soakage therefrom, into the ground or into the wall of any building, and it must also be freely ventilated into the external air. If the dung is removed from the premises not less frequently than every forty-eight hours, a metal cage may be used as a receptacle, but the ground beneath it must be adequately paved to prevent soakage into the ground, and if the cage is placed near a building, the wall of the building must be cemented "to such an extent as will prevent any soakage from the dung . . . into the wall".

Calculations have been made of the amount of solid and liquid excreta voided by different animals in a given time, and the results have proved useful, not only in physiology but also in practical farming.

The late Professor Varnell, in the course of his observations at the Royal Veterinary College, found that a horse discharged from the body 49 lbs. of dung and 29 lbs. of urine in twenty-four hours. Col. Fred. Smith, from his own investigations, practically confirms Professor Varnell's estimate. He also records that a cow voids about 160 lbs. of dung and 18 lbs. of urine in twenty-four hours.

In different animals the consistency of the solid excreta varies very much in proportion to the amount of water it contains. Fortunately the dung of the horse in health is fairly dry, and may often be lifted from clean straw with the stable-fork or shovel, leaving hardly a trace behind it. Some horses, however—animals of an excitable temperament,—void a quantity of soft dung from time to time, and in some the habit of evacuating watery dung in small quantities at frequent intervals is maintained in spite of treatment. Such animals can hardly be considered healthy, although no other symptoms of derangement may be observed.

In the matter of the mechanics of stable drainage simplicity is all-important. The main object to be kept in view is the single one of perfect efficiency; so long as that is attained, the means employed are of secondary consequence.

Some differences in the system of drainage employed for stables in towns, as compared with those in the country, is not only permissible, but

may in many cases be desirable. A town stable has, for instance, to be connected with the sewerage system, for which purpose advantage is taken of the sewer which is nearest to the stable, and the principal points to be considered are the best method of connecting the stable drain with the sewer, and whether the stable drain shall consist of an open channel or

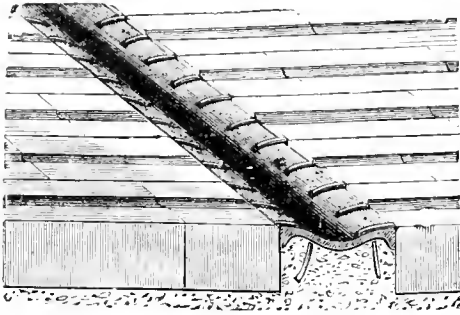

Fig. 470.—Wrought-iron Open Gutter
(St. Pancras Ironworks Co.)

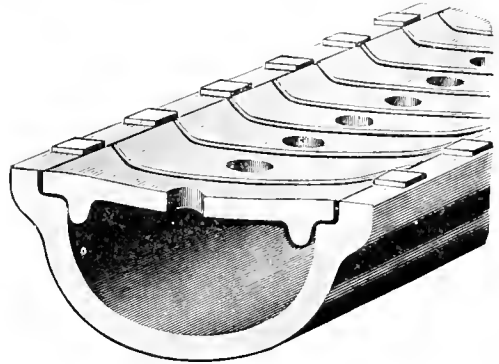

Fig. 471.—Covered Surface-drain

a closed one in the form of a pipe sunk a short distance underground, and running to the outside of the stable into a trap.

The object of trapping is to prevent the passage of gases from the sewer back into the stable, and it will be understood that, in the attempt to attain this very essential object, the disconnection of the stable drains by this means, whatever form they may assume, should be as complete as possible. Undoubtedly the most simple and sanitary method is the surface-

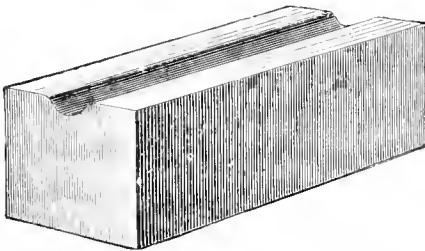

Fig. 472.—Brick with Drainage Channel for
Stable Floor

drain, which may be a mere open channel running from the front of the stall backwards, or it may be provided with a movable cover, so as to admit of the necessary cleansing and prevent obstruction. The two illustrations above show the two systems of the open and covered surface-drain (figs. 470, 471).

In applying the system of surface-drainage, whether covered or uncovered, it is necessary that the floor should be inclined in such a manner as to allow a sufficient fall for the escape of the sewage. In the case of stalls the fall is necessarily from before backwards. In the box it is commonly made to converge towards the centre, to which all fluid matters are conveyed by grooves in different parts of the flooring (fig. 472), and thence, by means of an underground drain, to the outlet; but with a little ingenuity surface channels can be used in boxes as well as in stalls, and are certainly better, as a drain-inlet

within the building is a possible source of danger to the animals and also to the men employed.

Various methods may be adopted, according to the size of the stable. In the case of a large one the separate channels in each stall or box run into a long channel at the foot of the stall, the outlet of which is at either end of the stable. When only two or three stalls or boxes have to be provided for, the urine may be conveyed from each by a separate channel to the outside of



Fig. 473. —Drain-pipe with Flap

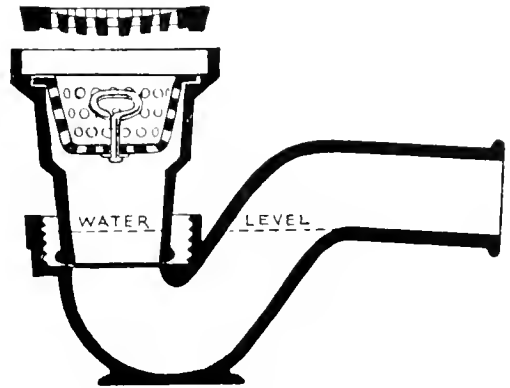

Fig. 474.—Winser's Iron Gully.

the stable; in fact, so long as the true principle is maintained, it is a matter of indifference how the details are arranged.

The channels in the stables must be disconnected from the drains outside by being made to discharge over trapped gullies. The liquid passes from the channel through a short iron pipe built into the wall, and it is a good plan to fit on the outer end of this pipe a brass or iron flap hinged at the top to open outwards (fig. 473), so that, while the liquid can run out readily, the flap prevents to a large extent the inlet of more or less foul air. Two good forms of gully are shown in figs. 474 and 475, one being of cast-iron and the other of stoneware, and each having a grating at the top and

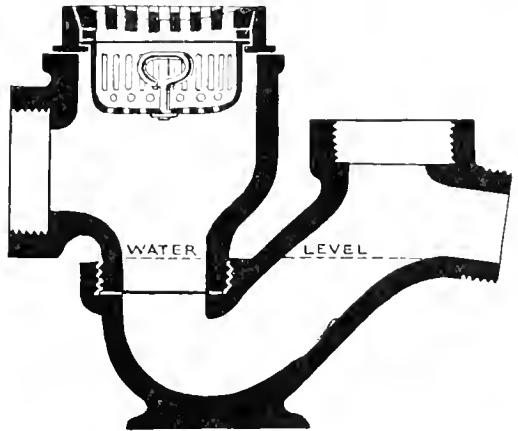

Fig. 475.—Winser's Stoneware Gully

a strainer below to retain solid matter. The stoneware gully has a side inlet, to which the drain from a grid under a water-tap can be connected. If the sewage is conveyed by the drains into a manure-tank, cesspool, or public sewer, aerial communication between these and the drain must be stopped by an intercepting trap, which is most conveniently placed in an underground chamber or manhole provided with an air-tight cover. The

drains must be ventilated by means of a grated opening a little above the surface of the ground (for preference near the intercepting chamber), and by a 3½- or 4-inch stout pipe of lead or cast-iron fixed to the wall of the building at the highest point of the drain and carried up to such a height and in such a position as to afford a safe outlet for foul air.

Stoneware pipes jointed with Portland cement and laid on a bed of concrete are commonly used for drains, but cast-iron pipes are more durable and more permanently water-tight.

In the next illustration (fig. 476) a very good method of draining by the use of underground pipes, where that system is already in use or is at any rate determined upon, is shown.

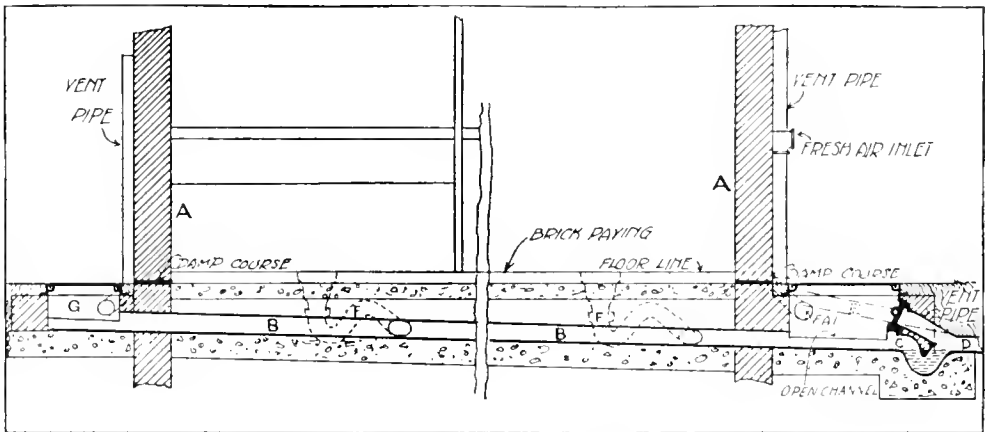

Fig. 476. Underground Drain for Stable

In this drawing A, A represent the walls of the stable, B, B the stable drain-pipe starting from the manhole G outside one end of the stable, and running under the stable to the manhole at the other end in which the siphon-trap C is placed. Into this drain the gullies F, F inside the stable, discharge. The siphon contains water the level of which is shown by the interrupted lines. In theory at least the water is a barrier against the passage of foul air from the outlet drain D back into the stable pipe, as such air will take its course through the clear opening of the ventilating pipe E rather than attempt to force the guarded part of the siphon C, which protects the stable pipe. As will be seen in this drawing, the drain is ventilated through pipes passing into the manholes at either end. These manholes are covered with air-tight iron covers, and provision is made for easy access for the purpose of cleaning out the drain by means of a brush with jointed cane handle. A trap similar to C must be placed between the outlet drain and the sewer or cesspool. It is of course essential that the gullies and the drain should be kept well flushed. Automatic flush-

tanks are now made for fixing at the highest points of drains, and can be regulated to discharge a fixed quantity of water periodically—(say) once or twice a day. They require no attention, except for cleaning and repairs, and are useful for keeping drains clean, particularly in flat districts where the drains are laid with very little fall. The automatic flush-tanks may be supplied from an overhead rain-water tank, but a supplementary supply of water should be laid on for use in dry weather.

FOOD

Nutrition may be defined as the process by which the waste which is constantly going on in the animal's system is compensated by the deposit of fresh material derived from food, solid and liquid. To understand exactly what is required it is necessary to know something of the constitution of the body, and it may be stated, in the first instance, that four elementary substances, oxygen, hydrogen, carbon, and nitrogen, are the principal constituents of the important tissues of the animal body, muscle, nerve, and the solid particles of the blood.

Constitution of the Body.—Organic bodies include albuminoids or proteids, gelatine, horny matter, and fats (composed of carbon, oxygen, and hydrogen, nitrogen being absent). All these constituents are combustible. Besides the combustible constituents there is a considerable proportion of incombustible, and when burned with those which are combustible they are left as ash, of which bone ash forms the largest proportion. Bone ash consists chiefly of phosphate of lime and magnesia, with a small quantity of the carbonate. The ash obtained from the burning of muscle or flesh contains a considerable proportion of the phosphate of potassium. The whole of the constituents of the animal body are combined with a very large proportion of water, which, however, varies in different animals, and at different ages, from a little over 40 per cent to nearly 70. The following table will show the proportion of water, nitrogenous matter, fat, and ash in the bodies of cattle, sheep, and pigs:—

PERCENTAGE COMPOSITION OF WHOLE BODIES OF ANIMALS

	Fat Calf.	Half Fat Ox.	Fat Ox.	Fat Lamb.	Store Sheep.	Fat Sheep.	Extra Fat Sheep.	Store Pig.	Fat Pig.
Water ...	65·1	56·0	48·4	52·2	61·0	46·1	37·1	58·1	43·0
Nitrogenous Matter ...	15·7	18·1	15·4	13·5	15·8	13·0	11·5	14·5	11·4
Fat ...	15·3	20·8	32·0	31·1	19·9	37·9	48·3	24·6	43·9
Ash ...	3·9	5·1	4·2	3·2	3·3	3·0	3·1	2·8	1·7

The Functions of Foods.—The fact that food contains albuminoids, which correspond to the constituents of flesh, and hydrocarbons, which represent fats, and also mineral constituents, which have been referred to, has led physiologists to adopt certain theories in reference to the function of each class of food in the animal body. The nitrogenous constituents and albuminoids have had ascribed to them the function of flesh-formers. They are distinguished from other nitrogenous constituents by the presence of a small quantity of sulphur and phosphorus, which constituents are absent from gelatine. Fats and also carbohydrates, such as starch and sugar, are considered to represent the combustible materials or heat-forming substances which are consumed in the process of respiration, the excess being deposited in the form of fat.

It is stated that animals cannot subsist on a diet composed exclusively of flesh-forming materials, nor on one from which carbohydrates are entirely excluded. On the other side there are instances recorded of animals having lived in perfect health for a considerable time on nitrogenous and also on non-nitrogenous foods. These exceptional cases need not be taken into account in practice, as there is sufficient evidence that the animal to-day requires for its support a food in which are combined all the constituents which are found in the organism.

Experiments have shown that nitrogenous food can be used for the formation of fat, and it is admitted that all the fat which is found in the body could not have been obtained from the amount of fatty matters which have been consumed as food. And the fact of animals having lived and been maintained in health on purely nitrogenous diet, is sufficient in itself to show that a considerable proportion of the material must have been consumed in the process of respiration.

Assuming that albuminoids are chiefly concerned in the formation of flesh and the development of force, only contributing in a minor degree to the formation of fat, it must also be allowed that fats have for their principal function the production of heat as a result of oxidation, and in this they are assisted by other carbohydrates—starch, sugar, and gums. But it is certain that they do not in any way contribute to the formation of nitrogenous constituents.

An important point is to be considered in reference to the respective value of each article of diet and its digestibility. A food may contain a considerable proportion of albuminoids which are comparatively useless to certain animals, on account of the digestive organs being incapable of appropriating the nutriment they afford. Bean straw, for example, contains 8 per cent of nitrogenous substances, but its structure renders it comparatively indigestible as food for the horse, in which animal digestion

is quickly performed, while it may be valuable diet for cattle, with their prolonged process of digestion, including rumination, which is really remastication. The following table from Warington's *Chemistry of the Farm* indicates the amount of water, nitrogenous substances, fat, soluble carbohydrates (starch, sugar, gums), fibre, ash, and albuminoids in the foods which constitute the provender of farm animals, and most of these foods are employed for feeding horses:—

PERCENTAGE COMPOSITION OF ORDINARY FOODS

Food.	Water.	Nitrogenous Substance.		Fat.	Soluble Carbohy- drates.	Fibre.	Ash.
		Albumin- oids.	Amides, &c.				
Cotton Cake (decorticated)	8.2	43.2	1.8	13.5	20.8	5.5	7.0
Cotton Cake (undecort.) ...	12.5	20.7	1.3	5.5	34.8	20.0	5.2
Linseed Cake	11.7	26.9	1.1	11.4	33.2	9.0	6.7
Rape Cake	10.4	28.1	4.6	9.8	29.1	10.3	7.7
Earthnut Cake	11.5	45.1	1.9	8.3	23.1	5.2	4.9
Beans	14.3	22.6	2.8	1.5	48.5	7.1	3.2
Peas	14.0	20.0	2.5	1.6	53.7	5.4	2.8
Wheat	13.4	10.7	1.3	1.9	69.0	1.9	1.8
Rye	13.4	10.5	1.0	1.7	69.5	1.9	2.0
Oats	13.0	10.6	0.7	5.4	57.3	10.0	3.0
Barley	14.3	10.2	0.4	2.1	66.0	4.5	2.5
Maize	11.0	9.8	0.6	5.1	70.0	2.0	1.5
Malt Sprouts	10.0	16.6	7.1	2.2	44.1	12.5	7.5
Wheat Bran	13.2	12.1	2.0	3.7	56.0	7.2	5.8
Brewers' Grains	76.2	4.9	0.2	1.7	10.7	5.1	1.2
Brewers' Grains (dried) ...	9.5	19.8	0.8	7.0	42.3	15.9	4.7
Rice Meal	10.3	11.3	1.0	12.0	47.8	8.6	9.0
Oat Straw	14.5	3.5	0.5	2.0	37.0	36.8	5.7
Barley Straw	14.2	3.2	0.3	1.5	39.1	36.0	5.7
Wheat Straw	13.6		3.3	1.3	39.4	37.1	5.3
Pea Straw	13.6		9.0	1.6	33.7	35.5	6.6
Bean Straw	18.4		8.1	1.1	31.0	36.0	5.4
Pasture Grass	76.7	2.9	1.1	0.9	10.9	5.2	2.3
Clover (bloom beginning)	81.0	2.6	0.8	0.7	8.0	5.2	1.6
Clover Hay (medium) ...	16.0	10.5	2.5	2.5	37.2	25.0	6.3
Meadow Hay (best) ...	15.0	10.2	1.8	2.3	39.5	24.0	7.2
Meadow Hay (medium) ...	15.0	8.0	1.2	2.2	42.0	25.4	6.2
Meadow Hay (poor) ...	14.0	6.3	0.5	2.0	41.1	31.0	5.1
Grass Silage (stack) ...	67.0	3.3	1.5	1.5	13.2	9.7	3.8
Clover Silage (stack) ...	67.0	3.3	2.7	2.2	10.5	11.9	2.4
Maize Silage	79.1	1.0	0.7	0.8	11.0	6.0	1.4
Potatoes	75.0	1.2	0.9	0.2	21.0	0.7	1.0
Cabbage	85.7	1.7	0.8	0.7	7.1	2.4	1.6
Carrots	87.0	0.7	0.5	0.2	9.3	1.3	1.0
Mangels (large)	89.0	0.4	0.8	0.1	7.7	1.0	1.0
Mangels (small)	87.0	0.4	0.6	0.1	10.2	0.8	0.9
Swedes	89.3	0.7	0.7	0.2	7.2	1.1	0.8
Turnips	91.5	0.5	0.5	0.2	5.7	0.9	0.7

Digestibility of Foods.—Experiments to determine the digestibility of the different kinds of food, a matter of the greatest importance to stock-owners, have not been carried on to any extent, if at all, in this country, and the author of *The Chemistry of the Farm* remarks that our knowledge concerning the digestion of food by farm animals is derived almost entirely from German investigations. He quotes from the work of Dr. E. Wolff, *Die Ernährung der landwirthschaftlichen Nutzhire*, and as the information is exceedingly valuable it is desirable to give a summary of it here.

The experiments were chiefly conducted, in the first instance, with oxen, cows, sheep and goats, but Dr. Wolff carried on special investigations on the digestive powers of the horse, in comparison with those of the sheep, the same food being supplied to each animal. The general results are shown in the two following tables, which indicate the proportion of each constituent digested out of 100 parts of each kind of food supplied:—

EXPERIMENTS WITH HORSES

Food.	Proportion of each constituent digested for 100 supplied.				
	Total organic matter.	Nitrogenous substance.	Fat.	Soluble carbohydrates.	Fibre.
* Pasture Grass	62	69	13	66	57
Meadow Hay (very good) ...	51	62	20	57	42
Meadow Hay (ordinary) ...	48	57	24	55	36
Red Clover Hay	51	56	29	64	37
Lucerne Hay (very good) ...	58	73	16	70	40
* Oats	68	86	71	74	21
* Beans	87	86	8	93	69
* Maize	91	78	63	94	100

EXPERIMENTS WITH SHEEP

* Pasture Grass	75	73	65	76	80
Meadow Hay (very good) ...	64	65	54	65	63
Meadow Hay (ordinary) ...	59	57	51	62	56
Red Clover Hay	56	56	58	61	49
Lucerne Hay (very good) ...	59	71	41	66	45
* Oats	71	80	83	76	30
* Beans	90	87	84	91	79
* Maize	89	79	85	91	62

* Mean of Several Experiments.

On comparing these figures it is evident that a horse digests meadow grass and hay less perfectly than a sheep does, and the difference between them is apparently as great when the food is young grass as when the

ordinary hay is employed. There is little difference in the proportions of albuminoids assimilated by the two animals, but the divergence becomes considerable when we come to the carbohydrates, fibre, and fat. Of the carbohydrates the horse digests 7 to 10 per cent, of the fibre 21 per cent, and of the fat and waxy matter 25 to 52 per cent less than the sheep. On the whole, the horse digests about 12 per cent less of the total organic matter of grass hay than the sheep. With red clover hay the results with the horse are better. With Lucerne hay of good quality the digestion of the horse is still better, and (save as regards the fat) practically equals that of the sheep.

The smaller digestive power of the horse for vegetable fibre is plainly connected with the fact that it is not, like the sheep, a ruminant animal, and it is thus unprovided with the same means of attacking an insoluble food. In a trial with wheat-straw chaff, the horse digested 22.5 and the sheep 47.6 per cent of the total organic matter.

With the corn the digestion of the horse is apparently quite equal to that of the sheep. No stress must, of course, be laid on the digestion coefficients found for ingredients of the food present in small quantity, as the fat and fibre of beans and the fibre of maize. In French experiments on horses, in which maize or beans were consumed alone without the addition of hay, it was found that with maize 94.5 per cent of the total organic matter and 87.1 per cent of the nitrogenous substance, and with beans 90.4 per cent and 89.3 per cent respectively were digested. Of potatoes 93 per cent, and of carrots 87 per cent of the organic matter were digested by the horse.

A difficulty which attends all experiments of this kind, in which special kinds of foods are given exclusively, is that their digestibility will be necessarily affected more or less when they are mixed with other foods. This is proved by the following facts, recorded by the same authority.

If to a diet of hay and straw, consumed by a ruminant animal, a pure albuminoid, as wheat gluten, be added, the added food is entirely digested without the rate of digestion of the ordinary food being sensibly altered. The same result has been obtained in experiments with pigs fed on potatoes to which variable quantities of meal-flour were afterwards added. The albuminoids of the meal were entirely digested, while the proportion of the potatoes digested remained unchanged.

An addition of oil (olive, poppy, and rape oil) to a diet of hay and straw is also apparently without unfavourable influence on the rate of digestion; indeed, some experiments with small quantities of oil ($\frac{1}{2}$ lb. of oil per day per 1000 lbs. live weight) show an improved digestion of the dry fodder; oil supplied in moderate quantities is itself entirely digested.

An addition of starch or sugar to a diet of hay or straw will, on the

contrary, diminish its digestibility, if the amount added exceeds 10 per cent of the dry fodder. The albuminoids of the food suffer the greatest loss of digestibility under these circumstances. The fibre also suffers in digestibility if the amount of carbohydrate added is considerable. When starch has been added, it is itself completely digested if the ratio of the nitrogenous constituents of the diet is not less than 1 in 8.

These facts are of considerable practical importance. Nitrogenous foods, as oil-cake and bean-meal, may be given with hay and straw chaff without affecting their digestibility, but foods rich in carbohydrates, as potatoes and mangels, cannot be given in greater proportion than 15 per cent of the fodder (both reckoned as dry food) without more or less diminishing the digestibility of the latter. This decrease in digestibility may, however, be counteracted in great measure by supplying with the potatoes or mangels some nitrogenous food. When this is done, the proportions of roots or potatoes may be double that just mentioned without a serious loss of digestibility. Potatoes exercise a greater depressing effect on the digestibility of hay than roots, starch being more potent in this respect than sugar. The cereal grains are rich in starch, but contain also a fair proportion of albuminoids. They may be added to a dry fodder without seriously affecting its digestibility if the ratio of the nitrogenous to the non-nitrogenous constituents of the diet does not fall below 1 in 8.

Common salt is well known to be a useful addition to the food of animals. It is stated to quicken the conversion of starch into sugar by the saliva and pancreatic juice. When sodium salts are deficient in the food, salt supplies the blood with a necessary constituent. Sodium salts are tolerably abundant in mangels and small in quantity in hay; they are absent in potatoes, and generally absent in grain of all kinds.

SYSTEM OF FEEDING

Quantity and Quality.—It is recognized as a principle in feeding animals that the quantity and quality of the food should bear a distinct relation to the purpose for which the animal is intended. With reference to the horse, it is always the case that the immediate object is to preserve the animal's health and condition, so that he may be able to do the largest amount of work without injury. With cattle, sheep, and swine, the attention of the feeder is directed towards the attainment of as much fat and flesh as it is possible to derive from the food with which the animal is supplied. With this system of fattening animals for the purpose of food the horse-owner has absolutely no concern, and the system, therefore, is considerably simplified, as the horse-owner is only required to exercise his

judgment in determining what amount and what quality of food is necessary to keep the animal in the best working condition. In the chapter on stable management the details of ordinary practice are described, and it will be seen that the quantity of food which a horse can advantageously consume varies in proportion to the amount and character of the exertion which the animal has to perform; the materials employed remain the same—for example, oats, hay, wheat, straw, and bran, with occasional small quantities of carrots or turnips, and, at certain seasons, grass. In ordinary work a horse will consume daily, on the average, *three quarters* of oats, with a small quantity of bran, and the addition of what is roughly calculated as a double handful of chaff composed of chopped hay and straw. A truss and a half of hay in the rack per week is a reasonable allowance. The very wide limits which are permissible, and, indeed, advantageous, in regard to quantity may be gathered by reference to the feeding of a brougham horse in the most active part of a London season, during which comparatively short time a number of horses are worked out, as it is called, in spite of the amount of food which they consume, and are disposed of at the end of the time, often in a very feeble condition. A cab horse, again, in constant work in a large town, consumes an amount of provender which varies with the animal's appetite and the opportunities which may be afforded for taking food. Usually the nose-bag is put on every time a journey is ended, and an interval is therefore allowed to the animal for refreshment. Notwithstanding the amount of provender which hard-worked horses will consume, it is evident that the exhausting effects of excessive exertion are not prevented by excessive feeding; but it is, on the other hand, quite certain that horses which are called upon to perform excessive work do better with a practically unlimited allowance of food—by which is meant supplying as much food as the animal is disposed to take—than they do when the quantity is limited.

Food and Work.—While excessive work, even with a liberal dietary, produces more waste in the system than can be compensated by the food which is taken, it is equally true that rest with a liberal dietary would be more injurious than excessive labour, and the typical system with regard to the proportion of food to the amount of work would be one which exactly supplied the amount of nutritive material accurately adjusted to the waste going on in the system. There are no means, however, of calculating this with absolute precision, and the matter is, therefore, necessarily left to experience.

Arrangement of the Diet.—Under ordinary conditions, particularly in small establishments, the arrangement of the horse's dietary is left to the groom or coachman, and so long as the animals are performing the

amount of work required of them, and do not suffer from any particular illnesses that interfere with their work, the owner does not feel called upon to interfere. Nevertheless, it would be advantageous in many cases if an intelligent interest were manifested in the condition of the animals, and it is more than probable that in many cases it would be found desirable to make changes to meet the peculiarities of certain horses. For example, some horses, like some human beings, suffer from bad appetites, or, as the groom would express it, do not eat their rations clean. This fact is ascertained by merely observing that a certain portion of the food supplied is left in the manger, while another portion is probably found lying under the horse's nose. To remedy this condition of things a change of food by the addition of some compound which will add to its flavour will have a very excellent effect. An extra sprinkling of salt will be very grateful to some horses, while others would prefer some spicy additions in the form of turmeric or some one of the advertised foods, which contain different condiments, mixed with meal, and have the advantage of inducing an animal to consume the provender, and at the same time stimulate the digestive powers.

The horse-owner is often puzzled how to arrange a system of feeding for a horse which remains in poor condition notwithstanding the fact that he eats a considerable quantity of food. The story told will commonly be to the effect that the horse eats as much again as any other animal in the stable, and remains a perfect skeleton all the time. Such animals, it may be remarked, are often possessed of a highly nervous temperament and feeble digestion, and considerable difficulty is often experienced in arranging the food to suit their particular case. Sometimes the addition of some new kind of diet will be found very effective—a small proportion of crushed oil-cake (linseed or cotton), malt meal, the wetting of the food when it is put in the manger, or the addition of an extra quantity of bran, will produce good results. In other instances, which are not benefited by this treatment, the addition of a certain proportion of animal food to the daily ration may have the desired effect. Some little care is required in preparing such food, and there may be some difficulty at first in inducing the animal to take it. A plan which has been found to answer is to make fairly strong soup from any coarse pieces of meat, and to pour the liquid, when cold, on to some bran, to make a mash. A small quantity to begin with of this mixture may be placed in the manger and covered with a sprinkling of oats and a little dry bran. Frequently this device is sufficient to induce the animal to take the mixture, of which he shortly becomes extremely fond. If the ration should be refused, however, and left uneaten at the end of an hour, the next thing is to clean the manger entirely and leave

FOOD PLANTS—1

- | | |
|---|--|
| 1. Wheat (<i>Triticum vulgare</i>). | 7. Cock s-Foot (<i>Dactylis glomerata</i>). |
| 2. Oat (<i>Avena sativa</i>). | 8. Hard Fescue (<i>Festuca duriuscula</i>). |
| 3. Barley (<i>Hordeum distichum</i>). | 9. Meadow Fescue (<i>Festuca pratensis</i>). |
| 4. Crested Dog's Tail (<i>Cynosurus cristatus</i>). | 10. Sheep's Fescue (<i>Festuca ovina</i>). |
| 5. Meadow Cat's-Tail or Timothy (<i>Phleum pratense</i>). | 11. Meadow Fox-Tail (<i>Alopecurus pratensis</i>). |
| 6. Smooth Meadow-Grass (<i>Poa pratensis</i>). | 12. Rye-Grass (<i>Lolium perenne</i>). |



FOOD PLANTS I

the animal without food for several hours, and then make some of the mash into small balls and place one after another into its mouth. In this way the creature shortly becomes accustomed to the flavour, and will offer no objection to the compound in future.

GREEN FOOD

The practice of turning horses out to grass during a certain period of the year is adopted with the idea that the animals will be materially benefited thereby. It is affirmed that the succulent herbage is cooling to the system, that the animals' legs and feet are considerably improved by the change of position and diet, and, in short, that the practice is altogether advantageous and free from objection. Experience, however, teaches that the effects of a run of grass very commonly fall short of the owner's anticipations. Everything, indeed, depends upon the circumstances in which the animal is placed, and the provisions which are made for shelter. In addition, the character of the soil and the quality of the herbage will have to be taken into account. In dry seasons, hard ground and scanty herbage are by no means conducive to the improvement of the animal's condition, and certainly the legs and feet are not likely to benefit by the violent exercise in which the animal commonly indulges when first turned into the pasture. Again, animals which have been engaged in hard work and been supplied with large quantities of concentrated food are likely to suffer from the sudden change to a diet containing a very large proportion of water, necessitating the consumption of a large quantity in order to make up for the deficiency of concentrated nutriment. The distention of the stomach and intestines by the amount of food consumed leads to pressure upon the diaphragm, which is injurious to the respiratory organs; and at the time when it was customary to turn hunters out to grass as soon as the season was over, it was not uncommon for a considerable number of the animals to be brought up in the autumn suffering from "broken wind". To get the full benefit from a change of diet from stable food to the meadow grass there should be proper arrangements for the animal's shelter, so placed that he can take advantage of it, should he feel inclined, to escape from wind, sun, or rain; and a moderate allowance of dry food, oats, bran, and hay should always be insisted on. This system has the advantages of giving the animal complete rest and change of position, with the addition of a proportion of succulent diet to the ordinary stable rations, and it is decidedly to be preferred to the haphazard system of turning a horse out to grass for several months and leaving him to take his chance.

METHODS OF CALCULATING THE NUTRITIVE VALUE OF
DIFFERENT ARTICLES OF DIET

For ordinary purposes the horse-owner will be content to refer to what has already been stated for the purpose of deciding what article of diet will be most useful and economical, but the German and French investigators have not been content with this general knowledge, and we are indebted to them for a number of interesting and important experiments, the outcome of which is to enable the curious in such matters to calculate with almost mathematical accuracy the exact relation which the food bears to its digestibility and to the waste of the system.

It appears that the power of assimilation in different animals varies very considerably in reference to the various constituents of food; thus a horse will digest, out of every 100 parts of mixed diet, 69 parts of albuminoids, 59 of fatty matters, 68 of the carbohydrates (starch, sugar, and gum), and 33 of cellulose and fibre. The annexed table will show the difference in these respects of the digestive powers of the ox, cow, and sheep:—

	Horse.	Ox.	Cow.	Sheep.
Albuminoids ...	69	65	57	57
Fatty Matters ...	59	64	65	61
Carbohydrates ...	68	66	70	73
Cellulose and Fibre	33	60	61	58

A further analysis indicates that the above proximate principles are differently digested in different articles of food, as shown by the table on p. 97, which relates to the digestibility of the proximate principles of different kinds of food by horses.

Various circumstances appear to modify the digestibility of different articles of diet. Age and mode of growth and preparation are among the modifying influences. Young plants are more digestible than mature ones, and the digestibility of old hay is less than that of new. It is also stated by the authorities which have been referred to that the digestibility of food is not affected by the amount which the animal consumes, neither is it altered by the amount of labour which the animal performs. According to Wolff, however, the addition of one food will alter the digestibility of another. Thus starch or sugar added to a diet of hay or straw in a larger amount than 10 per cent lessens its digestibility, especially in regard to the albuminoids which the food contains.

DIGESTIBILITY OF FOOD-STUFFS, SHOWING THE PROPORTION DIGESTED FOR
100 SUPPLIED

Food.	Animal.	Total Organic Matter.	Proteids.	Cellulose.	Fat.	Carbo-hydrates.
Green Grass	Horse	51	59	41	20	59
	Ox	77	75	75	66	78
	Sheep	62	60	61	52	66
Hay	Horse	48	57	36	24	55
	Ox	60	57	58	19	62
	Sheep	59	57	56	51	62
Clover Hay	Horse	51	56	37	29	64
	Ox	57	55	45	51	65
	Sheep	56	56	50	56	61
Lucerne	Horse	58	73	40	14	70
	Ox	62	78	42	33	70
	Sheep	59	71	45	41	66
Wheat Straw	Horse	23	19	27	...	18
	Ox	46	17	56	36	39
	Sheep	48	...	59	44	37
Oats	Horse	67	79	20	70	74
	Ox	70	78	20	83	76
	Sheep	71	80	30	83	76
Barley	Horse	87	80	100	42	87
	Ox	86	70	50	89	92
	Horse	89	77	70	61	94
Maize	Ox	91	72	77	85	94
	Sheep	89	79	62	85	91
	Horse	87	86	65	13	93
Beans	Ox	89	88	72	86	93
	Sheep	90	87	79	84	91

Oil in small quantities appears to increase the digestibility of hay and straw, but a large amount causes loss of appetite. Potatoes, owing to the amount of starch they contain, prevent the digestion of hay. Roots have a less depressing effect, owing to the sugar which they contain.

Col. Smith remarks that in some of his own experiments the addition of 2 lb. of oats to 12 lb. of hay increased its digestibility by more than 9 per cent. He adds that, in calculating a diet to ascertain its suitability for an animal, it is necessary to obtain from the tables given a proportion of principles digested, and then to find out the nitrogenous, fatty, and complete nutritive ratios. In illustration of this method of calculation, it is assumed that a horse receives as a daily ration 12 lb. of hay of medium quality and 10 lb. of oats. It is required to know the ratio of this diet before and after digestion, and the proportion of proximate principles digested.

This information is conveyed in the following table, referring to the constituents of hay and oats. It will be seen that the fat in the hay is

imperfectly digested, the fatty ratio falling from 1:4:1 to 1:12 after digestion. Otherwise the nutritive value of the food is raised, as the cellulose is excluded from the calculation.

Hay: Analysis Per Cent.	12 lb. Hay contains	Digestive Co-efficient.	Amount Digested.
	lb.		lb.
Water 14.3	1.70
Albuminoids ... 8.2	.98	58	.568
Fat 2.0	.24	19	.045
Carbohydrates ... 41.3	4.95	52	2.574
Cellulose 30.0	3.60	37	1.33
Nitrogenous Ratio, 1:5:3	Nitrogenous Ratio, 1: 4:6
Fatty .. 1:4:1	Fatty .. 1:12
Complete .. 1:9	Complete .. 1: 7

Oats: Analysis Per Cent.	10 lb. Oats contains	Digestive Co-efficient.	Amount Digested.
	lb.		lb.
Water 14.7	1.47
Albuminoids ... 12.0	1.20	87	1.04
Fat 6.0	.60	78	.468
Carbohydrates ... 56.6	5.66	76	4.30
Cellulose 9.0	.90	25	.22
Nitrogenous Ratio, 1:5:2	Nitrogenous Ratio, 1: 4:5
Fatty .. 1:2	Fatty .. 1:2:2
Complete .. 1:6	Complete .. 1:4:7

In the above table it is clearly demonstrated that only a certain amount of the digestible matter is appropriated by the animal's system; thus the total diet contained: albuminoids 2.18 lb., fats .84 lb., carbohydrates 10.61 lb., cellulose 4.50 lb.; while the system of the horse only appropriated: albuminoids 1.6 lb., fat .5 lb., carbohydrates 6.9 lb., and cellulose 1.5 lb. In other words, only 10.5 lb. out of the total of 18.13 lb. was assimilated.

Comparing the feeding values of different foods, the method of establishing a nutritive equivalent is adopted. Taking one typical food as represented by 100, every food containing the same amount of nitrogen as the typical food is considered to be equal to it, *i.e.* 100. A food, however, which contains twice the amount of nitrogen would have for its nutritive equivalent 50, because half the amount would be equal to the typical food; but if it possessed half the amount of nitrogen, its equivalent would be 200, as it would take twice as much food to contain the amount of the typical food.

Hay is taken as the standard of comparison, and the following table by Boussingault gives the relative values of the different articles of food in comparison with hay:—

Hay	100	Barley	48
Lucerne Hay	90	Maize	45
Trefoil	95	Bran	60 to 150
Lucerne Green	420	Linseed	30
Trefoil Green	420	Linseed Cake	25
Oat Straw	280	Peas	40
Barley Straw	350	Beans	40
Oats	60	Carrots	290
Wheat	45		

In reading the table, the numbers must be taken to indicate the number of parts of each article which will represent the 100 parts of hay, *i.e.* 45 parts of wheat, 30 of linseed, 350 of barley straw, and so forth, are equivalent to 100 parts of hay. However interesting this information may be, its true value can only be realized by taking it in connection with the fact that the animal's temperament and digestive capacity have a dominant concern in the appropriation of the different articles of diet. It is quite conceivable that the table might be found absolutely correct for a certain number of horses, while in an equal or possibly greater number of animals of different constitution, and under different circumstances, the nutritive equivalents given would have to be considerably modified.

All the elaborate experiments which have been performed by a large number of investigators have been mainly directed to the important object of discovering the influence of different foods in producing heat and force, or working power. The amount of heat evolved from the oxidation of certain foods is readily converted into its equivalent of mechanical energy. It was found by Frankland that when a dried food mixed with a powerful oxidizing substance, such as chlorate of potash, was placed in an apparatus surrounded with water, and burned, the heat developed raised the temperature of the water. 1 gramme (15·432 grains) when raised 1° C. (1·8° Fahr.) is called a heat unit. 1 lb. of albumen when oxidized raises the temperature of 4263 lb. of water 1° (Fahr.), while 1 lb. of fat raises the temperature of 9069 lb. of water to the same extent (1·8° Fahr.). Joule of Manchester demonstrated that the heat required to raise the temperature of 1 lb. of water 1° (Fahr.) was equivalent to the power required to raise the weight of 1 lb. 772 feet high. The foot-pound is, therefore, the unit of work, and 772 ft.-pounds is the mechanical equivalent of 1° (Fahr.). Knowing the number of heat units each substance is capable of producing, its potential or mechanical value may be calculated; and the author of *Veterinary Hygiene* suggests that the most simple way of doing this is to multiply

the actual amount of food digested by certain numbers which represent the comparative heat-forming value of fat, albumen, and starch.

The co-efficients are: fat 100, albumen 47·4, starch 43·1; and he gives the following example in answer to the question: "What is the comparative heat-forming value of the following foods?"

1ST FOOD			
Albuminoids	568 × 47·4 = 27
Fats	·045 × 100 = 4·5
Carbohydrates	2·574 } × 43·1 = 168·2
Cellulose	1·330 }
			<u>199·7</u>
2ND FOOD			
Albuminoids	1·04 × 47·4 = 49·3
Fats	·468 × 100 = 46·8
Carbohydrates	4·30 } × 43·1 = 194·8
Cellulose	·22 }
			<u>290·9</u>

This second food is obviously about one and a half times as heat-producing and work-producing as the first food; the two foods together represent the typical average food of a horse, the first being equivalent to the 12 lb. of hay, the second to the 10 lb. of oats. To find out the number of foot-tons produced by this diet, it is necessary to go back to Frankland's table, and, having found the number of heat units for the article of diet in question in albumen, fat, starch, or sugar, deduct four-fifths, as not more than one-fifth of the whole potential energy of the food will be converted into work. Thus the typical diet of 12 lb. of hay and 10 lb. of oats will have their potential and actual energy expressed as follows:—

12 lb. of Hay,	Lb.	Ft.-tons of Potential Energy.	
Albuminoids	...	568 = 1,572	}
Fats	...	·045 = 272	
Carbohydrates	...	2·574 } = 8,620	
Cellulose	...	1·330 }	
		<u>10,464</u>	Deducting four-fifths from the total potential energy leaves 2093 foot-tons for external work.
10 lb. of Oats,	Lb.	Ft.-tons of Potential Energy.	
Albuminoids	...	1·04 = 2,879	}
Fats	...	·468 = 2,830	
Carbohydrates	...	4·30 } = 9,980	
Cellulose	...	·22 }	
		<u>15,689</u>	Deducting four-fifths from the total potential energy leaves 3138 foot-tons for external work.

Colonel Fred. Smith states that from some careful experiments of his own he found that horses might be kept in perfect health without loss of body weight on 12 lb. of hay per diem, of which not more than about one-half was digested and assimilated by the system. Assuming that nearly 5 lb. of assimilated food possesses the same digestive co-efficients as those of the 12 lb. of hay given in the table marked "First Food", the horses received:

	Lb.	
Albuminoids	656	}
Fat	100	
Carbohydrates	2574	
Cellulose	1330	
Salt	150	
	4810	The potential energy being equal to 11,041 foot-tons.

Presumably the animal referred to as having been kept in health without loss of weight on 12 lb. per day did very little, if any, work, but the writer does not give any information on this point. He, however, remarks that it is difficult to fix the number of foot-tons of daily work which can be performed by a horse without loss of condition and weight, but he adds there are many circumstances which lead him to believe that 3000 foot-tons per day is the quantity.

FOOD AS A CAUSE OF DISEASE

Very little reflection is required to make it perfectly evident that good food of unexceptionable quality and free from any contamination with objectionable substances may, nevertheless, induce disease, as the consequence of variations in quantity and character.

Dr. Parkes remarks that so great is the influence of food on health that the diseases connected with food are probably the most numerous of any which proceed from a single class of causes.

Excess of Food.—When more food is introduced into the stomach than can be readily digested, the ordinary action of the gastric fluids is checked, and chemical changes, including fermentation, advancing to putrefaction, result. This final change is more likely to occur among flesh-feeding animals than among those which live on grain or herbage. A vegetable food is also of course capable of undergoing decomposition and producing considerable derangement in the alimentary canal. In cases where any of the products of decomposition are absorbed into the blood, signs of blood-poisoning may result, with a possibility of a fatal termination. Short of this, however, excess of food may only produce more

or less serious indigestion, ending in recovery under appropriate treatment. But the habitual consumption of excessive quantities of food, by horses which are thrown out of work without having the quantity of diet materially reduced, will result in the deposit of large quantities of fat in and upon various organs of the body, some of it on the surface of the heart, in the cellular structure of the liver, and in other organs. In the first instance fatty material may be merely laid up as a deposit in the texture of an organ, or the cells and fibres composing it may undergo complete degeneration, by which its natural structure is converted into particles of fat.

Insufficient food, on the other hand, produces extreme debility, and predisposes an animal to many diseases.

If the deficiency is chiefly in regard to nitrogenous materials, the muscular structures suffer most, and fatal results may follow. This is especially the case when a horse is compelled, notwithstanding the insufficiency of food, to continue its ordinary work.

Quality of food has also a considerable influence on nutrition, and foods grown on certain soils are known to be extremely poor in this respect. Where food of inferior quality is supplied on the assumption that it is of good quality, the nutrition of the body will fail to be sustained, and wasting results. On certain soils the herbage produced, and even the hay made from it, exercise an injurious influence on the animals which partake of it; at the same time it may not be possible to decide what changes have occurred to render the food deleterious. The scouring lands of central Somerset are a case in point, and although investigations have been made repeatedly, including analyses of the soil, herbage, and water, the cause of the disease which attacks animals feeding on the pastures has never yet been accurately determined.

There are many cases in which there is no doubt at all of the fact that weakness results from a diseased condition of the food. It is generally understood that plants suffer from a large number of diseases, many of them being easily recognized, but there is every reason to believe that there are others the exact nature of which has not been determined.

Among the diseases which are known, those depending upon animal or vegetable parasites are most marked in their character. Plants are attacked by numerous fungi or moulds, which are not only injurious to the plant, but in many cases to the animals which partake of them. Mouldy hay, for example, produces derangement of the digestive organs. Ergotized grain, taken in large quantities, has an extraordinary action upon the animals which consume it, including nervous derangement, associated with mortification of the lower extremities, and occasionally

sloughing of the extremities about the region of the fetlocks. A curious fungus, which is known as actinomyces, or rayed fungus (fig. 477), attacks certain grains and grasses, especially in river valleys, which, on being consumed, sets up centres of disease in different parts of the animals which feed on the infested plants. Sometimes it gets an entrance to the alveolar cavities by the side of a loose or decayed tooth, penetrating into the sinuses of the head and the cellular structure of the bones, causing enormous swellings, giving rise to the disease which is known in America as "Lumpy jaw". In other situations it causes large tumours in the neighbourhood of the throat, in the stomach, and also in the intestines.

Besides the vegetable parasitic fungi which attack food plants there are numerous animal parasites, and animals supplied with food so attacked suffer in various ways; in the first place from the damage done to the fodder by the ravages of the parasites, and in the second place from the direct attack of the parasites themselves, some of which produce irritation of the skin. An unfortunate circumstance connected with the effects of damaged food invaded by animal or vegetable parasites is the difficulty of connecting the disease of the animal with the disease of the plant. The tendency undoubtedly is to exonerate the food from suspicion, even to ignore it altogether as a possible cause of disease, until a considerable fatality has forced the owner to conclude that some

common cause must be at work to produce it, and even then it frequently occurs that the investigation which is made is directed into the wrong channel by the history of the case which is presented to the investigator, who is very likely to be informed that exactly the same articles of food have been, and are still being, supplied to other animals on the same premises, which have not suffered in consequence. This is a source of error which is particularly likely to occur when the food which is suspected is some kind of cake. It is quite possible that a cake contaminated with mould may be part of a lot which was supplied at the same time as the cake on which other animals are feeding with impunity, and that the animals which are poisoned are the only ones which have eaten the fungus-infected food. The investigator, therefore, should not be satisfied until

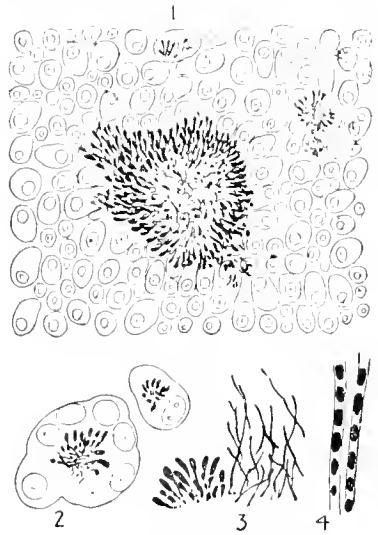

Fig. 477.—*Actinomyces Bovis*

1, The fungus on cow's tongue; 2, Cell or group of cells with actinomyces; 3, Clubbed filaments and centre filaments of the fungus; 4, Filaments from the centre enlarged.

he has made an exhaustive enquiry into the origin and quality of the food which has been supplied, and the particular animals which have suffered in consequence.

Some plants have distinctly poisonous qualities, *e.g.* the yew, horse-chestnuts, the *Colchicum autumnale*, acorns, and potatoes in the raw state (see "Poisoning").

It is a curious circumstance that some of these poisonous plants may be eaten for a considerable time with perfect impunity. The yew, for example, only manifests its poisonous quality on certain occasions, and the same thing is true of potatoes, the poison of which seems to lie chiefly in the skin, and horses which have consumed large quantities of them uncooked have died rapidly with symptoms of poisoning. Potatoes, or potato skins, however, appear to be perfectly harmless when boiled. Some foods become injurious in consequence of defective modes of preparation; for example, hay which has been highly dried or burnt in the making. Foxy oats, so called on account of the red colour which they assume as the result of having been exposed to moisture and subsequently dried in kilns, assume a decidedly poisonous character, acting chiefly on the kidneys. Numerous cases of the poisoning of cattle have been traced to the consumption of large quantities of frozen turnips.

Of the rapidly poisonous action of the yew under certain circumstances there is no doubt. Many instances have occurred where yew clippings have been thrown over a fence, and a considerable number of animals which had partaken of it have been found dead, or seen to be in a dying state, with the symptoms of narcotic poisoning. Yet horses have been known to graze for years in pastures the hedges of which were mainly composed of yew, and nothing has happened; when suddenly the introduction of one or two strange animals has been followed by the death of them from eating a small quantity of yew.

Perhaps in the majority of cases the animals which remain unaffected in the pastures do not eat the yew at all, and it is certainly the case that in experiments which have been made, some of them lately, the greatest difficulty has been met with in persuading the horses to eat the yew which was supplied to them, and it was always necessary to keep them without other food for a considerable time. In some experiments which were performed a few years ago a sheep, after being kept without food for two or three days, ate, in the course of twenty-four hours, 14 oz. of the dried leaves of the yew, and two days later it ate 6 oz., yet no effect was observed. A yearling heifer ate in twenty-four hours 2 lb. 6 oz. of half-dried leaves and twigs without effect. Three calves, about seven months old, consumed in two hours 3 lb. 6 oz. of half-dried leaves and

twigs without effect. Three days later the same calves ate 10 oz. in two hours, and two days afterwards one of the calves was noticed to be ill, and in half an hour it died. A donkey ate in twenty-four hours $5\frac{1}{2}$ oz. of half-dried leaves without effect, and two guinea-pigs consumed $1\frac{1}{2}$ oz. of dried leaves in seventy-two hours without suffering any inconvenience. In another instance experiments were tried with the yew leaves, some of which had been eaten by a valuable filly on the first night of entering the pasture, and which was found dead on the following morning. Some of the leaves from the plant of which the filly partook were given to three guinea-pigs, mixed with bran and oats. Ten days afterwards, the feeding being continued during the whole time, one of the guinea-pigs died. On the following day a second one died, and four days after, the third guinea-pig died. On post-mortem examination it was found that the stomach in each case was perfectly empty, the lining membrane of the intestines much congested, and the tube was filled with well-digested leaves of yew. Two sheep and a horse were huddled on the same pasture and supplied with the yew leaves, but they steadily refused to touch them. The horse was subsequently placed in his stable and a quantity of yew leaves, finely chopped, were mixed with the ordinary food and placed in the animal's manger, where it remained for the whole of the day without being eaten. On the following morning, however, the animal was found dead, and its manger was empty. It would appear in this case that the particular plant, the eating of which led to the death of the valuable filly, did possess actively poisonous qualities, at least for horses and guinea-pigs. The sheep which were made the subject of the experiment escaped by refusing to eat the plant.

Acorns are well known to be a useful article of diet under ordinary circumstances, and in places where they are abundant. On common lands they are carefully collected and sold by the collectors as food for horses, cattle, and sheep. Pigs thrive upon them, and the passage rights in forests where oak-trees are abundant are valued on account of the opportunities which the owners of pigs have to turn them into the forest when the acorns are falling. Sheep and cattle also take acorns freely, usually, if not invariably, when mixed with other food; but several serious outbreaks of acorn poisoning from time to time have occurred, attended with fatal results, when, owing to a long drought, the herbage has been extremely scanty, and the animals have, therefore, been induced to live on the acorns almost exclusively. The disease from which the cattle have suffered is not in any way due to the indigestible character of the food. Occasionally, in seasons when acorns are very

abundant, cattle and sheep, and even pigs, have suffered from a too free indulgence of a favourite food, and some of the animals have died from the impactment of quantities of the nuts in different parts of the digestive system; but this is not what is intended by the term acorn poisoning. On the contrary, in the true disease the most marked symptoms are not present until a considerable time after the acorns have been digested, and no trace of them is to be found on post-mortem examination. Of course this fact might be interpreted to mean that the animals have not died from the consumption of acorns, but the evidence is too clear to admit of any question.

In 1868, when the malady was first recognized, a large herd of cattle, which were feeding in a park where acorns were very abundant and pasture very scanty, became affected, while other cattle on the same estate, separated from the diseased ones only by an iron fence, which shut them off from the acorns, remained perfectly well. The symptoms were not at all violent in their character. In the first instance, after a week or ten days' feeding on the acorns, instead of improving in condition, the animals began to waste, and presented a remarkably listless and dull appearance. The appetite in the worst cases was entirely lost, and it was remarked that when the disease got to that stage the animal never recovered, but lingered on for some time, and was ultimately found dead on the pasture.

Careful analyses were made, but no special organic poison was discovered—nothing, in short, which could be suggested as a possible cause of injury except tannic and gallic acids. It may be observed in this connection that the detection of an organic poison is extremely difficult; in fact, the failure of discovery is by no means evidence that it does not exist. Since 1868 several similar outbreaks have occurred, usually under the same conditions, *i.e.* a hot, dry summer, deficiency of grass, and the prevalence of high winds in the autumn, causing the fall of a quantity of acorns before they are perfectly ripe. On the other hand, these climatic influences have prevailed in many years when no outbreak of acorn-poisoning has occurred.

SELECTION AND PREPARATION OF FOOD

Generally the horse-owner is content to leave the selection and preparation of the horses' food to his coachman or groom, leaving them to arrange with the dealers as to the quality of the oats, hay, and other articles of fodder which will be supplied.

This system has the advantage of saving a good deal of trouble, and in small establishments it would not be possible to appoint a responsible

person to examine samples of provender before the purchase is made, and to see that the bulk corresponds with the sample. But the owner would very often find it economical, as well as advantageous to his animals, to examine the samples himself, and to see from time to time if the quality is maintained. It is true that this presupposes a certain amount of knowledge which the owner may not possess, but it is certain, on the other hand, that a good many who do possess the necessary knowledge do not take the trouble to apply it to a useful purpose.

The ordinary articles of food of the horse are oats, bran, and hay, straw being employed only in admixture with the hay to form chaff. Oats are placed first, as the most important, and there is no article of provender which differs more in quality. Between the best and the worst it is not difficult for even a tyro to distinguish. Anyone can recognize bright, plump grains, having a sweet odour, containing no shrunken or broken grains, free from dust and other foreign matter, firm to the touch and also to the pressure of the teeth, and weighing not less than 40 lb. a bushel. It is also an important character of a good sample of oats that the grain must vary very little in size. In judging a sample, the observer has to note particularly that the oats have not been artificially dried by heat after they have become damaged by water. Dark-coloured oats, and those which have a peculiar odour, are always open to suspicion. At the present time, however, the methods of preparation to disguise the colour, as well as the taste and smell, of kiln-dried oats are so skilfully applied that damaged oats may very frequently pass muster, unless the observer has the skill which is only to be acquired by practice.

In some private stables it is customary to give a feed of oats entirely unmixed; but there are certain disadvantages attending this procedure. Horses are disposed to swallow rapidly or bolt oats which are given alone, and the quantity ordinarily given would be insufficient in itself to satisfy the appetite of a hungry animal. A similar quantity, $\frac{1}{4}$ peck of good chaff and a handful or two of bran, combined with the feed of oats, will force the animal to masticate the mixture and avoid waste. Crushing oats is undoubtedly a useful mode of preparation, and certainly facilitates digestion, and especially in the case of ravenous feeders which "bolt" their food without sufficient mastication.

Although oats constitute the staple food of a horse, other grains are occasionally given. Barley is very rarely employed as food for horses, and it is admitted, by those who are disposed to favour its use in mixture with other food, that it should be boiled previously to being given. Brewers' grains are also occasionally used for horse food in moderate quantities. They are the refuse of malted barley left after the brewing of beer.

Grains and malt sprouts—the latter containing nearly six times more nitrogenous matter than exists in the grains themselves—are exceedingly useful for horses when given in small quantities mixed with other food. They constitute a grateful change and stimulate the appetite of delicate feeders; and as they contain a considerable quantity of carbohydrates, besides some fatty matter, they are likely to prove beneficial to horses in poor condition, whether in consequence of excessive work or from an attack of a debilitating disease. Dried grains have recently come into use, and they, as a matter of course, having got rid of a large proportion of the water, of which between 70 and 80 per cent exists in the grain, may be looked upon as a somewhat concentrated food.

Maize.—When first introduced into this country it was used somewhat extensively by omnibus companies and in other large horse establishments, on account of its low price in comparison with that of oats, for which it was substituted. By the Paris Omnibus Company it is reported to have been found to be equal in digestibility to an equivalent quantity of oats. Experiments made in the army, as recorded by Colonel F. Smith, were not altogether favourable, as it appeared that in whatever proportion it was substituted for oats, there was a diminution in muscle and energy. Five thousand two hundred army horses were fed, in Austria, partly on maize for six months, and it is stated that, although they improved as regards their coats, they lost energy and sweated profusely at work. It is said to be largely used in America and South Africa for feeding purposes, and it does not appear that in those countries the objections which have been raised to its use as a substitute for oats exist, at least they have not been mentioned.

Maize contains less nitrogenous matter than oats, but it is extremely rich in fat and also in salts. It is difficult to masticate on account of its extreme hardness, and it is, therefore, absolutely essential that it should be submitted to some sort of preparation before being used, even if it is intended to be mixed with other food. The difficulty of mastication is, to some extent, disposed of by crushing. This process is certainly indispensable. Without it it is hardly possible that maize could be digested, even by ruminating animals. An opportunity occurred lately of noting the condition of this grain in the digestive organs of some deer, which were fed on mixed food in addition to the grass which they consumed. The mixture consisted of chaff, with chopped roots and maize uncrushed. A considerable number of the animals died during the season, after wasting. There was no reason, however, to suspect that they had suffered from indigestion; in fact, it was ascertained that they died from parasitic disease; but it was noticed that the maize, even in the fourth stomach, had escaped the action of the

digestive fluid, as well as the action of the teeth, and remained as perfectly intact as though it had been brought from the store, instead of being taken from the stomach. In fact, a portion of it, after being washed and dried, presented quite the ordinary appearance. The test may be taken as a crucial one, as the grain had been macerated in the first compartment of the deer's stomach, re-masticated during the process of rumination, passed through two other compartments of the stomach, and finally, in the fourth compartment, had been subjected to the action of the gastric juice.

Wheat appears to be a favourite article of diet with horses, and it is stated that they will, if allowed, gorge themselves with it, with serious consequences. Colic, tympany, and other ailments are the result of taking too large quantities. It has also been accused of being the cause of laminitis, or fever in the feet of the horse. Recently experiments by Dr. Voeleker have shown that, at its present price, it may be used with economy for feeding sheep.

Bran is constantly used in horse provender in mixture with oats and chaff. It is extremely rich in nitrogenous matter, and contains also a considerable quantity of carbohydrates and fatty matter. Formerly it was used as a food for horses in some parts of the country much more extensively than it is at present. It is stated that, as an exclusive food for horses, it is absolutely useless; but the writer remembers one establishment where all the cart-horses were fed upon bran alone, of course in unlimited quantity. The animals were all of them fat, and had remarkably glossy coats. Whether or not they would have borne an average amount of work cannot be stated, as the owner of the horses was a conspicuous member of the Society for Prevention of Cruelty to Animals, and took great pride in treating his horses with the greatest consideration. They were never consequently called upon to do any hard work, but of the fact that they lived exclusively upon bran and looked remarkably well there is no doubt.

For practical purposes, bran can only be used with advantage to a limited extent in mixture with other food, as has already been pointed out. It is largely used in the sick stable in the form of mash, which is made by pouring over it a small quantity of boiling water, and allowing it to remain until it is cool. It is also the custom in many stables to give horses a bran mash once or twice a week, and the practice has very much to recommend it. It has already been suggested that a handful or two mixed with the regular rations has the effect of inducing an animal to masticate the whole of the food with which it is mixed, and is, therefore, particularly desirable as an adjunct to the rations of the horses which are known as gross feeders. If the digestive organs of grain- and herb-feeding

animals were adapted for the digestion of bran, it would be a most valuable article of diet for horses, as the following table will indicate:—

ANALYSIS OF BRAN.

	Payen.	Millon.	Kühn.	Grandeau.	Warrington.	Wolff.
Water	13.90	13.90	13.40	12.80	14.0	13.6
Nitrogenous matter ...	18.77	14.90	14.00	13.82	14.2	13.6
Fatty matter	4.00	3.60	3.80	3.59	4.2	3.4
Carbohydrates	48.26	51.00	45.00	55.91	50.4	54.9
Cellulose	8.78	10.49	18.30	8.65	11.1	8.9
Salts	6.29	5.70	6.19	5.23	6.1	5.6

It will be seen that the results of analyses by different authorities are given, showing certain variations in the amount of nitrogenous matter, cellulose, and carbohydrates, but they all agree sufficiently to show that bran, chemically speaking, contains all the requisites for nutrition. The nitrogenous ratio varies from 1 : 2.8 to 1 : 4.3. Among the total salts are represented potash, soda, magnesia, lime, phosphoric acid, and silica.

Hay.—Although the term hay has a general signification as being grass which has undergone the process of drying, it really includes several varieties of fodder which have different degrees of feeding value.

The best hay, it is allowed, is that which is grown in the uplands. There is, besides, the ordinary meadow hay, and the hay from water meadows, and there is also hay which is made from various artificial grasses, such as the different varieties of clovers, vetches, lucerne, and sainfoin, all of which have a highly nutritive value.

Different specimens of hay vary considerably in their nutritive value, according to the character of the soil in which the crop is grown, the time of mowing, and the care which is taken in making it. It is hardly necessary to add that a very great deal depends upon the state of the weather during haymaking time. Hay of good quality should not be less than one year old, should retain some of its greenish tint and be perfectly sweet in smell. The slightest trace of mouldy odour should lead to its rejection. Burned hay has a dark colour, powerful odour, and pungent taste, rather suggestive of tobacco, and, as a rule, horses, unless forced by hunger, object to eat it. It is said, however, that some horses will eat burned hay, when it is not too much damaged, with avidity, for a time, and after a while reject it. It is, however, always injurious to the animals which partake of it for any length of time, causing excessive thirst and serious loss of

condition. The following table shows the constituents of hay according to the different authorities named:—

	Boussingault.	Sanson.	Grandjean.	Garola.	Wolff.	Voelcker.	American Farming.		
							Full Bloom.	After Bloom.	Before Bloom.
Albuminoids ...	7.20	8.50	10.11	8.40	9.5	9.88	8.63	9.44	11.63
Carbohydrates ...	44.20	38.30	40.90	41.00	41.7	48.09	36.11	41.40	36.01
Lignin and Cellulose	24.20	29.30	25.52	26.80	28.7	31.80	31.21	24.18	20.10
Fat ...	3.80	3.00	2.34	2.90	2.6	2.99	4.22	4.55	4.31
Salts ...	7.60	6.02	6.54	6.70	5.8	7.24	4.66	6.19	5.30
Water ...	13.00	14.30	14.59	14.20	14.3	14.30	7.45	7.13	7.79

Hay which is made from artificial grasses may be looked upon as an altogether more concentrated food than any kind of meadow hay, as the following table will indicate:—

	Red Clover, full bloom.	White Clover in bloom.	Crimson Clover.	Hop Trefoil.	Lucerne just in bloom.	Samfom just in bloom.	Vetches in bloom.	Furze.
Water ...	80.4	80.5	81.5	80.0	71.0	81.4	82.0	48.7
Proteids ...	3.0	3.5	2.7	3.5	4.5	4.2	3.5	5.3
Carbohydrates ...	8.9	7.2	7.3	8.2	9.2	7.3	6.6	16.1
Fat ...	0.6	0.8	0.7	0.8	0.8	0.7	0.6	1.1
Cellulose ...	5.2	6.0	6.2	6.0	9.5	5.2	5.5	24.0
Salts ...	1.3	2.0	1.6	1.5	2.0	1.2	1.8	2.8

	Red Clover Hay.	White Clover.	Swedish Clover.	Italian Clover.	Yellow Clover.	Vetches.	Lucerne.	Samfom.
Water ...	16.7	16.7	16.7	16.7	16.7	16.7	16.7	14.2
Albuminoids ...	13.4	14.9	15.3	12.2	14.6	14.2	19.7	14.8
Carbohydrates ...	29.9	34.3	29.2	30.1	36.5	35.3	32.9	35.7
Fat ...	3.2	3.5	3.3	3.0	3.3	2.5	3.3	3.3
Cellulose ...	35.8	25.6	30.5	33.8	26.2	25.5	22.0	26.4
Salts ...	6.2	8.5	8.3	7.2	6.0	8.3	8.7	6.2

The second table shows the composition of hay made from various artificial grasses; the high proportion of albuminoids brings their nutritive value nearly up to that of oats. All the artificial kinds of hay, therefore, require care in their use. Various disturbances of the digestive system are

attributed to excessive indulgence in them. In its ordinary use as fodder, hay is given both long and chaffed. It has already been stated that hay, when used as chaff, is mixed with sweet straw, as a rule, but chaff of good quality should have at least a double proportion of hay to straw, and hay is sometimes passed through the chaff machine and used alone.

Long hay is placed in the rack which is generally above the horse's head, and it may be looked upon as absolutely essential for animals which stand much in the stable, not only on account of its nutritive value, but for the further reason that it gives them a certain amount of occupation during a portion of the day which, in the absence of the rack food, the animal would probably occupy in consuming the bedding.

Straw.—For the purpose of feeding cattle, straw may be looked upon as a staple article of diet. It is also eaten in considerable quantities by horses which are turned into the straw-yard, and also by others in the stables, where they occupy some of their idle time in eating the straw which is used for litter. Indeed, it is often found necessary to apply the muzzle in order to prevent the indulgence of this somewhat dangerous habit. The principal and most profitable use of straw is when it is converted into chaff along with hay; there is no doubt that it very much assists in the preparation of food by compelling the animal to masticate it thoroughly. The following table shows the composition of different kinds of straw, of which wheat and oat straw are considered the best as food for horses:—

	Wheat.	Oat.	Pea.	Bean.
Water	13.55	13.63	14.28	17.28
Proteids	3.03	4.55	7.56	12.01
Fat	1.10	1.64	2.17	1.31
Carbohydrates	40.90	36.95	29.39	31.80
Cellulose	37.48	37.97	42.47	30.67
Salts	3.94	5.26	4.13	6.39

It may be remarked here that barley straw is generally considered to be very indigestible, and quite unfit for food for horses.

Pea and bean straw may be placed in the same category. It is true that they contain a large quantity of nitrogenous matter, and according to the analyses they would be estimated as possessing a high feeding value, but they contain a large quantity of woody fibre, which renders them indigestible, and, excepting in emergencies, they should be excluded from the diet of the horse.

Peas, beans, and lentils are very useful articles of food of the concentrated order, containing a very large proportion of nitrogenous



FOOD PLANTS II

- | | |
|---|-------------------------------------|
| 1. Green Pea (<i>Pisum sativum</i>) | 4. Broad Bean (<i>Vicia faba</i>) |
| 2. Green Pea (<i>Pisum sativum</i>) | 5. Bean Pod (closed) |
| 3. Chick Pea (<i>Cicer arietinum</i>) | 6. Bean Pod (open) |

matter. The following tables show the constituents of peas, lentils, vetches, and beans from the analyses made by different authorities:—

	Peas.	Gram.
Water ...	14.4	10.80
Proteids ...	22.6	19.32
Fat ...	1.9	4.56
Carbohydrates ...	53.0	62.20
Cellulose ...	5.4	
Salts ...	2.7	3.12

	Pigeon Pea.	Common Pea.	Lentils.	Vetches.
Water ...	10.77	12.70	12.70	10.10
Nitrogenous matter ...	20.19	25.20	24.57	31.50
Fatty matter ...	1.32	1.10	1.01	.95
Carbohydrates ...	64.32	58.38	59.43	54.26
Salts ...	3.40	2.53	2.29	3.19

	Beans.	Bhoot.	Oorad.	Moong.	Mote.	Cooltee.
Water ...	14.4	8.12	11.0	9.20	11.22	11.30
Proteids ...	25.0	40.63	22.48	24.70	23.80	23.47
Fat ...	1.6	17.71	1.46	1.48	0.64	0.87
Carbohydrates ...	55.8	29.54	62.15	60.36	60.78	61.02
Salts ...	3.2	4.00	2.91	3.26	3.56	3.34

On account of the large quantity of nitrogenous matter which peas and beans contain, they are used for animals which are required to undergo severe exertion, and then they are only given in moderate quantities of 3 or 4 lb. daily. In selecting them, it is highly important to notice that they are perfectly sound, quite free from any trace of mould or unpleasant odour. It is not uncommonly the case that a hunter, after a long run, will have a handful or two of beans put into his food on his return to the stable, under the impression that this will help to restore his exhausted energies. It would be impossible to commit a greater dietetic blunder. Immediately after excessive or prolonged exertion, the digestive powers, in common with the other organic functions, are enfeebled and therefore incapable of appropriating food which is from its mechanical condition difficult of digestion. A very moderate diet of good gruel or a small quantity of crushed oats with chaff and bran, the gruel by preference, is

all that the animal's system is capable of taking with advantage. Beans and peas will be useful later on, when the animal has recovered from its exhaustion.

Beans and peas, which would seldom be given until they are at least a year old and, therefore, make a very decided call upon the energy of the masticatory organs, are likely, to some extent at least, to escape even from the powerful grinders of the horse. They should consequently always be crushed and given mixed with the ordinary rations in the quantities previously mentioned.

Linseed.—Excepting for sick horses, or animals in poor condition, linseed is not employed as an article of diet. Its occasional use in the form of linseed mash is a favourite device of the stableman for improving the appearance of an animal's coat. When given for the purpose of restoring lost condition it will be mixed with other food to the extent of about 1 lb. per day.

Linseed is always ground, soaked, and boiled before being mixed with other food. The best plan is to boil it for a short time, as in making linseed tea, and when cold to mix it with bran or other articles of food. Linseed cake and the meal into which it is ground are sometimes used for sick and tired horses, either made into gruel or sprinkled over the food. It is obtained by crushing the seed and removing a large proportion of the oil for manufacturing purposes. It is consequently relatively richer in nitrogenous matter than are the seeds from which it is derived, as the two following tables will show.

Linseed yields the following analysis:—

Water	12.3
Proteids	20.5
Fat	37.0
Carbohydrates	19.6
Cellulose	7.2
Salts	3.4

	Pure Linseed Cake (Voelcker).	Linseed Cake.	Cotton Cake Undecorticated.	Cotton Cake Decorticated.	Rape Cake.	Palm-Nut Cake.	Ground-Nut Cake.	"Til" Cake.
Water	10.29	11.8	10.6	8.9	10.4	10.2	9.8	11.1
Proteids	28.59	28.7	24.7	43.6	30.7	16.1	31.0	37.2
Fat	12.66	10.7	6.6	14.9	9.8	9.5	8.9	12.8
Carbohydrates	34.85	32.1	26.0	19.7	30.1	41.9	20.7	20.5
Cellulose	8.07	9.4	24.9	5.7	11.3	18.3	22.7	7.5
Salts	5.54	7.3	7.2	7.2	7.7	4.0	6.9	10.9

In reference to linseed cakes, it may be remarked that the purchaser should carefully guard himself against the great risk of adulteration. Feeding cakes are of such great value to the agriculturist that the object of supplying them at a price which will attract custom could only be gained in a remunerative manner by adding to the genuine article a considerable proportion of useless material; and what is much worse, it has occasionally happened, whether accidentally or not can hardly be determined, that castor-oil beans, mustard seeds, and other highly objectionable and sometimes poisonous substances have been discovered on analysis.

Roots.—Mangels, swedes, turnips, and carrots, and also potatoes, which may be placed in the same group for convenience, are extremely useful articles for admixture with other articles of food, and they afford an opportunity of varying the diet from time to time. It has already been remarked that raw potatoes in certain conditions are poisonous, and especially is this the case in regard to the skins; consequently potatoes, when used for horse food, should always be boiled. The same precaution should also be taken when swedes are used. Mangels sometimes are used for horse food, and carrots are extremely valuable and are also very favourite articles of food with horses. In consequence of the exceeding fondness of horses for carrots, even in their dirty condition, it is desirable that they should be washed. Usually they are given whole, a few being thrown into the animal's manger. Now and then a case of choking has resulted from a horse swallowing large portions too greedily. To avoid this it is suggested that the carrots should be either sliced or grated; the latter process, however, is far too troublesome to be generally adopted, and in regard to slicing, unless it is very carefully done, some irregularly shaped pieces may escape the teeth and become impacted in the œsophagus.

Ensilage.—Some years ago the question of the preservation of green crops in pits or silos attracted an extraordinary amount of attention, and a commission was appointed, in which the present writer was concerned, to consider the question. The advantages which were most obvious in this method of dealing with grass and other crops which might be too poor to be worth harvesting in the ordinary way, were the independence of weather, increased facilities for storing in wet seasons, and the greater portability of the food obtained, as, under the effects of the pressure employed, a cubic foot of grass might be made to represent nearly the weight of an ordinary truss of hay.

The method of preparation is extremely simple, although in the first instance a large amount of capital was expended in the construction of model receptacles, or silos of wood or bricks, either sunk into the ground

or raised above it. Later on it was ascertained that very excellent results could be secured by merely cutting the green crop irrespective of the weather and stacking it in the ordinary way. It was found advisable to have large stacks in order to ensure sufficient pressure, and it was necessary also to cover the top of the stack with planks, close together, and to place on the planks any available heavy articles, pieces of machinery, large blocks of stone, and, in fact, any articles which might be encumbering the farm premises uselessly. The added weight, however, to the top of the ensilage stack, whatever might be its amount, did not appear to affect the density of the mass more than 4 or 5 feet down, and some very fair stacks of silage were made without any added pressure at all; but there is no doubt of the advantage of pressure in preventing mould at the upper part of the stack. It was calculated during the enquiry that the process of preserving green crops in this way, in the silo and by stacking under pressure, was extremely economical. It was found that grass preserved in this way yielded about five times the weight of the same grass made into hay. The other crops which were used for preservation by converting them into silage were rye, oats, millet, maize, barley, and sometimes wheat. And if these crops were in condition for cutting before the middle of June, before the seeds began to get hard, the land would be cleared in time for a second sowing.

Silage was intended to be used chiefly for cattle, but in reference to its use for horses also the commissioners reported as follows:—

“Strong as the evidence has been of the advantage of ensilage for keeping all stock in healthy condition, farm horses have by no means been excepted. We have received highly satisfactory accounts from several quarters of the health of working teams when given a limited proportion of silage, mixed with food. Among the plans of silos which have been submitted to us, those which consist of external walls, either above or below ground, whether of concrete or of stone, brick or clay lump cemented within, appear to be the most efficient; but in all cases, the absence of air depends upon two conditions: first upon its expulsion from the mass of forage ensiled, and, secondly, upon its exclusion when this is covered. Whatever may be put into a silo, it should be thoroughly well trodden in, and rammed down at the edges into a compact mass; with this object the advantage of rounding off the corners has been impressed upon us by some witnesses. To ensure the exclusion of the outer air it has been found useful to cover the mass with close-fitting boarded lids or shutters in one or more divisions, with a layer of bran-dust, or earth above them. Weights being required above this layer, to keep the mass compact, may be applied either in the form of any convenient dead-weight,

such as bricks, boxes or baskets of stones, or of mechanical pressure exercised by means of various systems of chains, screws, or levers. Instances are known of silos being successfully weighted without the use of boards, by simply covering the ensiled material with rushes, ferns, or other waste substances, and above these with dry earth or sand to the depth of 9 inches or a foot.

“As in the case of all important innovations, it is not surprising that the introduction of the system of ensilage into this country has been met by a considerable amount of prejudice and incredulity. During the progress of our enquiry we have endeavoured amply to discount all exaggerated estimates of its merits. After summing up the mass of evidence which has reached us, we can without hesitation affirm that it has been abundantly and conclusively proved to our satisfaction that this system of preserving green fodder crops promises great advantages to the practical farmer, and if carried out with a reasonable amount of care and efficiency should not only provide him with the means of ensuring himself to a great extent against unfavourable seasons, and of materially improving the quantity and quality of his dairy produce, but should also enable him to increase appreciably the number of live stock that can be profitably kept upon any given acreage, whether of pasture or arable land, and proportionately the amount of manure available to fertilize it.”

Two kinds of ensilage are recognized: sweet and sour, but the sour silage is most commonly in use. This is made by filling the silo as quickly as possible, or stacking the grass as the case may be, and putting weights on the top in order to check the rise of temperature which always occurs when the silage stack is made slowly, and results in the formation of sweet silage. In reference to the changes which grass undergoes during the process of conversion into silage, the following tables will afford the information in a condensed form. The analysis on ensilage is the mean result of thirty-seven analyses made by Dr. Voelker and published in the *Field*. The analysis of grass is that of Kuhn and Grandean.

	Water.	Nitrogenous Matter	Fatty Matter.	Carbo- hydrates.	Lignin and Cellulose.	Salts.	Nitrogenous Ratio.
Meadow Grass (Grandean) ...	78.35	5.24	0.96	9.66	3.72	2.07	1.2
Meadow Grass before flowering	75.00	3.00	0.80	12.10	7.00	2.10	1.4.3
Meadow Grass at the end of flowering ...	69.00	2.50	0.70	14.30	11.50	2.00	1.6
Meadow Grass (Kuhn) ...	72.00	3.10	0.80	12.10	10.00	2.00	1.4.1
Different Sweet Grasses (Kuhn)	70.80	2.60	0.70	11.70	12.10	2.10	1.4.7

ANALYSIS OF ENSILAGE.

Water	71.42
Volatile acid (calculated as acetic acid)28
Non-volatile acid (calculated as lactic acid)42
Albuminous compounds	3.17
Indigestible woody fibre	9.33
Digestible cellular fibre	10.39
Soluble carbohydrates, extractive matter, &c.	2.53
Mineral matter	2.46
										<u>100.00</u>

Both tables may be usefully compared with the table showing the analysis of hay at p. 111.

DIGESTION

Selection and preparation of food will be materially assisted by the knowledge of the physiological processes connected with the digestion of different kinds of provender. Very interesting experiments were performed by the celebrated French physiologist Colin, and Colonel Fred. Smith remarks that some of them he can fully bear out from his own observations. To avoid any mistakes, it will be advisable to quote the statements as they occur in the description which is given of the results of these experiments by the French physiologist. No details are given as to the methods which were adopted, and the critical reader may be expected to wonder how some of the facts given could have been ascertained.

The time occupied in digestion by the stomach of the horse is in proportion to the amount of nitrogen contained in the food—if hay be given before oats the hay will occupy one part (greater curvature) and the oats another part (lesser curvature) of the stomach. If the oats be given first they are deposited in the greater curvature, and the hay in the lesser curvature of the stomach. The two foods in both cases remain distinct until the mass reaches the pyloric end of the stomach, from which the intestine arises. According to Colin's experiments it is best to give the hay first and then the corn, otherwise the corn is sent into the intestine before being fully acted upon in the stomach.

The arrangement of food in the stomach in layers is disturbed by the swallowing of a large quantity of water. This disturbance does not occur, however, by the taking of a small quantity of water. Assuming this statement to be true, and it certainly seems to be perfectly reasonable, it affords a strong argument in favour of the usual practice in the best stables of always having water in the trough within the animal's reach.

The above results were obtained by giving different articles of food separately, but it appeared that when the foods were mixed, as they usually are—oats, chaff, roots, &c., being given together,—the different foods remained in the mixed condition in the stomach and passed into the intestines together, that containing the most moisture passing in first. The conclusion from this series of experiments was the very obvious one, that it is not desirable to mix foods of different degrees of digestibility, as they all pass into the intestines together, whether they have been acted upon by the gastric juice or not.

Most horsemen are aware of the common impression, which is undoubtedly true, that the digestion of the horse is extremely rapid—a necessary provision, indeed, to compensate for the smallness of the stomach compared with the animal's bulk.

Colin found that very early after the commencement of a meal the stomach begins to get rid of the food; in fact, as soon as the stomach is distended to a certain point a portion of the food begins to escape into the intestine, and in a quantity proportionate to the amount which is being eaten by the horse.

This circumstance naturally leads to the suggestion that the rations should be small in bulk, and given frequently, and that water should be given before feeding.

It was also ascertained that the conformation of a horse exercised a considerable influence upon the function of assimilation. Horses with narrow chests, badly ribbed up, and of a light mealy colour, animals which are known as bad doers, require great attention to their diet; in short, all the food which is given to them should be of the best quality, and the rule respecting small and frequent rations must be carefully observed. That the results of the experiments undertaken by the French physiologist are highly instructive will not be questioned. The probabilities, however, are that they will not be estimated by horse-owners in general as of sufficient importance to cause any interference with the ordinary routine of the stable; nevertheless cases may occur in which a strict attention to the principles which have been deduced from the facts discovered will be highly advantageous.

WATER

When it is known that something like four-fifths of the animal body consists of water, no argument will be necessary to prove the importance of a constant supply of the fluid in a proper condition for appropriation.

By the process of evaporation which is constantly going on from the skin, through the respiratory organs, and in other ways, water is constantly being excreted from the body, and when there is no supply from without to repair the loss, it must ultimately happen that all the animal tissues would become perfectly dried, which means that an animal weighing 100 lb. would be reduced to a mass weighing something under 30 lb. To compensate for the amount of water which is constantly being thrown off, even when in perfect rest, and to a much greater extent when undergoing exertion, it has been calculated that an adult man would require every twenty-four hours from $\frac{1}{2}$ to $\frac{7}{10}$ oz. of the fluid for each pound of his body weight. A man weighing 140 lb., therefore, will require from 70 to 90 oz. daily, and in ordinary English diet about 20 to 30 oz. of this is taken in the so-called solid food, and the remainder is drunk as liquid of some kind (Parkes). The horse, it is calculated, will require 8 to 12 gallons daily, a cow or small ox about 6 to 8 gallons, sheep or pigs $\frac{1}{2}$ to 1 gallon (Parkes).

Colonel Fred. Smith states that from experiments made in 1866 the War Office fixed the daily supply for cavalry horses at 8 gallons, and artillery at 10 gallons per horse. This quantity, however, was to include all water used for stable purposes, and in the artillery was to include washing carriages. From Dr. Parkes's observation, however, this quantity would be quite insufficient, as he came to the conclusion that 16 gallons per day per horse for all purposes was not an excessive amount. Colonel Fred. Smith also remarks that in a stable of cavalry horses, doing very little work, and at a cool time of the year, the amount per horse was found to average $6\frac{1}{3}$ gallons; and from experiments which he made in India he found that during the month of February a horse consumed on an average $8\frac{1}{2}$ gallons daily, which was made up as follows: Morning water, 1.9 gallon; mid-day, 3.4 gallons; at evening, 3.15 gallons. It does not appear to have been ascertained how much water a horse would consume daily when water is kept constantly in the trough in the stable or box, but it is generally believed that a less quantity is taken than when the animal has the water supplied to him at intervals three times daily.

Granting that a very considerable quantity of water is absolutely essential to keep the animal organism in a perfectly healthy condition, it must also be allowed that it is quite as necessary to obtain pure water as it is to supply the system with pure food. The latter requirement can be complied with without much difficulty. The food of the horse is so simple in its character, and undergoes so little preparation, that a very moderate amount of care will secure the animal perfectly whole-

some provender; but in the case of water the circumstances under which it is collected are so varied, and the sources of contamination are so numerous, that it is recognized by the experimental chemist as a fact beyond question, that when he requires pure water for scientific purposes he can only obtain it by the application of heat to convert the fluid into a vapour, which he is bound to convey through perfectly sterilized cold pipes, from which it will fall in the condition of water deprived of all foreign matter. In this condition of purity, however, it has lost all the flavour which makes it grateful to the palate, and at least certain products which are beneficial to the system. It becomes, therefore, most important to ascertain what impurities may be safely or advantageously admitted. Water in its absolutely pure condition consists of oxygen and hydrogen, and in this condition it may be obtained, theoretically, by the process of vaporizing under conditions which render contamination impossible. As it occurs, however, in seas and rivers, it holds in suspension or in solution various substances which it obtains from the earth and air through which it passes. Rain-water is sometimes referred to as the purest form in which water can be obtained naturally, but this implies that the rain shall fall and the water be collected in a place quite remote from habitations of all kinds, otherwise the various gases with which the atmosphere is charged, from the gaseous products of manufactures or living beings, are necessarily mixed with the falling rain, contaminating it sometimes to an extent which renders it poisonous or utterly unfit for use. Under ordinary conditions it is estimated that rain-water, even in rural districts, contains about 2 grains of solid matter to the gallon. In towns, particularly where large industries are carried on, the quantity of solids is necessarily much larger. The gases which contaminate rain-water are, in addition to carbonic acid, ammonia, sulphurous acid, and the emanations from drains and sewers. Other impurities are added as the rain passes over the roofs of buildings and along the gutters which are arranged for carrying it to the drains. Decaying vegetable and animal matters are frequently washed from the roofs of buildings, and when the water is carried along lead gutters, or stored in lead tanks, the sulphurous acid contained in the fluid, in addition to the products of decomposing vegetable matter, leads to the solution of the lead and renders the water poisonous, or at least highly injurious to the animals which drink it. When the water reaches the ground it becomes at once exposed to other sources of contamination. There is, first, the presence of putrefying substances on the surface, animal and vegetable, which leads to contamination with ammonia nitrates, nitrites, phosphates, and other constituents of natural and artificial manures, and in passing

through the soil it meets with various soluble salts of lime, magnesia, and soda, all of which tend to make considerable modifications in the quality of the fluid, to what extent may be gathered from the analyses of several specimens of water which are given by Professor Axe, published in the fourth volume of the *Royal Agricultural Society's Journal*, December, 1893. Three samples will suffice, and it will be observed that the first one is most remarkable for the amount of solid constituents, especially common salt, which it contains. "At Woodhall Spa, in Lincolnshire, a water said to possess valuable medicinal properties yields no less than 1542·2 grains of saline matter per gallon, as follows:—

						Grains per gallon
" Chloride of sodium (common salt)	1330·0
Chloride of calcium	111·0
Chloride of magnesium	91·2
Carbonate of sodium	10·0
Total	<u>1542·2</u> "

The next sample is drawn from the wells in the chalk at Croydon, and is noteworthy for the large amount of carbonate of lime it contains.

						Grains per gallon.
" Silica	1·2
Carbonate of calcium	17·8
Carbonate of magnesium	1·4
Chloride of sodium	2·0
Sulphate of sodium	0·9
Total	<u>23·3</u> "

This is a very hard water.

The sample which gave the following analysis is from Sudbrook Springs under the Severn:—

						Grains per gallon.
" Carbonate of calcium	13·6
Carbonate of magnesium	5·4
Sulphate of magnesium	3·2
Nitrate of magnesium	0·6
Chloride of magnesium	0·8
Chloride of sodium (with a little potassium)	3·5
Total	<u>27·1</u> "

Besides a considerable amount of chalk, this water is noticeable for the number and variety of the salts of magnesia it contains. It is therefore classed with the magnesian waters.

On the other hand, water collected from formations which are mainly composed of insoluble rock, are naturally remarkable for their freedom from saline constituents, as the two analyses of Woodland and Holmfirth waters will show.

"MANCHESTER WATER (WOODLAND)

	Grains per gallon.
Silica	0.30
Carbonate of calcium	1.70
Sulphate of magnesium	1.66
Chloride of sodium	0.91
Total	4.57

HOLMFIRTH WATER

	Grains per gallon.
Sulphate of calcium	0.8
Sulphate of magnesium	0.6
Chloride of sodium	0.8
Nitrate of sodium or potassium	0.2
Total	2.4"

The above specimens of water are obviously extremely soft, and under ordinary conditions of water-supply the fluid is divided into two kinds, hard and soft water, the hardness being due always to the lime salts—chiefly carbonate of lime or chalk, with the addition of a small quantity of the sulphate. Specimens of water containing large quantities of a great variety of mineral matters are properly classed as medicinal waters, which, however valuable in dealing with certain forms of disease, are not fit for use for dietetic purposes.

The question of the influence of hard water upon health has been frequently debated, and various opinions have been given in reference to it. There is no doubt that hard waters are constantly used for drinking purposes without any harm being suffered by the persons who take them, but it is asserted, by the author of the article from which we have quoted, that horses drinking hard water suffer from derangement of the organs of digestion, indicated by attacks of colic and other intestinal disorders. The skin is also said to lose its polish and become dull and scurfy, the coat staves, and a general state of unthriftness is induced. These results, however, suggest a very abnormal degree of hardness in the water which produces them. They are certainly not observed among horses which are living in chalk districts, where the use of hard water for men and also for the lower animals can hardly be avoided. Generally where hard water is distributed by the water companies it undergoes a preliminary process of softening by the addition of lime, which converts the soluble bicarbonate of lime into the insoluble carbonate or chalk, which is precipitated, and in this manner a considerable quantity of the lime is got rid of. The process, however, cannot be adopted on a small scale, where hard water is stored in tanks or ponds.

Hard water has occasionally been referred to as a cause of diseases of

bone and the formation of calculous concretions. It may be remarked, however, that the hardness of water is chiefly due to carbonate of lime, and would not, therefore, be likely to be very largely concerned in the formation of bony tumours, in which the phosphate of lime is the chief constituent; but there is no doubt that lime salts would be likely to contribute to the formation of calculous deposits in the digestive system or in other parts of the body.

It has already been stated that water forms a very large proportion of the tissues of the animal body—from 70 to 80 per cent,—and in the lower forms of living beings it may reach as much as 90 per cent. Professor Axe, in his articles in the *Royal Agricultural Society's Journal*, has given the following table, showing the amount of water contained in 1000 parts of the various organs and structures:—

Kidneys	827	Brain	750	Fat	299
Heart	792	Skin	720	Bone	216
Nerve	780	Bone marrow	697	Ivory	100
Spleen	758	Liver	693	Enamel of tooth	2
Muscle	757	Cartilage	550				
Sweat	995	Gastric fluid	973	Bile	864
Saliva	995	Milk	891	Blood	791
Tears	982								

The supply of water to the system is introduced in various ways, but the larger proportion is taken in the form of liquid or solid food, and there is also a certain quantity of water formed in the system by the oxidation of the various organic substances, resulting in combinations of oxygen with hydrogen and carbon producing water and carbonic acid.

Considering the important uses to which water is destined in the animal organism, it is remarkable that there is so little positive evidence of the injurious results attending the consumption of water which is polluted with animal and vegetable matter in various states of decomposition, with leakage from drains, with constant admixture with animal excreta, with the gases which are given off from decomposing bodies, and also with the organisms of specific diseases. It is quite true that every now and then the public is startled by a record of a great outbreak of typhoid fever or other fatal disease in consequence of some accidental contamination of the water-supply; but, as a rule, polluted water is about the last thing which is thought of as a possible cause of the outbreak of disease. This indifference probably arises in a great degree from the knowledge of the fact that people and animals continue to use the water of wells which are so placed as to be open to the entrance of the overflow of cess-pools; or, in cases of great scarcity, water from roadside ponds or ditches which are open to

every possible source of contamination, not only from causes which have been referred to, but from the addition of various kinds of offal not merely from healthy animals but from those which have died of anthrax, swine-fever, tubercle, and various other maladies. In addition to these sources of serious pollution there are the products of various kinds of manufactures. In mining districts the streams become contaminated with various poisonous substances; such manufactories as linen and jute works, starch factories, cloth works, tanneries, paper factories, and, in short, all kinds of manufactories which deal with organic substances in any form and discharge their refuse into ditches, or ponds, or rivers, or even on to the surface of the ground, through which they soak, contaminate the water springs at their sources.

A great deal has been said and written about the infection of ponds, ditches, and even of small pools or puddles, as some of them may be called, with the germs of parasites which are easily swallowed by animals grazing on grounds where such contaminated pools exist. While this fact is fully recognized by stock-owners, it is remarkable that they seem to prefer to trace an outbreak of parasitic disease among their lambs, sheep, and calves to any cause rather than the one which lies before them. From the circumstances of the case it is much easier to point to the sources of contamination of water, and to reason from the disastrous results which are occasionally traced to its use, and to those equally disastrous results which are referred to other causes than the right one, than it is to suggest means for rectifying the evil. The difficulties which stand in the way of providing a pure water-supply are in many cases absolutely insurmountable and in all cases extremely difficult. The celebrated engineer, the late Mr. Bailey Denton, spent a considerable portion of his life in trying to force public attention to the importance of water-storage. He constantly pointed out the very liberal quantity which was supplied every year in the form of rain, every inch which fell during a shower representing nearly a hundred tons of water to an acre, the whole of which amount is in the majority of cases allowed to soak into the ground wastefully, at least so far as its dietetic use is concerned. It may contribute to the growth of herbage, but it may, on the other hand, saturate the soil which is already useless on account of its marshy character. With a proper system of storage, such water, which is in excess of the immediate requirements either of the land or the animals upon it, could be preserved for future use; the only reason why it is not so preserved would seem to be the indifference of the authorities to the benefits which would be secured by such a course.

In the neighbourhood of large towns the system of water-storage is usually carried out by the means of reservoirs, but in rural districts the

hardships of a water famine have constantly to be endured in consequence of the absence of any means of storing. Presumably the question is one of cost, and it unfortunately happens that those districts which suffer most from scarcity of water in dry seasons are least capable of supplying funds for the formation of the required reservoirs.

A due recognition of the importance of a liberal supply of water for hygienic purposes in thinly populated districts as well as in populous would be naturally followed by the adoption of a proper system of inspection for the purpose of ascertaining the quality of the water, including its degree of hardness, whether arising from excess of carbonate of lime or from other lime salts which cannot be got rid of, and the employment of the proper means for the purpose of correcting any objectionable characteristics prior to the distribution of the fluid.

Means for these purposes are easily applied under the circumstances referred to, but they are absolutely impracticable so long as the supply of water is drawn from ponds or from wells which in many places are open to pollution which can neither be prevented nor corrected.

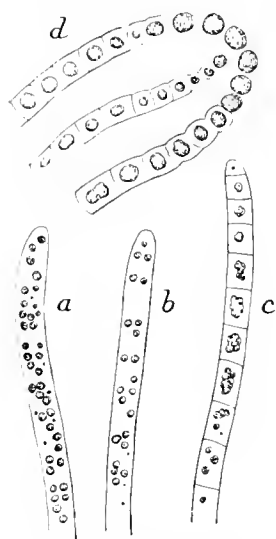

Fig. 478.—A Sewage Fungus, *Bryganaea alba* (sulphur bacterium)

a. In a medium rich in sulphuretted hydrogen. *b.* Almost depleted of sulphur granules by twenty-four hours' immersion in water free from sulphur. *c.* Sulphur disappeared; transverse walls now visible, after forty-eight hours' further immersion. *d.* Decaying through lack of sulphuretted hydrogen.

Natural Processes of Purification of Water.

Water in its most polluted form undergoes certain chemical and physical changes which have a distinct tendency to restore it to a wholesome condition. Under all circumstances water contains air, the oxygen of which acts with energy on septic bodies, causing them to undergo a new form of decomposition, resolving them into compounds of carbonic acid and ammonia. Further and even more destructive processes, the nature of which is not clearly understood, also take place under the influence of oxygen. It has been observed, for example, that water highly contaminated with sewage, so as to be quite turbid, if left entirely at rest for a long period becomes absolutely odourless and perfectly transparent; and what is more remarkable, this change is not the result of the subsidence of solid particles, but of the oxidation and conversion of solid material into soluble compounds. It does not, of course, follow that water under such circumstances will be fit for drinking purposes, but the instance is a remarkable illustration of the changes which are effected under the influence of oxygen.

Stagnant pools undergo a considerable amount of purification owing to the presence of living vegetation, particularly when the plants belong to the flowering order. It can be observed, even in so small a space as that furnished by an ordinary aquarium, that bubbles of gas are constantly being emitted from growing water plants or weeds, as they are called. In addition to the action of plants in furnishing oxygen, aquatic animals also contribute very largely towards the destruction of organic bodies. Myriads of minute creatures belonging to the infusoria spend their lives in the assimilation of organic substances; in fact, the presence of these animalcule and plants may be accepted as a proof that the water is capable of supporting animal and plant life. On the other hand, however, it has been observed by

Bennett, Rafter, and other writers referred to by the author of *Water in Relation to Health and Disease*, that there are numerous living beings contained in water which tend rather to add to its pollution than to remove it. It would appear that nearly all the varieties of aquatic fungi derive their sustenance from decomposing substances, and their presence in water is proof in itself of the existence of septic material. Such organisms as live on decomposing bodies are described as saprophytes. The sewage fungus (fig. 478) is a notable instance of an organism of the class referred to, and it is most easily recognized in the description which is given of it as "a dirty-looking, jelly-like layer covering the bottom and sides of the water-course in which it occurs". Its presence may always be taken as proof of the existence of sewage contamination.

Besides the various fungi which are found in streams, and water-courses, and drain-pipes, there are numerous algae, of which the blanket-weed (fig. 479) is a well-known example. Mr. Bennett describes algae in two distinct forms, the blue-green alga (fig. 480).

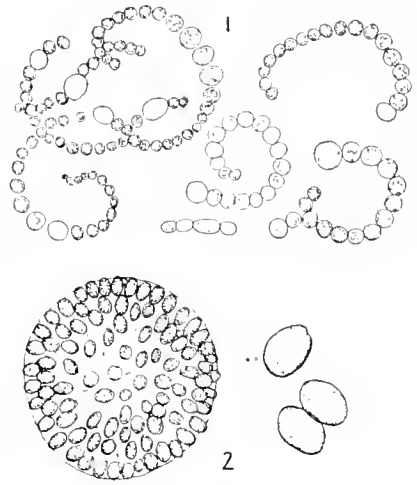

Fig. 479.—Blanket-weed

1, *Anabaena flos-aquae*. 2, *Celosporium Kutzingianum*, with detached cells.

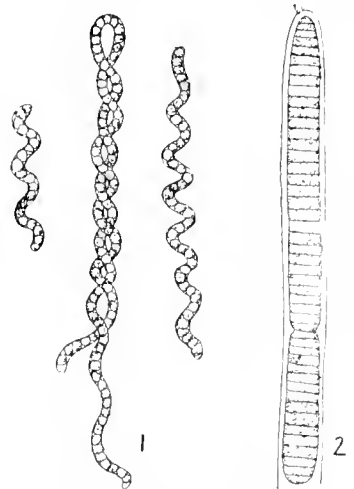

Fig. 480.—Blue-green Algae

1, *Spirulina Jenneri*. 2, *Oscillatoria insignis*.

and the chlorophyll-green alga (fig. 481). The first gives off a small amount of oxygen insufficient to exert any useful oxidizing function, while both excrete fetid gases during their decomposition; consequently, when found in water, they may be taken as an indication that it is unfit for use. Of the second class, one family (Conjugatæ) is distinguished by the peculiarity of extreme sensitiveness to the influence of decomposing substances. They can only live in water which is charged with oxygen. Their presence, therefore, in a flourishing condition may be accepted as

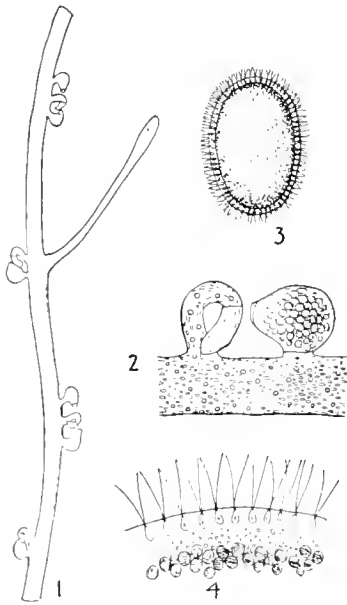

Fig. 481. — Chlorophyll-green Alga (*Vaucheria sessilis*)

1, Plant. 2, Portion of filament enlarged. 3, Swarm spore. 4, Portion of the same enlarged.

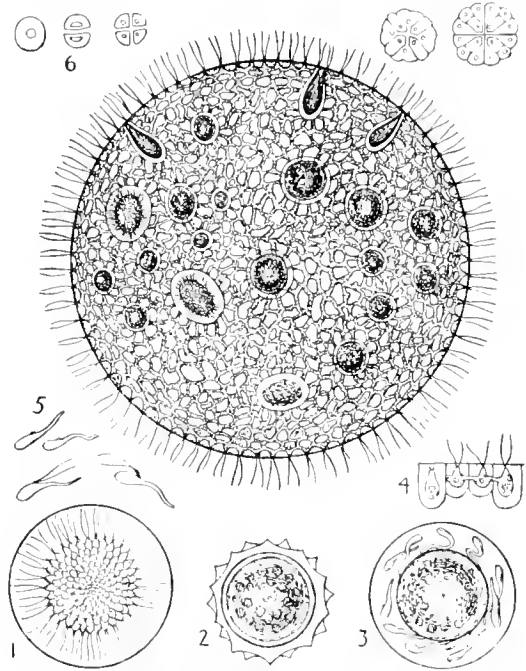

Fig. 482. — *Volvox globator* (colony)

1, Antherozoid. 2, Oosperm (mature). 3, Oogone. 4, Peripheral cells. 5, Antherozoids. 6, Mode of division of parent cell of a zoospore.

proof that the water is free from any large amount of objectionable organic constituent. It may be further noted of these plants that while they demand a large quantity of oxygen as a condition of their own life, they give off a considerable quantity of the same gas, to the manifest benefit of the water in which they reside.

An illustration of the purifying influence of plant-life on water is quoted as having occurred in India some years ago, when, by some accident, all the aquatic plants were removed from the water-tanks. The consequence was that the previously wholesome water quickly became unfit for consumption. According to Rafter, writing in the transactions of the American Society of Civil Engineers, the well-known and extremely beautiful alga, the *Volvox*

globator (fig. 482), has on certain occasions appeared in enormous quantities in the reservoirs which supply Rochester in the State of New York, imparting to the water a fishy taste and odour, and apparently causing sickness and death among the cattle which drank it. The stoneworts (fig. 483), so called from becoming coated over with an earthy deposit, when existing in large quantities give off sulphuretted hydrogen, which is a highly poisonous gas. A variety of fresh-water sponge has been identified as giving a nauseous odour and taste to water, owing to the presence of ammonia. Its removal from the places in which it grew was followed by the restoration of the water to a wholesome condition.

Mr. Francis, of Adelaide, records that in 1878 the lakes which form the estuary of the Murray contained a plant which he believed to be allied to the *Protococcus*, which formed a thick scum like green paint, some 2 or 3 inches thick, on the surface of the water, and when swallowed by cattle, which drank of it, it rapidly caused death.

Numerous other instances might be referred to in proof of the fact that while certain plants, probably without exception all flowering plants, and to a large extent all the high order of green plants which flourish in water and give out oxygen, particularly during the daytime and when the sun is shining, exercise a purifying influence upon water, there are others, including a number of aquatic fungi, which either exercise an injurious influence or indicate by their presence that the water is unfit for use. It is, therefore, a matter of considerable importance that the very common procedure of weed-cutting should be exercised with discrimination. All the aquatic plants which are beneficial, as well as those which are injurious, to water, are distinguished by botanical characteristics which can be readily identified by an expert. There will be no real difficulty, therefore, in determining, at any rate within certain reasonable limits, what plants should be as far as possible extirpated and which of them should be allowed to flourish.

Examination of Water.—In works on hygiene which are exclusively intended for professional readers it is usual to describe the processes, both chemical and physical, for the analysis of water for the purpose of

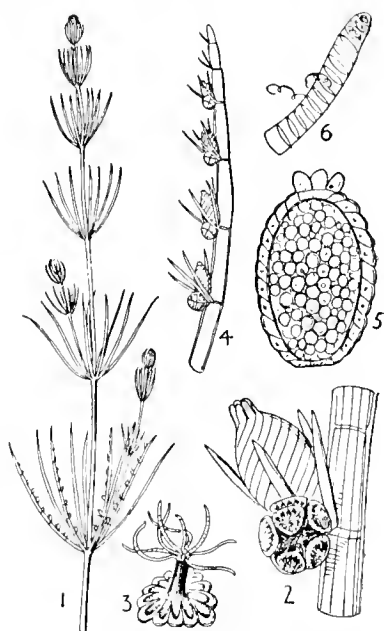

Fig. 483.—Stonewort (*Chara fragilis*)

1, Plant. 2, Sporangium and antheridium. 3, Valve of antheridium. 4, Enlarged branch. 5, Section of sporangium. 6, End of a filament.

ascertaining what constituents are present which may exercise any injurious action on the animal which drinks it.

By the mere physical examination the general character of the water is determined by the unaided eyesight, but it must be understood that this kind of examination does not justify any conclusion as to the qualities of the water which may render it fit or unfit for use. It has been proved that some of the brightest water may be charged with deadly material. In one of the outbreaks of cholera which occurred in London, a certain pump, the water of which several serious outbreaks of cholera were traced, was so noted for its bright, and sparkling, and palatable character that all the people within a reasonable distance round it came regularly to obtain, at any rate, sufficient water for drinking purposes, and as a consequence the disease was widely spread. As a matter of course, as soon as the character of the water was discovered, the pump was closed, and the spreading of cholera from that source was arrested. An illustration in the opposite direction was afforded by an examination of the porter-coloured water which is so commonly noticed in ponds near straw-yards, such ponds being the ordinary drinking-places for horses and cattle. The brown-coloured water is commonly said to suggest the presence of sewage, but the water referred to in the farm ponds was repeatedly examined by Dr. Augustus Voelker, and found by him to be singularly free from organic contamination, the brown colour being due to the formation of humic and ulmic acids which did not appear to exercise any deleterious influence on the animals which drank of it. There can be no doubt that the water of these farmyard ponds, into which the drainage from the straw-yards is constantly running, must have received large quantities of organic matter; but, being at the same time perfectly open to the constantly moving atmosphere, the organic matter must have been oxidized into comparatively innocuous compounds.

It is not suggested, of course, that porter-coloured water is a desirable fluid for horses or cattle, nevertheless it is an undoubted fact that it was in former times the habitual drink of those animals year by year; and in one case in the writer's knowledge it continued for a dozen years on a large farm, where the stock remained during the whole of that time in a remarkably healthy condition. It was during this period that the two circumstances, *i.e.* the remarkably healthy condition of the stock on the farm and the habitual use of porter-coloured water for the horses and cattle—in the case of the latter the *invariable* use of it for the reason that there was no other water within the animals' reach,—attracted Dr. Voelker's attention and led to the analyses referred to. The story itself suggests that a chemical examination of discoloured water is necessary in order to deter-

mine on what the discoloration depends. But, in any case, it must be clearly understood that the colour in itself is not a satisfactory indication of the quality of the fluid.

The brightest and most sparkling water may be absolutely deadly, while dark-coloured and dirty water may be comparatively harmless.

A rough test, which the unprofessional observer can easily employ, is to allow the specimen of water to stand in a glass for some hours, for the purpose of ascertaining if there is any sediment. Taste and smell are means of ascertaining something of the qualities of water, as in a wholesome state the fluid does not possess any decided taste, either acid or alkaline; and an odour, either pungent or offensive, may be at once accepted as proof that the water is not fit for drinking purposes. Then there are also certain simple tests which may be readily employed even by a person who has not more than a very elementary knowledge of chemistry. For example, the presence of lime may be detected at once by adding a solution of oxy-late of ammonium, which causes at once a white precipitate, and some idea may be formed of the amount by the quantity of precipitate which falls. A mere turbid condition, rendering the water somewhat opalescent in appearance, does not indicate that the water contains more than an ordinary quantity of lime, while a large quantity of precipitate indicates a hard water.

Colonel Fred. Smith gives a very simple process, which he has found effectual in estimating in a rough way the amount of hardness of water in which the oxy-late of ammonium has caused the characteristic white precipitate. He proposes to use the ordinary soap liniment as a test, and he finds that 1 drop of this preparation added to $\frac{1}{2}$ oz. of water will indicate about $1\frac{1}{2}$ grain of lime per gallon, if on shaking the mixture a lather is produced.

If, however, 4 drops are required to produce a lather there will be about 6 grains of lime per gallon. If 6 drops are required there will be 9 grains, if 12 drops, 18 grains. Calculating that the amount of lime per gallon in good water should not exceed 6 grains, it is easy to form some idea of the degree of hardness which exists in the water under examination. The process may be further extended in order to ascertain which of the lime salts is the cause of the hardness; which may depend upon carbonate of lime, and indeed generally does, but may also result from the presence of a sulphate, chloride, or nitrate. The presence of the carbonate is determined accurately by boiling a portion of the water which has been tested by the soap liniment. Supposing that it takes 12 drops of soap liniment to produce a lather before boiling, and only 3 drops to produce the same effect after the water has been boiled, it would show that the hardness was due to chalk (calcium carbonate). The advantage of acquiring this know-

ledge will be obvious when it is remembered that the hardness caused by the carbonate of lime may be got rid of by a comparatively simple process (the addition of a small quantity of lime, and precipitation of the carbonate. See page 123), while that caused by the presence of sulphate, chloride, and nitrate of lime cannot be removed. The test, however, for chlorine, sulphuric acid, and nitric acid would be rather beyond the powers of the amateur.

The presence of organic bodies is generally considered to render water unfit for use, but a great deal must depend upon the nature of the organic matter, whether animal or vegetable, and also on the state of decomposition which has been reached. Samples of water which have been found to contain an enormous quantity of vegetable matter have been taken by animals with perfect impunity, doubtless on account of the matter being of vegetable origin, and not having undergone decomposition. Microscopic examination of water, especially water which deposits various impurities after rest, is the only satisfactory method of discovering the character of the impurities. A further step in the same direction is inoculation of nutritive media, such as pure gelatine and other similar substances used by the bacteriologist, but this, as well as the use of the microscope, must necessarily be left in the hands of the expert.

EXAMINATION OF AIR

In an absolutely pure state, such as could only be secured by the admixture of the two essential constituents, oxygen and nitrogen, in proper proportion, the air does not exist in nature. The purest air contains a minute quantity of carbonic acid and a certain amount of water vapour, with traces of ammonia and ozone, varying in amount according to the situation, as well as organic and mineral particles. Of the constituents of healthy atmosphere, oxygen deserves the chief consideration as a powerful agent in the destruction of various impurities. Roughly, its proportion may be taken as one-fifth, while nitrogen constitutes the greater part of the remaining four-fifths, exercising apparently its chief function, that of diluting the oxygen and modifying its stimulant action. Animal life is not sustained by nitrogen, as it is a non-respirable gas; it is destroyed by oxygen by being carried on too rapidly—the animal under the violently stimulating, exciting influence may be said to live the whole of its life in a short space of time. It is only, therefore, by the combination of the two elements that a respirable atmosphere, capable of supporting life for its normal period, is obtained.

Air is distinguished by its almost unlimited capacity for absorbing

impurities of all possible kinds. Wherever animals and plants exist carbonic acid and various organic substances excreted from the system are constantly being thrown into the air. Living organic bodies are also continually being conveyed by the air, sometimes long distances, and in this way certain infective particles are conveyed from diseased to healthy animals. A large number of these, however, cannot in all probability be carried to any great distance, unless under the influence of powerful currents. It is recorded that ships, when several hundred miles from land, sometimes have their sails and yards covered with sand; it can hardly be questioned, however, that such heavy material could only be conveyed such a distance by very high winds.

Examination of air is only possible to the unprofessional observer by the use of the organ of smell, and it may be said of air, as it has already been said of water, that the presence of a smell of any kind is proof of contamination. The taste and the eyesight will assist in certain cases when the air becomes charged with the smoke emanating from chimneys of factories in which trades, which are described as noxious trades, are carried on; but for the purpose of detecting invisible suspended matters, organic bodies, carbonic acid, watery vapour, ammonia, and other solid and gaseous products, the knowledge and skill of the expert are absolutely essential.

INDIVIDUAL HYGIENE

Under the above heading Dr. Parkes, in his classical work on *Hygiene*, refers to individual hygiene as a large subject which would require a volume to itself; it will be understood that by the use of the term that great authority means to include everything which is in any way connected with the habits of the individual:—his work and his amusements, the nature of his diet, and the amount of exercise and rest which he takes, the kind of clothing which he wears, the climate which he inhabits, in short, everything which the man does or leaves undone. Even the exercise of his reasoning faculties, to quote the words of the author, “the amount of mental work, the practice of general good temper, cheerfulness, and hope”, are all concerned in digestive processes, and they are all included in the term individual hygiene. Obviously in applying the term to the lower animals a very large part of the subject, *i.e.* everything which relates to mental processes and the exercise of volition, everything indeed which the individual does by intention, must be necessarily omitted, because the animal in domestication has no choice in the matter of his diet, the amount of exercise or work, the gratification of his wants, whether reasonable or otherwise, as everything is arranged by the stable attendants. For these

reous the heading "individual hygiene" must be applied to the acts of the individual who attends to the horse, the animal itself being only called upon to submit to what is done for it or what it is constrained to do.

The author of *Veterinary Hygiene* adopts Dr. Parkes's classification generally, and deals with such matters as grooming, clipping, clothing,

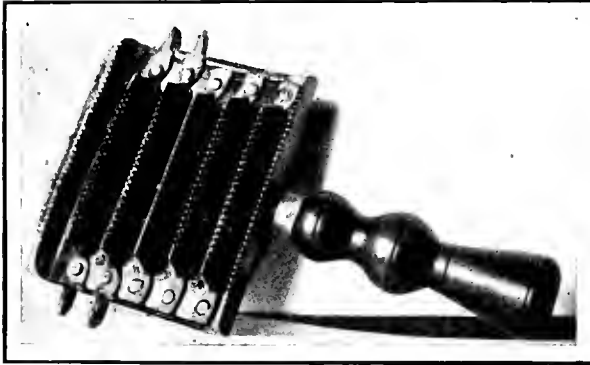

Fig. 484.—Curry-comb

bedding, and other items of stable management, which vary considerably in different establishments, according to the character of the work which the horse has to perform, or the views of the owner as to the comforts which are necessary for the animal's well-being, or the amount of luxury even which may be allowable in reference

to stable construction and stable appliances.

Grooming is the term which is used to include the various methods of cleaning horses, whether engaged in work or resting in the stable. The instruments employed for the purpose include brushes of different degrees of hardness; a curry-comb, which is a kind of iron rake with fine teeth;

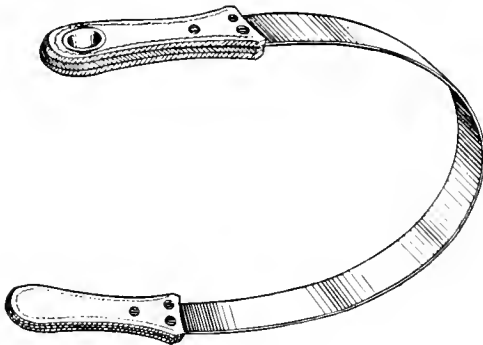

Fig. 485.—Scraper

wisps, which are small bundles of hay or straw twisted up into a convenient shape by the stable attendant who employs them; sponges, and an iron hook which is employed for removing mud from the feet. A thin flexible band of steel with handles at each end, known as a scraper, is also employed for scraping wet mud from the sides and other parts of a horse on a return

from a journey in wet muddy weather.

In the ordinary course, horses are groomed in the morning for the purpose of cleaning the skin from the dirt which may have accumulated during the night. This application of the brush with a certain amount of force not only removes the surface dirt, but also stimulates the skin and improves the circulation. It is usual to follow the brush by the wisp of hay or straw, and this part of the process is usually carried on by the stable-

man with considerable energy, and with the utterance of a peculiar whistling noise, which may be taken as a habit on the part of the operator, but is also considered by some people to be soothing to the horse. The wisp is usually brought down upon the skin with a certain amount of force, and then drawn along the hair, and the whole effect is doubtless very complete as a method of beating out the dust from the animal's coat.

The brush that is employed in the first instance is known as a dandy brush. (See fig. 486.) At different times during the application of this brush the attendant employs the curry-comb, an instrument with an iron back, having secured to it a series of small plates with fine saw-like teeth, intended solely for the cleaning of the brush from the accumulation of dirt and loosened portions of cuticle (dandruff), of which word the name given to the brush is evidently a corruption. The curry-comb is sometimes resorted to

for the purpose of assisting in cleaning a thick coat and a very scurfy skin; it is hardly necessary to say that the curry-comb was never intended for any such purpose, and that its use is altogether

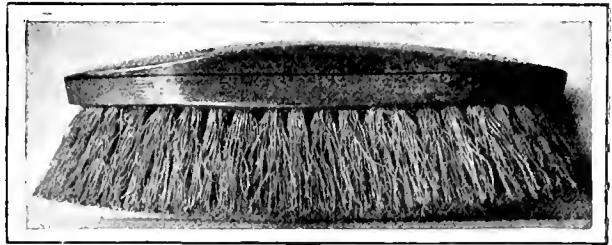

Fig. 486.--Dandy Brush

objectionable. In fact, unless considerable care is exercised, it may happen that the skin of the animal, to which a new and therefore sharp curry-comb is applied, may be considerably damaged at those parts where the skin is closely applied to bone, as in the protuberant part of the hips, for instance, and the owner of a horse observing such injuries may be pretty safe in suspecting the curry-comb, and in declining altogether to believe the ordinary explanation that the horse has scratched himself against a wall or the side of the stall.

The feet and legs, in muddy weather especially, are generally washed, and in the case of hunters, which after a run in heavy country in wet weather are covered with mud on the legs and lower parts of the body, washing with hot or cold water according to fancy is usually employed after the scraper has been used to clear away the greater portion of the mud. This procedure, so usual, and on the face of it so natural, a way of getting rid of the dirt that the stableman would have been once condemned as inefficient and idle if he had neglected it, has for a very long time continued without the least suspicion that it could under any circumstances be objectionable. It was very well known, however, that there existed a disease of the skin, which was called mud fever on account of its affecting horses which were working

on muddy roads or hunting in wet districts, and various methods of treatment were employed for its cure, and some countries had the credit of possessing soils which contained an unknown but extremely irritating constituent. It was, however, always the case that these parts of the country were perfectly harmless in dry seasons, but, having loose loamy soil, were readily converted into mud by heavy rains, and certainly no particular constituent likely to cause irritation was ever discovered, nor with our present knowledge of the subject is there any reason to suspect that such peculiar constituent existed.

To complete the story it is necessary to relate that some fifty years ago a veterinary surgeon in the midland counties discovered, in the course of his practice, that mud fever never occurred in badly conducted stables, where the attendants were either too lazy or too much occupied to trouble themselves about the mud on the animals' legs and other parts, but turned them into their stalls untouched, and got rid of the mud the following morning with the greatest ease, commonly by the aid of the ordinary birch broom, which, being applied to the parts where the dried mud remained, at once swept it off in the form of fine dust. The discoverer, whose name has escaped the writer's memory, as it has that of all modern writers on the subject, apparently induced some hunting men to try the method, to the great disgust of the grooms, as a matter of course. The system very soon became quite general in large establishments, and cracked heels and eruptions on the legs and other parts of the body almost, and in some cases entirely, ceased to appear among the horses.

In the best establishments, where the proper appliances are always to hand and understood, the practice is to envelop the muddy legs in dry, warm, flannel bandages, and brush the dust out of the coat the following morning.

As soon as the fact was discovered that washing the muddy skin was injurious, and all the more when hot water was used, a satisfactory physiological explanation was at hand; indeed, an experiment by one celebrated physiologist has only to be quoted in order to make the whole matter perfectly clear.

The experiment was one connected with a series relating to the causes of inflammation under the influence of change of temperature. The ear of a rabbit was subjected to the influence of cold fluid until the blood was driven from the superficial vessels by the contraction of the arteries. The animal was then at once transferred into a warm chamber. The blood immediately rushed back into the channels from which it had just before been driven, with the necessary result that some vessels were blocked by the excess of blood, while in others the circulation was going on with rapidity.

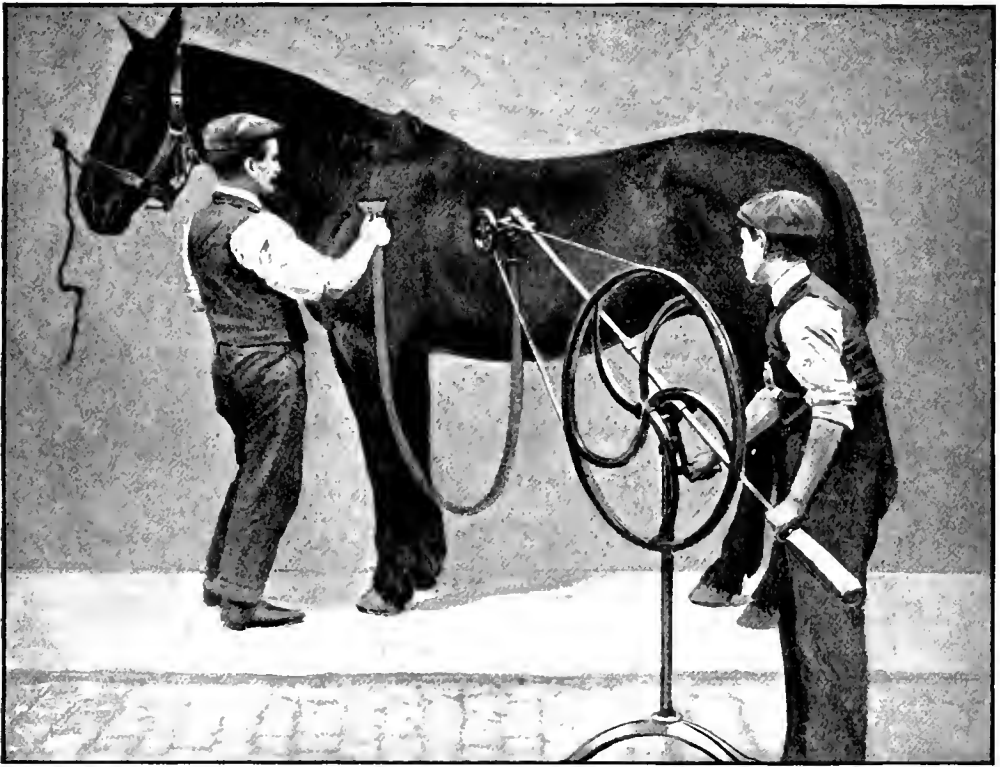

Fig. 187. — Barton-Gillette Clipping Machine

All the essential phenomena of the inflammatory process were thus induced.

Washing the feet is, of course, entirely free from the objection which attends washing the skin, as the hard horny substance which forms the hoof has no vessels, and consequently no circulation which can be disturbed; and when, in the case of light-coloured horses, washing the legs is insisted on, it should be done with cold water, the greatest possible care should be taken to dry thoroughly the parts which have been washed, and bandages should be at once applied. The practice of washing horses all over cannot possibly be defended. It is totally unnecessary, and, when it is done, the chances are entirely in favour of the animal being left in a wet condition, unless there are sufficient helpers at hand to ensure that the wisps, which must be frequently changed, are applied with sufficient energy, and for a sufficiently long time, to get rid of all the moisture.

Clipping, or singeing, or both, are absolutely necessary in the case of horses which have a thick winter coat, and are engaged in ordinary work. There is no doubt that the presence of a heavy coat indisposes the animal to exertion: the warmth naturally leads to excessive sweating, and the coat wetted in this way is dried with very great difficulty.

It has been suggested, as an objection against clipping, that a horse, after the removal of a thick coat, is likely to take cold; but this objection may be easily disposed of by the use of extra clothing for a time. In some cases among working horses a portion of the hair is left on the back and loins and also on the extremities.

Clothing, in the best establishments at any rate, is looked upon as one of the necessities of stable management, and if we accept Stewart's observation that its effect is to keep horses warm without endangering the purity of the air they breathe by restricting ventilation, it is evident that the use of clothing can be defended on hygienic principles. Clothing is in favour



Fig. 488.—Horse-clippers

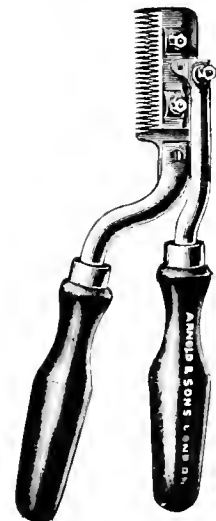

Fig. 489.—Clippers for Trimming Legs

with grooms and coachmen, and is sometimes used to excess for the purpose of keeping a horse's coat fine and glossy. It must be quite obvious, however, that thick clothing during hot weather is in every respect objectionable, and that, when it is employed, it should be regulated in regard to its weight, according to the climatic conditions under which the horses are placed.

Bedding.—In stables where luxurious appliances are in vogue, a sufficient quantity of straw of good colour and quality is considered to be indispensable for the comfort of the horse, as well as for the appearance of the stable; but when economy is an object, as in the case of large establishments, moss-litter is commonly employed, or, in place of it, saw-dust or tan. It was when moss-litter first came into use that there was a great outcry about the injurious effects of the litter on the horses' feet: certainly in some cases the hoofs of animals standing on the moss-litter were found

to be broken, and the soles of the feet discoloured, as if from the effects of a severe bruise. From experience, however, it would seem fair to conclude that the brittleness and the discoloration must have been due to other causes.

Of late years, at any rate since its use has been better understood, nothing has been heard of this objection.

Some horses exhibit an extraordinary fondness for the straw of their litter, and eat it in large quantities to the neglect of the hay which is placed in the rack for their use.

In these cases there are alternative means of prevention. One, the employment of a muzzle, and the other the disuse of straw altogether for the litter of the particular animal in favour of one of its substitutes.

Management of the feet is a very important part of individual hygiene, and it consists chiefly in a rapid adoption in regard to healthy feet of the policy of non-interference. Hoof ointments, which are supposed to increase the elastic qualities of the hoofs, when they are not injurious by plugging the openings of the horn tubes, many of which terminate, from their somewhat oblique course, on the wall, and all of which so terminate on the horny sole, are at best entirely unnecessary. The same thing applies, of course, to stopping the bottom of the feet. The most important part of hygienics, as applied to the feet, is a careful observation of the condition of the hoofs, and of the position of the shoes, with a view to having the latter renewed when necessary, or removed and reapplied when not sufficiently worn to necessitate the application of new shoes.

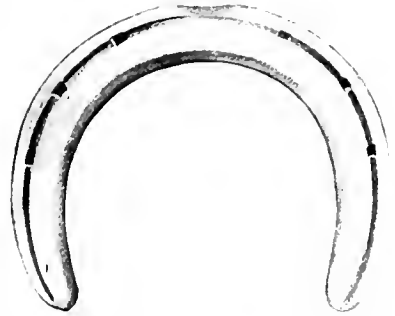

FIG. 490.—Toe-tip for Horses turned to grass

Horses which are kept to rest in loose-boxes—the most successful method, as a rule, of summering hunters—require more than usual care in regard to their feet. The hind shoes are usually altogether removed, and the edge of the crust is rounded off by the rasp, in order to prevent chipping. A light tip would usually be applied to the fore-feet, leaving the heels to come in contact with the ground surface.

The above remarks may be applied in regard to animals which are turned out to grass. In very dry seasons horses' hoofs, under such circumstances, become exceedingly dry and brittle, and contract sometimes to a serious extent. This happens just as certainly as it would if the hoofs were removed and placed in a warm place, the only difference being that, in the case of the living animal, the drying occupies a longer time. The only

remedy is the application of moisture, which possibly may mean the frequent removal of the horse from the dry ground into a shed or other place where the soil can be kept moist. It may be taken as a golden rule that moisture is essential for the maintenance of a healthy condition of the hoof horn, and that no other outward application is necessary.

Vices.—Certain habits which horses acquire while standing in the stable, habits which depend upon peculiarity of temper and constitution in some cases, while in others they are due to imitation, require correction, as far as it may be possible to correct them. Crib-biting and wind-sucking are perfectly well known to horse-owners; weaving, a singular habit of moving the head from side to side; drawing the halter-ropes by the attached blocks up and down through the manger-rings; and the extremely unpleasant habit of kicking, particularly at night, are all of them productive of a great deal of annoyance, and some of them—crib-biting and wind-sucking for example—are distinctly injurious, the two latter deserving to be classed under the head of unsoundness, as they certainly cause damage to the teeth, and lead to attacks of colic, loss of condition, and even more serious affections, and certainly render an animal less capable of performing the work which is required of it, than it otherwise would be.

All these stable vices are fully considered in the chapter devoted to that subject.

HYGIENICS APPLIED TO DISEASED ANIMALS

In the case of horses suffering from any kind of sickness, the principles of hygiene can only be applied for the purpose of assisting the restoration of health, as it would be impossible to preserve what has already been lost. Undoubtedly it is the case that sanitary laws should be more strictly applied in cases of sickness than during health, and their strict application should have relation to everything connected with stable management.

Isolation.—First, the subject of strict isolation has to be considered. At the commencement of an attack of illness it is impossible to determine, in many instances, whether or not the disease is infectious; in fact, it is even at present, notwithstanding our great advance in the knowledge of pathology, doubtful in respect of many diseases, whether they are infectious or non-infectious, and at any rate, at the outset, separation of the sick animal from the healthy is a simple precaution which should never be neglected, if it is possible to enforce it.

Food is the next subject, and it is rather remarkable that in regard to sick animals, as well as to sick persons, a question which is most anxiously asked is, what is the patient likely to fancy to eat. It was remarked by a

celebrated physician that his great difficulty in serious cases was to induce the friends of his patients to refrain from supplying them with anything in the form of food until he gave instructions to that effect; and it is well known to physicians in fever-hospitals what disastrous results have happened from the friends of patients recovering from typhoid fever surreptitiously bringing in a currant-bun, under the impression that it would tempt the patient's appetite and be a pleasant change from the slops on which he had been kept. Should the patient attempt to consume the delicacy, the result to be apprehended, and one which has happened, as proved by post-mortem examination, is the lodging of some of the currants in healing ulcers in the intestines, and the setting up of a new ulcerating process.

Some horses are certainly exempt, as a rule, from this special risk, but so extremely anxious are the attendants to support a sick animal's strength, as they say, that they not only tempt the appetite of the subject of inflammation of the lungs, or other acute disease, with carrots, green food, or some other delicacies, but, if they are refused, as most probably they would be, they insist on forcibly administering food in the form of gruel or thick linseed tea, quite forgetting that the mere act of exciting the patient, by the force which is necessarily employed, will do far more harm than the food could do good, even if it were willingly taken.

Attendants on sick horses have yet to learn that the want of appetite is Nature's unmistakable way of hinting that the animal is much better without food during the immediately acute stage of a fever attack. It is only during the stage of convalescence that food is absolutely necessary, and the ingenuity of the attendant may be wisely exercised in selecting articles of diet which he thinks the horse would be likely to take, always on the understanding that the food selected must be easy of digestion, and concentrated in its character. All kinds of bulky food are out of the question. A complete change of food has been recommended even in the case of animals that have no particular disease, but suffer from want of condition, and this change is far more necessary with animals which are suffering from acute disease. The most perfect change which can be devised is the substitution of animal for vegetable diet. Good meat-soup mixed with bran, and placed in small portions in the animal's mouth, as previously directed, will often excite the animal's appetite, and when he once becomes accustomed to the flavour of the new diet he will take it with avidity.

In extreme cases the fibrine of the blood, separated and dried, and mixed in the form of powder with bran mashes, has been found very effective as a restorative. Milk mixed with eggs forms an acceptable diet for sick horses, and is frequently taken by them without any difficulty, and it may be

allowed at any time after the first acute stage of the disease has begun to decline.

One error which is commonly committed in feeding sick horses is that of leaving the food which the animal has refused in the manger, with the idea that he may take it later on. Certainly nothing could be more disgusting to a sick person than to have the plate of food which he has declined kept close to him for some hours; and sick horses may be credited with a certain amount of taste in the same direction. When the food has been refused, it should be entirely removed from the manger, after the animal has been allowed a reasonable time to consume it, if he wished to do so. And no more should be offered until the horse indicates by his movements and looks, which an experienced stableman perfectly understands, that he is anxious for another opportunity of taking nutriment. Water should be kept always within the animal's reach, and should be frequently changed, so as to be always cool and fresh. The plan that is frequently—and in former times much more frequently than it is now—adopted of adding hot water to take the chill off, the compound so formed being called oddly enough chilled water, instead of what it really was, warmed water, is an act of unnecessary cruelty. Nothing can be more grateful to a man or horse suffering from feverish thirst than a draught of clear, cold water, and probably nothing more sickening than a draught of warm water.

Air, fresh and cool, is of equal importance with fresh and cool water, and with animals suffering from congestion or inflammation of the lungs it is often necessary to fix them in such a position that the cool air will reach them, as it is sometimes the case that sick animals will seek the most distant corner of the box, and get as far away from air and light as they possibly can—frequently standing with their heads close to the ground, a position in which they necessarily breathe the same air over and over again.

Light.—The question of the amount of light which a sick horse finds grateful will easily be decided by an observant attendant who notices the animal's movements. In diseases in which the eyes are affected, as they commonly are even from sympathy, a strong light is extremely irritating, and should be moderated at once, which can be easily done by fixing some kind of temporary blind to the window.

Temperature.—The temperature of the animal's body in all forms of sickness is a matter which should be attended to with the greatest care, and the regulations to this end will vary very considerably according to the season and the situation of the box in which the animal is kept.

In all febrile diseases the tendency is towards coldness of the surface

generally, and of the ears and extremities particularly. Under such circumstances it is important to conserve the heat by the application of clothing, which, if necessary, may be made to cover the whole of the animal's body. This is done by adding to the ordinary rug a hood which will cover the head down to the nostrils, with separate cases for the ears, and reaching downwards to the withers, joining the ordinary rug which should buckle across the chest (fig. 491). The further addition of flannel bandages to the

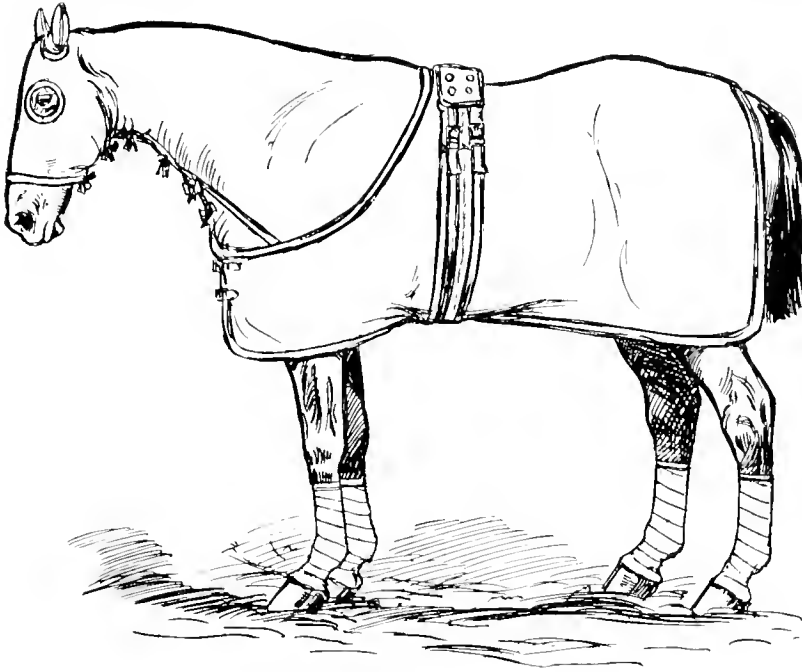

Fig. 491.—Clothing for Sick Horse

extremities will complete the clothing, which will naturally be thick or thin according to circumstances.

Grooming is very commonly entirely neglected in the case of sick horses, from a mistaken notion that it is better not to expose the surface of the animal to the open air, or to excite it by the employment of brush or wisp. This excess of precaution may be desirable during the continuance of the very acute stage of a febrile disease, and in cases generally where the animal's life depends upon perfect quiet being maintained; but as soon as the animal's condition will permit, friction to the surface should be employed daily, and two or three times a day it may be desirable to stimulate circulation in the extremities by removing the bandages and hand-rubbing the skin of the legs until warmth is restored, applying the bandages again immediately.

Exercise.—Presuming that the horse has a good roomy box, the want

of exercise will not be severely felt for some time; but as soon as it is safe for the animal to be moved out of the stable, walking exercise once or twice a day, beginning of course with a very short time and gradually increasing, will be an important aid towards the restoration of the animal's health and condition.

SIGNS AND SYMPTOMS OF DISEASE

The two terms, sign and symptom, are constantly used to express the same idea. There is, however, in reality a well-marked difference between them. A symptom is one of the characters of a disease, just as a cough is a symptom of an ordinary cold; it is also a symptom of acute bronchitis and laryngitis, as well as a symptom of what is known as broken wind; while a sign is a definite indication of a particular disease, as the presence of the tubercle bacillus is a sign of the existence of tuberculosis.

Notwithstanding the admitted difference between the signification of the two terms, they always have been, and probably always will be, used interchangeably. Strictly speaking, however, this is only justifiable when symptoms are diagnostic, in which case the term signs may be properly applied to them.

Symptoms may be described as local and general, according to whether they are limited to the diseased part or relate to the whole of the organism. They are also described as idiopathic when they arise directly from the diseased part, and sympathetic or secondary when they are due to secondary disorder. They are also premonitory and precursory when they are of a nature to suggest the advent of a disease, the indications of which are not yet defined. Thus it may occur to an attendant or to the owner of a horse that the animal has something the matter with it, but the most careful inspection and enquiry may fail to lead to the discovery of any precise morbid condition. Neither the pulse nor the breathing exhibits any special characters, and all that can be gathered from the animal's condition is the impression that it is sickening for something; and if it should be the case that influenza is prevalent in the district, the suspicion is at once aroused of the infection having attacked the animal.

Symptoms are diagnostic when they indicate the precise nature of the disorder from which the animal is suffering; for example, an attack of violent but intermittent abdominal pain is a diagnostic symptom of spasmodic colic. Prognostic symptoms include all those indications of disease which suggest the probable termination, as a failing pulse and coldness of the surface are warnings of a fatal ending to the disorder. Therapeutic symptoms are those which indicate a particular line of treatment, as high

temperature, quick pulse, and rapid breathing show the existence of fever, and point to the application of febrifuge remedies.

Symptoms which are obvious to an observer are described as objective, but when they are only expressed or described as sensations experienced by the patient they are called subjective symptoms. It is evident that in the lower animals subjective symptoms are practically non-existent, as it is rarely the case that an animal by its actions can express its sensations in such a manner as to be rightly interpreted. Again, symptoms are called dynamical when they are active or violent, and statical when they are subdued; the terms positive and negative are also used to express the same conditions.

Pathognomonic is a term used in application to symptoms which indicate a particular disease, as a peculiar cough and double action of the expiratory muscles are pathognomonic of broken wind. To the unprofessional reader these terms may appear to be unnecessarily complicated, but a little consideration will prove their usefulness as a means of saving time in description.

General Symptoms of Disease.—In order to arrive at a correct diagnosis, the skilled examiner has a certain method which enables him to obtain the information which he desires without any waste of time. Symptoms which to the amateur resolve themselves into a general expression of the presence of some illness, are to the eye of the expert in many cases distinctly indicative of the locality and nature of the disorder.

When diagnostic symptoms are absent it becomes necessary to make a systematic examination, which, although comprehensive, is carried on with so little effort and occupies so short a time as to attract very little notice from the lookers-on. For instance, beginning with the animal's head, a few seconds will suffice to enable the experienced examiner to ascertain the condition of the visible mucous membranes; a mere glance at the mouth, the interior of the nostrils, and the eye will be sufficient to show whether or not the membrane is red or yellow, or pallid or spotted, or in any way changed from its normal condition. The general attitude of the animal will have been noticed at the first moment of inspection, and the condition of the surface ascertained by passing the hand over different parts of the body and the extremities, the examiner noting whether or not the skin is in a healthy state or is harsh to the touch, adherent to the tissues beneath, hot, warm, or cold. The condition which is described as a staring coat, where the hair is more or less elevated or erect, is seen at once, and is always accepted as a symptom of bad condition, and may commonly be taken as premonitory of some serious disorder.

After a general examination of the kind described has been completed,

attention is paid to the condition of certain organs, including those of the circulatory, respiratory, and digestive systems. The state of the circulatory organs is to a large extent shown by the character of the pulse, *i.e.* the periodic expansion of the arteries, during the contraction of the heart in its effort to drive the blood throughout the body. This expansion, or beat as it is called, may be felt by placing the finger over any of the superficial arteries. The sub-maxillary artery (*a*, fig. 492) in the horse, as it passes under the edge of the lower jaw close to the bone, is a convenient vessel for the purpose. In the popular idea the object of feeling the pulse is to discover

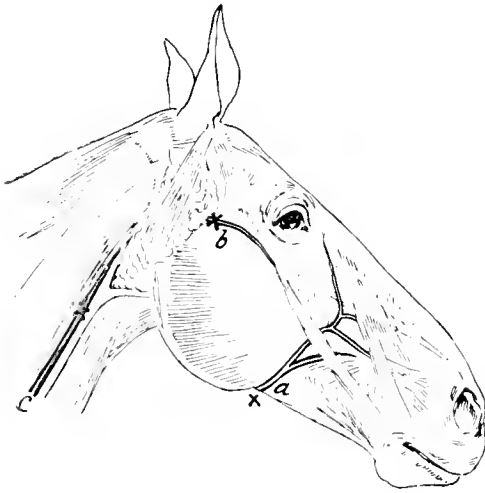

Fig. 492.—Points for Feeling the Pulse

a, The sub-maxillary artery. *b*, The zygomatic artery.
c, The carotid artery (behind the jugular vein). The pulse is felt at the points indicated by crosses, at *a* by pressing against the inner side of the lower jaw with the fingers, at *b* and *c* by pressing down upon the artery.

the number of pulsations in a minute. The pathologist, however, attaches far more importance to the character of the pulsation than to the number of beats in a given time, and it may be added that the character of the pulse varies under different circumstances to an extent which it may be difficult for the unprofessional mind to realize. Many of these variations can be recognized by the touch; their complete appreciation, however, requires the use of an instrument which is known as the sphygmograph, which enables the observer to obtain tracings showing precisely the condition of the circulation.

The varieties of pulse which can be recognized by the touch are described by Sir J. S. Burdon Sanderson in his hand-book of the sphygmograph under four heads: 1st, There is a frequent and infrequent pulse, terms which mean the number of pulsations within a given time. 2nd, The quick or slow pulse, expressions which are erroneously used to define the same thing, *i.e.* the number of beats per minute. To the pathologist the words quick and slow bear a totally different signification, meaning not the number of beats in a minute, but the time occupied by each beat of the pulse irrespective of number in a certain time; thus a quick pulse may be slow so far as the number of beats in the minute is concerned. 3rd, The large or small pulse, terms relating to the degree of dilatation of the artery in length and breadth. 4th, A hard or soft pulse, so called from the impression which the beat communicates to the touch: a soft pulse is easily compressed, while a hard pulse only gives way to considerable force.

All the above described conditions of the pulse, which can be appreciated without the aid of any instruments, convey to the mind of the expert certain ideas as to the state of the animal's system or of some particular part or organ. The frequent pulse, for instance—that is, a pulse which beats more frequently than the standard number of 40 in the minute,—in the horse indicates some degree of excitation in the circulatory system, which may depend on a variety of causes—exercise, a sudden alarm, the mere entrance of a stranger or a strange animal, may increase the frequency of the pulse within certain limits; but when in the horse the beats reach to 50 or 60 in the minute, or above, fever is obviously indicated.

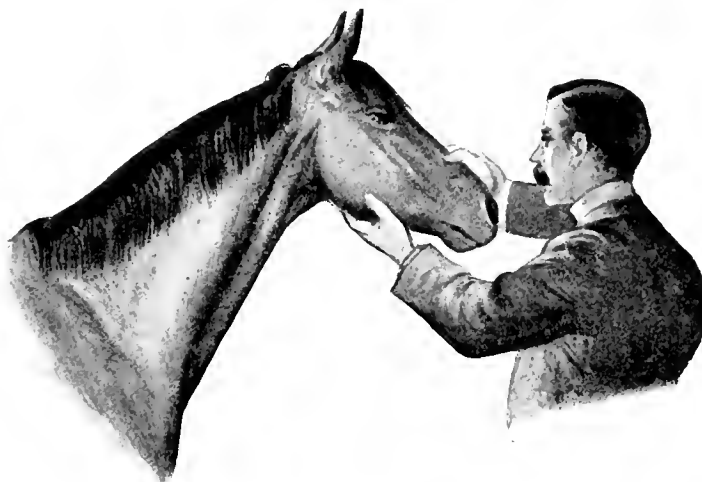

Fig. 493.—Feeling the Pulse

A very frequent pulse may, however, be associated with extreme debility; but in addition to the rapidity of the pulse in such circumstances there will be an important change in its character.

An infrequent pulse is found in diseases of the heart or brain, and in such cases the pulse is often intermittent, a condition which is extremely characteristic and easily recognized: a number of regular beats being followed by a period of rest, and then succeeded by another sequence of regular beats.

Quick pulse as distinguished from frequent pulse is more easily discovered by the sphygmograph than by the finger. It depends upon the sudden contraction of the ventricle: the expansion of the artery consequently occupies less time than in the healthy pulse, although by calculating the number of beats during a given period the quick pulse may be found to be also less frequent than the normal. The quick pulse would usually be taken to indicate excess in irritability of the muscular structure of the heart.

Slow pulse as distinguished from infrequent is due to the slow contraction of the ventricles, so that each beat is prolonged independently of the number of beats in a given time.

Reference has already been made to the sphygmograph, which is used for the purpose of obtaining a tracing of the pulse. This instrument has

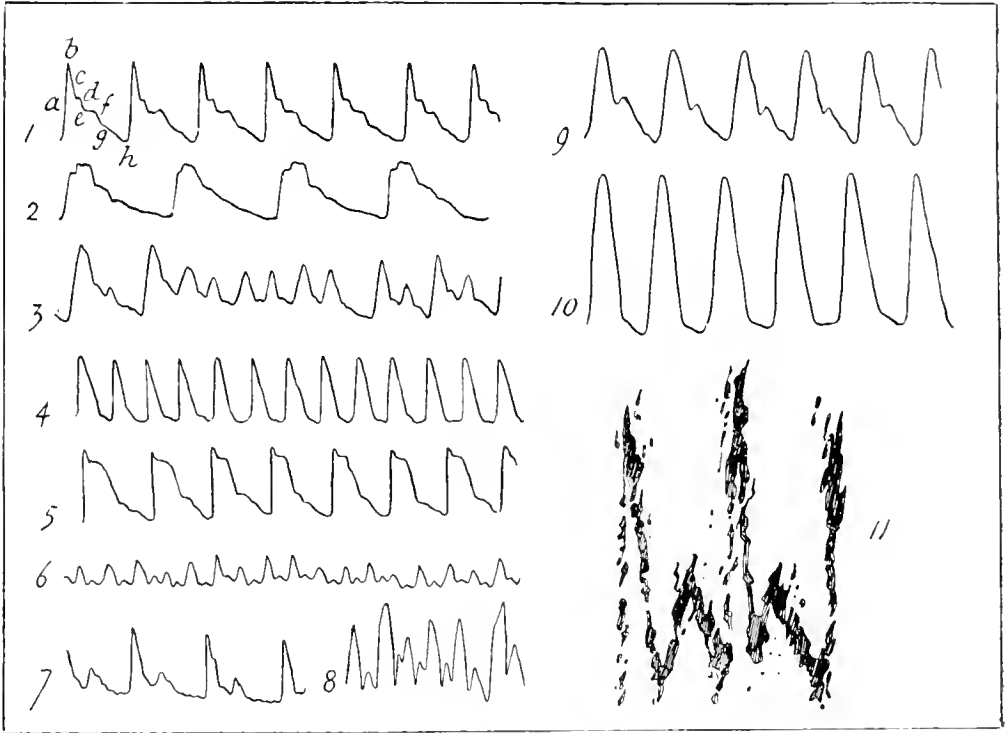

Fig. 494.—Sphygmograph Diagrams of the Pulse (after Sanderson, Dudgeon, and Steell)

In the Human Subject.—1, Normal healthy pulse; *a*, systolic wave produced by contraction of left ventricle; *b*, apex of upstroke indicating highest pressure; *c*, downstroke; *d*, first tidal or predierotic wave; *e*, aortic notch, probably indicating the end of the systolic and commencement of the diastolic action of the heart; *f*, dirotic wave due to sudden closure of aortic valves; *g*, second tidal wave; *g* to *h*, period of rest (after Dudgeon). 2, Feeble pulse of age (weak contractility of artery). 3, Senile pulse (muscle failure of heart). 4, Hard wiry pulse of rheumatic fever. 5, Hard and long pulse of hypertrophy of left ventricle with dilatation. 6, Soft pulse of irritative fever. 7, Nervous excitement. 8, Mitral and aortic disease.

In the Horse.—9, Tracing from the facial artery (normal). 10, From the same animal, after the destruction of the aortic valves, showing absence of the dirotic wave.

11, *Hematograph.* Blood spurted from a human artery received upon a revolving drum, showing systolic and dirotic waves (after Landois).

not come into use in general practice, nor is it probable that it will for some time at least replace the ordinary method of taking the pulse; nevertheless, it may be interesting to examine the above illustrations, which show very clearly how the different tracings are interpreted; and further information on the subject will be found in the treatises on the sphygmograph by Dudgeon, Steell, and others.

With regard to the respiratory system, symptoms having reference to

the number of respiratory movements in a given time, and their character, are almost as varied as are those affecting the circulatory system; thus the breathing may be quick or slow, spasmodic or difficult. Stertorous breathing is attended with a noise which may be compared to snoring. Breathing may also be irregular, sometimes being carried on by the abdominal muscles while the ribs remain fixed, and at other times by the thoracic muscles almost exclusively, as in cases of acute peritonitis. A peculiar form of the expiratory effort is exhibited in the act of coughing, the sound of which is produced by a sudden spasmodic expiration, and varies as to its character in different forms of disease; thus there are described moist, dry, and spasmodic coughs. There is also a cough which is peculiar to the broken-winded horse and to the roarer. A soft painful cough is present in bronchitis of the acute kind, and its character is so well defined that the expert will accept the sound as a diagnostic symptom. A hard, dry, or husky cough indicates the absence of mucus, a fluid which in the normal state moistens the lining membrane of the respiratory tubes, and in one stage of bronchitis, or bronchial catarrh, is secreted in excess and often assumes a purulent character. A dry cough is also a symptom of parasitic bronchitis, which is commonly on this account designated "husk".

Symptoms which are observed in relation to the digestive system are often rather obscure in their indications; diarrhœa, for example, may arise from so many and diverse causes that its presence does not materially assist the examiner in forming a diagnosis. Nervous excitement is capable of inducing it in some horses. The sight of a red coat or other preparations for the hunting-field act on some sensitive hunters much more rapidly than a dose of purgative medicine. Indigestion may be accompanied by this symptom, or the presence of parasites in the intestinal canal may produce the disorder; and it may also be the sign of a critical stage in certain febrile affections.

In the opposite state, *i.e.* constipation, the same difficulties occur in the endeavour to interpret the symptom, and in both cases it becomes necessary to take cognizance of other symptoms in order to arrive at a correct conclusion.

Diarrhœa or constipation, in association with a yellow tinge of the mucous membrane or the skin, or of both, will naturally lead to a suspicion that derangement of the liver is the primary cause. This symptom is also prognostic, as it points to the necessity of treatment being directed to the liver rather than to the digestive tube.

Disorder of the urinary organs is usually marked by obvious changes in the quantity and character of the urine secretion, and the practitioner frequently gains valuable information by observing that the secretion is

excessive, defective, or altered in character. An examination by means of the microscope and the application of chemical tests are among the means which the modern veterinarian employs to complete the evidence on which his diagnosis must be based.

It is not of course expected that the horseman will devote himself to the study of symptoms sufficiently to master the subject thoroughly, but he cannot fail to be interested in an account of the methods which are employed by professional men to arrive at correct conclusions as to the localization and pathological character of the derangements which it is their object to rectify by the use of appropriate remedies.

Special Character of Infectious Diseases.—Certain maladies which are due to the action of virulent micro-organisms, and also those in which, up to the present time, no special microbe has been detected, are distinguished from ordinary non-infectious diseases by certain features. The most prominent character of all infectious maladies, which has been recognized from the earliest times, is their tendency to render the system of the animal which they attack proof against a recurrence of the same affection for a considerable period, and in some cases for the life of the subject. Further, they are marked by the occurrence of certain phases or stages, beginning with what is called the period of incubation, by which is meant the time which elapses from the moment of infection up to the declaration of the disease, indicated by the appearance of the first definite symptoms. Following this, which may be described as the period of invasion, there is in eruptive affections a perfectly well-defined series of changes in the character of the eruption, from its first appearance to its decline. Small-pox furnishes the most typical instance of these changes, which begin with the appearance of papules or pimples (papulation). The effusion of serous fluid beneath the cuticle converts the red pimples into vesicles (vesication), subsequently the contents of the vesicles become purulent (pustulation), and at last dry up and form a scab (desquamation), which ultimately falls off, leaving an eschar behind it (pitting.) These changes occur at intervals on an average of something like three days.

In infectious diseases which are not eruptive the stages are not so definitely marked, but there is always the period of incubation, followed by invasion indicated by febrile symptoms, then the progress to the acute stage, and the gradual subsidence of the disorder to the period of convalescence, or, on the other hand, the increase of the energy of the attack until a fatal result occurs.

Another peculiarity of infectious diseases is their refractory character in reference to remedial measures. Medicines are for the most

part of little or no value in controlling the progress of these disorders, and it is recognized as an axiom in the treatment of all such affections that the aim of the physician should be to maintain the patient's strength to enable him to resist the effects of the malady during its progress, which it is admitted cannot be arrested.

The recognition of the fact that an attack of an infectious malady exhausts for a certain period the susceptibility of the system, very early led to the adoption of inoculation as a means of controlling the virulence of the disorder, and, further, of causing the attack at a period when it might be considered to be of least importance. When the inoculation was properly performed, even in a virulent disease like small-pox, the resulting attack was generally very mild in its character. The extremely minute quantity of the virus which was employed had a great deal to do with the more benign character of the infection, and the operation had further the advantage of enabling the operator to determine when the disease should be produced, and selecting a period when the patient was in the most favourable condition. The one insurmountable objection which presents itself, both in regard to man and the lower animals, is the danger of communication of the inoculated disease to susceptible subjects, who are as likely to suffer from a severe or fatal attack as if they had taken the affection from the most virulent case. The discovery of certain microbes which were proved to be the cause of disease, and the results of artificial cultivation in modifying this virulence, turned the attention of pathologists to the subject of protective inoculation by means of the ameliorated virus, which was found to produce an extremely mild form of the disease and to confer immunity with a very slight amount of risk. This method of protection has been tried with a certain amount of success in anthrax, and in the disease which is known as Blackleg in young cattle. In this country the system was not at first favourably received; accidents occurred among inoculated animals which led to losses as great as would in ordinary seasons occur in the unprotected. Improved methods of preparation of the virus, and simpler means of inoculation, have since been attended with a large measure of success.

For a long period there was only one infectious disease—glanders—to which the horse was believed to be subject, and in regard to this affection its infectious origin was frequently disputed. Of late years the progress of the science of bacteriology has led to the addition of a number of diseases which are classed as infections, the term being now understood to include disorders the virus of which may, according to some authorities, be generated in the organism instead of being introduced from the outside. This view, however, of auto-infection is not capable of

demonstration, because it is impossible to prove that the infection has originated in the organism, in face of the fact that the atmosphere is capable of conveying the spores of bacteria into the animal's body. The following diseases of the horse in the present day, among others, are included in the term contagious, infectious, or epizootic affections:—Anthrax, variola (horse pox), tetanus, pyæmia, malignant œdema, contagious stomatitis, purpura, strangles, influenza, contagious pleuro-pneumonia (which belongs to the influenza group), cerebro-spinal meningitis, tuberculosis, and certain affections of the skin, as mange, ring-worm, and epizootic lymphangitis, depending on the invasion of animal or vegetable parasites.

PREVENTION AND SUPPRESSION OF INFECTIOUS DISEASES

Prevention.—Preventive measures are of the utmost importance in relation to all diseases. They have a special value when directed against infective disorders on account of the peculiarity which those maladies possess of extending the area of their prevalence, unless severe restrictions are imposed upon the movement of diseased or infected animals, and even of persons or substances which have been in contact with them.

Prevention naturally occupies the first place in dealing with infective diseases; its immediate object being to oppose, as far as possible, their introduction into a country or a district.

The measures of suppression can only be employed when the disease has been introduced, and it becomes necessary to check its progress. Preventive measures in relation to the infective diseases of the horse must necessarily be limited in the majority of cases to individual action, as all the maladies which have been named already exist in the country, and every purchaser of a horse incurs a certain amount of risk of introducing an infected animal into his stables. Glanders appears to be the only affection which could be consistently dealt with by any restrictive enactments against the entrance of animals from those countries in which the disease is known to exist. The horse-owner may, however, protect himself by the exercise of care in the selection of fresh animals, and further, by enforcing a certain period of quarantine on his own premises, for the purpose of satisfying himself that the animal is free from the more common infective diseases, such as those which belong to the catarrhal group—influenza and strangles, for example. It is also possible for him to ensure perfect cleanliness and thorough disinfection, and he can avoid purchasing second-hand harness, clothing, brushes, buckets, or any apparatus used about the stable; or at least, in the event of such things being introduced, it is not difficult to have them properly

disinfected. It is also important for the horse-owner to recognize the added risk which horses incur of contracting disease when they are affected with cracked heels, abrasions of the lips, and generally any wound on the surface which may give access to the infective matter of glanders, strangles, tetanus, and other infectious diseases.

Away from home, the horse is exposed to fresh dangers which can hardly be averted. It may be true that the risks associated with public stables and water-troughs are exaggerated, but there can be no doubt that some risk has to be faced every time advantage is taken of such convenient arrangements.

In respect to horse-boxes on railways, complaints have been loud and deep that no provisions have been made for proper cleansing and disinfection, and that in consequence a sound horse may be put into one from which a diseased horse has just been taken. This may be done, but only in defiance of the law which has been in operation for many years past, and is generally enforced on all the railways in the country. The order provides that the floors of horse-boxes shall be thoroughly swept and scraped, as also all other parts with which the droppings of any horse, ass, or mule have come in contact. The sides of the horse-box and all other parts thereof with which the head or any discharge from the mouth or nostrils of any horse, ass, or mule has come in contact shall be thoroughly washed with water by means of a sponge, brush, or other instrument.

All the above-named steps are to be taken on every occasion after a horse, ass, or mule is taken out of a horse-box and before any other horse, ass, or mule, or any animal is placed therein.

That the provisions for cleansing and disinfecting horse-boxes are not universally appreciated may be gathered from the circumstance that complaints have been made by hunting-men of the use of water in cleansing horse-boxes on the ground that when a horse comes in from a run he wants a dry, warm box rather than a damp one, which being admitted, it nevertheless follows that proper cleansing is not possible without the free use of water.

Suppression of infective diseases implies the adoption of measures more or less stringent, according to the character of the disease. First in order stands the so-called stamping-out system, which includes slaughter of diseased and infected animals, or in place thereof perfect isolation, which would be equally effective if it were not that it is almost impossible to ensure it. In cases of disease which terminate fatally in the majority of instances, slaughter does not imply any great sacrifice, but in other infective maladies which ordinarily end in recovery isolation would naturally be substituted, and it may be here useful to suggest some of the precautions

which the effectual adoption of that system involves. The first requisite is a box which is entirely disconnected from other stalls or boxes, by which, of course, is meant that the walls and boundaries—no matter of what material they may be composed—although as a matter of course brick walls properly cemented so as to obtain a smooth surface are preferable to any other material—should extend from the floor to the ceiling; the entrance door should be also solid, light being admitted by a properly arranged window, and ventilation provided for as far as possible by openings in the ceiling. Next, all the appliances which are necessary in the feeding and general management of the animal should be kept in the box; and further, the man attending on the sick beast should have a waterproof covering which he can put on when entering the box, taking it off and leaving it in some convenient place as he comes out. It may seem hardly necessary to suggest that washing his hands in a disinfecting fluid and cleansing and disinfecting his boots are simple matters of precaution which commend themselves to common sense, and cannot possibly be omitted without definite and incalculable risk being incurred of spreading the disease.

During the time that a sick animal is kept in the isolation-box the free use of disinfectants is to be recommended. In the present day there are disinfectants which possess no odour, which can be used without giving offence to the most delicate nostrils, so that the common objection to their employment is easily disposed of. As soon as an animal has recovered, and is considered to be sufficiently well to leave the box, thorough cleansing and disinfection will necessarily follow. The procedure will not materially differ whether the animal has been slaughtered in consequence of having been affected with glanders or has recovered from an attack of influenza or strangles; in the latter case, however, it would not be unreasonable to disinfect the animal itself, immediately it comes outside the box, by sponging it over with a solution of Chinisol, and thoroughly washing its feet.

In regard to the box from which a diseased animal has been taken, the litter which has been used during the time of its illness, instead of being carted away for manure, should be taken to a convenient place to be burnt, or, this being impossible, it should be thoroughly mixed with quicklime; the floor, after being sprinkled with lime should be thoroughly swept, and the walls and all parts of the box should be thoroughly washed with hot water in which a liberal quantity of washing-soda has been dissolved. This preliminary washing is perhaps the most important part of the whole process, and no amount of disinfection can compensate for its neglect. In a properly constructed isolation-box the rack and manger and water-trough would all be made of iron, and therefore could easily be cleansed and disinfected; but if the animal has been kept in a place where wooden racks and

mangers are used, the most effective measure would be to have them pulled down and burnt, especially if the wood-work is in any way damaged, and the same course would be wisely adopted with regard to brushes, buckets, sponges, rubbers, and any other apparatus which has been used about the diseased animal.

After the sweeping and washing have been thoroughly done, all parts to which the cleansing process has been applied should undergo disinfection, and there is no doubt whatever that fumigation with chlorine gas, or sulphurous acid from burning sulphur, is the most effective means which can be adopted; but to be perfectly effectual the place must be so arranged that it can be completely closed while the gas is being disengaged. The ordinary sulphur candle supplies a convenient and satisfactory means of filling a place with sulphurous acid gas. Chlorine may be most readily set free by filling some common dinner-plates with a mixture of common salt and peroxide of manganese, and then pouring over the mixture ordinary commercial hydrochloric acid. As soon as the gas commences to escape, either from the sulphur candle or the mixture of salt and manganese, the door should be closed and the place left for twenty-four hours. The disinfection may be completed by applying to the floor and walls and all parts of the box a solution of any of the numerous disinfectants which are in use. Carbolic acid is most commonly employed, and in a mixture with twenty or thirty parts of water is very effectual for the purpose.

A place which has been properly disinfected should be fit for use for another animal as soon as the walls are dry, and this statement will answer the question which is commonly put as to the length of time which ought to be allowed before infected premises are again used for keeping animals. Clearly it must be the case that if the infected matter has been thoroughly destroyed or removed, time is a matter of no consequence, and if the process has been imperfectly done, and active infective matter is still left, it is impossible in many cases to say how long it may remain active. In fact, it would be necessary to make a different calculation in regard to each infective disease. Most probably the duration of the life of many kinds of virus discharged from diseased animals is brief, otherwise infective disorders would be more rife than they are. There are, however, always ready for quotation, stories of the wonderful vitality of infective matter, and it is at least satisfactory to keep an animal out of a place where microbes may possibly lurk until the danger may reasonably be regarded as a thing of the past.

A more serious difficulty is the want of proper appliances, in most private premises, for isolation and disinfection, and, further, the failure on the part of the owner and the attendants to realize the necessity of minute

attention being paid to each detail of the cleaning and disinfecting process, whereas the smallest blunder may render the whole procedure useless.

It will probably be a subject of enquiry what is the best course to be pursued in instances when, from the construction of premises and other circumstances, it would be absolutely impossible to carry into effect in their entirety the means which have been recommended, and the answer can only be in effect what is provided in orders relating to disinfecting and cleaning processes, viz. that where the premises cannot be disinfected, as in the case of a field, for example, in the manner directed, it shall suffice that they be disinfected as far as practicable.

27. OPERATIONS

MEANS OF RESTRAINT

Dealing with animals like the horse, of high nervous organization, great strength and activity, and often considerable weight, it is sometimes necessary to employ means of restraint whereby operations of greater or



Fig. 495.—Twitch applied

less severity may be performed. Minor ones can often be accomplished under the restraining influence of the voice alone; and in this connection it may be remarked that it is given to some men to exercise great authority over the brute kingdom, while a want of tact and judgment would seem to preclude others from ever attaining such a desirable influence.

Some of the means employed for this purpose are mechanical, others physiological, and in their application may be confined to a limb, or to one portion of the animal, or applied to his whole body. By superior force the animal is rendered incapable of resistance, and the same may be effected by the administration of drugs which overcome consciousness and paralyse movement.

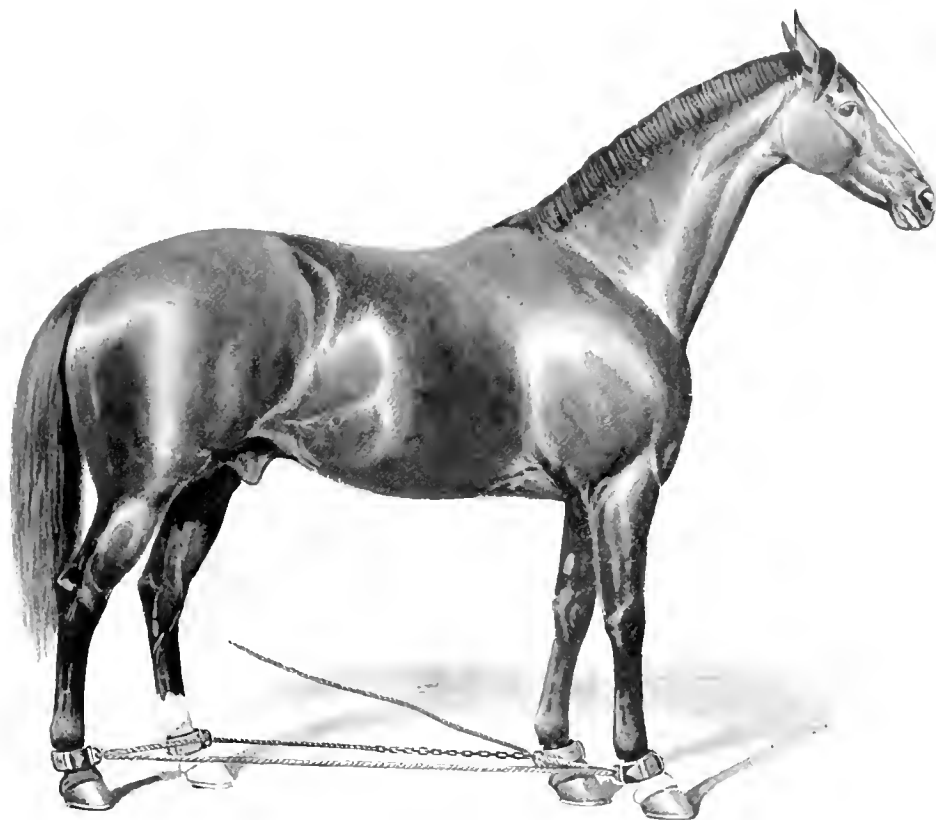

HORSE HOBbled

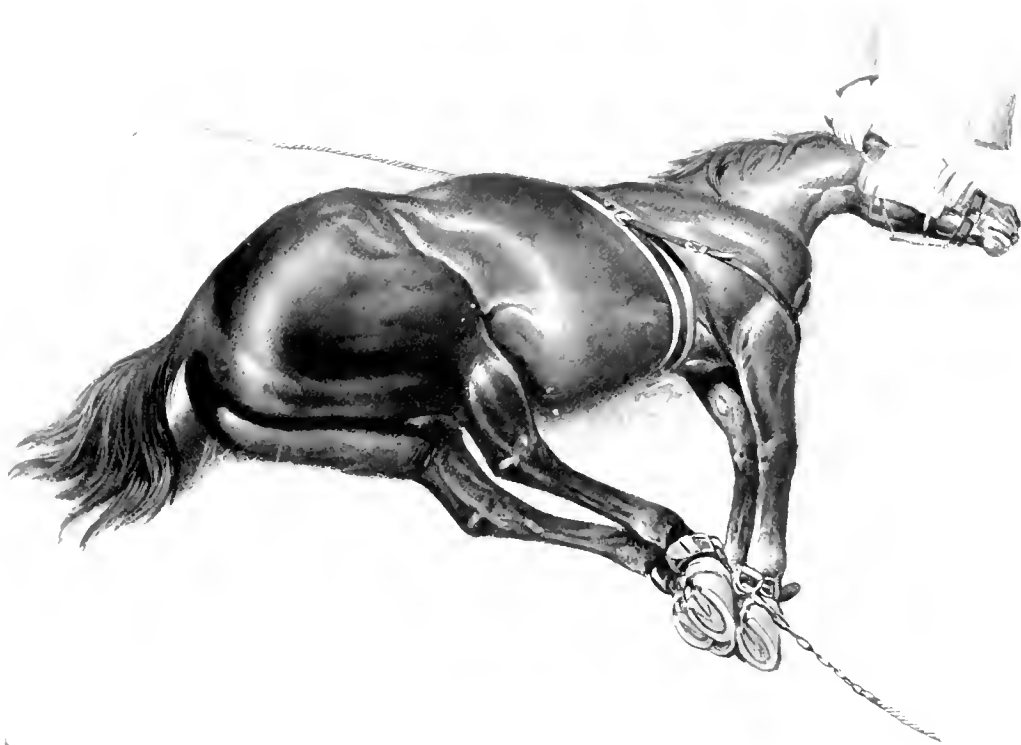

HORSE CAST

The **twitch** is a simple and effectual appliance by which a horse may be induced to submit to some trifling operation. It is, however, too often resorted to in many stables in lieu of gentler methods of persuasion.

This instrument consists of a loop of stout cord attached to a strong stick by means of a hole an inch or two from the end. In applying it the loop is placed on the horse's upper lip, and the stick is then twisted until sufficient force has been applied to overcome resistance (fig. 495). It is sometimes applied to the ear and tongue. The ear is liable to be permanently injured by it, and the practice of twitching the tongue is so cruel, as well as dangerous, that it cannot be too strongly condemned.

As soon as the twitch is removed from the lip, the latter should be gently rubbed with the palm of the hand, as this gives relief to the horse, and his gratification is evident by his manner.

Holding up a leg will be a sufficient deterrent in many cases where a restive animal will not otherwise submit to be handled.

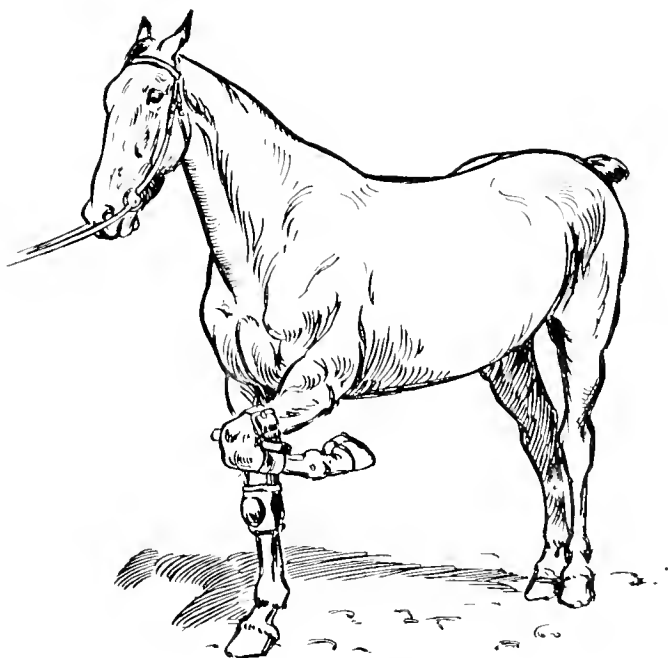

Fig. 496.—Fore-leg strapped up

If strapped up with a stirrup-leather—a method of restraint to be remembered in emergency (fig. 496)—knee-caps should not be forgotten, in anticipation of a fall.

Restive horses are sometimes induced to take medicine, or remain quiet while a hay seed is being removed from the eye, or some other simple operation is performed, by inserting the running portion of a hemp halter under the upper lip while the head piece is passed over the poll; any resistance made by the animal while so secured increases the amount of punishment and causes him to desist.

Attaching the head to the tail is one of the breaker's means of securing obedience, but is rarely applicable for the purposes of medication or minor surgery, so that we need not particularly describe it. The bag of

corn which the breaker finds useful in the case of determined rearers is also of service in the stable when a horse refuses to be drenched or "balled" and strikes out with his front legs.

Here an ordinary corn sack is about half-filled with heavy oats or maize, and the ends firmly secured to a harness collar (previously put on the animal's neck) in such a manner that the contents are suspended in front

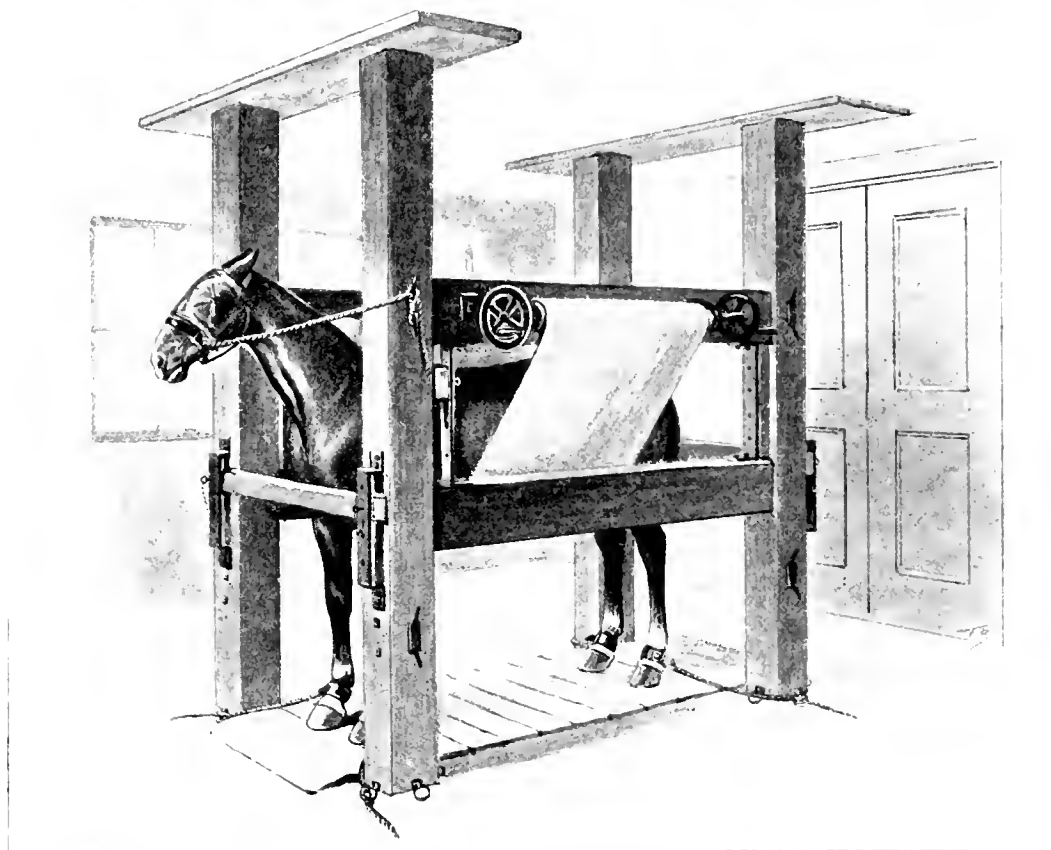
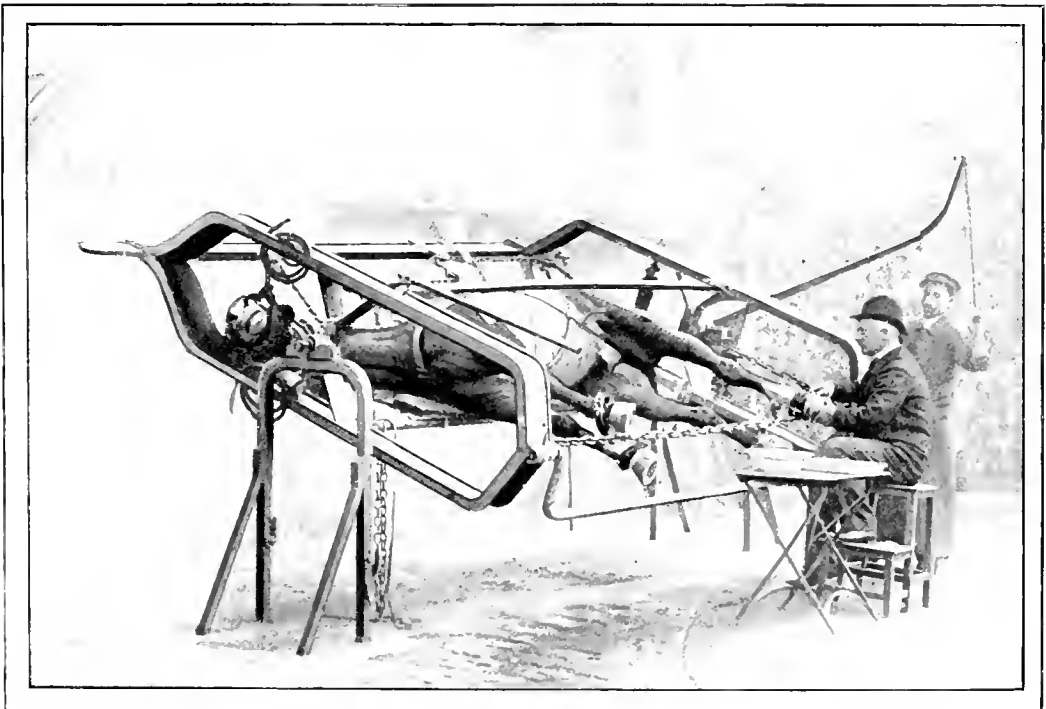
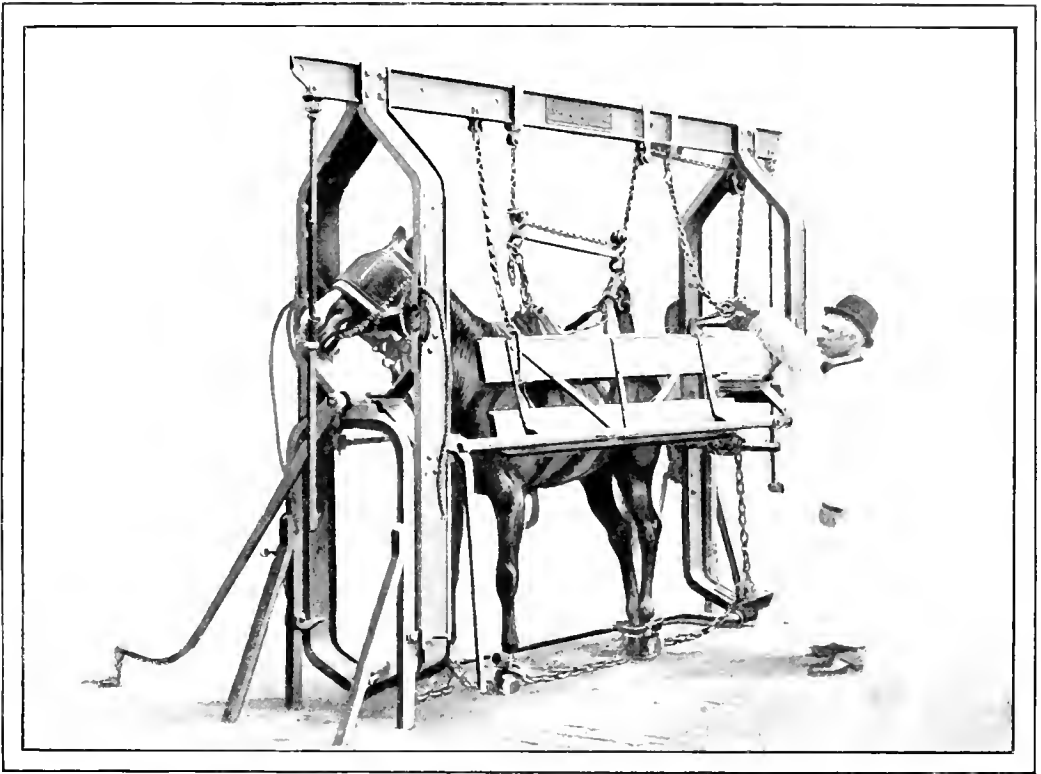

Fig. 497.—The Travis

of the creature's knees. He cannot strike, and it is with difficulty he can rear.

The horse-hair crupper is a useful restrainer, but belongs rather to the cure of vice than that of disease.

The **travis** (fig. 497)—a fixed apparatus seldom seen at the present day, though in general use formerly at all country smithies—is an arrangement of posts and rails, in length rather less than that of a horse's body, and in width only sufficient to permit those of large size to enter. By means of bars, straps, and cords a restive animal can be secured in a variety of



VINSOT'S OPERATING TABLE

attitudes, but the patient is liable to injure himself while struggling, and for this reason the traviis has to a great extent fallen into desuetude.

The **side-line** is a useful and humane appliance, having few objections, although, like all other methods of securing a horse, it is not wholly free from danger, either to the animal or attendants.

A single and a double side-line are recognized among those in the habit of operating upon animals. The former consists only of a long rope passed round the neck and fastened in form of a collar, the free end being carried between the hind-limbs and into the hollow of the heel, whence it is brought round to the front, and looped or fastened by a "half hitch" to the collar portion again.



Fig. 498.—Side-line

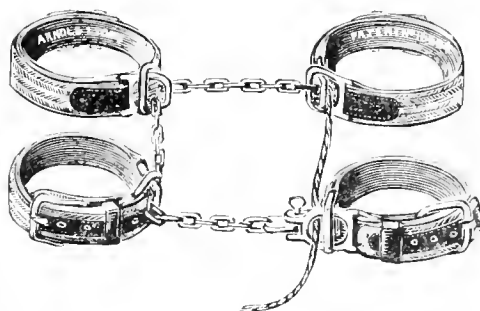

Fig. 499.—Hobbles



Fig. 500.—Cross Hobbles

The hind-leg can in this way be brought forward, and the horse prevented from kicking on that side.

The double side-line is employed in the same way on both limbs, but in addition it is also used to cast and firmly secure an animal on the ground. A common wagon rope is all that is necessary, but very much more convenient lines are now supplied by veterinary instrument makers. They are provided with eyes through which the rope ends are made to pass, with a minimum risk of either rubbing the skin or drawing the line too tight (fig. 498. See also Plate XLIII).

Hobbles.—This term may be employed to describe the apparatus used by veterinary surgeons for casting and securing horses on the ground. It consists of stout leather straps with steel eyes and buckles, and a specially made rope terminating in a few feet of chain, where the principal strength is required (figs. 499 and 500). The subject may be cast on either side or

readily turned over, when down, from one to the other. The accompanying illustrations give an idea of the *modus operandi* of casting (Plate LI). The horse to be cast is first made to stand with all four legs close together; the rope is then drawn up tight, the leading man standing near to the fore hobble, and at the word of command the three or four men engaged on the rope pull together in an outward and backward direction. To ensure the animal falling on the side opposite to that on which the men are pulling, another rope is usually attached on the falling side to a surcingle or else under the opposite arm, and given into the charge of one who can be depended on to exert the necessary power when the right moment arrives. When down, the rope is prevented from running out, and the horse from moving his legs, by a spring hook (fig. 501) being inserted between one of the links of the shortened chain, while

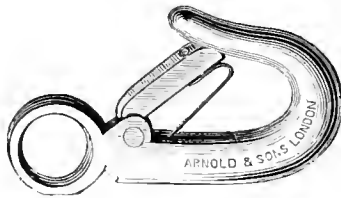

Fig. 501.—Spring Hook for Hobbles

his head is held back and pressed upon the ground. A piece of old pasture is the most convenient and at the same time safest bed upon which to cast animals, but where this is not procurable, a thick bed of straw answers the purpose equally well.

For the more important operations, and especially in well-equipped stables, an operating-table, such as that illustrated in Plate LII, is of course desirable, though not by any means essential.

The physiological means of restraint have been incidentally referred to in other parts of this work, notably that dealing with the subject of local and general anæsthesia.

For minor operations cocaine is one of the most valuable of recently discovered anæsthetics. By its aid we may perform minor operations upon the eye, the mucous membranes of the mouth, nostrils, &c. By injecting it under the skin, even such severe pain as that inflicted by firing can be obviated, and the patient made to stand during the operation. A solution containing from 4 per cent to 10 per cent of the drug is commonly employed, whether for painting on a mucous membrane or injecting subcutaneously, and up to about 15 grains, there is absolute safety. No greater amount should be used at any one time except under professional direction. (See ANÆSTHESIA, Vol. II, p. 479).

NEUROTOMY, NEURECTOMY, UNNERVING

The operation known by the above terms is undertaken with the object of depriving some part of an animal of sensation when affected with an incurable disease. It is resorted to in cases of navicular disease, of side-bone, ring-bone, and other forms of lameness of a chronic and painful character, more especially in the region of the feet.

Unnerving, although always effective in depriving the part of sensation, is attended with a varying measure of success, largely dependent upon the judgment of the surgeon. If undertaken upon a subject of navicular disease, for instance, it is important that the foot shall have sufficient strength of horn to receive the nails, without risk of binding or pricking in the course of shoeing. When deprived of sensation, injuries of this kind are not recognized by the horse, and he continues to use the diseased and unfeeling foot without that care which he would otherwise take of it, and without showing any signs of lameness. The presence of corns, which may fester in a foot deprived of sensation, is another element of danger, since in the absence of pain and lameness it is liable to pass unnoticed, until irreparable mischief is wrought. It is, however, an error to suppose that reparative power is lost when the purely sensory nerves are divided. If a pricked foot or one with a festered corn is detected before serious inflammatory changes have taken place, recovery may be looked for, if judiciously treated.

Neurectomy, if performed on suitable subjects, is undoubtedly a valuable operation, and may add two or three years or more to the usefulness of an animal.

Methods of Operation.—The operation is distinguished topographically as the *high operation* and the *low operation*. These terms are somewhat confusing to the beginner, as there is another neurectomy frequently performed, but adopted much later. It is called *median*, and is the highest on the limb, the median nerve being situated on the inner aspect of the forearm as shown at Fig. 502. For the present the old nomenclature must be retained. The high operation consists in division and removal of a portion of the trunk of the plantar nerve immediately above the fetlock. Here it runs a little to the front of the border of the back tendons (fig. 502), and, being immediately beneath the skin, affords the surgeon facilities for division without the risk of injuring other structures. It is rather more superficially placed on the outside, and as its bifurcation takes place somewhat lower down than on the inner side, the incision in the skin may be made a little farther down the limb in the former than the latter. It is usual to divide both nerves, though not always necessary, as, for

instance, when side-bone exists on one aspect of the pastern only. Moreover, by leaving the nerve of one side intact, the foot will continue to enjoy a certain amount of feeling, which will not only give security to the animal's movements, but ensure some degree of caution in the use of the limb, which will be to the advantage of the neurotomized half of the foot.

It is necessary to cast the animal prior to operation, and if total anaesthesia is to be produced, a period of some fifteen hours' fasting is recom-

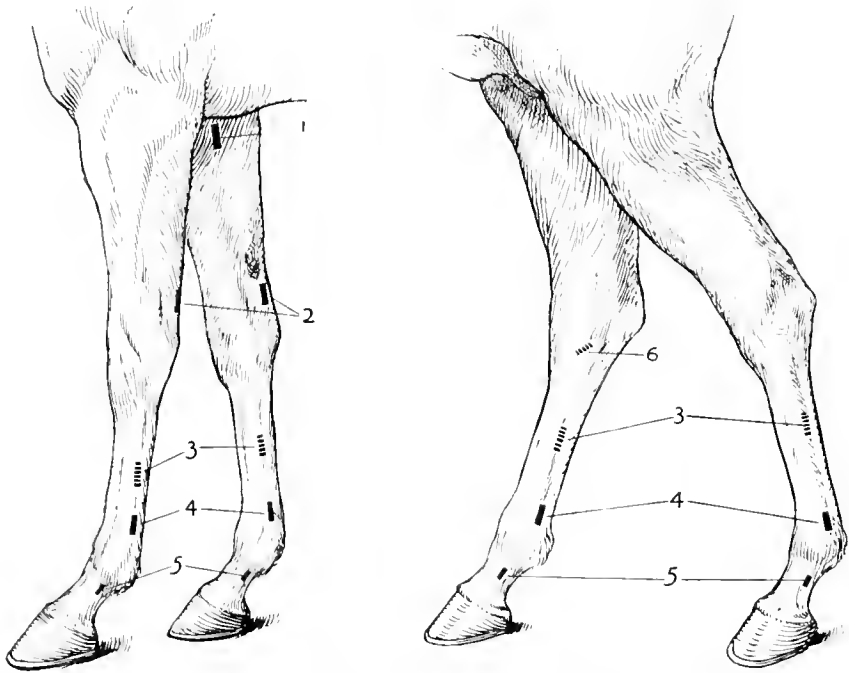

Fig. 502.—Tenotomy and Neurectomy. Localities of the various operations

- 1, Median neurectomy. 2, Neurectomy of the ulnar nerve. 3, Tenotomy of deep flexor tendon. 4, High plantar neurectomy. 5, Low plantar neurectomy. 6, Cunean tenotomy.

mended; indeed, fasting by way of preparation for throwing is by many veterinary surgeons considered a necessary precaution against risk of rupturing some of the abdominal organs, especially the stomach and bowels.

If, immediately the horse is cast, the precaution is taken to apply a powerful india-rubber band (with hook-and-eye) to act as a tourniquet, bleeding from the wound is prevented, and the operator has no difficulty in dissecting the nerve from its surroundings.

The site of the operation is closely clipped, and washed with soap and water, and afterwards dressed with an antiseptic, the same precautions being taken in respect to instruments and appliances to be used. A longitudinal incision about three-quarters of an inch in length is then made with a sharp scalpel, and the underlying connective tissue divided until a clear

view of the nerve is obtained. A blunt-pointed needle (fig. 503, and Plate LIII, fig. 2) with an eye in it is then passed under it. While so placed, the end of a piece of carbolized silk or gut is passed through the eye of the needle and drawn back under the nerve, which may now be raised from its bed and divided by a pair of blunt-pointed scissors. The chief difficulty attaching to this rather delicate operation is to recognize the nerve when exposed, and to distinguish between it and the artery which runs alongside of it. In old horses, the victims of many blisters, these two structures are somewhat firmly attached together, and require careful dissection.

Three-quarters of an inch of the nerve trunk must now be removed from that portion connected with the foot. Then the wound must be irrigated with an antiseptic, and covered with a pad of cotton-wool supported by a clean linen bandage, and subsequently treated by the ordinary antiseptic method.

Many modern practitioners who are adept at this operation make a transverse incision, and cut down upon the nerve with very little disturbance of the adjacent tissues. The nerve is divided by means of a combined needle and knife (fig. 504). In order to remove a sufficient length of it, through an aperture no more than half an inch long (fig. 505),



Fig. 503.—Neurotomy Needle

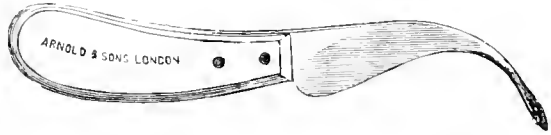

Fig. 504.—Neurotomy Needle and Knife combined



Fig. 505.—High Plantar Neurectomy by Transverse Incision

the insensitive end that has just been divided is picked up by strong pliers, and pulled out until sufficient is exposed for removal, as above advised.

Next in frequency of performance is the low operation, in which the posterior branch of the plantar nerve (fig. 502) is divided as it passes along beside the perforans tendon, midway between the fetlock and the coronet. The mode of procedure is the same as that described for the higher neurectomy. It is sometimes resorted to in navicular and other diseases of the posterior part of the foot, but it is not so uniformly successful as when the



Fig. 506.—Low Plantar Neurectomy. Raising the digital nerve by an aneurism needle threaded with carbolized silk or gut



Fig. 507.—Low Plantar Neurectomy. Severing the digital nerve held out by carbolized silk or gut

main trunk is divided above the fetlock. It has the advantage, however, of leaving a certain degree of sensibility in the front part of the foot, which greatly adds to the safety of the animal's movements. Dealers in unsound horses are much in favour of the low operation, as the scar resulting from it is not readily seen, and the unwary are in this way imposed upon.

Median neurectomy (fig. 508) is sometimes performed for the relief of lameness affecting some part of the limb from the fetlock upwards, such as that arising from "knee splints" and other ossific depositions which have not yielded to ordinary measures of treatment. Division of the ulnar branch (fig. 509) is also practised for removing sensibility of parts at the back of the knee.

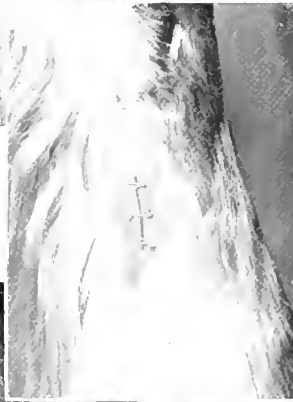

NEURECTOMY: THE HIGH PLANTAR OPERATION

1. Making the Incision. 2. Needle passed below the lateral digital nerve and threaded with catgut or silk or gut.
3. Severing the Nerve. 4. Removing portion of the Nerve. 5. The Operation completed.

Neurectomy has also been resorted to in the case of spavin, when all other treatment has failed, but not with satisfactory results.

Horses which have been unnerved, although free from lameness, usually give some indication of the fact. When the hand is passed over the site of operation the foot is sharply raised as though the animal had been asked to hold it up, or the horse flinches on the application of slight pressure over the nerve end, which always remains sore for some time after division. In many cases a nodule of more or less hard material forms on

the end of the upper division of the nerve, which can be felt on either side of the leg where the incision was made. When these exist they form serious ground of suspicion as to neurectomy having been performed, and all that is needed to settle the point is a few pin-pricks over the pastern. If the nerves have been divided there will be no snatching up of the foot, as occurs when sensibility of the skin is intact.

Sequelæ.—Some of the consequences of neurectomy have been incidentally alluded to: gelatinoid degeneration of tendons, sloughing of the hoof by undiscovered suppuration arising from pricks, wounds, corns, &c. When the operation has been resorted to for navicular trouble, the diseased bone will sometimes fracture or the flexor tendon passing under it becomes excoriated, its fibres soften, and rupture under the weight imposed upon them; the toe turns up, and the

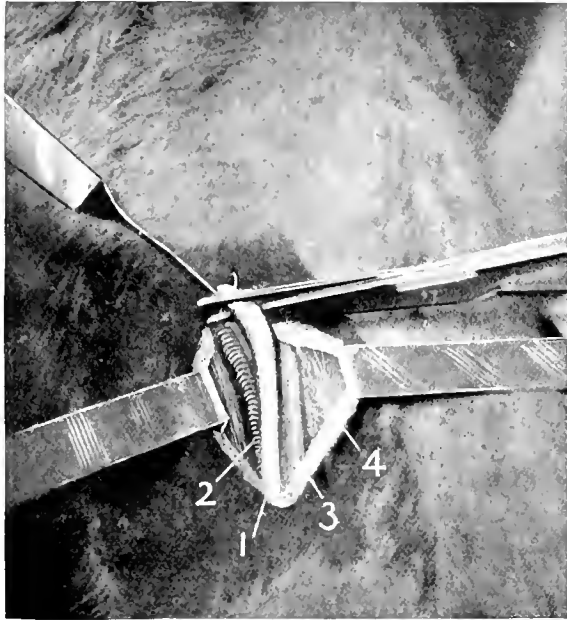

Fig. 508 — Median Neurectomy

- 1, Median nerve. 2, Brachial artery. 3, Brachial vein.
4, Ante-brachial fascia.



Fig. 509 — Neurectomy of the Ulnar Nerve

flexor tendon passing under it becomes excoriated, its fibres soften, and rupture under the weight imposed upon them; the toe turns up, and the

hindmost portion of the heel comes to the ground. A swelling now appears round the coronet, a bulging is seen in the hollow of the heel, and ultimately the hoof sloughs away and the end has been reached.

FIRING OR THE ACTUAL CAUTERY

Firing has been referred to, in other parts of this work, as an indispensable operation for the cure of lameness, while the actual cautery has also been advocated for the treatment of other forms of disease.

In veterinary practice the term "firing" has by common consent been applied to operations upon the limbs, as distinct from the use of the actual cautery for the destruction of morbid tissues, the arrest of

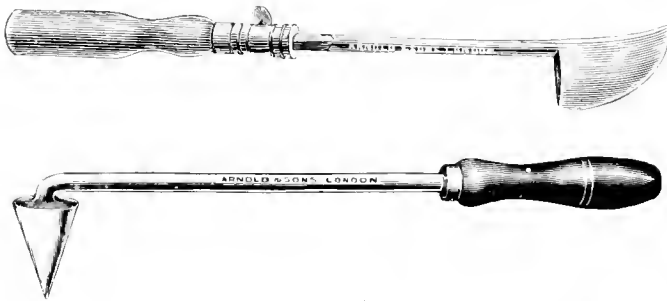
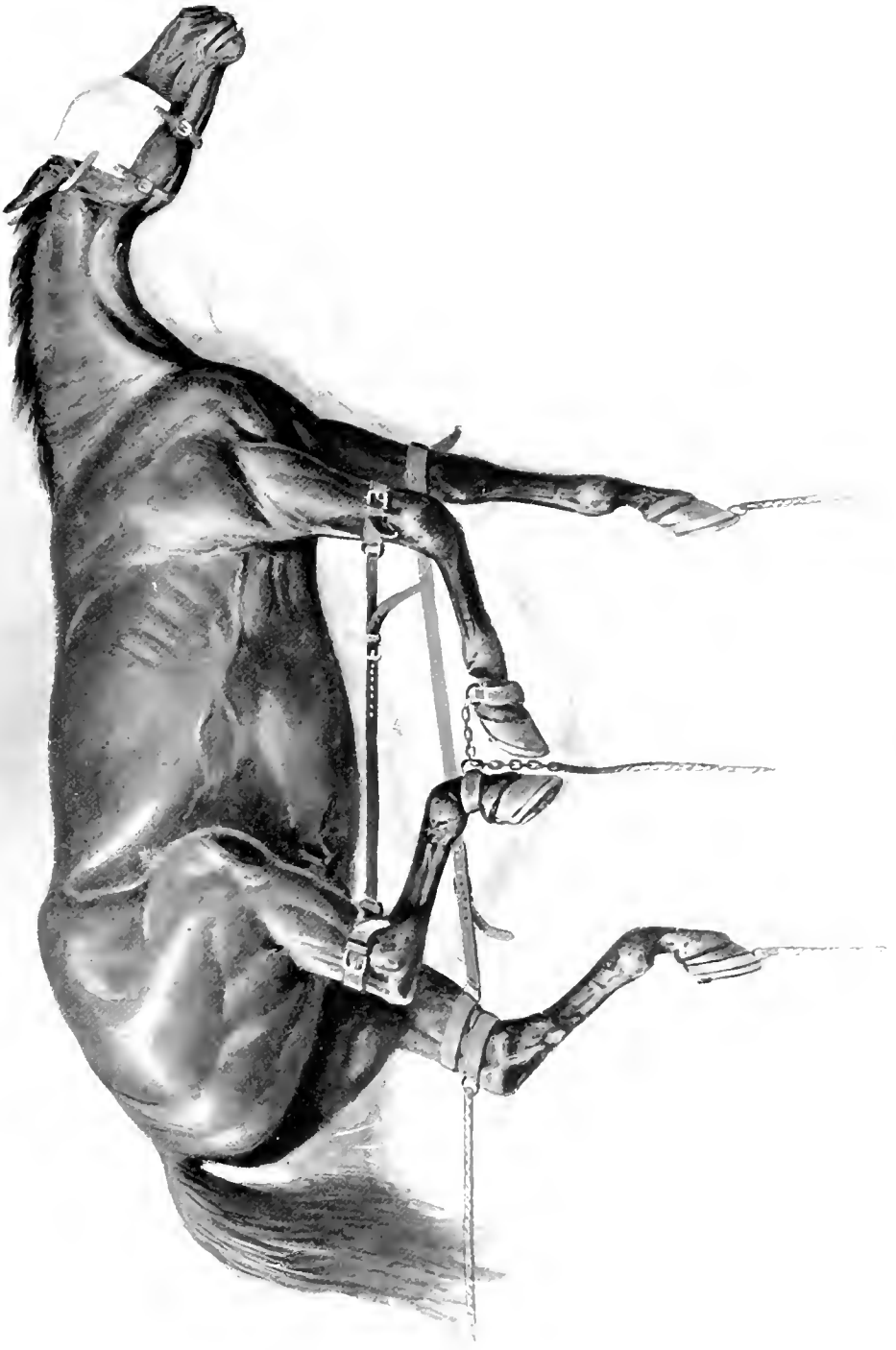

Fig. 510.—Firing Irons

hæmorrhage, or the severance of organs (as in castration). In the former case it is employed with two principal objects, namely, the excitation of superficial inflammation outside, but as near as possible

the seat of injury or abnormal growth, and by its subsequent thickening and contraction of the skin to afford an abiding support unobtainable in any other way. No humane man can witness the operation of burning the living tissues without pain to himself, and it is a matter for congratulation that not only is firing much less practised at the present time than formerly, but the more general use of chloroform by veterinary surgeons has deprived the operation of all unnecessary suffering. Since the necessity of firing is admitted by the best-informed as well as the most humane practitioners, we need not stay to defend the practice, but proceed briefly to describe the methods. Whether the operator proposes to fire in straight lines, on "feathers", "diamonds", "lozenges", or to make punctures with a pointed iron, the preparation will be the same. The part of the limb to be fired should be closely clipped, or the skin will be scorched by the burning hair, and the smoke and charred remains will obstruct the view of the surgeon and prolong the operation.

It is usual to cast the patient with hobbles (Plate LIV), but many men, expert by long practice, succeed in making a fairly good pattern with no greater restraint than that afforded by the twitch, and a front or hind limb held up. Cocaine, injected by several punctures a few



HORSE CAST FOR FIRING

minutes prior to operating, undoubtedly reduces the pain to the animal, and risk to the surgeon who undertakes to fire while the patient is standing. Plain lines about three-quarters of an inch apart probably answer quite as well as the most artistic patterns where the firing is intended to act upon a considerable area, as, for instance, in broken-down ligaments and tendons; but in the case of bony growths, as spavins, side-bones, and splints, punctures may be made with a fine-pointed iron (fig. 511) heated in a fire, or by an aluminium point heated by spirit vapour, as practised in the use of the thermo-cautery. Whether an iron or aluminium instrument is used, the acting surface of the implement should be slightly rounded at the edge, and applied in such a manner as to burn until a dull white appearance of the skin is produced, but avoiding complete division of it, which might result in sloughing and permanent blemish.

Besides the immediate superficial inflammation produced by the iron, which should be at red heat when taken from the fire, it is claimed for this ancient method of treating lameness, that by causing the skin to



Fig. 511.—Spavin-punch

thicken and contract it is made to afford permanent support to the part. There are not wanting authorities who deny the claim that firing has the effect of contracting the skin and producing a permanent bandage, and who assert that all the beneficial results the operation confers are obtainable from repeated blisterings. Viewed from the humanitarian aspect, a verdict in favour of firing might be given, in preference to blistering repeatedly, as it is more than likely that a horse suffers as much pain from a blister as from firing, if the latter operation is performed under chloroform. The inflammatory action set up by firing is not more painful than that produced by a severe blister, and as the effects produced by the former can only be obtained by a repetition of the latter there is little to be said against firing on the score of humanity.

The practice of applying a blister immediately to the skin already treated by the iron is not desirable where the lines are drawn close together, but it may be done with advantage in "open" firing. A minimum of two months' rest should be ensured to a fired horse, and as much longer as circumstances permit; the latter part of the time may be spent in a paddock or well-littered yard in preference to a loose-box, where during the first few weeks the patient should be confined. No good object can be obtained by removing the thick and scabby layer which results from the operation, and, unless an early repetition of the blister is required, it should be left to fall away after an under-covering of hair has been produced.

TENOTOMY

For the most part this operation aims at straightening deformed limbs by division of the tendons where, as the result of sprain or other causes, they have become contracted, or where from congenital deficiency of development they are abnormally short. A preliminary dose of aloes or some diuretic medicine may be advantageously employed where the limb is thick or swollen, as this tends to remove any temporary swelling and bring the tendons more clearly into view.



Fig. 512.—C mean Tenotomy. Scalpel inserted, forceps holding away fascia

Animals with contracted tendons have usually a very overgrown foot at the heel. This should be brought to the ordinary level before operation. The tendons which most frequently call for treatment are the large flexors of the fore and hind limbs, “perforans” and “perforatus”. Cunean tenotomy is practised for stringhalt when due to adhesions connected with spavin or other lesions in the immediate neighbourhood, but is of doubtful value. The operation, in any case, should be performed under chloroform.

The position chosen for dividing the “perforans” or “perforatus” tendon is a little below the middle of the canon, or rather less than half-way between the fetlock and knee of a fore-limb, and the fetlock and hock of a hind one.

The horse having been prepared, and everything in readiness, he is cast in the usual way, and the cross-straps are placed upon his legs above the hocks and knees (Plate LIV), the horse lying upon that side on which are the limbs we intend to operate upon, a position which will enable us to operate on the inner side of the limb. The writer's reasons for preferring the inner side are that the cicatrix is less in view than it would be if it existed on the outer side, and we are not likely to wound the oblique branch of nerve

(fig. 502), which leaves the inner metacarpal nerve at the upper third of the space between the knee or hock, and fetlock, to join the outer at the lower third. If we are about to operate on the hind-leg, the upper cross-strap (Plate LIV) is buckled up tight, thus drawing the uppermost hind-leg as far forward as possible. The foot of the leg to be operated upon is now removed from the hobble; a web halter is placed around the leg above the hock, but below the cross-strap, its free end being held by two assistants, who are to pull, when desired to do so, in a backward direction. It will be seen that this traction will be directly against the cross-straps, which will fix the leg. A similar piece of rope is to be placed around

the hoof: the heels of the shoe will prevent it from slipping off, and the free end is to be held by an efficient assistant, who also is to draw steadily when directed. To raise the leg a little it may be placed upon a cushion. The operator is now to place himself so as to be out of personal danger. The two men at the posterior rope are to draw firmly and steadily. The assistant at the foot rope

is to flex the foot as the operator directs, who is now to grasp the tendons, which are quite lax, about midway between the hock and fetlock with his left hand, the fingers being placed beneath the tendons and the thumb above them (fig. 515). In this way we can to a slight extent separate one tendon from another, so as to feel distinctly the space between the two. (Varnell.)



Fig. 513.—Tenotomy. Tenotomy knife inserted beneath tendon. Skin cut away to show position of blade beneath tendon. Forceps holding sheath



Fig. 514—Tenotomy Knife

After making a very small incision in the skin, the leg is slightly flexed. The tenotomy knife (fig. 514) is then forced sideways between the tendons and the suspensory ligament. The point of the knife must not be allowed to puncture the skin on the opposite side of the limb, and when introduced it must be kept close to the tendons to avoid injury to the vessels and nerves running along their border. The blade is now turned so that the



Fig. 515 —Tenotomy of the Perforans Tendon, showing position of hands and knife

cutting edge is brought into contact with the part to be divided; the foot is then forcibly extended by an assistant acting on the foot rope, and by a firm, steady, sawing movement of the knife the tendon is severed. This will be made known by a sharp snapping noise emitted by the sudden parting of the divided portions. The operation being accomplished, the knife is withdrawn and the animal is allowed to rise. A piece of carbolized wool is now applied to the wound, and support given to the leg by the application of a linen bandage from the foot upward towards the hock or knee, as the case may

be. In order to prevent any undue lengthening of the divided tendons during reparation a high-heeled or a patten shoe will require to be placed on the foot, and the animal must be supported by slings. At the expiration of a fortnight or three weeks the heel of the shoe must be lowered, and the position the foot takes on the ground carefully noted from day to day, so that should the heel show any signs of being drawn up as the tendon becomes reunited, a shoe with a long toe-piece or lever must be fitted to the foot in order to prevent undue contraction in the uniting substance.

It is customary with some to divide both perforans and perforatus, but in recent cases of contraction it suffices to divide the one or the other,

whichever may need it. The complete straightening of the limb is not always immediately apparent, as in long-standing cases numerous adhesions may still prevent the heel from being brought to the ground, unless they are put upon the stretch and broken by forcible extension of the leg while the animal is under control. Where no such adhesions exist, the patient at once puts the heel down and the toe has a tendency to turn up.

After-treatment consists in keeping the wound aseptic by bandaging with suitable dressings (see Antiseptics Employed in the Treatment of Wounds) for a few days, during which it may be expected to heal. Tying up the animal's head to prevent interference with the limb is always desirable.

When the tendons have reunited and the new connecting material has become firm and dense, the horse may be turned into a soft meadow for two or three months until the parts have regained their original strength.

The application of a repetition of blisters to the leg will reduce any slight enlargement which may result from the operation, and if at the same time the patient be subjected to a course of iodide of potassium a still better result may be effected.

The success of the operation is generally greater in the fore than the hind limbs, but very much depends on the time which is allowed for repair. The posterior extremities having to bear the strain of propulsion in heavy draught, require that reparation be thoroughly completed before the horse resumes work, and for this reason a longer time should be allowed.

More or less thickening of the tendons always remains after the operation, but by keeping the wound thoroughly aseptic this will be very much under control.

The only operation of much practical value is that on the back tendons of the leg.

CASTRATION

The necessity of this operation, at least so far as the British Islands are concerned, is its justification. There are not wanting extreme humanitarians who are prepared to deny the necessity of castration, and point to the fact of entire animals being employed to a considerable extent in European capitals. In the omnibuses of Paris, stallions are commonly found yoked together, and apparently upon good terms with each other. In this country it has been proved dangerous and inconvenient to employ them for such purposes. We may claim, too, that the custom of castration having been general for centuries, has tended to the survival of the fittest, and that being so, our horses are in every respect superior to those of other countries, and being more high-spirited, are consequently dangerous for general use when not emasculated. It is obvious that breeds cannot be

maintained pure if at pasture the sexes are permitted to associate, and the inconvenience of having to keep them apart on an ordinary farm holding would very materially interfere with horse-breeding. In the town stable a similar objection applies, notwithstanding that certain mechanical restraints are employed to keep mares apart and stallions from fighting.

Castration in some crude form would seem to have been a means adopted very early in the history of the world, not only for the purposes of taming and controlling animals used in the service of man, but also for improving their flesh. In the Pentateuch we have references to animals "maimed, broken or lacking in their parts", and a very distinct one to mulling¹ as still practised in Asia.

Age.—It is usual in this country to castrate yearlings, provided the colt has wintered well and developed sufficiently in the forehead. There is much to recommend this custom, inasmuch as the animal may continue after operation to run with other horses. It is, however, found that some considerable number of colts are not fit for operation at this age, for the reason that only one testicle is to be seen in the scrotum, the other not having made the second descent (they are both usually present at birth). It is then advisable to wait until autumn or perhaps until the following spring. Castration is also postponed until the second year when colts are low at the wither, light or of ewe-formation in the neck, or generally backward in development, or where it is desired to have male features more pronounced. For the last reason, operation may be deferred until the third season, when all the inconveniences of keeping an entire horse are of course encountered. When the operation is too long deferred the shoulders become thick and heavy, the crest high and coarse, and the forehead broad; in a word, the masculine features which distinguish the horse from the gelding become developed.

METHODS OF OPERATION

These are many, and vary not only in different countries, but also in counties and districts of England. Some are practised while the animal is upon his feet; others necessitate casting with hobbles or ropes.

The oldest, and what is still regarded by many expert operators as the best method, is by actual cautery. Hobbles of various designs (see Methods of Restraint) are employed by some operators, while others attain their object with no other apparatus than a wagon rope (see Plates LI and LV).

The colt being cast upon his left side, and the hind-limbs drawn forward out of the way of the castrator, the parts are fully exposed. The

¹ *Levit.* xxi. 20. "or having his stones broken". *Deut.* xxiii. 1.

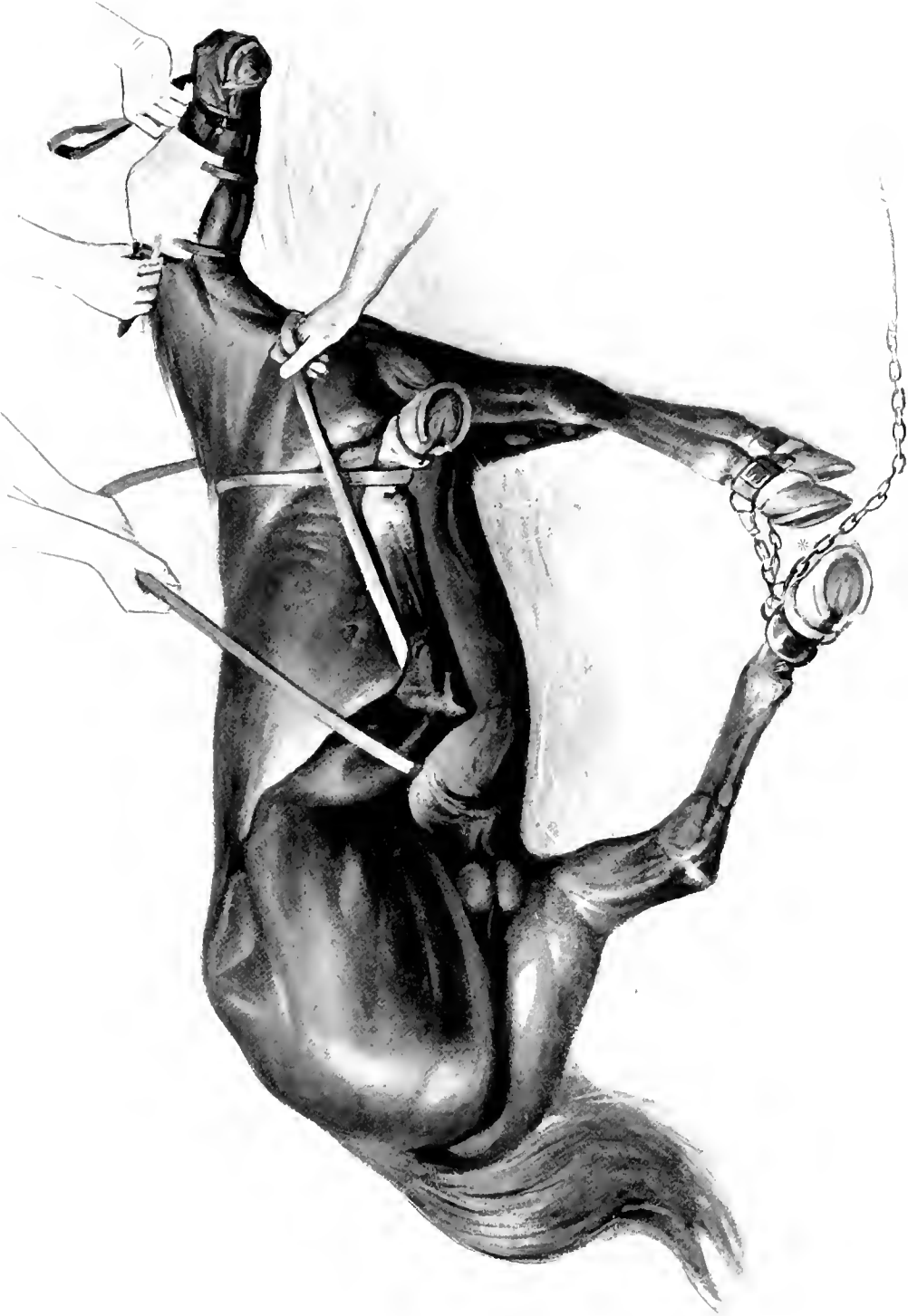

HORSE CAST FOR CASTRATION

A "D" or a Spring Hook must be inserted at * to prevent the chain from slipping.

penis and scrotum are now thoroughly cleansed with soap and water, and freely anointed with carbolized oil or vaseline, so that in the event of any considerable swelling following the operation, the penis may be extruded without difficulty in the act of urination. While this is being done, the scrotum is examined for possible hernia or malformation, and having satisfied himself that all is normal, the operator seizes the testicle in the left hand, and drawing the skin tightly over it, proceeds to lay open the scrotum with a bold long sweep of the knife (fig. 516), which shall by one stroke divide the common integument and investing membranes. He will choose the under testicle first, as the second operation will not then be so much obscured by blood as when the reverse order is pursued. The gland, having been freed from

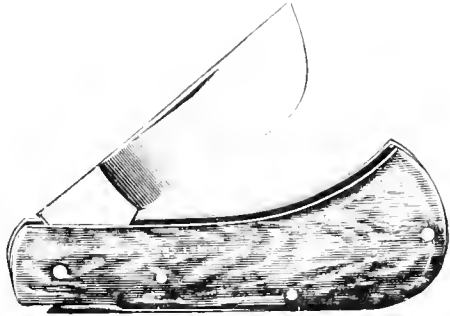

Fig. 516. Castrating Knife



Fig. 517.—
Castrating
Iron

the purse, is firmly grasped, and the action of the cremaster muscle, which tends to draw it back again into the scrotum, is steadily resisted. Any attachment which may be found to exist between the testicle and the investing membrane is divided by the knife, until the gland is clear of everything but the cord. A clamp or forceps made for the purpose (fig. 518) is then placed upon the latter, and either locked by a hook or serrated catch at the end, or firmly held by the operator, while in the right hand he holds a red-hot iron, with which the cord is divided by a gentle sawing movement of the instrument.

To prevent hæmorrhage from the spermatic artery a little powdered resin is dusted on to the divided extremity of the cord, and a somewhat cooler iron is then employed to seal up the vessel.

The majority of castrators employing this ancient but truly aseptic method also adopt

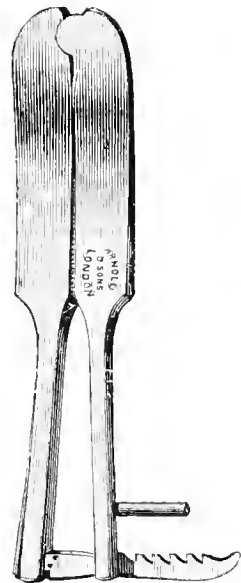

Fig. 518.—Clamp for
Castration by Firing

the precaution of smearing the clamp, and afterwards anointing the interior of the purse with an ointment composed of verdigris, Venice turpentine, and bees'-wax, with the object of preventing too rapid healing

of the wound and imprisonment of blood-clots, which may decompose and set up septic poisoning.

Whatever the origin of the custom, we know that verdigris (copper acetate) is a valuable antiseptic, and that the success of this apparently crude application of the antiseptic system is beyond dispute.

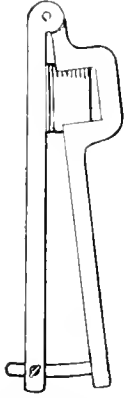

Fig. 519.—Fixing Forceps for Castration by Torsion

The method above described is that most commonly practised among those who employ the actual cautery and cast horses as a preliminary to castration, but the details vary, and some operators do not use a knife at all, but divide the coverings of the testes by a thin-edged and very hot iron. Dexterously carried out, this is not so painful as from the bare recital of the method it would appear, the severance being very rapid when the investitures are rendered tense by the hand or clamps grasping the scrotum below.

Hæmorrhage from the spermatic artery when imperfectly sealed is the chief danger to be feared; a moderate amount of bleeding from the small vessels divided is rather welcomed as presaging less swelling subsequently.

On the completion of the operation the inner aspect of the thighs should be anointed with lard or vaseline to prevent scalding of the skin by matter discharged from the wounds in the course of healing, and it may be advisable to tie up the tail when long, lest the decomposing blood and matter gathered upon it be transferred to the wounds and set up septicæmia or blood poisoning. This is especially liable to take place in summer, when flies are troublesome and the tail is lashed between the thighs to effect their displacement.

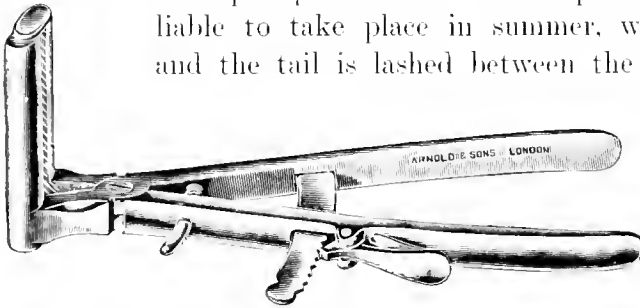

Fig. 520.—Torsion Forceps

Torsion.—A favourite method on the Continent, and in vogue in some parts of Scotland and Wales, is that of twisting and drawing out the artery until its

coats break and all possibility of hæmorrhage is precluded.

To castrate in this manner, the animal has to be cast in the way previously described, and the testicle let out of the purse by the knife. The posterior or non-vascular portion of the cord is then divided, leaving the testicle suspended by the vascular portion alone. The cord is then secured in the clamp above the epididymus. This portion is now seized by the

“fixing forceps” (fig. 519), which are firmly held by an assistant (Plate LVI, fig. 2). The operator now seizing the cord still nearer the testicle by the “moving forceps” (fig. 520), twists the intervening portion round and round from left to right until all the structures break away, and the testicle is removed. It is an operation requiring more skill than the method previously described, and occupies more time. If the traction and twisting are too quickly executed, the vessel may be broken before its coats are sufficiently torn and separated from each other (the object sought) to stop the bleeding.

Ligature.—With the same methods of restraint and preliminary preparation, severance of the glands may be effected by ligature. In this method the posterior or non-vascular portion of the cord is divided by the knife as in the preceding operation, and the artery is tightly bound round by some suitable material, as carbolized gut, waxed silk, or fishing cord. The first of these presents an advantage in that it is capable of being liquefied and absorbed during the healing of the wound, while the others require to be removed from outside when strangulation of the vessel has been effected; but none of them is wholly satisfactory.

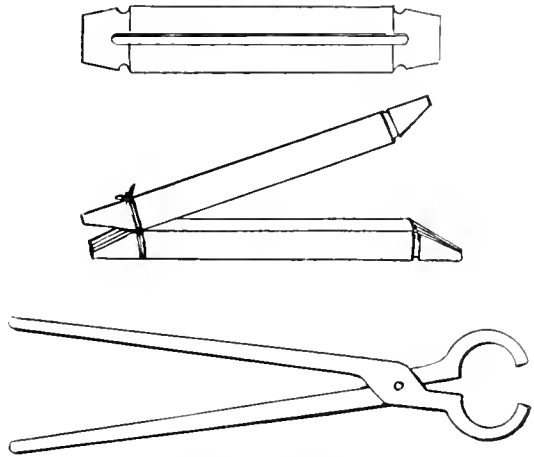

Fig. 521.—Clamps and Forceps for holding the same

The general opinion in this country among castrators of experience is to the effect that this, the most simple and cleanly method, is the least successful of any.

Caustic Clamps.—Destruction of the cord by a corrosive agent, combined with compression in a wooden clamp, is among the older methods, probably next akin to that practised among savages of including the whole scrotum in a ligature, and turning the wretched beast adrift until the testicles dropped off. In castrating by clamps one of two methods is adopted—the *covered* or the *uncovered* operation. In the covered operation the testicle is not completely exposed. The skin and dartos muscle are cut through, leaving the internal envelope immediately enclosing the organ intact. The clamp is then placed upon the spermatic cord and its investing tunic, with the ends directed backward and forward. They are then brought forcibly together by the castrating forceps (fig. 521), and securely tied by means of strong cord.

In the uncovered operation all the structures enveloping the testicle are cut through, and the gland is fully exposed. The clamps are then adjusted over the spermatic cord only (Plate LVI, fig. 1), in the same manner as in the covered operation, but a little more above the testis. When securely clamped the testicles may be removed or left to slough away.

The clamps employed in the operation of castration are sometimes grooved (fig. 521) along the centre for the accommodation of a charge of caustic paste, which, acting on the tissues of the cord, brings about their more immediate destruction.

Standing Operation.—It has been previously remarked that an element of danger necessarily enters into the act of casting horses and

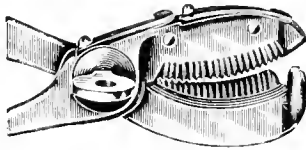
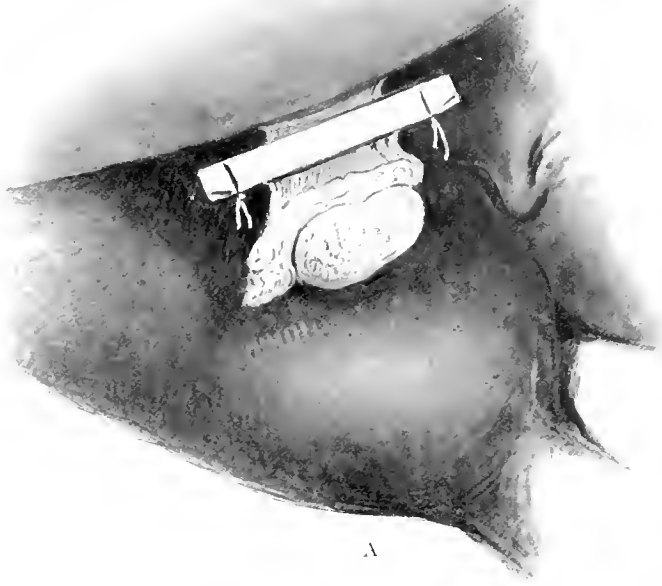

Fig. 522.—“Reliance” Castrator

retaining them in a fixed position on the ground. The risk is comparatively small in connection with colts, whose tissues are elastic; but injuries arising from this cause having from time to time occurred to animals of great value, an exaggerated importance has been attached to it,

hence the standing operation, which in recent years has been largely adopted, both by veterinary surgeons and the ordinary castrator.

The usual plan of the standing operator is to have the subject placed against a padded wall or partition in which a strong ring staple is fixed, and a running noose through it is passed over the animal's withers, whereby it is possible to keep him from turning round. A twitch is placed upon the upper lip in the usual way, and then by dint of threats and feints and the pain of the twitch together, the colt is induced to remain upon his feet. Many colts can be induced to stand with no other restraint than the twitch, as the fact of having the testes firmly held prevents them from kicking or striking. One effect of the pain they suffer is to make them crouch in a manner inconvenient to the operator. To keep them on their feet is the chief difficulty, and despite the twitch, shouts, and gestures of those who adopt this method, some will lie down. Taking advantage of the upright position the castrator grasps the scrotum in the left hand, and with a clean stroke of the knife liberates first one testicle and then the other. The testicles being liberated from the scrotum, there remains a choice of methods as to their removal. Some apply the caustic clamp, the central groove of



A

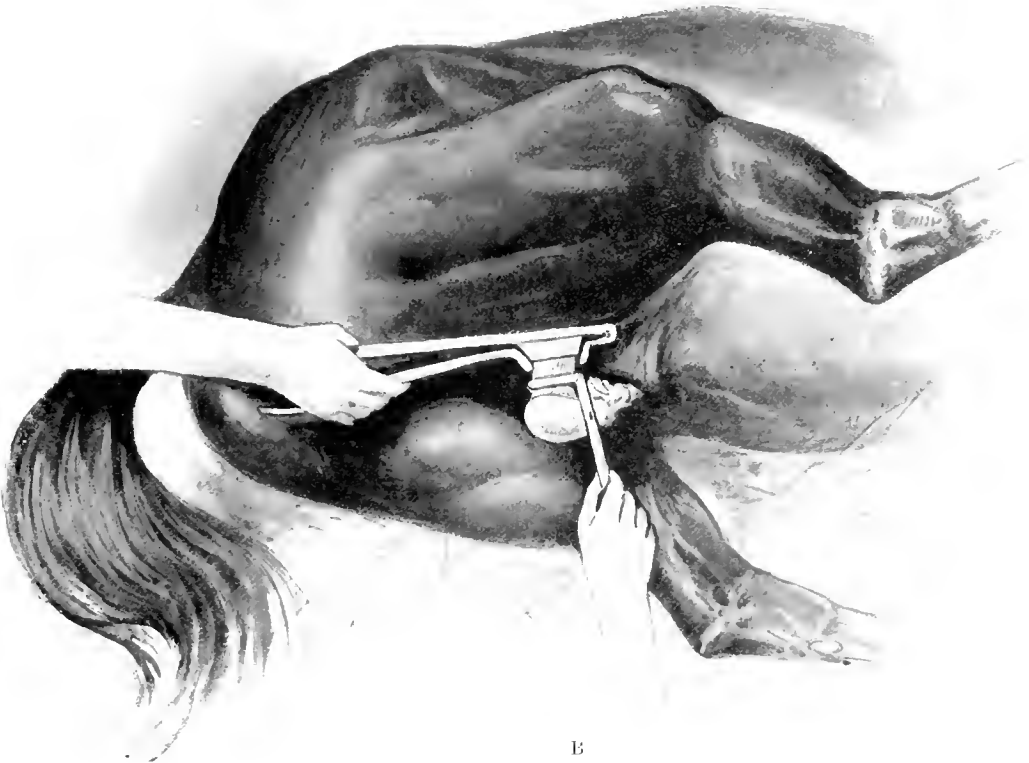

B

CASTRATION

A. By uncovered testicle. B. By limited torsion.

which is charged with a paste of perchloride of mercury and whiting, or some other destructive agent, which, together with the compression of the cord, corrode and strangulate the tissues. When this has been effected the clamps are removed. A quicker way of performing the standing operation is by severing the cord at once with a double-toothed instrument (fig. 522), which compresses and divides it at the same time, no clamp or other means of arresting hæmorrhage being adopted.

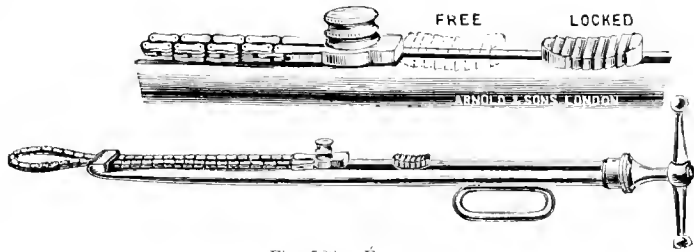

Fig. 523 —Écraseur

Another instrument, known as the *écraseur* (fig. 523), and first introduced into this country by a famous American castrator, is in the nature of a chain, and performs its task in a similar manner to the crushing serrated instrument last referred to. The advocates of the standing operation not only claim to avoid those accidents which result from casting, but likewise to ensure greater cleanliness and less liability to infection of the wounds while the horse is upon the ground.

PASSING THE CATHETER

This operation has been several times alluded to in connection with diseases of the urinary and generative systems. Its opportune performance may sometimes be the means of saving life, and of affording great relief in certain disorders, both in the male and female animal.

The male catheter (fig. 524) is an instrument some 4 feet in length, and composed of flexible material in order to accommodate itself to the curves over which it is required to pass on its way to the bladder.

It is hollow throughout its length, and commonly provided with a stilette of pliable material, such as whalebone. The end to be passed into the canal is provided with a nozzle of some harder substance, perforated in several places to admit the urine, and not therefore depending on a single orifice at the point, which may be blocked by mucus, blood, or other products of disease.

It may be passed when the animal is either standing or in a recumbent posture. If standing, the operator will adopt measures to secure his own safety, and take up a position on the horse's right side, where, with his left hand, he can seize the penis, and by exerting gentle but continuous traction overcome the resistance of the retractor muscles, and draw out the

organ to its fullest extent. A little flour or meal upon the hand enables one the better to grasp and retain it, as the resistance is not inconsiderable, especially in stallions. The instrument, previously oiled, is then taken in the right hand and carefully introduced into the urethral canal. Provided no obstacle exists, such as a calculus from the bladder, it is advisable to push on with steady but continuous force until that viscus is reached. Should any opposition of the kind indicated be encountered, all effort to

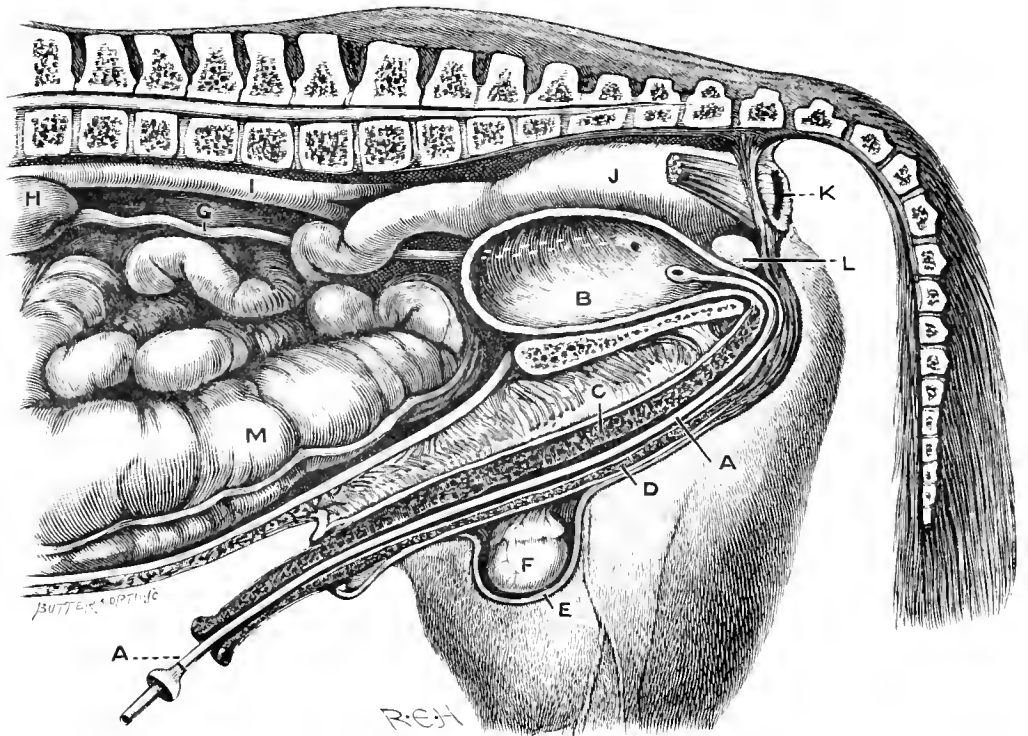

Fig. 524. Retention of Urine—Catheter inserted

A, Catheter. B, Bladder. C, Corpus spongiosum. D, Corpus cavernosum. E, Scrotum. F, Testicle. G, Ureter. H, Kidney. I, Aorta. J, Rectum. K, Anus. L, Prostate gland. M, Colon.

force the passage should cease, after a fair and reasonable attempt has been made to remove the obstruction. A careful operator will employ an assistant to watch the perineum and lightly press upon the part in order to direct the instrument over the curve of the pelvis, and give it a forward direction towards the bladder. It is important that the nozzle should reach as near as possible the floor of the bladder, so that all the fluid may be drained off; care, however, must be exercised not to injure the organ by forcible contact.

The stilette is next withdrawn, and a vessel held under the cup-shaped end of the instrument to receive the fluid. If no solid matters interrupt,

the urine will flow as from a syphon in steady and continuous stream until but little is left behind; but it is generally considered advisable, where extreme distension has existed, to leave some portion of the fluid behind for a time, with the object of exciting contraction in the walls of the bladder and restoring its normal function.

The catheter is now withdrawn, and if any meal or other substance has been used on the hands, the penis should be cleansed, and some simple

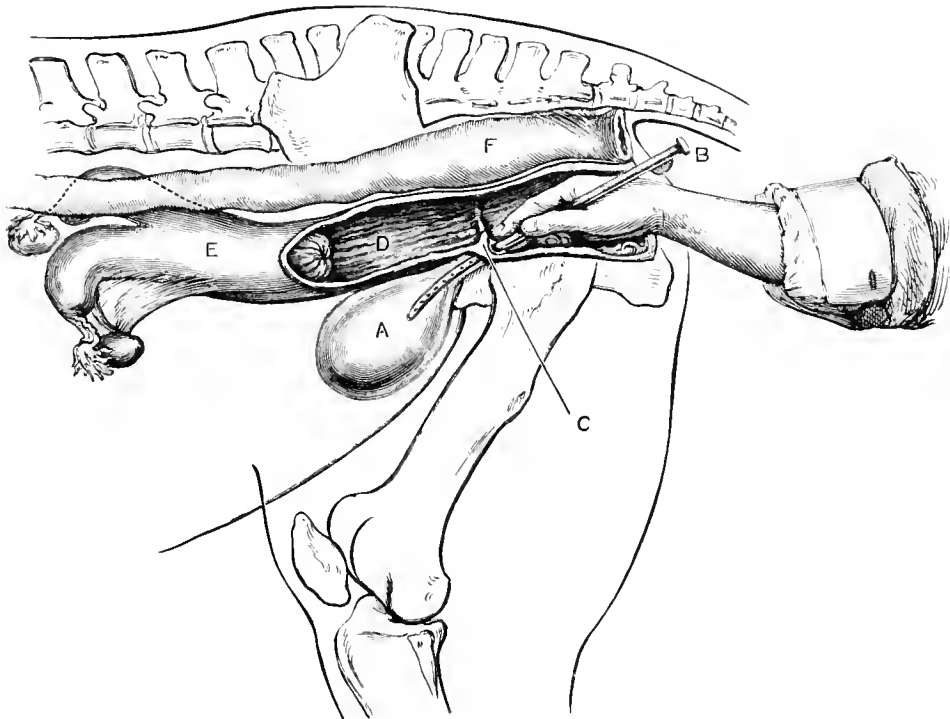

Fig. 525.—Insertion of Female Catheter

A, Bladder. B, Catheter. C, Membranous fold overlapping the orifice of the bladder. D, Vagina.
E, Uterus. F, Rectum.

unguent applied within the sheath to facilitate the extrusion of the organ in the act of micturition.

Among the chief disorders necessitating the employment of the catheter in the male animal may be mentioned retention of urine from stricture, enlargement of the prostate gland, the presence of calculi, injuries to the penis, morbid growths, inflammation of the bladder, and paralysis.

The female catheter (fig. 525) is a shorter instrument, and often composed of metal—a soft alloy, which will permit of slight bending. It is also made of caoutchouc, of cellulose, and other materials similar to those employed in the manufacture of male catheters. The orifice of the female bladder will be found on the floor of the vulva, about 4 to 6 inches from

the labiæ; an instrument, therefore, from 10 to 15 inches in length is found adequate for the purpose.

A fold of membrane slightly overlaps the opening, and when this is felt by the finger, the end of the catheter is directed to it and gently pressed forward and downward into the bladder.

Precautions for the safety of the operator are even more necessary in the case of mares than when attempting to withdraw urine from male horses (see Methods of Restraint).

The disorders calling for the use of the catheter in mares are, for the most part, the same as those for which it is employed in the male sex, but in addition there are troubles connected with the bringing forth of young which temporarily interfere with the passage of urine. Among these may be mentioned metritis, inflammation of the vagina after difficult and protracted labour, retention of the placental membranes, and maladies contracted *in coitu*.

OVARIOTOMY IN TROUBLESOME MARES

The ovaries are not unfrequently the seat of structural or functional diseases which, although not seriously affecting the general health of the mare, may, and sometimes do, render her vicious and useless. When these morbid states exist, the temperament and habits of the animal undergo a marked change, and what was before a quiet unaggressive mare now becomes a restless, unseemly, and dangerous creature.

During the period of œstrum, or what is commonly spoken of as "horsing", there is at all times a certain degree of exceptional irritability, and this is evident in some mares more than in others. But in the cases referred to above, it sometimes becomes so pronounced as to require the greatest care in their handling and general management. As the œstral period expires the danger may pass away, but in some mares it continues throughout the summer, while in others œstrum becomes a chronic condition. These animals are more or less constantly "horsing", and receive service after service without any result. The morbid sensibility they display renders them dangerous not only to drive, but likewise to attend upon in the stable.

When they are touched or even approached they squeal, straddle, let themselves down behind and throw out a quantity of urine, and the labia are spasmodically opened and closed for a number of times. Sometimes they will strike out with their fore-limbs, and the danger of such an animal is her tendency to kick and injure those about her. Mares so affected are difficult to put in and take out of harness, and they frequently lean towards

one side or the other and refuse to be straightened. Sometimes they may be driven without fear, and at others they become vicious and kick furiously at the vehicle to which they are yoked.

Habits of this kind are not unlikely to be attended with serious consequences, and the owner naturally seeks for something to be done to correct them. Here the operation of ovariectomy, or removal of the ovaries, is the only remedy by which the animal can be rendered quiet and useful. Sometimes, especially in the case of old mares in whom the vice of kicking has become indelibly established, the operation does not seem to overcome it altogether, but as a rule the contrary is the case, and the mare is rendered quite quiet and useful for all kinds of work.

It is seldom that animals of this kind will breed, and nothing is lost therefore by removing the organs of reproduction.

It is advisable that some attention should be given to the condition of the mare before the operation is commenced, and especially in respect to her diet. For three or four days previously she should be fed on sloppy bran, and during the last twenty-four hours before the operation, all food should be withheld and very little water allowed; this should be given early on the morning of the operation.

Inasmuch as the rectum is immediately above the part to be operated upon and the bladder below it, it is necessary that both these organs should be emptied of their contents. By so doing, additional room is acquired for the operator, and if an enema or two be thrown up the former before the operation, the liability of soiling the hands is thereby guarded against.

All the outlying parts of the mare, as the under surface of the tail, the rectum, the perineum, and the labia, should be thoroughly washed with warm water and soap, and after being sponged with clean water should then be freely dressed with a 5-per-cent solution of carbolic acid. This should be done in the morning, and again immediately before operating.

As the vagina is the part to be operated upon, it becomes of the first importance to ensure that it, as well as the part leading to it, should be rendered as thoroughly aseptic as possible. For two or three days before the operation an antiseptic solution of chinolol, or perchloride of mercury, or carbolic acid should be injected into it morning and evening; and when the mare is cast, and while under the influence of chloroform, this can be repeated, and in addition the walls of the vagina should be thoroughly sponged with antiseptic solution.

The instruments required for the operation are an *écraseur* (fig. 523), a knife whose blade is guarded (fig. 526), and an enema syringe. These must be thoroughly cleansed and boiled, or placed in a 5-per-cent solution

of carbolic acid for two or three days before being used. The sponges or wool, or whatever is used for mopping up the blood, must be similarly dealt with.

Having sterilized the instruments, the operator must give strict attention to his own person. Dirty hands or a dirty garment may make the difference between success and failure. He should wear a gown which has been washed and rinsed in a solution of carbolic acid or perchloride of mercury. His hands and arms should be washed and brushed in soap and carbolized water, and afterwards rinsed in a fresh solution of the same.

The nails must be cut short and be thoroughly cleansed.

These preliminaries having been completed, the operation may be proceeded with.

In casting a mare for the purpose in question, the ordinary hobbles (Plate LI) will suffice, after which she may be brought under the influence of chloroform in the ordinary way.

There are two positions in which an animal may be placed for being operated upon:—(1) Standing. (2) Recumbent.

In the former the parts to be dealt with are in their natural position, and are in this respect more readily seized and removed; but to restrain these animals for such an ordeal requires the administration of large doses of morphia or chloral, and even then a good deal of unnecessary pain and struggling invariably results.

The most convenient and humane method is no doubt to place the animal in the recumbent posture, and, as we have suggested, to put her under the influence of chloroform.

In this condition all sense of feeling is obliterated or put to rest. There is no pain nor suffering, and the mare may be put in any position the operator may require.

When this has been done, the operation may be proceeded with. This consists in making a hole in the walls of the vagina, through which the hand may be passed into the belly.

The operator, placing himself in a recumbent position behind the mare, takes the guarded knife (fig. 526) in the left hand and carries it into the vagina. At the anterior extremity of this cavity will be felt a short, fleshy projection, the neck of the uterus. This may be used as a guide for the incision which must be made in order to reach the ovary. The knife is carried to the inferior part of this body (as the animal lies), and being then

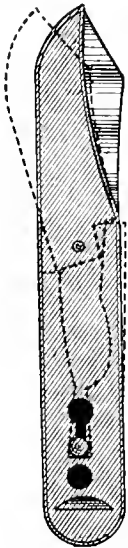

Fig. 526.—Guarded Knife. The dotted line shows the blade pressed forward for cutting

unsheathed, is carefully plunged through the walls of the vagina. Having done this, the fingers one after another are then passed into the opening, which they enlarge by tearing the structures until the hand can be introduced. The tearing is done in order to avoid hæmorrhage, which would follow incision of the vessels of the part.

On entering the abdomen the hand is passed in an upward and forward direction, following the line of the horn of the uterus, and the ovary will be found suspended from the spine behind the kidney. In a natural condition the ovary is somewhat soft, but in these nymphomanias it usually becomes more or less hard, and may be either enlarged or contracted.

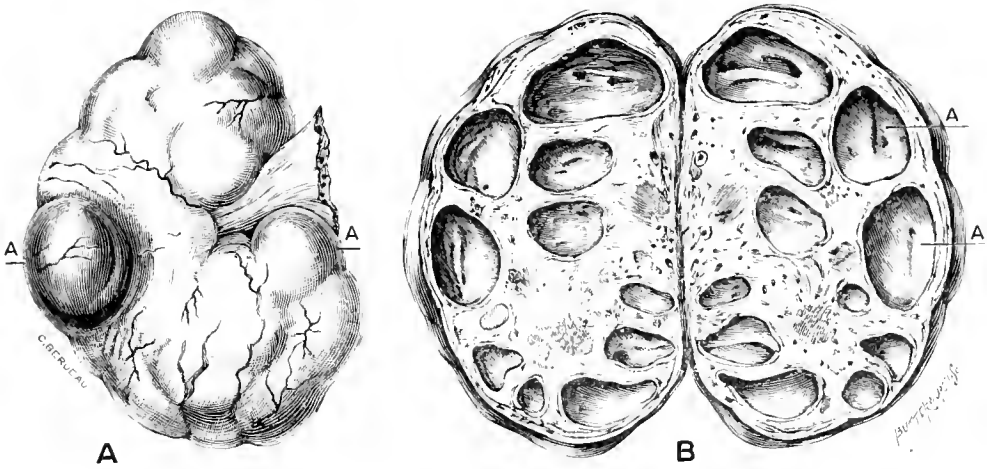

Fig. 527.—Cystic Ovary

A, The ovary entire. A A, Cysts distended with fluid. B, Ovary in section. A A, Cysts or Cavities from which fluid has been removed.

The next stage in the operation is the removal of the gland, and for this purpose the *écraseur* is passed through the wound made in the vagina. The chain of the instrument is then placed round the parts which suspend it, and tightened up by turning the screw slowly until the ovary drops into the hand. Care must be taken to secure it, and not allow it to fall into the belly. The other ovary is then removed in a similar manner.

This having been done, the operation is completed and the mare is allowed to rise. Usually these cases make a good recovery, and, excepting slight temporary uneasiness and colicky pains occasionally for the first few hours, no unfavourable symptoms are presented.

The mare should be kept on scalded food for a day or two, and gradually returned to her normal rations.

If after removal the ovaries be examined, they will be found to be in one of two conditions. Either they are much smaller than is natural, or they

are irregularly enlarged. In the former case they are hard and contracted in consequence of having undergone a process of fibroid degeneration, or in other words they have been converted into fibrous tissue. In the latter, when divided with the knife, a number of cavities of different sizes are found, filled with watery fluid. In this case the ovary is in a cystic condition (fig. 527). Many of these cysts are Graafian follicles which have become inordinately large, and in some instances by mutual pressure have broken into each other.

CASTRATION OF RIGS OR CRYPTORCHIDS

It sometimes occurs that the testicles, which in the early period of life are still in the belly (Plate XXXIV), fail to appear in the scrotum. For some reason or other connected with development, they are either retained in the abdominal cavity or stop short in the inguinal canal.

When this occurs such an animal is said to be a *rig* or *ridgling*, or more technically a *cryptorchid*. It is not uncommonly observed that one or both the testicles fail to descend in the sac. In the former case the horse is termed a *monorchid*, while in the latter he is distinguished as a double *cryptorchid*.

When the testicles do not "come down" into the scrotum the animal has all the attributes of a stallion, and he is consequently unable to be stabled with mares or turned to grass with other horses.

Horses in this condition are frequently capable of getting foals, are for the most part troublesome, and are undesirable property. Moreover, their progeny are liable to be afflicted with the same malformation as themselves; in other words the defect is congenital. It becomes necessary, therefore, that such animals should be castrated.

The operation to be resorted to is for the most part simple and free from danger, but where the testicles remain in the abdomen special care is needed for their removal.

In all cases it is desirable to prepare the horse for the operation by restricting his diet to bran and slops for two or three days; and, for twenty-four hours previously, withholding all kinds of food and restricting his water to half-rations.

This done, the horse is cast and fixed in the manner usually resorted to for castration. The operation is very much facilitated by the administration of an anæsthetic, when every muscle is relaxed and the animal lies quietly instead of struggling, as is the case where he is not under its influence.

Chloroform is undoubtedly the most useful agent in this connection,

since it controls the entire body and deprives the horse of consciousness and feeling.

The animal is now placed on his back, and trusses of straw or bags of saw-dust forced against his sides.

To empty the rectum before the operation is also a desirable course to pursue, and the tail should be tied up, and after the administration of chloroform has taken place it may be carried forward out of the way and tied to the collar.

The instruments which will be needed are a castrating knife (fig. 516), artery forceps, a pair of dressing forceps, a needle, strong silk, silkworm gut, and an *éraseur* (fig. 523).

Before commencing the operation it will be necessary that these several items be placed in a 5-per-cent solution of carbolic acid for forty-eight hours, otherwise they must be thoroughly boiled and kept in hot water until required. Cotton-wool or sponges, whichever may be used, should be rendered sterile by the same treatment.

The hair in and about the scrotum must be re-

moved by close clipping, and the site of the incision should be thoroughly washed with warm antiseptic water and soap. After washing, the part should be carefully soaked again and again with fresh antiseptic solution.

This should be done by the operator, whose hands will at the same time be undergoing disinfection. When complete, the part should be wiped thoroughly dry, and then the hands and arms of the operator must be washed and brushed with hot water and soap, and afterwards soaked for five minutes in fresh carbolic solution. Special attention should be given to the nails; in these cases they should always be cut short and be surgically clean.

The same treatment must apply to the assistant and anyone who may be told off to handle the instruments.

The first step in the operation is to make an incision carefully through the skin and the thin layer of elastic tissue beneath it, taking care to avoid cutting into any of the vessels forming the rich plexus of veins which are disseminated through the connective tissue beneath. This incision must be about 5 inches in length over the site of the testicle.

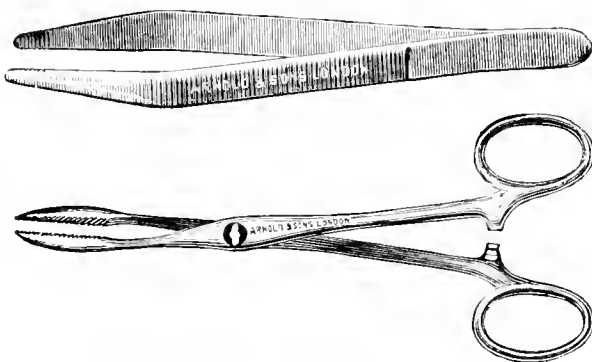

Fig. 528 — Dressing Forceps and Artery Forceps

The subcutaneous connective tissue is then to be torn through and pushed aside with the fingers, until the outer ring of the inguinal canal is reached. Sometimes the testicle is found immediately within it, in which case it will be seized and removed by passing the *éraseur* around the cord by which it is suspended. In other instances it is placed higher up in the canal, and in some cases it is found in the cavity of the belly. Whether it be found in the one place or the other it must be brought out, or the chain of the *éraseur* must be carried to it and placed around the cord, and by slow but continuous turns of the screw divided. Should any difficulty arise in meeting with it in the abdomen, the hand should be passed to the upper surface of the bladder, where the *vas deferens*, a firm tube about two-thirds the diameter of a lead pencil, will be found, and this followed in a forward direction will lead to the testis.

When the abdomen is opened and the internal ring enlarged, there is of course some danger of escape of the intestines. This may be guarded against by suturing the skin closely with interrupted sutures of silkworm gut, and in some measure also by allowing the horse to rise from the ground while lying on the side from which the testicle has been removed. This done, my friend Professor Hobday suggests that the skin be covered with iodoform and collodion (1 to 10) or orthoform and collodion (1 to 8).

From a consideration of the following table of cases operated upon by Professor Hobday, it will be seen that—

In 36 instances the right testicle alone was missing, whilst in 29 the left was the offending organ.

In 11 of the cases both testicles were concealed.

In 39 instances the organ was found in the abdomen, and in 43 it was in the inguinal canal.

In 2 instances (27 and 69) one or both testicles were entirely absent, and in 2 others (68 and 75) the missing testicle was not found after a prolonged search.

It may be mentioned that death occurred in only 4 out of the 77 cases.

PARTICULARS OF CASES OPERATED UPON BY PROFESSOR HOBDAY

No. of Case.	Date.	Breed	Age.	Testicle which was hidden.	Situation of Missing Testicle.	Other Testicle.
1.	March, 1898	Cob	—	Left	Inguinal canal	Had been removed.
2	June 4, 1898	Hunter	2½ years	Both	Do. do.	—
3.	July 7, 1898	Pony	—	Right	Do. do.	Had been removed.
4.	July 8, 1898	Cart	3 years	Both	Right one in inguinal canal, left one in abdomen	—
5.	July 8, 1898	Cart	3 years	Left	Inguinal canal	Had been removed.
6.	Oct. 9, 1898	Cart	2 years	Right	Do. do.	Do.
7.	Nov. 26, 1898.	Cart	3 years	Left	Do. do.	Do.
8.	Nov. 26, 1898	Cart	3 years	Right	Abdomen	Do.
9.	Feb. 21, 1899	Hackney	3 years	Left	Do.	Do.
10.	Mar. 28, 1899	Cart	3 years	Right	Inguinal canal	Do.
11.	May 18, 1899	Pony	5 years	Right	Do. do.	Do.
12.	June 24, 1899	Pony	3 years	Left	Do. do.	Do.
13.	July 6, 1899, and July 15, 1901	Cart	2 years	Left	Epididymus in canal; testicle in abdomen	Do.
14.	July 15, 1899	Hackney	2 years	Right	Inguinal canal	In scrotum.
15.	July 20, 1899	Cart	2 years	Right	Do. do.	Do.
16.	July 20, 1899	Cart	5 years	Left	Abdomen	Had been removed.
17.	July 22, 1899	Cart	1 year	Left	Do.	Do.
18.	July 22, 1899	Cart	3 years	Both	Inguinal canal	—
19.	July 29, 1899, and Sept. 30, 1901	Hunter	6 years	Right	Epididymus in canal; testicle in abdomen	Had been removed.
20.	Sept. 12, 1899	Cart	5 years	Right	Abdomen	Do.
21.	Sept. 12, 1899	Cart	3 years	Right	Do.	Do.
22.	Sept. 12, 1899	Cob	4 years	Left	Do.	Do.
23.	Dec. 7, 1899	Cart	3 years	Left	Do.	Do.
24.	Dec. 8, 1899	Cart	3 years	Left	Do.	Do.
25.	Dec. 8, 1899	Cart	4 years	Right	Inguinal canal	In scrotum.
26.	Dec. 8, 1899	Hackney	4 years	Right	Do. do.	Had been removed.
27.	Feb. 20, 1900	Thoroughbred	2 years	Both	—	—
28.	May 1, 1900	Pony	2 years	Right	Inguinal canal	In scrotum.
29.	May 12, 1900	Cart	3 years	Right	Abdomen.	Do.
30.	May 21, 1900	Pony	2 years	Right	Inguinal canal	Do.
31.	May 26, 1900	Hackney	3 years	Left	Abdomen	Do.
32.	June 2, 1900	Cart	2 years	Both	Inguinal canal	—
33.	June 29, 1900	Thoroughbred	3 years	Right	Do. do.	Had been removed.
34.	July 25, 1900	Cart	18 months	Right	Do. do.	Do.
35.	July 31, 1900	Hackney	2 years	Left	Abdomen	Do.
36.	Aug. 4, 1900	Cart	4 years	Left	Do.	Do.
37.	Aug. 23, 1900	Pony	1½ years	Left	Do.	Do.
38.	Sept. 5, 1900	Shire	7 years	Right	Do.	Do.
39.	Sept. 11, 1900	Hackney	7 years	Left	Do.	Do.
40.	Sept. 11, 1900	Cob	7 years	Right	Do.	Do.
41.	Sept. 11, 1900	Cob	7 years	Left	Inguinal canal	Do.
42.	Sept. 18, 1900	Cart	3 years	Right	Do. do.	Do.
43.	Sept. 18, 1900	Cart	3 years	Right	Do. do.	In scrotum.
44.	Oct. 12, 1900	Cart	1 year	Right	Abdomen	Had been removed.
45.	Oct. 12, 1900	Cart	2 years	Both	Do.	—
46.	Oct. 12, 1900	Pony	3 years	Left	Do.	In scrotum.
47.	Oct. 12, 1900	Cart	4 years	Both	Do.	—
48.	Nov. 3, 1900	Carriage horse	3½ years	Right	Inguinal canal	Had been removed.
49.	Nov. 5, 1900	Cob	4 years	Left	Abdomen	Do.
50.	Nov. 17, 1900	Hackney	3 years	Left	Do.	In scrotum.
51.	Dec. 1900	Cart	4 years	Right	Do.	Had been removed.

HEALTH AND DISEASE

No. of Case	Date	Breed.	Age.	Testicle which was hidden.	Situation of Missing Testicle.	Other Testicle.
52.	Jan. 18, 1901	Thoroughbred	3 years	Left	Inguinal canal	Had been removed.
53.	Feb. 11, 1901	Cart	3 years	Right	Abdomen	Do.
54.	May 20, 1901	Cart	7 years	Left	Do.	Do.
55.	June 5, 1901	Cart	4 years	Right	Inguinal canal	In scrotum.
56.	June 11, 1901	Hackney	2 years	Both	(Left testicle in abdomen, right testicle in canal)	—
57.	June 15, 1901	Thoroughbred	2 years	Left	Abdomen	In scrotum.
58.	June 15, 1901	Thoroughbred	2 years	Both	Inguinal canal	—
59.	June 21, 1901	Cart	2 years	Both	Abdomen	—
60.	June 21, 1901	Hackney	5 years	Right	Inguinal canal	Had been removed.
61.	July 1, 1901	Pony	2 years	Left	Do. do.	In scrotum.
62.	Aug. 1, 1901	Hackney	4 years	Right	Do. do.	Had been removed.
63.	Sept. 17, 1901	Hackney	3 years	Right	Do. do.	In scrotum.
64.	Sept. 17, 1901	Hackney	3 years	Left	Do. do.	Do.
65.	Sept. 24, 1901	Thoroughbred	2 years	Both	(Right one in canal left one in abdomen)	—
66.	Sept. 24, 1901	Cart	5 years	Left	Inguinal canal	Had been removed.
67.	Dec. 11, 1901	Cart	3 years	Left	Abdomen	Do.
68.	Feb. 18, 1901	Shire	8 years	Right	Do.	In scrotum.
69.	Mar. 1902	Cart	3 years	Right	—	Had been removed.
70.	April, 1902	Hackney	3 years	Right	Inguinal canal	Do.
71.	July 25, 1902	Shire	3 years	Right	Abdomen	Do.
72.	Aug. 26, 1902	Cart	2 years	Right	Do.	Do.
73.	Aug. 26, 1902	Cart	2 years	Left	Inguinal canal	In scrotum.
74.	Aug. 27, 1902	Cart	2 years	Left	Abdomen	Had been removed.
75.	Aug. 17, 1902	Cart	5 years	Right	Do.	In scrotum.
76.	Oct. 17, 1902	Cart	3 years	Right	Inguinal canal	Had been removed.
77.	Nov. 1, 1902	Cart	3 years	Left	Do. do.	Do.

THE GRESHAM PUBLISHING COMPANY

34 SOUTHAMPTON STREET, STRAND, LONDON, W.C.

* * * * *

The New Popular Encyclopedia.

A LIBRARY IN ITSELF. A General Dictionary of Arts, Sciences, Literature, Biography, and History. Edited by CHARLES ANNANDALE, M.A., LL.D., Editor of Ogilvie's "Imperial Dictionary of the English Language". Profusely illustrated. In 14 handsome volumes, super-royal 8vo, in Roxburgh library binding.

A New Century demands a New Encyclopedia. As time advances, knowledge increases. To sum up that knowledge a new Encyclopedia is required, and everyone ought to possess that new Encyclopedia.

The Gresham Publishing Company, having acquired exclusive control of the well-known POPULAR ENCYCLOPEDIA, are now issuing a **New and Revised Edition** of that famous authoritative work of reference.

The entire work has been revised to date under the editorship of **Dr. Charles Annandale**, assisted by a staff of **Specialists** and **Encyclopedic Experts**.

The **New Popular Encyclopedia** is a worthy successor to the previous edition, which numbered among its contributors men of the high position of LORD KELVIN, SIR ANDREW C. RAMSAY, PROFESSOR J. D. EVERETT, MR. COMYNS CARR, CAPTAIN ORD-BROWN, MR. M. M. PATTISON-MUIR, &c.

In the matter of **pictorial illustration** the New Popular Encyclopedia is *alone of its kind*. In no British Encyclopedia, not even in previous editions of the POPULAR, has so extensive a use been made of the pictorial arts to assist the elucidation of the subject-matter. In addition to the large number of **plates in colour**, there are very many plates in black and white: pictures of machinery-detail, portraits, ordnance such as Vickers, Creuzot, and Krupp guns, flying-machines, ethnological types, and the hundred-and-one different objects which can be rendered clearer by the use of pictorial illustration. A complete series of **Maps** is also provided.

The **Supplements** form a very special feature of the New Popular. Besides containing many articles on general subjects they give **biographies** of living men or of men recently deceased. Thus we have MR. CHAMBERLAIN, MR. KRUGER, LORD SALISBURY, LORD ROSEBERY, MR. ARTHUR BALFOUR, MR. GEORGE WYNDHAM, LORD ROBERTS, GENERAL BULLER, MAJOR-GENERAL BADEN-POWELL (whose brother, Major Baden-Powell, secretary of the Aeronautical Society, contributes the Article on Aeronautics), &c., &c.

"THE NEW POPULAR ENCYCLOPEDIA" is a perfect library in itself, superseding, practically, the necessity of having recourse to a large number of books on different topics, and furnishing, at moderate cost, a complete body of information on all subjects.

IT IS A UNIVERSAL GAZETTEER, giving accounts of the natural and political divisions, countries, cities, rivers, lakes, &c., throughout the world.

IT IS A UNIVERSAL HISTORY, in which are to be found full general accounts of all the countries of the world, with important events and details treated at length under specific headings.

IT IS A BIOGRAPHICAL DICTIONARY—giving the lives of all important historic characters, statesmen, lawyers, literary men, scientists, inventors, engineers, artists, musicians, theologians, &c.

IT IS A COMMERCIAL DICTIONARY, explaining economic principles, treating fully the practical details of the chief industries, and giving elaborate accounts of manufacturing processes.

IT IS A DICTIONARY OF THE SCIENCES—Students of natural history, botany, geology, astronomy, chemistry, &c., will find an ample general record of modern progress in the special sciences.

IT IS A DICTIONARY OF THE FINE ARTS, explaining the technical terms, theories, and processes, and giving a historic and biographical record of the various branches of the Arts.

"THE NEW POPULAR ENCYCLOPEDIA" is, moreover, a Dictionary of the Practical Arts and Handicrafts, of Law, Medicine, Household Matters, Education, Music, Games, and Sports.

Prospectus of any Book post free.

The Household Physician.

A Family Guide to the Preservation of Health and to the Domestic Treatment of Ailments and Disease. By J. M'GREGOR-ROBERTSON, M.B. C.M. (Hon.). With an Introduction by Professor M'KENDRICK, M.D., LL.D., F.R.S., Glasgow University. Illustrated by about 400 figures in the text, and a Series of Engraved Plates. In 4 divisions, super-royal 8vo, cloth; also in Roxburgh binding, in 1 volume or 2 volumes.

One aim of this book is to supply in as plain language as can be used some knowledge of what science has to say as to the body which we inhabit; the second aim is to give reliable assistance in the domestic treatment of simple ailments. The bodily ills to which young and old are liable are considered more fully than is usual in popular works.

The first portion of the book treats of the human body in health, and the various changes produced by disease. This part has been divided into sections, each section being devoted to one set of organs. For example, the bones and joints are considered in one section, the nervous system in another, the digestive organs in a third, and so on. The first half of each section describes the particular organs in their healthy condition, and the second half discusses the diseases to which they are liable. By this method the healthy and diseased states of each part of the body are placed in relationship to, and mutually explain, one another. This section, moreover, contains special chapters on the MANAGEMENT OF CHILDREN IN HEALTH, the DISEASES OF CHILDHOOD, and the DISEASES OF WOMEN.

The second portion of the book is devoted to HYGIENE, or the conditions of health as regards FOOD, DRINK, CLOTHING, EXERCISE, &c., and the rules to be observed for the promotion of health, both of individuals and communities. Details are given of the requirements of a HEALTHY HOUSE, in its construction, ventilation, water-supply, drainage, &c.

In the third portion of the work the nature and mode of ACTION OF DRUGS and other remedial agents are explained. But this part includes more than mere drugs. ELECTRICITY, an agent as valuable in medicine as it is in commerce, and MASSAGE, or medical rubbing, another new and formidable antagonist to ill-health, will also be fully treated.

In the remaining portion of the book the methods of dealing with ACCIDENTS AND EMERGENCIES find a place, and the commoner SURGICAL INSTRUMENTS are described and their mode of use explained; SICK-NURSING receives attention, and recipes for INVALID COOKERY and Notes of MEDICAL PRESCRIPTIONS are given.

The ILLUSTRATIONS are very numerous, consisting of about four hundred figures printed in the text, and a series of thirty-one engraved plates, many of which are in colours.

A GREAT HISTORICAL WORK.

A History of the Scottish People.

From the Earliest to the Latest Times. By Rev. THOMAS THOMSON and CHARLES ANNANDALE, M.A., LL.D. With 40 Original Designs by W. H. MARGETSON, ALFRED PEARSE, WALTER PAGET, GORDON BROWNE, and other eminent artists. In 6 divisional volumes, super-royal 8vo, cloth elegant.

The main features may be stated as follows:

It is a full and detailed History of Scotland from the Earliest Times to the Latest.

It is a History of the Scottish People, their manners, customs, and modes of living at the various successive periods.

It is a History of Religion and Ecclesiastical Affairs in Scotland.

It is a History of Scotland's progress in Commerce, Industry, Arts, Science, and Literature.

It is illustrated by a series of original designs reproduced in facsimile from drawings by eminent artists.

Prospectus of any Book post free.

NEW EDITION, REVISED AND GREATLY AUGMENTED.

Ogilvie's OF THE ENGLISH LANGUAGE. A complete Encyclopedic Lexicon, Literary, Etymological, Scientific, Technological, and Pronouncing. Edited by CHARLES ANNANDALE, M.A., LL.D. Illustrated by above **Imperial Dictionary** three thousand engravings on wood, besides a splendid series of full-page plates, many of which are coloured. This edition of the IMPERIAL DICTIONARY is beautifully printed on paper of imperial size, specially made for the Work. It is issued in eight Divisional Volumes of a handy size for reference, bound in cloth, with a fine design on side; or in four volumes Roxburgh binding.

The reception accorded by the press and the public to this new edition of the IMPERIAL DICTIONARY has been such as to show that the care and labour bestowed upon it have met with due recognition, and to prove that it will continue fully to maintain its established position as a standard lexicon of the English language, and as a work of the highest utility for the purposes of general reference and everyday requirement.

DISTINCTIVE POINTS.

To sum up the chief points of this edition—

- I. It is the latest revised dictionary, and has a supplement of many thousand new words.
- II. It contains more words, exclusive of compound and obsolete words, than any other English dictionary.
- III. The pronunciation is explained on a plan which is simplicity itself.
- IV. It gives the pronunciation and the meaning of the word as recognized *to-day*.
- V. It has more illustrations than any other English dictionary.
- VI. It has full-page plates (coloured and otherwise), which are an outstanding feature of the work. No other English dictionary contains full-page plates.
- VII. It has clear type, beautifully printed on fine paper, and is substantially and elegantly bound.
- VIII. It has a specially prepared Supplement issued with *each* volume, and not, as is usually the case, relegated to the end of the complete work.
- IX. It has a very full Appendix, probably the best and finest given with any dictionary in the world.
- X. It is sold on a plan at once acceptable and convenient, within the reach of all, and the price is very moderate.

“The IMPERIAL DICTIONARY”, says the *St. James' Gazette*, “is a work which fairly deserves the epithet of monumental. It is really what it professes to be—a complete encyclopædic lexicon, literary, scientific, and technological”. In other words, it is the best dictionary of its kind in the English language, and its kind is the best.”

“We have no hesitation in saying”, writes the *Spectator*, “that it will prove a most thorough piece of workmanship, and that among reference-books of its class it will hold the first place, both as an authority and a source of instruction and entertainment.”

“The encyclopedic method of treatment which has been adopted”, remarks the *Athenæum*, “will be found of the greatest service, affording as it does to the reader the advantages of the ordinary dictionary combined with those of the encyclopædia.”

The *St. James' Gazette* says:—“The encyclopædic part is executed with great skill and accuracy; and the genius of the editor has been exercised with the power and precision of a hydraulic press upon the enormous masses of facts with which he has had to deal”.

Prospectus of any Book post free.

The Cabinet of Irish Literature:

umes, super-royal 8vo, cloth extra, gilt edges.

SELECTIONS FROM THE WORKS OF THE CHIEF POETS, ORATORS, AND PROSE WRITERS OF IRELAND. Edited by CHARLES A. READ, F.R.H.S., and KATHARINE TYNAN HINKSON. In 4 vol-



Coulson Kernahan

As there is an Irish Nationality, so there is an Irish Literature, in which that Nationality has found expression. And what a magnificent Literature it is! how brilliant the roll of Irish writers from Swift, Steele, and Goldsmith, to Sheridan, Grattan, Moore, and the score of gifted men and women who are identified with the present renaissance of Irish letters!

THE CABINET OF IRISH LITERATURE is an attempt to give every Irishman, every Irish household, a share in the priceless treasures with which the literary genius of the race has enriched mankind.

It brings within the compass of a single great work a representative selection of all that is best in Irish Literature. Not, be it said, the old Irish Literature in the old Irish tongue; of that most is unknown to the people itself, though a good deal of it, in translation, will be found in this book. By Irish Literature is meant the Literature read and understood by the Irishmen of the present day—the expression of the ideas they really feel, of the life they truly live, in Mayo, in Limerick, in Cork, and in Derry.

It is a selection made without fear or favour, free from any bias, religious, political, or social. Merit is the only passport to its pages.

It gives, in brief pointed biographical notices, the life-history of every great Irish writer. We are enabled to realize the personality of the man as well as appreciate the qualities of his work.

It deals not only with the past but with the present; and it is the only work that brings home to us by illustrative extracts the great revival in Irish Literature that is now taking place. W. B. Yeats, Douglas Hyde, George Bernard Shaw, Nora Hopper, Seumas MacManus, Richard Ashe King, George Egerton, Moira O'Neill, are a few among the many scores of modern writers whose works are represented in the CABINET.

No Irishman who is proud of his nationality can afford to be without a work which thus focuses the whole intellectual activity of the race. To the younger generation it will be an inexhaustible source of inspiration, a priceless influence in forming their taste, in moulding their character—in a word, in perpetuating those qualities which now, as in the past, are associated with the name of Irishman.

The CABINET was originally planned by Mr. Charles Anderson Read, but this accomplished Irish poet and novelist did not live to see the fruition of his hopes. His work was completed by Mr. T. P. O'Connor, under whose auspices the first edition was issued. Now, after the lapse of nearly a quarter of a century, the time has come for a new edition of this monumental work, which shall take due account of the extraordinary activity in Irish letters during the intervening years. Under the able editorship of Miss Katharine Tynan (Mrs. Katharine Tynan Hinkson), herself one of Ireland's most distinguished writers, the work has been thoroughly revised and brought down to the present hour.

In its get-up it is all that a book of its great importance should be. The illustrations are many and of the highest artistic value. Some of the most eminent black-and-white artists of the day, including John H. Bacon, Charles M. Sheldon, W. Rainey, R.I., G. P. Jacob-Hood, R.I., and W. H. Margetson, have been commissioned to illustrate typical scenes from the masterpieces of our literature, and these drawings, rendered by the latest processes of photographic reproduction, and printed on specially prepared paper, add an unique charm to the work. The CABINET is further embellished with a large number of photographs of the most eminent Irish writers; and the cover design, in gold upon green cloth, is the work of Talwin Morris, the well-known designer.



F. Frankfort Moore

Prospectus of any Book post free.

The Book of the Home.

AN ENCYCLOPEDIA OF ALL MATTERS RELATING TO THE HOUSE AND HOUSEHOLD MANAGEMENT. Produced under the general editorship of H. C. DAVIDSON, assisted by over one hundred specialists. Copiously illustrated by coloured and black-and-white plates and engravings in the text. In 4 volumes, super-royal 8vo, cloth, with artistic design; also in 8 divisional volumes, cloth.

THE BOOK OF THE HOME is intended to form a complete work of reference on all subjects connected with household management. No efforts have been spared to ensure that every matter bearing upon the Home and Home Life shall receive full and sufficient treatment, and that the information given shall be reliable and in the best sense of the phrase up-to-date.

A few among over one hundred specialists who have contributed to the work:

Mrs. ADA S. BALLIN, Editor of <i>Baby—the Mother's Magazine</i> , and of <i>Womanhood</i> .	Miss GERTRUDE J. KING, Secretary to the Society for Promoting the Employment of Women.
Miss BERTHA BANNER, Training Teacher of Sewing and Dressmaking at the Liverpool Technical College for Women.	Miss E. E. MANN, Head Teacher at the Liverpool Training School of Cookery.
Mr. A. BLACK, C.E., Architect, Author of <i>First Principles of Building</i> .	Colonel M. MOORE-LANE, Contributor to the <i>Field</i> and other agricultural papers.
Mrs. DAVIDSON, Author of <i>Dainties, What our Daughters can do for themselves, &c.</i>	Mrs. C. S. PEEL, Dress and Household Editor of <i>Hearth and Home</i> , and Author of <i>The New Home</i> .
Miss J. FORSTER, Principal of the Cheshire County Council Dairy Institute.	Miss P. SIBTHORPE POOLEY, Lecturer to the Liverpool Ladies' Sanitary Association.
Mrs. H. R. HAWES (the late), Author of <i>The Art of Decoration, The Art of Beauty, &c.</i>	Miss RANKIN, Head Teacher of Laundry Work at the Liverpool Technical College for Women.
Miss HELENA HEAD, Principal of the Liverpool Girls' School for Secondary Education in Domestic Science, and Author of the <i>Manual of Housewifery</i> .	Miss FLORENCE STACPOOLE, Lecturer to the National Health Society and the Councils of Technical Education, and Author of <i>Handbook of House-keeping for Small Incomes, &c.</i>
Mrs. A. HODGSON, Home Decorator to <i>The Lady</i> .	Mr. DAVID TOLLEMACHE, late editor of <i>The Chef and Connoisseur</i> .
Mr. R. KEITH JOHNSTON, Author of <i>Household Difficulties and How to overcome Them</i> .	

The contents of THE BOOK OF THE HOME may be grouped under four heads. The first deals with all matters concerning the House—from the choice of its site to the least of its internal decorations. The householder is instructed in the laws regarding landlord and tenant, and counselled in the important matters of sanitation and ventilation, heating and lighting, and the stocking and management of the garden. The housekeeper is advised as to furnishing, everything necessary for the comfort and adornment of a well-equipped house being described in detail, hints being also given regarding removals, painting and papering, artistic decoration, arrangement of linen and store cupboards, &c.

In the second the daily routine of the Household is considered—the duties of the servants, their wages, their leisure and pleasures, the management of the kitchen, laundry, and store-room. Plain and fancy cooking receive due attention, recipes being given of a large variety of dishes, and suggestions made for breakfast, lunch, afternoon-tea, dinner, and supper. A number of menus are added suitable for the different seasons. Invalid cookery also has its special section.

In the third are discussed the legal and customary duties, and the occupations and pastimes, of Master and Mistress, the former being instructed as regards insurance and the making of a will, and the smaller matters of carving, the care of the wine-cellar, and the inspection of garden and stables, while the latter is advised as to account-keeping, payments, shopping, and innumerable other matters connected with her duties as Mistress. Other subjects treated under this head are dress, home occupations, visiting and entertaining, and indoor and outdoor amusements.

In the fourth sound, systematic, and practical advice is given as to the management, in health and sickness, and the education, of children and also on such important subjects as occupations for boys and girls, the ceremonies necessary on the coming out of a daughter, and the preparations and formalities necessary before and after a marriage.

THE BOOK OF THE HOME will thus be at once an indispensable ally to the young bride and the novice in housekeeping, and a valuable work of reference to the more experienced.

Prospectus of any Book post free.

The Natural History of Animals:

The Animal Life of the World in its various Aspects and Relations. By J. R. AINSWORTH DAVIS, M.A., of Trinity College, Cambridge, and of University College, Aberystwyth. Profusely illustrated with full-page colour and black-and-white plates, and engravings in the text, by eminent animal artists. In 8 half-volumes, cl. extra, also in 4 volumes, Roxburgh binding.

While the sum of human knowledge is gigantic now as compared with what it was a hundred years ago, in the department of Natural History the books upon which the great majority of us must depend have undergone practically no change. The general Natural History still follows the lines adopted by Goldsmith in his famous and delightful *Earth and Animated Nature*. That is to say, they are little more than classified catalogues of animals, taking up in succession the various groups and individuals, and describing them one after another, each as standing by itself. This is not what the intelligent reader of the present day requires. He must be put in a position to take a comprehensive grasp of the subject; he demands a competent guide, not a directory, however accurate.

It is with this end in view that THE NATURAL HISTORY OF ANIMALS has been compiled. It treats this great subject on essentially modern lines, giving an accurate and vivid account of the habits, relationships, mutual interdependence, adaptation to environment, &c., of the living animals of the world.

It is needless to say that the production of such a work demanded a man who has devoted his life to the study of biology and zoology, and who at the same time is a gifted writer and expounder. This rare combination has been found in the person of Prof. J. R. AINSWORTH DAVIS, M.A., of Trinity College, Cambridge, and of University College, Aberystwyth, the author of the present work. Prof. DAVIS is well known to naturalists as an ardent worker in Natural History, particularly in the field of marine zoology. He is a very distinguished graduate of Trinity College, Cambridge, the chief scientific school in Britain, perhaps in the world, and has done a great deal of literary work, both scientific and in other directions.

Briefly, the object of Prof. Davis's work is to give in a readable form and in non-technical language a general survey of the whole animal world from the stand-point of modern science—and the work may fairly claim to be a **Natural History on a new plan**, the first comprehensive work in English of its own special kind. Formerly Natural History had much the character of a miscellaneous aggregate of disconnected facts, but hardly any fact or feature connected with any animal can now be considered as isolated from others; and animals as a whole must be looked upon as interrelated in the most surprising manner both with one another and with their surroundings.

Every household library should contain a Bible, a Dictionary, an Encyclopedia, and a work on Natural History. This is the "irreducible minimum"; other books we may have, these we must. For THE NATURAL HISTORY OF ANIMALS it may fairly be claimed that it has a better title than any other work to become the **Natural History for the Household**. It is a work in which the adult reader will find a never-failing mine of information, while the younger members of the family will delight in its wealth of illustration, and its store of interesting and suggestive anecdote.

To teachers THE NATURAL HISTORY OF ANIMALS may be regarded as indispensable. More than usual attention has of late been directed to the important subject of **Nature-study**; and in this respect the appearance of Prof. Davis's work could scarcely have been more fittingly timed. In the domain of Natural History it is pre-eminently the book for the purpose. Its clear and orderly arrangement of facts, its masterly grasp of general principles, its comprehensiveness of scope and simplicity of style, combined with the most absolute scientific accuracy, render this work an invaluable book of reference for those who aspire to teach Nature-study on up-to-date principles.

The Illustrations, as befits a work of such importance, are on the most lavish scale. A large number are in colour, reproductions, by the latest processes of colour engraving, of exquisite pictures by the most eminent animal draughtsmen. In illustrating the work talent has been sought wherever it was to be found; and the list of artists is representative of several nationalities. A large number of the designs are the work of Mr. A. FAIRFAX MUCKLEY, who is probably unsurpassed in the capacity to depict living creatures with absolute fidelity to detail without sacrificing the general artistic effect. FRIEDRICH SPECHT, one of the most eminent German animal painters of the past century, is represented in THE NATURAL HISTORY OF ANIMALS by many of his best designs in colour and black-and-white. W. KUHNERT, another German artist whose work is universally admired; and M. A. KOEKKOEK, the talented Dutch painter, are also among those who have assisted in the embellishment of the work. An important feature is the series of diagrammatic designs showing the structure of certain typical animals, specially drawn under the direction of Prof. Davis.

Prospectus of any Book post free.

The Modern Carpenter, Joiner, and Cabinet-Maker:

A Complete Guide to Current Practice. Prepared under the editorship of G. LISTER SUTCLIFFE, Architect, Associate of the Royal Institute of British Architects. Member of the Sanitary Institute, editor and joint-author of "Modern House-Construction", author of "Concrete: Its Nature and Uses", &c. With contributions from many specialists. Illustrated by a series of about 100 separately-printed plates and 1000 figures in the text. In 8 divisional volumes, super-royal quarto, handsomely bound in cloth, with cover design by Mr. TALWIN MORRIS; also in 2 volumes, Roxburgh binding. In complete sets only.

In preparing THE MODERN CARPENTER the editor has had the great advantage of working upon the basis of Newlands's *Carpenter and Joiner's Assistant*, which for nearly half a century has been accepted as a **standard authority** on the subjects of which it treats, and for many years has been recommended by the Royal Institute of British Architects as a **text-book** for the examination of that society. And yet in the present work it has been possible to preserve only a very small part of Newlands's treatise, invaluable though this has been to two generations of craftsmen. While the fundamental features of arrangement and method which distinguish this famous work have been retained, the matter has had to be **entirely rewritten**, and many new sections have been added, on subjects not touched upon in the older work, with which the carpenter of the present day requires to be familiar.

In the new book, indeed, the old foundations that have stood the test of half a century of practical use have been retained, but **the superstructure is wholly new.**

The lesson to be learned from this fact is not far to seek. It is that the modern carpenter requires a **far wider expert knowledge** than sufficed his predecessor. The development of wood-working machinery, the introduction of new kinds of timber, improvements in the design of structures, the more thorough testing of timbers, and progress in the various industries with which Carpentry, Joinery, and Cabinet-making are intimately allied, have all helped to render the craft more complex. The carpenter of the present day has no use for the old "rule of thumb" methods, his calling is both an art and a science, and **knowledge, knowledge, and again knowledge** is the primary condition of success.

The editor of THE MODERN CARPENTER, **Mr. G. Lister Sutcliffe**, Associate of the Royal Institute of Architects, **needs no introduction** to practical men; his name is already well known not only through his professional position in the architectural world, but through his editorship of *Modern House-Construction*, a work which, although issued only a few years ago, has already become a standard book of reference. Mr. SUTCLIFFE'S large experience has enabled him to enlist the services of a **highly-qualified staff of experts**, whose special knowledge, acquired through long years of practical work, is now placed at the disposal of every member of the craft. The first condition in selecting the contributors to the work was that they should be **practical men**, not only possessing the indispensable knowledge, but having the ability to impart it. The result is that within the eight divisional-volumes of this work we have a treatise on every branch of the craft, distinguished by four outstanding qualities:— It is (1) **complete**, (2) **clear**, (3) **practical**, and (4) **up-to-date**.

An idea of the scope of THE MODERN CARPENTER may be gathered from the fact that while its predecessor, *The Carpenter and Joiner's Assistant*, comprised only **eight** sections, the new work includes no fewer than **sixteen**. A glance at these will show that the work **covers the whole field**; it is a complete encyclopædia upon every subject that bears upon the everyday work of the practical man

- | | |
|--|---------------------------------|
| I. Styles of Architecture. | IX. Staircases and Handrailing. |
| II. Woods: Their Characteristics and Uses. | X. Air-tight Case-Making. |
| III. Wood-working Tools and Machinery. | XI. Cabinet-Making. |
| IV. Drawing and Drawing Instruments. | XII. Wood-Carving. |
| V. Practical Geometry. | XIII. Shop Management. |
| VI. Strength of Timber and Timber Framing. | XIV. Estimating. |
| VII. Carpentry. | XV. Building Law. |
| VIII. Joinery and Ironmongery. | XVI. Index, Glossary, &c. |

The Illustrations are not the least of the many notable features of this great undertaking. The work is embellished in the first place with about **100 full-page plates**, reproduced, some in colours, by the most approved processes of mechanical engraving, and printed on specially-prepared paper. In addition to this unique collection there are no fewer than **1000 diagrams and designs** in the body of the work. No trouble or expense has indeed been spared to procure illustrations where these could elucidate the text.

Charles Dickens' Novels.

The Imperial Edition of the Novels of CHARLES DICKENS, in 16 volumes, large square 8vo, cloth extra, gilt top.



An Ideal Issue. ONE NOVEL, ONE VOLUME. Despite varying lengths, the paper, &c., is so adjusted that each volume is uniform in thickness and size.

The Cheapest Edition. The price of each volume makes the edition the *cheapest of the best editions*.

Sumptuously Bound. The cloth is of the finest and is imperial red in colour. The embellishments (produced in gold) are an appropriate design of national arms and imperial emblems by the eminent designer, Talwin Morris.

Illustrations a Unique Feature. Every picture drawn specially at enormous cost for this "Imperial" edition by the best known and most celebrated Artists of *to-day*.

George Gissing's Masterly Study. A literary character study, the work of this great authority, forms one of the volumes of this issue, and is illustrated with pictures of some of the quaint old hostelrys and places made famous by Dickens, and is altogether an invaluable addition to this issue.

Presentation Portrait. To every subscriber to this edition will be presented with the last volume a magnificent Photogravure of Charles Dickens. It is printed on the finest plate paper, 22 inches by 30 inches, and has been specially engraved for this edition.

A List of the Novels.

The following is a list of the volumes in the Imperial Edition:—

- The Pickwick Papers.
- Oliver Twist.
- Nicholas Nickleby.
- Martin Chuzzlewit.
- The Old Curiosity Shop
- Barnaby Rudge.
- David Copperfield.
- Bleak House.
- Sketches by Boz.
- Hard Times and Master Humphrey's Clock.
- Christmas Books.
- Dombey and Son.
- Little Dorrit.
- A Tale of Two Cities.
- Great Expectations.
- Charles Dickens: A Critical Study. By GEORGE GISSING.



Prospectus of any Book post free.

