

THE  
**Incandescent Gas Light:**

**ITS HISTORY, CHARACTER AND OPERATION.**

Compiled for the Inventor, the Manufacturer  
and the Consumer.

By **WILHELM GENTSCH,**  
*Engineer in the German Federal Patent Bureau.*

---

TRANSLATED BY SIDNEY A. REEVE, M. E.

---

PUBLISHED BY  
PROGRESSIVE AGE PUBLISHING CO.,  
280 BROADWAY, NEW YORK.  
1896.



61596

6160285

SIG

G28

### PREFACE.

The economic success of Dr. Auer's invention has placed the incandescent gas-light in the front rank of common interest; it has spoken in favor of the Welsbach light more powerfully than any treatise on either side of the question. A numerous series of articles are already dedicated to it which treat solely of the operation of the device or of its increasing spread. In contrast thereto the author has set himself the task of tracing the entire development of the incandescent gas-light and, wherever noteworthy predecessors are found, of discussing the reason why they did not survive. First, the situation of the incandescent gas-light of to-day must be built up from the broad foundation of its history. This process has permitted its view from a series of standpoints hitherto scarcely noticed, if at all, from which many preliminaries and improvements may be judged, and perhaps alterations also investigated. At any rate, the comparison with similar older devices, tried by service, may permit a more certain decision as to the relative direction in which an improvement on the Welsbach light may be sought.

WILHELM GENTSCH



## CONTENTS.

- CHAP. I. Predecessors of the present incandescent gas-light.
- CHAP. II. Mantles.
  - I. Composition.
  - II. Form.
- CHAP. III. Burners.
  - I. Burners for gaseous fuel.
  - II. Means for increasing the luminosity.
  - III. Burners for liquid fuel.
- CHAP. IV. Regulation.
- CHAP. V. Ignition.
- CHAP. VI. Protection of mantles (chimneys, etc.).
- CHAP. VII. Lamps, globes, and lanterns.
- CHAP. VIII. Operation of the Welsbach light (advantages, disadvantages, applications, etc.).

—:o:—

The Monazite Deposits of North and South Carolina.—By H. B. Nitze.  
Incandescent Lighting by Gas and Electricity in Combination.  
The Decision of Justice Wills in the English Welsbach suits.



## THE INCANDESCENT GAS-LIGHT.

### CHAPTER I.

#### PREDECESSORS OF THE PRESENT INCANDESCENT GAS-LIGHT.

At the start, the incandescent light may be defined as that luminous gas-flame in which atoms of carbon are separated from the ingredients of the gas and brought to incandescence by the heat of the flame which accomplishes this separation before combustion is complete. Where this process is lacking the development of light cannot take place. In time, however, the term "incandescent gas-light" expanded so that certain foreign bodies not furnished by the gas-supply were heated by the gas-flame and so brought to a luminous condition. Now that this idea has been narrowed, as a result of the invention of the Welsbach light, to the rare earths as incandescent material and the non-luminous Bunsen flame has served as a source of heat, the connection with other material for light and heat is so narrow that a review of older systems is proper.

As far as is revealed by information hitherto at hand, DRUMMOND, in 1826, or possibly 1828, first evolved the so-called *lime-light* (or *sidereal* or *oxy-hydrogen* light), through the influence of an oxy-hydrogen blast upon a crayon of lime, afterwards replaced by magnesia and later by zirconia. The flame of a mixture of two volumes of hydrogen to one of oxygen rendered these materials incandescent, with the emission of yellowish light from the lime, bluish light from the magnesium, and white light from the zirconium. The Drummond light found special application to the problem of marine optics, but developed great inconveniences for general illumination. In the first place, the necessity for using two gases, hydrogen and oxygen, in large quantities constituted a great objection, but then the incandescent material itself was unreliable; it warped or consumed in such a manner that the luminous core altered its position in the body, to the disadvantage of the light.

TESSIE DU MOTAY, in 1867, replaced the hydrogen by bituminous-coal gas, but with some decrease in luminous effect. Lights were installed under his supervision in the Palace of the Tuilleries and the Place de l'Hotel de Ville, but their operation proved to be uneconomical.

Later LINNEMANN<sup>1</sup> took up the idea, in directing a coal gas-oxygen flame against a plate of zircon, in order to obtain a light suitable for scientific purposes. Although the zircon plate became white-hot, intense radiation was limited to a surface of only one-fifth of an inch in diameter, so that great intensity was attained. Experiments have proven that at a pressure of 2.4" [of mercury] for the gas and about fifteen-fold value for the oxygen, there was necessary, for the development of

60 candle-power,	0.84 cu. ft. of coal-gas and	0.53 cu. ft. of oxygen ;
120 " " "	1.30 " " " " " "	0.91 " " "
200 " " "	1.69 " " " " " "	1.55 " " "

If a larger flame than that necessary for 120 candles was used a whistling sound limited further development of the light.

KOCH<sup>2</sup> also had in mind a light suited for scientific (medical) purposes for which he melted zirconia into porous glow-pieces suitably formed for the reception of the flame from the side: as cylinders, cones, balls, as needed. Forty amyl-acetate [thirty-five English] candles were developed by 0.88 cu. ft. of coal gas and 0.88 cu. ft. of oxygen.

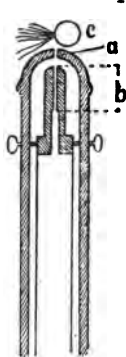

FIG. 1.  
LINNEMANN'S  
OXYHYDROGEN  
BURNER.

DROSSBACH<sup>3</sup> describes the alteration of a Maughan burner into a LINNEMANN oxy-hydrogen light (Fig. 1). *a* is the orifice for the coal gas,  $\frac{1}{8}$  of an inch in diameter; *b* the very fine orifice,  $\frac{1}{16}$  of an inch long, for the oxygen. The incandescent body *c* consists of zirconia which has been welded with 8 per cent of annealed boracic acid and then annealed. Oxide of cerium proved to be too easily melted.

The published experiments of SIR HUMPHREY DAVY stimulated ALEXANDER CRUCKSHANKS<sup>4</sup> to test the proposition to heat quartz or platinum bodies with non-luminous gas; it seems to especially apply to balls of platinum, or to networks of this metal coated with lime or other earths.

GILLARD<sup>5</sup> also used a basket-shaped net-work of platinum wire in his *platinum-gas* light. He produced the necessary gas by drawing steam over red-hot iron wire, a method which was very soon replaced by the water-gas process. The system was applied, amongst other places, to the well-known Christophle house in Paris and in the city of Narbonne, in Languedoc. It was last used in the years 1856 to 1865 as a splendid but very delicate, and therefore practically worthless, light.

SCHILTSKY<sup>6</sup> drew his oxygen from a holder *B* (Fig. 2) filled with compressed liquid gas, from which, by the valve handle *S* and pressure-regulator *R* in the supply pipe *l*, a uniform current of gas at a given pressure could be drawn. The pipe *g* supplies the fuel which is mixed with the oxygen at *f*, so that the flame of the mixture acts on

<sup>1</sup>The numbered references to patents of which this is one, will be found in a separate table at the end of the book.



the lime-plate *k*. The latter was laid horizontally by SEIFFERMANN<sup>7</sup>, and the above standing-lamp changed into a hanging-lamp, while the axis of the rays was altered from horizontal to vertical. One, two, or more, coal-gas-oxygen flames were directed from below against the lime-plate. The mixture of the two gases took place just before exit from the burner in a platinum sheath.

Besides various devices for the production, regulation, etc., of the oxygen and hydrogen gases used, of no interest here, WOLTERS and ROSLIN<sup>8</sup> describe a burner (Fig. 3) to be used with or without a reflector, standing upright or lying down. In any case the light issued through lenses, probably to diffuse the intense radiation. The incandescent body consists of lime or other suitable material and receives its oxy-hydrogen flame from the mixing-tube *k*. The mixing of the two gases begins in the blast-pipe *m*,

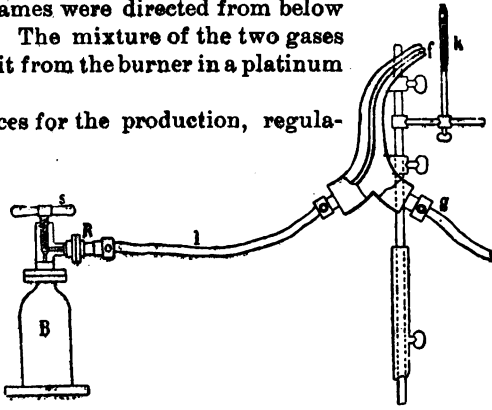

FIG. 2. SCHILTSKY'S BURNER.

through the middle opening *a* of which issues the oxygen and the hydrogen from the lateral holes *b*. *a* and *b* can be throttled at the same time, for which purpose the cock *c* opens or closes the flow from the pipes *h* and *o* in common. Care is taken that hydrogen always reaches the burner first. An ignition-tube *z* branches also from the hydrogen supply.

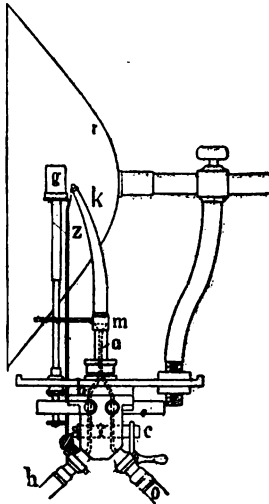

FIG. 3.—BURNER OF WOLTERS AND ROSLIN.

KHOTINSKY<sup>9</sup> goes a step farther in producing light by the incandescence of a refractory body in a flame of fluid, pulverized, or gaseous hydrocarbon, assisted by oxygen. As incandescent material, earths, especially alkaline earths, as oxides of calcium, barium, strontium, magnesium, aluminum, zirconium, etc., singly or in composition, are specified.

BRIN<sup>10</sup> contented himself in burning carbon pencils of a suitable sort in a stream of pure oxygen. The oxygen-jets were directed against the point of the pencil in such a manner as to impinge directly on the luminous center. In the place of the solid carbon could also be used petroleum or any other heavier or lighter liquid hydrocarbon; in which case the light, hitherto in the incandescent

class, would be altered into a petroleum or similar flame burning in oxygen.

In all the above-named cases oxygen plays an essential part; for the production of light by bringing the various materials, as lime, magnesia, etc., to white incandescence requires an extraordinary temperature, for which only the oxy-hydrogen blast flame is suited, in full-measure. The provision of such flames for operation on a large scale raises a difficulty which excludes the systems using them from wide introduction. Moreover, the perfection of the apparatus, the burner-construction, and the devices for preventing the formation of the blast-flame in the wrong place, demand much care, without which its operation is dangerous. This remains true when the hydrogen is replaced by the easily procured coal-gas, as long as it is mixed with the oxygen before burning. Moreover, such a substitution results in

a decrease of illumination, which should be considered, in purchase, in connection with the facilitation of fuel supply. But the loss becomes important when finally (and this was indeed the inevitable end) the oxygen was abandoned and the coal-gas burnt in atmospheric air; for it must be taken into consideration herewith that there is now involved the heating of about four times as much nitrogen as the oxygen necessary for combustion. If the efficiency of combustion in pure oxygen is to be approached the air supply to the flame must be pre-heated in some way.

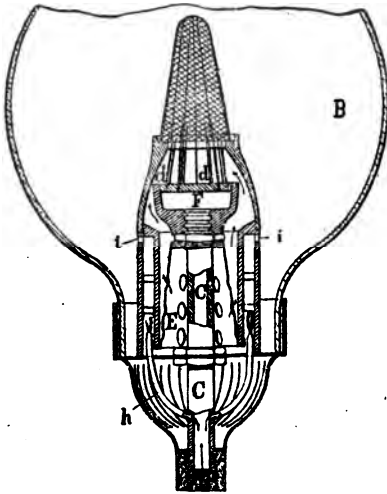

Fig. 4.—CLAMOND'S BURNER.

to operation early in 1860. According to early patents " he equipped a light arranged as a hanging-lamp with a central tube which was highly heated by special radial gas-flames and through which the air was fed under pressure to the burner. In the flow of this air from an orifice it carries with it the gas accumulated in a supply-chamber, so that a mixture of gas and highly heated air—CLAMOND gives its temperature as 1832° F—acts upon a lime pencil or magnesia basket. It is to be noticed that CLAMOND winds combustible material (paper) about his net-work basket, to protect it during transportation. The incandescent-body was also, in this case, hung in a platinum basket which was fastened by means of bayonet-locks upon easily fusible portions of the lamp.

In an older issue<sup>12</sup>, which applies to an upright lamp, CLAMOND sucks in air into a central tube, by means of a gas-current, from

CLAMOND put this alteration of the old incandescent light in-

which the air-gas mixture goes partly to the burner and partly through radial openings into a chamber where it burns in little jets and so heats the central air-tube. The latter is traversed by the air-supply for the flames burning in the magnesia basket.

This construction seems to have appeared dangerous to CLAMOND, for he had soon altered it<sup>13</sup> so that only gas passed through the tube *C* and the chamber *F* to the little burner-tubes *d* (Fig. 4). The heating of the air-chamber *E*, (divided by a cone whose purpose is not understood,) is accomplished by special flat flames, fed by the tubes *h*, whose products of combustion escape through the holes *i*. The use of liquid fuel was also to be accomplished by this apparatus. Mention might also be made of a later alteration of little significance<sup>14</sup> in which the flames for heating the magnesia basket strike inwardly, directed through holes in an annular chamber, instead of from bunches of little tubes.

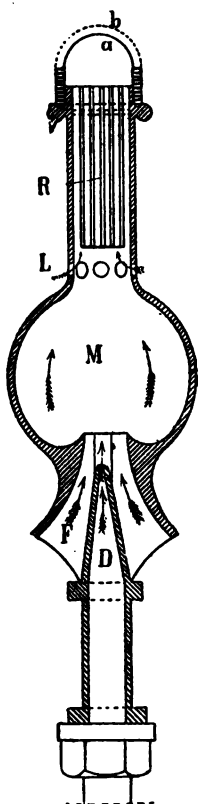

FIG. 5.  
SOMZEE'S  
BURNER.

SOMZEE attempted, in his first burner<sup>15</sup>, (Fig. 5.) to avoid preheating, although he similarly uses a capsule *a* of perforated lime or porous magnesia, which he covers with a platinum web *b*. He also recommends the use of platinum-sponge, whose melting point is somewhat higher, and also covering the incandescent matter with carbon-dust for increase in splendor of light. The burner itself is so formed that the gas issuing from a cone *D* sucks with it air through *F*, mixes with it in the spreading chamber *M*, so that the mixture, after receiving additional air through the holes *L*, passes through the tubes *R* under the capsule *a* and burns there with a blue flame. The result is hardly satisfactory. The designer therefore makes a step backwards<sup>16</sup>, and a very unfortunate one, in that he mixes air with the products of combustion of a gas-flame and leads this mixture into the above-mentioned chamber *M*, which usually contains air-inlets besides.

The already mentioned idea of utilizing liquid hydrocarbons for incandescent lighting is further frequently met. CHAIMSONOVITZ<sup>17</sup> thus designed an apparatus somewhat different from the rest. The peculiarity consists in that alcohol or other volatile hydrocarbon is drawn by a wick into a vaporization-tube where the vapor produced carries away with it air, and the air-vapor mixture is used to set into incandescence platinum or iridium wires. The heat is then carried back to the vaporization-tube. CHAIMSONOVITZ even falls upon the idea of uniting the action of an electric current and the alcohol-flame on the uminous material.

During the Crystal Palace exposition of 1882-83, at London, POPP's pneumo-hydraulic system of illumination aroused a wider interest, although POPP did not succeed, as did his predecessors, in giving his invention vitality. In fact, we meet here the same obstacle: the hypothesis of a need of far greater mechanism, for producing proper incandescence in materials, than is necessary, even in those difficult to make luminous. (Fig. 6.)

In this burner a mixture of air or other gas permitting combustion, with coal-gas or any other gaseous or vaporous hydro-carbon<sup>18</sup> is so generated that the air, (for instance) which is under pressure, is introduced axially into the gas-supply. The mixture thus made flows on into its own special passage-way and is led to the burner. The construction of the latter arose from the attempt to pre-heat the fuel sufficiently for the production of the necessary temperature of combustion within the luminous cap. In connection with the fixture is the central tube *i* upon which is a vertically adjustable head *k* of metallic or fire-proof material. The latter carries a fire-proof dome with an inclined parabolic portion *n* the lower end of which, *m*, exhibits a series of the largest possible number of small holes. The combustible material flows out of *i* through the cone *o*, holes *p*, head *k*, the cap *m n*, and burns outside the latter, heating the platinum net *q*. With the modification shown in Fig. 7, there enters a simplification in that the gas-mixture enters from *i* through the holes *r n* directly into the head and, heated by *o*, issues from the correspondingly perforated cap *l*.

The manifold inconveniences already noticed, which accompany artificial means of raising the natural temperature of the coal-gas flame, are now avoided by FAHNEHJELM<sup>19</sup> in that he exposes the luminous material solely to the action of a water-gas flame. He uses as a burner the single jet also used for illuminating-gas, or the two-hole or fish-tail burner, without excluding other patterns. FAHNEHJELM forms the incan scent portion out of fine, round or flat, needles or plates, which are set closely together in moderate number (up to one-hundred and above) in a rack of metal, porcelain, or pottery so as to form a comb (Fig. 8), as may best suit the form of the flame; or of needles bent into a loop, like hair-pins (Fig. 9.) simply strung on a metal hook and so hung over the flame; or, again, so as to represent a horizontal brush over an annular round-jet burner.

For the luminous material itself FAHNEHJELM prefers magnesia which is distinguished for its cheapness, white light, slight sensitiveness to changes of temperature, and little absorption of moisture.

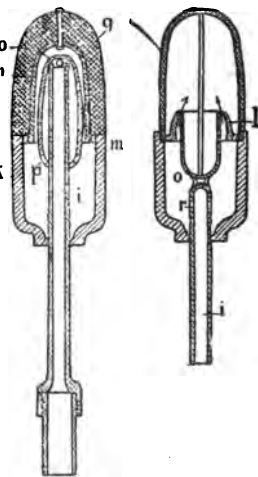

FIG. 6. POPP'S BURNER.

FIG. 7.

whether it be used as precipitated magnesium carbonate, as pulverized anhydrous carbonate, or as calcined or uncalcined dolomite rich in magnesia. However, other fire-proof oxides also, as lime, zirconia, silicic acid, etc., as well as refractory earths, as kaolin, cyanite, quartz, and their mixtures, are to be considered.

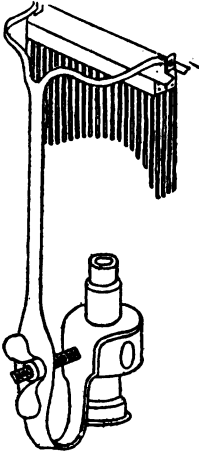

FIG. 8.  
FAHNEHJELM'S  
MANTLE.



Fig. 9.

The powdered, fire-proof mass is mixed up with a water-solution of starch, gum, or similar cohesive material into a plastic dough, which is then pressed out into thin threads by ordinary processes. These are cut, dried, and worked up into a comb, after which follows a preliminary roasting of the needles to burn out the organic cohesive material and to drive off the carbonic acid and water. At this point FAHNEHJELM's receipt for rendering the needles supple in the high temperature of the water-gas flame, that they may accommodate themselves to the form of the flame, appears of importance. In this the luminous material is added to a suitable flux, by a mixture of magnesia or lime to, for instance,

silicic acid, kaolin, or boracic acid.

In cases where water-gas was to be had and the Fahnehjelm system was installed for illuminating purposes<sup>20</sup> it has proven that it was wholesome; it has been recognized as practicable and cheap. In the fact, however, that it is chained to water-gas, to a gas which in spite of multifarious trials has not found a wide application\* and which is scarcely to be procured, is to be found the chief reason why FAHNEHJELM, too, has been unable to break the exorcism which hangs over all efforts at the introduction of an incandescent gas light.

\*In Germany. The Fahnehjelm burner had three chances in this country for proving its ability in public use—at Chicago, Ill., Jackson, Mich., and St. Joseph, Mo.—in all of which its use was found to be impracticable. TRANSLATOR.

## CHAPTER II.

### MANTLES.

#### I. *Composition.*

Before the time of Dr. Auer's record-breaking discoveries, as we have already learned in part from the first chapter, a whole series of materials had been utilized, with more or less permanent results, for the purposes of incandescent gas-lighting; although the Bunsen-flame, without the assistance of artificial devices, is rarely to be noticed. After the time of DRUMMOND'S light came, in particular, the platinum metals and the alkaline earths: as the oxides of calcium, barium, strontium, and magnesium; aluminum and zirconium may also be mentioned. The platinum metals brought into the field of experiment the entire series of heavy metals, as gold, silver, tungsten, manganese, iron, chromium, cobalt, nickel, and others, without any distinction as to whether these bodies existed as elements, pure metals, or in the form of salts.<sup>21</sup> The alkali-metals: potassium, sodium, lithium, rubidium, cesium, have proven themselves to be of just as little, if not even less, importance. Of the earth-alkali-metals, magnesium in particular has almost always been utilized, alone or in various combinations, as an incandescent material; the earlier productions thus from the start condemned their existence to failure by not having made use of a durable material. Without doubt, there was inherent in the above-mentioned substances made from the earth-alkali-metals an important capacity for the emission of light. They are not fire-proof, however; they volatilize in the flame, are brittle, and do not regain their form when once distorted by a too powerful flame.

The number of experiments, even if they lacked the guidance of logic, was justified by the knowledge that a luminous flame, in which carbon is separated and brought to incandescence by heat, offered an extremely defective utilization of the energy developed by the heat of combustion, so that only an insignificant portion of the work was changed into light and thus made useful, while the greatest portion was given up as useless heat. They leave no room for doubt that an illuminating system can only be developed on a large scale with a source of heat as easily obtainable as the above-mentioned luminous

materials, and which burns practically completely without reference to any emission of light. These conditions pointed very clearly to the Bunsen burner, in which the mixture of gas and air before combustion results in the formation of a non-luminous, bluish or bluish-green flame and a high degree of perfection of combustion. The carbon, now no longer separated, must be replaced by some material which conforms to the following conditions. It should possess a marked capacity for radiation of light, it must be fire-proof, it must not alter its form either by melting or vaporization, and it must be durable. To have solved these comprehensive problems in such measure that we are placed in possession of an incandescent gas-light capable of life, is the indisputable service of

DR. CARL AUER VON WELSBACH,

who chose the so-called rare earths for the purpose of luminosity. To avoid error, it should be noted that all that was known of the rare earths before Welsbach was that they became luminous when heated. This knowledge is axiomatic with whomsoever has tried laboratory-experiments with them. But a great gap existed between the establishment of this fact, almost unnoticed before, and the practical utilization of the phenomenon; and this gap was bridged by Dr. Auer's discovery.

The rare earths, as lanthanum oxide, yttrium oxide, etc., radiate comparatively little light. For instance, MCKEAN found, with the use of a burner consuming 3 cu. ft. per hour under 10-tenths pressure, that the light developed ran as follows:

Thorium oxide.....	3.56	Hefner candles.....	bluish white
Lanthanum ".....	28.32	" "	white
Yttrium ".....	22.96	" "	yellowish white
Zirconium ".....	5.36	" "	white
Cerium ".....	5.02	" "	reddish

Similarly, their durability is very slight. But if they are mixed, as by Dr. Auer, with one another or with magnesia or zirconium oxide in molecular condition, and the mixture severely roasted, there results a peculiar material which greatly exceeds the individual components in capacity for luminosity and in durability. The following proportions of mixture are mentioned as giving good results:"

60 % magnesia, 22 % lanthanum oxide, and 20 % yttrium oxide,  
 or 60 % zirconium oxide, 30 % " " 10 % " " ;  
 or 50 % zirconia and 50 % lanthanum oxide.

In these the yttrium oxide may be replaced by a mixture of yttrite earths and the lanthanum oxide by a mixture of cerite earths freed from didymium and containing little cerium. A rising proportion of yttrium oxide makes the color of the light yellowish-white, without injury to its intensity. The above mentioned materials, which radiate a dazzling white, can be toned down towards a yellow by the addition of a suitable proportion of neodym-zirconia, which radiates orange-yellow by itself, or towards a green by erbium-zirconia, which itself

radiates green. The magnesia in the magnesium-compounds, and the rare earths in the zirconium-compounds, play the role of base. A body in which magnesia and zirconium occur together does not possess, therefore, the good qualities of the above mixture, as trial has proven.

The components as above are brought into the desired proportion in solution in the form of salts, which are destroyed by incandescence with loss of the luminous material. A web (of vegetable fibre), previously washed with hydrochloric acid, is steeped in this solution and then incinerated by several minutes of continuous incandescence, so that the porous luminous bodies, which are supple and weld at a white heat, are saved. The form of the latter is suitably chosen, as we shall see later, so that it is surrounded by flame.

There might be inserted here a remark upon the cerium-group, which here steps into prominence, as distinguished from the zirconium-group. Cerium was discovered in the mineral *cerite* in 1803 by BERZELIUS, KLAPROTH, and HISINGER, and was later found in other minerals, as ytthro-cerite, orthite, euxenite, gadolinite, pyrochlorine, monazite, lanthanite, thorite, and orangite. MOSANDER pointed out lanthanum and didymium also in *cerite* in 1839. Zirconium is longer known and occurs crystallized, in rounded grains, and splintered, in granite, syenite, etc.: color: hyacinth-red (a jewel), brownish, or water-white. Its principal sources are the Ural, Ceylon, Bohemia, but also the Tyrol, Norway, and the Rhine district. Besides, large deposits of this material, formerly so little esteemed, have been discovered in North America, Siberia, Greenland, and Scandinavia.

We must not fail to note that AUER, even in his first publication, recommended the protection of the mantle, which was woven from threads about  $\frac{1}{16}$  of an inch thick, against tearing by the incinerating-flame, by the interweaving of heavier threads. The endangered portions of the mantle are touched up a second time with the solution, or dipped into it, so that stronger layers form there upon incandescence. The mantle or stocking is fastened to a platinum wire, and the connecting portions are treated in the same manner as the thickened portions, either by the use of the same solution as in the previous case, or a similar one of equal parts of magnesium or aluminum-nitrate, with an addition of phosphoric acid or glucinum-(beryllium-) nitrate.

AUER excludes, however, neither the application of fibrous (thread-formed) materials nor the use of amorphous, gelatinate, or extremely finely crystalline, precipitated matter.

Later AUER introduced thorium-oxide, which brought about an important rise in luminosity of the materials already known<sup>23</sup>; this is true in regard to the magnesia and zirconium mantle, as well as relatively to the compound of thorium-oxide with lanthanum-oxide or neodymium-, praseodymium-, or erbium-oxide, which latter furnish the colored (yellow, orange, or greenish) light. On the other hand, the combination of thorium-oxide with



magnesium, or with magnesia and aluminum-oxide (very dazzling) demands a higher temperature than the Bunsen-flame offers; similarly, mantles of cerium oxide with magnesia, or of zirconium-, lanthanum-, yttrium-, or thorium-oxide, remain non-luminous in the Bunsen-flame.

To make the incinerated mantle fit for transportation, it is dipped in a diluted solution of gum-elastic, collodion, or the like, so that a firm cover is formed, which is destroyed in the Bunsen-flame when the mantle is put into use.

The observed loss of luminosity AUER had apparently already attributed solely to the collection of fire-proof atmospheric dust on the surface of the mantle. To avoid such diminished activity, he undertook regeneration<sup>26</sup> by impregnating again the hardened mantle with a solution of lanthanum-oxide, etc., drying, and transforming the crystallized salts to earths in the burner-flame.

Later, AUER increased his series of luminous compounds by the

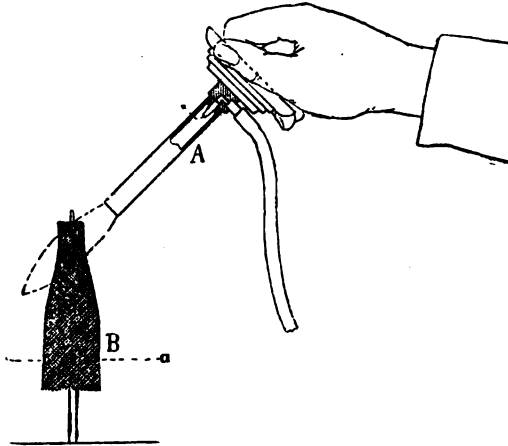

FIG. 9A.—INCINERATION OF THE WELSBACH MANTLE.

addition of uranium-oxide<sup>26</sup>; the latter was worked up, either with thorium-oxide or with the above-mentioned compounds, into an intensely luminous material of great durability.

In the now discarded manufacture of the Welsbach preparations, as carried on by the German Incandescent Gas-Light Stock Co. in Berlin, a stocking-net woven out of the finest Egyptian cotton was used as a carrier for the impregnating fluid<sup>26</sup> was carefully cleaned of all fatty matter in the way indicated, soaked in the solution of salts, and then dried. After cutting into suitable lengths and threading with asbestos loops, the raw mantles were worked up on a wooden mandrel by means of a "false leg," in which they are exposed on a cone of little brass wires to the action of a downwardly directed flame in such a manner that the incineration proceeds from the top of the mantle downwards for about a third of its length.

Up to that time a simple Bunsen-burner *A* (Fig. 9A) had been utilized, which was directed against the head of the mantle *B*, as shown plainly in the illustration. The flame played about its upper portion until it was burnt down to the mark *a*, which took about one

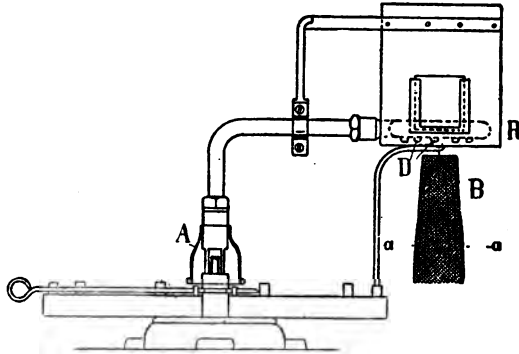

FIG. 9B.—KRUGER'S INCINERATING DEVICE.

minute, when the burner was put in use upon the next mantle, the remainder of the first accomplishing its own incineration. An abandonment of the process, however, had to result from its many disad-

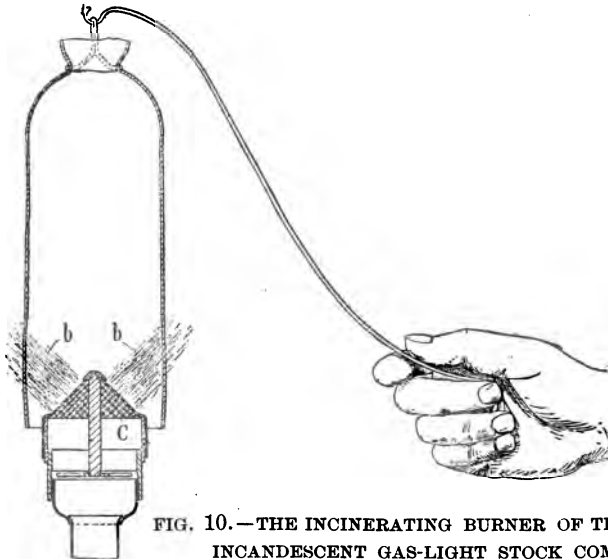

FIG. 10.—THE INCINERATING BURNER OF THE GERMAN INCANDESCENT GAS-LIGHT STOCK COMPANY.

vantages, such as the escape of gas through the air-holes of the mixing-tube, stoppage of the gas-tubing, as well as a deformation of the mantle (especially avoided in later treatment) due to a one-sided impact of the flame. KRUGER<sup>27</sup> (German Incandescent

Gas Light Stock Company) made the contrivance more suitable (Fig. 9 B) by using a burner, fastened in some way to the work-bench, having a vertical mixing-chamber *A*, while the tube, bent at a right-angle, runs out into a ring *R*; on this are nozzles *D* so placed that the issuing jets form the surface of a cone the apex of which lies in the axis of the ring *R*. The head of the mantle *B* is affected equally all around and, as above, is exposed to the action of the flame only long enough to incinerate two-thirds of it. The mantles are shoved under the burner or twisted about on suitable standards. KRUGER may also use gas and air under pressure.

In place of the older process of burning out, in which the incinerated mantle was heated over a Bunsen-burner and at the same time polished and formed with little glass rods, a manipulation which demanded exceptionally skilled labor, the German Stock Co. has introduced the following method.<sup>29</sup> The form is completed by the flame itself, for which purpose it must act upon the incinerated mantle with sufficient force and still equally on all sides. For this is used a burner *C* (Fig. 10) whose jet-openings are arranged on the surface of a cone (or perhaps on that of a cylinder) so that the flames *b* burn outwards like a funnel, under a pressure of 39 inches of water and over. If the mantles are moved up and down, over this burner, by hand or mechanically, the incandescent portion of the net is extended and smoothed. With some care even the raw mantles may be burned over this burner,

so that the first incinerating process is avoided.

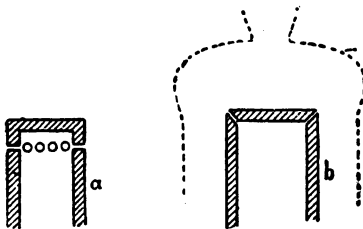

FIG. 10A.—PFLUECKE'S INCINERATING BURNER.

holes, when the upper portion of the mantle is to be rounded or formed otherwise.

The plan of hanging the mantle on a wire outside of itself, followed at an earlier date, is suitably altered so that a central rod forms the carrier without covering up the mantle.

FREDERICK LAWRENCE RAWSON<sup>30</sup> developed a correct Welsbach mantle by forming it on a round, somewhat tapering, platinum mandrel and exposing it, while there, to the heat of a blast flame. RAWSON'S plan for safe transportation is, however, especially important; the finished mantle is dipped in a liquid-hydrocarbon solution of paraffin, or in melted paraffin, whereby a paraffin-coating, easily removed by the Bunsen-flame without damage, encloses the mantle.

The increasing effects of AUER'S discovery make it broadly evident that incandescent gas-lighting, previously barely vegetating, has become the aim of numerous real and pretended inventors in

most civilized countries. If AUER claimed the rare earths as his own, the whole series of strongly luminous alkaline earths remain free. In order to utilize these valuable peculiarities without taking into the bargain the disadvantages shown by the mantles made from the alkaline earths (they are not durable, they do not weld but are brittle, they vaporize, and are, in short, practically useless) they have been provided with coatings which should increase their durability. Their tendency, however, to grow perceptibly dimmer after a few hours of service has not yet been circumvented. So far they have remained as unpromising for incandescent gas-lighting as the propositions for incorporating into mantles incombustible threads of organic or metallic matter for the sake of their strengthening effect, or for forming luminous bodies from plastic earths, from woven quartz-fibres, from asbestos, and so forth. Some illustrations are given here as proof of the above-mentioned tendencies.

Thus FAHNEHJELM<sup>21</sup> wished to cover incandescent plates, or the like, made of the oxides of magnesium, calcium, glucinum, or zirconium, or of mixtures of them, with a coating of fire-proof oxides of the heavy metals: manganese, chromium, cobalt, nickel, copper, and tungsten. The last mentioned oxides were suspended, finely powdered, in a solution of starch, rubber, water-glass, or the like, or as acids, or dissolved assalts in water, spirits, etc. The mantles were then dipped in the proper solution or the latter was applied with a brush.

HATTINGER<sup>22</sup> obtained, by heating to a red-heat a molecular compound of alumina and chromium-oxide, a rose-red material which radiated light of a reddish-yellow color. The net is impregnated by the application of a solution in water of, for instance, 100 parts of commercial aluminum-nitrate and 8 to 17 parts of chromium-hydroxide dissolved in nitric acid. The presence of fixed acids (phosphoric) or small portions of alkali or fire-proof oxides (of zirconium), should not hinder the formation of the material. The substitution of manganese oxide for the chromium-oxide causes the material to radiate a weaker, more yellowish, light.

SCHNEIDER<sup>23</sup> would make his mantle a firm skeleton of incombustible matter, as threads of platinum, quartz, silicic acid, asbestos, etc. He either weaves these threads into a carrier, to be burnt out, or he dips a fire-proof weave repeatedly into a fluid in which are floating finely divided fibres whereby is formed a combustible, fibrous coating which is impregnated later.

ECKL<sup>24</sup> also makes use of asbestos in all of its varieties, cutting it into little leaves (from  $\frac{1}{16}$  to  $\frac{1}{8}$  of an inch wide), or perforating it and placing it over the flame as a cylindrical or conical hollow body. The water is vaporized in the flame, leaving the metallic oxides which are the source of luminosity (alumina, potash or soda, magnesia, lithia, and iron oxide). The luminosity can be increased by coating with easily luminous oxides (by dipping in a solution of chloride of lithium and magnesium or iodide of potassium, etc.). The mica is

clamped between two discs, above and below, which are fastened together and to the burner-rim by a rod.

ROSENTHAL'S<sup>36</sup> mantle of burnt porcelain is the last to be mentioned. As it depends upon a thin-walled (he speaks of  $\frac{1}{16}$ , of an inch thickness) porous body, he uses wire-gauze over which is drawn a fine web. This is spread with the porcelain clay, which dries in about an hour. The mass is burnt in a retort, whereby the web falls out leaving pores in the porcelain mantle.

It may yet happen that the completion of the matter may see the fulfilment of an idea now close at hand: the utilization for incandescent gaslighting of the materials now used for electrical lighting. It is primarily important, in the production of light, that material be used which is capable of becoming intensely incandescent in the Bunsen-flame and of resisting at the same time the heat in the atmosphere.

Not far removed from the incandescent gas-light, especially when the surface radiates light similarly, is the following idea: a carbonized vegetable fibre coated, chemically or electrolytically, with nitrate of boron<sup>37</sup> or of silicon, or with refractory metals such as molybdenum, tungsten, chromium, and others, by which its surface is protected from injury. Experiments may, indeed, have been carried sufficiently far in this direction, but their results have only been to indicate just the more sharply the superiority of the Welsbach material.

Finally must be noticed the unusually extended British patent-records which, however, in spite of their variety, treat only of unimportant things and cannot lay claim to special criticism. LAKE'S<sup>37</sup> prophetic propositions alone should be mentioned—mere problems whose solution, in essential, was accomplished by AUER. Modest limits have been drawn, for instance, by STEPHAN<sup>38</sup>, DAVIES<sup>39</sup> SCHOTH<sup>40</sup>, PAGET and KINTNER<sup>41</sup>, HIRSHFELD<sup>42</sup>, and others, as they specify quite accurate processes. It is not even rumored that they ever stepped from the cream of English patents into practice.

## II. *Form.*

It should be recollected, in reference to the foregoing observations, that incandescent bodies may be divided, all in all, into three groups: first, those consisting of plastic material which endures manufacture and incandescence alike; then, those relying for support upon a skeleton which burns out upon incandescence; and finally, those made with a firm framework which withstands incandescence and most often takes part in the production of light. The Welsbach invention plainly falls under the second category. Moreover, it is evident, without further words, that immediately upon the development of the latter the propositions for the use of single elements, or their combinations, quickly became innumerable, without any of them having as yet attained the desired goal.

Much more important is the question of the most suitable form for the incandescent material, when once a practical and suitably durable one is found. On this point ideas appear, before and after

von Welsbach, one after another, in wild confusion, rarely betraying any logic. Here are perceived the plates and crayons of the lime-light, which are too far removed from the real incandescent gas-light; close upon them follow baskets of platinum, magnesia, etc., for the incandescence of which an ordinarily produced flame is not sufficient, but which demand a blast in addition. In some the flame itself, and in some merely the products of combustion, stream through the meshes of the basket-work. It is now known that the latter is rendered most brightly incandescent only when it is brought into the hottest zone of the flame; but the basket and the continually changing blast-flame do not allow themselves to be so fitted to one another that the former and the hottest portion of the latter coincide, to say nothing of the rapid alteration in the basket-work itself. The most intense zone of combustion and the basket will continually intersect one another, even in the most favorable case, now at a smaller and now at a greater angle, so that now a more narrow ring, and again a broader one, is subjected to the strongest temperature.

Similar restrictions apply to the relation between the flame and the ground, which is illuminated more or less according to the distance of the mantle from the top of the intense zone of combustion, which, moreover, may be badly torn by the flame working under such high pressure. All of these considerations make it plain that a favorable equalization of the flame for the production of light is not to be thought of. Complete perfection is only to be expected when the incandescent material is surrounded by the hottest zone. If the former be removed from the latter, or what is the same thing, if the flame be too large or too small, the efficiency falls.

Similar considerations lead further to the conclusion that the irregularly burning blast-flame *must* result in a variable illumination, since a variable mass of incandescent material is brought into brightest radiation.

The contrivance hit upon by SCHOTH<sup>43</sup> might indeed have remedied this difficulty. It consisted of two or more platinum baskets, set one over the other and so forming separate combustion chambers.

With this must be noted the fact that the vigorous passage of the products of combustion through the meshes of the incandescent material might result, in great part, in the deformation and destruction of the latter, in consequence of purely mechanical processes. The results of the experiments of VON HELMHOLTZ<sup>44</sup> upon the permeability of gases by light-waves are also applicable to the above-mentioned case, in which a thick cover, enclosing the gases impinging upon the incandescent material, detracts from the outward radiation of light from the same.

LUNGRÉN<sup>45</sup> worked up his illuminating substance (magnesia, zirconia, etc.) into threads or wires, plain or curled, and bent these into circles which were placed singly or in pairs (Figs. 11 and 12) over the non-luminous flame (of a coal-gas-and-air mixture or of water-gas) of an ordinary batwing burner. The incandescent threads are

nically formed about the flame *F* and are supported by means of the platinum wire *S*. The illuminating value of such a device may be concluded from the above remarks if one merely notices that the incandescent material occupies only an insignificant portion of the intense flame-zone and that not the heat of combustion, but merely the temperature of combustion, plays the important part in the process. It is moreover almost axiomatic, from the sensitiveness and mobility of

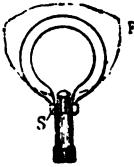

FIG. 11.



FIG. 12.

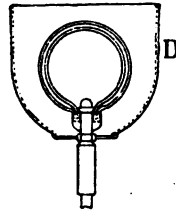

FIG. 13.

LUNGREN'S BURNER WITH INCANDESCENT FILAMENTS.

the batwing flame (the special result of its limited volume), that only a portion of it may strike the incandescent threads. LUNGREN himself must have noticed this later, for he soon devised the guide *D* (Fig. 13 for the flame.\*

---

\*As the Lungren light alone, of these various ones listed, has appeared in this country in commercial form, some further word about it may be of interest.

Lungren's first patent (No. 336,576; Feb. 23, 1886) was taken out on a "manner of supporting the incandescent filament" and shows, in its drawings, a helical coil of filament suspended in the axis of a chimney over the cylindrical jet of a Bunsen burner. Another form is given as a flat sinuous coil over a batwing flame and protected by a flat chimney. The chimney is mentioned in each claim."

His second patent (No. 365,832; July 5, 1887) refers to the filament itself and to one made of "the refractory earths—such as lime, magnesia, zirconia, etc." The drawings show various forms for the filament, of which Gentsch has chosen two for his illustrations, while the claims cover not only the filament itself but its manufacture "by expressing the material from a plastic mass in the form of fine threads and then forming these into a filamentary structure of the desired shape."

The third patent (No. 367,534; Aug. 2, 1887) covers merely the combination of burner and filament, in various specified ways, none of which are broad claims.

The fourth (No. 439,882; Nov. 2, 1890) covers the construction of the mantle, from filaments such as those described in the other patents, by weaving or interlacing, in contrast to the method, stated as previously in vogue, of winding "the threads comprising the structure upon a mandrel of the desired shape and pressing them together at the points of crossing."

The latest patent of Lungren which has come to our knowledge (No. 474,083; May 3, 1892) relates merely to the construction of a Bunsen burner of high-efficiency. It covers the use of a gas-regulator for varying pressures consisting of a disc floating upon the upward current of gas flowing towards the mixing-chamber, above which disc and fastened to it is a little needle-valve, closing, as the disc rises, the opening into the mixing chamber.

TRANSLATOR.

## THE FORM OF THE WELSBACH MANTLE

is the result of a quite different but correct point of attack. The quietly burning Bunsen flame possesses a firm envelop\*, which was made to serve as a model for its form. The Welsbach "stocking" (Fig. 14), which has been rightly taken as a pattern for incandescent gas-light mantles, bends itself about the flame from without, but at the same time leaves an exit for the products of combustion at its upper end. The flame develops itself freely, intensely heating the major portion of the luminous material in its envelop. The hot gases pass through the meshes of the mantle only to an insignificant degree, so that only a very thin zone of gas rises on the outside, enclosing the mantle in itself. This might indeed be considered as corroborated by the quiet



FIG. 14.  
AUER'S  
MANTLE.

light itself of the Welsbach mantle, the radiations of light from which are not continually diverted in various directions by bursting through trembling layers of gas. The fact that flame and mantle, moreover, maintain their proper relation is corroborated by some measurements carried out by SCHILLING in 1893<sup>66</sup>. In these, in one case, a Welsbach developed 49 candles upon 2.65 cu. ft. of gas-consumption and normal gas-pressure; after 900 hours of service under the same conditions it developed only 44.1 candles. Upon increasing the gas-consumption (by reaming out the gas-checks)

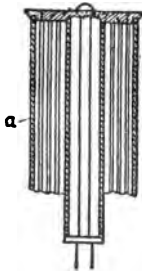

FIG. 17.—BAR-  
NETT MANTLE.

to 3.00 cu. ft., the candle-power, observed under the same pressure, rose to 47.1; and upon a rise of gas-consumption to 2.71 cu. ft. the illumination rose again to 66.5 candles. But in another case a lamp [not a Welsbach] which gave 45.2 candles upon 2.26 cu. ft. of gas-consumption suffered, upon an increase of the latter to 3.63 cu. ft., a diminution of candle-power to 21 as a result. In other words, in the first case, the mantle had spread itself so that only the envelop of the swollen flame could reach it, while in the second case the increase in size of the flame had resulted in the separation of the intense envelop of the flame from the mantle.

If it is to be admitted that the FAHNEJELM light designed for water-gas accomplished its purpose, it must be remarked, on the

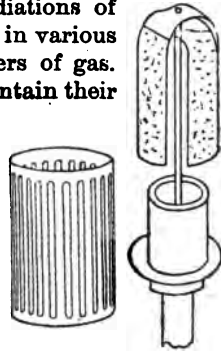

FIG. 15. FIG. 16.  
BARNETT'S BURNER.

\*It may be of interest here to explain that our word "mantle," which is so generally used in connection with the Welsbach light, is the result of a transposition into English of the German word, "mantel," which signifies, amongst other things, the "envelop of a flame, or that portion of it where the combustion is finally completed with the most active development of heat." The German word most generally used for the incandescent portion of a Welsbach light is "Strumpf," signifying "stocking," which we might better have translated into English and used in its corresponding sense.—TRANSLATOR.



opposite, that the needles chosen by that inventor could not give the usual effect of the Welsbach mantle. Nor could this happen to any greater extent with the slitted or perforated cylinders (Fig. 15) of BARNETT<sup>47</sup>, who also hung over a circular burner perforated ribbons in the form of a cross (Fig. 16). BARNETT also proposed a cylinder composed of little tubes, as *a*, Fig. 17. A favorable decision as to the value of the above variations from the Welsbach form of incandescent material may not be reached from the basis of the above observations.

## CHAPTER III.

### BURNERS.

#### I. *Burners for Gaseous Fuel.*

We have already taken occasion, in the description of some predecessors of the incandescent gas-light of to-day (already correctly identified in the earlier chapters as the Welsbach), to describe various burner-constructions. These will be briefly noted again, in passing, since valuable details are being continually added in the later productions.

As a supplement, however, mention might be made of the device (Fig. 18) invented by LEWIS<sup>46</sup>, which utilizes in an obvious manner a weave of platinum wire and a blast of gas and air. In the illustration the luminous basket is shown at *t*, the gas-supply at *a*, and the compressed-air supply at *b*.

It is worthy of note that LEWIS provides for the prevention of the conduction of heat from the incandescent material to the tubes *a* and *b* by interposing non-conductive material in the form of the ring *e* or the mixing-chamber *d*, made of soap-stone, graphite, or the like. How the development of light is to be diminished by heating the gas and air supplies, as he states, is above all things not evident. That air and gas, as far as they are heated, become proportionately lighter hardly applies. In another arrangement, moreover, the inventor attempts to accomplish the same purpose by dividing the two chambers *g* and *h* and connecting them merely by a series of very small bent tubes which are cooled by the atmosphere. The insertion of these tubes, however, is also to prevent the firing back of the flame toward *h*, and thus operate in the same manner as the sieve *f* (shown in Fig. 18) made out of wire gauze, finely perforated sheet-metal, soap-stone, or the like. It has proven practicable to place the exit openings of

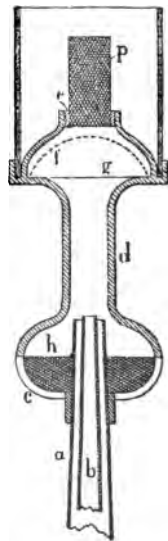

FIG. 18.—LEWIS'S BURNER.

the air- and gas-pipes *a* and *b* somewhat higher than the usual air-supply channel *c*. Finally, LEWIS at times enclosed it with sieves, the object of which in this case is not quite evident.

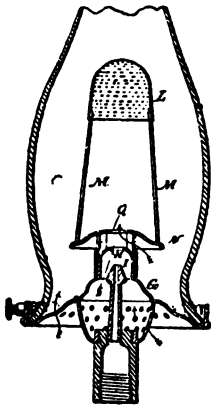

FIG. 19.—REQUA'S BURNER.

and *G* and again receiving air led to it from the chimney by the deflector *N*.

CLAMOND<sup>50</sup> (Fig. 20) utilizes a similar Bunsen burner in which a magnesia basket *M* serves as luminous material and in which the preheating of the gas and air is necessary for the satisfactory emission of light. The gas-and-air mixture, which has to pass through the wire cloth *t*, is therefore supplied through a number of little tubes *r* of a good heat-conducting material; for these CLAMOND prefers to use copper, one-eightieth of an inch thick, plated with nickel to prevent oxidation. Moreover, a chamber *h* is provided in which a portion of the heat developed is utilized in heating the little tubes *r*. The air needed for combustion enters by the holes *a* directly into the chamber *h*, being heated at the same time by *h* and *r*. For obvious reasons, there is interposed between the metallic chamber *A* and the mixing-tube a poor conductor of heat (steatite). The partition-plate *s* permits the air for combustion to enter only through *a*. A glass bowl *d* is designed to prevent any explosions or ignitions from occurring in the chamber *h*, by preventing the flame striking out through the holes from igniting the gas at the fixture-outlet *g*. A cone-shaped hood protects the

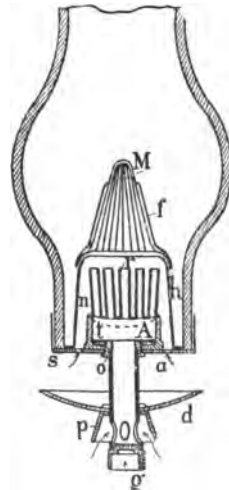

FIG. 20.—BUNSEN BURNER OF CLAMOND.

air-admission holes which lie over the openings for the issuing gas.

It should be remarked here that the magnesia basket *M* is fastened to a ring placed upon the chamber *h* by threads *f* of metal (nickel or platinum).

SELLON<sup>51</sup> proceeds much more simply to the same end, in that he uses an ordinary Bunsen burner. His burner is illustrated as a stand-lamp in Fig. 21. The gas flows through the supply-pipe *C*, to the tubes *B*, mixes with air entering through *E*, and then brings the mantle *F* to incandescence. The same designer later struck out the plan of bringing in the gas-and-air mixture through the luminous body and bringing it to combustion only above the latter. The mixing-chamber below the incandescent body is in this case made of transparent or translucent material. Fig. 22 illustrates the principle; the gas-and-air mixture proceeds through the tube *A* into the chamber formed by the lower portion *B* of the chimney and divided from the space bounded by the upper portion *C* of the chimney by the mantle *G*.

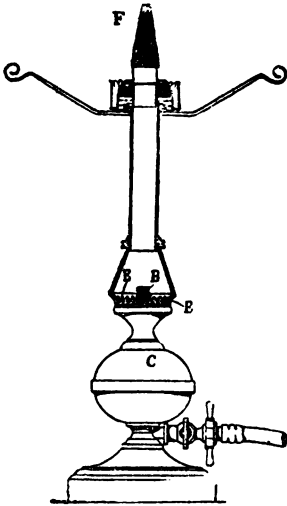

FIG. 21.

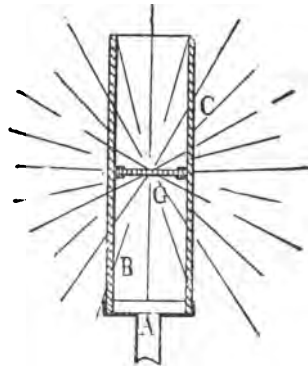

FIG. 22.

BUNSEN BURNER OF SELLON.

The mixture enters the space *C* through *G* and is here ignited, by which means the incandescent material *D* radiates light in every direction. SELLON describes a couple of variations of this principle of construction, as stand- and wall-lamps, which we will pass over superficially, only remarking that this proposition, interesting as a jest, has never been taken seriously.

The Bunsen burner, which must be regarded as having as its chief purpose the extension of the use of coal-gas in contrast to other fuels, has been adapted to the purpose of incandescent gas-lighting in the simplest manner since Welsbach brought his discoveries in the region of incandescent bodies into practice. Even the ordinary

burner with the smooth tube will satisfy the conditions as far as the form of the flame and of the mantle are concerned, the one with the other. But for a general and perfect illumination (which the burner is to bring about in only a short time, within an hour's consideration, so to speak) some alterations are nevertheless necessary, which have been naturally developed one after the other. It is due in large part to adversaries that, in a relatively short period of time, an apparatus operating with certainty has been developed from the primitive Bunsen burner by steps apparently slight but none the less important in their results. And in consideration of the reasons why the Welsbach incandescent light has been able to meet with such great favor, while similar older discoveries have been unable to get a step beyond limited application (as to both space and time), the fact is not to be under-estimated that the consumer has been given a burner that in management is obviously simple but which is faultless in operation.

When a suitable luminous material has been found to be good, it must be given a corresponding brilliancy. It must radiate a quiet, uniform light and must make no noise. Both can be effected by a proper construction of the burner. The size and position of the gas-supply openings and of the air admission, the proportions of suction-chamber and mixing-tube, have been so determined empirically that a given gas-pressure in the gas-supply will develop at any time a proper flame. WELSBACH has proposed, instead of allowing the gas to issue from a central hole bored in the supply-tube, as is usually the case, to ream out the gas-pipe to a larger diameter, to close it with thin sheet-metal, and to make several small holes in this. PINTSCH also proceeded in this manner (Fig. 23) in that he covered the pipe *d* with a perforated sheet *a*. In comparison with earlier practice the air-admissions *l* are placed lower than the gas-exit *a*. The air rising to the space to be illuminated, will thus not be in a position to divert the current of gas by possible entry through two air-admissions *l* lying opposite one another, and thus to operate detrimentally; there will apparently result, in greater probability, a diversion of the strongly entering stream of air in the direction of the gas-suction.

PINTSCH<sup>22</sup> had previously inserted in the burner-head, in order to avoid the noise of the ordinary Bunsen flame, a soap-stone body *k* which partly or entirely filled out the inner portion of the core of the flame so that explosive combustion could not take place in this portion of the flame. It should be remarked that the designer places at the mouth of the burner a capsule *b* uniformly bent about the body in question, which serves to center the mantle.

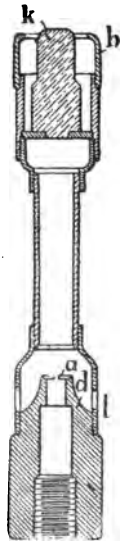

FIG. 23.  
A PINTSCH  
BURNER.

The burner of to-day, as applied to the Welsbach incandescent gas-light, carries a protective sieve covering the admission-opening, which prevents, according to well-known laws, the ignition of the gas-and-air mixture found in the mixing-tube; in which case the gas would burn immediately upon its exit from the little nozzle. This striking back of the flame occurs now and then in spite of all precautions, sometimes upon ignition and again during operation, but at the most quite rarely. It can be recognized by the extinction of the light as well as by a sharp whistling noise, before its other greater

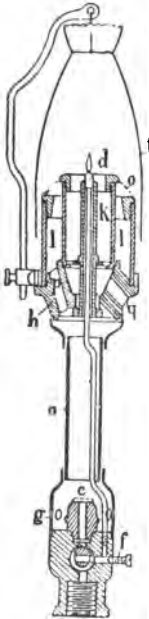

FIG. 24.  
A PINTSCH  
BURNER.

disadvantages (a bad odor and heating of the burner-tube) become noticeable. If the mantle is still aglow the trouble can be rectified by a quick closure and, immediately following, a rapid opening of the key. In the center of the protective gauze is placed a cone which serves as a guide to the mantle support and covers the central portion of the meshes. By this construction is secured an annular flame which possesses a larger envelop than a solid flame of the same gas-consumption, and consequently heats a broader mantle, permitting the production of a greater illumination. The air jets of the suction-chamber are projected out against the flame by an annular plate. The shell of the burner is made of thinly drawn brass-tubing so that there is no conduction of heat worth mentioning from the head to the mixing-chamber, even when no lining of soap-stone or the like is interposed.

With the use of larger mantles the question of the best relation between gas-consumption and active flame-surface comes again to the front. For this case PINTSCH<sup>33</sup> made the head of his burner of two concentric cylinders (Fig. 24), forming between them the annular space *l* for the passage of the air-and-gas mixture. The annular protective sieve *o*, highly arched towards the axis, guided the flame to the mantle. The inner cylinder *k* simultaneously conducted air to a portion of the flame for the purpose of its spread towards the mantle *t*. Between the head and the mixing-tube *a* is interposed a piece *h*, formed of material poorly conductive of heat, which is pierced by the passages *p* and *q*; the former leads the gas-and-air mixture from the mixing-tube *a* to the head-chamber *l*, while through the latter air passes to *k*, cooling at the same time the insulator *h*. Air-inlets *g* and gas-jets *c* are provided below in the usual manner. An ignition-device *d*, still extant, will be treated in a later chapter<sup>34</sup>.

It is hardly necessary to remark that AUER gave the impulse to an almost innumerable series of useful and useless, noteworthy and less worthy, propositions, as well as actual discoveries, all pertaining to the construction of the burner. To introduce them here would be to

carry coals to Newcastle and it is only possible, in closing, to review the most noteworthy.

For instance, STEWART<sup>55</sup> divides the Bunsen flame into little separate flames which heat incandescent bodies in the form of rods, needles, or tubes. The burner which he uses for the purpose consists, in essential, of a horizontal tube *g* (Fig. 25) which has in its crown little holes *b* and is so covered by a half-tube *e* as to form between *e* and *g* an air-chamber *h*. In the half-tube *e* are openings corresponding to the holes *b*, but larger and converging at the top into the outlets *f*. The gas issuing from *g* through *b* takes up air from the space *h* and the mixture

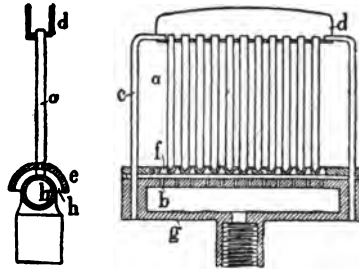

FIG. 25.  
STEWART'S BUNSEN FLAME.

passes the openings *f*, to burn above in little flames. The incandescent pieces *a* are arranged between the latter, loosely stuck through the saddle *d* formed of metal, steatite, or the like, and rest in the support of the cylinder *e*, free to expand at the top when heated. The holder *d* is fastened to the burner by means of the carrier *c*. When small tubes are used STEWART allows the flames to develop inside of them. The primary form of the gas-tube *g*, and that of the burner in consequence, may be, of course, widely varied, as into a star, a circle, a square, etc.

In contrast to the designer's views, however, no points are to be found which mark the device as practicable. The mixture of gas and air can only be incomplete; and even if an increase of flame-envelop

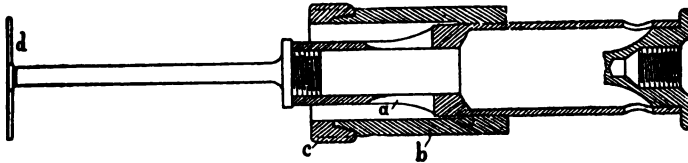

FIG. 25A.—SEEGRUEN'S BURNER.\*

results from the division, only a fragment thereof is brought into play upon the glow-pieces. There is, therefore, to be expected a loss much rather than a gain, in comparison with the much simpler Welsbach light, entirely aside from the evils caused by the action of the rods.

Another construction, whose purpose is not plain without further explanation, is that chosen by SEEGRUEN<sup>56</sup> (Fig. 25A). In this case the gas-and-air mixture enters by a small pipe from which it flows through the lateral openings *a* into an annular passage formed by the adjust-

\*The cut is given here in the position in which it is published in the original. Every indication, however, points to its being more properly placed in a vertical position.

able sleeve *b* with a soap-stone rim *c*. It is to impinge upon *a* but to become quiet again in the passage-way, that is, to rise quietly. *d* is a cross-piece carrier for the mantle.

STEUER'S production<sup>87</sup> is merely an experiment with the abandoned, shrivelling mantles. In order to incinerate these safely he erects a pipe vertically movable upon the burner-top for the support of the mantle, which is to be raised or lowered at will during incineration. This applies to the pipe with the mantle, or to the latter itself.

JACKSON and DANIELS<sup>88</sup>, in the design of their burner (Fig. 26), have a view to the utilization of a gas produced from odorous, liquid hydrocarbons. The apparatus possesses, in addition to the usual key *a*, a regulating-spindle *c* by means of which the area of the issuing jets at *b* can be altered, in the manner well known in vapor-burners, etc. The nozzle *b* projects through a larger opening *h* in a cap *i* which forms with the trough *d* an air-chamber; from this the gas issuing from the nozzle *b* sucks air with it through *h*. The air-chamber is further covered with a ring *e* perforated at *f*, while the amount of air introduced by the constant suction of the gas-current is regulated by the adjustable plate *g*. The gas-and-air-mixture next meets, in its rise, the two sieves *k* which are designed to bring about a thorough mixture of the gas and air. The space *s* is, in part, for the same purpose; it encloses the sieve *l*, consisting of curled hair, asbestos fibre, or similar light and durable material. Here the mixture is to become quiet and, since the space *s* may be well warmed, pre-heated also. It passes then to the Argand burner *n* and burns over the protective sieve *o*, which is fastened to the burner by the spring-clamps *p*, *q*. Air-passages *t* are led through the latter so that air may be supplied to the interior of the annular flame. The air passing through acts as a refrigerant upon the passage-walls and upon the mixture previously warmed in *s*. The constructor surrounds the mantle-carrier, placed at one side, with a poor heat-conductor *r* in order that the mantle may not be over-heated at its points of suspension, during service, and so be easily torn off—a fear which appears to have little foundation with the use of such ductile materials as AUER'S or with suitable suspension.

## II. Means for the Increase of Luminosity.

After the preceding discussion it is quite admissible to close the consideration of incandescent gas-light burners with a decision to give

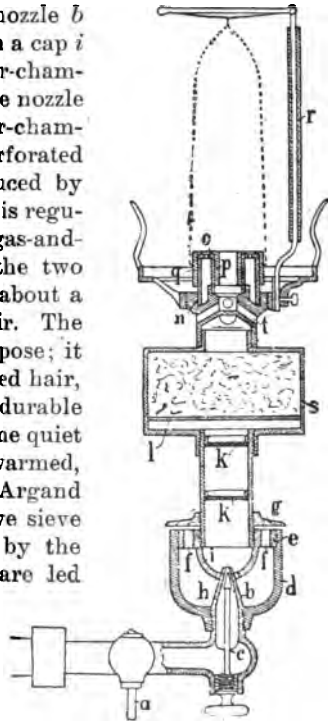

FIG. 26.—BURNER OF JACKSON AND DANIELS.



to the Welsbach device, partly on account of its logically correct arrangement and partly on account of its simplicity, the preference before all other constructions; which latter appear to have lost the right track, in part, in groping after something new.

If it be desired to increase the amount of light emitted by the incandescent material, the question arises as to an increase in the flame-temperature, referring to that of the actual envelop of the flame. In this question there must always be drawn a balance as to whether the device by means of which this result is sought be economical, in view of the somewhat increased consumption of the luminous material. In every case, however, the value of this consideration varies with the conditions of a given proposition; but neither with the older nor the newer productions can it result favorably, and practical tests have shown that the good and the simple have so far maintained successful competitive supremacy over what is perhaps better but more complicated.

The older devices which involve the production of an oxyhydrogen flame, or the addition of oxygen to the illuminating-gas flame, can therefore be regarded as excluded. Similarly, mere mention is made, in passing, of BERTON'S<sup>89</sup> work, in which illuminating-gas is mixed in peculiar proportion with nitrous-oxide ( $N_2O$ ), instead of with air. Likewise, the method given by PINTSCH<sup>90</sup>, in his time: that of supplying the illuminating-gas, through a pump or a blast, at a pressure of from 60 to 80 inches of water and of leading it to the burner under this pressure, can scarcely claim attention as of general value.

A certain amount of interest lies in the attempts to pre-heat the gas or the air, or both, or in other words to apply the principle of the regenerative gas-lamp to the service of incandescent gas-lighting, although no actual results in this direction can so far be pointed out. In reference to the Welsbach light it should also be noted that in it the transformation of the heat of the flame into light proceeds upon such a scale that the reclamation of the heat from the departing products of combustion would hardly justify the complicated construction hitherto necessary for that purpose.

In the description of the predecessors of the incandescent gas-light of to-day, occasion was taken to consider some constructions looking toward the above end. Some further inventions of the same sort might find a place here, solely in order to be perfectly complete. Such thoroughness would appear to be the better justified, as the improvement which took its beginning with the regenerative gas-lighting built up by Siemens has matured in endeavors, extending up to the most recent date, looking towards the combination of regeneration with the incandescent light.

LEWIS<sup>91</sup> brings in a somewhat separate arrangement (Fig. 27) for small lamps. The upper burner portion, carrying a platinum basket-work *a*, is divided from the lower portion by a poor conductor of heat *b* (soapstone). A draft-glass *e* is surrounded by a larger, short, glass cylinder *f* so that air is brought in between *e* and *f* underneath the

burner-plate *g*, being heated by *e*. The gas-tube *c* opens into a cone *d*, where the mixture with air takes place, holes *k* being provided, besides the latter, to bring in currents between *d* and *e*. The base *h* and the swivel-disc *i* have openings covering each other, which serve at once as inlets for air and as dampers, since they can be put out of operation by the rotation of the disc *i*. The purpose of the wire gauze or perforated sheet *l*, placed over *h*, is not quite evident.

In the same class may be placed the construction of RAWSON and HUGHES<sup>62</sup>, which is sketched in Fig. 28. This is, in essential, one of the familiar "intensive" lamps with central gas-inlet and with the gas-flame directed outwardly. In place of the usual burner is introduced, however, a modified Bunsen burner. The air is pre-heated by the departing products of combustion in the annular space *c*. The gas passes from the supply *a* into the tube *b* and sucks the already heated air into the mixing-pipe *d*.

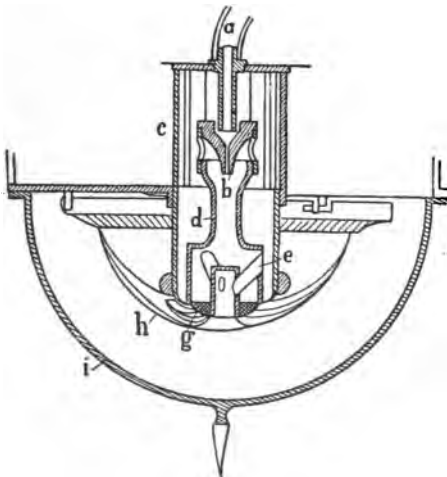

FIG. 28.

BURNER OF RAWSON AND HUGHES.

latter arise little flames directed against the basket *a*. The products of combustion flow around the chamber *d*, the walls of which heat,

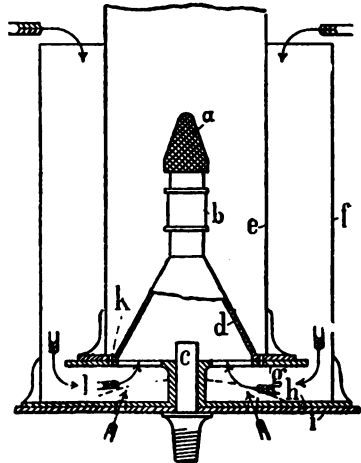

FIG. 27.

LEWIS'S BURNER.

The ring-shaped sieve *g*, arched downwardly, permits the spread of the flame in the manner indicated, while the cap of the incandescent body undertakes its further guidance. Radial channels *e* are intended to permit the supply of warm air to the interior of the flame. A globe *i* encloses the lamp from below.

CLAMOND<sup>63</sup>, who cannot get away from the obsolete magnesia basket (*a*, Fig. 28A) utilizes a horizontal gas-supply tube *b* and a distribution-chamber *c*, which forms, in the larger sizes as shown here, a ring-shaped channel. From the little tubes *g* inserted into the

the basket *a*. The products of combustion flow around the chamber *d*, the walls of which heat,

by radiation, the mixing-space *c*, as also the air-channels *e*, and flow out through the flue *f*. The air sucked in as a result of the operation of this device is thus warmed during its passage through *e* and *d*; a portion of it passes through the central cylinder *i* and is diverted against the little tubes by a disc *h*. In order to cool the inner globe *k* an outer globe *l* is added. The air necessary for combustion enters through the opening *n* in the latter, in which process it is probably supposed to be assisted by the disc *m*. If the volume of air which is sucked in through the chamber *d* by the flue *f* be not sufficient for this

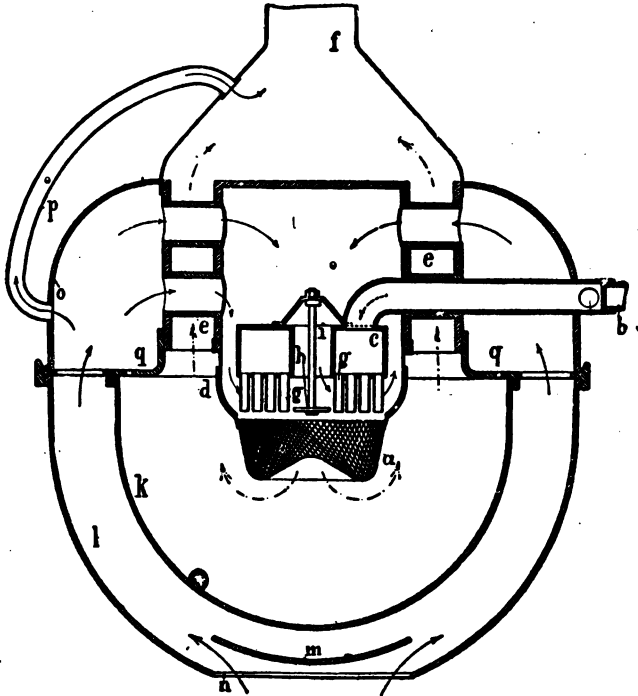

FIG. 28A.

CLAMOND'S BURNER.

purpose, channels *p* lead the air directly from the hood *o* into the flue. This is further provided with holes *q* through which the air can be brought immediately from the hood *o* into the globe *k*, in order, as the constructor states it, to cool the latter. Plainly, the similar air-admissions essential in regenerative lamps have swept by CLAMOND without their purpose having been very clear to him.

The intention of producing a regenerative incandescent gas-lamp is also to be perceived in the construction of KIESEWALTER<sup>64</sup>. Two forms of its development are illustrated in Figures 29 and 30. Referring to Fig. 29, the gas-tube *a* has exit-openings at its upper end. The issuing gas sucks the air in from the tube *b* and the mixture results

during the flow through the tube *c*. The mixture is intended to burn above the protective sieve *e*, by which means the cylindrical incan-

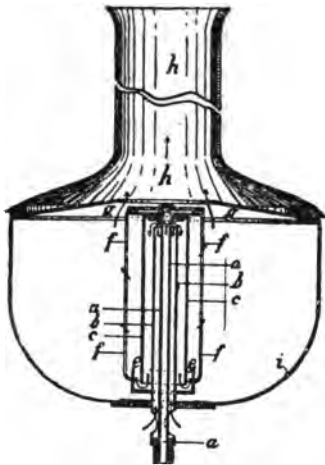

FIG. 29.

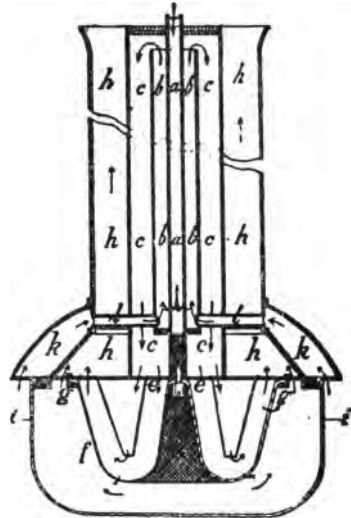

FIG. 30.

KIESEWALTER'S REGENERATIVE INCANDESCENT GAS-LIGHT.

descent material on the left, on the one hand, and on the other the cylinder *c*, are strongly heated. Whence comes the air necessary for

combustion, however, remains without explanation. The second arrangement, Fig. 30, which reminds one of CLAMOND, is similarly obscure. The apparatus is arranged as a hanging-lamp with a basket-shaped mantle *f*. The gas, passing down in the tube *a*, sucks air down through the pre-heating chamber *k* and the channels *l*, mixing with it in the tube *b*. The mixture is led on down through the cylinder *c* and is designed to burn below the protective sieve *e* so that, after the resulting heating of the mantle *f*, the products of combustion, as in the first arrangement, can pass off through *g* into the flue *h*, heating the portions *k*, *l*, and *c*. In both cases a globe *i* encloses the combustion-chamber.

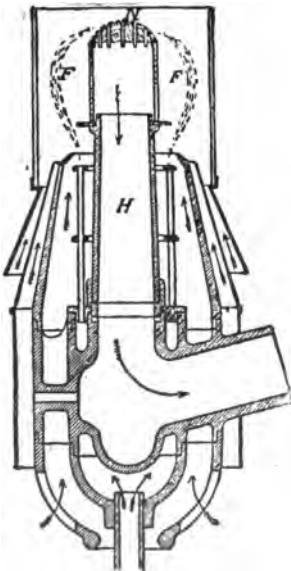

FIG. 30 A.

SIEMENS'S BURNER.

A lamp has already been mentioned, in passing, in which the luminous flame is combined with the incandescent light. The idea has recently been given body by the creator of the regenerative gas-light,

SIEMENS<sup>66</sup>, who provides his regenerative lamp with incandescent material. SIEMENS causes the luminous flame, burning in preheated air, to fully develop, introducing the luminous material in the place where combustion is complete and the temperature is the highest. The mantle is either surrounded or penetrated, according to the form and course of the flame, by the departing products of combustion. Fig. 30 A illustrates SIEMENS's apparatus arranged for the latter method, in which the form of the construction relating to the flame *F* may be taken for granted as known. The products of combustion, passing downwardly through the flue *H*, pass through the luminous basket-work (or the like) *N*. It should be noted that two differently colored sources of light result from this combination, to which the eye cannot be accustomed and which therefore demands special treatment by globes, etc. The question also arises, in reference to efficiency whether the transformation of heat into light is not detrimental to the regeneration.



FIG. 31.  
GALOPIN'S  
BURNER FOR  
HYDROCARBON  
VAPOR.

### III. Burners for Liquid Fuel.

It cannot be denied that the incandescent gas-light, in the significance of the term laid down here as a foundation, is also applicable to the field of illumination by means of liquid fuel. Here, indeed, the conditions in relation to the transformation of heat into light are, at the best, more unfavorable than in well constructed illuminating-gas burners. On the other hand, however, the petroleum or similar lamp does not presuppose a gas-works, and the efforts to free the advantages of the incandescent light over the ordinary luminous flame, from the necessity for the provision of a gas-supply are in every way worthy of notice. At the same time, the prospect for the solution of the problem is not very great; a fact which is partly due to the unsuitable form of the flame and partly to the process of vaporization, which stands diametrically opposite to the observed and tested experience with the gas-burner. The luminous flame, on account of its smoky peculiarities, has slight prospect of recognition [as a means for heating the mantle]; recourse is therefore had to the vaporization of the liquid hydrocarbon and its mixture with air in a manner similar to that of the Bunsen burner in order to produce a non-luminous flame, the heat of which is taken up by the burner itself and applied to the purposes of vaporization. The disadvantages resulting from this are evident, without further word, from the observations made in the description of the gas-burners, and there is now notice to be taken only of the evils which have their origin in the general nature of the fuel utilized.

GALOPIN<sup>66</sup> prepares beforehand a mixture of hydro-carbon vapor and air which he first leads to the holder *c*, Fig. 31, by means of a pipe

*b* which can be closed by a cock *a*. This may at the same time operate as a vaporizer, since it is heated by the products of combustion as they rise. From it the mixture passes, through a regulating-cock *d* and two protective sieves *e*, into a narrow passage *f*. To the latter is fastened a tube *g*, spreading towards the bottom, on the end of which the flame burns, heating the mantle *h*. If the light is no longer wanted the closing of the regulator-key *d* permits the mixture to flow slowly only through a narrow ring-shaped port in the same and to continue to burn at the exit *f* as an ignitor-flame. Complete extinction is accomplished by means of the cock *a*. It should be remarked, in passing, that GALOPIN uses as a mantle a weave of platinum wire of two different thicknesses. The flame traverses the weave and is thus hindered by the latter in its natural development. The entire apparatus appears to be more like a torch than a regular system of lumination.

The construction of CAMPBELL<sup>47</sup>, who uses an upright burner (Fig. 32), approaches more nearly to the Bunsen burner. The pipe *a* leads the liquid fuel (gasoline), upon the opening of the cock *c*, into a tubular support *q* which operates partly as a regulator and partly as a preheater. The vaporization itself takes place during the passage through the channels *f*, *e*, and *d* in the brass body *b*. The vapor issuing from a fine orifice from the channel *d* sucks in air through lateral openings which are protected by a casing *m* and mixes with it in the tube *l*. The spreading burner-top *o* carries an arched protective sieve; *p* is the mantle, the arrangement of which is plain from the cut. The regulation of the flame is brought about by means of the valve-spindle *g*. A further valve-spindle *h* is provided for the purpose of diverting a branch-current *k* from the passage *e* in such a manner that a very small flame burns outside of the body *b* and inside of the protective casing *i* so as to heat the body *b* suitably for vaporization.

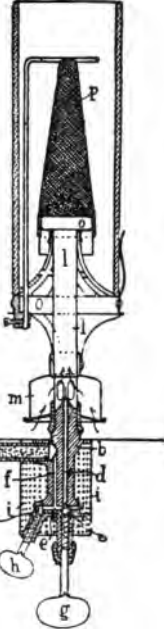

FIG. 32.

CAMPBELL'S  
BUNSEN BURNER.

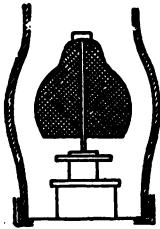

FIG. 35.

DEISSLER'S  
MANTLE  
SUSPENSION.

The construction is again recognized in simpler form in the alteration devised by FREESE<sup>50</sup> (Fig. 33). In this a cup *b* arranged beneath the heating-chamber is partly filled with benzine, the combustion of which heats the elbow *d*. The opening of the cock *e* then allows benzine to flow

into the hot tube *a*; it is here first heated, then, upon passage through the chamber *c* filled with wire-gauze, vaporized, and finally issues from the opening *f*. The air is sucked in through the openings *g* in the mixing-tube *h*. Upon the latter is placed the foot *i* of the mantle-carrier, the top of the burner itself being closed with a sieve. The downward extension of the head forms a protective envelop *k* for the air-inlets *g*. After the burner is set in opera-

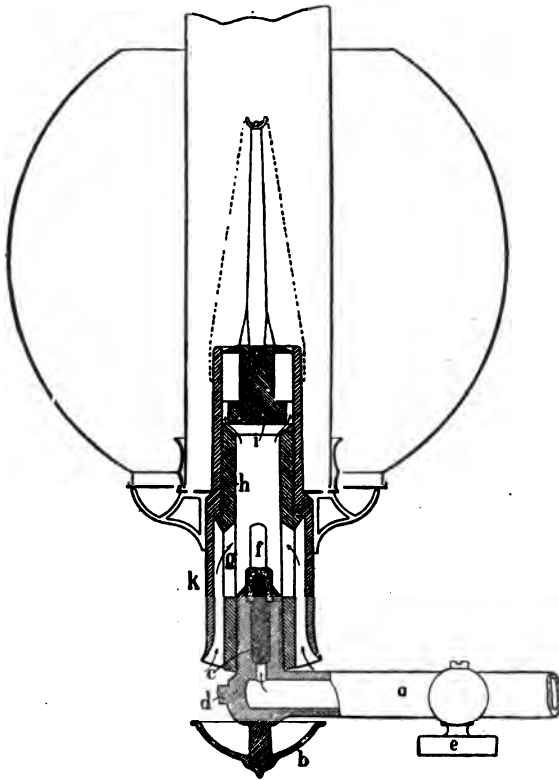

FIG. 33.  
BURNER OF FREESE.

tion further heating of the vaporization-chamber *d* and *c* takes place as the result of heat-conduction.

LINTZMEYER<sup>99</sup> gives more attention to the form of the flame. He uses a wick *a* (Fig.34) stepped at the top, which is in a sheath *b* and is adjustable by means of it. The central-draft lamp, designed for use with spirit as fuel, possesses a middle tube *c* which does not control the wick and which takes up air through *f* and leads it to the flame. The cone *d* is designed to regulate, as it is screwed more or less into the lamp, the supply of air to the interior of the flame; this results in a flame which suits itself automatically to the form of the stocking *e* and

which is formed, by reason of the steps in the end of the wick, of two concentric rings. The purpose of this arrangement is by no means entirely clear. The gases rising from the wick are to receive air through the holes *g*. The wick draws the combustible from the chamber *h* which in turn receives benzine from the holder *i* through a little pipe *k*. The chamber *h* extends well below the bottom of *i* so

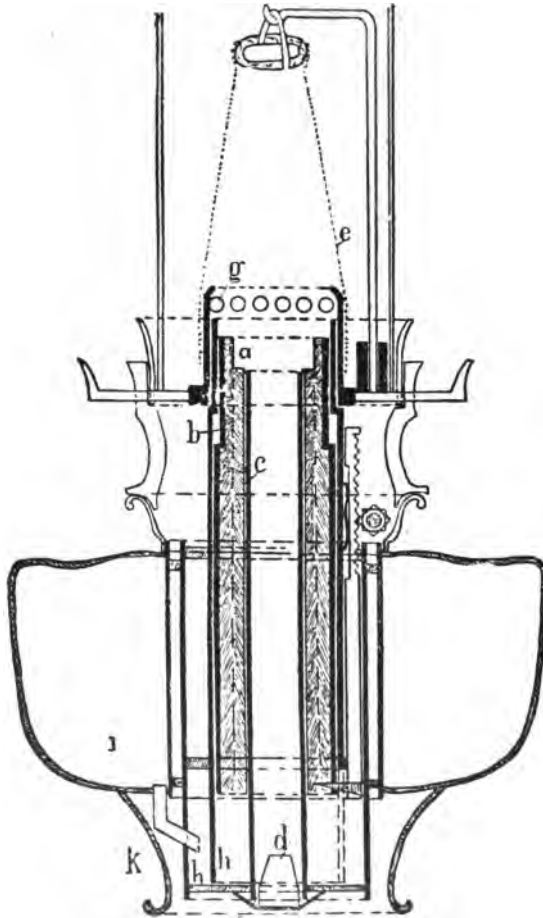

FIG. 34.  
LINTZMEYER'S BURNER.

that the wick can be screwed entirely down and the flame quietly extinguished.

DESSLER turned his attention to the support of the mantle. He therefore arranges, similarly to the chimney of a round burner, a moulded wire form which is supported on the burner head<sup>o</sup> and carries the mantle at its vertex. As an approach to the ordinary ar-



rangement of a gas-burner, he places a carrier consisting of a crayon on the flame-spreader<sup>71</sup> (Fig. 35) or he may also<sup>72</sup> carry up a holder bent about from below, the upper end of which rests upon the edge of the chimney; with this arises the special danger that in case of the cracking of the chimney the mantle also suffers.

## CHAPTER IV.

### REGULATION.

It is easy to see, from the standpoint of the preceding remarks, that for each mantle only one flame possesses the proper size and form for producing the highest luminosity of the incandescent body. There are, however, means for shaping the Bunsen flame within certain limits,—and it is with this that we are especially concerned. If, however, such precautions are to have practical value it is necessary that the mantle itself should remain constantly the same. Such a condition

has hitherto only been found, to a desirable degree, in the Welsbach mantle. This burner is, therefore, a necessary assumption in the arrangement of any regulating device. The Welsbach preparation is at times in a condition of white heat, at which time it is plastic; and indeed it must very often for hundreds of hours of service be spread by the mechanical operation of the flame whose gases spread against its walls from within so that the latter intersect its hot zone or envelope of the flame. This process causes a diminution of the luminous power of the mantle. The loss can be made good and the mantle brought to its original luminosity only by an increase in size of the flame and the second extension of the flame-envelope in such a manner that the mantle again coincides with it.

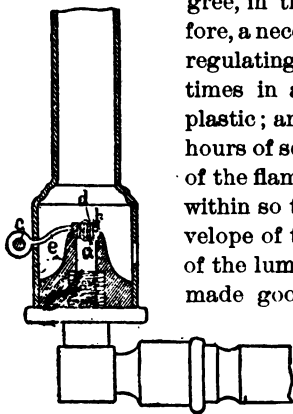

FIG. 36.  
BURNER OF GOULD & CO.

Gas-pressure regulators, having as their purpose a maintenance of the gas-pressure beneath the exit tubes at a constant point without regard to any alteration of the pressure in the supply-main during operation, can therefore be applied, without question, with the same warrant and the same results as with the ordinary burner. With this we are not concerned here; notice of the

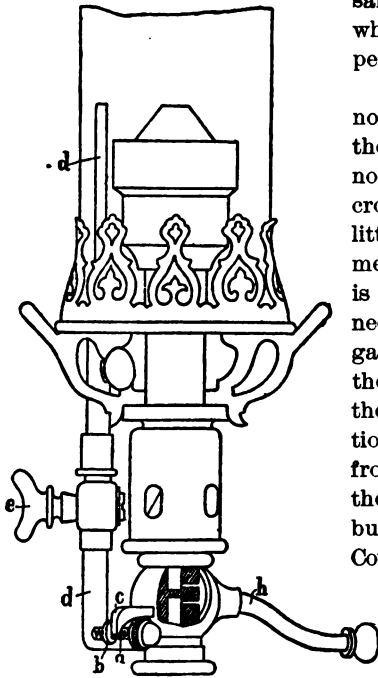

FIG. 37.—BURNER OF FISCHER & CO.

burner is rigidly fixed an adjustment-screw *c* by turning which the arm fastened to *b*, and in consequence *b* itself, are adjusted so that the holes in *a* can be covered over by the corresponding ones in *b*.

FISCHER & COMPANY<sup>74</sup> direct their attention to regulating the gas-admission. The principle upon which their construction is based is an attempt to attain the best emission of light by the adjustment of the gas-cock *h* (Fig. 37) the plug of which is a fixed one, and then to prevent any further opening of the cock, in the use of the burner, than corresponds to this effect. The revolvable casing of the cock is therefore provided with a lug *c*, and a screw *a* is placed on the fixed portion of the cock. On this can be screwed a nut *b* which limits the travel of *c*. It should be noticed, in reference to the igniting-device, that the igniter-tube *d* in this case branches off below the burner cock, is provided with a special shut-off cock *e*, and opens into the top of the burner.

The proportion of mixture of gas and air, as is well known, has great influence on the nature of the flame. In this connection there are two limits to be observed, of which one is a too slight pro-

same lies outside of our present task, which is to publish the inventions peculiar to the incandescent gas-light.

As designed by Welsbach and as now actually built, the gas enters from the fixtures into the mixing-chamber, not through one hole of considerable cross-section but through several (4) little openings punched in thin sheet-metal. The diameter of these ports is proportioned for the amount of gas needed for the flame under a given gas-pressure. In the construction of the burner great care must be put upon the correct execution of this precaution. In order to decrease the trouble from alteration of cross-section and at the same time to permit adjustment in burners already installed, GOULD & COMPANY<sup>75</sup> make use of the arrange-

ment sketched in Fig. 36. A little plate *b* is connected with a thick plate *a* by means of a rivet. Both have holes *d* corresponding to one another. Outside on the



FIG. 38.  
LEWIS'S  
BURNER.

portion of air, which will result in incomplete combustion, and the other is in the direction of too rich a mixture; the latter approaches an explosive mixture and will result in a noisy flame. Efforts at regulation, at will, of the admission of air into the mixing-chamber are therefore not new.

Thus LEWIS<sup>75</sup>, in spite of his simple platinum cap *k* (Fig. 38), has not been able to lay claim to a specially troublesome treatment of the problem in his arrangement of several concentric conical sheaths *c* about the gas-admission-tube *a* and the production of a corresponding series of annular air-inlets. These cones *c*, since they are movable by means of nuts upon the thread *d* of the burner-column, are adjustable in reference to one another as well as in reference to the cone *a*, so that, for instance, single air-inlets can be entirely shut off.

MEYN<sup>76</sup> proceeds much more simply in that he moves two cylindrical pieces *a*, *b* (Fig. 39) axially over one another; either *a* or *b* is provided with air inlets properly formed so that they can be covered by moving *a* in *b* or *b* in *a*. The axial adjustment can be made accurately by twisting them, in a manner familiar to all.

Similarly MÖLLER<sup>77</sup> provides an annular slide *C* (Fig. 40). In passing, it should be remarked here that the wire net *D* is closed in the center with a button *E* in order to insure the quiet combustion of a flame of larger superficial envelope-surface.

The isolated propositions for regulating the flow of the air necessary for combustion are of slight importance, because their purpose is not quite plain. The construction given by BOULT<sup>78</sup> might find room here (Fig. 41). A cup *a*, made of porcelain or metal and designed as a mixing-chamber, possesses lateral openings and carries an inner mixing-tube *b*. In burners of large gas-consumption ( $3\frac{1}{2}$  to 7 cubic feet), where several such tubes are placed

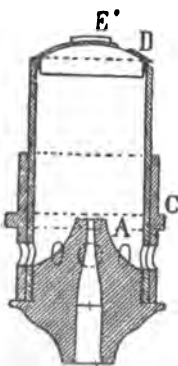

FIG. 40.  
MÖLLER'S BURNER.

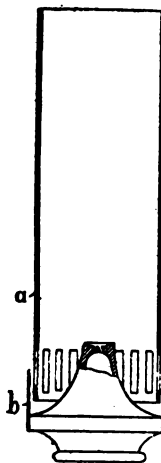

FIG. 39.  
MEYN'S BURNER.

one over another, the air enters in the manner indicated by the arrows. The burner *d* is surrounded by a cone *e* so that there is formed between *d* and *e* an annular channel as a guide for the air needed for combustion. The actual admission of the air takes place through holes which are adjustable by means of an annular slide *c*.

The following devices, in which both the gas and air-volumes are regulated, have been quite easily selected from the efforts at proportioning the gas-supply to the flame needed, and at the same time of correspondingly proportioning the air-supply to the gas-consumption already provided. Such precautions have already been taken at an earlier date, as, for instance, where compressed air is admitted to the gas-supply. Amongst other devices

the cock-plugs of the gas- and air-supplies have been fitted with a pair of gears meshing with one another (CLARK<sup>79</sup>) so that the adjustment of

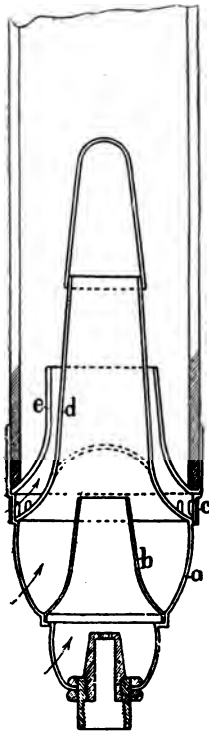

FIG. 41.  
BOULT'S BURNER.

it with a square spline which reaches through a cross-head *b* to the roof of the mixing-tube. The burner head has an internal thread and, with the gallery *l*, is revolvable about the mixing-tube. By turning *l* the cross-head *b*, and with it the carrier *a*, can be adjusted up or down. The gas-tube *c* is surrounded by a capsule *e*, both having holes *d*. The capsule *e* can be turned from without by means of the handle *f* so that the holes are more or less closed. The handle *f* carries with it an external sheath *g* which alters the air-inlets *h*.

BELL<sup>83</sup> entrusts the regulation of the gas-admission to an automatic regulator of well-known construction. This is inserted between the supply-cock and the admission-tube (Fig. 44). The gas passes through the port 5, the lateral openings 7, and the hole 10, into the chamber 9, and from

one cock compelled a corresponding movement of the other. RAWSON and HUGHES<sup>80</sup> (Fig. 42) fasten on the cock *G* an arm *c* which is connected by means of the link *b* with a sheath *s* which controls the air-inlet. In turning the cock *c* the sheath *s* is correspondingly moved and the air-admission regulated. On the arm *c* is fastened a second link *a* which adjusts the burner-head *H* axially upon the burner-tube. If the gas-consumption be decreased by a partial closing of the cock *G*, and a smaller flame thus produced, the head *H* is correspondingly raised and the flame itself, in consequence, brought into proper relation with the fixed mantle *L*; that is, so that it acts upon only a portion of the latter. There also takes place, to a certain degree, an exclusion of the mantle, from action. This, however, only possesses practical value in case the envelop of the diminished flame, in consequence of the rise of the burner-head, be again brought into coincidence with the mantle where it converges towards the neck.

KÖNIG<sup>81</sup> proceeds in just the opposite direction in making the mantle-carrier *a* (Fig. 43) adjustable. He designs it for this purpose by fitting

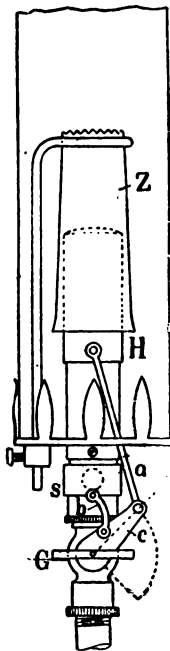

FIG. 42.  
BURNER OF  
RAWSON AND  
HUGHES.

there to the exit-flue 17. It thus traverses both sides of the piston 14, working in the cylinder 8, so that this, upon alteration in the gas-pressure,

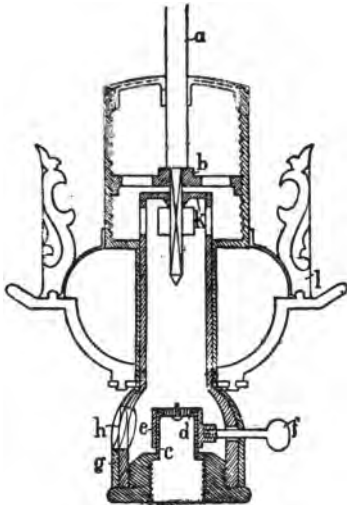

FIG. 43.—KING'S MANIFOLD CARRIER.

plays up and down, and this by means of an annular slide 13, influences the lateral openings 7. This construction, however, does not easily permit adjustment from without while in operation; it might be replaced by any other gas-pressure regulator. The object in view here is plainly the maintenance of the flame in a uniform condition, but it does not admit of a proportioning of the strength of the resulting current of gas, at a given gas-pressure, in correspondence with the demand of the moment. The constructor designs, apparently in order to permit adjustment in operation, an adjustment-screw 11 which can be set up against the hole 10. The air-admission 19 he protects by means of a cap 21, in which is placed an adjustment-ring 22 which is movable in the direction of its axis and which throttles more or less the air-admission between itself and the cover 16 of the gas-pressure regulator.

Referring to the cut, the ignition-device should be discussed here. The cock-plug 38 has a central port 37 which admits gas to the ignition tube 33. The ignition-burner 32 opens in the midst of the Bunsen flame above the protective sieve. The regulation of the ignition-flame is attained by means of the screw 42 in an obvious manner. In place of the central port the plug can also be fitted with annular channel 37 so that the axial plane of the ignition-connection lies at right angles with the axis of the gas-cock.

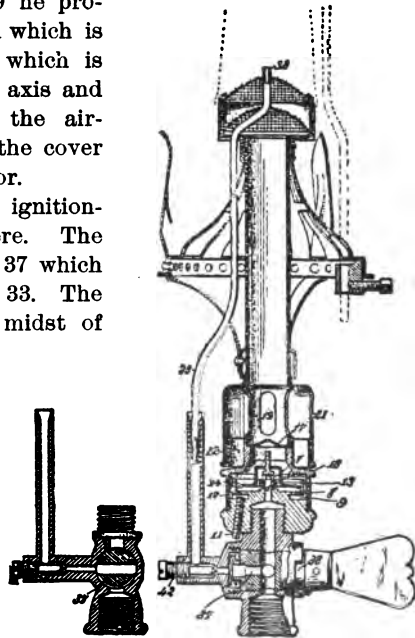

FIG. 44.—BELL'S BURNER.

If the air holes of a Bunsen burner are closed there results a

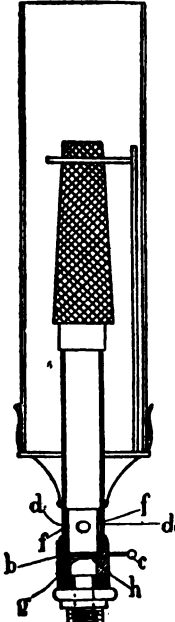

FIG. 45.  
BURNER OF  
WEIL AND  
ROSENTHAL.

transformation into a burner with a luminous flame. Although this latter can operate only deficiently it is of use with the incandescent gas-light for serving temporarily during the time at which a replacement of the mantle is needed. The construction of WEIL and ROSENTHAL<sup>83</sup> (Fig. 45) is given as one designed especially for this purpose. The base *h* of the mixing-chamber possesses holes *g* of two sizes so that small and large openings for the admission of air can be interchanged in the following manner. A plate *b*, lying over *h* and revolvable by means of the rod *c*, possesses only large holes, which, during operation of the burner with non-luminous flame, coincide with the small holes *g* of the base *h*. In case a luminous flame is needed, the openings of *b* are turned about over the larger openings *g* of the base *h* so that an increased flow of gas into the burner-tube takes place, while at the same time an internal sheath *f* connected with *b* closes the air-holes *d*. There will obviously be thus developed a brighter and more powerful flame at the burner-head than when only the quantity of gas needed for the operation of the Bunsen flame was allowed to enter.

## CHAPTER V.

### IGNITION.

We can to-day rely upon only that incandescent light in which the Welsbach preparation is used as a foundation. The fact is unquestioned that an absolutely innumerable array of heads has worked on the development of this idea, in itself a good one. In the preceding chapters only the most noteworthy productions amongst them have been taken into consideration because in many of the later methods, projected after Welsbach's discovery, there can be perceived a mimicry of past methods. Nevertheless, Auer is understood to have first produced an incandescent gas-light of real worth; the result of his creation is well reflected in the fact that numerous individuals, arising from the most varied spheres of life, have attempted actual or proposed developments of every kind of the finally discovered incandescent light and are yet attempting them, almost as if inspired by the sunlight which floods the prosperous work.

The ignition of the incandescent gas-light was consequently only first studied after this light had reached the point of durability. The process which must be accomplished in ignition is naturally more difficult to define than is the case with the ordinary luminous flame. There is this to be considered in connection with the delicate elements of the problem, the incandescent mantle and the Bunsen burner: the

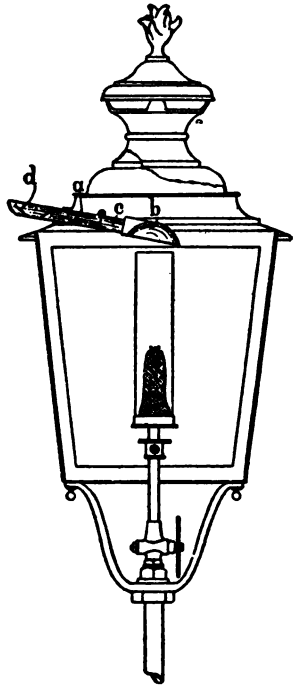

FIG 46.  
MUCHALL'S LIGHTER.

the



former when cold is sensitive to vibration or to jar such as is caused by the ignition of an explosive mixture, while the latter tends to strike back the flame to the gas-inlet tubes of the mixing-chamber. This latter phenomenon occurs very rarely with the Welsbach burner provided with a protective sieve; when, in spite of that, it does occur, the prompt closure of the cock, followed by a prompt opening of the cock and its ignition again, suffices as a corrective measure. If the striking back of the flame is not immediately observed the burner makes the fact known by a sharp sound so noticeable that the trouble can be remedied in time, in the manner indicated.

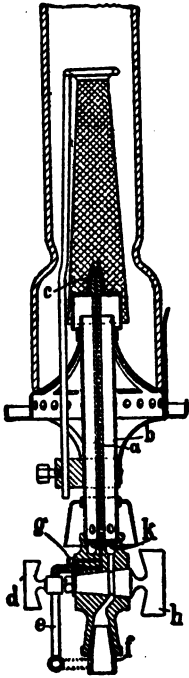

FIG. 47.

MACTEAR'S  
IGNITER.

The process which takes place after the opening of the burner-cock is plainly that the gas-and-air-mixture passing through the protective sieve fills the mantle and is guided by the latter to its upper opening. There are then two possibilities for ignition opened up: either one from below, that is at the level of the burner mouth; or one from above, that is, through the upper orifice of the mantle. The latter process has proven to be suitable and is accomplished by holding an open flame above the upper end of the chimney (which is always provided) after opening the gas-supply cock. The first shock of the exploding gas-and-air mixture is thus resisted by the upper and strengthened portion of the mantle; this certainly takes place, for the combustion of the accumulated mixture drives the unconsumed portion before it so vigorously that jets of flame are driven down about the burner-head and out beneath the chimney-gallery. A shield arranged above the air-inlets of the mixing-chamber of the burner has been designed to prevent the striking of the downwardly projected flame-jets directly against the gas inlets. This species of ignition by hand is simple, and indeed that ordinarily used in ordinary illumination by gas. The introduction of the ignition-flame from below is inadmissible.

For lanterns (in which the introduction of the flame above the chimneys is hardly feasible, yet, on the other hand, cannot be delayed until the hood has filled up with combustible gas-mixture, in which case the ignition would be carried much further than throughout the chimney), an arrangement has been devised by MUCHALL<sup>84</sup> which is sketched in Fig. 46. A spoon-shaped gas-trap *b* guides the gas-mixture issuing from the chimney and leads it out through a tube *ca*. The portion *a* of the latter is fixed; the portion *c*, on the other hand, can be either folded up about a hinge or telescoped towards *a*, so that the chimney can be lifted off. In the tube *a*

is introduced a tongue *d* which keeps rain and wind from the interior of the tube and is intended to force out the explosive gas-mixture to the point of ignition. The ignition-flame is brought to the outer end of *a*, whence the ignition is carried to the chimney by *acb*. The tube *ac* is only slightly bent, so that the chimney draught is not diminished. The device has been tested, to all appearances, in the street-lighting of Wiesbaden, with the aid of a spirit ignition-lamp which encloses the tube *a* between two lateral flaps so that the issuing mixture cannot be driven aside by the wind.

Quite naturally, the proposition has also been made to operate the ignition by a simple handle such as is used for turning gas-cocks. There has, therefore, been utilized in the most varied manner the application of an ignition-flame from below with the use of a very small amount of gas. As the most suitable position for the ignition-flame must be determined in the first place, the fundamental principle of the Bunsen burner will doubtless be of assistance in the problem; if the ignition of the latter takes place before the gas-mixture has filled the mantle it happens quietly and without detriment to the latter. It has been urged that a suitable pre-heating of the chimney and of the mantle was important; the latter can only possess significance if the heat developed is sufficient to render the mantle incandescent.

Amongst the possible special constructions and combinations the device of MACTEAR<sup>55</sup>, (Figure 47,) may be mentioned. In it an ignition flame-pipe of small diameter is brought through the mixing-tube *b* of the heating-burner and has its apex protected from the influence of the Bunsen flame during service by a cap *c*. The cock *b* provides for the cutting off of the supply *e*, which can also be kept independent of the main supply *f*. The adjustment of the ignition-flame is accomplished by means of the screw *g*. The cock *h* controls the admission of gas to the holes *k* in the ordinary manner. MACTEAR in another case carries the port for the ignition-supply down to the main supply *f* in the cock-casing so that the cock *d* and tube *e* are eliminated and in their place is substituted a second by-pass port in the cock *h*.

PINTSCH<sup>56</sup> proceeds similarly, in providing a by-pass in the cock-plug so that the ignition-burner *d* is fed when the passage to the tube *c* is shut off. The size of ignition-flame is adjustable by the set-screw *f*. BELL<sup>57</sup> whose construction has already been described, claims only unimportant variations. It is always in evidence in this that the burner is designed for the ignition-flame in the first place; the addition of the latter as a mere supplement is not met with. This latter appears possible, however, with the device of SCHLESINGER<sup>58</sup> in which the little ignition-tube (Fig. 48) is carried up between the burner-head

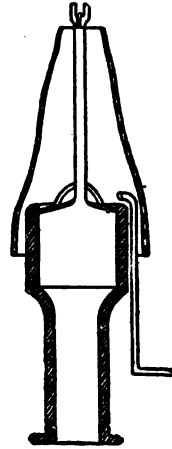

FIG. 48.  
SCHLESINGER'S  
IGNITER.

and the mantle and bent sharply inwardly over the former so that the ignition-flame is directed almost at right angles to the burner-axis. This would make necessary, for the accomplishment of the purpose in view, a special gas-supply; in order to meet this need SCHLESINGER<sup>20</sup>, places it in the main supply-pipe and branches off from the latter only just before reaching the burner.

HIMMEL's<sup>20</sup> attempt at using a Bunsen flame for ignition is interesting, although of slight importance. HIMMEL carries the mixing tube of a Bunsen burner through the head of the main-burner above the protective sieve of the latter; he lays across the opening of the ignition-tube wires (of platinum) which become incandescent and are intended, in case of accidental extinction of the auxiliary flame, to bring about re-ignition. There is hardly a possibility of the utilization of this flame, always so sensitive, and non-luminous except by accident, for ignition.

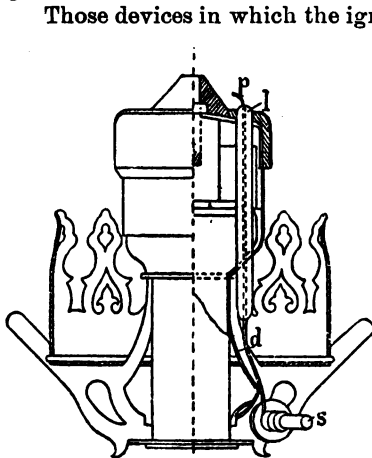

FIG. 49.  
REIDLINGER'S IGNITER.

Those devices in which the ignition-flame is located at the top of the burner-head, but outside of the mantle, are in every case to be ignored. In such a case it would act against the lower end of the mantle, so that indeed the ignition must take place through the same. It is plain that the mantle, delicate by nature, could not withstand its influence without injury. Only cursory notice will, therefore, be given to the construction of FISCHER & COMPANY<sup>21</sup>, in which the ignition-tube is carried up parallel with the burner and feeds, through lateral-openings, a horizontal flame directed against the mantle. The gas-inlets of both burners are in this case made in-

terdependent, the one upon the other, by connecting the two revolvable casings with gears so that the turning of one must result in a corresponding adjustment of the other. On the other hand, since ignition by hand regularly take place from above through the chimney, the designs in which the ignition-flame is directed over the upper end of the mantle may not be ignored. The MUNICH GAS LIGHT COMPANY<sup>22</sup> has directed its effort in this direction by boring through the side of the chimney and bringing in the ignition-flame directly over the mantle. The same thing can be noted in SCHULZ's<sup>23</sup> and SCHLESINGER's<sup>24</sup> methods.

It is most commonly intended to bring about the extinction of the ignition-flame when the main burner is in service; if both operations of the device are controlled by the same cock a simultaneous movement of the same may result in the extinction of the main flame before

the ignition-flame is ignited. This trouble is designed to be obviated by peculiar positions and forms of the cock ports; with the necessity ever present, however, of maintaining a little flame continuously burning even during the service of the burners, a thing accomplished in various ways<sup>96</sup>.

As to the multitude of electrical ignitions which have been devised for the luminous gas-flame, they can only be referred to with the remark that their application to the incandescent gas-light is immediately possible, if it be kept in mind that in this case is utilized a Bunsen flame, and that this, moreover, is surrounded by an incandescent mantle. There can thus be taken into consideration plainly only those devices in which the spark is provided by fixed or vertically adjustable contacts. It is correctly interjected that provision must be made of a special auxiliary device consisting of an electrical conductor and battery. On the other hand, it is argued that the electrical ignition is easy to install and, in particular, can be easily applied to lighting-fixtures already in place. The assertion made by TELLER<sup>96</sup> however, cannot be gainsaid: that this species of ignition easily fails by the collection on the contact points of products of oxidation which detract from the formation of the spark. The application of devices designed to operate, by the opening or closing of the gas-cock, an ignition from an electric current brought in from outside, is broader in its possibilities. There is space here for mention of only a couple of these inventions especially devoted to the incandescent gas light. Thus, L. A. REIDLINGER<sup>97</sup> (Fig. 49) brings in a supply-wire *d* insulated with a sheath *l* (of glass, soapstone, or the like) for the burner-head and terminates it opposite the gas-mixing cone, so that the igniting spark works between the cone and the end of the wire, grounding through the former and the burner itself. He also makes use of two wires *d*, whose ends *p* stand facing each other, and which are provided with contact-points *s* insulated from the

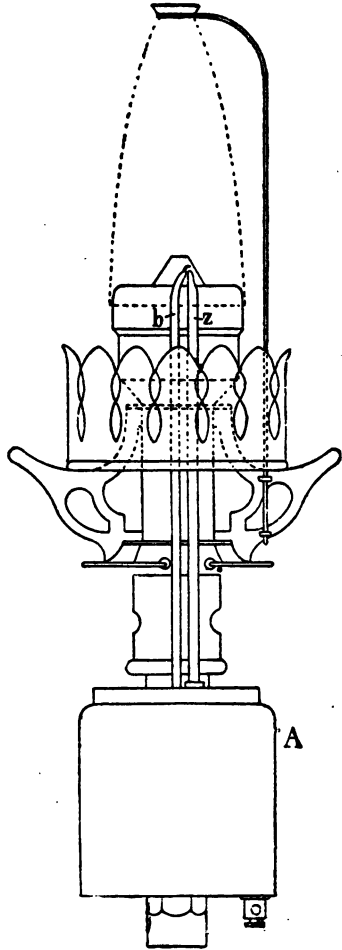

FIG. 50.

IGNITER OF STERN AND DAUS.

burner so that the burner itself is not in circuit. A special contact-rod, by means of which the gas-cock is opened, supplies the current.

The devices specified by LEO STERN and DAUS<sup>99</sup> differ from this in that the contact pieces *bz* (Fig. 50), which close the circuit when in a position of rest, are carried up between the burner-head and the mantle. The current is supplied from an electro-magnetic device *A*, the circuit being completed by the opening of the cock, by which the contact *b* is separated from *z* and the spark thereby formed between *b* and *z*.

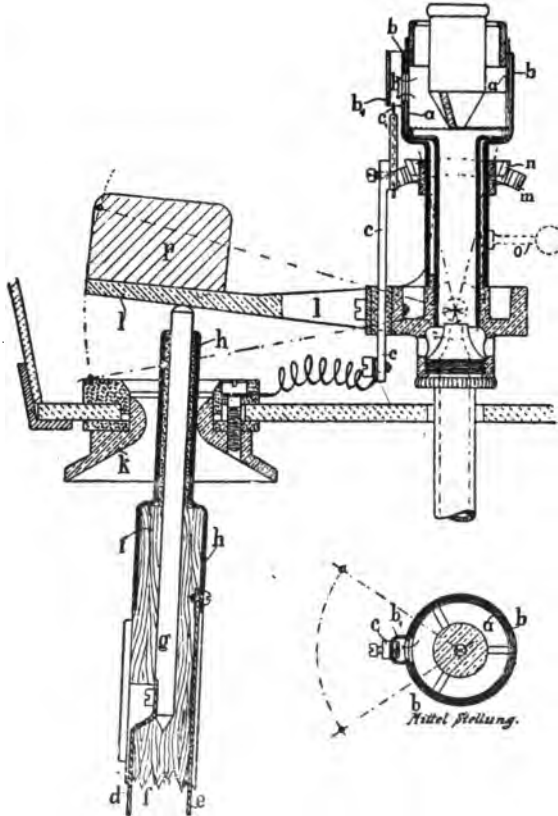

FIG. 51.

IGNITER OF STEGMEIER AND GEYER.

In another case, the flame-separating cone is provided by DAUS<sup>99</sup> with a special contact-piece on which rests a second contact introduced centrally through the cone. The circuit for the latter passes through the axis of the mixing tube and the air inlet to the same, so that the contact can only be moved vertically upon ignition.

An interesting device, designed especially for street-lanterns, has been proposed by STEGMEIER and GEYER<sup>100</sup> (Fig. 51). In it is provid-

ed a protective sieve arranged in the lower portion of the burner-head for the purpose of removing the locality of ignition from the active zone of the flame. A revoluble sheath *b* surrounds the burner *a*, allowing a portion of the gas-mixture to enter an ignition-chamber *b'*. Rotation results for about one-fifth of a circumference by raising the arm *l*, in gear with the toothed segment *mn*. By this movement the contact *c* is separated from the shell of the chamber *b'* so that sparks form, igniting the gas-mixture in *b'*. The flame thereupon carries across into the burner *a* through the lateral openings in the latter,

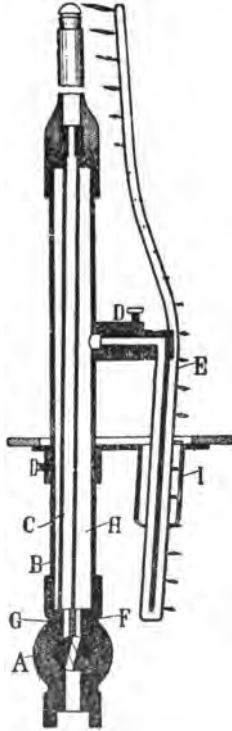

FIG. 51a.

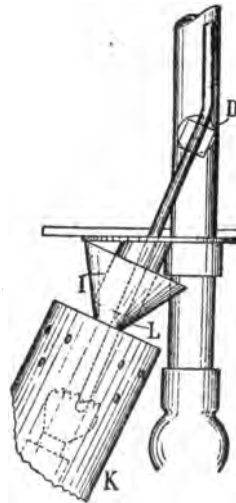

FIG. 51b.

## HECKERT'S IGNITING DEVICE.

which have just been opened but which are ordinarily closed by *b* during the burner's service. Upon release of the arm *l* the latter, and with it the movable portion of the device, is returned to its former position of rest by the weight *p*. The arm *l* now rests in circuit with the sheath *b* while the contact *c*, on the other hand, is in circuit with an insulated shell *k* introduced in the base of the lantern. In lighting, an ignition-cane *f* is brought into use, the wires of which *de* lead to a hand-battery and are also in circuit, respectively, with the rod *g* and the ferrule *h*. The cane is introduced into the opening of *k* so that the ferrule *h* rests against *k* while the rod *g* raises the arm *l*. The

current then passes through  $d g l m n b b'$  to  $c k h e$ . In domestic lighting the sheath  $b$  is rotated by means of a handle  $o$ , whereby a battery is brought into circuit respectively with  $c'$  on the one side and on the other side with the burner  $a$  by means of the gas-fixture.

It is worthy of remark that the well-known ignition of the ordinary gas-lamp by means of a "running flame" has been altered in variously modified form for the incandescent light. In these devices, in essential, a small tube branches off from the burner-fixture or some similar point leading on the one hand to a point outside of the burner from which the ignition is to originate and in the other direction to the burner. This tube is fitted with lateral holes. As soon as gas is admitted it issues from these holes; if such a gas-train be ignited, the ignition will run the length of the tube and thus reach the burner. When the ignition of the latter is accomplished the gas-supply to the auxiliary tube is shut off.

HECKERT <sup>101</sup> has brought out a design after this principle for a storm-proof lantern for use in public places (Figs. 51a and 51b). As is plainly shown, two ports  $F$   $G$  are provided in the cock-casing  $a$ , of which  $G$  feeds the burner through the internal tube  $C$  while  $F$  communicates with the external tube  $H$ . The latter has a support  $D$  into which opens the ignition-tube  $E$ , which is carried down through the base of the lantern and then bent up to the burner. In igniting, the gas-cock is so placed that the gas enters through  $F$  as well as through  $G$ . If flame be applied to the lower end of  $E$ , ignition results in the manner indicated above; whereupon the gas-supply for  $F$  is closed while that for  $G$  is fully opened. In order to protect the entire ignition-device from the wind, a support  $I$  is carried down around the tube  $E$ . The ignition-lamp  $K$  is correspondingly provided, for easier contact, with a funnel-shaped protective sheath  $L$  into which the support  $I$  projects, while the ignition-tube projects further down into the torch to the flame.

## CHAPTER. VI.

### PROTECTION OF THE MANTLE.

The incandescent gas-light brought out by AUER—and no other can be relied upon at this date—needs a protective chimney. Its purpose is not to aid in the development of the flame, for that is taken care of by the mantle; still less does it play the part of providing draft. Its duty is to enclose a layer of air within which the Bunsen flame may develop free from outside influences. It has already been shown that only that flame can produce a uniform, quiet light which has a firm envelope: moreover, the mantle must be protected from jar, impurities, etc., if it is not soon to either break or lose its luminous power. The chimney is therefore rarely tested as to its capacity for

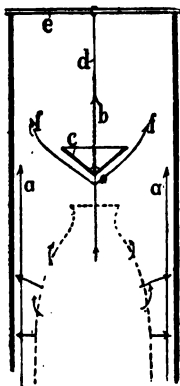

FIG. 52.  
DEVICE FOR  
PROTECTION OF  
THE MANTLE.

drawing air and thus influencing the flame. Here should be mentioned the parabolic expansion of the portion of the glass lying below the burner head, and also an arrangement of RAWSON'S<sup>102</sup>, who places the lower edge of the chimney on a level with the upper edge of the burner-head and at a short distance from the former inserts another bit of chimney like an extension downward, so that air may enter to the foot of the flame through the annular interstice thus formed. RAWSON appears to have hit upon an aimless device, in this case, however.

The necessary chimney brings with it an evil for which a remedy has been sought by the most diverse means and which has been indeed much reduced, though in no sense removed. This is the cracking of the chimney, which most commonly takes place with vigor, and therefore reveals exceptionally high tension in the glass. The ordinary sorts of glass undergo the experience with a certain regularity, and recourse must therefore be had to specially hardened material in



order to confine the phenomenon more closely to the region of accident; which can be, in part, accomplished.

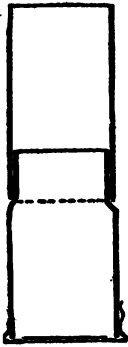

FIG. 53.  
PROTECTIVE  
CHIMNEY OF  
REICH & CO.

which is here only slightly heated. The cylinder of air surrounds, further up, the hot products of combustion issuing from the mantle in the direction of the arrows *b* and keeps the upper portion of the chimney cool. The necessary conditions for unequal tension of expansion of the latter are thus provided. If a cone *c* is suspended above the upper orifice of the mantle, by means of wires *d* and cross-head *e*, the products of combustion are diverted towards *ff*; they penetrate the cylinder of air and effect a heating of the upper portion of the chimney, a process which may result in a considerable decrease, if not a complete avoidance, of the inequality in tension.

It is to be noticed that the cracking of the chimney peculiar to the incandescent gas-lamp always takes place after a certain period of service, while the crash comes during ignition by hand in the manner usual with ordinary lamps and is to be regarded from the same point of view. A proposition<sup>103</sup> was made some time ago to place a canopy made of suitable metal on horizontal cross-arms on the upper edge of the

An explanation of the preceding has been sought in various directions. The following remarks are, to the author, relevant to the question. The height of the mantle is only a fraction of that of the chimney. Since, now, the heat developed by the envelope of the Bunsen flame in the incandescent light is transformed into light much more efficiently than is the case with the luminous flame, the incandescent matter doubtless produces enough heat-rays to heat proportionately the nearest layer of glass. The operation of the flame does not enter into the question, as it is independent of the mantle; moreover, portions of the flame can penetrate through the pores of the latter at the most only in such an amount and velocity as not to overcome the mantle's cohesion and, still more, to traverse it upwardly in only a very thin layer. The radiation takes place unhindered by the air passing between mantle and chimney in the direction of the arrows *a* (Fig. 52),

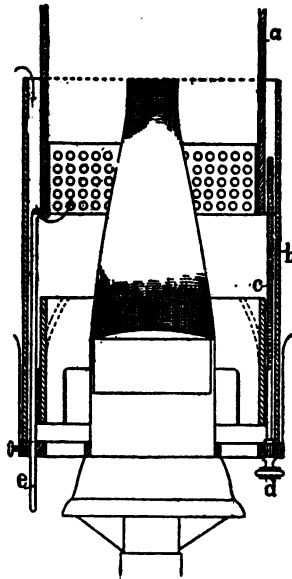

FIG. 54.  
PROTECTIVE CHIMNEY  
OF FRITZ.

chimney so that the central portion dips down into the latter. Its purpose is that outlined above, viz.: to carry heat over to the upper portion of the chimney, entirely, however, by the heat conductivity of the metallic portions of the canopy. The elimination of chimney-cracks is also the object of the provision of longitudinal and lateral slits in the chimney.<sup>104</sup>

Matters have been carried still further, in dividing the glass into parts adjustable as to one another, within certain limits, without spoiling the alignment. The amount of adjustment gives an idea of the amount of tension in a chimney made of one piece. Thus REICH AND Co.<sup>105</sup> provided two chimneys, with ends suitably fitted, upon one another (Fig. 53) either way about, but always so that the outside presents a smooth surface. FRITZ<sup>106</sup> has proceeded more ceremoniously and less practicably in that

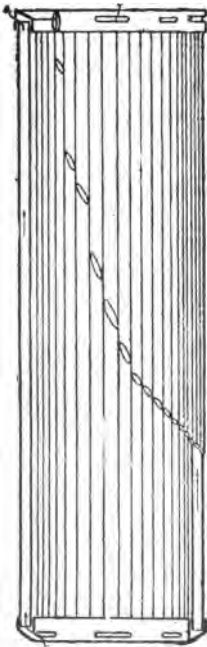

FIG. 55.  
LOLL'S PROTECTIVE  
CHIMNEY.

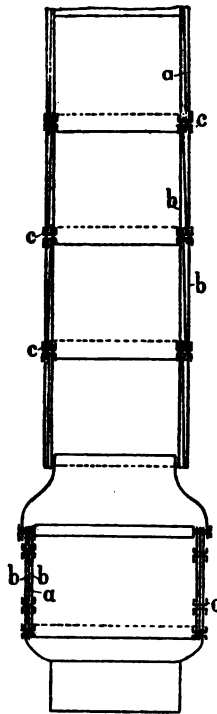

FIG. 56.  
MICA CHIMNEY OF  
SCHWINTZER & GRAEFF.

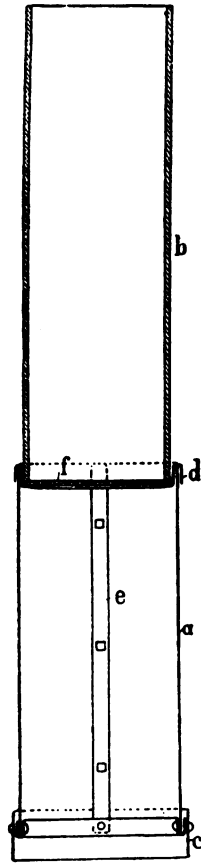

FIG. 57.  
MICA CHIMNEY  
OF ZIETZ.

he places a thin cylindrical or slightly conical ring *c* (Fig. 54) about the foot of the mantle and arranges a peculiar loosely fitting chimney *a* as an extension of it, while both are enclosed in a concentric protective

chimney *b*. The chimney *a* can be adjusted by thumb-screws *d* while guided by the rods *e*; or it is firmly fastened to the upper edge of *b*, in which case a grooved ring fixes its position.

Chimneys with composite walls made of glass rods which diffuse the light equally on all sides are certainly worth consideration. Thick walled glass tubes<sup>107</sup> have been utilized. Similarly, for instance, LOLL<sup>108</sup> (Fig. 55) inserted glass tubes in metallic rings provided with perforations for air-inlets; the lower ring fitting into the chimney gallery. Air is supposed to flow through the tubes, a self-evident process, in order to cool them. FRITZ<sup>109</sup> chose for his chimney suitably formed bottle-glass. There is further an old idea of forming a chimney of glass rods and covering it with a smooth glass cone.<sup>110</sup>

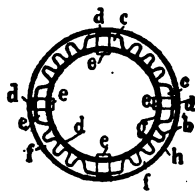
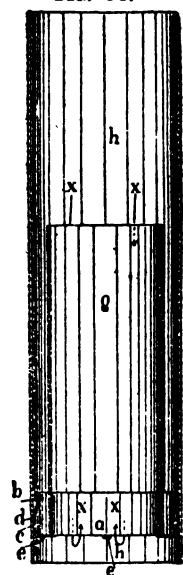

FIG. 58.

FIG. 59.  
CAMPE'S CHIMNEY.

When the inequality of heating-effects was once determined it was short work to seek a substitute for brittle glass, resulting in the use of the widely used, yielding mica. Not every one is so accustomed to the use of mica chimneys as to protect it from wrinkles and dents or to avoid peeling its layers; but with a precaution in cleaning, etc., not at all difficult to acquire, very pretty results may be had from its use. TELLER<sup>111</sup> notes, for instance, that on four lanterns of a Munich street-lighting installation twenty-five glass-cylinders were cracked in two months, in comparison with which the mica chimneys proved very durable. The slight loss of light noticed with the use of mica chimneys, and measured as from 3 to 5 Hefner candles, is of no practical importance compared with the total amount of light produced.

The nature of the material does not permit the manufacture of comparatively long, smooth tubes from a single piece, but there are available a few neat forms of joint consisting of simple overlapping and rivetting. Braces appear to be utilized to keep the chimney from spreading or bending, in time, at the height of the burner. SCHWINTZER and GRAEFF<sup>112</sup> enclose several short selenite chimneys *a* (Fig. 56) with their ends touching, force them into sheet-metal frames *b*, and fasten the combination with clamps. The spread of the lower portion reminds one of the ordinary draft-chimneys for petroleum-lamps.

ZIETZ<sup>113</sup> has chosen a composite design in which only the lower portion *a* (Fig. 57) is made of mica while the upper *b* is of glass. The former comprises two strengthening-rings *c d* which are further combined with two or more braces *e*. The ring *c* fits into the burner-gallery

lery; the ring *d*, however, is fitted to receive the glass addition *b* and further carries a metallic web *f* whose purpose is to catch the particles of dust falling in from above or the glass splinters, should *b* crack. There would be little to be said against these devices if only the dis-

turbing bracing *e*, necessary however with the mica chimney, might be avoided.

Those efforts must also be noticed here which attempt to reconcile these incongruities by inserting a mica cylinder between the top of the flame and the chimney to obstruct, to a certain extent, the radiating heat<sup>14</sup>. The object of making the protective devices from mica plate provided with holes, slits, etc.,<sup>15</sup> is not clear.

CAMPE<sup>16</sup> has discovered an apparently practicable setting for an internal chimney for use with the ordinary smooth chimney commonly used with the incandescent gas-light, which can be understood from Figs. 58 and 59, and which incidentally provides for pre-heating the air of combustion. The setting consists of a smooth, inner sheet-metal ring *a* and an outer corrugated sheet-metal ring *b*, the two fastened together by the angle-pieces *e*. The

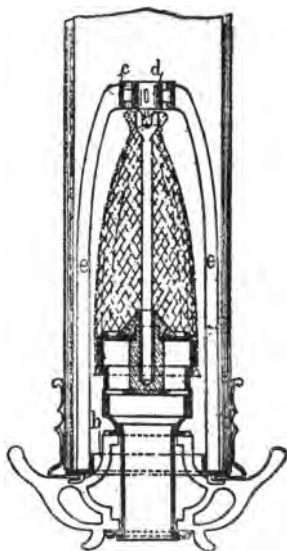

FIG. 60.  
BRUERE'S PROTECTIVE  
DEVICE.

corrugated ring *b* possesses extended corrugations *c* from which rise elastic clips *d*. By means of the latter the setting grasps the outer chimney at every point by friction, while the inner chimney rests between *a* and *b*. Air is to pass between the corrugated piece *b* and the chimney *h* in the direction of the arrows *x*, warming itself from *g*.

When a glass chimney collapses during ignition the several pieces tend to collect in a heap, to the destruction of the mantle. If the accident occurs after burning some time the little splinters of the central portion are strewn outwardly while the upper portion falls down on the mantle, destroying it. In each case it is not alone the loss of the chimney which is to be mourned but the more painful one of the mantle.

In order to at least protect the latter from such mishaps the most diverse attachments (wire-cloths, etc.) have been in some cases proposed and in some put into practice, the object of each being to keep the falling particles of glass away from the mantle. To these, for instance, belongs the protective device of BRUERE'S<sup>17</sup>, the parts of which are stamped from metal (ingot-steel sheets) and well nickeled. A ring-shaped foot-plate *b* (Fig. 60) and two upper concentric rings

*cd* are firmly fastened together by four struts *e*. The arrangement surrounds the mantle and is fastened to the burner by means of bayonet-locks. A further purpose of BRUERE'S construction is to protect the mantle, by means of the ring *d* placed not too high above its head, from being lifted from its support by a draft from below or a too heavy gas-pressure. The attachment has still a third purpose: to guide the chimney by the struts *e* in its removal for cleaning, etc.

The removal and replacement of the chimney is a fertile source of destruction of mantles, by collision with them; in such cases, very naturally, the tendency is to set up vibrations with the chimney which are permissible with the ordinary burner but out of place with the incandescent. In this connection a series of guides for the chimney have been devised, all of which are intended to prevent the accidental deviation of the chimney, in lifting or lowering it by hand, from its vertical path.

GUTMANN<sup>118</sup> (Figs. 61 and 62) makes use of a two-part cylinder *A* the half-envelops *a* of which can be swung on the hinge *b* or fastened together by the

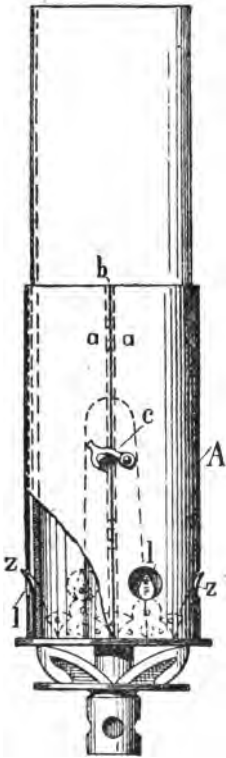

FIG. 61.

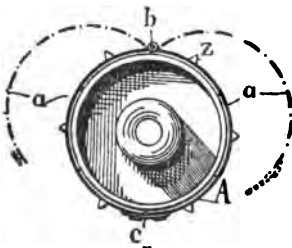
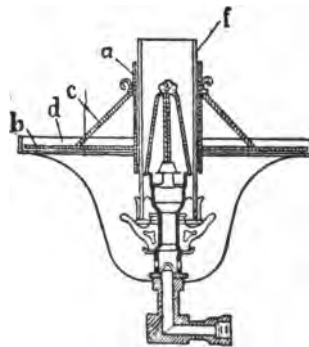

FIG. 62.

GUTMANN'S TWO-PART  
CHIMNEY.FIG. 63.  
OHLEN'S GUIDE.

latch *c*. If the chimney is to be removed, for instance, the protective device is opened, placed about the chimney-gallery (its outwardly bent scallops *z* projecting through the holes *l*), and locked by means of the latch *c*. The chimney can now be raised only vertically and replaced

similarly. Upon the replacement of the chimney the attachment *A* is removed.

For lamps having a globe-carrier, *OHLEN*<sup>119</sup> has constructed the following similarly removable guide (Fig. 63). The sheet-metal tube *a* surrounding the chimney *f* is provided with a disc *b*, fitting the carrier-ring *d*, and supported by struts *c*. The device is passed over the chimney *f* at will so that the disc *b* rests on the ring *d*. The chimney *f* can now be removed and replaced only vertically.

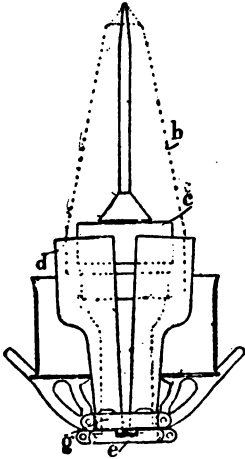

FIG. 64.  
BURNER HEAD WITH  
PROTECTIVE SHEATH.

consisting of two or more leaves, which is firmly fastened to the burner-tube and ordinarily shows a considerable distance from the burner-head *c*. If, now, the mantle *b* be so suspended that its lower edge hangs between *c* and *d* the parts of the sheath can be made to approach the burner by raising a ring *g* and the mantle correspondingly grasped.

*PINTSCH*<sup>121</sup> places about the burner-head *b* (Fig. 65) two concentric rings *a* fastened together at the bottom, between which should hang the foot of the mantle. In this manner rising draughts of air are to be prevented from spreading and tearing the mantle. A second object of the double ring *a* is to catch the mantle when, from any cause, it should fall from its support.

In spite of the use of chimneys it is yet possible, although rare, that the mantle may develop lateral vibrations, if not solidly surrounding the burner-head. In order to hold its lower edge and so avoid its destruction, a noisy light, etc., it has been proposed<sup>120</sup> to surround the burner-head *c* (Fig. 64) with a protective sheath *d*,

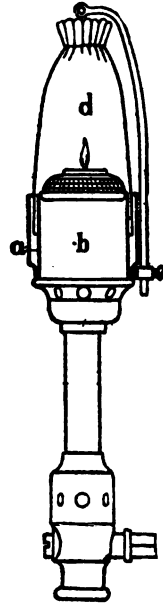

FIG. 65.  
PINTSCH'S  
BURNER-HEAD.

## CHAPTER VII.

### LAMPS, GLOBES, AND LANTERNS.

The Welsbach incandescent gas-light is an active source of luminosity having its origin in a small surface; its light is therefore dazzling. This condition will always have to be taken into consideration in the production of the above apparatus for illumination; it can be met by many scientific aids, so that the utilization of the incandescent light has not been limited by this peculiarity while it has been much assisted by the slight amount of heat developed. As the burners themselves are fitted with standard threads any gas-lamp, standing or hanging, can be altered into an incandescent light by a change of burners. The table-lamp makes some diffusible material desirable for the protection of the eyes; there results from its use a loss of brilliancy often amounting to fifty per cent. of the total amount of light, without regard to that caused by the shade. But the Argand burner also makes use of a deflector, which is in that case needed to catch the heat-rays; if the greater volume of light of the Auer burner is taken into consideration, it loses practically nothing from its globes in comparison with the former. Where a heavier demand for light is met by hanging-lamps they should be located at such a height, for the sake of distribution of light, that the light-source may and should remain uncovered below. Lecture halls and school-rooms, in which neither may the pupils be blinded in looking towards the desk, nor the lecturer be troubled in looking in the opposite direction, make a peculiar claim upon the arrangement of lights for which there is no general rule for solution. In such a case should be considered the indirect illumination which has recently come to the front; in it the downwardly radiating light is caught by reflectors entirely or partly opaque and directed against the ceiling, so that the source of light is wholly or partly covered and only diffused light is utilized. The process of diffusion naturally does not take place without loss, amounting to from thirty to sixty-six per cent. according to the perfection of dif-

fusion. With the arc light, which can only be used with a "milk-glass" globe, the loss is synonymous with that caused by the globe of the Welsbach; with the regenerative gas-light, however, hitherto regarded as the strongest gas-lamp, the loss incurred in diffusion is perceptible. The incandescent gas-light, however, which also needs a protection for the eye, is relieved of loss of efficiency by the substitution of a diffusive material for this shield.

As to the form, color, or material of the shade, it is useless to set any rules, as in every case the choice will be made according to taste and possibilities. Whether the mantle should be shielded by red or blue glass, clear or opal, or with glass etched with arabesques, should be determined according to the light's destination; with which should be remembered that the more the light is altered by artificial means the more will be lost in total effect.



FIG. 66  
THE  
FREDUREAU  
GLOBE.

The opal-glass globes especially used for electric arc lights have found application to the incandescent gas-light, a fact apparently attributable to a delusion; an especially tasteful choice is hardly to be perceived in this.

The clear glass globe has been made serviceable for diffusion of light in a peculiar manner by altering its outer service. Thus FREDUREAU<sup>122</sup> (Fig. 66) forms on the exterior horizontal rings, of triangular cross-section, which are designed to scatter outwardly and downwardly the light rays falling upon the interior of the globe.

The HOSERS<sup>123</sup> set in motion a great train of calculation in explanation of their construction. While earlier globes<sup>124</sup> show four-sided pyramids on their exterior or interior surfaces for scattering the light in all directions, the HOSERS leave their spherical globe smooth on the outside; the inner surface consists, however, of numerous pyramids with their apices directed radially towards the source of light. The latter are bordered by surfaces which are curved with a designated wave profile, designed with reference to a uniform distribution of the light.

PSARONDAKI and BLONDEL<sup>125</sup> differ from this in arranging furrows on the inside as well as the outside of the globe (Fig. 67) crossing one another at right angles; thus, for instance, if the exterior grooves *a* run horizontally, the interior ones *b* run vertically in contrast.

Only those constructions can be considered as lanterns for the incandescent gas-light which, even with an excessive external disturbance of the atmosphere, provide a quiet uniform emission of light, or, in other words, which are storm-proof. There are obviously a whole series of designs which aim for the above goal and of these many are worthy of mention; to illustrate them all here would involve too much space. Therefore, only those may be chosen which in general possess a tightly closed case and admit the air to the hood. Its path is so guided that with an increase of pressure without, the internal resis-



tance also increases, so that the entrance into the casing takes place with uniform velocity.

RIEDINGER'S shadowless incandescent light lantern<sup>126</sup> (Fig. 68) possesses a thick glass body *B* which is held by the frames *A* and

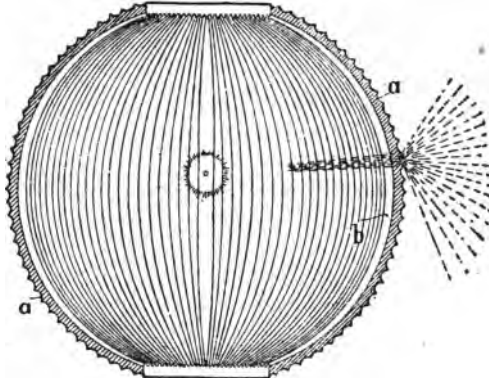

FIG. 67.  
THE GLOBE OF PSARONDAKI AND BLONDEL.

fastened together with two rods. *H* is a removable hood under which is firmly screwed the reflector *P* which is downwardly convex. The

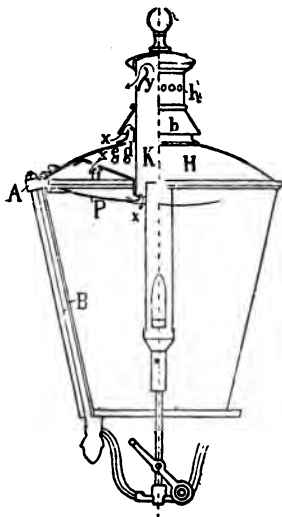

FIG. 68.  
RIEDINGER'S LANTERN FOR  
INCANDESCENT LIGHTS.

air enters under the hood *b* in the direction of the arrows *x*, traverses the holes *d e f*, and passes between the reflector and chimney into the lantern space, but could just as easily pass out again at the top. The products of combustion traverse the chimney *K* and pass out through the holes *g*.

The BAUMGARTEN lantern<sup>127</sup>, in which the air enters chiefly between a conical reflector and the hood into the upper space, but may also be led in part through the hollow corner-pieces into the lower chamber of the casing, should also be mentioned here.

A condition of the close lantern which is not found in lanterns provided with doors in the side, is the necessity of arranging some device for ignition from the outside, a subject which has already been taken up.

Similar constructions have been devised, which provide for the case in which the burner-cock is placed closely beneath the burner and thus remains inside the lantern while opening and closing must

be performed from the outside. A solution of the problem necessitated in consequence has been discovered, for instance, by Volk<sup>128</sup>, who provides the cock-key and a revolvable collar on the gas-pipe beneath the lantern with corresponding segments of wheels, which are connected in duplicate with one another by means of little chains, or the like, so that the rotation of the collar accomplishes a similar rotation of the cock-key. The segments provide for an exact movement of the chains in straight lines through the base of the lantern, whereby only small openings in the latter are necessary.

While indoors the radiation of light toward the sides and upwards is not lost in illumination, but is more or less returned, according to the reflective capacity of the walls and ceilings, in the case of the street-lantern the loss of the light-rays not directed downward can never be regained. A reflector, therefore, cannot be avoided in this case; its purpose is to catch rays not striking directly beneath the lantern and to return them thither. A flat cone, the lower base of which is placed about 5 mm. ( $\frac{1}{8}$  inch) above the source of light, has proven to be apparently the best form of reflector, and is usually made of porcelain. Plain ring-shaped panes with outer edges bent downward also work well; though in this case the chimney has to be inserted too deeply into the reflector if direct rays are not to be lost over the latter. Convex reflectors, however, must be classed as of little advantage, since they scatter upward the most favorable portion of the rays, a thing which is ordinarily prevented by the application of reflectors.

## CHAPTER VIII.

### THE OPERATION OF THE WELSBACH INCANDESCENT GAS-LIGHT.

Every scientific innovation first wins the title of a step in advance when it passes from the region of science into the territory of successful practical operation. At the start, several incandescent gas-light systems were advertised which, in part, were put into use quite widely and developed astonishing illumination effects. Their success however, was transient; and as quickly as it was attained the most of them vanished. They lacked that practical value which depends not only upon the brilliant production of light but upon many other conditions as well.

Even the Welsbach incandescent gas-light, a child of the latest time, advanced quickly to considerable respect; in which there is to be expected, however, from the experience already accumulated, by no means a fall but rather a rise, because the system is based upon a broadly wholesome foundation suited to the conditions of the time, as was not the case with its predecessors.

In order to clear away the impression of a leaning towards the incandescent gas-light, it may be remarked that, as nothing on earth is perfect, the system of illumination in question has its drawbacks as well. If it is to be determined, however, whether the light is to be regarded as an actual advance in the art of illumination or not, the question will not be easily settled on the premise that good illumination satisfies all the existing requirements, but more directly by a consideration of the question whether the Welsbach light surpasses the best sources of light to-day in regular use. It is in this latter sense that the affirmation has been accomplished by experimenters as well as in actual use.

In order to draw a comparison it is necessary to determine how much light, and of what sort, is produced by the Welsbach.

#### *The Candle-Power*

depends upon several factors which admit of various combinations and consequently varied results. The connection between the Bunsen

flame, the mantle, and resultant luminosity was pointed out some time ago<sup>129</sup>; if the first two be altered the last must change also. Without doubt, the condition of single mantles will not always be the same; nevertheless, the method of manufacture has now reached such a degree of perfection that variation occurs only as a matter of chance and is not to be estimated as greater than with any other factory-made lighting-device. It is always necessary, to test the above relations, to use several mantles of the same series under like conditions.

The flame of a burner depends upon the gas-consumption, with a given gas-pressure, but also upon the gas-pressure with a given consumption, and its heating-power still again upon the character of the gas (poor or rich). The best combination for a given sort of gas and for the commercial Welsbach mantle has been the subject of many thorough tests.

The Physical-Technical Federal Institute, at Charlottenburg, in 1892, tested several mantles submitted by the German Incandescent Gas Light Company under a pressure of 34 mm. (13.4 tenths) of water and a consumption of 112 litres (3.95 cu. ft.) of gas per hour, and found the horizontal candle power to average 66 Hefner lights, between limits of 60 as a minimum and 74 as a maximum.

FAHRNDRICH, of Vienna, reports 50 "normal candles"<sup>130</sup> with a gas-consumption of 90 litres (3.36 cu. ft.) and 80 NC with a consumption of 120 litres (4.24 cu. ft.), without noting the gas-pressure. At another time he reported

41.4 NC with 3.36 cu. ft. and 8.7 tenths pressure.  
72.4 NC " 4.41 " " " 18.9 to 19.7 tenths "

He further cites a report of a city test-committee<sup>131</sup> which had found 117 NC upon a consumption of 133 litres (4.70 cu. ft.) and 75 NC upon a consumption of 75 litres (2.65 cu. ft.).

OECHELHAEUSER's tests<sup>132</sup> are instructive in that they furnish a good insight into mutual relations. He utilized four burners of different gas-consumption—100, 110, 120 and 130 litres (3.53, 3.88, 4.23, and 4.58 cu. ft.)—burning under the same gas-pressure; of these each was tested under a gas-pressure of 20, 25, 30, and 40 millimetres (7.9, 9.8, 11.8, and 15¼ tenths) respectively, so that altogether sixteen combinations were made. He reported, as the best conditions for Dessau gas, which gives out 5,200 to 5,600 calories per cubic metre (584 to 628 B. U. T. per cu. ft.), 3.88 cu. ft. of gas consumed, 15.76 tenths of gas-pressure, and 74 HL. Next in the series were three Berlin and three Vienna burners which were operated on a consumption of 110 litres and under 20, 30, and 40 millimetres pressure. Under these conditions the Berlin burners gave 50.2 and the Vienna burners 64.5 normal candles. An increase in gas-pressure from 20 to 40 mm. resulted in an increase of candle-power of

26 per cent. for the Berlin burners, and  
30 " " " " " Vienna "

The experimenter also notes that it is advantageous to allow the lower

edge of the mantle to lie closely on the burner-head and to make the former cylindrical rather than to contract its diameter towards the top. This is corroborated by the fact that the envelop of a Bunsen flame burning under high gas-pressure itself approaches the cylinder in form. VON OECHELHAEUSER also questions the results of SALZENBERG'S (Bremen) experiments, viz.: 64 Hefner lights, or 55.2 normal candle, upon 90 litres (3.18 cu. ft.) under 36 mm. pressure.

RENK'S results are derived from comparative tests in which the efficiency of six incandescent gas-burners were compared with that of other gas-apparatus. The premises, 150 litres (5.29 cu. ft.) and 77 mm. (30.3 tenths), are somewhat unusual and not corresponding to the best results obtained with the Welsbach light. However, RENK derived values of 62.59, 57.71, 55.46, 55.44, 53.93 and 51.43 normal candles, or an average of 55.98.

LANG,<sup>133</sup> indeed, was willing to record himself as getting 75 Hefner-lights, or 64 normal candles upon a consumption of 80 litres (3.15 cu. ft.) under a pressure of 22 mm. (14.2 tenths).

The sum total of these tests is that, excepting the results of tests under especially unfavorable circumstances (unusually high gas-pressure), one normal candle may be had upon a minimum of 0.035 and a maximum of 0.084 cu. ft. of gas, or, under the ordinary gas-pressure of 7.9 to 19.7 tenths, an average of 0.0600 cu. ft.

A comparison with other good gas-burners can be made from the data collected by FAHNRICH and RENK.

According to the former:<sup>134</sup>

Kind of Burner.	Gas-Consumpt'n per hour. cu. ft.	Candle Power.	Cu. ft. per candle.
Hollow-head.....	5.30	13	0.406
Ordinary Argand.....	5.65	16	0.353
Siemens Intensive.....	VI	33	0.212
	III	60	0.204
	II	130	0.162
	I	300	0.162
	O	500	0.141
	OO	74.7	650
Old Welsbach.....	2.47	13	0.191
	3.53	20	0.176
New Welsbach.....	3.35	50	0.070
	4.24	80	0.053

It is to be noticed from this that the new Welsbach surpasses by far not only the Argand burner but even the SIEMENS "intensive," although the best of its kind. Notice should also be drawn to the inferiority of the old Welsbach light as compared with the new, a fact that alone testifies to the advance made since the original invention.

RENK<sup>135</sup> standardizes a gas-pressure of 77 mm. (30.3 tenths), under which eight Welsbachs consumed on an average 148½ litres

(5.24 cu. ft.); from which he was able to assume, in tests carried out with six sets of apparatus, a standard consumption of 150 litres (5.29 cu. ft.) without danger of accusation of partiality. Each of the two batswing and five Argand burners used in that connection used, on an average, 285 litres, or an excess of 135 litres. Under these conditions RENK found the candle-power to be:

		Normal Candles.
1)	Batswing A.....	14.53
	with maximum brilliancy.....	15.72
	with " consumption.....	12.44
2)	Argand burner A.....	25.13
	" " B.....	27.82
	" " C.....	30.41
	" " D.....	30.98
	" " E.....	33.77
3)	Incandescent gas-light A.....	62.59
	" " B.....	57.71
	" " C.....	55.46
	" " D.....	54.44
	" " E.....	53.93
	" " F.....	51.43

or, on an average, 14.27 for the batswing, 29.61 for the Argand, and 55.93 for the incandescent gas-light. These results teach that the incandescent gas-light, with an economy of 50 per cent. in gas, develops about four (more accurately, 3.9) times as much light as the batswing, or utilizes the gas eight times as well, and about twice (more accurately, 1.9 times) as much as the Argand, or utilizes the gas four times as well.

Finally, the fact is emphasized that in the Welsbach the illuminated gas is more than doubled in value over the best gas-light with luminous flame, the SIEMENS Intensive, and that the proportion is naturally increased as the batswing is approached. Since the production of light results from the process of combination the conclusion is immediately certain that in the incandescent gas-light the transformation of heat into light reaches a correspondingly high degree of perfection.

According to DEWAR<sup>136</sup> the energy is transformed as follows:

In candles	}	98	%	into	heat	and	2	%	into	light
oil gas										
" Geissler tubes*		97		"	"	"	3		"	"
" electric incandescent lights		95		"	"	"	5		"	"
" arc lights		90		"	"	"	10		"	"
" magnesium lamps		85		"	"	"	15		"	"
" sunlight		70		"	"	"	30		"	"
" the "Johannis" beetle		1		"	"	"	99		"	"

The figures given for gas are corroborated by others especially determined for the Argand burner. Since 10 litres of gas are to be counted upon in the latter per candle hour (FAHNDRICH) while for the Wels-

\*The word "heat" is here evidently intended to include in its significance all sorts of non-luminous radiant energy.—TRANSLATOR.

bach an average of 1.7 litres suffices, the relation of heat and light developed by the latter must be 88 and 12 per cent. respectively.

It should be added that, in proportion to the large amount of light developed by the incandescent mantle, the variations in initial capacity of the mantles is not important, and in every case must be estimated not so high in proportion as occurs with electrical incandescent lamps. VON OECHELHAEUSER investigated three groups of the latter rated on the market as 16-candle, which developed 17, 18.5, and 16.8 Hefner lights respectively, or an average of 17.4 HL (=15.0<sup>137</sup> normal candles). The 127 lamps, from various makers, tested by THOMAS, MARTIN, and HASLER, and nominally 16-candle-power, gave an average initial capacity of 15-candle-power. Still greater variations have been determined by CH. HAUBTMANN,<sup>138</sup> viz.: 15 to 21 candle-power (102 volts) for ten sorts of 16-candle lamps from several countries.

#### THE ESTIMATION OF THE DURATION OF LUMINOSITY

of the Welsbach preparation next demands a determination of when the mantle loses its power of emitting light. Hitherto, single mantles have been used for 2400<sup>139</sup> to 4000<sup>140</sup> hours without resulting in an expectation, even after this long period of service, of an expiration of the faculty in question. Indeed, the supposition is at the same time matured, that the luminous peculiarity of the mantle does not generally undergo loss. Since, moreover, a mechanical depreciation revealing itself in a reduction in weight (as is peculiar, for instance, to mantles made of the alkaline earths) has never been substantiated, the life may pass as theoretically immeasurable. The observed loss of luminosity does not enter the question in hand, for it evidently results not from the condition of the material, but from other causes<sup>141</sup> to be considered later; this also explains the frequent phenomenon of an increase in luminosity following a decrease.

In practice, however, these relations present quite another appearance; in practice it is the durability of the Welsbach mantle which plays the most important part. It is the most sensitive point in the system, and is therefore always seized upon by its opponents, chiefly in ignorance of the faults of their own favorites, as a weapon of attack; it has been managed, however, with energy and success by the interested circles. The earlier mantles withstood no vibration, when cold, without crumbling into dust. Even to-day they need careful handling yet thanks to perfection of manufacture (the sharp incineration with gas under pressure by the German Incandescent Gas Light Company) considerable improvement is shown; the mantles may be taken into the hand or laid upon the table, and the care necessary has been reduced to that customarily bestowed upon electrical illuminating apparatus. In a state of incandescence the mantle is supple and tenacious; the delicate web remains, however, and the cracking of the chimney also results in destruction. The latter occurred comparatively often at an earlier date, but has been limited, as already pointed out, to mere accident.

There are Welsbach mantles which have lasted 4000 hours<sup>142</sup> (SHRIDDE). FAEHNDRICH in 1892 wished to standardize a life of only 350 hours. VON OECHELHAEUSER reported in the same year 500, 800, and 2400 hours; amongst 14 burners three mantles perished after 1170, 1950, and 2340 hours respectively. The case of 20 electrical incandescent lamps was placed in contrast, of which 8 burnt out after periods of from 59 to 533 hours. Ten of them were destroyed immediately upon being cut in, four of them from short circuit. Thus, as late as 1892, chance, which had been the cause of inutility of the luminous material at an earlier date, was still revealed in the electrical light to at least the same degree as in the Welsbach. Since then conditions have been changed, by strengthening the mantle, improvement in chimneys, etc., markedly in favor of the incandescent gas-light; so that the estimates of MUCHALL<sup>143</sup> and others, who give 550 hours as a certain life for mantles in a brittle condition, exposed in street-lanterns to the greatest vibration, do not appear to be too high.

DECREASE IN CANDLE-POWER

of the Welsbach mantle has been observed, not exceptionally. Many cases are known in which no decrease in luminosity could be deter-

Tests of	Gas-consumption in litres per hour.	Gas-pressure. Tenths.	Initial candle-power. Hefner lights.	Period of observation. Hours of service.	Final candle-power. Hefner lights.	Decrease in candle-power. Per cent.	Average.	
							Of hours of service.	Of candle-power.
Faehndrich.....	95	8.67	48.0	524	34.0	29.0	..	..
	125	18-18.7	84.0	383	29.0	65.0	..	..
Von Oechelhaeuser	110	7.5-15	58.3 (av'ge.)	500	45.2	22.4	500	50.4
	..	..	..	800	32.7	43.9	800	41.0
for Berlin "burner II."	..	15	61.6	500	54.0	12.4	500	57.1
	..	..	..	800	..	16.3	..	..
Salzenberg.....	90	13.5	64	400	64.0	0.0	..	..
	100	15	..	740	59.0	8.0	..	..
Muchall.....	..	..	..	100	60.0	..	..	..
	..	..	..	500	58.0	..	..	..
Shridde.....	..	..	..	1000	52.0	..	..	..
	..	..	..	1600	48.0	..	..	..
Shridde.....	..	..	..	2000	46.0	..	..	..
	..	..	57.0	4000	33.7	..	..	..

mined after a period of many hours, and also others in which it appeared, after a certain time<sup>144</sup>. However, a decrease must be expected as a rule, and can be attributed to two conditions, viz.: to the impetuous operation of the flame, and to the collection of dust on the mantle. The pressure of the flame doubtless produces a general deformation of the soft mantle, which is thus torn from the hottest zone



of the flame; while the melted atoms of dust which may fall in from without or be sucked in with the gas-supply, gradually coat the netting. Here, also, there are as many results as tests to corroborate. The most noteworthy of them are collected in the foregoing table.

According to this the electrical lamps show no superiority whatever. VON OECHELHAEUSER determined for them a decrease in candle-power of 28.7 per cent. after 500 hours, and after 800 hours of 38.5 per cent., by which time the consumption of energy had fallen to 2.2 watts. Indeed, THOMAS, MARTIN, and HASLER<sup>145</sup> report, as the average candle-power of lamps rated commercially as 16-candle, 8½ English candles after 1000 hours, which amounts to a depreciation of 43.3 per cent. The average candle-power throughout that period amounted to 11 English candles, or 30 per cent. less than the nominal initial luminosity. These results are corroborated by HAUBTMANN,<sup>146</sup> who found, in ten sorts of 16-candle lamps which showed an initial luminosity of from 15 to 21 candles, a candle-power after 1000 hours of 5.08 to 14.98, and as an average for that period 8.50 to 16.00 candles. If 500 hours be taken as a standard for both incandescent systems (which is much more permissible, as shown, with gas than with electricity) the average candle-power according to even the earlier reports of VON OECHELHAEUSER might be counted upon as,

for electricity 14.8 Hefner lights = 12.7 normal candles.  
for the Welsbach 57.1 " " = 50.0 " "

#### STREET LIGHTING—THE OPERATION OF THE WELSBACH INCANDESCENT GAS LIGHT.

For street lighting, which demands a source of light unaffected by weather or vibration, storm proof lanterns and reinforced mantle heads are essential. The former are to be had in good designs, while the mantle is being made only slightly sensitive to even marked vibration by treatment with gas under pressure and by repeated coatings of the head with a special fluid. The results of the tests made in Munich from Feb. 8 to April 24, 1893<sup>147</sup>, according to which three mantles per burner per year were not found sufficient, were later corrected up to Jan. 1, 1894, by those obtained by MUCHALL in Wiesbaden<sup>148</sup>, in which the longest life of burner appears to be 1,493 and 1,741 hours, the average values 705 and 579 hours, and the number of mantles needed per 1,000 hours as 1.42 and 1.73 respectively. It should be noticed that in this case MUCHALL uses glass chimneys. The Munich estimates of TELLER, as well as those of MUCHALL from Wiesbaden, teach what influence is exerted by vibration upon the life of street-lamp mantles; in the first case the consumption of the "consolidated" lanterns should have been only one-fourth of that of the candelabra, and in the latter the ratio of 1.6: 1.1 prevails. In every case, on the other hand, is recommended the assumption of a life of 550 hours for Welsbach mantles.

According to SCHILLING<sup>149</sup> the location of the lamps at a distance of 45 meters (148 feet) from one another at the start (Dec. 6, 1892) gave

an insufficient effect; the decrease of the distance to 38 meters (125 feet) was satisfactory. The surface illumination, which was measured, it should be remarked in passing, with a light-source of very low candle-power, might be styled very uniform; for the measurements were made at various angles and also at considerable distance from the lamp upon a surface normal to the light-rays, as follows:

	For the Welsbach.	For the ordinary lamp.
at 30°	0.86	0.35 metre-candles <sup>150</sup>
“ 40°	1.19	0.58 “ “
“ 50°	1.36	0.74 “ “
“ 70°	1.29	1.1 “ “
“ 80°	0.89	0.9 “ “

The combined operation of two adjacent lanterns provided with Welsbach lights can thus generate 2 metre-candles upon the ground between them; this would be about the brilliancy which prevails upon the ground between two arc-lights of 500 candles each hung 40 metres (132 feet) apart and 8 metres (28 feet) high, while between the ordinary 16-candle gas-flames only 0.012 metre-candles are projected on the ground. SCHILLING recommends for principal streets a distance of 25 metres (82 feet) between lanterns and the combination of three Welsbach lights in each; thus a minimum of 0.8 mc, and a maximum of 8 mc, would be developed. A street in Munich is successfully lighted upon this rule.

MUCHALL reports peculiar destruction of service in the early days caused by little insects being sucked in through the four holes which admitted air in every burner, and were there killed by the issuing gas and thus gradually filled the interior of the burner. This made necessary the clothing of the mixing-tube with fine wire-cloth, by which means the air-openings were protected without contracting the passage-way for the air.

To-day the lanterns in use in a great number of cities prove that the original fears apply no longer and that the Welsbach light shows the same advantages for street as for domestic lighting.

It might be added that a theater (with the exception of the stage) has recently been fitted with Welsbach lights. The use of pilot-lights in this case permits the darkening and re-lighting of the auditorium in the most convenient manner.

From a hygienic point of view, both the complete combustion of the Bunsen burner and the marked decrease in gas consumption per candle-power permit the immediate conclusion that the production of deleterious products and of burdensome heat is in the Welsbach in part entirely removed and in part limited to a wholesome degree. It should be remarked that the mantle itself is absolutely passive, that is, separates no ingredients; the view formerly widely spread that magnesia dust is given off from the mantle needs to be denied, the more so because the Welsbach burner contains no magnesia.

The ordinary luminous flame separates, as a product of incomplete

combustion, the poisonous carbonic oxide, so destructive to the haemoglobin of the blood; according to GRUBER the limit of unwholesomeness is a proportion of carbonic oxide in the air of 0.2 per 1,000. RENK<sup>151</sup> could identify, by the use of the RODOX method, by means of which less than 1 part of oxide to 20,000 of air can be detached, no measurable amount of the gas in the products of a Welsbach burner, even after a 13-hour test; results drawn from other sources coincide with RENK's in showing that the Welsbach light cannot be brought into the question by the perception of vitiation of the atmosphere with carbonic oxide. The opposite declarations of GREHANT are contrasted with this.

For the measure of vitiation with carbonic acid, the well-known rule of VON PETTENKOFER of a maximum limit of 1 per 1,000 has been proposed as a standard and is generally accepted. The occurrence of this gas is a natural result of combustion, but in the Welsbach, on account of decreased consumption per candle-power, is considerably diminished. RENK determined, for instance<sup>152</sup>, that an Argand burner increased the amount of carbonic acid in a room in four hours by 3.394 parts per 1,000, but a Welsbach only 1.427. Since the production of carbonic acid in complete combustion is proportional to the gas consumption, while the latter is utilized in the Welsbach four times as efficiently as in the Argand, the carbonic acid to be calculated upon with the former is only half. The ratio of efficiency between the SIEMENS Regenerative and Welsbach burners is given by KARSTEN<sup>153</sup> as 4.4:1.9, on the average, which expresses the vitiation in production of carbonic acid to be obtained by the substitution of one of these burners for the other. The exception should be made here of the regenerative lamp used for purposes of ventilation, where all products of combustion are led away.

The decreased development of heat is to be attributed to the smaller gas consumption and the more perfect metamorphosis into light. Radiant heat, which comes heavily into the balance against this in all gas-burners with luminous flame, is practically not present in the Welsbach. VON ORCHELHAEUSER could no longer verify any increase of temperature by radiation at a distance of 50 to 70 cm. (19.7:27.6 inches) from the light. It is customary to style the electric glow-lamp as light without heat; according to RENK a 16-candle lamp, in fact, gives out 46 calories (183 B. T. U.) per hour. The ordinary 16-candle gas flame produces about twenty times, and the Welsbach, for equal light, about  $3\frac{1}{2}$  times, as much.

The dazzling effect of the light-source is of interest for the eye, as it especially increases in the use of the Welsbach in school-rooms, etc., where the eyes can be detrimentally affected by the direct rays in looking at the black-board. The large amount of light, indeed, permits the hanging of the burners quite high ( $8\frac{1}{4}$  to 10 feet), although globes, which always cause a loss of light, are still desirable. Accord-

ing to VON OECHELHAUSER the ordinary Welsbach light possesses about 2,000 square millimeters of incandescent surface; upon a basis of 60 candles, 1 candle is derived from an area of about 33 sq. mm. In contrast thereto is the BERNSTEIN estimate<sup>154</sup>, according to which, in the electric glow-light, one candle emanates from only 4 sq. mm. of surface. As the ratio between luminous surface and candle-power is the measure of the blinding effect, the latter thus amounts in the Welsbach to only one-eighth of that of the electric glow-lamp. WEBER has shown how much the human eye can bear: his experiments would indicate from 68,000 to 189,000 metre candles; the latter value was measured upon a white card laid horizontally in bright, open sunshine at mid-day.

There must next be considered the illumination of desks in lecture rooms and drafting rooms; and for this purpose RENK<sup>155</sup> has instituted basic comparisons. He used for his determination an Argand burner of 25.5 normal candles, which he later replaced by a Welsbach of 52.4 nc. The light received by the table below the lamp was:

	With the Argand. Metre cand- les.	With the Welsbach. Metre cand- les.	Increase in Brilliance <sup>156</sup> of Welsbach over Argand.
Beneath the lamp.....	33.71	45.38	34.6 per cent.
50 c.m. (19.7 in.) to one side.....	24.73	32.26	46.6 " "
100 " (39.4 in.) " ".....	11.46	17.71	54.5 " "
150 " (49.1 in.) " ".....	5.36	9.96	85.9 " "
200 " (78.8 in.) " ".....	2.50	6.00	140.0 " "

The uniformity of illumination, which depends upon the form of the light-source, thus appears much more favorably for the Welsbach mantle, since the difference between the brightest and darkest spot amounts to 7.5 fold with the Welsbach and 13.5 fold with the Argand. Shades and eye-protecting globes very much affect the influence of the light. According to RENK the following relations hold true:

	"Milk" glass shade with- out eye-screen. Metre candles.	Eye-screen made of milk- glass. Metre candles.	Eye-screen made of ground- glass. Metre candles.	Variation brilliance due to the use of	
				Milk glass. Per cent.	Ground glass. Per cent.
Beneath the lamp.....	61.65	74.38	57.60	+20.6	-12.5
50 c.m. to one side.....	42.32	34.27	23.28	-19.0	-22.9
100 " " ".....	20.61	12.78	16.00	-37.9	-22.4
150 " " ".....	10.78	5.38	8.32	-50.1	-21.4
200 " " ".....	5.58	2.83	4.88	-48.1	-6.6
Average.....	.....	.....	.....	-26.9	-17.2

The milk glass\* thus gives a greater loss of light than the ground glass. This should be taken into consideration in the arrangement of school-room lights, if the demands of health, to wit: a local brilliancy of 10 candles, with a minimum of 3, are to be met.

The Welsbach, on account of its peculiar tendency to direct the rays obliquely upwards, can also be used with success in the indirect illumination lately come into favor in which, as is well-known, the direct rays radiated downwards are caught by a reflector and, if this be chosen properly translucent, partly diffused but largely thrown back toward the ceiling. In the auditorium of the Hygienic Institute at Halle four WENHAM regenerative lamps, which admittedly radiate their light downwardly, were thus found upon application to indirect illumination, to forfeit all these direct rays; they were placed with two Welsbachs by RENK. This resulted in the increase of the original illumination on the benches, from 17.48 metre candles on an average, to 38.6 mc., that is about 121 per cent. while the gas consumption was reduced by 28 per cent.

That the Welsbach is the superior to other species of illumination in point of cost is practically demonstrated. The ratios have continually increased, as shown, in the course of time in favor of the Welsbach, chiefly due to increased durability of mantle and chimney.

The following examples may be instanced as a comparison of cost with the electric glow-lamp, the momentary local prices for gas and electric current respectively giving various values.

For 600 hours of service per year VON OECHELHAEUSER calculated:

	Marks.
Welsbach light:	
600 hours, at an average consumption (under varying pressure) of 100 l. = 60 cbm. of gas @ 16 pf. ....	9.60
12 months rent @ 60 pf. ....	7.20
4 renewed mantles (2 or 3 are allowed for accidental destruction) .....	1.60
	18.40
or 3.07 pf. per hour.	
3 electric 16-candle glow-lamps at 36. per hour each:	
600 hours at 10.8 pf. ....	64.80
3 lamp-feest @ 5 M. ....	15.00
	79.80
or 13.3 pf. per hour.	
1 50-candle electric glow-lamp	
600 hours at 11.25 pf. ....	67.50
1 lamp fee. ....	5.00
	72.50
or 12.08 pf. per hour	

\*By this is meant, without doubt, what is here known as opal glass, but it may be somewhat different.—TRANSLATOR.

†An expense peculiar to the German system of internal revenue.—TRANSLATOR.

The electric glow-lamp thus proves to be about four times as expensive in operation as the Welsbach.

LANG<sup>197</sup> gives the following estimate, when a candle-power of 48 Hefner lights is desired:

	Welsbach.	3 Batswing Burners.	3 Electric Glow-Lamps.
	Hourly gas consumption 90 litres. Candle-power (mean of 500 hours of service) 48 Hefner lights.	Hourly gas consumption, 120 litres.	Price of Electric Current per ampere-hour.....8 pf. (One hour of service).....4 pf. Price of lamp.....1 M. Candle-power..16 H.L. (Average of 1000 hours of service.)
	Life of mantle..500 hours. Cost of mantle.....150 M. Cost of chimneys ....30 pf.		
Upon 500 lighting-hours .....	Mantles consumed.....1 Chimneys.....2		Lamps consumed.....3
Absolute cost of operation .....	10 M.	31.50 M.	61.50 M.
Upon 1000 lighting-hours.....	Mantles consumed.....2 Chimneys.....4		Lamps consumed.....3
Absolute cost of operation.....	20 M.	63 M.	123 M.

LANG deduces from this a ratio of operative cost between gas and electric incandescent lights as 1:6.

The same experimenter further calculates, upon a basis of corresponding amounts of light a lower operative cost for the Welsbach than for the electric arc-light, as follows:

Hefner Lights.	Lighting Hours.	Welsbach.		One Arc Light. Cost.
		Number.	Cost.	
200	500	4	40	45
	1000		80	90
600	500	12	120	125
	1000		240	250

Unfortunately it is not noted here whether the two lights were compared separately or in combination. As a rule the arc-light would have the advantage in economy where a large source of light is wanted; it must take a lesser place, however, where smaller amounts of light are desired or where a uniform distribution is necessary.

MUCHALL's practical tests lead to the following calculation of the absolute cost of Welsbach street lighting.

For 1000 lighting-hours

	Marks.
Gas.....	10.00
Replacing mantles and chimneys.....	4.32
Interest and depreciation on first cost of burners and for transfer of accounts.....	1.04
Attendance and maintenance of street fixtures.....	7.00
	Total 22.36

The absolute cost of the batswing burner stands, comparatively  
For 1000 lighting-hours:

Gas (0.180 cbm., or 6.25 cu. ft., per hour per burner) 180 cbm at 10 pf.....	18.00
Attendance and maintenance of street fixtures.....	7.00
	25.00

An illumination  $2\frac{1}{2}$  to 3 times as great thus shows a direct saving.

Taking all in all, it must be recognized that the Welsbach light, from the standpoint of economy and health, signifies a great advance in the art of illumination. The earlier views to the opposite, which, clinging throughout to the predecessors of the Welsbach discovery, made use of the argument of analogy, have been practically relegated by the rapid spread of the system and the successful efforts towards making its application general, to localities where statistics are lacking. This advance is certainly not to be mistaken for the limit of the field of illumination; much rather it will still remain the task of science to search for practically useful means for a more complete transformation of heat into light than is possible with the Welsbach mantle.

## REFERENCES.

- 1 *Journal für Gasbeleuchtung*, 1886, Vol. 29, p. 633.
- 2 *Journal für Gasbeleuchtung*, 1889, p. 988; 1891, p. 8; D. P. J. 1890, No. 278, p. 235.
- 3 C. Z. 1891, p. 328.
- 4 British Specifications, No. 8141, of the year 1839.
- 5 British Specifications, No. 11,080, of the year 1846.
- 6 G. P., No. 15,437.
- 7 G. P., No. 22,503.
- 8 G. P., No. 17,786.
- 9 G. P., No. 14,689.
- 10 G. P., No. 13,700.
- 11 G. P., No. 16,640 and 21,205.
- 12 G. P., No. 25,360.
- 13 G. P., No. 26,397.
- 14 G. P., No. 26,404.
- 15 G. P., No. 26,988.
- 16 G. P., No. 27,494.
- 17 G. P., No. 27,519.
- 18 G. P., No. 23,408.
- 19 G. P., No. 29,098 and No. 34,307.
- 20 SCHULTZ-KNAUDT in Essen and JULIUS PINTSCH in Fürstenwa.de.
- 21 Cf. VON KEMANN'S "Mantles for incandescent-gas-lights," *Glaser's Annalen*, 1894, p. 481 *et seq.*
- 22 G. P., No. 39,162.
- 23 G. P., No. 41,945.
- 24 G. P., No. 44,016.
- 25 G. P., No. 74,745.
- 26 Fluid.
- 27 G. P., No. 79,239.
- 28 G. P., No. 77,384.
- 29 German Registry of Design, No. 15,101.
- 30 G. P., No. 43,012.
- 31 G. P., No. 62,026.
- 32 G. P., No. 66,117.
- 33 G. P., No. 72,202.
- 34 G. P., No. 73,173.
- 35 G. P., No. 74,758.
- 36 S. P., Nos. 2,530, 2,531, 2,537, 2,586, 2,587, and 2,588.
- 37 E. P. P., Nos. 225 of the year 1882.
- 38 E. P., No. 1,038 of the year 1880.
- 39 E. P., No. 3,263 of the year 1882.
- 40 E. P., No. 5,337 of the year 1882.
- 41 E. P., No. 6,805 of the year 1889.
- 42 E. P., No. No. 2,689 of the year 1893.
- 43 British Specifications, No. 5,337 of the year 1882.
- 44 *Journal für Gasbeleuchtung*, 1893.
- 45 American patents, Nos. 365, 832, and 367,534.
- 46 *Journal für Gasbeleuchtung*, 1893, p. 309 and following.
- 47 British Specifications, Nos. 13, 129 and 14,091 of the year 1889.
- 48 G. P., No. 21,323.
- 49 United States patent, No. 266,889.
- 50 Swiss patent No. 1,735.
- 51 United States patent, No. 372,933. G. P., No. 43,191.
- 52 G. P., No. 43,991.
- 53 Swiss patent, No. 6,885.
- 54 Cf. of the following descriptions.
- 55 United States patent No. 409,520.
- 56 German Registry of Design, No. 14,064.
- 57 German Registry of Design, No. 14,124.
- 58 United States patent, No. 492,295.
- 59 G. P., No. 40,399.



- 60 G. P., No. 61,314.
- 61 G. P., No. 30,174.
- 62 British Specifications, No. 1,195 of the year 1886.
- 63 G. P., No. 59,274.
- 64 G. P., No. 73,175.
- 65 British Specifications, No. 4,369 of the year 1893.
- 66 United States patent, No. 354,977.
- 67 United States patent, No. 447,757.
- 68 German Registry of Design, No. 20,036.
- 69 G. P., No. 75,672.
- 70 German Registry of Design, No. 7,615.
- 71 German Registry of Design, No. 7,645.
- 72 German Registry of Design, No. 7,578.
- 73 German Registry of Design, No. 12,908.
- 74 German Registry of Design, No. 15,635.
- 75 British Specifications, No. 105 of the year 1883.
- 76 German Registry of Design, No. 16,040.
- 77 British Specifications, No. 5,022 of the year 1891.
- 78 British specifications, No. 9,240 of the year 1891.
- 79 British Specifications, No. 4,240 of the year 1884.
- 80 British Specifications, No. 1,195 of the year 1886.
- 81 German Registry of Design, No. 20,396.
- 82 United States patent, No. 416,548.
- 83 G. P., No. 77,394.
- 84 G. P., No. 74,638.
- 85 United States patent, No. 378,699. British Specifications, No. 5,322 of the year 1887.
- 86 Figure 24, page 24.
- 87 Figure 44, page 40.
- 88 Swiss patent, No. 6,629. German Registry of Design, No. 15,568.
- 89 German Registry of Design, No. 16,315.
- 90 German Registry of Design, No. 16,193.
- 91 German Registry of Design, No. 18,097.
- 92 German Registry of Design, No. 12,396.
- 93 German Registry of Design, No. 12,560.
- 94 German Registry of Design, No. 13,125.
- 95 *Journal für Gasbeleuchtung*, 1893, page 606.
- 96 *Journal für Gasbeleuchtung*, 1893, page 609.
- 97 German Registry of Design, Nos. 11,633 and 11,634.
- 98 German Registry of Design, No. 14,790.
- 99 German Registry of Design, No. 15,922.
- 100 G. P. No. 72,746.
- 101 G. P., No. 78,758.
- 102 G. P., No. 43,012.
- 103 German Registry of Design, No. 23,254.
- 104 German Registry of Design, No. 13,832.
- 105 German Registry of Design, No. 22,973.
- 106 German Registry of Design, No. 29,647.
- 107 German Registry of Design, No. 22,445.
- 108 German Registry of Design, No. 23,786.
- 109 German Registry of Design, No. 23,788.
- 110 United States Patent, No. 165,116.
- 111 *Journal für Gasbeleuchtung*, 1893, p. 609.
- 112 German Registry of Design, No. 13,828.
- 113 German Registry of Design, No. 21,615.
- 114 German Registry of Design, No. 27,580.
- 115 German Registry of Design, Nos. 29,459, 29,960, 31,911.
- 116 G. P., No. 77,800.
- 117 G. P., No. 75,386.
- 118 G. P., No. 76,088.
- 119 G. P., No. 79,199.
- 120 G. P., No. 69,989.
- 121 Swiss patent, No. 6,936.
- 122 *Le Gaz.*, Vol. 38, p. 68.

- 123 G. P., No. 56,863.
- 124 United States patent No. 258,769. British Specifications, No. 13,893 of the year 1889
- 125 G. P., No. 78,866.
- 126 *Journal für Gasbeleuchtung*, 1893, Vol. 36, p. 633.
- 127 G. P., No. 35,776.
- 128 German Registry of Design, No. 12,944.
- 129 See "Form of Mantle."
- 130 1 Hefner light (HL) equals 0.862 "normal candles." (N.C.)
- 131 *Journal für Gasbeleuchtung*, 1892, p. 527.
- 132 Transactions of the *Veria zur Beforderung des Gewerbe*, 1892.
- 133 *Chemiker Zeitung*, 1893; p. 1034.
- 134 *Journal für Gasbeleuchtung*, 1892, p. 527.
- 135 Report of November 12, 1892.
- 136 *The Engineer*, 1896, p. 77.
- 137 One German "Association" candle (normal candle) equals 1.162 Hefner lights.
- 138 *L'Electricien*, 1892, p. 201.
- 139 VON OECHELHAEUSER.
- 140 *Journal für Gasbeleuchtung*, 1894.
- 141 See Chapter VI.
- 142 *Journal für Gasbeleuchtung*, 1894, p. 619.
- 143 *Journal für Gasbeleuchtung*, 1894, p. 273.
- 144 *Journal für Gasbeleuchtung*, 1893, p. 309 *et seq.*
- 145 *Journal of Gas Lighting*, 1892, p. 153.
- 146 *L'Electricien*, 1892, p. 201.
- 147 *Journal für Gasbeleuchtung*, 1893, p. 609 *et seq.*
- 148 *Journal für Gasbeleuchtung*, 1894, p. 273.
- 149 *Journal für Gasbeleuchtung*, 1893, p. 608.
- 150 1 metre-candle is the brilliancy which 1 normal candle throws upon a white surface at the distance of 1 metre.
- 151 Opinion of Sept. 30, 1894.
- 152 Opinion of Sept. 30, 1894.
- 153 Natural Science Association of Schleswig-Holstein, Vol. X.
- 154 A. Bernstein "Ueber die Umwandlung des electrischen Stromes in licht." Hamburg, 1891, p. 20.
- 155 Opinion of Nov. 12, 1892.
- 156 The word brilliancy is used here and often elsewhere in the chapter as a translation of the German word *helligkeit* and really signifies "degree of illumination," which is quite distinct from the photometric significance of the English word "brilliancy."—TRANSLATOR.
- 157 *Chemiker Zeitung*, 1893, p. 1034.

## THE MONAZITE DEPOSITS OF NORTH AND SOUTH CAROLINA.

BY H. B. C. NITZE, E. M.,

Assistant State Geologist of North Carolina.

Not many years ago monazite was considered as one of the very rare minerals of the earth's crust, as the Greek derivation of its name "to be solitary" implies. During the past eight years it has been found, as an accessory constituent of the granitic and dioritic eruptive rocks and their derived gneisses, over widely separated areas of the earth's surface in the United States, Canada, South America, England, Sweden, Norway, Finnish Lappmark, Russia, Belgium, France, Switzerland, Germany, Austria, and Australia, and further search and investigation is liable to reveal its still wider distribution in similar rocks of other countries.

In the great majority of its occurrences, however, it forms but a minute portion of the rock, in many instances being detected by the petrographic microscope only. The commercially economic deposits of monazite are those occurring in the placer sands of the streams and adjoining bottoms, and in the beach sands along the seashore. Such placer and beach sand deposits can only be formed in countries which have escaped the eroding influence of the prehistoric glaciers that once covered a large portion of the earth, particularly in the Northern hemisphere. In those countries lying beyond the boundaries of the former glacial barriers the soft upper layer of decomposed rocks has been held in place, except the dissections caused by fluvial action, and has been preserved from destruction and removal by the moving masses of ice. Such superficial rock-decomposition extends to a depth of 50 to as high as 200 feet, depending on local conditions, and the appropriate name of saprolite (from the Greek meaning "rotten rock") has been applied by Mr. Geo. F. Becker of the United States Geological Survey, to such masses of decomposed earthy, but untransported rock. By water-erosion and secular move-

ments these saprolites are disintegrated and deposited in the stream-beds and bottom-lands below. Here by virtue of running water the material undergoes a natural process of sorting and concentration, the heavy minerals being deposited first and together. This is called a placer-deposit, a term well known in gold mining. Where the saprolites originally contained monazite this mineral, on account of its high specific gravity (4.9 to 5.3), is concentrated together with other minerals, such as rutile, brookite, menaccanite, magnetite, garnet, cyanite, hornblende, feldspar, quartz, etc. The beach-sand deposits have a similar explanation. Here the surf, as it breaks against cliffs of decomposed monazite-bearing crystalline rocks, disintegrates the same and washes away the lighter earths and minerals, leaving naturally concentrated deposits of monazite sand, with greater or less admixture of foreign minerals along the beach.

The geographical areas over which such workable deposits of monazite have been found are very limited in number and extent, and are confined, so far as our present knowledge goes, to North and South Carolina in the United States, the coast of Brazil, and the Sanarka River in Russia.

Of the Brazilian deposits it may be said that the principal ones occur in the beach-sands along the seashore, in the extreme southern part of the province of Bahia. These beach-sand deposits are constantly subjected to the action of the waves and the tide, and while patches of concentrated monazite are found in certain localities one day, their position may be entirely shifted the next, and even placed out of reach, thus placing considerable difficulty in the way of regular, stationary mining operations.

Of the Russian deposits little is known at the present time.

In the United States the placer-deposits of North and South Carolina stand alone. This area includes between 1600 and 2000 square miles, situated in Burke, McDowell, Rutherford, Cleveland, and Polk counties, N. C., and extending into Spartanburg and Greenville counties, S. C. It is not meant to convey the idea that this entire area is monazite-bearing, but simply that within its boundaries are included those scattered deposits which have been found to be of economic value.

The principal deposits are found along the waters of Silver, South and North Muddy creeks; Henry's and Jacob's forks of the Catawba river; the First and Second Broad rivers. These streams have their sources in the South Mountains, an eastern outlier of the Blue Ridge.

The country rock is granitic biotite gneiss, and dioritic hornblende gneiss. The monazite occurs in the gravel-deposits of these streams and their adjoining bottom-lands. The thickness of the stream-gravels is from 1 to 2 feet, and the width of the mountain creeks in which they occur is seldom over 12 feet, and usually less.

The percentage of monazite in the original sand is very variable from an infinitesimal quantity up to 1 or 2 per cent. At the present time, however, these stream-deposits have been practically exhausted,



MINING FOR MONAZITE IN NORTH CAROLINA.—THE BURIED BEDS.

and the monazite must be obtained from the deeper lying bottom-gravels. These are worked by digging pits and removing the overlay of barren soil, from 4 to 6 feet in thickness, and then raising the underlying monazite-bearing sand and gravel with a shovel. The monazite is won from this by washing in sluice-boxes with a small stream of running water, exactly after the manner that placer-gold is worked. The sluice-boxes are about 8 feet long by 20 inches wide by 20 inches deep, and are set at a slight inclination near the mouth of the pit. Two men work at a box, the one charging the gravel on a perforated plate fixed in the upper end of the box, and the other one working



NORTH CAROLINA MONAZITE.—HILL SIDE PLACER WASHING.

the contents up and down with a gravel fork (resembling a pitch-fork) or perforated shovel in order to float off the lighter sands. The boxes are cleaned out at the end of the day's work, the washed and concentrated monazite sand being collected and dried. Magnetite, if present, is eliminated from the dried sand by treatment with a large hand-magnet. Many of the heavy minerals, such as zircon, rutile, brookite, menaccanite, garnet, etc., cannot be completely eliminated, their specific gravity being so near to that of monazite. The commercially prepared sand, therefore, after washing thoroughly, is not pure monazite. A cleaned sand containing from 65 to 75 per cent.

monazite is considered of good quality. Sometimes two sluice-boxes are used, one above the other. The sand is washed down without regard to loss in the first box, whereby a small percentage of very clean product is obtained, approximating perhaps 85 per cent. monazite. The material that flows from the tail-end of the first box into the upper part of the second still contains the greater part of the monazite. It undergoes a similar washing operation in this second box, whereby a second grade of sand is obtained which contains, say, 60 to 70 per cent. monazite. From this box there is always an irrecoverable loss of monazite in the final tailings, which in cases, is considerable. Sometimes this second grade, after being dried, is still further cleaned by pouring in a fine stream from a small spout, placed some 4 or 5 feet above a planed board or a cloth. As it falls in a heap, the lighter sands, together with some of the fine grained monazite, collect around the periphery of the pile and are constantly brushed off by a common clothes-brush.

Another primitive process in vogue is to allow this fine stream of sand to fall through a winnowing-machine, such as is used by farmers in separating chaff from wheat, whereby the lighter sands and fine grained monazite are blown off in a separate pile from the heavier monazite and other mineral grains (rutile, garnet, etc.). These dry tailings are then rewashed in the sluice-box, and a third grade of fine-grained monazite is obtained.

It will be seen that in these methods of washing and concentration, in the first place it is impossible to make a perfectly clean monazite product in any quantity, by far the greater proportion containing in the vicinity of only 65 to 75 per cent. monazite, the remaining 35 to 25 per cent. being chiefly rutile, garnet, and some other heavy minerals; secondly, there is always a considerable loss of monazite in the tailings; and thirdly it is a time consuming and tedious process.

The advantage, therefore, is evident of devising some process by means of which the impure monazite sands can be concentrated and cleaned to practically absolute purity on a commercial scale, at a reasonable cost, and with virtually no loss in the tailings. This has in fact been successfully accomplished, and it may not be long before it is put into practical operation.

As in all other localities, so also in the Carolinas, the percentage of thoria in the monazite is variable. It ranges from less than 2 to as high as 6 per cent.

It is only within the past three years that the mining and concentration of monazite sand in North and South Carolina has grown to a regular industry. In 1887 some twelve tons of sand were shipped from the Brindletown district in Burke county, N. C., and during 1888 and 1889 a number of tons were shipped to Philadelphia.

The product for 1893 amounted to 65 tons, for 1894 nearly 300 tons, and for the present year the last amount will probably be more than doubled.

## INCANDESCENT LIGHTING BY GAS AND ELECTRICITY IN COMBINATION.\*

THE BURNER DESIGNED BY LOUIS DENAYROUZE, ENGINEER, OF PARIS.

As long as gas was the sole means of illumination for cities and important industrial establishments all propositions for the improvement of the burner by a more effective utilization of the gas were met only with distrust. This situation, however, has been altered since electricity, which has for some time seriously endangered the future of illumination by gas, has been utilized as a source of light. The rapid spread of the incandescent gas-light in the last few years quickly destroyed the fears raised by the electric light, and to-day it is already recognized that gas is maintaining a successful fight with electricity, as well in quality of production as in reference to intensity of illumination. This remarkable means of illumination [electricity], should by no means be allowed to drop entirely, even if it is no longer the exclusive source of lighting, but may be combined with advantage, by reason of its dynamic peculiarities, with illumination by gas.

This line of thought forms the foundation for the present invention, which is distinguished by the combination of a gas-burner with a ventilator which sucks in the air necessary for combustion and which is driven by means of a little dynamo or magneto motor; which in turn is fed by an electric current brought through wires laid along the gas-fixture.

In my design, as is evident from the illustrations, the electricity is used as an aid in the supply of air, and its work, as is explained further on, is to mix the same thoroughly with the gas in order to solve most completely and economically the problem of illumination by incandescent gas-light. The accompanying cuts illustrate two forms of the device in question.

Figure 1 is a vertical section through a design provided with only one burner, while Figure 2 gives the elevation of a two-armed gasolier.

\* From the *Austria-Hungarian Illustrated Patent-Gazette*.



The gas is let in from above through the pipe *a* where it passes through the hollow spindle *b* of a little motor driven by electric current. Below the motor *c* is placed a ventilator *d* whose fan-wheel *e* is rotated, whereby the outside air is sucked in through the opening *f* and driven into the magazine chamber *h* through the passage *g*. The hollow spindle *b* has its lower end projecting into this chamber, which is provided at this place with the holes *f'* through which the gas enters the chamber *h*. On this lower end of the spindle *b* are placed discs *i* which rotate with the motor *c* and thus intimately mix up the gas streaming out of the supply pipe and the air brought in by the ventilator. This combustible mixture now flows through the pipe *l* provided with a cock *m* to the burner *k*, which is constructed preferably

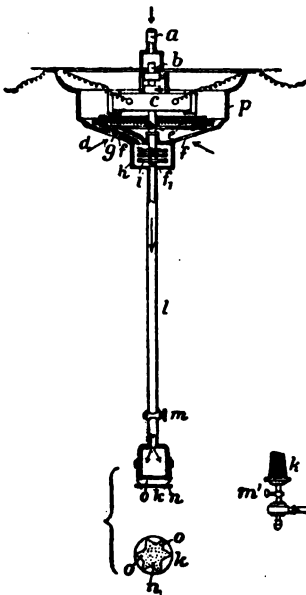

Fig. 1.

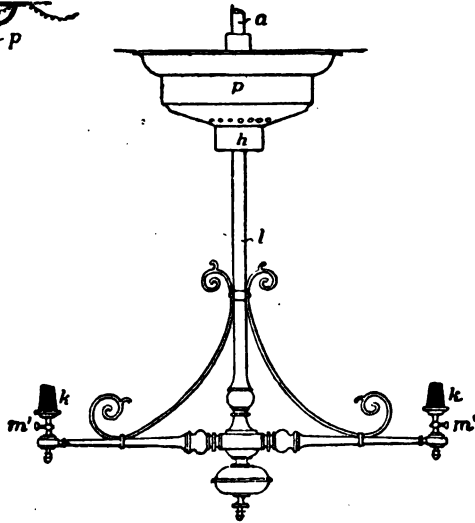

Fig. 2.

of refractory incandescent material. In Figure 1 it is represented as a star-shaped plate *n*. The combustible mixture flows to this star—made, for instance, from magnesia—through a great number of holes *o*, which are suitably arranged in the form of the star.

This star can be replaced, as shown in Figure 2, by wicks, stockings, or baskets made of similar luminous and durable material.

All the rotating portions of this design—the electric motor, ventilator, and mixing device—are enclosed in a casing *p*.

The cock *m* (Fig. 1) as well as the cocks *m'* (Fig. 2) can be operated electrically so that the ignition and extinction of the burners can be operated automatically.

The experiments which have been made with the above described

design have led to a similar and perceptibly better means for the supply of combustible mixture—that is, to the simultaneous sucking in of air and gas by means of the ventilator. This arrangement is shown in Figure 3, partly in elevation and partly in vertical section. The important improvement consists in the arrangement of the ventilator *d* and the little electrical motor *c* between the point of mixing of air and gas and the true burner *k*. The construction of the admission chamber is plain from the cut. The gas enters in fine jets, as an Argand burner, through the openings of a mouthpiece *h'* while the air is brought in through the conical tube *i'*. Mixing is started in the first place by the active sucking of the ventilator and is completed inside the ventilator by the movement of the fans operating upon the masses of gas and air.

In order to indicate the significance of the success of the results attained, it is sufficient to state that this design, with only an inconsiderable velocity of the ventilator wheel, reached the intensity of one Carcel lamp [= 8 to 9 English candles] with a consumption of 0.247 to 0.282 cu. ft. of gas, and that this consumption was reduced, at a higher speed, to 0.176 cu. ft., and indeed, with the help of regenerative combustion, to a still smaller quantity. The economy attained is consequently from three to four times that of the best gas-burners.

It is evident that the ventilator may bring about the desired mixture by the most various means (such as wings, scoops, screw-wheels, etc.). The construction and principle of the design makes possible the increase in the most simple manner of the economy offered by the generative combustion. For this purpose it is sufficient to provide the suction openings of the ventilator (Fig. 3) with a tube *l'* which can be carried above the burner in the form of a spiral. If it is desired to carry the re-heating very far, it is only necessary to use the ordinary gas-lamp chimney in combination, above or below, with a tube crown and to draw in the air through this.

An effective illumination can also be attained with this design by means of an increase of oxygen and hydrogen supplies. Thus, since the electric current driving the motor can supply at the same time the 3 volts necessary for the electrolysis of water, it is plain that the mixture of gas and air can be enriched by oxygen and hydrogen, as the nitrogen contained in the atmosphere ordinarily absorbs, unused, a considerable portion of the heat developed. For this purpose it is only necessary, to gain a marked enrichment, to dissociate the necessary amount of water by means of the electric current in the vicinity of the burner; in which case the necessary precautions for the avoidance of explosion are, of course, to be observed.

The claims of the patent are as follows:

1. An illuminating device for the incandescent gas-light, as described, whereby air is drawn in by means of a ventilator placed in the supply-pipe (*a, l*) and driven by electrical motor *c*, and is intimately mixed in the mixing-chamber *h* with the gases flowing to the burner *k*.

2. The modification of the illuminating device described in 1, so that the mixing-chamber *h* for gas and air is placed before the ventilator *d* (Fig. 3) in such a manner that this leads the gas and air already mixed to the burner, which is so placed as to re-heat the aforesaid air on its way to the mixing-chamber.

3. The enrichment of the combustible mixture with hydrogen and oxygen, which materials are produced by the destructive electrolysis of water by means of electrical current in the neighborhood of the burner.

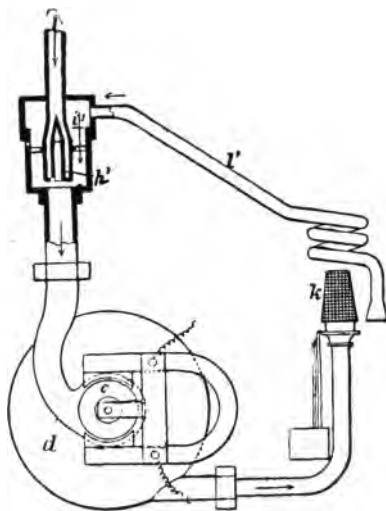

*Fig. 3*

The French patent taken  
out by Denayrouze is numbered 245,457; Feb. 28, 1895.

## THE DECISION OF JUSTICE WILLS IN THE ENGLISH WELSBACH SUITS.

Judgment was given in these two actions by Mr. Justice Wills, in the Queen's Bench Division of the High Court of Justice, on April 18. The trials commenced on March 9 and extended over fifteen days, Mr. Justice Wills then reserving judgment.

### THE DE MARE JUDGMENT.

The plaintiffs complained of threatened infringements by the defendants of letters patent granted to Carl Auer von Welsbach for the manufacture of an illuminant appliance for gas and other burners, bearing No. 15,286, of 1885. The defendants deny that what they propose to do will constitute an infringement of the patent, and attack the patent on nearly all possible grounds.

It has long been known that certain substances, notably lime, magnesia, and zirconia, when subjected to the heat of a flame of mixed coal-gas and air will produce a brilliant incandescence. The common oxyhydrogen limelight is well known. Zirconia had been used—on a very small scale—in the same way, and the illuminant properties of magnesia were also well known. Many attempts had been made to utilize these properties by introducing such substances into the flames of gas, or of gas and air mixed, but they had all, for one reason or another, come to nothing. I am not going to enter at present into questions of anticipation, but it is quite safe to say that for all practical purposes Welsbach discovered a practical and simple method of arranging oxides, to be rendered incandescent, in a shape which made it possible to use them in burners, and also discovered that a class of substances, which for convenience and brevity are generally spoken of by chemists, also throughout the hearing of this case, as "rare earths," would afford at once, when blended with zirconia, the necessary illumination and the necessary coherence. "Earth" in the specification is used—and it appears to be the general practice of chemists so to use it in reference to the substances with which this patent is concerned—as a synonym for the oxide of a metallic base, or of metallic bases, and the names of substances which end in "a" designate the oxides of the corresponding metals whose names end in "um." Zirconia is oxide of zirconium; lanthania is oxide of lanthanum and so on. It is perhaps an

elementary thing to mention, but I have found out in the course of this case that even the men of science do not always use these terms correctly. Even so great an authority as Professor Crookes, in one passage of a work which has been much cited, uses the name of an oxide in correlation with the name of the metal, where it is clear that he means to compare either the two metals or the two oxides; and Sir Henry Roscoe told us, towards the end of the case, that chemists have almost an inveterate trick of failing to distinguish between the oxide and the metallic base. No doubt it does not mislead them, but it is apt to be confusing to an outsider like myself; and I have thought it as well to mention it.

#### THE RARE EARTHS.

One other matter had better be referred to before I proceed to discuss the specification. There is a group of metals whose oxides are "rare earths," known to chemists as the cerium group. The cerium group is divided into two sub-groups, the cerium sub-group and the yttrium sub-group. They possess many—indeed, most—properties in common, but are distinguished by one marked line of division, very definite to the chemist. The salts of the cerium sub-group when in solution are precipitated by potassium sulphate, whereas the salts of the yttrium sub-group are not so precipitated; so that there is no difficulty in separating the two sub-groups. The different members of each sub-group can only be separated by a very elaborate or troublesome process known as fractional precipitation; and the members of the yttrium sub-group are particularly difficult to disentangle.

The cerium sub-group of metals consists of cerium, lanthanum, didymium, samarium, and, perhaps, a fifth member. The two latter are extremely difficult to separate from didymium, are in very small quantities, and need not be further noticed.

The yttrium sub-group consists of yttrium, known for a century past, erbium, known for nearly a century, terbium, and a number of others, which, as Professor Dittmar remarks, in the *Encyclopædia Britannica*, seem to grow like the minor planets. They are exceedingly alike in properties and behavior, and are, excepting yttrium, exceedingly difficult to isolate, and, for practical purposes, inseparable when found together.

The members of both sub-groups are frequently found together, as in a mineral called gadolinite, one of the principal sources whence they are extracted, so that the power of easy separation by potassium sulphate, which divides them at once by precipitation of the cerium sub-group, is important. The members of each sub-group are also frequently found together. Few of the members of either sub-group are found without traces of other members, either of the same or of the other sub-group; but this case is not concerned with traces, which need not be further alluded to. Yttrium is obtained from a mineral called samarskite, which contains none of the metals of the cerium sub-group. Cerite is a mineral which contains cerium, didymium and lanthanum but none of the members of the yttrium sub-group. There are other minerals which contain both cerium and yttrium, or combinations of the respective metals of both sub-groups in great variety. In all cases the minerals from which the rare metals or their oxides are

extracted have first to be freed from certain grosser impurities, such as silicon, oxides of iron, and the like. That having been done, the two sub-groups are easily separated by the potassium sulphate precipitation above described. The only further separation which need be considered is with respect to the cerium sub-group, whence, according to the patentee, the bulk of the cerium, and the whole—or practically the whole—of the didymium must be extracted. I have used the present tense—perhaps inaccurately—as I am speaking of what was known in 1885, the date of the patent. Since then, and in consequence of Welsbach's patent, a great industry in the production of the salts of the rare metals in question has sprung up, and a great deal more is known about them now than was then known. But Professor Crookes had in 1883 and 1885 delivered two lectures upon them at the Royal Society, which had been published, which contained the results of great research into their nature and connection with one another, and the means of separating them. They are to be found in his *Select Methods of Analysis*. If I were to change the names of the metals into those of the oxides, substituting, for instance, yttria for yttrium, and the like, my statement would be equally correct.

The patentee has coined one phrase which, apparently, is not to be found in the books. He speaks of "ytterite earth." "Cerite earth" appears to have been a common phrase enough, but, oddly enough, "ytterite earth" was not a phrase in common use. It is, I think, beyond all doubt that he uses it in a sense precisely analogous to that in which "cerite earth" was commonly used—that is, not for the natural minerals containing yttrium and its associated metals, but for the composite oxides of yttrium and the other members of the yttrium sub-group after the first process of separating them from such impurities as silicon, iron, and the like had been performed. With these preliminary remarks I proceed to ascertain what the meaning of the specification is.

#### CONSTRUCTION OF THE SPECIFICATION.

I have been referred to various supposed rules for the construction of specifications, but have not derived the slightest assistance from them. Such as have been suggested appear to me either too obvious to need enunciation, or to require so much qualification as to be apt to mislead. I am not greatly helped, I confess, by being told that "it is the duty of the Court fairly and truly to construe the specification, neither favoring the one side nor the other; neither putting an unfair gloss upon the specification to save the patent if it is said that the patent is void, nor putting an unfair gloss upon it to make it include something which you may think it was unhandsome to take from the patentee"—even though this proposition is to be found in the reports of cases in the House of Lords. A specification, like any other document, must be construed as one best can construe it, by trying to see not so much what the draughtsman meant—commonly his desire is to be as vague as possible without endangering the patent—as what he has said, and it is only by a critical examination of the specification, illustrated by the common knowledge existing at the date of the patent, that one can arrive safely at the construction.

Welsbach heads his patent "manufacture of an illuminant appliance

for gas and other burners." "My invention," he says, "relates to the manufacture of an illuminant appliance in the form of a cap or hood, to be rendered incandescent by gas and other burners so as to enhance their illuminating power." So as to enhance, that is, the powers of illumination already possessed by the burners. "For this purpose," he continues, "I employ a compound of oxide of lanthanum and zirconium" (he means, obviously, "a compound of the oxides of lanthanum and zirconium") "or of these with oxides of yttrium, which substances in a finely divided condition when they are heated by a flame give out a full, large, almost pure white light, without becoming volatilized or producing scale or ash, even after being kept incandescent for many hours, but remain efficient without deterioration even when they are long exposed to the air."

He then proceeds to give what I may call specimen prescriptions for blends, with which it will, I think, be more convenient to deal presently. Having done so he proceeds: "For applying the substances mentioned as an illuminant, I use a fine fabric preferably of cotton previously cleansed by washing with hydrochloric acid. I saturate this fabric with an aqueous solution of nitrate or acetate of the oxides"—that is the oxides already mentioned in the opening sentences of the specification, and in what I have called the prescriptions—"and gently press it until it does not readily yield fluid, so that in stretching or opening out the fabric, the fluid does not fill up its meshes. The fabric is then exposed to ammonia gas and, when it has been dried, is cut into strips and folded into plaits." A method is then described of giving the desired shape to the cap or hood and of suspending it in the chimney of the lamp, which it is not necessary to discuss. "On igniting the flame," he continues, "the fabric" (*i. e.*, the cotton groundwork upon which the oxides have been deposited) "is quickly reduced to ashes, the residuum of earthy matters nevertheless retaining the form of a cap or hood. For part of the zirconia," he then says, "a mixture of magnesia and zirconia may be employed. . . . Obviously fabrics of various forms or constructions may be employed according to the character of burner to which they are applied." Then follows a paragraph relating to means of strengthening the resulting structure, which is not material.

The patentee then claims: "The manufacture, substantially as herein described, of an illuminant appliance for gas or other burners, consisting of a cap or hood made of fabric impregnated with the substances mentioned and treated as set forth."

I have passed over what I have called the prescriptions, because I wished to present in the simplest form the outline of the process adopted, which begins by taking a fabric made, say, of cotton, of suitable pattern, and proceeds to impregnate it with salts of the blends of oxides in question, and then ammoniates it. The result of the soaking is to get the salts into every minutest portion of the fibers of the fabric, so that when finally the cotton fabric itself is eliminated by fire, there may be left a solid substance occupying almost the very portions of space found filled by the impregnated fabric. The result of ammoniation is to convert the salts into hydrated oxides, filling, as did the salts, the innermost recesses of every portion of the fabric.

The fabric is not yet fit for permanent use in the burner. The last

operation is performed when the hood is placed in the burner and set on fire by lighting the gas. This process drives off all the water of the hydrated oxides, and reduces them to their final condition of anhydrous oxides, in which state they perform the business purpose of giving illumination by incandescence. This seems to me to be, so far, the essence of the Welsbach process.

I now come to the prescriptions. "The proportions in which the substances" (the substances which had already been mentioned being the oxides of lanthanum, zirconium, and yttrium) "are compounded may be varied within certain limits. I have found the following proportions very suitable:—60 per cent. zirconia or oxide of zirconium, 20 per cent. oxide of lanthanum, 20 per cent. oxide of yttrium. The oxide of yttrium may be dispensed with, the composition being then:—50 per cent. zirconia, 50 per cent. oxide of lanthanum. Instead of using the oxide of yttrium, yttrite earth, and instead of oxide of lanthanum, cerite earth containing no didymium, and but little cerium, may be employed."

A great deal of evidence and description was, as it seems to me, wasted upon the meaning of the last sentence, which seems to me to be perfectly clear. The oxides or earths of the yttrium sub-group are very easy to separate from those of the cerium sub-group—very difficult indeed to disentangle from one another. If, therefore, you are getting your yttria from a natural mineral, which contains besides yttria appreciable quantities of the other members of that sub-group, you need not go any further nor take any trouble to separate them from one another. They will do as they come. Of the cerium or ceria sub-group, lanthania is the oxide you want. Didymium you must eliminate, and much cerium will interfere with the desired results. Therefore if you are approaching your lanthania through cerite earth, that is, through compound oxides of the cerium sub-group, you must get rid of the didymium if the cerite earth contains it, and you must get rid of all but a small quantity of the cerium. If your cerite earth happens to contain no didymium and only a small quantity of cerium, it will do as it is, and without further separation.

It seems to me now possible to understand exactly what the patentee claims. It is not the prescription, apart from the rest of the process. It is not the construction of the skeleton, or, as it has been aptly termed, a simulacrum of the vegetable fabric, in any oxides, or in any oxides which will give good and durable incandescence (a claim which would certainly vitiate the patent), but it is the combination of the various essential elements in the process described, the manufacture of the hood out of the substances mentioned by the patentee (no doubt because he had ascertained that they would answer) by the means of impregnation with the blends or salts within the descriptions and proportions indicated by the specification, including, of course, all such variations of proportions or of strength of solution as are fairly within the specification as it would be understood by a competent workman, and brought to its final condition for every-day use by being put into the burner, and so having the carbon filaments and threads burned out and the anhydrous oxides left in the precise shape which the fabric had, till burned out, assumed. If the process which the defendants held out



that they were going to use is substantially identical with this process, they are liable in this action. If it is not so, they are entitled to my judgment.

But before discussing the question of infringement, I must deal with the objections which are raised to the patent itself. They comprehend nearly every objection that can be raised.

#### ALLEGED ANTICIPATIONS.

The invention, it is said, was not the proper subject of a patent, having regard to the state of common knowledge at the time. It was not new. It was not useful. The specification is too vague, because the proportions of the oxides are misleading and would not produce a good result, and because no sufficient directions are given as to the strength of the solutions or the means of burning out the fibrous material. The specification does not sufficiently distinguish between what is old and what is new in the invention.

I will deal with these objections *seriatim*:—

1. The invention was not the proper subject of a patent with reference to what was known, and was not novel.

In my opinion these objections are singularly ill-founded. The invention, with improvements which have naturally followed in its train, has undoubtedly created a great new industry, not only in the caps or hoods, which are the subjects of it, but in the extraction of the oxides and salts of the rare metals. The globe has been ransacked for new sources of supply. How great in this direction has been the effect of Welsbach's discovery will be found in an interesting passage in Professor Dewar's evidence to which no exception has been taken. The invention has accomplished what has long been a desideratum—what has been attempted before, but always with an utter want of success; and it has for the first time brought within the range of practical manufacture the production of a brilliant light by incandescence within an ordinary gas-flame.

The evidence on this point seems to me absolutely conclusive, but it is right that I should consider in detail the various alleged anticipations which have been relied upon. The first is a specification, No. 8,141 of 1839, by one Alexander Cruickshank, who proposed to coat a cage of platinum with lime—the coating to be obtained by dipping the platinum cage into chalk and water or covering it with quicklime and then putting the cage over the gas-flame. The process, however, is perfectly useless. The oxide of calcium simply drops off the platinum, and it is impossible to get a coherent structure of the oxide. The different rates of expansion of platinum and oxide of calcium alone seem a sufficient explanation of the futility of Cruickshank's suggestion, apart from the absolute difference between his mechanical coating of the metal by the lime and the chemical method of Welsbach's patent, by which the nitrates are made to submit to decomposition and deposit their oxides.

The next alleged anticipations are to be found in two patents, taken out in 1880 and 1883 respectively, on behalf of a French gentleman named Clamond. The first is for an attempt to apply the incandescent qualities of lime or similar substances, such as magnesia or

zirconia of which we have a familiar example in the ordinary oxyhydrogen or limelight, to burners for domestic use, and has absolutely nothing in common with Welsbach's process. The second was on similar lines with the first, and proposed to direct a jet of mixed gas and air against a set of small parallel cylinders or sticks of magnesia, which were to be rendered incandescent by the flame of the jet. It was again a kind of modified oxyhydrogen limelight, and in no way comparable with Welsbach's invention.

The next suggested anticipation is in a provisional specification of 1882, filed by William Robert Lake, on behalf of one Stokes Williams, of New Jersey, U. S. A. It contains no less than 43 different heads, and embraces a vast variety of suggestions, many of the very crudest nature. By his eighteenth paragraph he proposes to build up or form the light-emitting portions of what he calls his thermo-candle by the deposition of metal or metal alloys upon an earthy material such as zirconia, gypsum, lime, etc., obviously proposing metal as the source of incandescence. Under his twenty-first head he proposes to construct the said light-emitting portions by the deposition—apparently by a process of electrolysis—of metal or metal alloys upon filaments, strings, threads, or pieces of cotton, etc. Twenty-secondly, to form the same light-emitting portions by the deposition of highly refractory metals or alloys upon a base or form of other materials—some sort of metal framework—which was, I presume, to incandesce and so give out light. The parts of the specification from heads thirty-firstly to thirty-ninthly were relied upon. But they again all, or almost all, relate to the deposit in some fashion or other, generally by a process of something like electrotyping of some metal which is to give out light. He suggests in one place that a destructible material can be used as the base upon which to effect this metallic deposit, and then that the base may be burned away, leaving a very thin metal frame, thinner than can be obtained in any other way, and that such thin framework may be alloyed with, or covered with, or coated with, other and indestructible materials such as magnesium, zirconium, etc. Still the metal is to coat the framework and be the incandescing thing; and he suggests that by decomposition and recomposition of "salts or oxides of metals" a metallic coating may be obtained for a piece of fiber, gauze, asbestos, muslin, or what not, which has previously been dipped in "salts or oxides of magnesium or other material." Two passages, numbered 38 and 39, have been pressed upon me over and over again as containing a kind of germ of Welsbach's invention. It requires, in my opinion, all the extreme benevolence of construction and inference bestowed by those who desire to possess themselves without payment of the fruits of another's industry and brains to extract from them a hint in the direction of what Welsbach has done. Welsbach has shown how to do it, and it is astonishing to find how easily it is done, and how readily it is to be got out of Stokes Williams' generalities by those to whom Welsbach has shown the way. I have no doubt the companions of Columbus took the same view of the problem how to make the egg stand upright after he had solved it for them.

As to No. 38, Dr. Helmer, the principal, and an extremely able, scientific witness called on behalf of the defendants, confessed at last

that he could make neither head nor tail of it; and for all practical purposes No. 39 is very little better. Stokes Williams gives me the notion of being a man with a wide range of extremely superficial knowledge; and when whatever there may be of ingenious suggestion is buried beneath a hopeless mass of unintelligible generalities and ambiguities, which deprive it of any practical use, it cannot be regarded as deserving of serious notice as an anticipation. There is scarcely a discovery in the arts or in physics for which some vague ante-type may not be found in earlier writings. The Glacier theory, which Professor Forbes reduced to a scientific certainty, was in such a sense anticipated by Bishop Rendu, and Perkins' steam gun, which used to be exhibited when I was a boy, was anticipated by every lad who struck a bit of cork into the mouth of a tea-kettle and watched the steam blow it out.

The next anticipation relied upon is contained in a patent of 1883, taken out by William Heather Spence for a Swede named Fahnehjelm. This again consists of a number of small sticks or pins, made of the powdered oxides of magnesium, calcium, zirconium, silicon, or similar materials, which are to be exposed to the flame of water-gas. They are to be made into a paste with gum or starch, etc., and then moulded into the right shape. It is another application of the principle of the oxyhydrogen limelight, and presents not the least resemblance to Welsbach's invention.

The last of the alleged anticipations are to be found in three papers published, respectively, in a German technological periodical and in two issues of a like journal in France, about the years 1848-9, relating to a process by which one Frankenstein professed to have saturated tissues of one sort or another with a mechanical mixture of powdered lime or magnesia, or lime and magnesia, or chalk and calcined magnesia, with water alone, or with water and gum arabic, or some similar material. The tissue was then made into a suitable form, introduced into the burner, and set fire to. Frankenstein asserted that with great care the remaining earthy substances would hold together during one period, and give a bright light. There is absolutely no analogy between this mechanical application of the substances intended to incandesce and the chemical mode of deposition of the oxides upon and within the interstices of the fabric to be destroyed which is effected by the Welsbach process. It is further proved by the plaintiffs' witnesses, and admitted by those for the defendants, that it is absolutely impossible to obtain even the slight coherence alleged to have been secured by Frankenstein without the introduction of the salts of sodium or some other body into the mixture.

There appears to me, therefore, to be no ground whatever for the attack upon the patent on the score of want of novelty. The field upon which Welsbach entered was untrodden, and marked only by the absolute failure of every attempt to penetrate it.

#### THE AMMONIA PUZZLE.

2. It is next set up that the invention was not useful—a singularly hopeless contention. The invention has, no doubt, undergone many improvements since it was first introduced, and it would be unfair to estimate the value of the results achieved in 1885, or early in 1886, by the

brilliant incandescent lighting of the present day; but the evidence is conclusive that with the original invention of 1885, and nothing else, a candle-power per cubic foot per hour of gas consumed was obtained which greatly surpassed the best result obtainable at that date. Mr. Sugg was the only witness called to give evidence in a contrary direction. Welsbach saw him in May, 1886, with reference to taking up the patent. Mr. Sugg was largely interested in what were known as regenerative gas burners, and was not likely to look with a favorable eye upon an invention which would interfere with his own business. He was very hazy in his recollection of candle-power, but thought it about equal to that produced by his own processes. The evidence, on the other hand, of the plaintiffs' witnesses is definite and precise, and it came from the witnesses upon whom I feel that I can place reliance. Mr. Sugg also said that the invention in 1886 was not likely to be a commercial success—a view very likely to tinge his recollections unfavorably—but having nothing to do with the question of utility in reference to the validity of the patent.

Under the head of non-utility may be considered a very serious attack upon the patent—very stubbornly maintained—in respect of the direction in the specification to ammoniate the mantle before burning it—a direction which it was said would, under some conditions not excluded by the specification, be fatal to the mantle, which will, in such case, fall to pieces. The evidence upon this head has been given piecemeal. Strictly speaking, it ought to have been closed before the learned counsel began their concluding addresses in this, the *De Mare* case. This case, however, was followed by another against the Sunlight Company in which the same question arose, and as to which I could not limit the inquiry to the evidence in the first case. The result has been that practically I am applying the evidence on the subject of ammoniation given in both cases to the action with which I am now dealing; and as each fresh allegation of a new cause or element of failure had, as a matter of common fairness, to be tested by the plaintiffs, the cross-examination of whose witnesses had not indicated what was going to be said, there has been an amount of evidence and discussion, backwards and forwards, which, however inevitable, is undesirable, and has been embarrassing enough to me, though it has ended, notwithstanding great complication, in a very simple result. I do not propose to go into any considerable detail, though I think it necessary to give an accurate outline of what took place. The plaintiffs gave evidence in the first instance, by several witnesses, that they had made ammoniated mantles by the Welsbach specification of 1885, and nothing else. They were all good chemists, but a skilled workman for the purpose of such a manufacture as that of the present patent must be a skilled chemist. They were of precisely the same class as the witnesses called by the defendants to show that they had failed, and no exception has been taken to them on the ground that they were not of the right class to test the specification. The ammoniated mantles made by the plaintiffs' witnesses—running into the hundreds—were all coherent and satisfactory. The process was performed in court. The defendants' witnesses, on the other hand, said they had made ammoniated mantles in great numbers by the specification which all fell to pieces, and all those which

they made in court did fall to pieces. The plaintiffs suggested impurity in the materials. The defendants answered that they had procured the materials from known chemical manufacturers, that they were commercial articles, and must be taken with the ordinary risk of impurity attaching to a commercial article. There is a fallacy here. In 1885 neither the salts of zirconium nor those of any of the rare metals in question were in any true sense commercial articles. A chemical manufacturer would produce them if ordered, and they figured in catalogues of chemical manufacturers at prices per gramme which, in the case of nitrate of zirconium, works out to £3 an ounce; and the prices of some of the other substances were very much greater. There was, in fact, at that time no commercial use for them at all. Some of the salts of cerium were used in medicine for certain disorders of women—zirconia was occasionally used for the oxyhydrogen light. There was no other use for any of them except for laboratory experiments, and I think it clear that under these circumstances the patentee is not hurt by the fact that, now that, in consequence of his invention, a large industry in these things has sprung up, there may be sources of danger in the now commercial article which he could not anticipate, and I think he is entitled to be judged by the results when the components of his prescription are used in a substantially pure state. I am sure this was the view originally taken by the defendants' counsel and witnesses, for every witness called by the plaintiffs described the process he had used and how he had purified the salt, and it was not even hinted at in cross-examination that anything unreasonable in this respect had been done. Mr. Swinburne, upon whom the brunt of a great part of the battle fell, described in his evidence the steps he had taken to get the salts required pure, and no suggestion was made, till the defendants were answered upon all other points touching the ammoniation, that anything had been done to which the patentee was not fairly entitled, and I am satisfied, quite as much by what was not said as by what was said, that any fair-minded man who had wished to make a Welsbach mantle by the specification would have begun by seeing that his chemicals were substantially pure.

The plaintiffs, of course, asked to be allowed to test the solutions which had led to failure in the hands of the defendants' scientific witnesses, a most reasonable demand, stoutly resisted, as were other reasonable requests of the same kind, and acceded to only after pressure from myself. It turned out that they contained 10 per cent. of nitrate of potassium. "That," said the defendants' witnesses, "is of no consequence." "How do you know that?" was the natural question. The answer was a remarkable one. Instead of saying "We have cleared the solution of its 10 per cent. of nitrate of potassium," which can be done with perfect ease, they said: "We have taken a perfectly pure solution and added to it 10 per cent. of nitrate of potassium, and it makes no difference." The plaintiffs answered, and it seemed to me a good answer: "We have taken the solution with which you have failed, and simply by purifying it have got perfectly good mantles." Mr. Ballantyne was put into the box and described how he had purified the solution—omitting details, it is sufficient to say—by the use of hyposulphite of soda. No exception was taken at the time to the method

which he had adopted for purifying the solution. This was on Friday, 20th March. By Monday morning, 23rd March, the defendants had discovered that this was not the right way of purifying the zirconium salt, according to the knowledge of 1885, but that it ought to be purified by ammonia, and that if the ammoniacal method of purifying the nitrate of zirconium were adopted the mantles would fail. A very intricate inquiry was embarked upon, having, to my mind, no practical bearing upon the subject, as to whether this remarkable difference in the behavior, according to preparation by one process or the other, of the two specimens of nitrate of zirconium was due to a hitherto undiscovered existence of two allotropic or isomeric forms of zirconium or to some other abstruse chemical or physical cause. The plaintiffs said again: "Let us have a sample of the chemicals you have been at work with and let us see whether there is any real mystery about it." With some difficulty, again, they got a sample to work upon, and using the ammonia method of purification (which is the only one that is said to point the way to failure) Mr. Ballantyne produced, without any difficulty, good mantles. He was put into the box again on Friday, 27th March, and detailed exactly what he had done. The only difference between his treatment and that of the defendants was that he had washed the precipitate produced by the ammonia, which the defendants had not done. The defendants themselves had found out that if this precipitate was washed or "even stood in the presence of water"—whatever that may mean; something, I suppose, less than actual washing—the process succeeded; so that the question was now reduced to whether Mr. Ballantyne had taken more precautions in the way of washing than would naturally be taken by a person possessed of the necessary chemical knowledge to make him "a fairly skilled workman" with respect to the preparation of nitrate of zirconium. Mr. Ballantyne—whom I entirely believe—not only said that he had never taken more than the ordinary precautions familiar in the laboratory for the preparation of nitrate of zirconium but gave excellent technical reasons, which I or any one else, though not a chemist, can perfectly understand, why such precautions are always adopted with respect to zirconia and some kindred substances. It turned out that he had used less than the amount of precaution which he would have used under other circumstances, because the evidence on behalf of the defendants, which really did look as if there might be a serious case against the patent, having been given on Monday morning (23rd March), he had been anxious, if possible, to conclude his experiments before the rising of the Court, and had therefore washed and filtered less than he ordinarily would have done.

Mr. Bousfield recurred, in cross-examination of Mr. Ballantyne, to the subject of allotropy, and of the physical causes which make the difference between washing and not washing of importance. To me they seem utterly irrelevant. It may be that "standing in presence of water," and still more washing, produces a change of condition and gives an allotropic variety of nitrate of zirconium which is useful where the other variety is useless, or it may be, as Mr. Ballantyne inclines to think, simply that zirconium and its salts belong to a class of substances long known to be specially liable to impurity, and which,

therefore, a reasonable chemist would wash carefully before he used them. Whatever the reason, I am satisfied with Mr. Ballantyne's evidence, that careful washing is the ordinary treatment, and that he has found no difficulty with a washing even less thorough than would be ordinarily applied, and that the defendants' difficulties are due to the fact that they did not reasonably cleanse the precipitate. I wish to add that Mr. Ballantyne has given me reason to rely upon him. He is one of the most truthful and fairest-minded men I have seen in the witness box.

On Monday, 30th March, when the evidence in the second case was still going on, Mr. Bousfield returned to the charge. On the previous Thursday Dr. Hehner had procured a fresh sample of nitrate of zirconia from a German manufacturer named Mirck, with whose nitrate of zirconium he had had the least difficulty. This, he said, he had tested. It was substantially pure, and yet he could not make mantles with it. I do not wish to repeat what I have said as to the use of an article now become a commercial product, made on a large scale, as a test for the sufficiency of a specification which could be exposed to no such risks as may be incident to the production of an article of commerce—a totally different thing from its preparation in minute quantities for laboratory experiments. But there is a circumstance connected with this matter which justifies, I think, my refusal to act upon this evidence, or to submit it to further experiment by the plaintiffs. Some communication had passed, it appears, on the Thursday between leading counsel, by which Mr. Moulton knew from Mr. Bousfield that some evidence of this kind would be given. Mr. Moulton, therefore, on the Friday took occasion to say that if there were any further attack to be made with respect to ammoniation he trusted they might have a sample of anything with which the defendants could not make a mantle, and he would undertake to make one, and to explain what the difficulty was. Obviously it ought to have been given, but Mr. Bousfield would give no sample then; and none was given either then or afterwards. It turned out on the Monday (30th) that the incriminated nitrate of zirconium was in court, when Mr. Bousfield raised difficulties about then giving a sample, in quantities abundantly sufficient for a host of experiments, and that Dr. Hehner was only prevented from handing it to the other side by Mr. Bousfield himself. There has been, indeed, a marked difference throughout the case between the perfect readiness of the plaintiffs to hand over to the defendants samples of anything in their possession which had been the subject of evidence and the reluctance exhibited on the part of the defendants to do the like by their opponents where the commonest fair play seemed to me to require the delivery of a sample. I cannot persuade myself to entertain a serious doubt that if the opportunity had been offered to the plaintiffs' chemists they would have disposed of this difficulty as satisfactorily as they have dealt with every other element of this attack upon the patent.

This ground of objection to the validity of the patent, therefore, in my opinion, completely fails. It has occupied in the aggregate, the equivalent of at least two or three days and the matters involved have

been so completely thrashed out that I should hope this inquiry may at any rate set that matter at rest.

3. Then the next ground of attack is that the proportions of the oxides given are wrong, and no directions are given as to the strength of the solutions, and that a competent workman would need other and further directions.

The subject-matter of the specification is such that no one but a person possessing a very considerable amount of chemical knowledge could, at the date of the specification, be considered a competent workman. The proportions actually given are right, and work satisfactorily. The hoods can be produced and made coherent with solutions very widely differing in strength, and I am satisfied with and accept the evidence of the plaintiffs' witnesses, who say that the want of a direction as to the strength of the solutions would have presented to a man competent to do this class of work no real difficulty. Excellent hoods were made by persons at the time unacquainted with anything but the Welsbach specification, and who received no other information than that contained in the specification—made at once, without further experiments and with no failures; and it was not suggested that Mr. Ballantyne and Mr. Cooper, good chemists, no doubt, were not fair types of the "skilled workman," as applied to the subject-matter in hand. Many questions were put to the defendants' witnesses as to whether one set of proportions and one strength of solution would not produce a better result than another. Except with regard to the ammoniation, with which I have already dealt, no one has said that he has found any difficulty in making an effective mantle satisfying the conditions to be attained for want of more specific directions. Sir Henry Roscoe, of whose evidence I desire to speak with the utmost respect, said that the proportions and strength of solutions were matters of importance, as no doubt they were, but he did not say that he or any one else had failed by reason of vagueness in these respects in the specification.

4. An objection is raised on the pleadings that the specification does not sufficiently distinguish between what is old and what is new in the invention. As, however, not a word has been said about it in the course of the case, I need not say any more than that, in my opinion, in such a specification as the one I am dealing with no such distinction is necessary.

#### THE INFRINGEMENT.

I pass now to the only remaining question, the very important one of infringement as threatened by the defendants.

The defendants have very plainly stated what it is that they say they intend to do. In answer to the fourth interrogatory it is said that the defendants intend to construct and sell in this country plumes for incandescent lamps in the manner referred to in paragraphs 2 and 12 of the affidavit of De Mare and Franchet, sworn on the 28th May, 1895.

In paragraph 2 of the affidavit, De Mare describes his system by reference to two patents taken out by him in 1894 and 1895, and an application of 11th April, 1895. The application of April, 1895, is the only material document. It describes the plumes somewhat imperfectly,



but as specimens were given by the defendants to the plaintiffs in the course of this litigation, and as one was made an exhibit at the trial, there is no doubt as to what was intended. A plume consists of a number of threads tied on to a platinum wire, and arranged so as to form a sort of fringe, all the threads of which are brought very closely together while they are strung on to the wire, but allowed to separate as they leave it, so that the apparatus looks like a housemaid's small hand brush, the cross section of which would take the shape of a fan. This plume is then to be dipped into a solution consisting, preferably, of one part of sulphate of magnesium, two parts of sulphate of erbium, and two parts of sulphate of zirconium (all chemically pure) in twenty-five parts of water; that is so far as the salts are concerned, sulphate of magnesium 20 per cent., sulphate of erbium 40 per cent., sulphate of zirconium 40 per cent. The plume may be dipped into collodion or varnish for the sake of strength, and is then to be suspended in the flame of a gas-burner to produce incandescence. In paragraph 12, Franchet, the other deponent, sets forth the solution employed by him in manufacturing a certain set of six plumes, five of which are mentioned in the plaintiffs' particulars of objection as having been handed to the plaintiffs on 25th April, 1895, by one Edward Robotham, and as types of the contemplated infringements. Franchet says he used for these plumes:—

Nitrate of zirconium about	50	per cent.
Nitrate of erbium	30	"
Sulphate of magnesium about	10	"
Sulphate of bismuth about	5	"

I have no means of translating the percentages of sulphates into nitrates or *vice versa*, but as they are referred to in the answer to the fourth interrogatory as if they were the same, and it has not been suggested that there is any material difference between the two formulæ, I must assume that they are substantially alike. The small percentage of sulphate of bismuth added by Franchet appears to have no sensible effect, except slightly to increase the strength of the plumes. It volatilizes on the application of heat, and is not material.

The evidence of infringement, or intended infringement, however, does not stop here. In October last the plaintiffs' solicitors applied to the defendants' solicitors for "some of the De Mare fringes, similar to the five supplied by Robotham to the plaintiffs," and on the 22nd October, 1895, the defendants' solicitors wrote to the plaintiffs' solicitors, quoting the above words of the letter of the plaintiffs' solicitors, and enclosing six more fringes prepared by Mr. Franchet. These six, therefore, were clearly delivered as specimens of what the defendants proposed to make. One of them has been analyzed by Mr. Ballantyne for the plaintiffs. He found it to consist of:—

Oxides of zirconium,	84	per cent.
Oxide of yttrium sub-group,	9	per cent.
Oxide of magnesium,	7	per cent.

The defendants' solicitors, at the same time that they sent six fringes to the plaintiffs' solicitors, sent four out of a batch of twelve, from

which the six sent to the plaintiffs' solicitors had been taken, and which they had procured from De Mare, in Paris, to their own chemist, Dr. Hehner, for analysis. He found them to consist of:—

Oxide of zirconium, 55 per cent.

Oxides of the yttrium sub-group (including erbium), 39 per cent.

Oxide of magnesium, 7 per cent.

The composition of the fringes delivered during the course of the action is not in itself any cause of action, but it is evidence of what the defendants were likely to do. With these varying compounds it is not easy to say exactly what the defendants meant to do, and I think it pretty clear that they were not very certain themselves. They clearly depended upon De Mare for their samples of plumes, for it appeared that it was to him that they resorted to get them. Mr. Bousfield said more than once that he was going to call De Mare. Possibly these analyses may explain why he did not do so.

Enough, however, appears to satisfy me that, unless the omission of the ammoniation, the omission of lanthania, and the variation in the form of the illuminant appliance prevent me from saying that the substance of Welsbach's patent has been taken, the defendants were about to infringe, and ought to be restrained.

Welsbach's limits of proportion are very large. Only one witness—for the defendants—attempted to put a definite figure to the "certain limits" within which the specification says the proportions may be varied. He said that a variation of from 25 per cent. to 30 per cent. upon the figures given would not be an unfair way of looking at it. No one has translated for me De Mare's sulphates or Franchet's nitrates and sulphates into the corresponding proportions of oxides, but so little has been said about there being any substantial difference that I should be disposed to infer that Dr. Hehner's analysis of four fringes probably gives something approaching to the true proportion of oxides. If so, the substantial difference between the two sets of prescriptions—those of the plaintiffs and those of the defendants—consists in the omission of the oxide of lanthanum. Of course, when the oxide of lanthanum was left out the proportions of the remaining substances must be altered in some way or other. No reason was given for the omission of lanthanum. The omission undoubtedly involves some loss of the light-giving power of the plume; and, generally, no advantage has been suggested as obtained by any variation there may be between Welsbach's and De Mare's proportions of the oxides or salts.

The non-ammoniation is very easily disposed of. Professor Crookes—a very great authority—called for the defendants, said that in his opinion ammoniation was not necessary to arrive at the result proposed by the patentee; and it appears that the only effect—apart from the danger attending ammoniation, which I have already discussed—of dropping the ammoniation is that when you expose to the gas-flame the fabric impregnated with nitrates, you drive off, in the shape of nitrous acid, the nitrogen and the greater part of the oxygen, leaving one equivalent of oxygen which combines with the metallic bases and produces an anhydrous oxide or anhydrous oxides, so that you get at

the same result by one step as you get at by two steps if you ammoniated the fabric. This is strictly the use of a chemical equivalent perfectly well known at the date of the patent, and can have no bearing upon the question of infringement.

The "plume" is no doubt a form of appliance suited to a batswing burner, to which the Welsbach cap or hood would be inapplicable. Welsbach, however, points out that the form and construction of the fabric may be varied to suit different burners. It is urged that the plume is not a fabric at all. I do not know why not. It consists, not of a single thread, but of a number of threads mechanically held together by a wire, and I think by another thread. Why is not a plume a "fabric"? The essential part of it for the present purpose is the agglomeration of threads. The defendants say that nothing but a textile fabric is a fabric. I can see no reason for putting such a limitation upon the word.

Before I go further, I wish to discuss the principles which appear to me to be applicable to the question of infringement. In dealing with the question of construction I have carefully avoided any reference to the relative importance of different parts of the invention. In dealing with the question of infringement it is impossible not to consider them. Infringement is a question of fact for the jury, if there be one, and the question is not whether the substantial part of the process said to be an infringement has been taken from the specification, but the very different one whether what is done, or proposed to be done, takes from the patentee the substance of his invention. A process might be wholly gathered from a specification, and nowhere else, and yet be no infringement, if it did not take substantially the thing invented. What the thing invented is must be gathered from the specification alone, and the patentee cannot escape from the thing he has claimed as the standard, and the only standard, with which to compare the alleged infringement, so as to see if it constitutes substantially the appropriation of the thing claimed.

When, however, you come to make that comparison, how can you escape from considering the relative magnitude and value of the things taken, and of those left or varied? It is seldom that the infringer does the thing, the whole thing, and nothing but the thing claimed by the specification. He always varies, adds, omits; and the only protection the patentee has in such a case lies, as has been often pointed out by every tribunal, from the House of Lords downwards, in the good sense of the tribunal which has to decide whether the substance of the invention has been pirated.

It is contended by the defendants that what is important and what is of subsidiary consequence can only be gathered from the specification itself. I am satisfied that that neither is nor can be the law. Certainly *Dudgeon v. Thomson* (3 App. Cas. 34), which was cited as an authority to that effect, says nothing of the kind. "Additions or subtractions," says Lord Cairns, "may exist, and yet the thing protected by the specification may be taken notwithstanding." There is no means of ascertaining whether, notwithstanding additions or subtractions, the invention has been taken, except by seeing what they are worth as compared with the things which have been taken bodily from the

invention. In the case of a patent for a combination, or for a series of operations, the specification very often contains no clue to the inventor's own view of the relative importance of the different elements in the combination. If he says nothing on the subject, you must conclude that, as far as the specification goes, they are all presented as of equal importance, and all as essential parts of the combined whole, and yet there may be infringement notwithstanding "slight variations." (Cotton L. J., in *Proctor v. Bennis*, 36 Chancery Division 740-754.) So again, says Cotton L. J., at p. 756, "omissions and additions may be very material in considering whether, in fact, the machine of the defendant is an infringement of the combination which the plaintiff claims." Omissions and additions may even be improvements, but that fact "does not enable you," says Bowen, L. J., "to take the substance or the plaintiffs' patent." "If the instrument patented," says Lord Cairns, "consisted of twelve different steps, producing in the result the improved clipper, an infringer who had taken eight, nine, or ten of those steps might be held by the tribunal judging of the patent to have taken the substance, the pith and marrow of the invention, although there were one, two, three, four, or five steps which he might not actually have taken." (*Clark v. Adie*, 2 App. Cas. 315,320.) In such a case, as far as the specification went, the patentee would, under ordinary circumstances, treat the whole of the twelve steps as essential parts of his combination, and, so far as the specification went, there would be nothing to indicate that any one of them was not indispensable, or was of less importance than the others. In *Proctor v. Bennis* there was nothing to indicate that the patentee thought the parts of his combination omitted or varied by the defendant of anything but cardinal importance. How was the question suggested by Cotton, L. J., whether the variations were "slight," to be ascertained except by evidence as to the relative importance of the variations in question as compared with the patented combination as a whole? "There is, or may be," says Lord Justice James and Lord Justice Mellish, "an essence of substance of the invention underlying the mere accident of form, and that invention, like every other invention, may be pirated by a theft in a disguised or mutilated form, and it will be in every case a question of fact whether the alleged piracy is the same in substance and effect, or is a substantially new or different combination." (*Clark v. Adie*, 10 Ch. App. 667, 675.) Drop the word "combination," which is perfectly immaterial as regards the principle, and every word is applicable to the present case. Mr. Bousfield says I am not entitled to take this as an accurate statement of the law, as the case went to the House of Lords, and no such doctrine is, as he contends, enunciated by the Law Lords. This, however, is a mistake. Lord Cairns expressly says: "I am quite satisfied with the judgment of the learned Lords Justices, and I should have been content to rest the decision of this case upon that judgment," but for its importance. (2 App. Cas., p. 326.)

There can be no doubt of the importance attached by Welsbach to the use of the oxide of lanthanum, which he clearly regards as a thing not to be omitted from what he claims, and he, therefore, enters upon the contest as to infringement heavily handicapped, as it were, by his

own view of the great importance of the use of lanthania in his prescription; but, for the reasons I have already given, I think the fact has no further weight, and leaves me free to exercise my own judgment in weighing this fact with others when dealing with the question of infringement. If the patent consisted of the mere prescription, the omission of lanthania and the variations of the proportions would, of course, prevent the defendants from being treated as infringers. But this is not a patent of that description. The claim is far wider, and the patentee is, accordingly, entitled to a larger measure of protection. "It goes to the very root of the case," says Lord Justice Bowen, speaking of infringement, "to remember that this is, as it was described by one of the counsel, a pioneer invention, and it is by the light of that, as it seems to me, that we ought to consider the question whether there have been variations or omissions and additions which prevent the machine complained of from being an infringement of the plaintiffs." (*Proctor v. Bennis*, 36 Chancery Division 740, 764). I think, in substance, this is the same thing as saying that if the specification shows that a result which is in fact new is attained by the combination described, and the claim extends to the process by which that result is arrived at, the substance which is to be regarded on a question of infringement is of a very different character from what it is when the result is an old one and a known one, in which case the claim, if a good one, must be limited to the very combination patented.

Now, what was the character of Welsbach's invention so far as result is concerned? It was undoubtedly a perfectly new result, and in every respect deserving the name of a "pioneer" invention. The phrase is not mine, but Lord Justice Bowen's. I use it only as a compendious way of repeating what I have already said; and the substance of what Lord Justice Bowen said is expressed in other words by both Lord Justice Cotton and Lord Justice Fry. Welsbach certainly discovered, for the first time, a method by which a skeleton, frail but durable, of the resistant earthy oxides mentioned by him could be obtained which would give practically a means of obtaining light by incandescence, which would surpass the economy of the best modes known of getting illumination from gas. His specification claims the whole process by which he arrived at that result. Out of it the defendants take the impregnation of the fabric by blends of salts of zirconium, and of the rare earths, and the reduction of these to anhydrous oxides, forming the simulacrum of the fabric. I am satisfied, by the evidence, that it is this mode of getting blends of the specified oxides into the shape of the fabric out of which the hood has been made that has rendered the process of any use, and that a mere variation of prescription, extending even to the omission of lanthania, is of very trifling consequence in comparison. Mr. Bousfield's contention comes shortly to this, that looking to the variations in the prescription, and especially to the omission of lanthania, if I were trying this case with a jury, it would be a miscarriage if I left the question of infringement to a jury, and that I should be bound to give judgment for the defendants. I am of opinion that the case would have to be left to the jury. If it be left to me as a jury, I have no hesitation at all in finding that the defendants propose to take the substance of the Welsbach process.

I prefer the expression "substance" to "pith and marrow," even though that phrase was used by Lord Cairns. I have had some difficulty in preventing myself from misapplying it, and I think it would be very likely to mislead a jury. Pith is a great deal less than the substance of the vegetable structure of which it is part, and marrow a great deal less than the substance of the animal structure of which it is part. Metaphors are very apt to mislead, as they are seldom close enough to the things to which they are applied. It has been urged upon me that the patent cannot have been infringed, because chemical patents cover only such chemical equivalents as were known at the date of the patent to be equivalents, and inasmuch as it was not known that a like result might be obtained by the omission, as by the use, of lanthania in the blend, there can be no infringement by a process which drops lanthania, and *Heath v. Unwin* (5 House of Lords Cases, p. 505) was pressed upon me over and over again, as well as a passage with regard to mechanical equivalents in the *Ticket Punch Register Company v. Colley's Patents* (12 Patent Cas. pp. 171, 185). *Heath v. Unwin*, in my opinion, has no application at all. There the patent was not for a combination of a long series of steps, but for one simple and single chemical operation, which it was held was not imitated by a process of a very different kind, which resulted in producing the same effect. The result attained was not new. The carbonization or decarbonization, as the case may be, of iron is the essential condition of making steel, and *Heath's* patent covered only a new mode of effecting that result. It has no analogy with such a patent as the present, in which the use of the blend containing the oxide of lanthanum is a mere element of a large combination. To apply it would reduce the patent owned by the plaintiffs to one for a mere formula, which is really what most of Mr. Bousfield's arguments have come round to. So in the ticket punch case the remarks of Lord Justice Smith as to the decision in *Proctor v. Bennis*, however applicable in the circumstances of that case, have really no bearing upon the present case, in which it is only in respect of one very subordinate matter in a long chain of operations that any question of chemical equivalents can arise.

The substance of Welsbach's invention as described in his specification, according to the construction which I have put upon it, is, in my opinion, appropriated by what the defendants were proposing to do, and I therefore give judgment against all the defendants upon all the issues, with costs, and grant the injunction prayed for; and I certify, pursuant to Section 31 of the Patents and Trade Marks Act, 1883, that upon the trial of this action the validity of the letters patent granted to Carl Auer von Welsbach, No. 15,286, dated the 12th December 1885, came in to question; and I further certify, pursuant to Section 29 of the same Act, that on the trial of this action the plaintiffs proved the particulars of breaches delivered by them.

The shorthand notes of the evidence, costly as they must be, have greatly abridged the length of the trial, and have been a saving of expense, and the notes and printed transcripts must, therefore, be allowed.

Mr. Roger Wallace applied that the costs should not be as between solicitor and client, but Mr. Justice Wills said he would not interfere.

as the attack upon the patent had been carried on in a spirit that he had very seldom seen equalled.

#### THE SUNLIGHT JUDGMENT.

In this case the plaintiffs complain of infringement and threatened infringement in respect of the patent of 1885, to which the De Mare case relates, and also of one granted to Oliver Imray, being 3,592 of 1886, and one granted to Ludwig Haltinger, being 586 of 1891. As, however, the grounds of action in respect of the latter two patents were abandoned during the hearing I have nothing to add to the judgment just delivered in the De Mare case, so far as relates to construction and validity of Welsbach's patent, and have to deal only with the question of infringement. The defendant company was formed to work a patent granted to one Dellwik, being No. 2,110 of 1890, for improvements in the process of treating incandescents for use with gas lamps or burners. Dellwik's patent does not impress me favorably. It is full of what, after Sir Henry Roscoe's evidence, I am fully justified in calling nonsense about the conduction of heat and the selection of substances because of their conducting power; and I doubt if this rubbish was put in for any other purpose than to try and make it look unlike Welsbach's process. The fact, however, that the patentee was trying, by means not creditable, to escape a danger will not make the process an infringement of Welsbach's patent, if it is not so in fact. It is extremely difficult to say what Dellwik really describes. He says he takes "the ordinary incandescent" and treats it by such and such means. If under the "ordinary incandescent" he includes the incandescent fabric of Welsbach produced under his patent, the defendants could not, of course, make such a fabric, and then subject it to his process, without infringing Welsbach's patent. But as that would be, not to gild refined gold, but to coat it with brass, I do not suppose there is any danger of that being done, nor has it been suggested that it will be done. Dellwik confines his claim, so far as now material, to (1) the treatment of incandescents, such as the oxides of calcium, magnesium, aluminium, zirconium, or similar metals of this group, or compounds of these oxides, by covering or saturating them with a coating of refractory oxide of a heavy metal or metals. (2) The treatment of incandescents, being similar oxides, by covering or saturating them with a coating of a more refractory oxide, such as the oxide of chromium, yttrium, lanthanum, didymium, and the like. (3) The like coating the incandescents with oxides of heavy metals mixed with the oxides last mentioned, and some others.

Here, again, there is at least a suspicion of a not very honest specification. To coat the fabric with oxide of didymium would, it seems, be fatal to its light-giving powers. It is perhaps better to see what the defendants are really doing, for it is not suggested that what they are actually doing is not an honest specimen of the work they intend to carry on.

They take the idea of the skeleton hood produced by the Welsbach process, but make it of about 50 to 60 per cent. of alumina, about 30 per cent. of zirconia, and then coat this with a thin coating of oxide of chromium. They used to add a small percentage of a secret sub-

stance, but have found that they do not need it, and are not now using it. I have seen what it is—the name having been deposited in a sealed envelope—and do not think it affects the case in any way.

It seems to me that this is essentially different from what is claimed by the Welsbach specification. Mr. Moulton and Mr. Terrell have both put the matter very plainly and very fairly before me, and admit that they have no case unless the Welsbach skeleton—*i. e.*, the fabric of earthy oxide got by impregnation with a salt and by the action of flame, of whatever resistant earthy oxides composed—is within the Welsbach patent. Mr. Terrell says the consequences of an adverse decision on this point are very grave. I am very sorry if they are so, but I cannot help it. It seems to me that this is just what Welsbach did not claim. He might, of course, have claimed the hood made of any materials. But that would have entirely altered his patent, and would have exposed it to a fresh set of dangers which I cannot estimate, but which were no doubt present to his mind and to that of his experienced patent agent, Mr. Imray. He might have claimed the hood, of whatever materials, applied for purposes of illumination. But that again would have altered his patent. In that form it would have been, as Mr. Swinburne put it, with that perfect frankness, truth, and indifference to consequences which marked every answer that he gave, and made him the perfect ideal of what a scientific witness should be, a patent for the use in the form of a hood of whatever substance would answer, which would have made his patent not worth the paper upon which it was printed. But he did claim nothing of this kind, and seeing the manner in which he moulded his illuminants into shape—*viz.*, by a chemical process of reduction from salts, and not by coating, it was absolutely necessary that he should select his substances from those which he had ascertained would give suitable illumination in the end; and the use of the rare earths is beyond all doubt, for this reason, of the essence of his invention. He could not by any adaptation of his process make a strong groundwork of alumina or alumina and zirconia, and then spray it or saturate it with the salt of an illuminant oxide, to be reduced to the oxide on putting it into the flame, which is what the defendants have done. It was a necessary consequence of the nature of Welsbach's process that his skeleton should be absolutely homogeneous throughout. Take a fragment out of the structure from the back or the front, or sides, from the rind or the core, it must be the same in composition. Hence the whole fabric was a compromise between strength and illuminating power, except in a detail so unimportant that I have not thought it worth while to notice it: he could make no use of the great strength and tenacity of alumina, because it has practically no illuminating power. The Sunlight process uses alumina very largely indeed. It makes a hood which is a mixture, homogeneous throughout, of alumina and zirconia, and so gets greatly increased strength for the hood, with moderate illuminating power introduced by the zirconia. The idea of this part of the process is, no doubt, taken from the Welsbach patent. But the addition of a thin coating of oxide of chromium is what gives the illumination, and in this instance the substantial illuminant is not that portion of a homogeneous mantle which is exposed to the flame, but a foreign substance



laid on in a thin film, and quite absent from the bulk of the structure. It is true you get much less light than by the Welsbach process. For many purposes, probably, that is no disadvantage; and you get a yellowish instead of an absolutely white light, which also, in the opinion of many people, is no disadvantage. With the relative merits of the resulting mantles, however, I have nothing to do.

Lord Halsbury said, in the ticket punch case, that he gave his judgment with reluctance. In one sense I may use the same phrase, for I do not think Mr. Moulton has exaggerated the value to the world of Welsbach's idea, or reduction to practice of the idea—whichever way it may be put—of getting a coherent skeleton of earthy oxides, and I feel that the defendants—and I doubt not that others have done the same—are taking a very valuable process bodily from Welsbach without any remuneration. But that is the necessary fate of a patentee who does not, or cannot, claim separately that which may be, in fact, the most ingenious and meritorious part of his invention, and who confines himself to claiming the aggregate of a whole string of processes of which this is one. The construction of the skeleton is none the less ingenious and meritorious because it seems so simple when put into practice. Columbus' performance with the egg, to which I referred in the De Mare case, was very simple when it was once done. But, as far as this case is concerned, the fatal difficulty is that the formation of a Welsbach skeleton by other means and of other substances than those pointed out in the specification or by means substantially identical and apart from the contemporaneous formation of the illuminants, is not claimed. If it were, or if there was infringement in the mere construction of a Welsbach skeleton out of the materials used by the defendants, I should, of course, agree with Mr. Moulton that the addition of a coating of oxide of chromium would not make it the less an infringement. But so to hold would, in my opinion, be practically to give to the specification a construction it cannot bear, and to turn into a patent for the skeleton, no matter of what materials composed.

No use is made by the defendants of any of the rare earths, and their choice of substances and their method of applying the illuminants appear to me to be as wide asunder as the poles from those contemplated by Welsbach.

This case affords, to my mind, an interesting illustration of the criticism I ventured to make in the De Mare case upon the phrase which has been used as to taking the pith and marrow of an invention. It seems to me that in this case that is precisely what the defendants have done; and yet they have not taken its substance or anything like it.

I must, therefore, give judgment for the defendants upon the issue of infringement. In respect of the issue of the validity of the patent of 1885, I find for the plaintiffs, and I certify that the validity of the patent has been in issue.

[THE END.]

