

TECHNICAL GAS AND FUEL ANALYSIS

BY

ALFRED H. WHITE

PROFESSOR OF CHEMICAL ENGINEERING, UNIVERSITY OF MICHIGAN

SECOND EDITION
REVISED AND ENLARGED
SIXTH IMPRESSION

McGRAW-HILL BOOK COMPANY, Inc.
NEW YORK AND LONDON
1920

East Engineering

TP

321

.V15827

1920

cop. 4

COPYRIGHT, 1913, 1920, BY THE
MCGRAW-HILL BOOK COMPANY, INC.

PRINTED IN THE UNITED STATES OF AMERICA

THE MAPLE PRESS - YORK PA

E. Engin.
Engin.
Barham
7. 1. 54
87140
add. cop.

PREFACE TO SECOND EDITION

The years intervening since the appearance of the first edition have seen a distinct increase in our knowledge of the subjects covered in this book. Standard Methods for Sampling and Analysis of Coal and Coke and also for Examination of Liquid Fuels have been studied and approved by several technical societies. Methods for analysis of gases have been critically studied and new technique developed by the staffs of various organizations, notably the Bureau of Mines and the Bureau of Standards, and by a number of individual workers. The literature has been carefully reviewed for this edition and the inclusion of new material has increased the size of the book about twenty per cent. No attempt has been made to describe all of the new methods nor to illustrate all of the various forms of apparatus now on the market. On the contrary the effort has been to illustrate types and to indicate essential features. Criticism has been solicited from teachers who have used the book as a text and the needs of students have been kept in mind, but the intention has also been to make the book one which would supply the practicing engineer and chemist with the most necessary information.

ANN ARBOR, MICHIGAN,
May, 1920.



PREFACE TO FIRST EDITION

With the increased demand for the economic utilization of fuels has come an increased necessity for accuracy in testing both the raw fuel and the manner of its utilization. Our knowledge has recently been greatly extended by the investigations conducted by the Committee on Calorimetry of the American Gas Institute, the International Photometric Commission, the Joint Committee on Coal Analysis of the American Chemical Society and the Society for Testing Materials, the Bureau of Mines and the Bureau of Standards.

The author has aimed to present the conclusions of these committees and also to indicate where there has been marked dissent from them. He desires to express his especial appreciation to Professor O. L. Kowalke of the University of Wisconsin for his courtesy in revising the chapter on Determination of Heating Value of Gas; to Professor S. W. Parr of the University of Illinois for suggestions on Calorimetry and Chemical Analysis of Coal; and to Dr. H. C. Dickinson of the Bureau of Standards for his suggestions on Calorimetry.

ANN ARBOR, MICHIGAN,
August, 1913.

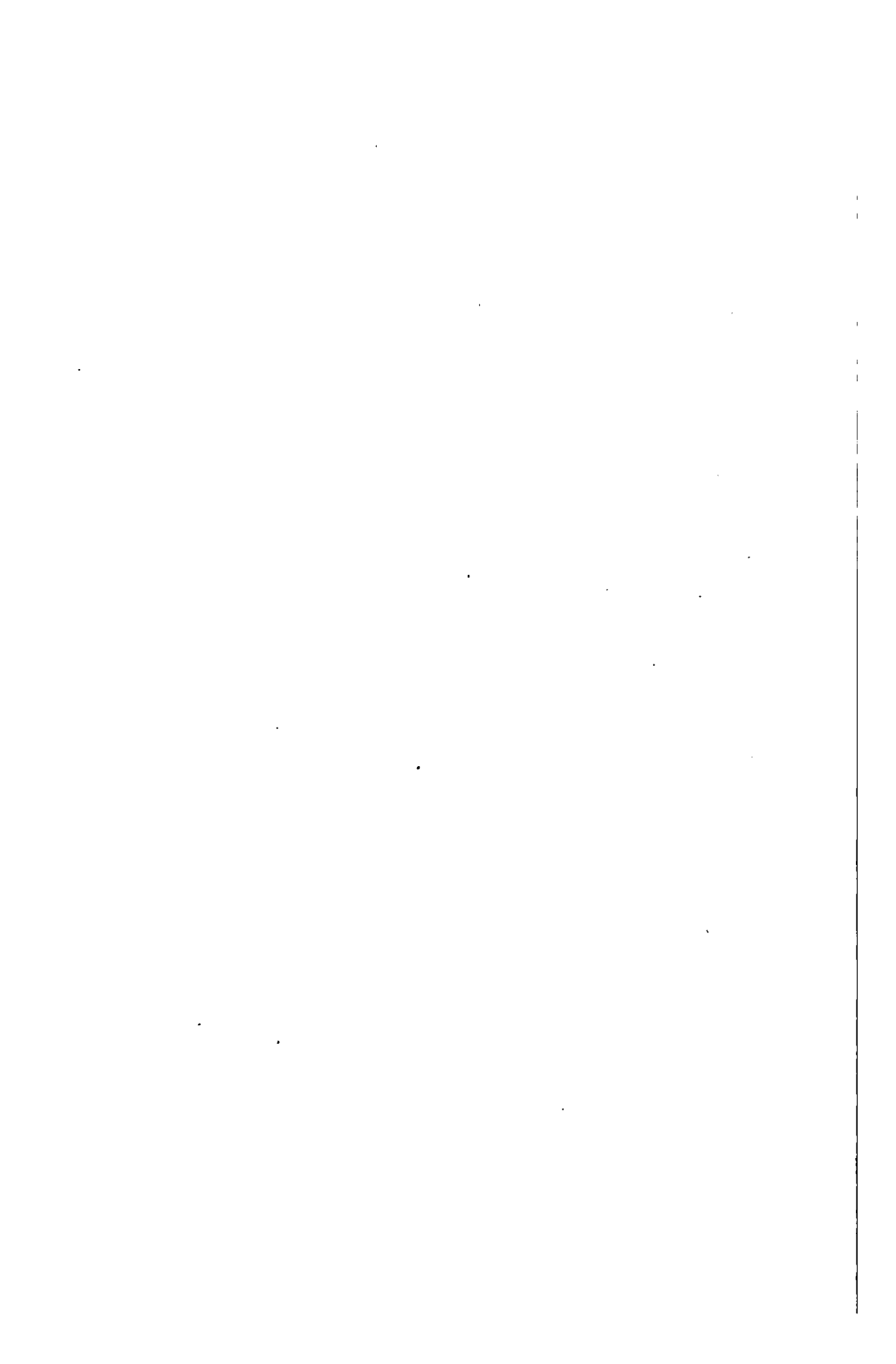

CONTENTS

	PAGE
PREFACE	v

CHAPTER I

SAMPLING AND STORAGE OF GASES	1
Difficulties involved—The problem of a fair sample—Materials for sampling tubes—Types of sampling tubes and their use—Aspirators—Solubility of gases in water—Saturating water in sampling tanks—Collecting an average sample representative of a definite period—Collecting a representative instantaneous sample—Storing gas samples.	

CHAPTER II

GENERAL METHODS OF TECHNICAL GAS ANALYSIS	14
Introduction—General method—The gas burette—Care of stop-cock—Saturating the water of the burette—Drawing the sample of gas into the burette—Measuring a gas volume—Calibration of a gas burette—Gas pipettes—Connecting the burette and pipette—Details of a simple gas analysis—Accuracy of the analysis.	

CHAPTER III

ABSORPTION METHODS FOR CARBON DIOXIDE, UNSATURATED HYDROCARBONS, OXYGEN, CARBON MONOXIDE AND HYDROGEN	28
Carbon dioxide—Unsaturated hydrocarbons—Oxygen by phosphorus—Oxygen by alkaline pyrogallate or hydrosulphite—Oxygen by ammoniacal copper solution—Carbon monoxide—Absorption of hydrogen—General scheme of analysis.	

CHAPTER IV

EXPLOSION AND COMBUSTION METHODS FOR HYDROGEN, METHANE, ETHANE AND CARBON MONOXIDE	43
Available methods—Apparatus for explosion analysis—Manipulation in explosion analysis—Oxidation of nitrogen as a source of error—Accuracy of explosion methods—Hydrogen by explosion—	

Hydrogen and methane by explosion—Carbon monoxide, hydrogen and methane by explosion—Quiet combustion of a mixture of oxygen and combustible gas—Fractional combustion with palladinised asbestos—Fractional combustion with copper oxide—Detection of minute quantities of combustible gas—Oxygen by explosion or combustion—Nitrogen—Form of record of gas analysis.

CHAPTER V

VARIOUS TYPES OF APPARATUS FOR TECHNICAL GAS ANALYSIS. . .	64
Introduction—Schlösing and Rolland's apparatus—Orsat's apparatus—Bunte's burette—Chollar tubes—Instruments for recording carbon dioxide in flue gases—Methods of gas analysis depending on thermal conductivity—Gas analysis by optical methods.	

CHAPTER VI

EXACT GAS ANALYSIS	74
Historical—General methods—Corrections for temperature and pressure—Description of gas burettes—The bulbed gas burette for exact analysis—Manipulation of gas burette for exact analysis—Calibration of burette—Absorption methods in exact gas analysis—Carbon dioxide—Unsaturated hydrocarbons—Oxygen—Carbon monoxide—Hydrogen—Methane—Errors in calculation of results of explosion and combustion—Nitrogen	

CHAPTER VII

HEATING VALUE OF GAS	92
Introduction—Continuous flow calorimeters—Wet gas meters—Corrections for temperature and pressure—Control of the water—Measurement of temperature—Measurement of mass of water—Description of calorimeter—Preliminaries of a test—Description of a test—Calculation of observed heating value—Total heating value—Net heating value—Calculation of total heating value—Accuracy of method—Determination of humidity of air—Non-continuous water heating calorimeters—Automatic and recording gas calorimeters—Calculation of heating value from chemical composition.	

CHAPTER VIII

CANDLE-POWER OF ILLUMINATING GAS	119
Introduction—Method of rating candle-power—The bar photometer—Standard light—Photometric units—Standard candles—	

The Hefner lamp—The Pentane lamp—Secondary standards of light—Standard gas burners—The Bunsen and Leeson photometric screens—The Lummer Brodhun photometric screen—The flicker photometer—The gas meter—The photometer bench and its equipment—Details of a test—Illustration of calculation—The photometer room—Jet photometers—Accuracy of photometric work.

CHAPTER IX

ESTIMATION OF SUSPENDED PARTICLES IN GAS	138
Introduction—The distribution of particles in the cross-section of a straight main—Mean velocity in the cross-section of a gas main—Influence of bends in a main—Velocity of gas in a sampling tube—The filtering medium—Estimation of suspended tar and water—Electrical precipitation of suspended particles	

CHAPTER X

CHIMNEY GASES	144
Introduction—Sampling—Formation of carbon dioxide—Effect of hydrogen of coal on composition of chimney gases—Carbon monoxide and products of incomplete combustion—Volume of air and of chimney gases—Loss of heat in chimney gases—Interpretation of analysis of chimney gases.	

CHAPTER XI

PRODUCER GAS	156
Formation of producer gas—Sampling producer gas—Analysis of producer gas—Interpretation of analysis—Heating value of producer gas—Volume of producer gas—Efficiency of a gas producer.	

CHAPTER XII

ILLUMINATING GAS AND NATURAL GAS	163
Introduction—Sampling—General scheme of analysis—Chemical composition of illuminating gas—Benzene—Benzene and light oils by differential pressure method—Hydrogen sulphide—Total sulphur compounds—Naphthalene—Ammonia—Cyanogen—Specific gravity—Natural gas—Gasoline in natural gas.	

CHAPTER XIII

LIQUID FUELS	187
Introduction—Sampling—Heating value—Specific gravity—Mois-	

ture—Proximate analysis—Suspended solids—Flash point—Gasoline—Specifications for motor gasoline—Kerosene—Fuel oil.

CHAPTER XIV

SAMPLING COAL	204
General consideration—Difference in composition of lump and fine coal—A scoopful as a sample—Influence of lumps of slate—Taking a sample—Mine sampling—Preparation of sample—Preservation of sample—Usual accuracy of sampling—Standard methods of sampling—Sampling coke—Reliability of samples.	

CHAPTER XV

THE CHEMICAL ANALYSIS OF COAL	222
Introduction—Proximate analysis—Preliminary examination of sample—Air-drying—Grinding and preserving the sample for analysis—Moisture—Volatile matter—Ash—Fixed carbon—Sulphur—Ultimate analysis—Carbon and hydrogen—Nitrogen—Phosphorus—Oxygen—Methods of reporting analyses—Accuracy of results—Slate and pyrites—Standard methods for the laboratory sampling and analysis of coal—Standard methods for the laboratory sampling and analysis of coke.	

CHAPTER XVI

HEATING VALUE OF COAL BY THE BOMB CALORIMETER	258
General methods of determining heating value—The calorimetric bomb—Details of the calorimetric bomb—Thermometers—Preparation of sample—Manipulation of bomb calorimeter—Thermometer corrections—Radiation corrections—Corrections for oxidation of nitrogen—Corrections due to oxidation of sulphur—Correction due to combustion of iron wire—Reduction to constant pressure—Water value of calorimeter—Adiabatic calorimeter—Precision calorimetry—Accuracy of results—Total and net heating values.	

CHAPTER XVII

HEATING VALUE OF COAL BY THE PARR CALORIMETER AND OTHER METHODS	282
Introduction—Combustion in a stream of oxygen—The Thompson calorimeter—The Parr calorimeter—Preparation of Parr calorimeter—Care of sodium peroxide—Operation of Parr calorimeter—	

CONTENTS

PAGE

Corrections to be applied with Parr calorimeter—Accuracy of Parr calorimeter—Calculation of heating value from chemical analysis.

APPENDIX 290

Saturation pressure of water vapor—Reduction of gas volumes—Factors for reduction of gas volumes—Relative humidity—Corrections to be applied to observed heating values of illuminating gas and natural gas—Emergent stem corrections for calorimeter thermometers—Corrections for difference between inlet water temperature and room temperature when determining heating value of gases—Table for constants of certain gases and vapors—Mean specific heats of gases—Volume of water vapors taken up by one cubic foot of air—Baumé scale for liquids lighter than water.

INDEX 305

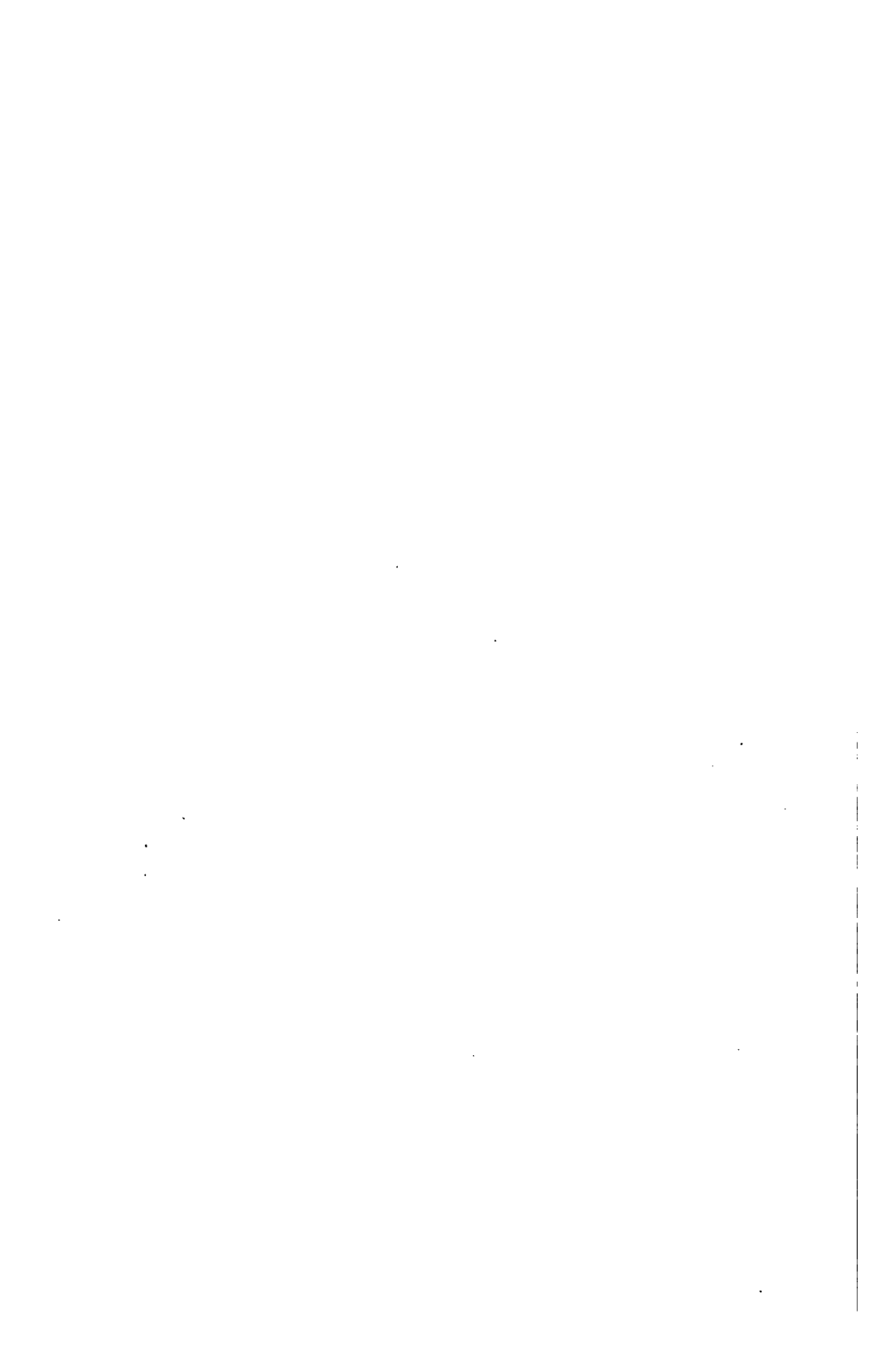

TECHNICAL GAS AND FUEL ANALYSIS

CHAPTER I

SAMPLING AND STORAGE OF GASES

1. Difficulties Involved.—The problem of obtaining a representative sample of a gas for analysis presents in many cases more difficulties than the analysis itself. If the gas flowing through a main were of perfectly uniform composition throughout its cross-section and also throughout its length the problem would simplify itself to the introduction of a tube through which a portion of gas might be removed for analysis. The proposition becomes at once more complicated when it is necessary to sample gases which have not passed through any adequate mixing chamber and which usually travel through the main or flue in pulsations of widely varying composition. Ocular evidence of this condition is afforded by a glance at the average smoke stack with its pulsing billows of smoke. If it is desired to determine not only the composition of the fixed gases but also the amounts of suspended solids, tar particles, water globules, etc., the problem becomes one of great complexity, capable frequently of only partial solution. This question is discussed separately in Chapter IX.

2. The Problem of a Fair Sample.—Gases should be sampled as close as possible to the point of the reactions which are to be studied, thus minimizing errors due to leakage of air or gas, deposition of solids or secondary reactions. Gases travel through straight pipes in an irregular succession of waves of rather a spiral form, the velocity being greatest at the center of the pipe and least next to the walls. The shape of the wave is altered by every bend, branch or other change in the pipe and the point of maximum velocity is also shifted. The temperature of gases from hot furnaces also varies throughout the cross-section of the

conducting pipe, being usually hottest where the velocity is greatest and coldest next to the walls and in dead bends.

It is in general advisable to sample from a point of approximately average velocity and temperature, but it is not possible to find a single point from which a truly representative instantaneous sample can be drawn. It is necessary to extend the sampling period over a time which will on the theory of probabilities allow so great a series of gas waves to pass the sampling tube that the resulting sample will be truly representative. A small volume of gas can therefore only be considered a representative sample when it has been drawn from a practically homogeneous mass of gas—a condition which is rather closely fulfilled in illuminating gas which has been purified and further made uniform through mixing and diffusion in a large gas holder. The condition is not fulfilled in producer or chimney gases.

No fixed time can be set as the most desirable for a single gas sample. If the sample is being taken from chimney gases which are supposed to be the same from one hour to another, the sampling process may very well extend over one hour or six hours. The longer the period the more nearly will the sample be an average one. The same thing holds true for illuminating gas coming from a holder, but it would not hold true for producer gas from a single producer nor for illuminating gas from a single retort, for these gases vary continuously in composition, each fresh charge of coal commencing a new cycle. When dealing with gases of this sort it is necessary to start and stop the sampling with reference to some definite point in the cycle. A truly proportional sample of a constantly varying gas cannot be obtained without rather elaborate precautions.

3. Materials for Sampling Tubes.—Sampling tubes must be of a material which will not react with the gases and change their chemical composition. Iron, and in general metals, cannot be used at high temperatures. Iron reacts with carbon dioxide quite rapidly at 200° C., producing carbon monoxide and oxide of iron. It also reacts readily with oxygen. An oxidized pipe will react with hydrogen causing that gas to disappear as water at equally low temperatures. Pipes with rough surface will induce a rapid catalytic decomposition of such gases as ammonia and some of the less stable hydrocarbons at a rather low red heat.

The best materials for sampling tubes are glass, quartz or porcelain. These tubes should be protected by a wrapping of asbestos in the form of paper or twine and should be slipped into an iron jacket which takes the strain off the tube and prevents sudden temperature changes. Glass begins to soften about 600° C. or 1100° F. and on long exposure to a red heat devitrifies and ultimately cracks spontaneously on cooling. Porcelain will stand about 1000° C., but at higher temperatures the glaze commences to soften. Unglazed porcelain will stand a higher temperature and special refractory mixtures may be obtained which will not soften at 1700° C., but such tubes are apt to be porous and should only be used if proved to be free from leaks. Fused quartz is in some respects admirable as a material for sampling tubes, since its coefficient of expansion is so small that it never cracks because of temperature changes. It will stand 1100° C. without softening but on long heating tends to become crystalline and brittle. The ordinary opaque electroquartz tubes are often porous and should be carefully tested for leaks before they are used.

4. Types of Sampling Tubes and Their Use.—The simplest form of sampling apparatus consists of a single tube through whose open end the gases are aspirated. When sampling from a large flue the sampling tube is sometimes closed at the end and perforated at various points along its length with the expectation that gas will be drawn uniformly through the holes at intervals across the flue. A device of this sort usually fails of its purpose and is often less efficient than a single tube. If the perforations are all of the same diameter they will allow the same amount of gas to pass through only in case the suction is the same on each. This condition can be attained in practice only by making the perforations small and the suction high so that it will be practically as great at the far as at the near end of the sampling tube. But such small holes stop quickly with dust and are not practicable.

A better device to secure a more uniform sample from the gases of a flue is shown in Fig. 1. It consists of a bundle of glass tubes of the same diameter but of varying lengths which are wired together and slipped into an iron pipe not quite so long as the shortest glass tube. The glass tubes are cemented into this with neat

Portland cement in such a manner that their ends next the threaded joint are all even and about 2 in. from the end of the iron tube. This may readily be accomplished in the following manner. Plug the threaded end of the iron pipe with a cork and stand it vertically on the corked end. Plug one end of each of the glass tubes with putty and stand them in the iron tube with their lower ends resting on the cork. Fill the iron tube for 3 in. with a paste of Portland cement and water and allow to stand for twelve hours to harden. The sampler is finished after removing the cork and putty by screwing onto the iron pipe a cap which is provided with a 1/4-in. nipple to which convenient connection may be made. The suction required to draw a slow stream of gas through a smooth tube 2 ft. long is only slightly more than that required for a 1-ft. tube. The empty space at the end of the pipe acts as a mixing chamber and allows a fairly satisfactory sample to be drawn through the nipple.

The sampling tube is to be inserted in the flue in such a way

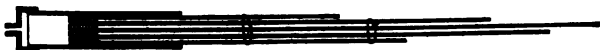

FIG. 1.—Multiple gas sampling tube.

that there will be no leakage around it. An iron gas main may be drilled and tapped to receive a threaded nipple into which the sampling tube is luted when in use and which is closed by a cap when not in use. When a hole must be cut through a brick wall a threaded nipple may be cemented permanently into the wall and closed, when not in use, with a cap. If only a single sampling tube is used it should be inserted to about the point of mean velocity of the gases, a subject which is discussed in Chapter IX. Where a multiple sampling tube of the above type is used it should be inserted so that the longest tube reaches at least to the center of the flue.

It is frequent but bad practice to connect the sampling tube and the aspirator by a rubber tube. Rubber is softened and burned by hot gases and yields gaseous products which contaminate the sample. It also dissolves tar and hydrocarbon vapors and even permanent gases like ethylene in sufficient amount to materially change the character of the gas. Furthermore, even

the best rubber is never gas tight but always allows some leakage. It is usually necessary to use a small amount of rubber tubing in making connections, but its use should be restricted to lengths of only an inch or two where it serves as a connector between glass or metal tubes. When thus used a copper wire should be twisted tightly around the rubber where it slips over the glass tube to ensure a tight joint. A tightly stretched rubber band may be used instead of the wire. Small lead or seamless copper tubes are flexible and more satisfactory than glass where the temperature is not so high that the gases react with the metal.

5. Aspirators.—The commonest form of aspirator consists of a bottle or tank initially filled with water which flows slowly out and is replaced by the gas. With this form of aspirator the suction constantly decreases as the head of water drops and therefore the flow of gas slackens, which is a disadvantage. This may be overcome by making the entering gas pass down through a central tube and then bubble up through the water on the principle of the Marriotte bottle, but unless the water of the aspirator has been previously thoroughly saturated with the gas this process is certain to change the composition of the gas very materially. The extent of the error introduced by failure to observe this precaution is discussed later. A film of heavy paraffine oil is sometimes poured on the water of the aspirator bottle to prevent interaction between the water and the gas. Such an oil-film does not, however, prevent the interaction and does not even make it much slower. If oil is used it should be at least as heavy as a lubricating oil so that it will not give off any appreciable volume of vapors which even in small amount will cause difficulty in the estimation of oxygen by phosphorus. Oil should not be used when the gases sampled contain hydrocarbons, since these are quite soluble in heavy mineral oils.

Where frequent samples are to be drawn a pair of aspirator tanks as shown in Fig. 2 are to be recommended. Tanks to hold approximately a cubic foot should have the cylindrical portion 12 in. in diameter and 12 in. high with the cones each 6 in. high. They may be made of galvanized iron and will be strong enough with merely soldered seams if they are not knocked about too much. The ends of the cones terminate in short 1/2-in. nipples soldered in. The lower end of the tank carries screwed to this nipple a 1/2-in. cock F, and beyond this another 1/2-in. nipple

with a hose union. The upper nipple carries a 1/2-in. tee on whose side-arm is an ordinary 1/4-in. gas cock E, and on whose upper end is a cap tapped for a 1/4-in. pipe. This pipe, cut the length of the tank, is threaded into the cap from the inside before the latter is in place so that when screwed together the 1/4-in. pipe runs the whole length of the tank and projects through the cap enough to receive the gas cock D. With a pair of bottles of this sort the water flows from one to the other and is not exposed to the air so that it remains saturated with the gas.

If a water or steam line is at hand an injector may be employed as an aspirator. It is desirable in most cases to have the suction a slight and steady one, a condition not readily attained with injectors running only to a small per cent. of their capacity. It is well to have the injector open more widely than is necessary to furnish the suction required and to have on the line an automatic water seal relief valve as indicated at E in Fig. 3 which will suck in air at the inlet of the aspirator if the suction rises too high.

6. Solubility of Gases in Water.—The solubility of gases in water varies with the temperature and the pressure. For our treatment it will be sufficient to assume that the gas is always under atmospheric pressure and at ordinary room temperatures. Under these circumstances the solubility of the common gases is as follows:

SOLUBILITY OF GASES IN WATER

Expressed as the volume gas dissolved by unit volume water at the temperature of the experiment when in contact with the pure gas at atmospheric pressure.

	59° F.	77° F.
Carbon dioxide.....	1.070	0.826
Oxygen.....	0.036	0.031
Nitrogen.....	0.019	0.016
Carbon monoxide.....	0.027	0.023
Methane.....	0.039	0.033
Ethylene.....	0.147	0.119

When mixed gases are in contact with water the amount of each gas dissolved will be in direct proportion to its volume and its solubility. Thus the composition of pure water saturated with air at 59° F. and at atmospheric pressure would be

Composition of air, per cent.	Volumes of gases in 100 vols. water	Percentage composition of gas dissolved by water
CO ₂ 0.04	0.04 × 1.07 = 0.043 vols. CO ₂	1.9
O ₂ 21.0	21.0 × 0.036 = 0.756 vols. O ₂	32.9
N ₂ 79.0	79.0 × 0.019 = 1.500 vols. N ₂	65.2
Total dissolved gas = 2.299 vols.		100.0

The composition of the gases in water saturated with chimney gases may be calculated in the same manner.

Composition of gas, per cent.	Volumes of gases in 100 vols. water	Percentage composition of gas dissolved by water
CO ₂ 10	10 × 1.07 = 10.70	85.0
O ₂ 10	10 × 0.036 = 0.36	2.9
N ₂ 80	80 × 0.019 = 1.52	12.1
12.58		100.0

The change in the carbon dioxide from 10 per cent. of the gas sampled to 85 per cent. of the gases dissolved in water shows how serious are the errors which can arise in sampling. If the sampling tank originally filled with pure water should be only half emptied so that it would be half filled with gas of the above composition and half filled with water, and then it should be allowed to stand till equilibrium were attained, 7 per cent. of the gas would be dissolved by the water with the following result.

Original composition of gas, per cent.	Composition gas after standing over water, per cent.	Composition of gases dissolved by water, per cent.
CO ₂ 10.0	5.2	73.4
O ₂ 10.0	10.4	5.0
N ₂ 80.0	84.4	21.6

The above illustration shows that in chimney gases it is not at all impossible to have an error of 50 per cent. in the CO₂ through carelessness in sampling. Errors of similar nature, although hardly of such large proportions, will arise with other gases. With illuminating gas it is the important class of illuminants of

the ethylene series which is most seriously affected. If it is worth while taking a sample at all it is worth while to saturate the water with which the gas is to come in contact.

7. Saturating Water in Sampling Tanks.—When the gas to be sampled is under pressure it may be bubbled through the water contained in a bottle, best only about two-thirds full of water and loosely stoppered. The air of the bottle will soon be replaced by the gas which will thus act on the constantly changing surface of the liquid as well as on the surface exposed to the bubbles. An occasional vigorous shake will greatly accelerate absorption. Under these conditions the water will become practically saturated in fifteen minutes. It is not wise to attempt to saturate water by bubbling the gas through it while in an open beaker, since the constant presence of the air above the liquid defeats the very object aimed at.

The water in tanks of the form shown in Fig. 2 may be readily saturated if suction is available by connecting tank 1 to the gas main as shown and connecting the suction pipe to cock E of the same tank. The gases will then bubble through the water and pass out E. Where suction is not available the procedure is as follows. Start with tank 1 full of water and tank 2 empty. Fill tank 1 with gas and connect the cocks E on the two tanks with rubber tubing. Raise tank 2. Water will flow from 2 into 1 and gas from 1 to 2. When each is approximately half-full close the valves and shake. Finish passing the water from 2 into 1 and disconnect the rubber tube from E of tank 2. Draw a fresh tankful of gas into 1, allowing that in 2 to escape into the air. Connect the cocks E with rubber tubes as before and repeat the process of dividing the gas and water between the two tanks and shaking. After three such operations the water will be sufficiently saturated.

8. Collecting an Average Sample Representative of a Definite Period.—It is frequently desirable to determine the average composition of gases flowing through a flue for a period of time which may be 15 minutes or 24 hours. If the period is not longer than an hour the use of two cu. ft. tanks as shown in Fig. 2 is satisfactory, it being assumed that only the true gases are of importance and that suspended solids and condensable vapors are either absent or unimportant. A represents the multiple sampling tube projecting into a flue. B is a tube loosely packed

with cotton or asbestos to filter out dust. C is a bubbling tube to indicate the rate of flow of the gas. The first step in a test is to saturate the water of the tanks as previously directed. At the close of this operation tank 1 should be full of water and tank 2 of gas and the sampling tube and the filter should be full of gas. To commence the sampling operation D is opened fully and F is opened slightly until gas bubbles through C at the rate desired. It is a mistake to open widely the lower stopcock on the sampling tank and control the flow of gas by partially closing the upper stopcock, since with this procedure the gas in the tank is under

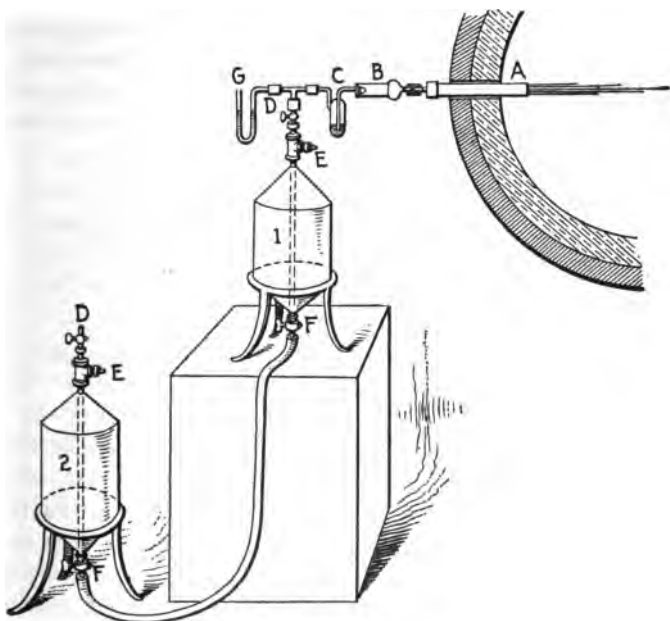

FIG. 2.—Apparatus for aspirating a sample of gas from a flue.

an unnecessarily reduced pressure and there is an unnecessary risk of leakage. The gas in tank 2 escapes through the open cock at the top. The pressure gage at G will indicate if the sampling tube or the filter becomes choked. The rate of gas flow should be so adjusted that tank 1 will be almost filled with gas at the end of the period. There should still remain enough water to act as a stirrer for the gas when the tank is shaken vigorously to mix the contents. This mixing is a simple precaution which should never be omitted. It is true that gases do

mix by diffusion but the rate is a slow one and it is never safe to rely on diffusion to give a fair sample. After the gas in tank 1 is mixed a portion may be transferred through cock E to a laboratory gas holder for analysis. To get ready for the next sample the E cocks on both tanks should again be connected by the rubber tube and the gas transferred to tank 2 so that the water in tank 2 will remain saturated.

If the sampling period is to extend for much more than an hour the flow of gas through the sampling tube becomes so slow that a multiple sampling tube is not to be relied on. The use of the additional apparatus shown in Fig. 3 remedies the difficulty where a continuous aspirator is available to draw a rapid stream of gas through the sampling tube. The gas filter, bubbling tube and sampling tanks of Fig. 2 are to be attached to cock A of Fig. 3. The sampling tanks may then be set to take as slowly

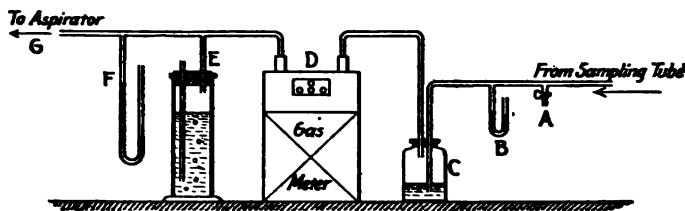

FIG. 3.—Continuous gas sampling apparatus.

as may be desired a portion of the representative rapidly flowing gas stream.

In Fig. 3, B is a pressure gage to indicate any obstruction of the sampling tubes, C is a bubbling bottle to give a visual control of the rate of the stream, D is a gas meter, E is a pressure control and F a pressure gage on the line from the aspirator. The suction on the sampling tube as shown by gage B should be only a few tenths of an inch of water. It is difficult, however, to get an aspirator to work properly when nearly shut off so that the aspirator is opened enough to work efficiently and the suction on the line is kept down by the regulator E. The suction on B may be regulated by the depth to which the tube in E is immersed. An orifice meter may be substituted for the dry meter shown in the installation at D. Such an apparatus may be made of metal or may be made quite simply from glass tubing.¹

¹ Benton, *Jour. Ind. and Eng. Chem.*, xi, 623 (1919).

The title of this section calls for the collection of a sample representative of a definite period. The foregoing procedure only accomplishes it approximately. In order that the sample should be truly representative a given proportion, say one-tenth of 1 per cent. of the gas, should be constantly passing through the sampling tube. If the flow of gas in the main dropped to one-third of its former rate, the flow of gas through the sampling tube and into the sampling tank should also decrease. The ideal to be striven for is to have in the small sampling tank gas of the identical composition that there would be in a large gas holder where all of the main gas stream had been gathered and mixed. This can only be accomplished by a sampler which takes representative quantities as well as qualities of gas. The sampling apparatus described is supposed to work at a constant and not a proportionate rate, but it does not even do this accurately. It is not, however, possible to take a truly proportional sample without great elaboration of equipment and the method described is usually sufficient.

9. Collecting a Representative Instantaneous Sample.—The problem of a representative instantaneous sample is in some ways simpler than that involved in collecting a sample to represent a longer period. If the apparatus shown in Fig. 3 is attached to a multiple sampling tube a sample drawn at A should be fairly representative. If desired an Orsat burette or similar apparatus may be attached permanently at A.

10. Storing Gas Samples.—Samples of gas obtained as directed in the preceding section are too large for ready transportation to the laboratory for analysis. It is usually convenient to transfer a portion to a small glass gas holder which is advantageously of the type proposed many years ago by Hempel and shown in Fig. 4. This consists of a bulb terminated above by the gas inlet of capillary tubing bent in the form of a U to allow a water seal and at the bottom by a larger tube for the water supply. The transfer of gas is accomplished in the following stages. Attach at cock E of Figs. 2 and 4 a glass tee carrying at A a rubber connection and a small funnel and at B a rubber connection. Fill the gas holder with water taken from the large sampling tank 2 of Fig. 2, which is saturated with the gas, and connect the gas holder at B as shown in Fig. 4, with the exception

of the screw clamps at A and B. Open valve E and blow gas through the tee and out A to expel air. Close E and force water from the small gas holder into the funnel. Tighten clamp A. Fill the glass gas holder nearly full of gas and close E. Open A cautiously and allow water to flow from the funnel and fill the capillary seal of the gas holder. Close clamp B and disconnect the gas holder from the tee. Elevate the levelling bottle so as to put the gas in the holder under slight pressure, and close the clamp C at the bottom of the holder. The gas is now stored in a

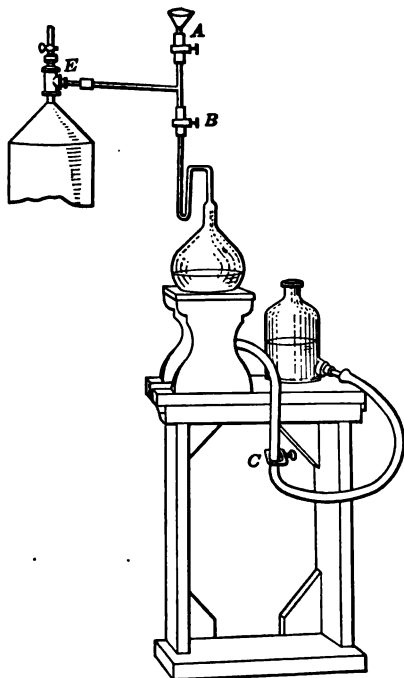

FIG. 4.—Glass gas holder for storing samples.

glass vessel closed at the top by a capillary tube filled with water, which in turn is closed by a clamped rubber tube at the top of the capillary. At the bottom the holder is similarly closed by a column of water. The gas is thus in contact with nothing but glass and water and if the latter has been previously saturated,

may be preserved without change for months. The above form of gas holder is always reliable. The galvanized iron sampling tanks shown in Fig. 2 may also be made of glass on a smaller scale and used for storage of gases. They are more convenient where samples are to be shipped since they do not have the projecting bent capillary which is liable to be broken in shipment.

Gas holders of the floating type are not to be relied upon for there is always diffusion of gases through the water, and after several hours evident changes may be found. There are numerous forms of gas holders where stopcocks are relied upon to prevent leakage. Stopcocks may be tight or they may not and anyone who has had experience with the irritating doubts attendant upon their use will prefer not to trust them more than is necessary. The same thing holds true of rubber stoppers and connections. Gases may, however, be transported quite safely in glass bottles with rubber stoppers provided a little water is left in the bottle and the stopper is wired tightly in and covered thickly with paraffine. The bottle is then to be kept upside down. Under these conditions the small amount of water in the bottle forms a seal on the inside and the paraffine a seal on the outside, re-enforcing the rubber. When samples of this sort are to be shipped by express they should be packed in crates without a top so that care will always be taken to keep the proper end up. Where gases have to be stored a long time and especially where they must be shipped, the truly safe way is to collect them in glass tubes drawn out at each end and fuse the ends in a blowpipe flame.

CHAPTER II

GENERAL METHODS OF TECHNICAL GAS ANALYSIS

1. Introduction.—Gas analysis is an extremely useful method for controlling the operation and checking the efficiency of many industrial operations. All of the manifold industries using fuel as a source of heat and almost all industries engaged in producing fuel or utilizing it in any way find in gas analysis a valuable assistant. There are very many special industries which require the analysis of gases which are peculiar to themselves and not connected with fuels, but though the general methods of gas analysis here given will often apply to these cases, no attempt will be made to develop those applications which might better be taken up in connection with a study of the particular industries. This chapter will consider only the gases arising from the utilization of fuels.

The purpose for which the analysis is desired will influence the methods to be employed and the kind of apparatus to be used, for time consumed and liability to errors increase rapidly with the number of constituents to be determined. The analysis is to be made as simply as possible, small percentages of gases unimportant for the purpose of the analysis being neglected and groups of related gases being frequently determined together. In boiler firing and in the operation of all furnaces heated by combustion of fuel, the variations in the percentages of carbon dioxide, oxygen and carbon monoxide show at once the changes in efficiency of the furnace. In the operation of gas producers these three constituents with the added determination of hydrocarbons and of hydrogen suffice for most purposes. When gas is to be sold to consumers, as is the case with a city gas supply, a more complete analysis is often necessary and not infrequently some uncommon and minute constituents must be sought as an explanation of trouble.

This adaptation of the means to the end is a characteristic of technical analysis, which seeks only the particular information

of value for the purpose in hand. On this account gases from different sources will be considered separately, although there may be much in common between them. There are various operations common to almost all processes of gas analysis which may well be considered before passing to special cases, and such general considerations form the subject of this chapter.

2. General Method.—The method preferably followed in technical gas analysis requires a measurement of the initial volume of the mixed gas, the absorption of a single constituent by an appropriate reagent, and the measurement of the new volume, the constituent absorbed being determined by difference. Where no suitable absorbent is known for a given constituent it is desirable to transform the gas into some more suitable compound. It is necessary in order that these changes in volume due to absorption be correctly noted, that the temperature and pressure of the gas be known at each step, and it would be ideal if both the temperatures and pressures could be kept absolutely constant throughout the process. This can never be accomplished, although by special apparatus described in Chapter VI on Exact Gas Analysis errors due to change in external temperature and pressure during an analysis may be automatically eliminated. This procedure is, however, more complicated than is necessary for technical work where it is usually sufficiently accurate to make the assumption that the temperature of a water-jacketed burette in a laboratory does not vary during the hour that may be required for an analysis, and that the barometric pressure does not change in the same period. Since this simpler procedure is sufficiently accurate for most technical purposes, it will be described first. The historical development of the present apparatus and methods is discussed in Chapter VI on Exact Gas Analysis.

3. The Gas Burette.—The gas burette has its zero point at the top and is usually of 100 c.c. capacity. It is closed at the top by a stopcock or sometimes simply by a rubber tube and a pinchcock and should always be enclosed in a water jacket. Almost all forms of gas burettes will answer the above description, but there are many differences of detail, the most important being the style of the stopcock which closes the burette at the top. The form of apparatus which has been evolved in

the laboratory of the University of Michigan¹ and which has given good service during the past ten years is shown in Fig. 5, which illustrates the apparatus as it appears in service. Details are given in Fig. 6. The burette-stand may be improvised from an ordinary iron stand, one of whose rings of external diameter slightly greater than the water jacket of the burette has been provided with a brass collar, thus making a

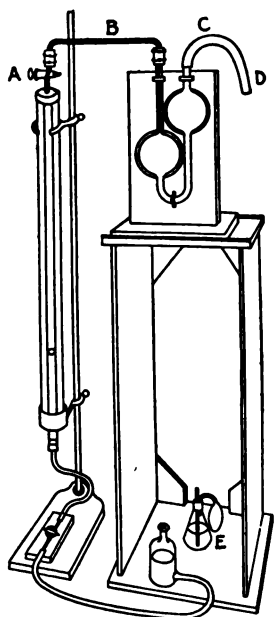

FIG. 5.—Gas burette and pipette.

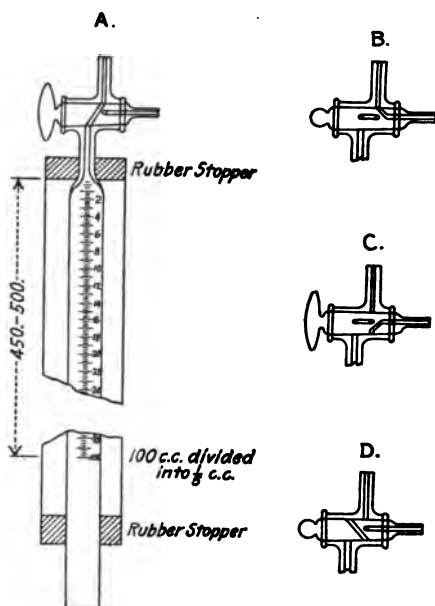

FIG. 6.—Details of gas burette.

cup in which the rubber stopper of the water jacket rests without binding. Another ring large enough to slip loosely over the water jacket serves to keep the burette vertical. A segment is sawed out of the front of this ring to allow an uninterrupted view of the graduations, and it is wrapped with chamois skin until it fits as snugly as desired. A spring clamp made from sheet brass makes a more elegant upper support. By this simple arrangement the burette may be raised, lowered, or swung to

¹ White and Campbell, *J. Am. Chem. Soc.*, 27, 734 (1905).

one side at the convenience of the operator, and may be tipped in any position while carrying, without danger of breakage.

By reference to A of Fig. 6 it will be seen that the body of the burette is a perfectly straight tube. It is closed at the bottom by a one-hole rubber stopper, which need not even be wired in, unless the burette is to be filled with mercury. To clean the burette, all that is necessary is to take out the rubber stopper and lift the burette and its jacket out of the rings when it may be turned upside down, swabbed out as an ordinary burette, and then swabbed with a clean dry muslin which is more efficient than a wet cloth in removing the film of grease which causes the drops to hang to the glass. Caustic soda may be used or chromic acid, but they are not usually necessary.

4. Care of Stopcock.—The stopcock of a gas burette is very carefully ground and polished so as to be as nearly gas tight as possible. Particles of grit getting into the capillary opening are apt to cut a groove around the stopcock so the opening is bored diagonally in order that the grooves worn in this manner may be parallel and non-connecting. This device is of assistance but the stopcock must still be handled carefully.

To keep in good condition remove the stopcock from the burette, wipe it off with a dry cloth and see that the capillary openings are clean. Do the same with the seat into which it fits in the burette and the capillaries with which it connects. Rub a thin coat of some lubricant over the stopcock. Vaseline is inferior. A material made by melting one part of best black rubber at as low a temperature as possible and stirring into it one part of paraffine and one part of vaseline answers well when it is carefully made. The author has found anhydrous lanolin the best material. The lubricated stopcock should be pressed gently into the dried seat and turned a couple of times, when the space between the stopcock and the seat should appear perfectly translucent without air bubbles or any discontinuity. If too much lubricant is used it will work itself into the capillaries and clog them. If either the stopcock or the seat is wet the lubricant will not adhere well. These stopcocks are expensive and it is advisable to fasten them to the burette with a fine copper wire attached to the stopcock so loosely that it can turn readily. It is not advisable to use a rubber band for this

purpose since it sticks to the handle of the stopcock and exerts a torsion sufficient sometimes to turn the cock at an inopportune time. The stopcock should always be loosened in its seat when the burette is to be put away and it is admirable policy to always clean it and make it ready for use again before setting it aside.

✓
5. Saturating the Water of the Burette.—The liquid filling the burette is almost always water which allows much more rapid and convenient and in some ways more accurate manipulation than mercury does. It should be saturated with gas similar to that which is to be analyzed. If the gas is air this precaution may often be omitted, since distilled water is usually saturated with air. The precaution should not be omitted with other gases, especially those like flue gases rich in the more soluble carbon dioxide. The errors due to solubility of gases are discussed more fully in Section 6 of Chapter I. Place 200 c.c. of water in a flask or bottle of about 400 c.c. capacity and lead in a stream of gas through a glass tube passing through a loosely fitting cork, shaking occasionally. If the supply of gas is limited a smaller flask may be used and the loose cork may be pressed down tight after the air has been displaced. Shaking the flask facilitates absorption. It is not necessary that the water be absolutely saturated and five minutes is usually ample time for the operation.

6. Drawing the Sample of Gas into the Burette.—The gas to be analyzed is assumed to be contained in a gas holder of a type similar to that shown in Fig. 4 of Chapter I, but the directions for use of this type of gas holder may readily be adapted to other types.

The tubing to connect the burette and gas holder should be capillary so that the air contained in it may be completely swept out without wasting much gas. A tube of 1 mm. internal diameter answers well. It should not be rubber because rubber absorbs heavy hydrocarbons from gases rich in these bodies and gives them back again to gases containing them in but small amount. It is necessary to make one rubber connection at each end of the capillary tube but the surface of rubber exposed to the action of the gases should be reduced to a minimum by bringing the ends of the glass capillary tubes into direct

contact with each other, or, if it is necessary to leave a pinch-cock on the rubber, as close to each other as possible. The glass tubes should be cut off square and the sharp edges softened in a flame sufficiently to prevent the cutting of the rubber but not enough to constrict the capillary opening of the glass tube. The rubber tube should fit tightly to the glass and be of the best quality black gum rubber, free from any internal ridge where the seam has been joined. The inside of the rubber tube may be moistened with water or preferably with glycerine to make it slip more readily over the glass. The rubber connections to the capillary should be bound with wire as a further safeguard against leakage. Soft copper wire of about 22 B. & S. gage is suitable. Finer wire is too apt to cut the rubber. Heavier wire is apt not to pull up snugly. Copper wire of 24 B. & S. gage insulated with cotton and paraffined like that used for annunciators, is the best material as it is strong enough and does not cut the rubber. It is a mistake to wrap the wire several times around the tube. A piece of wire about 2 in. long should be wrapped once around the tube. The crossed ends are then to be grasped close to the rubber with a pair of pliers and tightened with a single half turn of the wrist.

No rubber joint can be relied on to be gas-tight for a long period of time. A joint prepared as directed here should, however, not allow any perceptible leakage in the course of a gas analysis although it is wiser not to subject it to any higher gas pressure or suction than necessary.

The method of connecting the gas holder and the burette is shown in Fig. 7 where A is the gas holder, D, a bent capillary tee tube and F the gas burette. Before making the connections the gas burette is to be filled with saturated water and the cock closed by a turn of 180° which completely seals both the capillaries below and above the cock. The capillary tee tube is to be inserted into the open rubber tube above the clamp B, connected at E as shown and the joints are to be wired. The gas in the holder is to be put under pressure by raising the levelling bottle and clamp B opened. Cock C is then opened slightly until the water in the capillary of the gas holder rises to displace all the air in the funnel arm. Cock C is then closed and cock F turned 90 degrees to the position shown in Fig. 7 and at B in

Fig. 6. The rest of the water in the capillary A moves through D and out F driving all air ahead of it. Some gas may also blow out if the manipulator is not skilful, but this does no harm. Cock F is then turned 90 degrees opening the passage to the burette as shown at A in Fig. 6 and the gas passes into the burette. When enough gas is in the burette another 90-

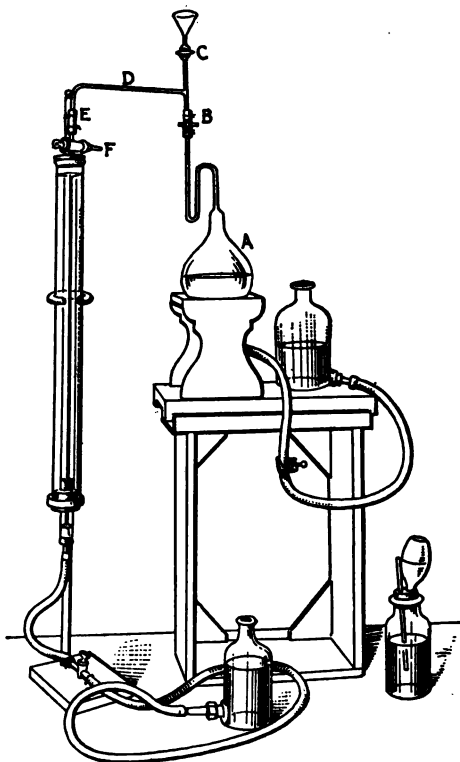

FIG. 7.—Gas burette and gas holder.

degree turn of the cock in the same direction to the position C of Fig. 6 stops the gas flow. A few cubic centimeters of water are placed in the funnel above C (Fig. 7), the pressure in the gas holder is changed to suction, cock C is opened and water flows into the capillary of the gas holder re-establishing the seal. The clamp B may then be closed and the capillary disconnected. This procedure allows transfer of the gas without

possibility of change in composition and restores the seal of the gas holder at the close of the operation. Instead of the tee with cock and funnel blown as one piece the simpler apparatus shown in Fig. 4 of Chapter I may be used.

7. Measuring a Gas Volume.—The volume of gas is to be measured at the temperature of the water jacket and at barometric pressure. The temperature of the gas as drawn into the burette does not ordinarily differ very many degrees from that of the jacket water but it should be allowed to stand a few moments to allow it to attain that temperature. During these minutes the gas if not already saturated with moisture rapidly absorbs it from the moist burette walls and becomes saturated as it should be before its volume is measured.

Delay in reading the volume is also necessary to allow the film of water which adheres to the burette walls as the sample is rapidly drawn in, to run down. If the walls of the burette are clean the water will have run down in three minutes so completely that the volume has become approximately constant. If this precaution is neglected the volume read may easily be in error by 0.2 c.c., even with a clean burette. Some operators object to this three-minutes wait as too great hindrance to rapid work and it is true that if the readings are made by a skillful operator immediately after the introduction of the gas, the errors of successive readings are almost constant and disappear in the subtractions. If, however, the practice is followed of detaching the used pipette and connecting the new one before reading the volume of gas, sufficient time will have elapsed without the operator's having been idle.

To obtain a sample of exactly 100 c.c. a sample of slightly more than 100 c.c. is initially taken and compressed by raising the levelling bottle until the bottom of the meniscus is exactly opposite the 100 c.c. mark. The stopcock at the bottom of the burette is then closed so that the meniscus cannot change its position and the stopcock at the top of the burette opened momentarily to the air, to allow the pressure in the burette to equalize itself with the outside air. The volume of gas should now be 100 c.c. at atmospheric pressure but the correctness of the volume should be checked by opening the stopcock connecting the levelling bottle with the burette and raising the levelling

bottle until its water surface is at the same height as that of the water in the burette. The connecting stopcock may now be closed and the volume read as indicated by the bottom of the meniscus. If the operation has been properly carried out the volume should be exactly 100 c.c. This volume is subject to correction for error in the burette and if an exact 100 c.c. sample is desired the meniscus may have to be set on some other figure than the 100 mark.

8. Calibration of a Gas Burette.—A gas burette may be calibrated like any other form of burette by wiring a one-hole rubber stopper carrying a stopcock into the bottom of the burette and weighing the water delivered. Burettes of good quality are usually calibrated accurately enough throughout their cylindrical portion to make this form of calibration unnecessary for technical work. The burette should, however, be calibrated in its upper portion, especially if its previous history is not definitely known, since its original stopcock may have been broken and the volume of the neck changed when a new stopcock was fused on, and since it may have been calibrated by the maker to be used when filled with mercury instead of with water. The error in this latter case arises from the custom of reading the mercury meniscus at the top of its convex surface and the water meniscus at the bottom of its concave surface. It will be readily seen that if the mercury meniscus stands at 10 c.c. there will be more gas in the burette than if the same burette is filled with water with the bottom of its meniscus at 10 c.c. This error may amount to 0.2 c.c. in an ordinary burette. Both of these errors are constant ones throughout the cylindrical portion of the burette and independent of the volume of gas in the burette. It will therefore be sufficient to determine them once.

The most convenient method is to compare one burette with another. Draw into each burette about 10 c.c. of air, the exact amount being entirely immaterial. It is only necessary that the volume be large enough so that the reading is in the cylindrical portion of the burette. It is not desirable that the volume be large since the error caused by water adhering to the walls of the burette increases with the size of the sample. Connect the burettes by a bent capillary tube making the rubber connections while the stopcock of one of the burettes is

open to the air so that the air enclosed in the capillary will be under atmospheric pressure. Read the volume of the air in each burette at atmospheric pressure as usual. We will assume that Burette A which has an unknown constant error "x" is the one being tested and that Burette B is the one assumed to be correct throughout its cylindrical portion, although it may itself have a similar unknown constant error "y." Transfer all of the air from A to B stopping the water in A just at the stopcock and read the new volume in B. The notes will then read somewhat as follows:

CALIBRATION OF BURETTE A AGAINST BURETTE B

	Burette A	B
Initial vol. air	10.6 c.c. + x	9.5 c.c. + y
Second reading	0	20.3 c.c. + y
	<hr style="width: 50%; margin: 0 auto;"/>	<hr style="width: 50%; margin: 0 auto;"/>
Subtracting	10.6 c.c. + x = 10.8 c.c.	
	x = +0.2. c.c.	

This result translated into words means that there must be added to each reading of Burette A 0.2 c.c. Since the probable error of observation is 0.1 c.c. several successive determinations should be made and the mean taken.

It is always wiser to record this error in the notebook after each reading, 92.5+0.2, and not simply make the correction mentally and record 92.7, since there may always come a time when the analyst will be in doubt as to whether he has made the mental correction or forgotten to make it before recording. This error automatically disappears whenever one volume is subtracted from another and it is therefore only necessary to apply it when the absolute volume needs to be known as is the case with the initial volume taken for analysis. This makes the error vastly less important than it would be otherwise, for if in an analysis of flue gas an apparent 100 c.c. sample is taken which becomes when corrected 100.2 c.c., and 10 c.c. is found to be CO₂, the percentage of CO₂, neglecting the burette calibration, is found to be 10.00 per cent. and allowing for the calibration 9.98 per cent., which when rounded off becomes 10.0 per cent. as before. The case is different, however, when a sample of 10.0 c.c. is taken as is the case in explosion analysis. If the

analysis showed 8.0 c.c. of hydrogen, the percentage neglecting the calibration would be figured as 80.0 per cent. but allowing for the calibration would be 78.4 per cent. It is preferable to record the calibration correction even though it may be later neglected in the calculation.

9. Gas Pipettes.—The various gases are determined so far as possible by absorption in suitable reagents contained in pipettes of the form shown in A, B, and C of Fig. 8. The use of a separate pipette for each reagent was first brought into general use by Hempel. These pipettes differ from his in the elimination of the deep U bend in the capillary, which is retained only in the explosion pipette. This deep bend is a distinct disadvantage

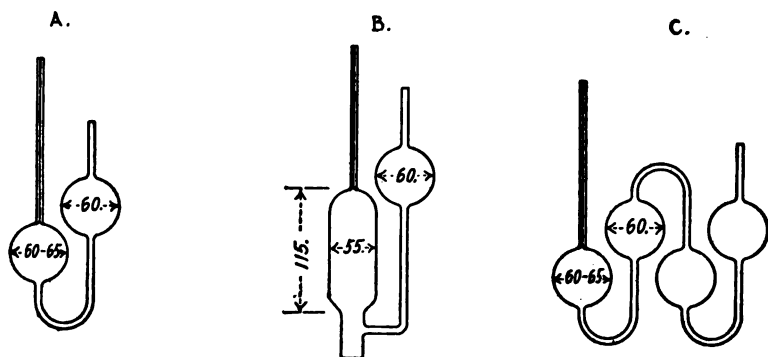

Fig. 8.—Details of gas pipettes.

since drops of reagent collect in it and are later carried into the burette. It is no longer needed when used with the burette just described. These pipettes are mounted on wooden stands, as shown in Fig. 5, which should be paraffined and not shel-lacked so that they may not be affected by reagents accidentally spilled.

10. Connecting the Burette and Pipette.—The greatest manipulative error with most forms of gas analysis apparatus comes from the frequent changes of pipettes necessary. Unless the operator is skilful there is danger of loss of gas or inclusion of air. The form of burette just described prevents this error. The general arrangement of the burette and pipette is shown in Fig. 5. The stopcock A is turned to the position shown at B in

Fig. 6, the bent capillary B whose dimensions are immaterial, is connected to the burette and pipette and the rubber joints are wired. The operator blows through the rubber tube (D of Fig. 5) on the last bulb of the pipette, forces the liquid from the pipette up the capillary and over to the stopcock, driving all the air ahead of it, and closes the stopcock by turning it 90° to the position D of Fig. 6. The capillary tube is now entirely full of liquid and the operator has only to compress the gas in the burette by raising the levelling bottle, and turn the stopcock a half turn to the proper position (A of Fig. 6) when the gas will pass into the pipette. By this method of manipulation, it is easy to transfer the gas from burette to pipette without loss or inclusion of air. Furthermore, since the volume of the capillary is entirely immaterial, it may be chosen of larger diameter than usual, permitting more rapid work and lowering the pressure necessary to force the gas through it rapidly. It has been found advantageous to have the stopcock left-handed, as indicated, so that the hand manipulating the stopcock may not interfere with a clear view of the meniscus of the liquid advancing along the capillary tube.

11. Details of a Simple Gas Analysis.—Accuracy in gas analysis is dependent on the exercise of very great care in manipulation. When the analysis is completed there is no way of going back over the ground again as may so frequently be done in ordinary chemical analysis, and it is not always possible to make duplicate analyses. The analyst must be able to state with confidence that every precaution was taken to ensure an accurate result. Detailed directions will be given for the analysis of a gas which may be assumed to be air. This is a very convenient material for practice since it may be obtained in unlimited quantities and of practically constant composition.

The burette is to be cleaned (§ 3), the stopcock lubricated (§ 4), and the water saturated (§ 5). Draw the sample of gas into the gas burette (§ 6), measure it (§ 7), and connect it to a pipette containing NaOH (§ 10), for determination of CO₂. The connections having been properly made and the air driven out of the capillary tube as indicated, raise the levelling bottle and pass the gas into the absorbent, letting the water of the burette follow until it reaches the bottom of the capillary of

the pipette. The gas is now all in the pipette. Let it remain for about three minutes gently shaking the pipette occasionally to agitate the gases and cause more rapid absorption. When it is believed that absorption is complete pass 1 c.c. of the burette water into the pipette to rinse from the capillary any reagents which might have been splashed into it, and then draw back the gas into the burette, pulling the liquid of the pipette as far as the stopcock on the burette. By a quarter turn of the stopcock to position B of Fig. 6 the connection between the pipette and the burette is closed while that from the pipette to the air is open. This causes the reagent to siphon back into the pipette. After waiting for three minutes to allow the liquid to drain from the walls of the burette read the volume as before and report the decrease in volume as the volume of the CO_2 absorbed. There is no certainty that all the gas has been absorbed. The only way for the operator to be sure is to pass the gas back again into the pipette and repeat the operation until the volume remains constant. Disconnect the pipette from the capillary tube, and rinse out the capillary tube with the wash bottle shown at E of Fig. 5, thus completing the first step of the analysis. If the gas being analyzed is air, the volume after treatment with NaOH should be the same as before since the volume of CO_2 in the air, 0.04 per cent., is too small to be measured with a burette of this type.

In the practice analysis of air the next determination would be that for oxygen which would be absorbed by phosphorus, alkaline pyrogallate or ammoniacal copper solution as directed in §§ 3, 4 and 5 of Chapter III. Air contains 20.9 per cent. of oxygen by volume. The residue is assumed to be nitrogen.

Successive analyses of similar gases may be made without changing the water in the burette provided that none of the reagents have been carelessly drawn into the burette. The greatest danger is from the caustic solution which will absorb some of the CO_2 from a newly introduced sample before its volume has been measured. Phenolphthalein in the water will act as an indicator to show when it has become alkaline and should be changed. There is no objection to having the burette water faintly acid and there is the advantage that small amounts of alkali are neutralized and rendered harmless.

12. Accuracy of the Analysis.—Account should now be taken of the magnitude of various possible errors, some of which have not been mentioned. The smallest division on the burette is usually 0.2 c.c. and the volume may not with certainty be estimated by interpolation closer than 0.1 c.c. This probable error limits the accuracy of the process to 0.1 per cent. with a sample of 100 c.c. and an accuracy of 1.0 per cent. with a sample of 10 c.c. Change of temperature of the burette water during an analysis causes a change of 0.36 per cent. in the volume of the gas for each degree centigrade. Change of barometric pressure causes a change in volume of 0.13 per cent. for each millimeter of mercury change in pressure. There are other minor sources of error which will be mentioned in Chapter VI under "Exact Gas Analysis." It will be evident that it is perfectly useless to expect an accuracy of greater than 0.1 per cent. with apparatus of this type, and that an error of 0.2 per cent. is not improbable. An analyst who reports an analysis carried to hundredths of a per cent. only shows his own ignorance.

CHAPTER III

ABSORPTION METHODS FOR CARBON DIOXIDE, UNSATURATED HYDROCARBONS, OXYGEN, CARBON MONOXIDE AND HYDROGEN

1. Carbon Dioxide.—This gas is determined by absorption in a strong solution of either caustic soda or potash. Very concentrated solutions dry the gas and make it necessary to let it stand in the burette before reading the volume until it has again become saturated with moisture. Dilute solutions work too slowly. A solution of 50 grm. NaOH in 150 c.c. of water is recommended to be kept in the form of pipette shown in A of Fig. 8. The absorption is rapid, three minutes being always ample. The reaction may be accelerated by gently shaking the pipette or by passing the gas back and forth. Glass rods or preferably glass tubes are sometimes introduced into the pipettes to accelerate the absorption by offering a large wetted surface with which the gas may come in contact. If this device is used care must be taken that no gas bubbles are trapped in the pieces of glass tubing as may frequently be the case if they are less than 5 mm. internal diameter or if they do not stand vertically. If it is desired to place glass tubes in the pipette use the form shown in B of Fig. 8. It will be necessary to wire the rubber stopper firmly into place to prevent leakage of the caustic.

This reagent absorbs not only carbon dioxide but also sulphur dioxide, hydrogen sulphide and any other acid vapors which may be present. It may be used until almost all of the caustic has been changed to carbonate. One pipette will absorb about four liters of CO₂. There will be slow carbonate formation through exposure to the air but the reagent may be used without fear for several months provided it is used infrequently.

2. Unsaturated Hydrocarbons.—These gases are determined by absorption in a liquid which by addition forms saturated compounds from the unsaturated ones. In gases from coal the

predominating constituent is ethylene, C_2H_4 , but smaller percentages of the other olefines are present and sometimes small amounts of acetylene, C_2H_2 . A solution of bromine water made by diluting one volume of saturated bromine water with two volumes of water is the reagent preferred by the author. It is placed in the first bulb of the double pipette shown in C of Fig. 8, and the third bulb is filled with water to lessen the diffusion of bromine into the air of the laboratory. If the solution becomes bleached through formation of hydrobromic acid in the sunlight, it is sufficient to add a few drops of liquid bromine which again brings it up to its normal strength. It is unnecessary to have it so strong that the gas drawn back into the pipette shows pronounced yellow bromine fumes. When gases with more than a small per cent. of unsaturated hydrocarbons are brought into contact with bromine it is possible to observe the formation of the bromide as an oily film on the surface of the liquid. As this film retards reaction between the bromine and the gas, it is advisable to shake the pipette gently during absorption, when little drops of the heavier ethylene bromide may be seen falling to the bottom of the pipette. The gas drawn back into the burette will contain so much bromine vapor that its volume may even have increased in the process. It must be passed into a caustic solution and shaken for about one minute to remove the bromine fumes and then brought back into the burette and measured. The diminution in volume is to be reported as unsaturated hydrocarbons. A delicate test for the complete removal of these constituents is afforded when phosphorus is subsequently used as a reagent for oxygen. A fraction of a tenth of a per cent. of ethylene will completely prevent the reaction between phosphorus and oxygen. Three minutes shaking with the bromine is sufficient to remove the unsaturated hydrocarbons from most gases, but gases of high candle power, like Pintsch gas, sometimes require ten minutes. Treatment with bromine water should be repeated until phosphorus smokes when the gas is brought in contact with it.

Fuming sulphuric acid acts in the same way as bromine water, but it is difficult to handle, attacks rubber tubing badly, and must be protected from the moisture of the air to avoid loss of efficiency.

3. Oxygen by Phosphorus.—Yellow phosphorus is an extremely reliable reagent for the absorption of oxygen when used under proper conditions. It combines with oxygen producing solid oxides of phosphorus and reacts with almost no other gases which might be present. The disadvantage attending its use is the danger of the reaction not taking place at all because of the presence of poisons, because of too low temperature or because of too high a concentration of oxygen in the gas. There is, however, easy ocular evidence of the reaction so that there need be no uncertainty as to whether the reaction has taken place. When once started it goes to completion.

The pipette is of the form shown in B of Fig. 8. To prepare it for use the pipette is inverted and filled with water and into it are dropped sticks of phosphorus about 5 mm. in diameter which have been cut to proper length under water. The sticks are to stand vertically and fill the pipette practically full. The only advantage of the small sticks lies in their greater surface and in the convenience with which the pipette may be filled. It is possible to prepare them in the laboratory by melting phosphorus under water at a temperature a little above 44° C. and sucking it into a slightly conical glass tube. With expert manipulation this tube may be lifted from the warm water and plunged into cold water where the phosphorus will solidify and contract so that the stick may be pushed from the tube. It is simpler though not so elegant to mould the sticks in a tin dish about 5 in. long made with a corrugated bottom and provided with a rim about an inch high and a handle. This mould is submerged in a dish of warm water and enough phosphorus melted in it to fill the corrugations. It is then lifted out and placed in cold water till the sticks become solid. Molten phosphorus catches fire instantly in the air and produces dangerous burns on the skin. Particles of solid phosphorus dropped in cracks of a wet table or floor have been known to smoulder twenty-four hours and finally burst into flame. Great care must always be exercised in handling phosphorus and it is usually preferable to buy it already cast in small sticks. The pipette should be kept in the dark when not in use to avoid the deterioration of the phosphorus. Pipettes made from brown glass

retard the action of the sunlight. With proper care a phosphorus pipette should last for years without refilling.

When a gas containing oxygen is introduced into a phosphorus pipette there normally appears at once a dense white cloud of oxides of phosphorus which are evident even when the amount of oxygen is less than 0.1 per cent. of the total volume. All technical gases will contain this much oxygen, for even if they did not contain it originally they will have absorbed it from the water of the sampling apparatus or of the burette, so that the presence of these clouds is a sure indication that the reaction is progressing properly. Conversely the absence of any smoke means not that there is no oxygen present, but that there is something preventing the reaction. The reaction between oxygen and phosphorus is also attended by a glow, visible only in the dark, which disappears with the completion of the reaction. The white cloud consists of solid particles of phosphoric oxides which slowly settle and dissolve in the water. It is not necessary to wait for this, however, before drawing the gas back into the burette and measuring the oxygen absorbed for the particles possess very slight vapor tension and do not occupy an appreciable volume. The reaction should with certainty be completed in three minutes if the white smoke appears promptly and if the surface of phosphorus exposed is large. It will not accelerate the reaction to shake the pipette since the reagent is a solid and the pipette is so closely filled with sticks that diffusion will soon bring the oxygen to the surface of the phosphorus.

The sticks of phosphorus at first yellow and waxy become covered with a reddish crust on long exposure to light and are inactive. Such sticks may be melted under water, skimmed, and cast into new sticks. The inactive crust may also be removed by placing in the pipette a 10 per cent. solution of $K_2Cr_2O_7$ made faintly acid with H_2SO_4 . The chromate becomes reduced to the green chromic salt with oxidation of the surface of the phosphorus. It is preferable, however, to avoid deterioration by keeping the pipette in the dark when it is not in use.

If the white vapors do not appear promptly when the gas is passed into the pipette, the explanation may be sought in four directions.

a. The temperature may be too low. It should be above $15^\circ C$.

b. The concentration of the oxygen may be too high. Moist phosphorus does not react at all with perfectly pure oxygen at ordinary room temperature. If the partial pressure of the oxygen is diminished either mechanically by an air pump or by dilution with an inert gas the reaction commences. With 50 per cent. oxygen it is violent, flame being produced and the phosphorus melting. There is danger of breaking the pipette. When the concentration is less than 30 per cent. the reaction proceeds quietly and the phosphorus does not melt.

c. A poison may be present. The most commonly occurring poison is ethylene, a few hundredths of a per cent. of which completely prevents the reaction between phosphorus and oxygen. Acetylene, benzine, ether, hydrogen sulphide and many other substances possess similar though usually weaker powers. Fortunately they are practically all removed either mechanically or chemically by bromine water followed by caustic potash and the gas should always be thus treated if the white fumes fail to appear promptly.

d. The phosphorus may have been rendered inactive by a heavy dose of poison. It may be restored by replacing the water in the pipette with fresh water and passing several successive samples of air into the pipette until the phosphorus again smokes freely.

Commercial compressed oxygen should be diluted with nitrogen before analysis. The nitrogen may be conveniently prepared from air by passing a buretteful of air into the phosphorus pipette, disconnecting the pipette and closing it with a pinchcock. Twenty-five to thirty cubic centimeters of the oxygen are then to be drawn into the burette (note that a calibration error of 0.3 c.c. means 1 per cent. here) and the phosphorus pipette reconnected. There will be sufficient nitrogen in it to flush out the capillary connecting tube and fill the burette as well. The oxygen may now be absorbed by phosphorus. It is desirable to introduce the oxygen into the burette before the nitrogen which thus fills the upper part of the burette and comes in contact first with the phosphorus. If the reverse procedure were followed and the oxygen introduced in the burette last, it might be brought in concentrated form in contact with the phosphorus

and cause violent combustion, a trouble which the above scheme of procedure avoids.

It has been frequently noted that beginners in gas analysis obtain rather consistently low results when determining the oxygen in air. This is usually due to the presence of sodium carbonate in the water of the burette as the result of faulty manipulation of the caustic pipette. The water in the phosphorus pipette contains phosphoric acid and if, in the manipulation, some of this acid is drawn back into the burette containing a little alkali, carbon dioxide is evolved in sufficient amount to cause the apparent percentage of oxygen in the air to be a few tenths of a per cent. low.

4. Oxygen by Alkaline Pyrogallate or Hydrosulphite.—Alkaline pyrogallate is very frequently used, especially in apparatus of the Bunte or Orsat type. When used with proper precautions it gives accurate results. Pyrogallol is a trihydric phenol $C_6H_3(OH)_3$, which in alkaline solution is a strong reducing agent, becoming itself oxidized to other products. Unfortunately, unless the solution is freshly prepared and strongly alkaline there is danger of carbon monoxide being evolved as oxygen is absorbed. This not only causes the oxygen to be reported low, but also makes the carbon monoxide high. Berthelot has shown that a reagent made by taking a solution of 1 part of pyrogallol in three of water and mixing it with its own volume of a solution of 1 part of KOH in two of water will, when freshly prepared, absorb ten times its volume of oxygen without giving back more than a trace of CO, but that solutions which have been used too long or do not contain enough alkali may give up as much as 5 per cent. of the volume of oxygen absorbed as carbon monoxide.

The reagent should be kept in a double pipette (C of Fig. 8), the third bulb being filled with water to prevent action of the air on the reagent. It may also be kept in a single pipette (A of Fig. 8) provided a rubber balloon is fastened to the second bulb for the same purpose. The reagent works very slowly at temperatures below 15° C. Carbon dioxide and other gases which would be absorbed by alkali must be removed before testing for oxygen with pyrogallate.

Mr. H. A. Small in the author's laboratory tested the behavior of a solution of pyrogallate made up according to Berthelot's directions and kept in an ordinary four bulb pipette without

any special precautions to prevent diffusion of oxygen into the pipette. Duplicate samples of air were analyzed almost daily for more than a month. During the first four weeks the reagent absorbed the proper percentage of oxygen although it was frequently necessary to shake more than three minutes to accomplish this. The 150 c.c. of reagent in the pipette had up to this time absorbed 1140 c.c. of oxygen. After this the absorption of oxygen became incomplete, the line of demarcation being quite sharp and the apparent oxygen of the air dropping from 20.7 per cent. to 20.4 per cent. Tests showed that the oxygen was still being quantitatively absorbed but that about 0.3 per cent. of carbon monoxide was being evolved. These results confirm Berthelot's statements. According to our results 1 c.c. of the reagent absorbs 8.0 c.c. of oxygen. In case of doubt concerning the reagent it should be tested on air and should be rejected unless it absorbs 20.6 to 20.8 per cent. of oxygen.

Anderson¹ recommends a much more strongly alkaline solution prepared by dissolving 15 g. pyrogallol in 100 c.c. of a solution of KOH of sp. gr. 1.55. An alkaline solution of this concentration is obtained by 1.5 to 2.0 parts of KOH in 1.0 parts of water. NaOH cannot be substituted for KOH in this concentrated solution. A disagreeable feature of this concentrated reagent is the formation of a precipitate which chokes the glass tubes and renders it difficult to determine the exact level of the liquid when drawing the gas back into the pipette. Anderson has described a special pipette to minimize this difficulty. Each cubic centimeter of reagent will absorb satisfactorily 22 c.c. of oxygen from air when used in an ordinary Orsat pipette. The absorption is much more rapid than with the ordinary reagent. Anderson recommends the simple Orsat pipette over the more complicated forms, for use with this reagent. Sodium hydrosulfite has been recommended by Franzen² as a cheaper and better reagent than pyrogallol. The solution is prepared by dissolving 50 gm. $\text{Na}_2\text{S}_2\text{O}_4$ in 250 c.c. H_2O and mixing this with 40 c.c. of a caustic solution made by dissolving 500 gm. NaOH in 700 c.c. H_2O . Each cubic centimeter of this reagent absorbs 10.7 c.c. oxygen. The equation for the reaction is as follows:

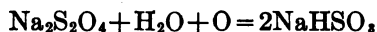

¹ *Jour. Ind. and Eng. Chem.*, 8, 131, 133 (1916).

² *Chem.-Berichte*, 39, 2069 (1906).

The solution is placed in a pipette containing rolls of iron gauze to increase the absorbing surface. Franzen states that the absorption is complete in five minutes without shaking, that it proceeds almost as rapidly at 4° C. as at room temperature, and that there is no danger of the formation of CO in the process.

5. Oxygen by Ammoniacal Copper Solution.—Orsat¹ advocated a cold saturated solution of ammonia and ammonium chloride in contact with metallic copper as a reagent for the absorption of oxygen and called attention to the limitation in the use of this reagent caused by its absorption of carbon monoxide. Badger² has recently made a careful study of various modifications of this solution and recommends that the reagent be prepared by saturating with ammonium chloride a mixture of one part concentrated ammonia and one part water. This solution will absorb from fifty to sixty times its volume of oxygen and then fails, not by refusing to absorb quantitatively but by the formation of so heavy a precipitate that it becomes unmanageable. The presence of metallic copper in the gas space is necessary for the proper operation of this reagent. The first bulb of a pipette of the type of B in Fig. 8 is filled with copper wires placed vertically and long enough so that the upper ends of those centrally placed reach even into the outlet of the capillary tube. This precaution is necessary when analyzing nearly pure commercial oxygen as otherwise the liquor rising as the oxygen is absorbed may submerge all of the wires before the oxygen is all absorbed. A rubber balloon may be fastened on the second bulb of the pipette to prevent rapid absorption of oxygen from the air. This reagent is cleaner to use and has a longer life than pyrogallate and its action is not interfered with by the poisons which inhibit the action of phosphorus. It is active at almost any temperature. Ammonia is given off from the fresh reagent in amount sufficient to make it necessary to pass the gas into a pipette containing dilute sulphuric acid before reading the volume to be recorded as that of the gas from which the oxygen has been removed. An old reagent gives off very little ammonia. This solution absorbs carbon monoxide and also acetylene and cannot be used to determine oxygen when these gases are present. It is recommended for the analysis of commercial oxygen.

¹ *Annales des Mines*, Series 7, t. 8, 485 (1875).

² *Jour. Ind. and Eng. Chem.*, 12, 161 (1920).

6. Carbon Monoxide.—The methods for absorption of CO are less satisfactory than for any of the other commonly occurring gases. The usual reagent is cuprous chloride Cu_2Cl_2 which on account of its slight solubility in water must be used either in acid or ammoniacal solution. The acid solution consists of a practically saturated solution of cuprous chloride in hydrochloric acid of specific gravity of approximately 1.12. Since the acid is only a solvent, its exact concentration is immaterial. Commercial acid may be used. About 150 grm. of the cuprous chloride will dissolve in a liter of acid of this concentration. This solution of cuprous chloride when pure is perfectly colorless but it darkens through slight oxidation as on exposure to the air, so that the usual solutions are black. It is possible to keep it colorless by placing in the reagent bottle or in the pipette copper turnings or copper wire, but it does not increase the efficiency of the reagent. If the oxidation proceeds so far that the solution becomes green, due to complete oxidation to the cupric state, the solution is worthless until it is again reduced to the cuprous state.

The reagent is kept in a double pipette whose third bulb is filled with HCl of sp. gr. 1.12 instead of water so that in case the cuprous chloride spills into it, it will not be precipitated. The gas which must have been previously freed from unsaturated hydrocarbons and oxygen is passed into the pipette and shaken for three minutes, then drawn back to the burette and passed into a second pipette containing fresh cuprous chloride where it is again shaken for three minutes, drawn back and measured. The HCl vapors in the gas may be neglected. There is no method of knowing whether the absorption of the CO has been complete. The only safe way is to repeat the absorption using a fresh solution until the volume becomes constant. Usually two absorptions of three minutes each are sufficient.

The reaction between carbon monoxide and cuprous chloride has not been definitely worked out. Jones¹ has shown that under certain circumstances a crystalline compound of definite composition results— $\text{Cu}_2\text{Cl}_2, 2\text{CO} \cdot 4\text{H}_2\text{O}$. In the dilute solutions present in gas analysis, however, the reagent behaves

¹*Am. Chem. Jour.*, 22, 287.

exactly as if it dissolved the carbon monoxide. When a perfectly new solution is used the CO will be practically completely removed. As the CO in solution increases there comes apparently an equilibrium between that in the gas and that in the solution, with the result that the absorption is incomplete. If a gas with only a small amount of CO is brought in contact with a solution which has absorbed much, the gas will increase in volume due to CO given up by the solution. Each cuprous chloride pipette should bear a label on which should be recorded the number of cubic centimeters of carbon monoxide which has been absorbed. When it has absorbed more than 10 c.c. it is not safe to rely on the results. In practice the analyst should have two pipettes for cuprous chloride, one, which has absorbed considerable carbon monoxide, to be used first, and another, which should be kept almost entirely fresh to follow the other. When this second pipette has absorbed 10 c.c. of CO it should be used as the first pipette and the former first pipette should be emptied and refilled with fresh reagent. The solution may be regenerated if desired by boiling it for half an hour in a flask containing some metallic copper and provided with a reflux condenser to prevent much loss of acid. The feebly held CO is driven off by the boiling and any oxidized solution is reduced to the cuprous state again.

Krauskopf and Purdy¹ suggest the use of stannous chloride as a reducing agent to be added to a solution of cupric chloride and form cuprous chloride in solution. Their solution contained 127.2 grams metallic copper and 616 c.c. of concentrated hydrochloric acid per liter. The cupric chloride dissolved in the hydrochloric acid was reduced by the stannous chloride. The presence of stannic and stannous chlorides even in relatively large amounts does not impair the efficiency of the solution for the absorption of carbon monoxide. The authors report that 200 c.c. of this solution will absorb over 300 c.c. of carbon monoxide quantitatively as shown by the following extract from their Table I where Pipette I contains an old solution and Pipette II a fresh solution, used after Pipette I gave no further absorption.

¹ *J. Ind. Eng. Chem.*, 12, 158 (1920).

Amount of CO already absorbed	365.5 c.c.
Volume of gas taken	50.2 c.c.

Pipette I		Pipette II	
Time, min.	Amount CO absorbed	Time, min.	Amount CO absorbed
1	39.0	1	0.4
2	0.6	2	0.2
3	0.2	3	0.0

The authors also confirm the reliability of the process of regenerating the solution by heating to 60–70° C. for several hours under a reflex condenser.

The ammoniacal solution is made by suspending about 150 grm. of cuprous chloride in a liter of distilled water into which ammonia gas is passed until the liquid becomes a pale blue color. The ammoniacal solution slowly regenerates itself on standing, the CO becoming oxidized to $(\text{NH}_4)_2\text{CO}_3$ and a mirror of metallic copper depositing. The NH_3 gas must be removed by an acid pipette before the correct amount of CO absorbed may be read.

Carbon monoxide may be estimated by explosion or combustion as described in the next chapter. Minute amounts of it may be estimated by the I_2O_5 method given in Chapter VI on "Exact Gas Analysis."

7. Absorption of Hydrogen.—Hydrogen may be absorbed by palladium sponge superficially oxidized to palladous oxide, according to the method of Hempel. It is necessary to regenerate the palladium after each experiment and the reaction is prevented by small amounts of carbon monoxide, hydrochloric acid and other constituents so that it is not a method which has found much favor.

A solution of palladous chloride as prepared by Campbell and Hart¹ is a better reagent. It is used as an almost neutral 1 per cent. solution prepared by dissolving 5 grm. palladium wire in 30 c.c. of HCl to which is added 1 or 2 c.c. HNO_3 . The solution thus prepared is evaporated just to dryness on the water bath, redissolved in 5 c.c. of HCl (sp. gr. 1.20) and 25 or 30 c.c. of water, warmed till solution is complete and diluted to 750 c.c. It is placed in a simple Hempel pipette made to be readily

¹ *Am. Chem. Jour.*, 18, 294 (1896).

detachable from its frame so that the bulbs may be placed in a water bath. The first bulb of the pipette should have a capacity of at least 150 c.c. to allow for expansion of the gas and water vapor when the solution is warmed. The gas freed by the usual methods from CO_2 , C_nH_{2n} , O_2 and CO , and containing H_2 , CH_4 and N_2 is passed into the pipette and the water from the burette passed over to seal the capillary of the pipette. A screw clamp is placed on the rubber connecting tube and the pipette disconnected from the burette and placed in a water bath at 50°C . for an hour and a half. A higher temperature does no harm provided it does not expand the gas so much as to cause it to bubble out of the first bulb or to leave only a small amount of reagent in contact with the gas in the first bulb. The hydrogen reacts with the palladium chloride forming metallic palladium and HCl . The total decrease in volume is reported as hydrogen. The reagent may be counted on to absorb one-third of its volume of hydrogen completely in an hour and a half. Larger quantities will be absorbed more slowly. It is readily regenerated by rinsing from the pipette, evaporating just to dryness on the water bath, dissolving in 5 or 6 c.c. HCl and 4 or 5 drops of HNO_3 and again evaporating. The dry palladous chloride is dissolved by adding 2 c.c. conc. HCl and a small amount of water and is then diluted to its original volume. The method is accurate and satisfactory. Carbon monoxide and other reducing gases behave like hydrogen and must be removed previous to the test but hydrocarbons of the methane series are not affected. The chief objection to the method lies in the time consumed which makes it frequently necessary to correct the gas volumes for change in room temperature and barometric pressure. A memorandum should be made of the temperature of the burette jacket and of the barometric pressure before and after the test and corrections made if necessary.

Paal and Hartmann¹ recommend a solution of colloidal palladium made by dissolving 2.44 grm. colloidal palladium manufactured according to Paal's process by Kalle (=1.5 grm. palladium) and 2.74 grm. of sodium picrate in enough water to bring the volume to 130 c.c. Gaseous hydrogen dissolves in the aqueous palladium solution and reduces the picric acid. Hempel²

¹ *Chem. Berichte*, 43, 243 (1910).

² *Zeit. Angewand. Chem.*, 25, 1843 (1912).

has made a critical study of this method and reports that a solution prepared in this manner will absorb in 15 minutes

when freshly prepared	21.2 c.c. H ₂ per 1 c.c. reagent.
after 79 days	16.2 c.c. H ₂ per 1 c.c. reagent.
after 1 year	1.6 c.c. H ₂ per 1 c.c. reagent.

He states that a fresh solution may be safely trusted to absorb completely 7.2 c.c. H₂ per centimeter reagent in three minutes if heated to the temperature of the blood. He advocates the preparation of the solution in small quantities and its use in a pipette filled mainly with mercury. A disadvantage attending the use of the reagent is the persistent foam which results after shaking and which must be allowed to subside before the volume of the gas is read. A few drops of alcohol at once dissipate the foam but spoil the reagent for further use. When alcohol is used the pipette must be carefully cleaned before another experiment.

In using this method the gas must first be freed from oxygen which is caused to unite with the hydrogen by the palladium, from unsaturated hydrocarbons which form addition products with the hydrogen, and from carbon monoxide which retards the absorption of the hydrogen. Bromine is recommended as the absorbent for the unsaturated hydrocarbons as it removes compounds of arsenic and phosphorus which might retard the catalytic action. Alkaline pyrogallate is advised for absorption of oxygen as phosphorus fumes affect the palladium. An ammoniacal solution of copper chloride is preferred to the acid solution.

8. General Scheme of Analysis.—Fig. 9 shows the apparatus ready for the analysis. The details concerning the individual steps of the process were given in Chapter II but it is well to recapitulate the important points in connection with the general scheme of analysis. The water of the burette is saturated with gas similar to that which is to be analyzed and a sample of approximately 100 c.c. is then drawn in and the volume read at atmospheric pressure after three minutes have been allowed to elapse so that the surplus water will have drained from the bur-

ette walls. Any needed correction for burette error is to be applied to this reading. The caustic soda pipette is to be connected to the burette, and the gas passed into it and allowed to remain with gentle shaking for three minutes. CO_2 is absorbed, as well as H_2S , SO_2 , etc., the whole being usually reported as CO_2 . The gas is drawn back into the burette and while waiting for the excess water on the burette walls to run down, the capillary connecting tube is flushed out and the bromine water pipette

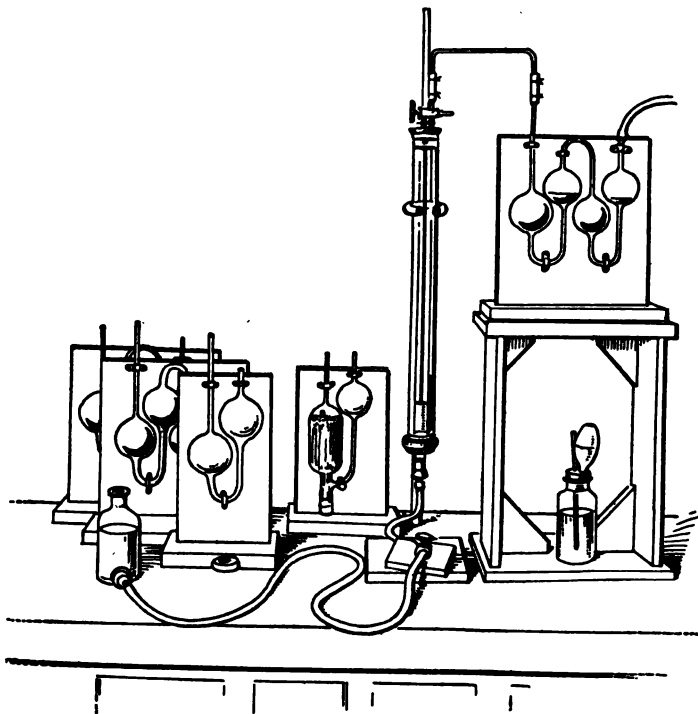

FIG. 9.—Assembled apparatus for gas analysis.

is connected. The volume in the gas burette is then read, and the gas passed into the bromine water where it is shaken for three minutes. It is drawn back to the burette, and at once passed into the caustic pipette where it is shaken one minute to remove bromine fumes. It is then drawn back into the burette and the decrease in volume reported as unsaturated hydrocar-

bons. The gas is next passed into the phosphorus pipette. White smoke at once appears. If it does not, it is a sign that some poison is present, usually removable by another treatment with bromine water. Following the estimation of oxygen comes that of carbon monoxide with cuprous chloride either acid or ammoniacal, preferably acid unless hydrogen is to be absorbed by palladium. Two cuprous chloride pipettes must be used in series, the second one containing almost fresh reagent. The residue from this absorption consists of hydrogen, hydrocarbons of the paraffine series and nitrogen. The hydrogen may be absorbed by palladium as outlined in this chapter but it is more common practice to estimate the hydrogen and hydrocarbons by combustion. The methods are discussed in the next chapter.

CHAPTER IV

EXPLOSION AND COMBUSTION METHODS FOR HYDROGEN, METHANE, ETHANE AND CARBON MONOXIDE

1. **Available Methods.**—Hydrogen and carbon monoxide may be estimated by absorption as indicated in the preceding chapter. They may also be estimated after oxidation to water or carbon dioxide. There are no satisfactory absorbents for methane and ethane and so these gases are always estimated indirectly after oxidation. The oxidizing agent may be gaseous oxygen and the reaction may be violent as in explosion methods or it may be quiet combustion. There may even be combustion of hydrogen

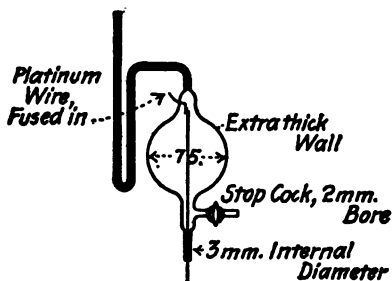

FIG. 10.—Detail of explosion pipette.

and carbon monoxide with the aid of a catalyzer in the presence of methane which remains unchanged. The oxidizing agent may also be an oxide, especially copper oxide, and here again there may be fractional combustion. The most rapid method and the one most frequently used is that of explosion.

2. **Apparatus for Explosion Analysis.**—The analysis by explosion is carried out in a stout glass vessel provided with electric connections across whose terminals a spark may be passed to cause the explosion. The shape and dimensions of the apparatus may vary. The form which has given good satisfaction

in the gas laboratory at the University of Michigan for a number of years¹ is shown in Fig. 10. It is a modification of the Hempel pipette and differs from it principally in the arrangement of the electric terminals and in the incorporation of an explosion guard in the stand.

In the older forms of pipette the explosion was induced by a spark made to jump a gap between two platinum wires sealed through the glass of the narrowed upper part of the bulb. When the interior of the bulb became wet as frequently happened the electric current would sometimes travel around the wet wall instead of sparking across the gap, and it was not possible to obtain an explosion. Gill² modified the bulb by introducing one of the wires through a ground glass joint at the bottom of the pipette. This was a valuable modification because it made the creeping distance so long that the spark was compelled to jump the gap, but the ground glass was difficult to keep tight. The form here described introduces the wire from the bottom but adopts a simple method of sealing which is very satisfactory. The lower wire which should be stiff (and may be of nickel about 1 mm. in diameter) is pushed through the open lower end of the pipette and sealed by sucking molten sealing wax into the pipette almost to the level of the tee. As the sealing wax hardens the wire may be moved to adjust the spark gap to the desired dimensions. No difficulty has been experienced in making this joint tight. The explosion pipette and its stand are shown in Fig. 11. The bulb is enclosed in a box open at the top and with a plate glass window in front, so that the operator can observe the explosion in perfect safety. The bottom of this box has an irregular opening sawed in it so that the pipette as shown in Fig. 10 may be lowered into place. The bulb sits in a cup shaped hollow of the shelf which may be padded with wet asbestos paper if necessary to make it fit well.

The weight of the mercury renders other fastening for the bulb unnecessary but the capillary is fastened to the rib behind it by a loop of fine copper wire passing through holes drilled in the rib. The strain of the rubber tube filled with mercury is taken off the glass tee by a ring below the shelf into which the rubber tube is

¹ White and Campbell, *J. Am. Chem. Soc.*, 27, 734 (1905).

² *J. Am. Chem. Soc.*, 17, 771 (1895).

wedged firmly by a split cork. The rack for the levelling bottle is higher than the tee of the pipette so that when the bottle is in the rack the mercury in the rubber tube is under pressure whereas if the mercury bottle were sitting on the base of the stand there would be a partial vacuum within the rubber tube. This may seem immaterial, but it must be remembered that all rubber is porous and that bubbles of air sucked into the rubber tube are certain to make their way up into the pipette and be measured

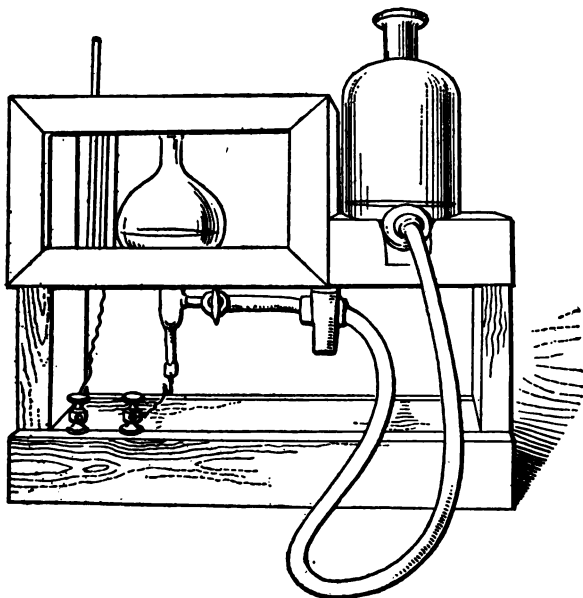

FIG. 11.—Explosion pipette and stand with protecting screen.

as part of the gas in it. Fine copper wires soldered to the electrode terminals of the pipette pass to the binding posts on the stand. The fine platinum electrode is liable to be cut if it is bent back and forth where it is sealed through the glass and to protect it the copper wire from the upper electrode is brought smoothly up to the capillary and tied there firmly with thread. The design of the stand is such that if a bulb breaks a new bulb may be inserted without trouble if it has even approximately the dimensions of the old one. The method of connecting this pipette to the burette and of transferring the gas is the same as for other

pipettes. This pipette is filled with mercury, since under the high pressure developed the solubility of the gases in water becomes large enough to cause appreciable error. An induction coil capable of giving a half inch spark together with its battery is necessary. A coil giving a large spark such as is given by the automobile sparkers is much better than a coil giving a thin high voltage spark.

3. Manipulation in Explosion Analysis.—In the explosion process a sample of gas previously freed from carbon dioxide, oxygen, unsaturated hydrocarbons and usually carbon monoxide is drawn into the burette and measured. Its volume may vary from 8.0 c.c. with pure methane to 50 c.c. with gases containing high percentages of nitrogen. Air sufficient to fill the burette is then drawn in. The burette is connected to the pipette as usual, care being taken to have the rubber connections in good condition and firmly wired, and the mixture is passed into the explosion pipette, the water of the burette being run over through the capillary of the pipette until the capillary is full. This water in the capillary acts as a cushion, preventing the force of the explosion from blowing up the rubber connections. The gas in the explosion pipette is brought to atmospheric pressure by means of the levelling bottle, the stopcock is closed, and the levelling bottle replaced in its rack. It is advisable to shake the pipette to ensure thorough mixing of the gases, for diffusion proceeds somewhat slowly. The gas is exploded by a spark from the induction coil. If the gas consists mainly of hydrogen there is usually no visible flame although a slight tremor of the mercury may be observed. If the gas contains much hydrocarbon a flash of flame may usually be seen. It is not advisable to spark the mixture more than a second as some nitrogen will unite with the oxygen at the temperature of the spark forming oxides of nitrogen with decrease of volume and erroneous results. The explosion completed, the gas is again brought to atmospheric pressure by means of the levelling bottle, and then brought back into the burette and measured. If there has been marked contraction, the next step is to pass the gas into caustic solution and determine if there has been formation of carbon dioxide.

If the decrease in volume after explosion was less than 12 c.c. it is almost certain that the explosion was incomplete. If

there was no decrease in volume it is not safe to assume that no combustible gas was present, for it may have been present in such a small proportion that the mixture was not explosive. The proper procedure in either case is to add about 10 c.c. of pure hydrogen made by the action of caustic soda on metallic aluminium and explode a second time. The addition of this amount of hydrogen ensures complete explosion. After allowance for the contraction due to the added hydrogen, the composition of the original gas may be calculated as explained later.

It is advisable to determine roughly the amount of oxygen remaining after the explosion so that there may be no doubt that an excess was present.

4. Oxidation of Nitrogen as a Source of Error.—Almost all technical gases contain nitrogen as do also commercial forms of oxygen. Bunsen first noted that nitrogen and oxygen react at the temperature of the electric spark or of an explosion flame to form small amounts of various oxides of nitrogen whose volume is less than that of the reacting gases and which combine with caustic. The formation of oxides of nitrogen leads, therefore, to an erroneously high contraction after explosion and to an erroneously high figure for CO_2 due to explosion. The error is discussed more fully in Chapter VI on Exact Gas Analysis but it cannot be altogether neglected in technical work. The error increases with higher flame temperatures and the simplest way to keep it within reasonable limits is to dilute the reacting gases with some inert gas such as nitrogen or excess of oxygen. The volume of the gases participating in the explosion (combustible gas + theoretical volume oxygen) should be from one-third to one-fifth that of the non-exploding gases (nitrogen + excess oxygen). It will be seen that 12 c.c. H_2 + 6 c.c. O_2 require to be diluted with from 54 to 90 c.c. nitrogen or oxygen and that 8 c.c. CH_4 + 16 c.c. O_2 require at least 72 c. c. of diluting gases.

The explosion of large samples of gas mixed with commercial oxygen, a method proposed by Hinman and endorsed by Gill,¹ involves much greater danger of blowing up the pipette and because of the higher temperature of explosion, tends to cause a larger formation of oxides of nitrogen from the nitrogen necessarily present.

¹ *J. Am. Chem. Soc.*, 17, 987 (1895).

5. Accuracy of Explosion Methods.—The necessity of diluting the exploding gases to avoid oxidation of nitrogen restricts the size of a sample of a rich gas like illuminating gas to about 10 c.c. With this small sample each 0.1 c.c. error in reading means 1.0 per cent. A greater accuracy can therefore not be expected except by averaging a number of analyses. It may be considered safe to rely upon a single analysis for the various gases determined by absorption, but explosion analyses should always be made in duplicate. The main portion of the gas after the absorption should be stored in a gas holder to be drawn upon for subsequent check analyses.

6. Hydrogen by Explosion.—If hydrogen is the only combustible gas taking part in the explosion its volume may be calculated from the contraction after explosion according to the following equation:

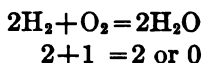

Expressed in volumes this means that two volumes of hydrogen combine with one volume of oxygen to form two volumes of water vapor. Since, however, the gas after explosion cools again to the temperature of the burette water and is the same as before explosion, and since it was saturated with water before explosion, the additional water formed must all condense. For our purposes, therefore, two volumes of H_2 react with one volume of O_2 with complete disappearance of the reacting gases. Under these circumstances when hydrogen is the only exploding gas, two-thirds of the resulting contraction will be the volume of the hydrogen exploded.

7. Hydrogen and Methane by Explosion.—Methane combines with two volumes of oxygen to form carbon dioxide and water according to the following equation:

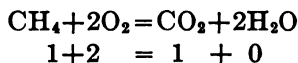

The volumetric relations are expressed by the figures of the equation, one volume of methane uniting with two of oxygen to form one volume of carbon dioxide, and two of water vapor

which condense and disappear as explained in the preceding paragraph. The result of the explosion, therefore, is that there is a contraction of two volumes for every one volume of methane and the formation of a volume of carbon dioxide equal to the methane.

It is possible to determine the proportion of hydrogen and methane present in a gas mixture by explosion with air. The volume of carbon dioxide resulting from the explosion equals the volume of the methane. The contraction due to the methane is twice the volume of the methane and the difference between this contraction in volume and the total contraction is the contraction due to the explosion of hydrogen. In accordance with the preceding section two-thirds of this contraction is hydrogen. The following example will serve as an illustration of the method of calculation.

Sample of illuminating gas.....	99.5	c.c.
Volume after absorption of CO ₂ , C _n H _{2n} , O ₂ , CO.....	85.2	
Sample for explosion.....	10.3	
Air to.....	97.6	
After explosion, volume.....	80.1	
Contraction.....	17.5	
After KOH, volume.....	74.9	
Vol. CO ₂ formed.....	5.2	
After phosphorus, volume.....	69.4	
Vol. excess oxygen.....	5.5	
Calculation 5.2 c.c. CO ₂ = 5.2 c.c. CH ₄		
Contraction due to 5.2 c.c. CH ₄ = 2 × 5.2 = 10.4		
Contraction due to hydrogen = 17.5 - 10.4 = 7.1		
Hydrogen = 2/3 × 7.1 = 4.7		
Vol. CH ₄ = 5.2		
Vol. H ₂ = 4.7		
Vol. N ₂ by diff. 0.4		
	<hr/>	
	10.3	

$$\text{Per cent. CH}_4 = 5.2 \times \frac{85.2 \times 100}{10.3 \times 99.5} = 43.1$$

$$\text{Per cent. H}_2 = 4.7 \times \frac{85.2 \times 100}{10.3 \times 99.5} = 39.0$$

$$\text{Per cent. N}_2 = 0.4 \times \frac{85.2 \times 100}{10.3 \times 99.5} = 3.3$$

The ratio of exploding to non-exploding gases in the above illustration may be calculated as follows:

$$\begin{aligned} \text{Exploding gases } 5.2 \text{ c.c. CH}_4 + 10.4 \text{ c.c. O}_2 &= 15.6 \\ 4.7 \text{ c.c. H}_2 + 2.35 \text{ c.c. O}_2 &= 7.05 \end{aligned}$$

$$\begin{array}{r} \text{Exploding gases} \qquad \qquad \qquad 22.65 \\ \text{Non-exploding gases } 97.6 - 22.65 = 74.95 \\ \hline \frac{\text{exploding gases}}{\text{non-exploding gases}} \quad \frac{22.65}{74.95} = 3.3 \end{array}$$

The excess of oxygen is calculated from the volume of air taken for explosion, = $97.6 - 10.3 = 87.3$ c.c. air with 20.9 per cent. $\text{O}_2 = 18.24$ c.c. O_2 available. Used for combustion, as above, $10.4 + 2.35 = 12.75$ c.c. Excess oxygen = $18.24 - 12.75 = 5.49$ c.c., which checks with the 5.5 c.c. found by direct experiment.

8. Carbon Monoxide, Hydrogen and Methane by Explosion.—The composition of a gas mixture containing CO , H_2 , and CH_4 may be determined by a single explosion in addition to the contraction and CO_2 the oxygen used in the explosion is also determined.

There are various methods of calculation, that given by Noyes and Shepherd¹ being as follows:

1. Gas taken $\qquad \qquad \qquad = \text{CH}_4 + \text{CO} + \text{H}_2 + \text{N}_2$
2. Contraction $\qquad \qquad \qquad = 2\text{CH}_4 + \frac{1}{2}\text{CO} + \frac{3}{2}\text{H}_2$
3. Oxygen consumed $\qquad \qquad = 2\text{CH}_4 + \frac{1}{2}\text{CO} + \frac{1}{2}\text{H}_2$
4. CO_2 formed $\qquad \qquad \qquad = \text{CH}_4 + \text{CO}$

Hence $\text{H}_2 = \text{Contraction} - \text{O}_2 \text{ consumed.}$

$$\text{CO} = \frac{2}{3} (2\text{CO}_2 + \frac{1}{2}\text{H}_2 - \text{O}_2 \text{ consumed})$$

$$\text{CH}_4 = \text{CO}_2 - \text{CO}$$

$$\text{N}_2 = \text{Total gas} - (\text{H}_2 + \text{CO} + \text{CH}_4).$$

The oxygen consumed is calculated by determining the residual oxygen and deducting this from the volume of oxygen introduced as air whose percentage of oxygen is assumed to be 20.9.

This method is more rapid than the usual one in which the CO is absorbed by Cu_2Cl_2 , and it has no systematic errors, provided the dilution is great enough to avoid oxidation of nitrogen. It will, except in expert hands, be found less reliable

¹ *J. Am. Chem. Soc.* 20, 345 (1898).

than the usual method of absorption of CO and explosion of H_2 and CH_4 because each value calculated is dependent on the accuracy of three successive operations instead of two.

9. Quiet Combustion of a Mixture of Oxygen and Combustible Gas.—Various attempts have been made to do away with the explosion pipette by causing the gas to burn gradually. Coquillion¹ in 1876 proposed to estimate small amounts of hydrocarbons in the air from mines by placing within a pipette a spiral of platinum or palladium wire. The mine air was introduced into the pipette, the spiral was to be heated to redness and, the amount of combustible gas being below the explosive ratio, the hydrocarbons were to be gradually burned. He recommended that for technical gases where there was danger of explosion the platinum spiral be placed in a small bulb blown

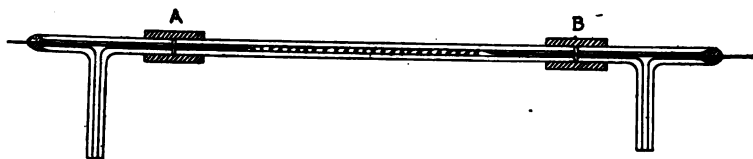

FIG. 12.—Quartz combustion tube with platinum spiral.

in the capillary tube between the burette and pipette. The mixture of gas and air was measured in the burette, and then passed through the capillary over the glowing spiral. The capillary tube was supposed to be adequate to prevent the explosion from flashing back into the burette. Hempel² has improved this latter apparatus by placing the platinum spiral in a quartz tube between two glass capillary tubes. His arrangement as modified by the author is shown in Fig. 12 where *AB* represents a tube of transparent quartz about 4 mm. internal diameter and 125 mm. long, at each end of which are glass capillary tees connected to it by rubber tubing. Through each tee runs a stout nickel wire connected by a spiral of fine platinum wire. The nickel wires are sealed into the glass capillaries by sealing wax drawn into the enlarged ends of the capillaries. The apparatus may therefore be readily repaired if the platinum

¹ *Comptes rendus*, 83, 394; 84, 458 and 1503.

² *Zeit. angewand. Chem.*, 25, 1841 (1912).

wire becomes burned out. The nickel wires should be so large that they almost fill the capillary tube which should be of about 1 mm. internal diameter. They will then not be heated perceptibly by the passage of an electric current sufficient to heat the platinum wire to redness and will by their cooling action help to prevent the explosion from flashing back into the gas burette. If the mixture of gas and air is passed slowly over the platinum spiral the temperature will not rise above a fair red heat and there will be little danger of formation of oxides of nitrogen, hence there is no need of diluting the gases with so much air as is necessary in the explosion process and therefore a larger sample of gas may be used. It is not safe, however, to take a large sample of gas and dilute it with pure oxygen, for the capillary tube cannot be relied upon to prevent an explosion flashing back into the burette when a very explosive mixture is used.

The inaccuracy of the usual explosion methods led Dennis and Hopkins¹ to devise a process of combustion whereby a large sample of gas might be quietly burned in pure oxygen. The combustion pipette consists of a pipette such as is used for phosphorus with its second bulb cut off and a levelling bottle for mercury connected. The ignition wire in the form of a platinum coil or grid is placed within the pipette immediately under the gas inlet and connected to two heavy wires which, insulated from each other, pass through the rubber stopper at the bottom of the pipette and are fastened to binding posts. The diameter and length of the platinum ignition wire must be chosen with reference to the electric circuit so that it will be easily heated to redness and its temperature controlled without the need of cumbrous rheostats. The conducting wires within the pipette may be of platinum or one of the non-rusting nickel-chromium alloys and should be at least 1 mm. in diameter.

The manipulation is as follows. The full volume of gas remaining after absorption of oxygen, consisting of CO, H₂, CH₄ and N₂ is transferred to the combustion pipette and a clamp is screwed onto the rubber connecting tube at the tip of the burette so that the pipette may be disconnected from the burette. The burette is filled with oxygen free from CO₂ and

¹ *J. Am. Chem. Soc.*, 21, 398 (1899).

of known purity and reconnected to the pipette, but the stopcock of the burette is kept closed. The levelling bottle of the pipette is placed at such a height that the gas in the pipette is under slightly diminished pressure and the electric ignition wire brought to incandescence. The stopcock on the burette is now opened and a slow stream of oxygen passed into the pipette. A slight flash is usually noticeable as ignition takes place and the platinum wire glows more brightly so that it may be necessary to interpose more resistance in the heating circuit. The volume of gas in the pipette may either increase or decrease and the height of the levelling bottle must be varied accordingly. It is usually necessary to periodically increase the external resistance to prevent the platinum wire from burning out as the hydrogen originally present gives way to water vapor. After the oxygen is all passed into the pipette, the current is interrupted, the gases allowed to cool and the CO , H_2 and CH_4 determined as in § 8.

The great advantage of this process lies in the large sample and the consequent diminution of the error of observation. It requires a special pipette, which is, however, easily constructed, a source of electric current and a controlling rheostat. The manipulation is somewhat complicated and it has been the author's experience that novices usually wish that nature had provided them with an extra pair of hands. The error due to oxidation of nitrogen has been found by the author¹ to be fully as large in this process as in the explosion process. The subject is discussed more fully in Chapter VI. Hempel² also reports unfavorably on this process on account of the formation of oxides of nitrogen when combustion is continued long enough to ensure oxidation of all the methane.

10. Fractional Combustion with Palladinised Asbestos.—The well known power of palladium to bring about the union of hydrogen and oxygen at low temperature has long been made use of as a means of separating hydrogen from methane. The use of palladinised asbestos is due to Winkler. The asbestos is prepared by soaking a small amount of selected long fibred asbestos in a concentrated solution of palladous chloride prepared according to § 7 of Chapter III. The fibers are to be kept as

¹ *J. Am. Chem. Soc.*, 23, 477 (1901).

² *Zeit. Angewand. Chem.*, 25, 1841 (1912).

nearly parallel as possible and after saturation are to be dried and ignited at a very dull red heat when the chloride will decompose leaving the fibers coated with metallic palladium and possibly palladous oxide. A bundle of two or three of these single fibers about an inch long is introduced into the end of a straight capillary glass tube about 1 mm. internal diameter and eight inches long, and brought to the middle of the capillary by suction on the opposite end of the tube. A drop of water on the asbestos makes it move more freely. The capillary is then to be dried and bent to the usual form for connecting the burette and pipette.

In manipulation 20 or 30 c.c. of gas freed from CO_2 , C_nH_{2n} and usually CO is mixed with an excess of air and passed through the capillary tube containing the palladinised asbestos into a pipette containing water. If the asbestos is very active, combustion may begin without external heat but to make certain the tube is heated with a small gas flame or alcohol lamp. It is not necessary to heat the tube to redness. A spark frequently appears at the end of the asbestos filament when the combustible gas first strikes it. This is a sign that the gas is passing too rapidly and the speed must be decreased until the spark disappears. Otherwise some methane will be burned. The gas is passed back and forth through the capillary twice and then drawn back into the burette and the volume measured. If hydrogen alone has been burned two-thirds of the contraction will be the volume of the hydrogen as explained in § 6. Carbon monoxide will burn as well as hydrogen in this process and where both were present, it will be necessary to determine the carbon dioxide formed in addition to the contraction. The calculations follow from the equations:

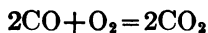

$$2 + 1 = 2$$

$$\text{Contraction} = \frac{1}{2}\text{CO} \text{ or } \frac{1}{2}\text{CO}_2$$

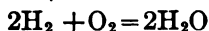

$$2 + 1 = 0$$

$$\text{Contraction} = \frac{3}{2}\text{H}_2$$

Therefore $\text{CO}_2 = \text{CO}$

$$\text{Total contraction} = \frac{1}{2}\text{CO} + \frac{3}{2}\text{H}_2$$

$$\text{H}_2 = \frac{2}{3} \left(\text{contraction} - \frac{1}{2}\text{CO} \right)$$

This method is accurate provided the palladinised asbestos is dry and active and the proper temperature is maintained. It requires care to prevent any drops of water from getting into the capillary. If this happens when the capillary is cold the thread of asbestos becomes wet and must be dried thoroughly before it is active. If a drop of water gets into the capillary while it is hot the glass tube cracks. Very little attention has been paid to the possibility of small amounts of foreign gases rendering the palladium catalyzer inactive, but from the elaborate precautions which are necessary to keep the platinum contact substance active in the sulphuric acid manufacture it is evident that this possibility should not be ignored. The capillary tube should never be heated to redness on account of danger of burning methane. The combustible gases are diluted largely with air to avoid too intense combustion and also to avoid an explosion of the main body of the gas which might be propagated through the capillary if the gas mixture were too rich. Disastrous explosions have been known to result from an attempt to burn mixtures of hydrogen and oxygen in this manner. The combined volumes of hydrogen and carbon monoxide in the sample taken for analysis should not be over 20 c.c. and the volume after dilution with air should be almost 100 c.c. This method has been investigated by Nesmjelow¹ who emphasizes the danger of burning methane if the gases are passed through the capillary at a rate faster than one liter per hour. Hempel² has recently reported the results of a study of this process and finds that to obtain accurate results the temperature of the capillary must not rise over 400° C. and that the gas must be passed at a speed of not over 100 c.c. in eight minutes. He recommends, as a method of temperature control, that the portion of the capillary to be heated rest in a brass trough which in the middle is thickened sufficiently to contain a hole deep enough for a thermometer bulb. In default of a thermometer a glass tube sealed at the bottom and containing a little mercury may be inserted in the hole. The boiling of the mercury (358° C.) indicates when a sufficiently high temperature has been reached.

¹ *Zeit. Anal. Chem.*, 48, 232 (1909).

² *Zeit. Angewandte Chem.*, 25, 1841 (1912).

11. Fractional Combustion with Copper Oxide.—The combustion of carbon compounds of all sorts through contact with hot copper oxide has been a method long employed by organic chemists. Campbell¹ first utilized the principle of fractional combustion in gas analysis and determined accurately the minimum combustion temperature for various gases both with copper oxide alone and with palladinised copper oxide. His values are as follows:

Gas	Initial combustion point	
	Pure CuO	Pd.-CuO
H ₂	175–180° C.	80–85° C.
CO.....	100–105° C.	100–105° C.
C ₂ H ₄	315–325° C.	240–250° C.
C ₂ H ₆	270–280° C.	220–230° C.
C ₄ H ₈ (Iso).....	320–330° C.	270–280° C.
CH ₄	No combustion at 455° C.	

Jaeger² first proposed a convenient scheme for utilizing this principle in ordinary gas analysis and the method usually bears his name. He takes advantage of the wide difference in the ignition point of CO and H₂ as compared with CH₄ to separate the two gases by fractional combustion. His method with some modifications which the author has found desirable is as follows:

The combustion tube shown at A in Fig. 13 is of hard Jena glass or preferably transparent quartz and has an internal diameter of about 10 mm. and a length of 200 mm. It is filled throughout its middle 100 mm. with granulated copper oxide kept in place by wads of asbestos fiber. The open ends of the tube are closed by elbows of glass capillary tubing which slip within each end of the combustion tube as far as the asbestos wads and are held in place by rubber tubing fitting tightly over the end of the combustion tube and also over the glass capillary. The asbestos shield shown in section at B and in elevation at C sits like a saddle over the middle portion of the tube and keeps the heat from the rubber connections during combustion. The combustion gases pass out the perforations shown in the top of the shield. A thermometer standing in the tube of the

¹ *Am. Chem. Jour.*, 17, 688 (1895).

² *Jour. Gasbeleucht.*, 41, 764 (1898).

shield with its bulb touching the combustion tube indicates the temperature at which hydrogen is being burned.

The whole volume of the gas from which CO_2 , C_nH_{2n} and O_2 have been removed is used for the analysis. The copper oxide tube is connected to the burette on one side and on the other to a phosphorus pipette which has been previously filled with air and now contains nitrogen. This nitrogen is allowed to flow through the combustion tube and out into the air through the burette stopcock flushing out the air in the tube and rendering

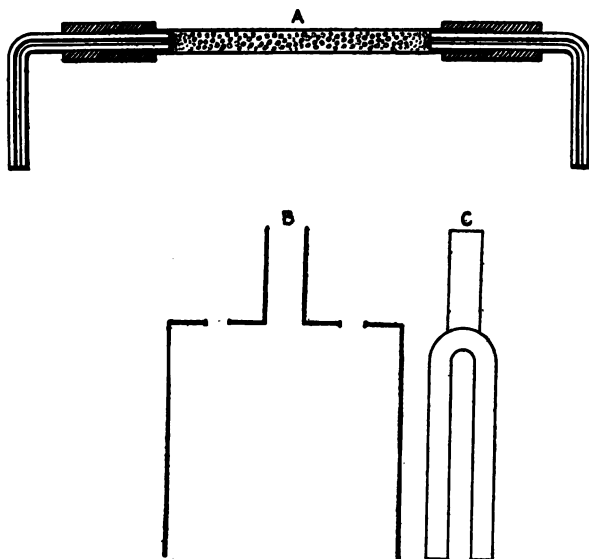
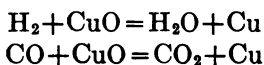

FIG. 13.—Quartz combustion tube filled with copper oxide.

unnecessary the troublesome correction involved in Jaeger's original method. The nitrogen is all driven out of the phosphorus pipette, and the water in it blown to a mark arbitrarily fixed on the capillary stem of the pipette and the burette stopcock turned so that connection with the outside air is shut off, the burette also remaining closed. The gas burner under the combustion tube is lighted and adjusted so that the thermometer inserted in the jacket and resting on the combustion tube shows about 250°C . The expanding nitrogen in the combustion tube is free to pass into the phosphorus pipette. When the

combustion tube is hot, the burette stopcock is opened and the gas passed slowly into the phosphorus pipette and back again so that it has all been exposed twice to the action of the copper oxide. A few cubic centimeters of the gas are again passed into the phosphorus pipette, the burette stopcock is closed and the flame removed. If the combustion tube is of glass it must be slowly cooled to room temperature but if it is of quartz it may be sprayed with water or wrapped with a wet cloth until it again reaches room temperature. As the tube cools there is sucked back from the pipette some of the gas purposely placed there and when it is thought that the tube has reached room temperature the liquid of the pipette is again brought to the mark in the capillary which was used at the commencement of the test. If after adjustment has been made the water of the pipette continues to rise in the capillary it is proof that the combustion tube has not yet reached room temperature.

The volume of the gas in the burette is now measured and a caustic potash pipette substituted for the phosphorus pipette. This requires somewhat careful manipulation for the combustion tube is still filled with gas which must not be allowed to diffuse into the air. To accomplish the substitution the stopcock of the burette is opened and the gas drawn out of the capillary of the phosphorus pipette into the burette until the liquid has mounted as high as the rubber connecting tube. The glass capillaries of the pipette and the combustion tube are separated enough to allow a clamp to be screwed on the rubber tube and the phosphorus pipette is disconnected and replaced by a caustic pipette whose liquid before making the connection is blown practically to the top of the capillary by the help of a rubber tube attached to the second bulb. With care this substitution of one pipette for the other may be made with an error of only a few tenths of a cubic centimeter. The carbon dioxide formed from the CO is then determined. Since it is not feasible to drive all the gas from the combustion tube into the caustic the gas should be passed back and forth several times. The method of calculation of the H₂ and CO follows from the equations:



The metallic copper has practically the same volume as the copper oxide. The CO_2 has the same volume as the CO . The H_2 completely disappears. Therefore the contraction in volume after heating to 250° is equal to the H_2 , and the CO_2 is equal to the CO .

Methane is estimated by heating the combustion tube to redness and slowly passing the gas back and forth into the caustic pipette. Methane burns somewhat slowly and it is wise to pass it back and forth at least four times. The decrease in volume is read after the combustion tube has been cooled as before. The equation for the reaction is:



If the gas had been passed back and forth into a pipette filled with water during the combustion there would have been no change in volume but since the gas was passed into the caustic pipette during the combustion process and the CO_2 was absorbed the contraction equals the methane.

It is assumed in this calculation that CH_4 is the only one of the paraffine series present. This is usually the case but natural gas, Pintsch gas, carburetted water gas and gas from coal distilled below a red heat may contain small proportions of ethane and possibly higher homologues. Pentane vapors are present in many samples of natural gas. Any two constituents such as methane and ethane may be determined by this method if during the combustion at a red heat the gases are passed back and forth into the phosphorus pipette or other pipette filled simply with water and the contraction after combustion measured and then the CO_2 determined. The calculation follows from the equations:

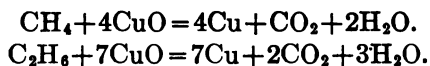

In the case of CH_4 , the volume is the same after combustion as before. In the case of C_2H_6 the volume has increased by a volume of CO_2 equal to the C_2H_6 . Any increase in volume after combustion is reported as C_2H_6 and the volume of the CO_2 less twice the C_2H_6 is reported as CH_4 .

In case pentane is present the increase of volume after com-

bustion is four volumes for each volume of pentane according to the equation—

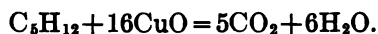

It is not usually feasible to distinguish by analysis between the various higher hydrocarbons.

The copper oxide has been partially reduced to metallic copper in the combustion and must be re-oxidized by drawing air through the red hot tube. This may be done very conveniently by means of an aspirator since no attention on the part of the analyst is required.

This method is perhaps the most accurate of the technical methods for the estimation of CO , H_2 and CH_4 and is to be commended because it does not involve any special equipment which cannot be made by the analyst himself. It is somewhat slower than the explosion methods but if a quartz tube is available it is not a tedious process. A quartz tube is highly desirable since glass tubes always break after a time and in breaking usually spoil the analysis. There is no danger of oxidation of nitrogen as in the other methods and a large sample of gas may be taken thus reducing the errors of observation to a minimum. The greatest liability to error comes from incomplete combustion of the hydrocarbons. Ethane is especially difficult to burn and it is desirable to repeat the combustion on the gas residue after the CO_2 has been absorbed to make sure that there is no further formation of CO_2 .

12. Detection of Minute Quantities of Combustible Gas.—The methods described in the preceding paragraphs have been applied in specialized and portable apparatus for the detection of small amounts of combustible gases, as for instance in the air of mines, and also for the removal of small amounts of poisonous gases, such as carbon monoxide, by gas masks. In one type of detector for mine gases, the methane is oxidized by a glowing spiral and the heat of combustion is measured by the resultant change in the temperature or resistance of the platinum spiral. In another type the moisture formed by combustion is used as the indicator. Especially sensitive forms of copper oxide and other oxides were developed during the war by the Chemical Warfare Service and

were used in special types of gas masks. The oxides were so sensitive that they were active and protected the wearer against carbon monoxide even in winter weather. The same oxides have been used in portable apparatus for the detection of carbon monoxide through the heat developed by combustion. A still more sensitive detector for carbon monoxide in air is found in a mixture of iodic anhydride with fuming sulphuric acid and pumice. The detection is based on a green color of a transitory nature produced in this mixture by minute quantities of carbon monoxide. By this means as little as one hundredth of a per cent. of carbon monoxide can be detected, and by intensity of color an approximate estimate of concentration up to 1 per cent. can be made.

13. Oxygen by Explosion or Combustion.—The volume of oxygen in a gas may be determined by explosion or combustion with an excess of hydrogen. The gas must be free from hydrogen and carbon compounds. If an excess of pure hydrogen is added and the mixture exploded or burned with a platinum spiral according to the methods given in this chapter, the oxygen may be calculated from the decrease in volume.

14. Nitrogen.—There is no desirable method for the direct determination of nitrogen, which is always taken by difference. This is very unsatisfactory since, although some of the errors in analysis may compensate each other, there is a tendency in a long analysis for them to pile up on the nitrogen.

The Jaeger method of combustion with copper oxide just described allows all of the gases other than nitrogen to be removed in a single process and affords a valuable check on the accuracy of the longer analysis. A sample of 100 c.c. of the gas to be analyzed is passed through the combustion tube at red heat and into caustic. The CO_2 , CO , H_2 , and C_nH_m will all disappear in the process as will also the oxygen if it is present in only small amount. The residue will be nitrogen and possibly oxygen which may be removed by phosphorus.

15. Form of Record of Gas Analysis.—There may of course be great variation in methods of keeping records of gas analyses. The record should in every case however be full enough to show every step of the operation. The following record is given as a sample.

ANALYSIS OF ILLUMINATING GAS

at Chemical Laboratory, University of Michigan, Sept. 9, 1917

Sample	99.4 - 0.3 = 99.1 c.c.	
After KOH	97.4	CO ₂ = 2.0 c.c. = 2.0%
After Br ₂	92.6	C ₂ H ₄ , etc., 4.8 c.c. 4.8
After P	92.2	O ₂ 0.4 c.c. 0.4
After Cu ₂ Cl ₂	84.8 - 0.3 = 84.5	CO 7.4 c.c. 7.5

First explosion:

Sample	9.4 - 0.3 = 9.1	
Air to	97.9 - 0.3 = 97.6	
After explosion	83.0	Contraction = 14.9
After KOH	79.2	CO ₂ = 3.8
After P	71.0	Excess O ₂ = 8.2

Calculations:

$$\text{Factor to give percentage} = \frac{84.5 \times 100}{9.1 \times 99.1} = 9.37$$

$$\text{CH}_4 = 3.8 \times 9.37 = 35.6\%$$

$$\text{H}_2 = \frac{2}{3}(14.9 - 2 \times 3.8)9.37 = 45.6\%$$

$$\text{N}_2 = [9.1 - (3.8 + 4.87)]9.37 = 4.0\%$$

Exploding gases:

$$3.8 \text{ c.c. CH}_4 + 7.6 \text{ c.c. O}_2 = 11.4 \text{ c.c.}$$

$$4.9 \text{ c.c. H}_2 + 2.4 \text{ c.c. O}_2 = 7.3 \text{ c.c.}$$

 18.7

Non-exploding gases:

$$97.6 - 18.7 = 78.9$$

$$\text{Ratio} \frac{\text{non-exploding}}{\text{exploding}} = \frac{78.9}{18.7} = 4.2$$

Second explosion:

Sample	9.2 - 0.3 = 8.9 c.c.	
Air to	95.0 - 0.3 = 94.7	
After explosion	80.4	Contraction 14.6
After KOH	76.7	CO ₂ 3.7
After P	70.0	Excess O ₂ 6.7

Calculations:

$$\text{Factor to give percentage} = \frac{84.5 \times 100}{8.9 \times 99.1} = 9.58$$

$$\text{CH}_4 = 3.7 \times 9.58 = 35.4\%$$

$$\text{H}_2 = \frac{2}{3}(14.6 - 2 \times 3.7)9.58 = 46.0$$

$$\text{N}_2 = [8.9 - (3.7 + 4.8)]9.58 = 3.8$$

Exploding gases:

3.7 c.c. $\text{CH}_4 + 7.4$ c.c. $\text{O}_2 = 11.1$ c.c.4.8 c.c. $\text{H}_2 + 2.4$ c.c. $\text{O}_2 = 7.2$

18.3

Non-exploding gases:

94.7 - 18.3 = 76.4

Ratio $\frac{\text{non-exploding}}{\text{exploding}} = \frac{76.4}{18.3} = 4.2$

Summary of analysis:

	I	II	Average
CO_2	2.0		2.0%
C_2H_4 , etc.,	4.8		4.8
O_2	0.4		0.4
CO	7.5		7.5
CH_4	35.6	35.4	35.5
H_2	45.6	46.0	45.8
N_2	4.0	3.8	3.9
			<hr/> 99.9%

CHAPTER V

VARIOUS TYPES OF APPARATUS FOR TECHNICAL GAS ANALYSIS

1. **Introduction.**—Chapter II describes the apparatus which the author believes best adapted to technical gas analysis and gives detailed directions for its manipulation. The present chapter will describe various other forms of technical apparatus especially those which first embodied valuable principles. The number of modifications is legion and no attempt will be made to even enumerate them. The order of description will in general be historical.

2. **Schlösing and Rolland's Apparatus.**—Perhaps the earliest

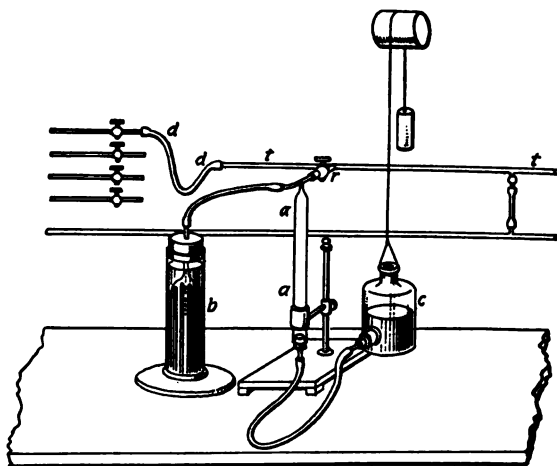

FIG. 14.—Schlösing and Rolland's apparatus.

successful attempt to devise an apparatus for the rapid analysis of industrial gas was that of Schlösing and Rolland¹ who devised a simple apparatus which foreshadowed closely the modern type. Their apparatus apparently attracted little attention

¹ *Annales de. Chim.*, Series 4, t.14, 55 (1868).

partly because its description was embodied in a long article on the ammonia-soda process whose title did not contain any reference to gas analysis. The original cut of their apparatus is reproduced as Fig. 14 as it still may serve as a model for a chemist who has to improvise his own apparatus. The following description of the apparatus is taken from the original work. In the upper left hand corner of the cut are seen four lead pipes of small diameter coming from various pieces of apparatus in the plant. A rubber tube *d* connects any one of these with the copper tube *t* to which is attached an aspirator. The burette *a* terminates at the top in a tee of almost capillary tubing, one arm of which connects to the gas supply through the cock *r* and the other to the pipette *b*. No mention is made of a clamp on the rubber tube between *a* and *b* but necessarily such must have been used. To draw a sample of gas the cock *r* is opened and the levelling bottle *c* is raised until the water fills the burette and reaches *r*. The gas formerly in the burette is now in the pipe *t* out of which it is swept by the stream of gas which is constantly flowing. The bottle is then lowered until the gas has passed below the 100 mark. The aspirator is stopped, the rubber tube *d* disconnected and the bottle raised, *r* being again opened until the level of the water in the burette is at 100 and is at the same time coincident with the level of the water in the levelling bottle. The burette will then contain 100 volumes of gas at atmospheric pressure. The gas is then passed back and forth into the absorption pipette *b* filled with caustic potash and containing glass tubes to increase the absorptive surface. The volume in the burette is then read as before and the decrease in volume reported as CO₂.

3. Orsat's Apparatus.—The original form of the Orsat¹ apparatus is practically the same as that frequently used today, as will be seen by Fig. 15 which is a reproduction of the original cut. It consists of a water-jacketed gas burette terminated at its upper end by a branched glass capillary tube. The pipettes, in order from right to left, contain caustic potash, alkaline pyrogallate and cuprous chloride. The cock I on the branched capillary serves for the connection of a platinum capillary in which hydrocarbons mixed with air, and added hydrogen if necessary, may be burned. The sample of gas is brought to the burette by the water-aspira-

¹ *Annales des Mines*, Series 7, t.8, 485 (1875).

tor KLM which sucks a rapid stream of gas through the cock R and the dust filter P. The operation of the apparatus will be evident to anyone who has read the three preceding chapters.

Many modifications of this burette have been proposed since it was first described, but the principle has not been altered. One group of workers has increased the complexity of the apparatus in an attempt to increase speed of manipulation. The most noteworthy change of this sort is probably the introduction of the

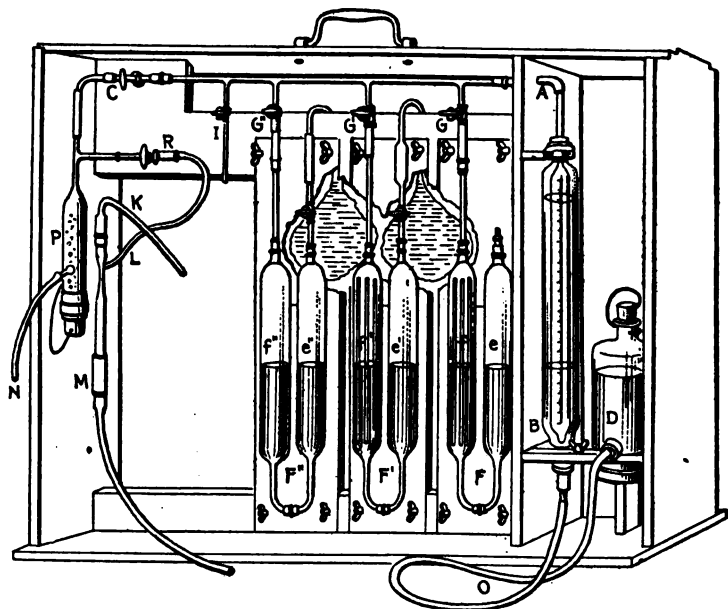

FIG. 15.—Orsat apparatus. Original form.

bubbling pipette in which, by a three-way cock on the top of each pipette, the gas is made to pass down a central tube and bubble up through the liquid of the pipette to be later drawn from the top of the pipette when the three-way cock is thrown to its second position. There are decided objections to complication in any form of apparatus which may receive rough treatment in transportation and which is frequently handled carelessly by its operators.

The usual modifications of the Orsat apparatus possess at least four glass stopcocks on the various outlets of the branched tee.

Unless the apparatus is always manipulated by a skilled operator it is almost inevitable that some of the alkaline reagent from the pipettes will be drawn into these stopcocks. It is apparently equally inevitable that the cocks will as a consequence stick and become broken. The branched tee is itself a source of trouble since it is fragile and difficult to clean when stopped. In Fig. 16 is shown a modification of the Orsat apparatus due to Allen and

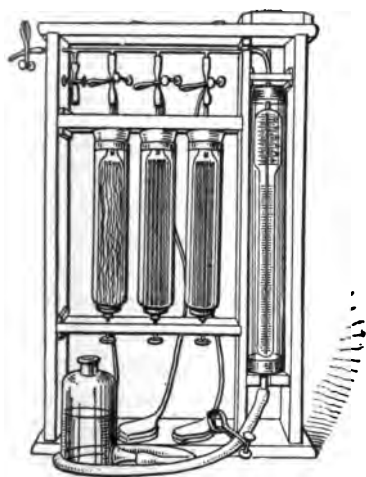

Fig. 16.—Orsat apparatus. Allen-Moyer modification.

Moyer which commends itself for its simplicity and durability. The capillary glass tube is replaced by one of hard rubber and the glass stopcocks are replaced by pinchcocks which are practically as satisfactory. The pipettes themselves are of the test tube type and are closed at the top with a soft rubber stopper which is pressed against the upper shelf by the screw which supports the cup in which each pipette rests. This gives a firm and yet elastic support for the pipettes which prevents breakage in shipment.

The method of operating all Orsat burettes is the same. The water of the burette should be saturated with gas similar to that which is to be analyzed. The gas is taken into the burette through the end of the capillary projecting out of the left hand side of the case. If the sample is drawn directly from the smoke flue the precautions given in Chapter I on Sampling must be observed. In any case the burette is filled with gas which is then wasted through the fourth side arm into the outside air, thus getting rid of the air which was in the capillary tube of the instrument. The sample of gas is now drawn into the burette and measured with the precautions given in Chapter I. In addition to the gas which is in the burette there is a volume of about 1 c.c. in the capillary tube which is entirely neglected. The gas is passed into the caustic pipette and CO_2 determined

as described in § 1 of Chapter III, then into the second pipette filled with pyrogallate for oxygen (§ 4 of Chapter III), then into the third pipette filled with cuprous chloride for CO (§ 6 of Chapter III).

This apparatus is much used for analysis of smoke gases and it is sufficiently accurate for this purpose. The errors which arise from the failure of the gas in the capillary to come into contact with the reagent will hardly be more than 0.1 c.c. for each of the gases. The tendency will be for the oxygen to be slightly high due to some CO₂ which did not get into the caustic pipette and for the CO to be high due to oxygen which did not get into the pyrogallate pipette.

The Orsat apparatus is not usually employed for gases like illuminating gas where many constituents have to be determined, although other absorption pipettes and even explosion pipettes have sometimes been made a part of the instrument. The errors mentioned above due to the gas remaining in the capillary increase with the length of the capillary and it becomes preferable to use the burette with detachable pipettes.

4. Bunte's Burette.—Dr. H. Bunte¹ in 1877 described his burette which although in the main obsolete still has some uses and is illustrated in Fig. 17. It consists of a burette closed at the top by a three way cock *a* carrying a funnel tube, and at the bottom by a cock *b*. The zero of the burette is somewhat above the lower cock.

A levelling bottle such as is used with the ordinary Hempel type of gas burette is to be connected to the lower cock. The sample of gas is drawn into the burette as usual and its volume may be read as usual. The method of reading the volume prescribed by Bunte is unusual. A sample of gas slightly larger than 100 c.c. is to be taken into the burette and the volume compressed until it reads exactly 100. Water is now poured into the funnel tube to the mark *m* etched upon it and cock *a* is opened to communicate with the funnel tube which is unstoppered. Some gas bubbles through the cock and the liquid above it and escapes into the air. The bore of the cock is so small that no water flows down and after the bubbling has ceased the volume of gas in the burette is still 100 c.c. measured under the pressure

¹ *Jour. für Gasbel.*, 1877, 447.

of the atmosphere plus the column of water in the funnel tube. The volume of the gas is always to be read under these conditions. In order to introduce an absorbent such as NaOH into the burette a partial vacuum is produced by opening the lower cock and lowering the levelling bottle. The cock *b* is then closed, the levelling bottle disconnected and the reagent in a small dish is placed below the cock *b* so that the tip of the cock is immersed. On opening the cock some of the reagent will be sucked into the burette. The burette is then shaken to facilitate absorption, care being taken to hold it only by the tips so that the heat of the hands will not change the temperature of the gas. To read, the volume after absorption the funnel tube on the top of the burette is again filled with water, and the upper cock opened. Water flows into the burette and more water is added to the funnel until with the upper cock still open the water remains stationary on the mark *m*. Conditions are now as they were at the first reading and the volume is again read. The diminution in volume if NaOH was the reagent, is as usual reported as CO₂.

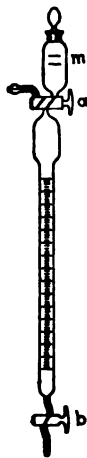

FIG. 17.—
Bunte gas
burette.

Oxygen is determined by alkaline pyrogallate (§ 4 of Chapter III). To avoid diluting the reagent the dilute caustic in the burette is sucked out as far, as possible and 20 c.c. of the pyrogallate introduced.

The burette is shaken at intervals for five minutes and then rinsed with fresh water introduced through the funnel tube, the pyrogallate being allowed to flow out of the lower stopcock. As soon as the walls of the burette are rinsed clean the bottom stopcock is closed and the volume read as before with the top stopcock open and the funnel tube filled with water.

Carbon monoxide is absorbed by acid cuprous chloride as usual (§ 6 of Chapter III), but a very considerable amount of preliminary manipulation is necessary. The alkaline pyrogallate must be thoroughly washed out by water flowing through the burette and then replaced by HCl sp. gr. 1.12. When this has been done the Cu₂Cl₂ reagent may be added and after the absorption the volume measured with the funnel tube filled with dilute HCl.

The only advantage which a burette of this type can claim is its portability. Its manipulation is cumbrous, the introduction of the large volumes of wash water changes the composition of the gas, and the temperature of the burette, which is usually not jacketed, is almost certain to change unless very unusual precautions are observed to keep it from contact with the hands of the operator and to have the temperature of the reagent and wash water the same as that of the room where the operation is being carried on. The Orsat apparatus is preferable for almost all purposes.

5. Chollar Tubes.—Mr. B. E. Chollar¹ in 1888 modified

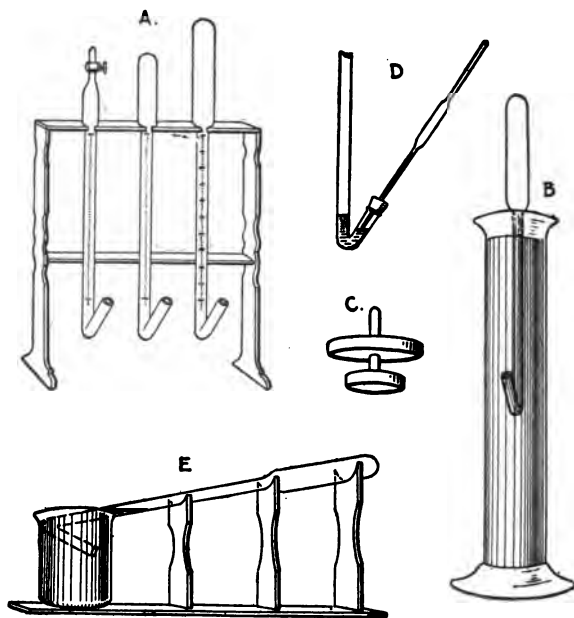

FIG. 18.—Chollar tubes for gas analysis.

Cooper's eudiometer and produced a very practical and simple combination burette and pipette. In Fig. 18 at A are seen three of the Chollar tubes in a rack. The zero point is the top of the bulb and the graduations start at the bottom of the bulb and extend down to the bend in the tube. The bulbous portion may

¹ *Proc. Western Gas Association*, 1893, 219.

occupy varying proportions of the total volume and since it is not graduated a tube must be chosen proportioned properly for the analysis to be made. Of the three burettes shown at A, that on the right is called a 10 per cent. burette because the graduations cover only 10 per cent. of the total volume. The middle burette is a 25 per cent. burette, and the burette on the left is a 50 per cent. burette, provided also with an upper stop-cock which is convenient, but not necessary for all the forms.

It is assumed that a plentiful supply of gas for analysis is available and that it is under pressure. A rubber tube is slipped into the burette round the bend and up to the top through which gas is blown until the air is displaced. It is safer to fill the tube with water and displace this with the gas. The rubber tube slips into the burette more readily if it is wet. When the burette is completely filled with gas it is immersed in the cylinder of water B far enough to seal the outlet and the rubber tube is withdrawn. The burette is now pressed completely under the water and kept there by the weighted cover C for a few minutes until the gas has attained the temperature of the water which should be at room temperature. The top of the burette is then grasped by the tip of the fingers to avoid warming the gas and the burette is raised until the meniscus inside of the burette coincides with the surface of the water in the glass cylinder when the gas volume is read at atmospheric pressure. In case the volume of the gas has increased through expansion so that the meniscus is below the graduations a portion of the gas must be removed by closing the lower end of the burette with the thumb while it is still under water and then by raising and tilting the burette causing a few bubbles to pass into the short arm from which they escape into the air when the thumb is removed.

To introduce reagents, a portion of the water is sucked from the short arm of the burette by a pipette as shown at D. Sufficient water must of course be left to seal the burette. Sufficient reagent such as caustic soda is then introduced to completely fill the short arm which is tightly closed by a rubber stopper or the thumb. The burette is then inverted and shaken until absorption is believed to be complete. The gas which may have gotten into the short arm is now worked back into the body of the burette by turning the burette almost horizontal and the

burette is again immersed in the large cylinder. The rubber stopper is removed after the outlet is sealed with water, water enters to replace the gas absorbed and the volume of the gas is read as at first.

The usual reagents for carbon dioxide, unsaturated hydrocarbons, oxygen and carbon monoxide may be used. A solution of arsenious oxide is recommended for hydrogen sulphide.

To wash out one reagent before adding another the burette is placed on the stand shown at E in Fig. 18 with its open arm pointing down in a beaker of water. The reagent being heavier than water tends to flow out. The washing may be accelerated by passing water into the burette through a rubber tube. The instrument is very readily portable and after a little experience results of considerable accuracy may be rapidly obtained.

6. Instruments for Recording Carbon Dioxide in Flue Gases.—

There are a number of commercial instruments on the market which aim to make a continuous record of the percentage of carbon dioxide in stack gases. These instruments usually derive their motive power from an aspirator which sucks a sample of flue gas through a dust filter and then through the analyzing mechanism. Most of these mechanisms imitate the action of the analyst when he sucks in a buretteful of gas, passes it into caustic solution and then measures the decrease in volume. In the machine the filtered gas is made to exactly fill one measuring chamber, then passed into caustic and then into a second chamber where its volume is measured by the height to which it raises a small gas holder or by some other mechanical means. A pen attached to the gas holder indicates on a chart the height of the gas holder and, if the chart and instrument are correctly adjusted, it records directly the percentage of carbon dioxide. Machines of the above type give intermittent readings. The Uehling carbon dioxide machine operates continuously and without measuring chambers. It measures the percentage of carbon dioxide by recording the difference in suction caused by the diminution in volume of the gas after removal of the carbon dioxide by caustic. Two standard diaphragms are inserted in the line through which the gas flows and the dry caustic absorption cylinder and the recording manometer are placed between them. With air flowing through the apparatus a certain suction will be registered.

With gases containing carbon dioxide a higher suction will be registered because of the smaller volume of gas passing the second diaphragm. A detailed description of several of these instruments together with results of tests on them has been made by the Bureau of Mines.¹ Some of them work very well but it must be remembered that none of them are fool proof and that all of them require rather frequent and expert adjustment.

7. Methods of Gas Analysis Depending upon Thermal Conductivity.—This method depends on the difference in thermal conductivity of different gases. A carefully calibrated platinum wire is heated with a constant electric current. The gas to be tested is then made to flow through the tube containing the wire and the difference of the resistance of the hot wire is measured. If the gases have not reacted with each other or been subjected to chemical change under the influence of the hot wire, this measurement allows the calculation of the heat conductivity of the gas, and in case only two constituents are present it permits the proportions of each to be calculated. By the use of a series of conductivity tubes with proper absorbents or oxidizing apparatus between them a continuous test may be made of the composition of gases with a number of different constituents. The apparatus may be made recording. It is largely one of the developments of the Bureau of Standards for war needs² and is hardly yet a technical instrument for general purposes.

8. Gas Analysis by Optical Methods.—The refraction of a beam of light passing through a gas is in general proportional to the density of the gas. While the differences in the index of refraction are small they may, with rather complicated apparatus, be accurately measured. The method is most readily applicable where there are only two constituents in a gas mixture. An instrument called the interferometer or refractometer has been devised for this work but it is to be regarded more as a scientific instrument than one for technical use, although Burrell and Seibert³ state that the instrument may be successfully used for technical analysis of the following: mine air for carbon dioxide and methane; manufactured hydrogen, chlorine and other gases for purity; illuminating gas for benzol, and flue gases for carbon dioxide. Edwards⁴ has published a critical review of the application of the interferometer to gas analysis.

¹ J. F. Barkley and S. B. Flagg. Instruments for Recording Carbon Dioxide in Flue Gases. Bulletin 91. Bureau of Mines, 1916.

² Weaver and others, *Jour. Ind. and Eng. Chem.* 1920.

³ *Bul.* 42, Bureau of Mines.

⁴ *Technologic Paper No. 121*, Bureau of Standards, 1910.

CHAPTER VI

EXACT GAS ANALYSIS

1. Historical.—Lavoisier in his *Traité Elementaire de Chemie* published in 1789 devoted Chapter II of Book III to Gasometry or "The Measurement of Weight and Volume of Gaseous Substances." He described eudiometers, a gasometer of the bell jar type, and methods of separation of certain gases by absorption and explosion as well as the mathematical method of making correction for temperature and pressure.

Bunsen and Playfair¹ in a paper "On the Gases Evolved from Iron Furnaces" presented in 1845 what was perhaps the first serious attempt to develop methods of gas analysis for technical investigation. The methods published in this paper formed the basis of Bunsen's classic book "*Gasometrische Methoden*" published in 1857. Bunsen used a graduated cylindrical eudiometer inverted over a trough of mercury both for measuring the volume of the gas and for carrying out analysis by absorption and explosion. It was necessary to determine the temperature and pressure of the gas when each reading of volume was made and to make arithmetical corrections to bring the volume to standard conditions. It was possible to work accurately with his apparatus but it has been replaced by simpler forms which allow more rapid work.

Regnault and Reiset² in a paper on the respiration of animals developed a eudiometer which was capable of accurate work but was very cumbersome.

Doyere in 1848³ exhibited before the French Academy of Sciences apparatus for gas exact analysis and two years later⁴ presented details of the remarkably complete and ingenious apparatus which he had devised. He used a separate pipette

¹ *British Ass. for Advancement of Science*, 1845, 142.

² *Ann. de Chim. et de Phys.* (3), 26, 299 (1849).

³ *Comptes rendus de l'Academie de Science*, Feb., 1848.

⁴ *Annales de Chimie*, 3 Series, 28, 5, (1850).

for each reagent, measured his gases saturated with moisture instead of dry, and by means of a mechanical compensator avoided all corrections for change in gas volume due to temperature and pressure. He absorbed carbon dioxide by caustic potash and estimated oxygen by explosion or by absorption with ammoniacal cuprous chloride, two pipettes being used in series followed by a third containing dilute sulphuric acid. He also studied the estimation of hydrogen by explosion.

W. Hempel in the second edition of his *Gas Analysis* (1889) described a modification of Doyere's method in which he measured the gas volume in a bulb, varying the pressure of the gas at each reading so that its volume always filled the bulb to a definite mark. The pressure under which the gas stood was then measured and correction mathematically made to find the volume under standard conditions.

2. General Methods.—These earlier processes with their complications were necessitated by the imperfections of apparatus, especially stopcocks which could not be relied on to be gas-tight. With the development of reliable stopcocks came the development of apparatus so that now there is little need to use any of these older processes. The methods of exact gas analysis are now in general the same as those employed in technical analysis but with greater attention paid to the elimination of minor errors. The gas burette is graduated more accurately and an attempt is made to read to hundredths of a cubic centimeter instead of tenths. Correction is made either arithmetically or mechanically for variations in temperature and pressure of the gas during analysis. Mercury is used instead of water as the confining liquid in the burette and errors due to diffusion in the pipette are prevented. Special methods are sometimes introduced for the estimation of minute constituents of the gas.

3. Corrections for Temperature and Pressure.—According to the law of Boyle the volume of any gas varies inversely as the pressure and according to the law of Gay Lussac all gases expand under constant pressure by the same amount—about $1/273$ of their volume—when heated from 0°C. to 1°C. , and the same for each succeeding degree. The volume of a gas is almost universally expressed in scientific work as that which it would occupy

if completely dry and at a temperature of 0° C., and a pressure of 760 mm. of mercury. For technical purposes the gas is frequently calculated to the volume which it would have at 60° F. and 30 in. of mercury pressure when saturated with water. The formulæ for this calculation are given in § 4 of Chapter VII on the Heating Value of Gas.

The formula for the reduction of the volume of a dry gas to 0° and 760 mm. dry follows from the laws stated.

$$V_0 = \frac{V}{\left(1 - \frac{t}{273}\right)} \frac{p}{760} \text{ or } V_0 = \frac{Vp}{(1 - .00367t)760}$$

If the gas as measured was saturated with moisture at say 60° F. and it should actually be chilled to 0° C. most but not all of the water would be condensed. It is usual in calculations to assume either that the gas becomes completely dried which is the usual assumption or that the water all remains in the vapor state which is less frequently assumed. The formula given above will be the one used in the latter case where the water vapor is assumed to obey the gas laws without condensing, just as nitrogen or hydrogen would.

If the gas is to be reduced to standard conditions, dry, the volume of the water vapor must be deducted. Since the assumption is that the gas is saturated with moisture at the temperature "t" the proportion of moisture will be a constant which may be expressed either in terms of volume or more conveniently in terms of barometric pressure. Table I in the Appendix gives the vapor pressure of water, "a," for each 1° C. within the limits usually required. The formula for reduction of the volume of a gas read when saturated with moisture, to its volume when dry at 0° C. and 760 mm. is therefore as follows:

$$V_0 = \frac{V(p-a)}{(1 - .00367t)760}$$

If the readings are in the Fahrenheit scale and in inches of barometric pressure the formula becomes

$$V_{32} = \frac{V(p-a)}{\left(1 - \frac{t-32}{491} \cdot 30\right)}$$

4. Description of Gas Burettes.—The burette for technical analysis does not allow an accuracy greater than 0.1 c.c. and the probable error is more nearly 0.2 c.c. The errors are in part due to the coarse graduations of the cylindrical burette tube and in part to liability to change in the temperature and pressure under which the gas volume is read. A device for automatically correcting for change in temperature and barometric pressure was devised by Petterson¹ in an apparatus for the analysis of air. This was quickly adapted by Hempel to his gas burette and as used by him consisted of a closed tube connected to one arm of a manometer whose other end connected with one tip of a three-way cock at the top of the burette. The volume of the gas instead of being read at a changeable atmospheric pressure was to be read at the unchanging pressure in the closed compensating tube. The modification of this type of apparatus developed by the author² is shown in Fig. 19.

The burette has a specially bored stopcock as shown in the sketch which allows communication to be established through the stopcock between the burette and the compensating tube. The latter consists of a U tube manometer shown in A of Fig. 19 connected to the burette by a single rubber connection at *a*, placed so that gas never comes in contact with the rubber and there can be no possibility of leakage—a fault of the Hempel type of apparatus. The other end of the U tube bends down and terminates in a tube about the same diameter as the burette and

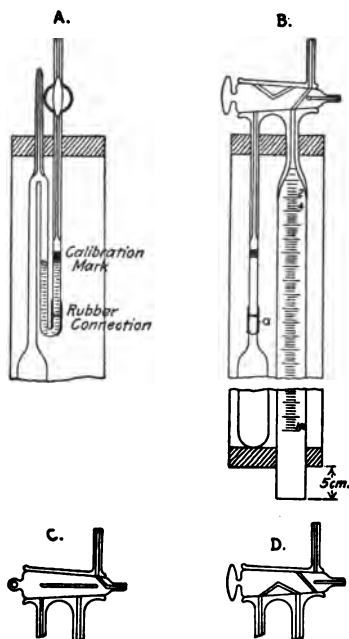

FIG. 19.—Details of gas burette with automatic compensator for temperature and pressure.

¹ *Zeit. anal. Chem.*, 25, 467 (1886).

² *Jour. Am. Chem. Soc.*, 22, 343 (1900).

sealed at the bottom. At the top of the U is a capillary tip which in practice is fused shut as explained later.

In mounting the burette which is assumed to be clean and entirely taken apart the manometer is connected to the burette at *a* by a piece of good black rubber tubing wired in place, and the large rubber stopper at the lower end of the burette is pushed up until it rests snugly against the bottom of the comparison tube and presses the glass parts at *a* firmly together within the rubber tube. The glass water jacket tube is then slipped over the top of the burette and onto the lower rubber stopper and the upper split cork fitted into place. The burette is then placed in a stand such as is shown in Fig. 21. The levelling bottle is also connected to the burette as in technical analysis with the added precaution of wiring the rubber stopper into the burette so that it may not be blown out through the weight of the mercury column. The process of wiring in a rubber stopper is simple but since beginners are sometimes at a loss to accomplish it the following description is given. A piece of rubber tubing is first slipped over the bottom of the burette to give a soft surface for the wire to grip. A piece of copper wire about 18 gage is annealed by passing several times through the flame of a Bunsen burner and a piece about 4 in. long is twisted in the middle of one about 8 in. long to form a T. The longer piece is then bent around the burette and twisted till it fits snugly. Its two ends are now brought over the rubber stopper and twisted with the free end of the 4-in. piece of wire until the cork is firmly pressed in.

To prepare the comparison tube for use, a few drops of water are to be brought into its lower portion to saturate the air it contains, the manometer is to be filled with mercury and the capillary tip is to be fused shut. The two first operations can be conveniently accomplished in one operation. The burette is filled with mercury on whose surface are a few drops of water. By turning the stopcock to the position shown at D of Fig. 19, the water with the mercury following it may be passed through the stopcock and the U tube and over into the comparison tube. The progress of the mercury is to be arrested when the water has trickled down the comparison tube and the mercury is to be drawn back until there is just enough left in the U tube to fill it approximately to the calibration mark when there is atmospheric

pressure on both limbs of the U as shown in Fig. 19 at A. This may be readily accomplished after one or two trials. The capillary tip of the comparison tube is now to be sealed with a blow pipe and the burette is ready for use.

This burette has the advantage over the usual technical type that its readings are unaffected by variations in external temperature and pressure, but the volumes themselves cannot be read more accurately than with the technical type unless a reading telescope is employed. Even with this aid to the eye the results are not always certain for the presence of a few drops of water on the mercury alters the shape and boundaries of the meniscus.

5. The Bulbed Gas Burette for Exact Analysis.—The idea of converting the burette into a string of bulbs connected to a side arm burette apparently originated with Bleier.¹

The author has utilized this suggestion in the design of the burette shown schematically in Fig. 20, and in perspective in Fig. 21; it consists of a burette with stopcock and manometer as already described. The main body of the burette contains twelve bulbs, each of a capacity approximating 12 c.c. A line is etched on each constriction and the capacity of the bulb between these marks is determined. Starting from the capillary above the top bulb a side arm springs, terminating in a small burette with total capacity of 15 c.c. and graduated in 0.1 c.c. Both these burette tubes connect at the bottom by means of heavy rubber tubes and a Y with a stopcock on each arm, to a common levelling bottle. A screw clamp on each rubber tube serves for the exact adjustment of the mercury. To measure a gas, the stopcock is placed in position shown at C of Fig. 19 and the mercury in the bulbed tube brought to the mark in one of the constricted portions by opening the proper stopcock on the Y and raising or lowering the levelling bottle. When adjusted, the mercury is held in its proper position by closing the stopcock on the Y. The stopcock leading to the small burette tube is then opened and the gas brought to approximately atmospheric pressure by proper change in the mercury level. The three-way stopcock at the top of the burette tube being now turned to position shown at D in Fig. 19, the burette is brought into connection with the manometer, which is properly set by further

¹*Ber. d. Chem. Ges.*, 31, 1, 238.

changing the level of the mercury in the small burette. The final adjustment in both burettes is made by the screw clamps on the rubber tubes.

When the gas burette is used in the manner indicated the gas volume is read under conditions which are constant but not necessarily known. It is not usually necessary in gas analysis

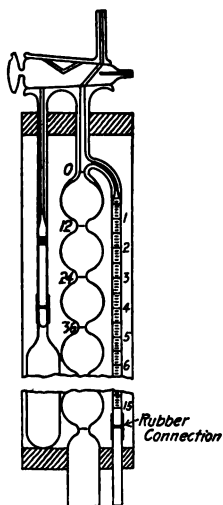

FIG. 20.—Details of bulbed gas burette for exact gas analysis.

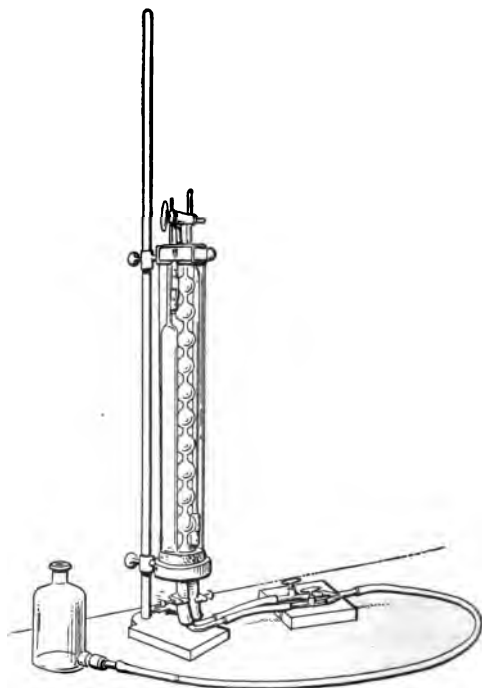

FIG. 21.—Burette for exact gas analysis.

to know the absolute value of a gas but it may be obtained if the temperature and barometric pressure are noted at the time the tip of the manometer tube is sealed. The volume of the gas is to be read when the level of the mercury in the two arms of the manometer is the same. The gas has then the same volume which it would have had at the temperature and pressure prevailing when the manometer was sealed. Correction to standard con-

ditions may be made mathematically as indicated in a preceding paragraph. This procedure for reading the gas volume is not as accurate as the one recommended for gas analysis where the mercury is brought tangent to the rim of a metal sleeve but it is amply accurate for most purposes.

6. Manipulation of Gas Burette for Exact Analysis.—It is necessary to discharge from the burette all of the residual gas including that in the manometer tube. This may be accomplished by discharging most of the gas from the burette into the air and then by turning the stopcock and lowering the levelling bottle, drawing into the burette the gas from the manometer until the mercury of the U tube is just at the stopcock. The gas in the burette may then be discharged into the air. If there is danger that alkali has been introduced into the burette in a previous operation it is advisable to draw into the burette a few cubic centimeters of acidulated water and with it rinse down the walls of the entire burette, subsequently expelling it. This also makes certain that the walls of the burette are wet so that the gas to be subsequently introduced will become saturated with water.

The gas is then introduced into the burette as in technical analysis. If a volume of approximately one hundred cubic centimeters are wanted, nine bulbs are filled with gas at atmospheric pressure. The stopcock at the top of the burette is then closed and the gas compressed into eight bulbs. Up to this time the side arm of the burette has remained filled with mercury. The stopcock on the Y is now opened and part of the gas transferred to the side arm until the whole is again under atmospheric pressure as shown by the agreement of the level of the mercury in the levelling bottle held in the hand of the operator, with the level of the mercury in the side arm. The stopcock on the Y is now to be closed and that at the top of the burette is to be turned to make communication with the manometer, the mercury in which drops at once to approximately its proper position. By using the clamps on the rubber tubes as fine adjustments the meniscus in the bulbed tube is to be brought tangent to the mark between two bulbs and also the meniscus in the manometer is to be made tangent to the metal sleeve.

The volume of the gas will be read as x c.c. in the bulbs + y

c.c. in side burette + z c.c. in manometer. As there are these three readings to be made it is necessary that each be very accurate. Let us see how accurately this may be done. First, the mercury in the bulbed tube is to be brought to a specified mark in a tube of about 5 mm. internal diameter. By means of the screw clamp this may be done with such accuracy that the error is negligible. Second, the volume of gas in the side tube must be read. Each 0.1 c.c. in this tube occupies a space of a little over 2.5 mm. and it is possible to interpolate 0.01 c.c. with the eye with an error of less than 0.02 c.c. Third, the mercury in the manometer must be brought to a definite mark with such exactness that the barometric pressure, under which the gas volume is read, shall be almost identical each time. A difference of 1 mm. of mercury pressure changes the gas volume 0.13 per cent., which on a volume of 100 c.c. equals 0.13 c.c., an error far too large. It was found impracticable to attain the required accuracy when it was attempted to bring the mercury to a mark etched on the glass. The best device was found to be a band of thin, blackened copper, wrapped around the tube and cemented to the glass. It is possible to bring the mercury tangent to the lower surface of this with great exactness. In working with this burette the author is accustomed to make all readings in duplicate, readjusting at all points each time, and to repeat if the two differ from each other by more than 0.01 c.c. Duplicates usually agree within this limit. The greatest difficulty found in manipulation is to draw the liquid from the pipette over exactly to the burette stopcock and stop it there. If it gets into the burette, a bubble lodging in one of the capillary tubes frequently damps the sensitiveness of the manometer. If this happens the bubble may be shot out of its lodging place by compressing the rubber tube above the screw clamp with the fingers. Such a bubble may also be carried into the manometer, where it will obscure the surface of the meniscus. To remedy this it is well to keep 2 or 3 mm. of water on the surface of the mercury in the manometer. This allows a perfectly sharp reading of the mercury meniscus below the water-level. The manometer should respond to a very slight movement of the screw clamp.

The advantages of this burette may be summarized as follows: It is a compact burette which, without reading-telescope or other

accessories, allows the volume to be read with an error of less than 0.02 c.c., compensates automatically for changes of temperature and pressure, and avoids completely all errors due to inclusion of air or loss of gas in making connections with the absorption pipettes. The disadvantages so far developed are chiefly those inherent in all forms of apparatus which possess a stopcock and rubber connections. Both may leak; but on the other hand both may be kept so tight for limited periods of time as to introduce no measurable error.

7. Calibration of Burette.—The burette must be carefully calibrated throughout its entire length. This can best be done by weighing the mercury discharged. One cubic centimeter of mercury at 0° C. weighs 13.59 gm. Since all that is desired is a relative calibration the mercury need not be strictly pure nor need correction be made for its temperature. Ten milligrams, of mercury corresponds to less than one-thousandth of a cubic centimeter so greater accuracy than this in weighing is a waste of time. Wire a stopper carrying a stopcock into the bulbed tube and fasten by a stiff rubber tube a stopcock to the side arm. It is especially important that the rubber tubing should not bulge under the mercury pressure and to prevent this it should be firmly wound with wire. Connect the tips of these stopcocks to the mercury levelling bottle and through them fill the burette with mercury completely to the stopcock. The portion first calibrated is the capillary tube from the bottom of the stopcock to the zero of the bulbed tube and the zero of the side arm. After that each bulb and each cubic centimeter of the side arm is separately calibrated. The accuracy of the calibration may be checked by the procedure of a regular analysis where a volume of gas is chosen such that it for instance fills 9 bulbs and a small portion of the side arm. The method of reading may then be changed to eight bulbs plus a considerable volume in the side arm but if the calibration is correct the same volume should, of course, be shown. The volume of the small portion of the manometer tube above the mercury may best be determined by filling the burette completely with mercury and then drawing the air out of the manometer tube into the side arm of the burette where it may be measured under atmospheric pressure with an error of a few tenths of a per

cent. Since the total volume is only a small fraction of a cubic centimeter the method is amply accurate.

8. Absorption Methods in Exact Gas Analysis—The same reagents may in general be used in exact as in technical analysis. Care should however be taken to see that the reagent has been recently saturated with gas of a sort similar to that which is to be analyzed. In case the reagent is one which does not attack mercury the pipette is to be filled with mercury which carries on its surface only a few cubic centimeters of the reagent. If pipettes of the ordinary type are filled with mercury the mercury rising in the second bulb places the gas under considerable pressure and greatly increases the danger of leakage at the rubber connections. An explosion pipette may with advantage be used as an absorption pipette under these circumstances since its stopcock and levelling bottle allow a regulation of the pressure within the pipette. Where the greatest accuracy is not required it is sufficient to lessen the errors due to diffusion by introducing a few cubic centimeters of mercury to form a seal in the ordinary form of pipette. In the case of solutions like cuprous chloride where mercury cannot be used reliance must be placed on the complete saturation of the reagent. Where gases are readily soluble errors due to diffusion mount up rapidly. For instance: A sample of 74 c.c. of acetylene gas when passed into an ordinary NaOH pipette as used in technical gas analysis decreased to 63.9 after quietly standing for three minutes, to 58.0 after a second contact, and to 29.0 c.c. after three minutes shaking with the same reagent. After two more similar periods the residue left in the burette was only 5.2 c.c. A second sample of gas behaved similarly, and by connecting a burette with the second bulb of the pipette the acetylene diffusing through was recovered quantitatively.

9. Carbon Dioxide.—Carbon dioxide is usually estimated by absorption in caustic soda as in technical analysis. If other acid gases such as H_2S , SO_2 , or HCl are present they may be removed by first shaking the gas in a pipette containing $KMnO_4$ very faintly acidified with H_2SO_4 . An increase in volume after this operation would indicate that oxygen had been evolved during the process. If direct evidence of the presence of CO_2 is desired a clear solution of $Ba(OH)_2$ should be used instead of NaOH in the pipette for CO_2 absorption. The formation of a

white precipitate completely soluble in HCl will show the presence of carbonates.

10. Unsaturated Hydrocarbons.—Unsaturated hydrocarbons as a class are estimated as in technical gas analysis by absorption with fuming sulphuric acid or bromine water. It is difficult to prevent the errors due to diffusion mentioned in § 8 since both reagents attack mercury. Where it is desirable to eliminate the error as far as possible a stopcock may be placed in the line between the two bulbs of the pipette which can be closed after the gas has been passed into the pipette while absorption is taking place.

A separation of the constituent unsaturated hydrocarbons is rarely carried out. It is best accomplished by bubbling a known volume of the gas through bromine and fractionating the resulting bromides. The results are at best unsatisfactory. Ernshaw¹ has shown that it is possible to calculate the average composition of the illuminants from data obtained by exploding a sample of the gas which still contains the olefines and deducting from the observed contraction and carbon dioxide the amounts due to hydrogen, carbon monoxide and the paraffines. The method demands very accurate work.

Acetylene may be absorbed in a faintly ammoniacal solution of silver or copper salts. The precipitated acetylides are explosive and care should be taken in handling them. The ammonia vapors are to be removed from the gas by shaking with dilute acid before the volume is measured. Water dissolves more than its own volume of acetylene, so great care must be exercised to saturate the water of containing vessels before the gas to be analyzed is brought into them. Also gas from which large percentages of acetylene have been removed must not be returned to vessels containing much water with which it had previously been in equilibrium since the water will give back to the gas material amounts of acetylene.

Phosphorus forms a delicate reagent for qualitative detection of traces of unsaturated hydrocarbons. If when the gas in question is brought in contact with phosphorus under the conditions prescribed for the estimation of oxygen, white fumes form, it is certain evidence of the absence of more than minute traces of unsaturated hydrocarbons. If on the other hand the

¹ *Jour. Franklin Inst.*, 146, 161 (1898).

fumes fail to appear even after the addition of air it is not absolutely certain that the poison is an unsaturated hydrocarbon for ether, chloroform and a number of other substances behave similarly.

11. Oxygen.—The estimation of oxygen by phosphorus as in technical analysis admits of little improvement in simplicity or accuracy. Alkaline pyrogallate may be used where it is not possible to remove the poisons which prevent the use of phosphorus, and the ammoniacal copper reagent may be used, subject to the limitations given in Chapter III.

12. Carbon Monoxide.—It was stated in Chapter III that the methods for estimation of carbon monoxide were unsatisfactory. They are more unsatisfactory for exact than for technical analysis. The absorption by cuprous chloride given in technical methods is hardly to be considered as an accurate method. The change in the absorption spectrum of blood after treatment with carbon monoxide may be made an accurate qualitative test for carbon monoxide but does not lend itself readily to quantitative purposes.

The method usually employed is to oxidize the carbon monoxide, after having made certain that all other compounds which would be affected by the oxidizing agent have been removed.

Iodine pentoxide is the most commonly employed oxidizing agent, the reaction being:

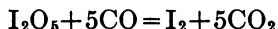

The details here given are essentially those of Kinnicutt and Sanford,¹ who used substantially the method of Nicloux. The gas is first purified by being bubbled slowly through concentrated sulphuric acid and then passed through a tube containing lumps of caustic soda. This treatment removes unsaturated hydrocarbons, hydrogen sulphide, sulphur dioxide and similar reducing gases. The purified gas is then passed through iodine pentoxide contained in a U tube immersed in an oil bath at 150° C. Following the U tube comes another absorption tube containing about 0.5 g. potassium iodide dissolved in 10 c.c. of water. If a liter of gas is used as small an amount as 0.025 c.c. of carbon monoxide may be detected. The method is ordi-

¹ *Jour. Am. Chem. Soc.*, 22, 15 (1900).

narily only used for the detection of minute amounts of carbon monoxide and it is not suitable for large amounts. The absence of any liberated iodine may be considered a positive proof of the absence of carbon monoxide. The liberation of iodine is however only a proof that some reducing substance was present, which can only with certainty be claimed as carbon monoxide after careful blank tests have shown that the purifying train is adequate to remove all other reducing substances and that the iodine pentoxide does not yield iodine except in the presence of such a reducing substance. Gill and Bartlett¹ tested this method on illuminating gas and report results about 9 per cent. high. They report accurate results when mixtures of carbon monoxide and air are used.

Morgan and McWhorter² traced some of the difficulties of this method to the reduction of the iodine pentoxide by the hydrocarbon vapors given off by the lubricant and in the stopcocks of the U tube containing it. They recommend that the tips of the U tube be sealed with a flame. They further recommend the estimation of the carbon dioxide formed in the reaction as a more accurate index of the carbon monoxide than is the iodine. They insert an absorption tube containing standard barium hydroxide in the train after the tube containing potassium iodide and after the close of the test titrate the residual barium hydroxide with oxalic acid.

13. Hydrogen.—Hydrogen may be directly absorbed in metallic palladium but is almost always oxidized. The gas should first be freed from unsaturated hydrocarbons and other reducing gases as well as oxygen, so that it contains only hydrogen, saturated hydrocarbons and nitrogen. There is then a choice of methods—one class oxidizing the hydrogen without affecting the hydrocarbons, and the other simultaneously oxidizing both hydrogen and hydrocarbons.

There are several methods for fractional oxidation of hydrogen which are reliable. The errors which attend the method of simultaneous oxidation of hydrogen and methane have been briefly discussed in Chapter IV. The important systematic error in explosions and flame combustions is due to the oxidation

¹ *J. Am. Chem. Soc.*, 29, 1589 (1907).

² *Jour. Ind. and Eng. Chem.*, 2, 9 (1910).

of nitrogen. The formation of oxides of nitrogen increases with higher temperatures. The most favorable mixture for their formation is one in which there are equal volumes of oxygen and nitrogen. The errors are therefore minimised by keeping the temperature of combustion low and by making the diluting gas as nearly pure oxygen as possible. It is not possible to give an absolute statement of the magnitude of the error introduced for it will vary with each difference in the form of the explosion vessel and in the violence of the explosion. The following series of measurements by the author¹ will indicate the magnitude of the error and also the accuracy of the burette for exact gas analysis described in this chapter.

EXPLOSION OF PURE HYDROGEN

Hydrogen, c.c.	Air, c.c.	Contraction after explo- sion, c.c.	Calculated per cent. hydrogen	Contraction over potas- sium hydrox- ide, c.c.	Explo- sive ratio
11.35	84.80	16.90	99.26	0.00	4.64
12.11	85.57	18.08	99.53	0.00	4.37
14.19	84.27	21.27	99.92	0.00	3.62
16.77	85.77	25.13	99.90	0.01	3.06
16.54	82.64	24.76	99.80	0.01	3.00
18.19	83.22	27.29	100.01	0.01	2.71
21.10	83.28	31.74	100.28	0.00	2.29
27.04	83.86	40.80	100.59	0.11	1.73

The hydrogen was prepared by the action of caustic potash on aluminium so as to be free from hydrocarbons. It will be noted that in this series air was used to supply the oxygen and as the diluent. A variation of 1.3 per cent. in the apparent purity of hydrogen due solely to errors inherent in the explosion process makes it evident that the method can hardly be called an accurate one.

The errors attendant upon the flame combustion method of Dennis and Hopkins described in § 9 of Chapter IV are illustrated in the following series.

COMPARISON OF EXPLOSION AND COMBUSTION METHODS
ON HYDROGEN

Explosions with Air

Sample hydrogen c.c.	Air c.c.	Contraction after explo- sion, c.c.	Contraction over potassium hydroxide, c.c.	Hydrogen per cent.	Explo- sive ratio
15.32	85.34	22.71	0.04	98.82	3.43
18.15	82.39	26.93	0.06	98.91	2.73

¹ *Jour. Am. Chem. Soc.*, 23, 476 (1901).

Explosions with Oxygen

Sample hydrogen c.c.	Air c.c.	Contraction after explosion, c.c.	Contraction over potassium hydroxide, c.c.	Hydrogen per cent.	Explosive ratio
	Oxygen				
14.82	93.51	22.04	0.02	99.14	3.91
16.48	82.18	24.51	0.02	99.15	3.02
20.58	80.09	30.60	0.03	99.12	2.29

Combustions by the Dennis and Hopkins Method

Hydrogen c.c.	Oxygen c.c.	Air c.c.	Contraction after combustion, c.c.	Contraction over potassium hydroxide, c.c.	Hydrogen per cent.	Oxygen in excess
91.29	51.65	54.55	136.72	0.04	99.84	13.72
58.48	53.39	50.14	87.43	0.10	99.66	40.89
89.31	40.77	50.21	133.57	0.07	99.70	3.73

The values obtained by explosion with oxygen are remarkably concordant and are probably as accurate as we can hope to attain. The values obtained by explosion with air are higher and more irregular. The values of the Dennis and Hopkins method are also high and involve an error of about 0.6 per cent.

14. Methane.—There are no absorption methods for methane which are acceptable. It is estimated by oxidation to CO_2 and H_2O with measurement of the change in volume after oxidation and after absorption of the CO_2 . The general methods are given in § 7 to 11 of Chapter IV. There is greater liability of error in the explosion process through formation of oxides of nitrogen than is the case with hydrogen, as is illustrated by the following series of tests of methane made from methyl iodide and the zinc copper couple.

EXPLOSION OF METHANE

Sample methane c.c.	Air c.c.	Contraction after explosion	Carbon dioxide c.c.	Methane per cent.	Hydrogen per cent.	Explosive ratio	Ratio contraction sample
7.05	92.07	13.09	6.53	92.62	0.28	4.05	1.85
8.93	104.17	16.66	8.31	93.23	0.14	3.53	1.86
9.07	98.35	17.10	8.54	94.15	0.14	3.19	1.88
10.20	98.22	19.27	9.63	94.41	0.06	2.61	1.89

In these experiments the explosive ratios all lie within the limits set by Bunsen, but there is a variation of 1.6 per cent. in the apparent percentage of methane as calculated by the usual methods and there is a corresponding variation in the amount of hydrogen. Similar experiments made with commercial oxygen (96.5 per cent. pure) as the diluting agent instead of air showed errors rather greater than when using air in similar amount. The greater error in analyzing methane as compared with hydrogen results almost certainly from the higher temperatures attained in the explosion of methane. It is not possible to dilute the gas sufficiently to avoid this danger without running the risk of incomplete combustion of the methane. The methods of oxidation of methane which involve flame as in explosion or the Dennis and Hopkins method are always liable to material error due to formation of oxides of nitrogen. The errors may be minimized by keeping the gases at a low temperature while reacting. Jaeger's method of analysis by combustion with copper oxide in a combustion tube as described in § 11 of Chapter IV cannot involve the formation of material amounts of oxides of nitrogen. This method is not so rapid or convenient as the others but, if care is taken to carefully cool the gas, including that remaining in the combustion tube, to its initial temperature before noting the change in volume, it is believed to be the most accurate method.

15. Errors in Calculation of Results of Explosion and Combustion.—Some gases, notably carbon dioxide and the complex hydrocarbons, do not conform completely to the gas laws. The deviation is slight at low partial pressure and is usually negligible, but should be discussed. Burrill and Seibert¹ cite the following instances. If the volume relations in the explosion of methane and oxygen are accurately expressed they will be written as follows:



According to the above equation if perfectly pure methane were exploded with pure oxygen the composition as calculated from the contraction would, if calculated by the usual rules, be 100.2 per cent., while if calculated from the carbon dioxide its percentage would be 99.4 per cent. The following table shows the

¹ *Bul.* 42, Bureau of Mines.

molecular volumes for carbon dioxide at 20° C. and different partial pressures:

Mm. of mercury	Molecular vol.
100	0.9993
200	0.9986
300	0.9980
400	0.9972
500	0.9965
600	0.9958
700	0.9951
760	0.9950

If methane should be exploded with the theoretical volume of air instead of pure oxygen the error would decrease so that the apparent purity as calculated from the contraction would be 100.14 per cent. and as calculated from the carbon dioxide would be 99.86. These errors are in general within the limits of the other errors arising in analysis by explosion or combustion.

Where ethane is present the error is greater



The molecular volumes of ethane corresponding to different partial pressures are shown in the following table:

Mm. of mercury	Molecular vol.
0	1.000
100	0.999
200	0.997
300	0.996
400	0.995
500	0.993
600	0.992
700	0.991
760	0.990

Burrell and Seibert cite an analysis of Pittsburgh natural gas which, calculated from the theoretical equations, showed 15.1 per cent. C_2H_6 and 84.1 per cent. CH_4 , while by calculation from the corrected equations the results became 15.7 per cent. C_2H_6 and 83.1 per cent. CH_4 .

16. Nitrogen.—The method of removal of all gases except nitrogen by combustion with copper oxide as given in § 12 of Chapter IV is fairly exact. The gases of the argon group are left with the nitrogen but the separation of these is not included in this work.

CHAPTER VII

HEATING VALUE OF GAS

1. Introduction.—The heating value of gases may be determined by combustion in a bomb calorimeter but the difficulty of transferring a definite quantity of gas to the bomb prevents the general adoption of such a method. The standard type of calorimeter is one in which the gas is burned with atmospheric air and the total heat of the products of combustion is transferred as completely as possible to the water of the calorimeter. A continuous flow calorimeter is usually employed wherever a sufficient amount of gas is available, but the intermittent type is also used. In some other types of calorimeter the heat of combustion is used to raise the temperature of a piece of metal, or a thermocouple placed in the flame. Calorimeters of these latter types give merely relative figures which can only be converted into heat values after very careful calibration. They are in no sense standard instruments and are not discussed in this book. It is also possible to calculate the heating value of the gas from its chemical composition with approximate accuracy.

2. Continuous Flow Calorimeters.—The continuous flow calorimeter bears much resemblance to the type of instantaneous water heaters found in bath rooms. The gas, after passing through a meter, is burned in a Bunsen burner. The products of combustion give up their heat to a stream of cold water flowing in a direction opposite to that of the gases so that the gases emerge from the instrument cold and the water emerges hot.

The process to be accurate requires the fulfillment of the following conditions:

- a. The gases must be accurately measured, be burned at a constant rate, and combustion must be complete.
- b. The water must enter at a constant rate and at constant temperature, and be at approximately room temperature.
- c. The heat of combustion must all be transmitted to the

water whose mass and rise in temperature must be accurately determined.

The pioneer instrument of this type was that devised by F. W. Hartley in 1884.¹ The standard by which gas was judged was, at that time, candle power and therefore the instrument did not attract much attention. The first calorimeter to be used widely was that designed in 1893 by Hugo Junkers.²

3. Wet Gas Meters.—The gas is usually measured in a wet meter which consists of a horizontal cylindrical casing of sheet metal enclosing a horizontal drum and filled about half full of water. The drum is divided with slant partitions into three or four compartments, each with its own entrance for gas at the back and its exit at the front. Each of these compartments constitutes a distorted screw thread enlarged to a chamber in the center. As the inlet of one of these compartments comes out of the water the pressure of the gas entering causes the drum to revolve and the compartment fills with gas. When the compartment is full the inlet dips below the water and seals, the outlet unseals and the water entering the compartment drives out the gas before it. If there were only one or two compartments the flow of gas could not be continuous, but with three or four compartments in the drum, one is always discharging and the rate of flow of gas is about constant.

It will readily be seen that the capacity of each compartment and the time of sealing and unsealing the inlet and outlet will be affected by the height of water in the meter so that the exact setting of the water level becomes of great importance. Each meter is provided with a gage glass and a pointer which can be adjusted to indicate the proper water level. The Committee on Calorimetry of the American Gas Institute in its 1912 report states that even with careful work an error of 0.3 per cent. may be introduced by inaccurate adjustment of the water level and that on passing 100 cubic feet of gas through the meter an error of about equal magnitude may be introduced through evaporation of the water. The meter must be calibrated frequently for accurate work.

The gas meter must be calibrated by passing a known volume

¹*London Jour. Gas Lighting*, 43, 1142 (1884).

²*Jour. fur Gasbel.*, 36, 81 (1898).

of gas through it. This known volume may most accurately be obtained by the use of what is known as a cubic foot bottle or a smaller container of the same type. Containers of this type should be rigidly made of glass or metal and tapered at the top and bottom to glass tubes of small diameter upon which zero marks are etched. The capacity of one of these containers is determined by the weight of water which it contains. They may be bought in elaborate forms and with the certificate of the Bureau of Standards. Where a standardized bottle is not available a sufficiently accurate substitute may be improvised from a gas holder of the type shown in Fig. 23. This consists of a cylinder of galvanized iron coned and terminated with a cock at both ends. If this is filled with water at room temperature and weighed, and then drained and weighed, the volume of the tank may be calculated from the following table. The volume thus obtained may be considered constant within ordinary ranges of temperature since the coefficient of expansion of mild steel is only 0.000067 per degree Fahrenheit.

The tank shown in the illustration holds one-third of a cubic foot and is weighed upon the balance shown in front of it. If larger tanks are used they must be made of heavy material so as not to change in volume when filled with water.

WEIGHT OF ONE CUBIC FOOT OF WATER

50° F.....	62.41 lb.
60° F.....	62.37 lb.
70° F.....	62.31 lb.
80° F.....	62.23 lb.
90° F.....	62.13 lb.

In making the test the tank is to be filled absolutely full of water of almost room temperature and left standing by the side of the meter in a room of fairly constant temperature for several hours to make sure that all the parts of the system are at the same temperature. The gas supply is to be bubbled through water in order to be certain that it is saturated with water vapor. If the depth of water in the saturator is so adjusted that no gas bubbles through unless a very slight suction is applied, it will obviate mathematical corrections, because if the static pressure

of the water in the saturator is adjusted to counterbalance the pressure of the incoming gas, and the outlet of the discharge from the tank is set at the level of the lower cock, a direct comparison of the volume of gas registered by the meter and the capacity of the tank gives the calibration factor for the meter without any calculation for difference in pressure. So long as the whole system is at the same temperature it is immaterial what the temperature is. The upper cock of the tank may now be connected directly to the outlet of the meter. The lower cock of the tank should have a rubber tube attached which drops down to allow the formation of a water seal and rises again to discharge the water at the level of the cock. If now the lower cock on the tank is opened water will flow out through the rubber tube and an equal volume of gas will flow through the meter. When the water is all out of the tank the gas will be automatically stopped by the water seal in the rubber outlet tube and the whole system will be under atmospheric pressure, which is a condition necessary for accurate work.

4. Corrections for Temperature and Pressure.—The volume of the gas used in a test must be corrected for temperature and pressure. The standard conditions for the United States and Great Britain are a temperature of 60° F. and a barometric pressure of 30 in. of mercury. The gas as it comes from the wet meter is assumed to be saturated with water and correction is made for the excess of water vapor over that normal for 60°. Tables giving the correction factors in convenient form have been issued by the Gas Referees of London. They are derived according to the formula.

$$n = \frac{17.64(h-a)}{460+t}$$

where n = factor sought

h = height of barometric column in inches mercury

a = vapor tension in inches of mercury at temp. t

t = observed temp. of meter in degrees F.

Although this formula apparently involves the full correction for vapor tension which would reduce the volume of gas to a dry basis at 60° F., there is a further correction contained in the figure

17.64 of the formula which corrects the gas to a basis of 60° F. when saturated with water. The full formula is as follows;

$$n = \left(\frac{1}{1 + \frac{t-32}{491}} \right) \left(1 + \frac{60-32}{491} \right) \left(\frac{h-a}{30} \right) \left(\frac{30}{30-.51} \right)$$

The first member of the formula corrects the volume to 32° F., the second to 60° F., the third to dry gas under 30 in. barometric pressure, and the fourth to gas saturated with moisture at 60° F. the 0.51 being the vapor pressure of water at 60° F. Table III in the Appendix gives the factors for each degree Fahrenheit and each 0.1 in. pressure within wide limits.

5. Control of the Water.—The water supply must always be sufficient to keep the overflow on the small elevated constant-level tank in operation. If the supply of water to the tank slackens much the rate of flow to the calorimeter will also change. The temperature of the water should also be constant and approximately that of the room. In order to insure a water supply of even temperature and pressure it is advisable to install in the calorimeter room an elevated tank of at least 20 gallons capacity connected to the water mains and provided with an overflow from which the supply for the calorimeter is drawn.

6. Measurement of Temperature.—The temperature of the inflowing and outgoing water is determined by thermometers which should read to tenths of a degree. They must be carefully calibrated throughout their length by comparison with a standard. It is immaterial whether they are Centigrade or Fahrenheit thermometers but the Fahrenheit are more convenient, when as is customary, the results are to be expressed in British thermal units per cubic foot of gas. The thermometers are to be carefully placed in the calorimeter so that their bulbs are completely surrounded by water and are nowhere in contact with the metal of the calorimeter.

7. Measurement of Mass of Water.—The mass of water heated during an experiment may be determined either by measurement or by weight. A 2000-c.c. graduated cylinder is used sometimes. This is not an ideal device, for not only are the graduations coarse but the varying temperatures at which the

water is measured necessitate the use of different correction factors to reduce the volumes to the equivalent weights. It is much more satisfactory to weigh the water. If the thermometers are in the Fahrenheit scale it is more convenient to have the balance weigh in pounds and hundredths of a pound. If the thermometers read in the Centigrade scale it is more convenient to preserve the metric unit throughout. The water should be weighed in a metal bucket or glass vessel for which a counterpoise is provided. It is convenient to counterpoise the bucket with the interior wet as it is just after the water has been poured out after a test. Its weight will be so nearly constant that it is not necessary to counterpoise after each test. The balance should be capable of carrying ten pounds on each pan with a sensitiveness of one-hundredth of a pound.

8. Description of Calorimeter.—The illustrations of Fig. 22 show the Junkers calorimeter which has served as the model from which most of the American instruments have been developed. Some of the American instruments embody distinct improvements—such as ease of disassembly for repairs or cleaning, and automatic tipping device for diverting the stream of heated water from the measuring bucket when the meter hand has made a complete revolution. The gas coming from the meter is burned in a Bunsen burner placed in the cylindrical combustion chamber of the instrument. The hot gases rise in the central chamber, pass down through a series of small tubes in the annular water jacket surrounding the combustion chamber, unite again in a single flue at the bottom of the instrument and pass out through an orifice whose size may be regulated by a damper. Water enters through the rubber tube *w* to the small elevated tank *a* which serves to supply water to the calorimeter under a constant head. The amount of water flowing into the instrument is controlled by the valve *b* and the waste water from *a* is discharged at *c*. The water traversing the instrument passes out at *d* and during the actual test is measured in the graduated cylinder shown, or collected in a vessel and subsequently weighed.

The operation of the instrument is shown in detail in Fig. 22. The sectional illustration shows the burner (2) properly placed in the combustion chamber (1) and the path of the combustion gases and the water. The products of combustion rise in the

central chamber, turn at the top, descend the annular cooling chamber (3) to the drum (4), pass the thermometer (5) and escape at (6). The water rises to the small overflow cup (7) traversing a filter of wire gauze. The excess of water overflows and passes out of the instrument to the waste pipe through a rubber

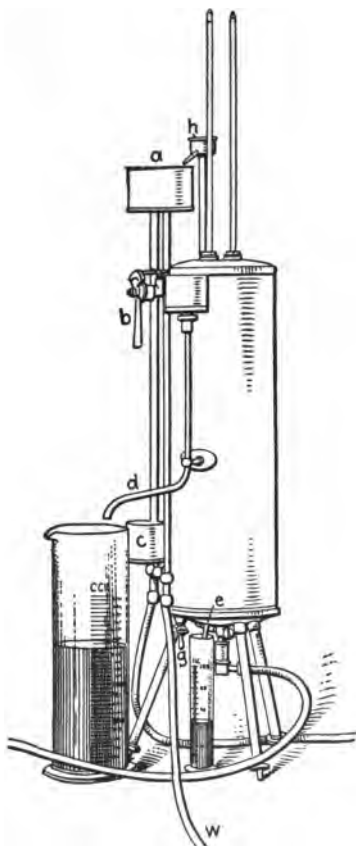

FIG. 22a.—Gas calorimeter.

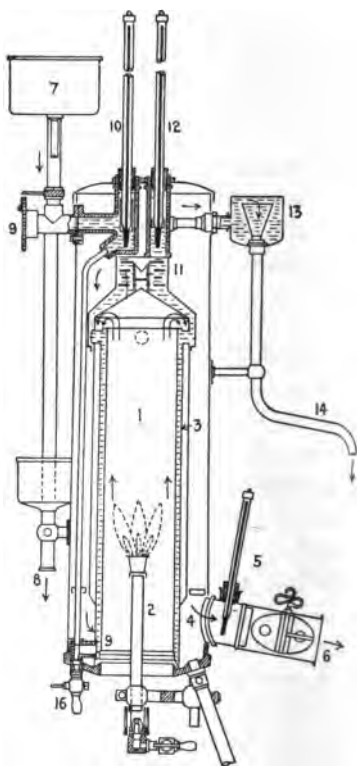

FIG. 22b.—Section of gas calorimeter.

tube attached at (8). The small vessel (7) must always be kept overflowing to insure a constant pressure and hence a constant supply of water through the valve (9). The water passes the thermometer (10) which registers the inlet temperature, descends in a small pipe within the outer casing to the bottom of the instru-

ment and rises in the annular chamber surrounding the gas passages (3), thus passing in a direction opposite to that of the combustion gases. The water from the annular chamber passes through the drum (11) provided with baffle plates to mix it and to insure that all parts of the stream are of uniform temperature, passes the thermometer (12) which registers the outlet temperature, to the overflow vessel (13) and out at (14).

The water formed in the combustion of the hydrogen and hydrocarbons of the gas is condensed as it descends the annular condenser (3) and passes out of the drip shown at *e* of Fig. 22*a* and is caught in a graduated cylinder. The working parts of the calorimeter thus described are insulated from the room by an air jacket. The outer casing of the calorimeter is nickel-plated and to be kept polished to lessen the loss of heat by radiation. It is well to drain the calorimeter when not in use by opening the cock (16). There is some danger that air brought in by the incoming water may collect around the inlet thermometer and disturb the accuracy of its readings. The tube (h) shown at the top of the calorimeter in Fig. 22*a* is to allow such bubbles to escape. Any water entrained by the bubbles passes out of the small overflow.

9. Preliminaries of a Test.—The calorimeter is to be set up on a table where the light is good, where there are no draughts, and where there is a water supply and a waste pipe. Fig. 23 shows the calorimeter set in a hood which has been modified by lowering a portion of the floor to bring the thermometer more nearly on a level with the eye of the observer. On the top of the hood is a zinc-lined wooden tank connected to the water supply and provided with an overflow pipe, from which the water supply for the calorimeter is drawn. This large overflow tank is necessary to compensate for variations in the temperature and pressure of the city water supply. It should preferably hold enough water for the day's tests, so that the water standing over night may come to room temperature.

The first step is to turn on the water and regulate the supply so that it flows through the instrument at the rate of approximately 1.5 to 2.0 liters per minute in case illuminating gas of ordinary quality is to be tested. The water must continuously overflow from both cups (13) and (7) of Fig. 22*b*. No water

should drip from spout *e* nor from any other part of the instrument.

The gas meter is to be levelled and water added if necessary to bring the bottom of the meniscus of the water on a level with the pointer. This is to be done when there is no gas pressure on the meter, and to ensure this state of affairs the burner cock on the outlet of the meter should be open and an opening should be made to the air on the inlet side of the meter. This may usually be most conveniently effected by disconnecting the rub-

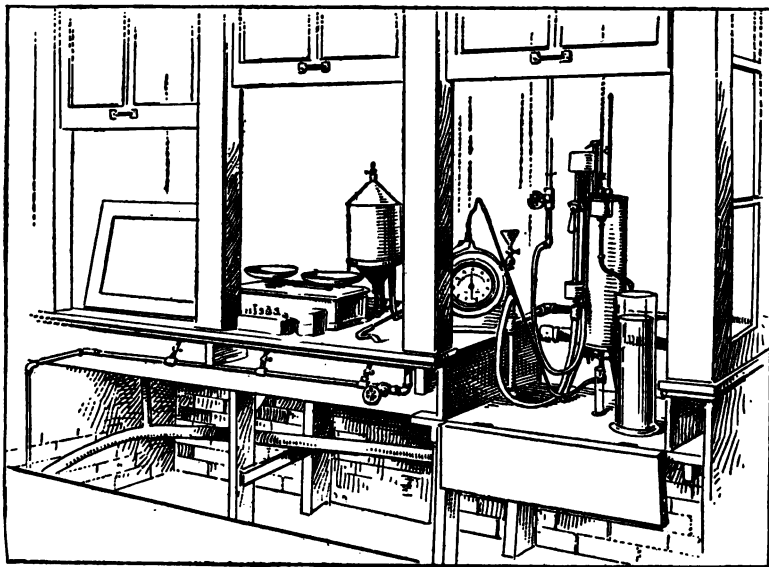

FIG. 23.—Gas calorimeter and accessories.

ber tube, but may also be accomplished by unscrewing the small plug at the bottom of the well below the gas inlet. This also serves the purpose of removing any water which may have splattered into the gas inlet. The probable error in adjusting the water level is 0.3 per cent. so that when a greater accuracy is required the meter should be recalibrated after adjustment. The gas supply is to be connected to the meter and then to the calorimeter. A pressure regulator is unnecessary on a city gas supply if the meter works smoothly. Directions are frequently

given to interpose a regulator of the floating bell-jar type between the meter and the calorimeter. If this is done it must be watched closely because any variation in the heights of the drum of the regulator at the beginning and end of the test causes an error in the measurement of the gas. Long connections of rubber tubing are to be avoided since rubber is porous and also exerts a selective solvent action on the hydrocarbons of the gas. The connections should be of glass with short lengths of rubber on each end.

The system is to be tested for leaks by closing the burner cock and opening the inlet cock on the gas main. The large hand of the meter should not show any perceptible change in position after two minutes. When the system has been found to be tight the burner cock may be opened and the gas allowed to escape into the air of the room until the large hand of the meter has made one complete revolution. It may then be lighted without danger of explosion unless the gas is acetylene, uncarburetted water gas or similar gases having wide explosive limits. Be sure that no unburned gas gets into the calorimeter where it might cause explosion later.

The flame from the burner is to be regulated so that it is a clear blue color with just a tinge of yellow at the tip. The volume will depend on the quality of the gas. Special tips for gases of very high or low heating value are provided with the instrument. With ordinary illuminating gas the rate of flow should be between 5 and 7 ft. per hour. The gas should be burned with a small excess of air. The draft may be controlled by the butterfly valve (6) of Fig. 22. The valve should be set to give maximum readings of the thermometer on the water outlet. That setting which gives the highest result is the most accurate. The Bureau of Standards¹ recommends as a "normal rate," the rate of 70 per cent. of the maximum attainable without incomplete combustion. The flame must burn perfectly steadily. If it flickers the most probable cause is the presence of water in some of the connections. The rubber tubing should be disconnected and drained, the plug in the well below the inlet of the meter removed, and the pressure regulator examined. It may be that the flickering is due to friction within

¹ Technologic Paper No. 36.

the meter which causes the drum to stick. This can usually be observed by closely watching the large hand of the meter and observing if it lags at particular points of its revolution. Trouble from this source cannot usually be remedied without sending the meter back to the factory. Flickering of the flame of the test burner may also be due to fluctuations in the pressure of the gas in the mains or services. A U-gage attached to a gas out'et will show whether this is the case. If it is necessary to test gas under these conditions the flickering may be lessened by interposing between the gas outlet and the meter a large empty bottle. Care must be taken to fill this bottle completely with water and then displace this with gas to avoid danger of explosion.

If the meter has been recently filled with fresh water the gas should be allowed to burn for an hour before the test in order that the water of the meter may become saturated and not cause any change in the composition of the gas passing through it.

10. Description of a Test.—When the gas and water supply and the burner have been thus adjusted, the lighted burner may be placed in the calorimeter, care being taken to properly center it and to see that it projects far enough into the instrument so that the top of the burner will be above the lower level of the belt of cooling water. This operation is facilitated by a small mirror placed below the instrument. The thermometer in the outlet water will at once commence to rise, and in a few minutes will be constant to within a few tenths of a degree. The increase in temperature of the outflowing over the incoming water should not be more than 20° F. and it may be necessary to readjust the water and gas supply to obtain this condition. If it is necessary to change the adjustment of the gas the burner should be removed from the calorimeter. The butterfly valve must not be closed enough to prevent the flame from burning strongly and freely. The escaping gases should not have any odor of unburned gas. Their temperature should be only a few degrees above that of the water entering.

The water formed in the combustion of the hydrogen and hydrocarbons will condense in the calorimeter and commence to drip from the small spout at the bottom of the instrument. The test should not be commenced until the thermometer on the water outlet has remained constant for several minutes and the

condensed water has also commenced to drip from its spout showing that equilibrium has been reached within the calorimeter.

The counterpoised bucket for the water is placed in a convenient position and as the large hand of the meter passes a zero mark the water is turned into the bucket. Both thermometers are now to be read at each quarter position of the meter hands or more frequently. The outlet thermometer sometimes fluctuates rapidly and it is well under such circumstances to read it as many times as possible so as to obtain a fairer average. A consumption of 0.2 of a cubic foot, or two revolutions of the large meter hand is sufficient with illuminating gas. The last thermometer readings will be made when the meter hand is in the three-quarter position. The operator then watches the meter while holding one hand on the tube through which the outlet water is flowing and as the meter hand again reaches the zero he swings the tube out of the bucket, thus marking the completion of the test. After the water has been weighed a duplicate test may at once be started. The procedure is the same in case the water is to be measured in a graduated cylinder instead of being weighed. The volume readings of the cylinder must be converted into grams by means of the table in § 6 of Chapter XVI on Manipulation of the Bomb Calorimeter. It is not possible to read the volume very accurately in a wide graduated cylinder.

The water of condensation dripping from the instrument is to be measured to allow the calculation of the net heating value. It is accurate enough to catch the water formed from 1 cu. ft. in a 50 c.c. graduated cylinder.

In case the temperature readings have not stayed constant within a few tenths of a degree during the test, the results should be discarded and an attempt be made to better the conditions.

If for any reason the burner goes out during a test and unburned gas gets into the instrument, it must be expelled before again lighting the flame. This may readily be accomplished by blowing vigorously through the escape pipe of the combustion gases.

11. Calculation of Observed Heating Value.—The heating value of gas is usually expressed, in English speaking countries, in British thermal units per cubic foot of gas measured when

saturated with moisture at 60° F. and under a barometric pressure of 30 in. of mercury. The method for correcting the observed volume of gas to these standard conditions has been described in § 4. ~~The factors for converting cubic centimeters of water at various temperatures to grams are given in § 6 of Chapter XVI.~~ A Calory is defined accurately enough for this work as the amount of heat required to heat 1 kg. of water 1° C., and a British thermal unit to be the amount required to heat 1 lb. of water 1° F. irrespective of the temperature of the water. The formula for calculation of the heating value is

$$HV = \frac{m(t' - t)}{v}$$

where m = mass of water heated

t' = mean temperature of water flowing out

t = mean temperature of water flowing in

v = corrected volume of gas burned

If m is expressed in pounds, t in degrees Fahrenheit and v in cubic feet, the result is at once British thermal units per cubic foot.

If m is expressed in kilograms, t in degrees Centigrade and v in cubic feet, the result is in the hybrid unit Calories per cubic foot which may be corrected to British thermal units per cubic foot by multiplying by 3.968.

If m is expressed in grams, t in degrees Centigrade and v in liters the result will be in the metric unit, small calories per liter which is the same as Calories per cubic meter. This is the method of reporting heat values in Germany and other countries which use the metric system. To convert Calories per meter to British thermal units per cubic foot of gas measured under the same condition multiply by .1124. In scientific work the heating value of a gas is usually reported as Calories per cubic meter of dry gas at 0° C. and 760 millimeters pressure. In technical work in Germany the gas volumes are usually corrected to 15° C. and 760 mm. pressure which makes the conditions practically the same as those which prevail in this country.

The following data are from a test made under rather unfavorable conditions and where no attempt was made to secure

an accuracy closer than 1 per cent. The meter used passed 0.1 cu. ft. of gas per revolution, the thermometers were in the Fahrenheit scale and the water was weighed in pounds.

Meter reading at start.....	21.200
Meter reading at close.....	21.400
Meter temperature.....	71° F.
Barometer.....	29.8
Correction factor for temperature and pressure.....	0.965
Correction factor for meter.....	0.996
Temperature of water	

In	Out
53.8°	70.9°
53.9	70.8
53.9	70.9
53.8	70.9
53.9	71.0
53.9	70.9
<u>54.0</u>	<u>71.0</u>

*safe than
approx.*

Average..... 53.88° F.

70.91° F.

Calibration correction for inlet thermometer.....	-0.1°
Calibration correction for outlet thermometer.....	+0.1°
Corrected inlet temperature.....	53.78° F.
Corrected outlet temperature.....	71.01° F.
Rise in temperature of water.....	17.23° F.
Room temperature.....	72° F.
Weight of water heated.....	6.76 pounds

not that cut

Gas burned, corrected $0.2 \times 0.965 \times 0.996 = 0.192$ cu. ft.

Uncorrected heating value $\frac{6.76 \times 17.23}{0.192} = 606$ B.t.u. *95.2*

Correction for difference in temperature between inlet water and room temperature = 0.7 B.t.u. per degree F. (see Table VIII of Appendix)

*40
20
800*

Temperature inlet water.....	54° F.
Room temperature.....	72° F.
Difference.....	<u>18° F.</u>

Correction to be subtracted $0.7 \times 18 = 12$ B.t.u.

Observed heating value 594 B.t.u.

12. Total Heating Value.—The total heating value of a gas has been defined by the Bureau of Standards¹ in the following terms. "The total heating value of a gas, expressed in the English system of units, is the number of British thermal units produced by the combustion, at constant pressure, of the amount of the gas which would occupy a volume of 1 cubic foot at a temperature of 60° F., if saturated with water vapor and under a pressure equivalent to that of 30 inches of mercury at 32° F. and under standard gravity, with air of the same temperature and pressure as the gas, when the products of combustion are cooled to the initial temperature of gas and air and the water formed by combustion is condensed to the liquid state."

It is believed preferable that this term replace the term "gross heating value" which has been very loosely used. The total heating value differs from the observed heating value in the application of certain corrections for errors which while minor may cause an error of as much as 2 per cent. in the final result. These are discussed in following paragraphs.

13. Net Heating Value.—In most industrial operations the combustion gases are not cooled to room temperature before escaping from the apparatus and therefore some of the heat of the gas is wasted. This is due to a lack of efficiency of the apparatus and varies with individual conditions. There are so many industrial operations, however, where the water formed in combustion escapes as steam and the latent heat of steam formation is so large when compared with the amount of heat required to raise the temperature of fixed gases or of water or steam through moderate temperature intervals that the value of the latent heat is frequently deducted from the gross heating value. The resulting lower value is called the net heating value.

The *net heating value* is defined by the Bureau of Standards as follows: "The *net heating value* of a gas, expressed in the English system of units, is the number of British thermal units produced by the combustion, at constant pressure, of the amount of the gas which would occupy a volume of 1 cubic foot at a temperature of 60° F., if saturated with water vapor and under a pressure equivalent to that of 30 inches of mercury at 32° F.

¹ Waidner and Mueller, Technologic Paper No. 36. Industrial Gas Calorimetry.

and under standard gravity, with air of the same temperature and pressure as the gas, when the products of combustion are cooled to the initial temperature of gas and air and the water formed in combustion remains in the state of vapor. According to the above definitions the net heating value is less than the total heating value by an amount of heat equal to the latent heat of vaporization, at the initial temperature of the gas and air, of the water formed by the combustion of the gas."

The heat absorbed when one gram of water at 100° C. changes to steam at the same temperature is 0.536 Calories. The heat absorbed in the change of liquid water at 10° C. to vapor at 10° C. is very closely 0.600 Calories. This latter figure is usually employed in calculating the net heating value which is obtained by multiplying the number of cubic centimeters of condensed water dripping from the calorimeter during the combustion of a cubic foot of gas by 0.6, and 3.968 to convert into British thermal units and then subtracting this value from the observed heating value in British thermal units per cubic foot. The method of calculating the net heating value in the test reported in the preceding section is as follows:

Meter reading at start.....	21.200
Meter reading at close	22.100
Gas burned	0.900 cu. ft. uncorrected
Gas burned corrected, $0.9 \times 0.965 \times 0.996 = 0.86$ cu. ft.	
Condensed water collected, 21.8 c.c.	
Condensed water formed per cu. ft. gas $\frac{21.8}{0.86} = 25.4$ c.c.	
Latent heat of condensed water, $25.4 \times 0.6 \times 3.968 = 60$ B.t.u.	
Uncorrected heating value of gas.....	606 B.t.u.
Correction for difference in temperature between inlet water and room temperature = 0.4 B.t.u. per degree F. (see Table VIII of Appendix).	
Corrections to be subtracted $0.4 \times 18 =$	7
Latent heat of condensed water.....	60
Net heating value of gas.....	539 B.t.u.

14. Calculation of Total Heating Value.—The calculation of Observed Heating Value given in Section 11 must be modified

by taking account of the following errors in order to calculate Total Heating Value.

- Temperature correction for barometer.
- Correction for pressure of gas at meter.
- Correction for emergent stem of thermometer.
- Correction for variation in temperature of inlet water.
- Correction for variation in temperature of escaping gases.
- Correction for humidity of air.
- Correction for humidity of gas.

An illustration of a complete record and calculation with correction for all errors as taken from Circular 48 of the Bureau of Standards forms is given in Fig. 24.

15. Accuracy of Method.—The accuracy of gas calorimeters has been thoroughly investigated by the Committee on Calorimetry¹ of the American Gas Institute and subsequently by the Bureau of Standards.² Both investigations agree that continuous flow calorimeters give substantially accurate results when properly constructed and operated.

The sources of error are as follows:

Errors in Registration of Gas Volume.—If the meter is in good condition and is calibrated after the water level has been adjusted the error of the meter need not exceed one-tenth of 1 per cent. If these precautions are neglected the error may be large. The error of observation will be about one small division of the large scale corresponding to 1 part in 200 or 0.5 per cent. error in a test as ordinarily run.

Errors in Measurement of Temperature.—If the thermometers are accurately calibrated, the water supply of constant temperature and the consumption of gas and its heat value constant during a test, there should be practically no instrumental error. If the constancy of any of these conditions is upset there will be errors due partly to lag in the thermometers which do not instantly respond to the changed condition. An error which is negligible except in the most accurate work is that caused by the different temperature of the bulb and the stem of the thermometer. There will be no correction for the emergent stem of the

¹ *Proc. Am. Gas Inst.*, 1908, 285; 1909, 148; 1912, 65.

² Technologic Paper No. 36. *Industrial Gas Calorimetry*, 1914.

HEATING VALUE TEST RECORD

Place Bureau Bldg. Date Oct. 8, 1913 Time 10 a.m. Gas Sturm
 Calorimeter No. J1209 Meter No. 6312 Thermometer No., Inlet 5781A Outlet 5781B
 Gas line purged ^{Yes}/_{No} Meter adjusted ^{Yes}/_{No} Leak test ^{Yes}/_{No} Water valve 65 Damper closed
 Differential therm. corr'n det'd. Oct. 1, 1913 (date). Last meter calibration Sept. 4, 1913 (date)

	START	END		SERIES No. 1		SERIES No. 2		SERIES No. 3	
				Inlet	Outlet	Inlet	Outlet	Inlet	Outlet
Temp. of barometer	68°	68°	Preliminary	67.94	86.54	67.93	86.40	67.90	86.40
Barometer reading	29.52	29.51		50	45	45			
Corr'd. corr'n	-0.1			50	49	48			
Temp. corr'n	-1.0			43	40	40			
Corr'd. barom. height	29.40			36	43	39			
Pressure at meter (inches in water)	1.5			43	47	43			
Eqv't. (inches of mercury)	.11			54	50	49			
Total gas pressure	29.51			67.93	49	67.93	50	67.90	52
Meter therm. reading	68.1	68.3		50	41	50			
Corr't. corr'n	-3			50	40	40			
Meter temp.	67.9		47	48	42				
Reduction factor γ	0.963		40	38	45				
Psychrometer { wet bulb	53.0	53.0							
{ dry bulb	68.0	68.5							
Humidity	35%								
Temp. of products	69		Supplementary	49	41	46			
Time of 1 meter rev.	52"		Average	67.93	86.46	67.93	86.45	67.90	86.45
Eqv't. vol. (cu. ft. per hr.)	6.9		Certificate corr'n	-2.8	-2.5				
CONDENSED WATER COLLECTED			Differential corr'n	-0.2	-1.8	-1.9	-1.8	-1.9	
Meter reading: start	Ther. 1	Ther. 2	Emergent stem corr'n	+0.8					
	18.1	19.4	Certificate temp.	67.75	86.27	67.75	86.26	67.72	86.26
" " end	19.1	20.4	Temp. rise T	18.52	18.51	18.54			
Condensate (cc)	2.16	2.12	Water heated W	6.74	6.74	6.72			
" per cu. ft. (60° F.)	2.23	2.19	No. of rev. of meter	2					
Average A	2.21		Meter calib. 1 rev. =	0.1006					
NET HEATING VALUE			Gas volume γ	0.2012					
Observed heating value average	644		Observed heating value	644	644	643			
Corr'n for heat loss	+1		$\frac{W \times S}{V \times T}$						
Reduction to met (A x 2.8)	-51		Corr'n for heat loss	+1					
Net heating value	594		Corr'n for steam humid.	+4					
Corrected as correct,			Total heating value	649	649	648			
<u>E. F. M.</u>			Average	649					
Observer,								Stn. per cu. ft. (60° F.)	

FIG. 24.—Complete record sheet for determination of heating value of gas: from Circular 48, Bureau of Standards.

inlet thermometer if the inlet water is at room temperature. If the room temperature is 70° F., and the temperature of the outlet water is 90° F., an addition of from 0.07 to 0.10° F., should be made to the observed reading of the outlet thermometer, the exact amount depending on the depth to which the stem of the thermometer is immersed in the water. Detailed tables of these corrections form Table VII of the Appendix of this book. A more important error due to changed conditions during a test results from the large volume of water always contained in the calorimeter.

A calorimeter may contain approximately four pounds of water so that a test may be half completed before any of the water whose temperature has been taken at the inlet, reaches the outlet. In case the temperature of the inlet water shows any considerable variation it is wiser not to stop the readings with the termination of the test but continue to read the outlet thermometer at the regular intervals for a third revolution of the meter hand, and to use the inlet temperatures of the first and second revolutions and the outlet temperatures of the second and third revolutions, in making the computations. It will be evident that the larger the volume of water in the calorimeter the greater is the possible error from this source. The error in making a single reading of the thermometers should be less than a tenth of a degree and the mean error of a series of seven observations should not be over 0.05°. On a rise of ten degrees this corresponds to 0.5 per cent. This average of seven readings will not give the correct mean temperature of the water unless the individual readings differ from each other only by a few tenths of a degree.

Errors in Determination of Mass of Water Heated.—The error in weighing the water should be less than 0.1 per cent. but an error of a second in terminating the experiment means a possible 0.8 per cent. This is a greater time error than necessary but the probable error in this process will be 0.5 per cent.

Error Due to Incomplete Combustion.—When the calorimeter is properly adjusted, this error should vanish.

Errors Due to Sensible Heat and Uncondensed Water Vapor Escaping in Combustion Gases.—As the gases pass down through the calorimeter they meet water of progressively lower tempera-

ture until just before leaving the calorimeter they are surrounded by water of the temperature recorded by the inlet thermometer. They should therefore leave the instrument at a temperature within a few degrees of that of the inflowing water. With a theoretical air supply the error from this loss of sensible heat in the dry gas is less than 0.3 B.t.u. per degree of temperature difference per cubic foot of gas burned. According to the report made to the American Gas Institute,¹ the actual errors observed as due to this source were only 0.5 B.t.u. per degree per cubic foot even when the temperature of the inlet water was far from that of the room. The actual figures recalculated slightly are given below.

Temp. inlet water	Temp. exhaust gases	Difference between temp. exhaust gas and inlet water	Error in heat value due to sensible heat of dry gases of combustion, B.t.u.	Error per degree difference
Deg. F.				
39	45.6	+6.6	+3.7	0.56
49	54.2	+5.2	+2.7	0.52
59.6	63.2	+3.6	+1.8	0.50
70.4	72.4	+2.0	+1.0	0.50
80.5	81.5	+1.2	+0.3	0.23
89.3	88.6	-0.7	-0.5	0.70

The error due to water vapor in the exhaust gases may be more serious. The exhaust gases always leave the calorimeter saturated with water. The gas burned having passed through a wet meter is also practically saturated with water. The air for combustion, whose theoretical volume for illuminating gas is roughly six times the volume of the gas, and whose actual volume may be twice that, is drawn from the room and may vary widely in humidity. The maximum error which can thus be introduced may be indicated by the following calculation. It is assumed that one volume of gas is burned with six volumes of air and that the volume after combustion contracts to six volumes. The water formed in combustion will remain in the vapor form so far as the gases can hold it and the remainder will condense in the

¹Proc. Am. Gas Inst., 1909, 168.

calorimeter. The one volume of gas burned entered the calorimeter saturated with water so that only additional water to saturate 5 cu. ft. need come from combustion. The weight of water vapor per cubic foot of gas will vary with the temperature as shown in the following table.

Temp.	Wt. vapor in mixed cu. ft. gas and vapor
32° F.....	0.000304 lb.
42° F.....	0.000440 lb.
52° F.....	0.000627 lb.
62° F.....	0.000881 lb.
72° F.....	0.001221 lb.
82° F.....	0.001667 lb.
92° F.....	0.002250 lb.

The following examples will serve as an illustration of the use of these figures.

(1) Assume that the air enters at 62° and 50 per cent. saturated with water vapor, the gas enters at 62° saturated with moisture and the exhaust gases escape at 82°.

Moisture brought in 6 cu. ft. air at	0.00044 = 0.00264 lb.
Moisture brought in 1 cu. ft. gas at	0.00088 = 0.00088 lb.
	0.00352
Moisture carried out by 6 cu. ft. gas at	0.00166 0.01000
Excess of moisture supplied from water of combustion	0.00648 lb.
Latent heat = 1070 B.t.u. per lb.	
Heat lost = 0.00648 × 1070 = 6.9 B.t.u.	

This is an unusually large error since there is no need of letting the exhaust gases escape at such a high temperature. If they had escaped at 72° the error from this source would have been only 4.1 B.t.u. If they had escaped at 62° the error would have been only 1.9 B.t.u. If they had escaped at 52° or 10° below room temperatures the error would have been almost zero.

This error is present in almost all operations but when care is taken to have the temperature of the exhaust gases a few degrees below that of the room the error should not be over 3 B.t.u. It will usually make the result too low but in cases where the room

is warm and the air nearly saturated with water it may be in the other direction.

The most accurate results are obtained by keeping the temperature of the gas and the exhaust at room temperature and correcting for the humidity of the air according to Table V of the Appendix when gas of approximately 600 B.t.u. is being tested and according to Table VI when natural gas of about 1000 B.t.u. is being heated. Under these conditions the error will be about 1 B.t.u. Before using this table the humidity of the air must be determined as directed in the following Section. The corrections are expressed in B.t.u.'s and are to be added where the sign is + and subtracted where it is -.

Loss of Heat by Radiation.—The calorimeter is protected against interchange of heat with the outside air by an insulating air chamber enclosed in a polished metal jacket. The efficiency of this protection is given in the report of the Committee on Calorimetry of the American Gas Institute for 1908 as 99.5 per cent. The metal jacket should be kept bright in order to maintain this efficiency.

Accuracy of the Process as a Whole.—None of the various preceding sources of error need amount to over 0.5 per cent. They will partially offset one another. When great care is taken the total error may not be over 1 per cent. Under ordinary conditions it is not safe to assume that the error will be less than 2 per cent.

16. **Determination of Humidity of Air.**—The following directions for the measurement of atmospheric moisture are given by the U. S. Weather Bureau.¹ The most reliable instrument for this purpose is the sling, or whirled psychrometer. In special cases rotary fans, or other means, may be employed to move the air rapidly over the thermometer bulbs. In any case satisfactory results can-

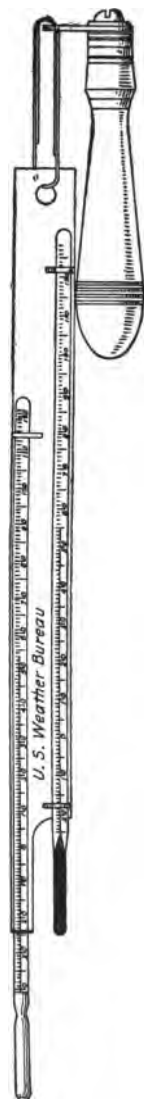

FIG. 25.—Sling psychrometer.

¹ U. S. Dept. Agriculture, W. B. No. 235, Psychrometric Tables.

not be obtained from observations in relatively stagnant air. A strong ventilation is absolutely necessary to accuracy.

The sling psychrometer consists of a pair of thermometers, provided with a handle as shown in Fig. 25, which permits the thermometers to be whirled rapidly, the bulbs being thereby strongly affected by the temperature of and moisture in the air. The bulb of the lower of the two thermometers is covered with thin muslin, which is wet at the time an observation is made.

It is important that the muslin covering for the wet bulb be kept in good condition. The evaporation of the water from the muslin always leaves in its meshes a small quantity of solid material, which sooner or later somewhat stiffens the muslin so that it does not readily take up water. This will be the case if the muslin does not readily become wet after being dipped in water. On this account it is desirable to use as pure water as possible, and also to renew the muslin from time to time. New muslin should always be washed to remove sizing, etc., before being used. A small rectangular piece wide enough to go about one and one-third times around the bulb, and long enough to cover the bulb and that part of the stem below the metal back, is cut out, *thoroughly wetted* in clean water, and neatly fitted around the thermometer. It is tied first around the bulb at the top, using a moderately strong thread. A loop of thread to form a knot is next placed around the bottom of the bulb, just where it begins to round off. As this knot is drawn tighter and tighter the thread slips off the rounded end of the bulb and neatly stretches the muslin covering with it, at the same time securing the latter at the bottom.

To make an observation, the so-called wet bulb is thoroughly saturated with water by dipping it into a small cup or wide-mouthed bottle. The thermometers are then whirled rapidly for fifteen or twenty seconds; stopped and quickly read, the *wet bulb* first. This reading is kept in mind, the psychrometer immediately whirled again and a second reading taken. This is repeated three or four times, or more, if necessary, until at least two successive readings of the wet bulb are found to agree very closely, thereby showing that it has reached its lowest temperature. A minute or more is generally required to secure the correct temperature. In whirling and stopping the psychrometer

the arm is held with the forearm about horizontal, and the hand well in front. A peculiar swing starts the thermometers whirling, and afterward the motion is kept up by only a slight but very regular action of the wrist, in harmony with the whirling thermometers. The rate should be a natural one, so as to be easily and regularly maintained. If too fast, or irregular, the thermometers may be jerked about in a violent and dangerous manner. The stopping of the psychrometer, even at the very highest rates, can be perfectly accomplished in a single revolution, when one has learned the knack. This is only acquired by practice, and consists of a quick swing of the forearm by which the hand also describes a circular path, and, as it were, follows after the thermometers in a peculiar manner that wholly overcomes their circular motion without the slightest shock or jerk. The thermometers may, without very great danger, be allowed simply to stop themselves; the final motion in such a case will generally be quite jerky, but, unless the instrument is allowed to fall on the arm, or strikes some object, no injury should result.

The tables from which humidity may be calculated form Table IV of the Appendix and give the data for a barometric pressure of 29.0 inches of mercury. Their use is illustrated by the following example.

$$\begin{aligned} \text{Air temperature } t &= 75.0^{\circ} \text{ F.} \\ \text{Wet bulb reading } t' &= 66.0^{\circ} \text{ F.} \\ t - t' &= 9.0^{\circ} \text{ F.} \end{aligned}$$

In table opposite 75° in column 9.0 is found 63.

Relative humidity = 63 per cent.

If the barometric pressure had not been 29 in. a slight error would have been introduced whose magnitude may be judged from the following examples of the same problem at different barometric pressures.

Barometric pressure 30	Relative humidity 63
Barometric pressure 27	Relative humidity 63
Barometric pressure 25	Relative humidity 64

The Weather Bureau report 235 referred to above gives fuller tables and may be obtained from the Bureau for 10 cents.

17. Non-continuous Water Heating Calorimeters.—In the third edition of his *Gas Analysis*, Hempel described a calorimeter where a volume of about a liter of gas was measured in a glass cylinder, passed through a small burner and burned in a stream of oxygen within a calorimeter containing a known mass of water. The rise in temperature of the water gave the data for the calculation of heat value, after the instrument had been calibrated by the combustion of hydrogen.

The *Graefe calorimeter* is a commercial instrument of the same general type but somewhat larger. The instrument is rather crudely constructed and allows the exhaust gases to escape at an unduly high temperature so that it is necessary to calibrate it against some standard calorimeter. An inherent defect in calorimeters of this type comes from the increasing temperature of the exhaust gases as the test proceeds and the water of the calorimeter becomes warmer.

The *Parr*¹ *calorimeter* aims to compensate for this error and errors due to moisture in the exhaust gases by providing two duplicate calorimeters, one of which runs on pure hydrogen while the other is testing the unknown gas. The variation from the correct result shown by the hydrogen calorimeter is taken as the correction to be applied to the other result. The Committee on Calorimetry of the American Gas Institute in its 1912 report states that this calorimeter if properly operated gives correct results but that it is rather complicated in construction and requires more skill for its proper operation than the other types. The instrument gives total heating values only.

The *Doherty calorimeter* is a compact instrument which measures the gas in an annular cylinder surrounding the combustion chamber and its water jacket. The gas is displaced by the warmed water which has flowed through this water jacket or heat absorption chamber, and thermometer readings are taken as the water level passes fixed points on the gage glass. No meter is required and the water is neither weighed nor measured. The Committee on Calorimetry of the American Gas Institute in

¹ *J. Ind. and Eng. Chem.*, 2, 337 (1910).

its 1912 report states that this calorimeter when operated properly gives the same efficiency as the Junkers calorimeter.

18. Automatic and Recording Gas Calorimeters.—The formula for the calculation of the heating value of a gas as given in § 11 of this chapter is $H.V. = \frac{m(t' - t)}{V}$. It is evident that if

the ratio $\frac{m}{V}$ can be kept a constant and t can also be kept constant that the heating value can be readily determined from a single reading of t' or can be continuously determined by a recording thermometer showing the temperatures of the outlet water. In the Junkers continuous calorimeter the ratio $\frac{m}{V}$ is kept constant by passing both gas and inlet water through meters whose drums are geared together by a chain forcing them to rotate always proportionately. There are various other types of automatic calorimeters. In every case they should be checked occasionally by a direct determination with a standard instrument.

19. Calculation of Heating Value from Chemical Composition.—If the heating value and the proportion of each constituent in a mixed gas is accurately known, it is possible to calculate the heating value of the mixture. Table IX gives the heating value as well as other properties of a number of gases.

If each constituent in the gas were known, the heating value calculated from this data would probably give accurate results. However, when it is noted that among the olefines, propylene has a heating value approximately 50 per cent. greater than ethylene, and butylene a heating value almost double that of ethylene it will be seen that there is dangerous latitude for arbitrary assumptions as to the constituents of the olefines. When the "illuminants" as reported include not only the olefines but benzene the error involved in an arbitrary assumption of the mean heating value becomes still greater. The varying members of the methane series also possess widely differing heating values. Earnshaw¹ gives an analytical method for determining the mean composition of the olefines and for differentiating between me-

¹ *Jour. Franklin Inst.*, 146, 161 (1898).

thane and ethane. The method is, however, difficult analytically, and the results when obtained are not entitled to the degree of confidence which pertains to those obtained directly in a calorimeter.

The probable error involved in this method of calculating the heating value of gas (unless Earnshaw's complex analysis is followed out) is about 5 per cent. In the case of carburetted water gas it is still higher. In the case of producer gas where the total percentage of hydrocarbon is low *and where all suspended tar particles have been removed* the results are more accurate.

CHAPTER VIII

CANDLE POWER OF ILLUMINATING GAS

1. Introduction.—The use of candle power as a standard test of illuminating gas was practically universal before 1900. The most efficient of the early types of gas burner was the Argand and quite naturally it was used as the test burner. When carburetted water gas of high candle power came into use a bats-wing burner was found to be more efficient and was in some cases allowed. The Welsbach mantle was developed later and its efficiency was found to be more nearly in proportion to the heating value of the gas than to its candle power. The proportion of gas burned in luminous flames is now so small in proportion to that burned for development of heat that tests of candle power have become of minor importance and are in a fair way to become obsolete as a criterion of quality of gas. Photometry deals with the measurement of the intensity of light. The term light as used here includes only those rays which excite vision in the human eye, which thus necessarily becomes the final arbiter in photometric tests. The eye cannot estimate absolutely the amount of light which stimulates it. It can compare roughly the intensity of illumination from two sources and it can determine with more precision when the intensities from two sources are the same. In the sense in which it is here used, photometry consists in the comparison of two lights, one of which is a standard. The photometer is a device which assists the eye in determining when the two lights are of the same intensity. The intensity of light entering the photometer is changed by varying the distance between the photometer and the light, the intensity of light from a given source varying inversely as the square of the distance. When the adjustments have been made so that the intensity of light impinging on the photometer from the two sources is the same, as shown by the equal illumination of the two photometer faces, the ratio of the unknown light to the standard light becomes mathematically calculable from the relative distances of the lights from the point of equal illumination. The value of

luminous intensity is in English-speaking countries and in France expressed in candle-power.

2. Method of Rating Candle-power.—The light emitted from a single incandescent particle would illuminate uniformly every point of an enveloping sphere and the intensity of illumination might be measured equally well at any point on the sphere. When the light to be measured comes from a surface of finite size as is always the case in practice, there is interference with the free path of the light waves from a single particle in one or more directions so that the illumination of the enveloping sphere is no longer uniform. It is possible by the use of reflecting mirrors to determine the illumination at various points on the circumference of a polar circle and to plot from this data a curve showing the distribution of light at various angles. Methods of this sort are often resorted to in a study of illumination where it is desired to determine the value of a light source for a particular purpose. This method is, however, rarely followed where it is simply a question of testing the quality of the gas. The simpler custom of taking the horizontal candle-power given by a conventionalized burner under conventional conditions as indicating the value of the gas, has become well established.

3. The Bar Photometer.—The bar photometer consists of a graduated bar which carries at one end a standard light and at the other end the test light. Upon the bar slides a carriage with an apparatus for comparing the illumination from the two sources. The carriage is to be moved back and forth until the point is found where the illumination from the two lights is equal, and its position on the graduated bar recorded. If now the distance of the comparison box from the standard light be called "a" and that from the unknown light "b," then the illumination of the unknown as compared with the standard light is expressed by the proportion,

$$\frac{\text{unknown}}{\text{standard}} = \frac{b^2}{a^2}$$

There are many modifications of this type of photometer but all involve the four essentials: a standard light, the unknown light, a photometric screen and a means of measuring the distance of each light from the comparison box. It is customary to have the two lights fixed at opposite ends of the bar, in which case the

sum of $a+b$ in the preceding formula is a constant. Sometimes however the standard lamp is placed on a sliding carriage connected by a rigid link with the photometric screen so that the distance "a" of the formula becomes a constant. A modification of the bar photometer in use in England is the table photometer where the two lights and the comparison box are all rigidly fastened at the points of a triangle. Comparison is effected by varying the rate of combustion of the gas being tested until equality of illumination is reached. Its candle-power is then mathematically determined. This method of determining candle-power is not in use in Germany or America.

The various essential parts of a bar photometer will be considered separately and the details of its operation will then be described.

4. Standard Light.—The early photometrists used as their standards candles of varying size. In 1860, the English parliament adopted as standard the sperm candle $7/8$ in. in diameter and burning at the rate of 120 grains per hour. In 1884, Hefner v. Alteneck brought out the amylacetate lamp which became a widely used standard for testing the candle-power of gas. The Harcourt 10 candle pentane lamp was proposed in 1898 and has been adopted as the official source of light by the Gas Referees of London. It has many advantages. All of these flame standards vary materially in candle-power with change in atmospheric conditions and are, for scientific work, to be corrected to standard conditions of temperature, pressure, humidity and percentage of carbon dioxide in the air. In ordinary work when used in measuring candle-power of gas flames they are however not thus corrected but the assumption is made that the standard light and the gas light are equally affected by atmospheric conditions.

The only satisfactory standard not affected by atmospheric conditions is the incandescent electric lamp. Incandescent lamps properly aged may be bought with the certificate of the Bureau of Standards and furnish the most reliable photometric standards when used under proper conditions. These conditions, however, require that the lamp shall be supplied with current at perfectly definite voltage from a large storage battery equipped with suitable rheostats and electrical measuring instruments so that the installation is an expensive one, and is used only in re-

search laboratories. When the incandescent electric standard is used in the photometry of gas flames correction must be made for the effect of atmospheric conditions on the flame. This correction is not infrequently as much as ten per cent., and has been accurately determined for only a few of the standard lights.

5. Photometric Units.—The international candle is the common unit of intensity in England, France and America, having been officially adopted by agreement of the government standardising laboratories of the three countries in 1909. Prior to that date the official unit in this country had nominally been the British Parliamentary candle but there had not been definite agreement as to its value. In Germany the photometric unit is the Hefner which equals 0.90 International Candles. Conversely 1 International Candle equals 1.11 Hefners. The history of the adoption of the International Candle may be found in the reports of the Bureau of Standards and in the Proceedings of the American Gas Institute.¹

Although there is thus an international unit of light, the international candle, it does not follow that this unit is best obtained by burning any actual candle. In fact various other standard lights are preferable.

6. Standard Candles.—In 1860 the Gas Referees of the City of London adopted as their unit the light emitted by a sperm candle of 1/6 lb. weight when burned at the rate of 120 grains per hour. From time to time they issued specifications for the manufacture of candles to fulfill this requirement but were never successful in ensuring uniform quality and in 1897 entirely discontinued the use of candles. The Dutch Photometric Commission reported in 1894, after an exhaustive study, that the average light from a good English Parliamentary candle might exceed or fall below that of the average candle by nine per cent. The use of candles as standards is deservedly decreasing.

When candles are to be used they are burned on a candle balance placed on the photometer bench. A simple form of balance is illustrated in Fig. 26. A long candle is cut in two and both halves used simultaneously. They are to be allowed to burn until the cups have formed normally and the wicks have bent over till the tips are glowing in the outer flame. The

¹*Proc. Am. Gas. Inst.* 2, 454, 528 (1907); 3, 403 (1908); 4, 78 (1909).

candles are then to be turned so that the glowing end of one wick points towards the photometer and that of the other points in a direction at right angles to that of the first. They should project 1 to 1 1/2 in. above the holder and should burn clearly and without guttering. When all is in readiness for a test, the counterpoises are adjusted so that the candles are slightly too heavy for a perfect balance. As they burn away the pointer on the scale falls and as it passes the zero mark the stop watch is started. A 20-grain weight is then placed on the pan below the candles and photometric readings are made each half-minute.

At the expiration of four and a half minutes the observer returns to the candle balance and stops the watch when the pointer again is at the zero mark, indicating that the 20 grains of sperm have been burned. If the candles are burning at exactly the proper rate the watch should show that exactly five minutes have elapsed. If the variation in the amount of sperm burned per hour is not over 5 per cent. from the standard amount it is permissible to make a mathematical correction, the as-

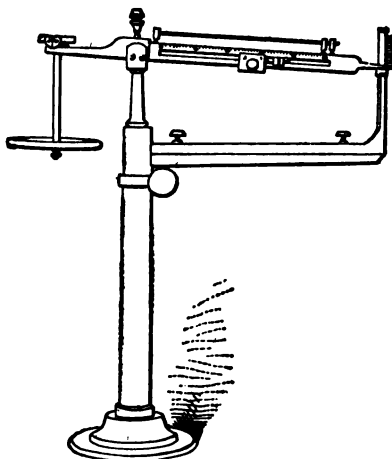

FIG. 26.—Candle balance.

sumption being that the light evolved is in direct proportion to the weight of candles burned. If the observed weight of sperm burned by the two candles is 250 grains per hour instead of 240 the value of the light is said to be $2 \times \frac{250}{240} = 2.08$ candles. If the deviation is greater than 5 per cent. the test must be rejected and a different candle used. Improper ventilation and too high a temperature in the photometer room will affect the burning of the candles. This subject is discussed in § 18.

7. The Hefner Lamp.—The dimensions of the Hefner lamp have been rigidly specified by the German Reichsanstalt¹ which

¹ *Jour. für Gasbel.*, 36, 341 (1893).

will certify a lamp to be correct if it is properly made mechanically and gives a light which does not differ more than 2 per cent. from the official lamp of the Reichsanstalt. The construction of the lamp is shown in Fig. 27. It consists of a brass bowl into which a head screws carrying the German silver wick tube and the mechanism for controlling the height of the flame. The flame height is determined by a gage which clamps to the head-piece. The older form of gage shown at A consists of two sights, one on each side of the flame. The newer Krüss optical gage shown at C consists of a ground glass screen and a magnify-

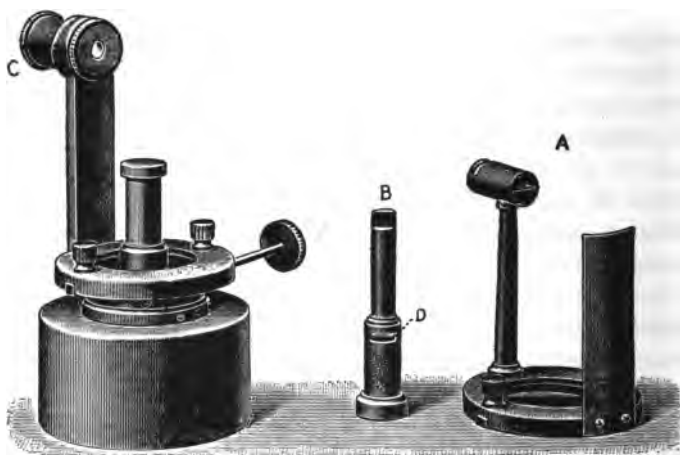

FIG. 27.—Hefner lamp.

ing lens which allows more delicate adjustment of the flame tip to the horizontal line across the gage. Each lamp is provided with a control gage shown at B which fits over the wick tube and sits squarely on the head-piece. With the control gage in this position and the lamp level an observer looking toward the light should see through the openings D a very fine ray of light less than 0.1 mm. wide between the top of the wick tube and the control gage, and looking through the optical gage should see the cross-hair in exact coincidence with the broad top of the control gage. The wick tube is screwed into the head-piece and if it becomes necessary to change its height the control gage,

inverted, is to be pushed down the wick tube and used as a handle. The exact material of which the wick is made is not of importance but it must fill the tube snugly but not tightly. It is best to use only that furnished by the manufacturers. The amyl acetate must be of good quality and certified to be fit for photometrical purposes.

In using the Hefner lamp the bowl is to be filled about two-thirds full of amyl acetate and after the wick has been moistened by capillary action it is to be screwed somewhat above the wick tube and cut squarely off. The lamp is then to be lighted, and allowed to burn at least ten minutes with occasional regulation of the flame height before a test is commenced. The temperature of the photometer room should be between 60° and 70° F. The lamp is to sit on a horizontal support in a room free from drafts and adequately ventilated.

The flame height of the Hefner lamp is to be carefully adjusted since a deviation of 1 mm. from the correct flame height of 40, introduces an error of about 3 per cent. It is the luminous tip of the flame which is to be 40 mm. high. With the Krüss optical gage the frosted glass cuts out the almost colorless outer flame so that there is no possibility of confusion. With the older Hefner gage the luminous tip should appear tangent to the lower edge of the sighting plane.

If the lamp is used only infrequently it should be emptied after use and both lamp and wick should be washed with alcohol. It is wise to throw away the old amyl acetate and clean the lamp in this manner at intervals even when it is in frequent use since the amyl acetate decomposes somewhat on standing.

The Hefner lamp gives a light of 0.9 international candles when burned in pure air under 760 mm. barometric pressure and containing 8.8 liters of water vapor per cubic meter. Although atmospheric conditions must be controlled and correction made in exact scientific work corrections are usually omitted in taking candle-power of gas on the assumption that atmospheric conditions affect the Hefner lamp and the gas burner to a similar degree. The errors involved in this assumption are discussed briefly in § 18. The Hefner lamp is a widely used standard. It is portable, cheap, and relatively accurate. Its disadvantage is its

low candlepower, and the tendency of the flame to flicker, especially at summer temperature.

8. The Pentane Lamp.—The 10 candle pentane lamp or Harcourt lamp was adopted as standard by the London Gas Referees in 1898.¹

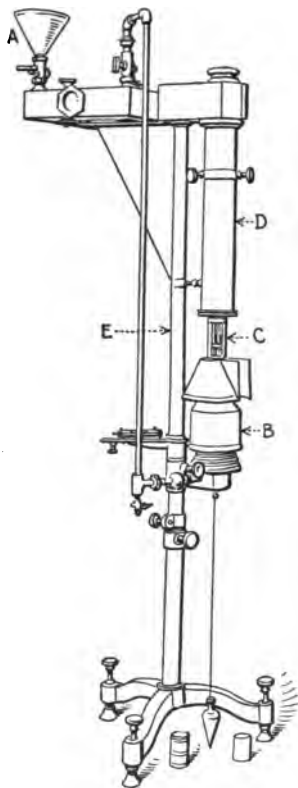

FIG. 28.—10 candle power pentane lamp.

Fig. 28 shows this lamp with some improvements in details recommended by the Bureau of Standards and added by the American manufacturers. In this lamp air entering at A passes over pentane and becomes saturated with pentane vapor. The air-gas so formed descends by gravity to an Argand burner B enclosed in a metal hood. The flame is drawn into a definite form and the top of it is hidden from view by a long brass chimney C. The chimney is surrounded by a larger brass tube D in which air, warmed by the chimney, rises and descends through the tube E, which is also the main standard of the lamp, to the center of the Argand burner where it aids in the combustion of the gas. The lamp may be obtained with the certificate of the Bureau of Standards.

Before using the lamp the saturator is to be filled about two-thirds full of pentane and both cocks on the saturator are to be closed. As pentane is very volatile and mixtures of its vapor and air within certain proportions are explosive care must be taken that no flames are burning in the room while the lamp is being filled. The inner chimney above the burner must be centered by the adjusting screws, turned so that the mica window is away from the photometer box and set at the proper height by placing on the burner the 47 mm. block which accompanies the

¹*Jour. of Gas Lighting*, 71, 1252 (1898).

lamp, and lowering the chimney till it rests lightly on the block. To prepare the lamp for lighting, open the outlet cock on the saturator and the drip cock. This will fill the feed pipe with pentane vapor and air. Open the inlet cock on the saturator, close the drip cock, open the regulating cock at the burner and light the gas at once. It requires about fifteen minutes for the flame to become constant and during this period the top of the flame should be kept approximately on the cross bar of the mica window. The lamp should be set for maximum luminosity which condition is attained when the flame is just high enough so that the non-luminous upper portion is cut off from the photometric screen by the chimney. In case of doubt the proper setting may be determined by lighting the gas flame at the other end of the bench and determining with the photometer the setting of the lamp which gives maximum illumination.

In leaving the lamp after a test both the inlet and the outlet cocks of the saturator should be closed. After about a gallon of pentane has been burned the liquid remaining in the saturator should be emptied out and thrown away.

9. Secondary Standards of Light.—The Hefner lamp, the 10 Candle Pentane lamp and, to a lesser degree, standard candles are primary standards since they are readily, if not entirely accurately, reproducible. There are various secondary standards which are convenient to use when frequent candle-power determinations are to be made but which must be standardized at intervals by direct comparison with a primary standard. Most of these standards are based on the fact that the brightest portion of a lamp flame is of almost constant luminosity.

The Edgerton Standard burner consists of a Sugg "D" burner provided with a glass chimney $1\frac{3}{4}$ in. in diameter and 7 in. high. Outside of this glass chimney is a brass sleeve with a horizontal slot $\frac{13}{32}$ of an inch high through which the light passes to the photometer. This is nominally a five candle-power standard but will actually vary from four to seven candles. After the value with a given gas has been fixed it will not vary much if the candle-power of the gas feeding it does not vary over two candles. The chimney must be cleaned frequently and the lamp restandardized each time a new chimney is put into service.

The Elliot lamp is a student lamp of special design with a

flat wick and a rather large chimney and a screen which cuts off all but the desired portion of the flame. The lamp uses kerosene as its fuel and is nominally a ten candle-power lamp. Its illuminating value with a single lot of good kerosene is of very satisfactory constancy.

10. Standard Gas Burners.—At the time when gas testing commenced to be standardized the Argand burner was the form in common use. This type was therefore naturally adopted as the standard. It was also recognized that it was only right to

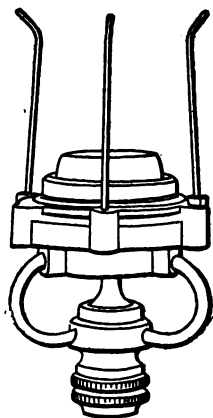

FIG. 29.—D Argand burner.

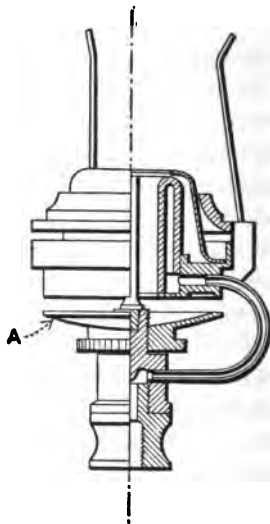

FIG. 30.—Metropolitan No. 2 Argand burner.

test the gas in a burner which was adapted to it and therefore various standards came into vogue in England, such as the Sugg D Argand illustrated in Fig. 29, which is intended for gases of less than 16 candle-power. The Sugg F burner is intended for gases of 16–20 candle-power.

In 1905, in connection with a readjustment of the price and candle-power of the gas supplied in London the Gas Referees were directed by Parliament to use a burner adapted to obtain from the gas the greatest amount of light when burned at the rate of five cubic feet per hour. In accordance with these instruc-

tions the Gas Referees adopted the Metropolitan No. 2 Burner shown in Fig. 30. This burner differs from the older types mainly in having an adjustable air supply to the center of the burner. The burner is designed for all qualities of gas up to 20 candle-power. When lighting the burner the air regulating disc A is to be screwed down so that the full supply of air passes to the burner, and the burner is to be adjusted to approximately the five cubic foot rate. After allowing it to burn for fifteen minutes to become thoroughly warm the gas is to be adjusted carefully to the rate of 5 cu. ft. an hour, after which the air regulator is to be screwed upwards until the flame rises in the chimney as high as possible without smoking. The Metropolitan No. 2 Argand gives results materially higher than the ordinary Argand on gases of low candle-power.

Bray's No. 7 Slit Union burner is frequently used with carburetted water gas of more than 20 candle-power. The rate of gas consumption is as usual adjusted to 5 cu. ft. an hour.

11. The Bunsen and Leeson Photometric Screens.—The Bunsen photometric disc dates from 1841 and in its simplest form consists merely of a sheet of paper with a grease spot in the center. This is mounted so that it may be moved back and forth between the two lights. When looking toward the stronger light the translucent grease spot appears bright. As the carriage is slowly moved away from the stronger light the contrast between the spot and the surrounding paper diminishes and almost disappears when equality of illumination is reached. If the carriage is moved still further in the same direction the grease spot stands out dark against the white background. The paper screen is usually mounted in a box as shown in Fig. 34 where by an arrangement of mirrors the observer standing in front of the instrument may see both sides of the screen at once. This form of apparatus is still frequently used.

The Leeson star disc is a modification of the Bunsen screen. It consists of a piece of opaque paper from whose center is cut a star and which is pressed between two sheets of translucent paper.

12. The Lummer-Brodhun Photometric Screen.—This is a very accurate form of photometer which is shown diagrammatically in Fig. 31 and in perspective in Fig. 32. It consists

of a series of reflecting surfaces and prisms which direct light rays from the two sources into a telescope tube. Light entering from the two opposite sources R and L is diffusely reflected by the

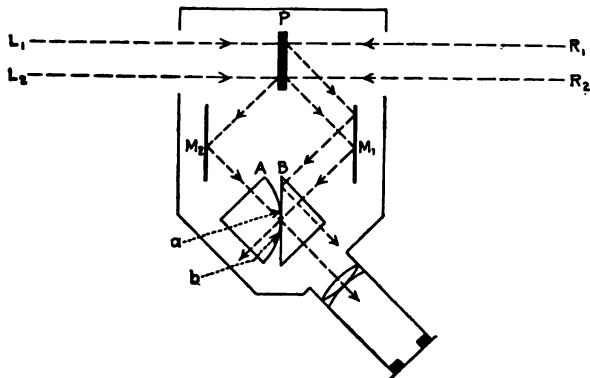

FIG. 31.—Diagram of Lummer-Brodhun photometric screen.

opaque plaster of paris disc P onto the mirrors M₁ and M₂ and by them to the prisms AB. The prism A has most of its hypothe-

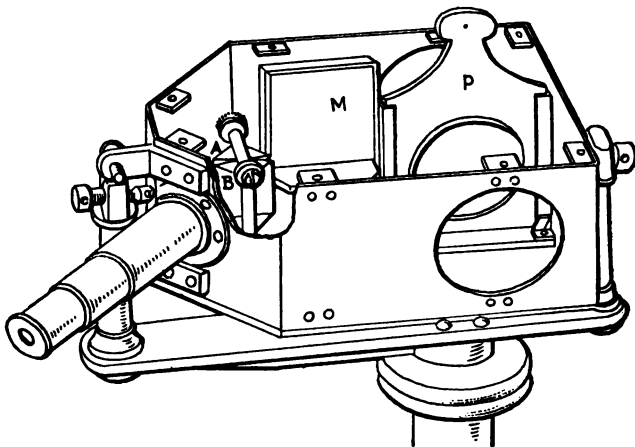

FIG. 32.—Lummer-Brodhun photometric screen.

nusal face ground away, only a small circular plane being left in the center. The two prisms are clamped closely together and become optically homogeneous over this small circular area shown

at ab. Of the light coming from L only that reaches the telescope which passes through this circular spot, the path of the rays being shown from L₂. Of the light from R, that which strikes the spot ab passes on undeflected and is absorbed by the black walls of the box. The path of these rays is shown from R₂. The other rays suffer total reflection into the telescope as shown in the rays from R₁. The image in the telescope appears, therefore, as a circular spot illuminated from L in a circular field illuminated from R. In this equality photometer when the illumination from the two sources is identical the spot and the field are not to be distinguished from one another.

In the Lummer-Brodhun contrast photometer advantage is taken of the physiological fact that the eye is able to perceive a smaller degree of difference in contrast than difference in brightness. By suitably cutting the prisms the image in the telescope is divided into four portions as shown in Fig. 33. In this figure the shaded trapezoidal space A' is illuminated from the same source as the shaded semi-circular area A. Similarly B and B' are illuminated from the same source. However, although the areas A and A' are illuminated from the same source, they are not equally illuminated, for through the interposition of a plate of glass before A' it receives about four per cent. less light than A. B' is in the same way and to the same degree less brilliantly illuminated than B.

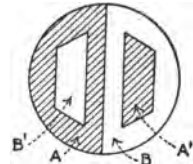

FIG. 33.—Field of Lummer-Brodhun contrast photometric screen.

If, now, the light from the two sources is exactly the same both in intensity and color the semi-circular fields A and B will be identically illuminated and will not be distinguishable from one another. The trapezoidal figures A' and B' will also be identically illuminated and will stand out with the same relief from their respective backgrounds. This can only happen when A and B are equally illuminated. It affords a more sensitive ocular test of the equality of A and B than can be obtained by comparing them directly. The lights at the two ends of the bench are never of absolutely the same, and are sometimes of a widely differing, color. When a Welsbach light is tested against the Hefner lamp the field illuminated from the mantle burner is a clear blue color while the other is a yellow. The eye cannot determine with much

accuracy when the yellow field and the blue one are illuminated to the same extent, but it can determine with greater accuracy when the yellow trapezoid A' stands out from its blue background with the same distinctness that the blue trapezoid B' stands out from its yellow background. The eye judges slight contrasts more accurately than large ones and therefore it is most sensitive when the photometer is almost at the neutral point. It is well to make an approximate setting for equality of A and B and then focus the attention on the contrast between the trapezoids and their respective backgrounds and complete the adjustment.

13. The Flicker Photometer.—In the various forms of flicker photometer the light from each source is presented alternately and rapidly to the eye by means of revolving discs or prisms in the photometer box. When the intensity of light from the two sources is the same the flicker vanishes. No difficulty is experienced with lights of varying colors, but the photometer is fatiguing to the eye and its proper adjustment requires considerable skill.

14. The Gas Meter.—The meters used in photometric work are of the same general type of wet meter as those described in § 3 of Chapter VII for calorimetric work. They must be calibrated with the same care and used with the same precautions. It is more convenient, however, to use a smaller meter which passes only 1/12 cu. ft. per revolution. When the gas is being burned at the rate of 5 cu. ft. an hour this meter will make exactly one revolution a minute. The dial of the meter is graduated into five parts with finer subdivisions. An observation of one minute will therefore give directly the uncorrected gas consumption in cubic feet per hour. Great care must be taken to see that the water of the meter is saturated with gas of the sort that is to be tested, for the "illuminants" of the gas are relatively soluble in water and a slight change in their percentage makes an appreciable difference in the candle-power of the gas.

15. The Photometer Bench and Its Equipment.—The preceding sections have discussed the various types of standard lights, burners and photometers which may be used. It is evident that wide latitude may be exercised in the choice of units and the method of assembling them to form a photometer bench.

The details regarding the length of bar, type of standard light,

form of test burner, kind of comparison box, and the directions for testing are in some cases controlled by legal enactment and are in some cases matters of arbitrary choice. It is under all circumstances necessary that the meter, standard light, and gas burner be thoroughly reliable. The photometric screen may be of cheaper type and the bench itself may be of simple wooden construction with the scale made of yard sticks joined together. The bar most commonly used in America is 60 inches long. This is sufficiently accurate where ordinary gas flames are being tested. For lamps of high candle-power longer bars are desirable.

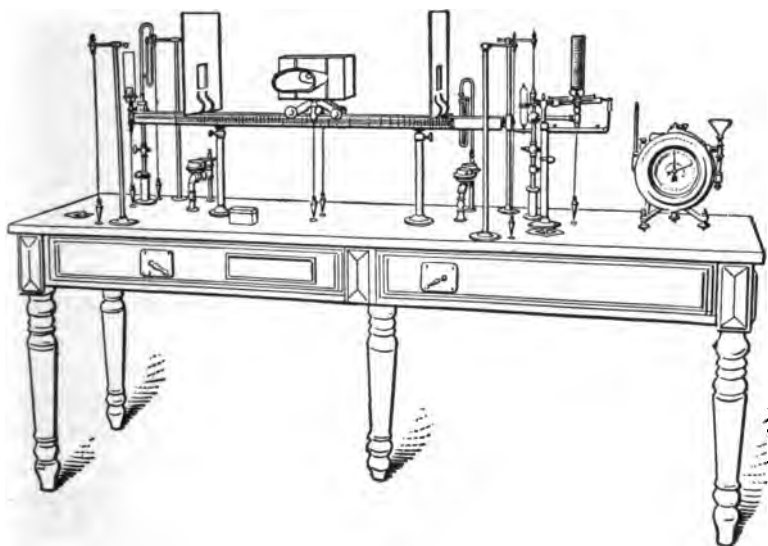

FIG. 34.—Photometer bench.

A photometer bench frequently used is shown in Fig. 34. At the right hand end is shown the meter and next to it the candle balances in position, with the Edgerton standard burner on a swinging arm so that it may be used instead of the candles. At the left hand end is the Argand burner for the gas and between the two the bar itself with its screens and photometer. The piping for the gas is entirely below the table top but the pressure regulators and gages are shown above the table at the back.

Precision photometers usually follow the German, or Reichs-

anstalt, pattern in which the bar is built up of a rigid steel track on which the carriage of the photometric screen travels. The standard light and the test light are usually also mounted on a travelling carriage with provision for clamping them rigidly at any desired point of the bench. The length of the bench may thus be varied at will.

16. Details of a Test.—The details of a test will of course vary with the equipment of the photometer bench and especially with the type of standard light employed. Directions for the use of these lights have been given in preceding sections. In the following paragraphs will be found general directions which are applicable to most forms of apparatus.

The meter is to be examined to see that the water-level is correct and if necessary more water is to be added. In case the test is unusually important the meter should be calibrated against a tank of known volume. The tightness of connections between the meter and the burner is to be assured by turning the gas into the meter while keeping the stopcock on the burner closed. The meter hand should not show any perceptible motion in one minute. If there is a small leak allowance may be made for it in the calculations, but it is vastly better to have the whole apparatus tight.

A clean chimney is to be placed on the Argand burner and the burner lighted. The pressure gage between the diaphragm governor and the burner should indicate about 1 in. of water pressure depending on the exact type of burner used. The consumption of gas is to be set so that the meter hand makes a revolution in approximately a minute and the light is then allowed to burn for at least fifteen minutes. If the meter has had much fresh water added to it, or if it was last used for a gas of a different quality than the one soon to be tested, or if the gas is being drawn from long lengths of pipes where the gas lies dead, a longer time than fifteen minutes must be allowed to elapse before commencing the test which must not be started until it is certain that the gas burning is of representative quality and that it has not been changed by contact with the water of the meter.

The final adjustment of the gas is made after taking into consideration the meter temperature and the barometric pressure. The desired rate of consumption being 5 cu. ft. measured under

standard conditions, the correct apparent rate may be mentally calculated by adding to the 5 ft. 0.01 cu. ft. for each degree Fahrenheit shown by the meter thermometer above 60, and adding 0.03 ft. for each 0.1 in. of mercury pressure below 30. For example, if the meter temperature is 80° F., and the barometric reading is 29.5 the uncorrected consumption of gas per hour should be $5.0 + .20 + .15 = 5.35$. The gas is to be set to this desired flow with an error of less than 1/10 cu. ft. The stopwatch is started as the hand crosses the zero and stopped after one complete revolution. It should read between 59 and 61 seconds. After the gas has been satisfactorily adjusted and the standard lamp given a final adjustment the test may be commenced.

The observer starts the stopwatch as the large hand of the meter passes the zero and steps quietly to the photometer avoiding sudden movements which would create drafts, and makes and records the first observation. Four more readings are made at intervals of about twenty seconds and then the photometric screen is reversed and five similar readings taken. If the lights flicker during an adjustment the observer must wait until the drafts have subsided before completing the observation. The series of ten observations usually requires about five minutes. At their conclusion the operator steps back to the meter and stops the watch as the large hand of the meter again passes the zero.

If a stopwatch is not available it is better to make the test during an even number of minutes rather than during the consumption of an even number of cubic feet of gas. If the observer holds the watch close to the meter and keeps his eyes on the watch till the second hand reaches the zero and then reads the position of the large meter hand, and follows the same procedure at the close of the test, the error will be well within the other necessary errors of the process. In case a stopwatch is available, it is more accurate to start the watch as the meter hand comes to its zero and to conclude the observation when the meter hand passes its zero, after the photometric observations have been completed.

17. Illustration of Calculation.—The calculation which follows is for a test made on a 2500 mm. bench with a Hefner light as the standard.

Date, Feb. 26

Source of Gas. Proportional Tank. Test 42. Experimental Gas Plant.

Gas burned in London Argand.

Standard Light—Hefner.

	Time	Meter Reading
Commencement of Test	10 : 16 : 00 A. M	47.8
End of test	10 : 21 : 00	50 + 24.6 = 74.6

Duration 5 : 00

Difference in meter readings	26.8
Cubic feet gas per hour uncorrected.....	5.36
Meter Temperature 80° F. Error in meter less than 0.1 per cent.	
Barometer 29.5 inches. Correction factor.....	0.930
Cubic feet gas per hour uncorrected 5.36. Corrected.....	4.98
Bar Readings 454, 456, 455, 462, 460	
460, 458, 460, 463, 464 Average 462.	

$$\text{Calculation } \left[\frac{(2500 - 462)^2}{(462)^2} = \frac{X}{.9} \right] \times \frac{5.00}{4.98} = 17.6 \text{ candle-power.}$$

18. The Photometer Room.—The photometer bench must be placed in a room of reasonably constant temperature which is free from drafts and yet well ventilated. A room ventilated so that the carbon dioxide does not rise above ten parts in 10,000 during a test is as much as can be expected in ordinary work. The carbon dioxide may rise to twenty parts without the air being more polluted than in an ordinary crowded street car in winter. The water vapor normally present in the air and that given off by the flames and the respiration of persons in the photometer room exerts an even greater influence on flames than the carbon dioxide but since its accurate determination is difficult, the carbon dioxide is usually taken as the measure of contamination of the air.

The committee on Photometry of the American Gas Institute¹ has published some curves showing the variation of certain flames with increased carbon dioxide when compared with an incandescent electric lamp. The humidity of the air varied so much from day to day that a comparison of one day's work with another could not be made and the following figures from their curves must be taken as merely illustrative of the large errors that may arise.

¹ *Proc. Am. Gas. Inst.*, 11, 480 (1907).

COMPARISON OF PENTANE LAMP WITH GAS FLAME

Parts CO ₂ in 10,000.....	10.0	20.0
Per cent. loss of candle-power of gas flame.....	4.0	20.0
Per cent. loss of candle-power of pentane flame.....	7.5	31.0

COMPARISON OF PENTANE LAMP WITH CANDLES

Parts CO ₂ in 10,000.....	10.0	20.0
Per cent. loss of candle power of candles.....	19.0	27.0
Per cent. loss of candle power of pentane flame.....	13.0	16.5

It is therefore evident that the usual assumption that the standard light and the test light are equally affected by atmospheric conditions, is erroneous and that care should be taken to have the test made under as favorable atmospheric conditions as possible.

19. Jet Photometers.—There are two main types of jet photometers. In one type, gas passes through a pressure regulator and issues at constant pressure through a small round orifice where it burns in a jet whose height as read on the glass chimney is assumed to give candle power directly. In the other type of jet photometer the gas flame is kept at a constant height and the pressure required to force the gas through the burner opening is measured as an indication of candle power. No type of jet photometer can be relied on to do more than give approximate determinations. They should be calibrated frequently against a bar photometer.

20. Accuracy of Photometric Work.—When it is recalled that a Hefner lamp is considered as correct if it is within 2 per cent. of the standard, and that the absolute value of the pentane lamp may vary as much as 25 per cent.¹ in the course of a year on account of changing atmospheric conditions and further that the human eye is a very inaccurate scientific instrument, a greater accuracy than half a candle can hardly be expected with illuminating gas tested under ordinary conditions. Much larger errors may creep in unless care is taken.

¹J. B. Klumpp, *Proc. Am. Gas Light Assoc.*, 1905. Appendix.

CHAPTER IX

ESTIMATION OF SUSPENDED PARTICLES IN GAS

1. Introduction.—The estimation of particles held in suspension in gases is daily becoming of greater importance on account of legal restrictions on pollution of the air and on account of insistence on closer control of industrial operations by manufacturers. The problem is one of great difficulty and is usually susceptible of only approximate solution. Not only is it difficult to obtain the suspended solids present in a flue at a given point and time, but it is difficult to determine whether the solids thus determined were normal in amount or whether they were, for instance, low because of the deposition of an unusually large proportion prior to the point of sampling on account of slower velocity of gas in the main, or because of lower temperature or for some other reason.

2. The Distribution of Particles in the Cross-section of a Straight Main.—If the main is horizontal it is evident that there will tend to be a stratification of the particles, the large and heavy particles separating faster than the fine and light. This tendency to settle is, however, resisted by the whirling motion which gases traversing flues frequently possess and which is frequently caused by the inequalities in pressure produced by bends in the pipe. The velocity of gas in a straight main at ordinary working speeds is greatest at the center and least at the walls. The shape of the wave front varies with the speed of the gas, high velocities accentuating the difference. Solid particles are pushed gradually out of the zone of high velocity into one of lower velocity in the same way that a piece of wood in a river is gradually pushed to the still waters along the bank. This action takes place in a vertical as well as a horizontal main.

The solids contained in a gas at the point of greatest velocity will therefore be the least in amount, the smallest in size, and the lowest in specific gravity. The quantity of particles, their size and specific gravity will all increase in the regions where velocity

is least. In a normal round main this point of greatest velocity is the center where will be found the fewest and lightest solid particles. Their quantity and magnitude increase in successive rings to the circumference. If the velocity of the gas is decreased until the main is also acting as a settling chamber there will be little difference in the velocity throughout the cross-section and the region near the top of the main will contain the fewest solid particles.

This uneven distribution of suspended particles in a gas stream may take place very rapidly as was shown by the author¹ some years ago in an attempt to determine the amount of suspended tar in unpurified illuminating gas. A 14-in. main containing unpurified illuminating gas was tapped on its horizontal axis at a point a few feet beyond the exhauster and two sampling tubes inserted, one extending to the middle of the main and the other projecting through the wall only about an inch. Four tests were made and in each case the suspended tar caught in the sampling tube near the edge of the main was more than twice as great as that found in the tube projecting to the center.

3. Mean Velocity in the Cross-section of a Gas Main.—Threlfall² has shown that it is necessary to investigate the distribution of velocity for each individual case as it arises, but that in general the radius of the circle of mean velocity is about 0.775 of the radius of the pipe. In one case it was as high as 0.9 of the radius but in no case did it sink to 0.69 which is the figure quoted for water flowing through a long and smooth pipe. The radius of mean velocity did not change with varying speed of gas flowing through the pipe within the ranges of 600 ft. and 3600 ft. per minute, which marked the limit of the experiments. Threlfall's experiments were on pipes varying from 6 to 36 in. in diameter.

4. Influence of Bends in a Main.—If gas flowing through a straight main comes to a bend there will be a change in the relative velocities of the particles of the gas throughout the cross-section. The kinetic energy of a body is represented by the expression $1/2mv^2$ where m represents the mass of a body and v its velocity. It is evident therefore that the particles with the greatest mass and the greatest velocity will be projected beyond

¹ *Proc. Mich. Gas. Ass.*, 1906.

² *Proc. Inst. Mech. Eng.*, 1904, 1, 245.

their companions. The point of maximum velocity will shift from the center to a point nearer the opposing wall and will then slowly return to its normal position with a spiral movement. Solid particles on account of their greater mass may strike the opposing wall and if they or the wall are sticky may adhere there and build up deposits.

It will be evident, from what has preceded, that it will not be possible to find a single point in a gas main from which it is possible to draw a fair sample of gas for the determination of suspended solids. If a sample can only be taken at a single point, the termination of the sampling tube should be at about the point of mean velocity, as explained in the preceding section. In important tests it is advisable to draw a number of samples from various points in the cross-section of the main. A tube with numerous perforations along its length is useless for this work. Separate tubes should be used each with its own filter and aspirator as explained in Chapter I.

5. Velocity of Gas in a Sampling Tube.—The rate of flow through the sampling tube has a material effect on the accuracy of sampling as has also the inclination of the sampling tube to the gas stream. It is evident that if a sampling tube is inserted at A of Fig. 35 at right angles to the flow of gas, even assuming that the solid particles are uniformly distributed, the result will be incorrect for the heavy particles will tend to be carried past the open end of the tube and not drawn into it. The suspended solids will be reported low even if the speed of gas within the sampling tube is as high or even higher than that in the main. If, on the other hand, the opening of the sampling tube faces the approaching stream of solid particles as at B, on the same assumption of uniform distribution of particles, the result may be correct, or it may be high or low. If the speed of the gas in the sampling tube is the same as that in the main the result should theoretically be correct. The whole column of gas opposite the opening of the tube should enter without distortion. If, however, the

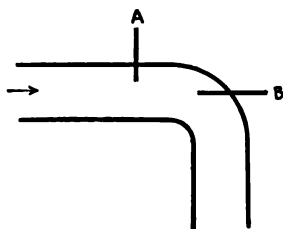

FIG. 35.—Diagram showing method of inserting sampling tube in gas main.

velocity in the sampling tube is lower than that in the main the column of gas approaching the opening will be disturbed and part of it will be forced aside. The solid particles will on account of their momentum not be pushed aside so readily and will therefore enter the tube in unduly great amount, giving a high result. If the velocity of the gas in the sampling tube is greater than that in the main there will again be a disturbance in the approaching column of gas. A column of gas larger than the opening of the tube will be sucked in, but the solid particles in the outer shell of gas thus sucked in will not be diverted from their course and will pass by the opening of the tube, giving a low result. Brady¹ states that in sampling blast-furnace gas an error of more than 44 per cent. was caused when the sampling speed was dropped to half that in the main. It is thus evident that the speed with which gas enters the sampling tube must be carefully controlled. The velocity of the gas must however be reduced before it passes through the filtering medium or the finely divided particles will not be taken out. The usual sampling tube has therefore a relatively small aperture. Care must be taken that the aperture is not so small that it will become clogged, which readily happens when tarry matters are present. Each case must be studied independently.

6. The Filtering Medium.—Where conditions permit, filter paper discs or shells make satisfactory filtering media. The Brady gas filter for dust in blast-furnace gas is described in the article referred to in the preceding section. A filter using a disc of filter paper as developed by Mr. W. S. Blauvelt² of the Semet-Solvay Company has been used by the author with good results. Various commercial filters of this type are now on the market.

When large amounts of tar are present a weighed tube filled with a fibrous material may with advantage be inserted ahead of the filter paper. The filtering materials to be inserted in the sampling tube will vary with conditions. If the temperature is high, sand or ignited asbestos is suitable. Ignited asbestos is usually to be preferred since on account of its fibrous nature it makes a more efficient and a lighter filter. This last consideration is of importance since the suspended solids collected frequently weigh only a few milligrams and it conduces to accuracy to have the increase

¹ *Jour. Ind and Eng. Chem.*, 3, 662 (1911).

² *Proc. Am. Gas. Inst.*, 4, 795 (1909).

in weight of the filter relative to its initial weight as large as may be. The tubes may be of glass, porcelain or quartz protected if desirable by an iron jacket. The tubes after filling and before use should be placed in an air bath heated to the temperature to which they are to be exposed later and dry air should be drawn through them until they are constant in weight. They should then be cooled in dry air, weighed, carefully stoppered and if possible kept in a dessicator until used. The asbestos for this purpose should not be soft enough to pack readily and choke the tube. The fine washed asbestos used for analytical work is not so good for this purpose as a cruder sort. Sometimes when much tar is present it is advantageous to procure the crude asbestos rock and merely crush it coarsely in an iron mortar.

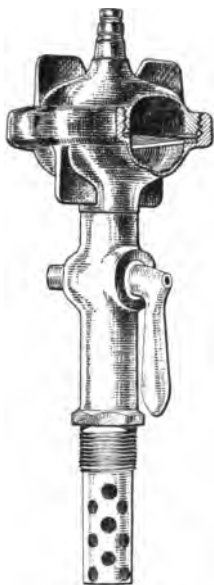

FIG. 36.—Tar camera for colorimetric tar determination.

7. Estimation of Suspended Tar and Water.—The amount of suspended matters caught by a filter paper may be estimated either by color or, if sufficient in amount, may be determined by weight. A second weight after drying at 105° C. for an hour will give by difference the moisture and other volatile matter, while the weight after ignition will give the mineral matter, correction being made if necessary for the change in composition due to ignition. The Steere Engineering Company manufactures a convenient filtering device which they name a tar camera and which is illustrated in Fig. 36. They furnish with it a colorimetric chart from which the amount of suspended tar may be determined directly by comparison of colors.

Where asbestos filters have been used a similar procedure may be followed provided the asbestos has been ignited before use. In drying the tube however it is not sufficient to heat it externally. Dry air must be drawn through until it comes to constant weight. The water will be driven off and also approximately 25 per cent. of the weight of the tar. The non-volatile tar remaining may afterward be extracted with

chloroform or carbon bisulphide, and this figure increased by one-third will give a rough estimate of the amount of tar present. It is not possible to determine accurately the amounts of water and suspended tar since it is not feasible to determine how much of the material volatilized is tar and how much is water.

8. Electrical Precipitation of Suspended Particles.—Where the expense warrants the installation of the process, the method of electrical precipitation as developed on the large scale so successfully by Cottrell¹ may be applied. The equipment consists of a small step-up autotransformer capable of giving 15,000–30,000 volts, a rectifier for this high-tension alternating current and a precipitating vessel which may be made of an iron pipe with an insulated electrode in the center. An exhaustor for aspirating the gas and a meter for measuring it must also be provided. This apparatus will quantitatively precipitate all suspended solid and liquid bodies including tar and operates on such large volumes that the precipitated materials can readily be examined.

¹*Jour. Ind. and Eng. Chem.*, 3, 542, (1911).

CHAPTER X

CHIMNEY GASES

1. Introduction.—A knowledge of the chemical composition of the gases escaping from a chimney aids much in controlling the efficiency of the furnace. It makes very little difference whether the fuel is burned to raise steam or to melt steel and it is of equally small importance whether the fuel burned be solid or liquid. The only assumption is that it is desirable to burn the fuel as completely as possible without the introduction of any unnecessary excess of air. When gaseous fuels are burned the same general principles apply but there is somewhat greater complication in calculation. This chapter therefore limits itself to a study of the gases arising from complete combustion of solid or liquid fuels. Let us see how much light a knowledge of the composition of the gas can throw on the operation of the furnace.

2. Sampling.—Samples should be drawn from a point as near to the fire as possible, while still allowing time for complete combustion. Irregular streams of unburned gases may arise from a bituminous coal fire with adjacent streams of almost unchanged air. Kreisinger, Augustine, and Ovitz¹ have shown that if samples are taken a short distance beyond the firebox of a furnace such as is used in boiler plants the percentage of carbon dioxide may vary from 0.8 to 15.6 per cent. in two samples taken simultaneously and only sixteen inches apart. When composite samples obtained over a period of eight minutes were drawn from points only eleven inches apart and four feet from the combustion chamber there was still a difference of 1.0 per cent. in the carbon dioxide of the two samples. If, however, the investigator goes a long distance from the point of combustion in an effort to obtain a fair sample, he runs the danger of finding his gases diluted by air pulled through leaks in the setting. The very greatest care must therefore be exercised in sampling chimney gases.

¹ Bul. 135 Bureau of Mines. Combustion of Coal and Design of Furnaces.

3. Formation of Carbon Dioxide.—Air is composed of practically 21 volumes of oxygen and 79 volumes of nitrogen and other inert gases. When oxygen unites with carbon there is formed carbon dioxide which is stable unless it comes into intimate contact with carbon or other reducing agent at a high temperature. Chemically the result is expressed as follows:

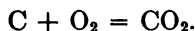

The expression means not only that carbon dioxide is formed by the union of carbon and oxygen, but also indicates that *one volume of carbon dioxide is formed from one volume of oxygen and that the volume of the smoke gases after cooling is the same as that of the air which was used.* This follows from the law of Gay Lussac which states that a molecule of one gas occupies the same volume as that of any other gas under like conditions. The simplicity of this volume relation makes it extremely desirable to work with volumes instead of weights in problems where gases are involved.

Since one volume of oxygen forms one volume of carbon dioxide it follows that the theoretically best composition of the chimney gases from the combustion of carbon would be 21 per cent. CO_2 and 79 per cent. N_2 . This is unattainable in practice because the strong reducing action of the glowing carbon on the carbon dioxide will cause formation of carbon monoxide (CO) which will not be again oxidized unless it is brought in contact with free oxygen while still at a high temperature. An excess of oxygen is in practice necessary to ensure this. It follows from the fact that the volume of the carbon dioxide is the same as that of the oxygen which formed it, that all chimney gases resulting from the combustion of pure carbon to carbon dioxide will contain 21 per cent. of $\text{CO}_2 + \text{O}_2$ and 79 per cent. of N_2 .

4. Effect of Hydrogen of Coal on Composition of Chimney Gases.—The simple relation stated in the preceding section only holds where carbon is the only fuel burned, a condition which is quite closely fulfilled with a coke fire and approximately fulfilled when anthracite coal is the fuel. When fuels contain notable percentages of hydrogen, as does bituminous coal, and to a greater extent petroleum and most gaseous fuels, part of the oxygen of the air burns to water which escapes from the furnace as steam.

The changes which air undergoes on combustion with coal may be illustrated as follows:

100 cu. ft. dry entering air is distributed:
 79 cu. ft. N_2
 10 cu. ft. O_2 to combine with C
 9 cu. ft. O_2 as excess
 2 cu. ft. O_2 to combine with H of coal

Products of combustion from 100 cu. ft. dry air after cooling to initial temperature.

79 cu. ft. N_2
 10 cu. ft. CO_2
 9 cu. ft. O_2
 4 cu. ft. H_2O

 102 cu. ft. total volume

The water in this illustration will have a volume of 4.0 cu. ft. if it remains in the state of vapor after cooling to the initial temperature of the air before combustion.

If this combustion had taken place in the bomb calorimeter where, instead of dry air, oxygen saturated with moisture is used, the 4.0 cu. ft. of water would have condensed to liquid when the products had cooled to their initial temperature. If combustion gases taken from the bomb are analyzed in the usual way in a burette filled with water so that the gases always remain saturated with water vapor, no account whatever would be taken of the water vapors and the analysis reported would be the same as if the gas volume had been:

79 cu. ft. N_2	80.6 per cent.
10 cu. ft. CO_2	10.2 per cent.
9 cu. ft. O_2	9.2 per cent.
<hr style="width: 10%; margin-left: 0;"/>	<hr style="width: 10%; margin-left: 0;"/>
98 cu. ft.	100.0 per cent.

Let us now work backwards from this gas analysis which may be assumed to represent the composition reported for a stack gas. When the gas sample was being drawn part of the steam formed may have condensed. If the gas sample was stored over water it certainly became fully saturated with water vapor so that its volume became entirely independent of the amount of steam which it contained in the chimney. The resulting gas

composition would then be the same as if the combustion had taken place in the bomb calorimeter. The calculation would be as follows: 100 cu. ft. of air contained 79 cu. ft. of nitrogen which is now 80.6 per cent. of the chimney gas, therefore the volume of the gas is $\frac{79}{80.6} = 0.98$, or 98 per cent. of the initial volume of entering air measured under the same conditions of temperature and pressure. It follows that 2.0 of the 21 volumes of oxygen have combined with hydrogen to form water.

The volume of the water formed, so long as it remains in the vapor form, will be twice that of the oxygen from which it was formed as shown by the equation.

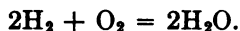

The hydrogen in this case is contained in the coal and is considered as a solid just as the carbon is. In the case of gaseous fuels the problem is a little more complicated and is treated under Producer Gas.

5. Carbon Monoxide and Products of Incomplete Combustion.—The presence of carbon monoxide, hydrogen or hydrocarbons is a sign of incomplete combustion and represents loss of heat which would have been liberated in the furnace had combustion been complete.

Heating value 1 lb. C to CO_2	14,600 B.t.u.
1 lb. C to CO	4,450 B.t.u.

Since carbon burning to CO only evolves 30 per cent. of the heat obtainable by complete combustion it is evidently uneconomical to allow more than small amounts of this gas to appear in chimney gases.

It is frequently stated that carbon monoxide is formed when carbon burns with an insufficient supply of air. This is only a partial truth for with a bed of coals at a dull red heat it is difficult to form carbon monoxide no matter how much the air supply is limited. If the free oxygen in the chimney gases is below 3 per cent. it will be entirely normal to find products of incomplete combustion. The presence of carbon monoxide and other incompletely burned gases is abnormal when associated with much more than 3 per cent. free oxygen. It indicates either a faulty design of the furnace or carelessness on the part of the fireman.

Furnaces intended for coal high in volatile matter must have roomy combustion chambers so that the streams of gas given off by the coal may have time to mix with air and burn before they become chilled by contact with cold surfaces. Furnaces designed for anthracite coal do not have such large combustion chambers and hence do not give good results with bituminous coal.

As mentioned in Chapter III, the estimation of carbon monoxide presents some difficulties and the careless analyst may readily report a fraction of a per cent. of carbon monoxide when none is there. On the other hand, the natural tendency is to fail to find hydrogen when it is present in only small amounts.

The presence of soot in chimney gases is not necessarily an indication that measureable amounts of unburned gases are present for the particles of tar and carbon formed by the destructive distillation of the coal burn much more slowly than do the gases and also have higher ignition temperatures and so are more likely to escape combustion.

6. Volume of Air and of Chimney Gases.—The volume of the air used in combustion per pound of carbon and the volume of the chimney gases may be calculated from the gas analysis. The method is based on the assumption that the nitrogen of the air passes through the furnace unchanged in volume, and that all of the nitrogen of the chimney gases is derived from the air. This assumption is practically correct, the small amount of nitrogen derived from the coal introducing only a negligible error.

It is necessary also to have some factor to connect the weight of carbon burned with the volume of the chimney gases. One pound of carbon burning to CO_2 requires 32.1 cu. ft. of oxygen measured wet at 60° F., and 30 in. barometric pressure and yields 32.1 cu. ft. carbon dioxide. If the air were perfectly dry only 31.4 cu. ft. would be needed per pound of carbon and the volume of carbon dioxide would be 31.4 cu. ft.

Let us assume the following gas analysis:

CO_2	8.5 per cent.
O_2	10.8 per cent.
N_2	80.7 per cent.

It was shown in § 3 that the increase in the percentage of the nitrogen over 79 was due to the condensation of steam formed by

the union of hydrogen of the coal with oxygen of the air. The volume of these gases referred to 100 of air may be obtained by multiplying them by the factor $\frac{79}{80.7} = 0.979$.

	8.5 × 0.979 =	8.3 CO ₂
	10.8 × 0.979 =	10.6 O ₂
	80.7 × 0.979 =	79.0 N ₂
		97.9
O ₂ which has disappeared as steam	2.1 forming	4.2 steam.
		100.0

The volume of air used per pound of carbon may now be obtained.

To burn 1 lb. carbon	= 32.1 cu. ft. moist O ₂ forming	32.1 cu. ft. CO ₂
Oxygen in excess	$\frac{32.1 \times 10.6}{8.3}$	= 41.1
Oxygen forming steam	$\frac{32.1 \times 2.1}{8.3}$	= 8.1
Total oxygen per pound carbon,		81.3 cu. ft.
Accompanied by $\frac{79}{21} \times 81.3$		= 305.5 cu. ft. N ₂
Corresponding to		386.8 cu. ft. air.

The excess of air may be determined from the ratio

$$\frac{\text{Oxygen used}}{\text{Oxygen required}} = \frac{32.1 + 41.1 + 8.1}{32.1 + 8.1} = \frac{81.3}{40.2} = 2.02$$

The volume of the chimney gases is obtained directly from the above, it being remembered that the volume of the CO₂ is the same as that of the O₂ forming it and that the volume of the steam (assumed to be cooled to standard temperature without condensation) is twice the volume of the oxygen forming it.

Volume of chimney gases from 1 lb. carbon in the above example:

CO ₂	32.1 cu. ft.
H ₂ O vapor 2 × 8.1.....	16.2 cu. ft.
O ₂	41.1 cu. ft.
N ₂	305.5 cu. ft.

Total chimney gases 394.9 cu. ft.

7. Loss of Heat in Chimney Gases.—The bomb calorimeter gives the heating value of coal with 100 per cent. efficiency. In this instrument the gases are cooled to practically the same temperature as before ignition and *all* water formed in combustion is condensed to liquid water. The calorimeter makes no distinction between water present as moisture in the coal or as combined water in the coal, and the water formed by combustion of the available hydrogen or hydrocarbons. In calculating the loss of heat in chimney gases the clearest procedure is to determine what would have been the state of the products of combustion if combustion had taken place in a bomb calorimeter, and then calculate the losses caused by the higher temperature of the gases and the presence of water in the state of vapor rather than as liquid.

The heat carried away by these gases may be determined by multiplying their volume by the rise in temperature and by their specific heat. It was first shown in 1883 by Mallard and Le-Chatelier that the specific heats of gases are not constant but increase with rising temperature. Engineers have been slow to adopt these variable specific heats but there can be no question as to their general correctness. The mean specific heats expressed in British thermal units per cubic foot and per pound at constant pressure have been calculated by the author from the data of Holborn and Henning¹ and are given in Tables X and XI of the Appendix. It will be noted that the specific heats of oxygen, nitrogen and all permanent gases are the same per cubic foot, an agreement which holds true only for specific heats by volume and not for those for which the unit basis is weight.

The loss of heat per pound of carbon in the particular case given above will be calculated as follows, a temperature of 600° F. for the escaping gases being assumed:

Temperature through which gases are heated 600 – 60 = 540.

Use mean specific heats from Table X corresponding to 600° F.

Heat lost in CO ₂ ,	32.1 × 0.0253 × 540	= 439 B.t.u.
Heat lost in steam,	16.2 × 0.0221 × 540	= 193
Heat lost in oxygen,	41.1 } 346.6 × 0.0177 × 540	= 3310 B.t.u.
Heat lost in nitrogen,	305.5 }	
		3942

¹ *Annalen der Physik*, 23, 809 (1907).

It is necessary to know the percentage of carbon in the coal before this loss of heat per pound carbon can be calculated to the desired basis of loss per pound of coal.

The loss of heat per pound of dry coal =

$$\frac{\text{Loss per pound carbon} \times \text{per cent. carbon in dry coal}}{100}$$

Moisture present in the coal when placed on the fire will be vaporized, and, in case combustion is complete, will escape from the stack as steam. It is immaterial whether or not it underwent decomposition in the fire, only the initial and final states being important. The amount of water thus vaporized calculated from the analysis of the coal is reported in pounds and is most conveniently kept in that form throughout the calculation. The mean specific heats by weight at constant pressure are given in Table XI of the Appendix. Moisture present in the air introduced into the firebox will be heated from room temperature to that of the escaping gases. Its amount may be determined from observations with a wet and dry bulb thermometer from which the percentage humidity may be calculated as described in § 16 of Chapter VII. The volume of water vapor per cubic foot of air for various temperatures is given in Table XII of the Appendix.

There is also steam in the stack gases which is derived from the union of the hydrogen and oxygen of the coal with each other. It is sufficiently accurate to assume that all of the oxygen of the coal unites with the hydrogen of the coal to form water, that the excess or available hydrogen unites with the oxygen of the air to form water and that all of the carbon of the coal unites with the oxygen of the air to form carbon dioxide. The volume of steam due to this union of the hydrogen and oxygen of the coal with each other can only be accurately calculated from an ultimate analysis. Fortunately its amount is small and fairly constant for a given type of coal. The weight of water so formed, sometimes called "combined water," may be taken as:

2.5 per cent. for anthracite coals.

6.0 per cent. for Eastern bituminous coals.

10.0 per cent. for bituminous coals of the Western or Illinois type.

These figures may for this purpose be added to the percentage of moisture in the coal.

There are also changes in the ash of the coal which may involve absorption of oxygen or liberation of SO_2 or CO_2 but they are negligible in a calculation of this sort.

PROBLEM ILLUSTRATING CALCULATION OF LOSS OF HEAT IN CHIMNEY GASES

Data	Coal as charged	Average composition of chimney gases
Moisture.....	9.3 per cent.	
Volatile matter..	31.7	CO_2 9.6 per cent.
Fixed carbon....	53.7	O_2 9.8
Ash.....	5.3	N_2 80.6
	100.0	100.0
B.t.u. per lb.....	12,456	Temp. escaping gases.. 720° F.
Per cent. total carbon..	71.6	Temp. inlet air..... 70° F.
		Relative humidity..... 75 per cent.

Distribution of air entering furnace.

Factor to correct for change of volume caused by formation of water in combustion $\frac{79}{80.6} = 0.98$

$$\begin{aligned}
 9.6 \times 0.98 &= 9.4 \text{ O}_2 \text{ for burning carbon} \\
 9.8 \times 0.98 &= 9.6 \text{ O}_2 \text{ in excess} \\
 80.6 \times 0.98 &= 79.0 \text{ N}_2 \\
 &\quad \underline{\hspace{1.5cm}} \\
 &\quad 98.0 \\
 &\quad \underline{\hspace{1.5cm}} \\
 &\quad 2.0 \text{ O}_2 \text{ for burning hydrogen} \\
 &\quad \underline{\hspace{1.5cm}} \\
 &\quad 100.0
 \end{aligned}$$

Volume gases from 1 lb. carbon.

1 lb. carbon produces 31.4 cu. ft. dry CO_2 .

$$\text{Factor } \frac{31.4}{9.4} = 3.34$$

$$\begin{aligned}
 9.4 \times 3.34 &= 31.4 \text{ cu. ft. CO}_2 \\
 4.0 \times 3.34 &= 13.4 \text{ cu. ft. H}_2\text{O vapor} \\
 9.6 \times 3.34 &= 32.7 \text{ cu. ft. O}_2 \\
 79.0 \times 3.34 &= 263.8 \text{ cu. ft. N}_2
 \end{aligned}$$

Volume dry air required for combustion $100 \times 3.34 = 334$ cu. ft.

Moisture in air for combustion assumed as 75 per cent. of saturation at 70° F.

$$\begin{aligned}
 0.75 \times 0.026 &= 0.019 \text{ cu. ft. per cu. ft. air} \\
 334.00 \times 0.019 &= 6.35 \text{ cu. ft. for 1 lb. carbon}
 \end{aligned}$$

Losses due to sensible heat of gases.

Gases heated from 70° — 720° F.

Loss in CO₂ = 31.4 × 650 × 0.0257 = 525 B.t.u.

Loss in H₂O (sensible heat only)

vapor from entering air..... 6.35 cu. ft.

formed from available H of coal..... 13.4 cu. ft.

moisture (9.3) and combined water (6.0)

of coal = 0.153 lb. per lb. coal

or $\frac{0.153}{0.716} = 0.214$ lb. per lb.

carbon with 0.0476 cu. ft. per

lb. (Table IX, Appendix)..... 4.5 cu. ft.

Total water vapor..... 24.25 cu. ft.

Heat lost = 24.25 × 650 × 0.0221 = 347 B.t.u.

Loss in O₂ and N₂ 32.7 + 263.8 = 296.5 × 650 × 0.0177 = 3410 B.t.u.

Total B.t.u. lost in sensible heat per lb. carbon..... 4282

Total B.t.u. lost in sensible heat per lb. coal 4285 × 0.716 = 3065

Losses due to latent heat of water.

Moisture in coal 9.3 per cent. = 0.093 lb. per lb. coal

Combined water in coal 6.0 per cent. = 0.060 lb. per lb. coal

Water formed by combustion of available H of coal

forming 13.4 cu. ft. H₂O vapor with 0.0476 lb. per

cu. ft. = 13.4 × 0.0476 = 0.638 lb. per lb. carbon =

0.638 × 0.716 = 0.457 lb. per lb. coal

Total water which would have condensed had com-

bus-tion taken place in bomb calorimeter 0.610 lb. per lb. coal

Latent heat of vaporization 0.610 × 1067 = 651 B.t.u.

Total heat losses per lb. coal burned.

Sensible heat of gases = 3065 B.t.u.

Latent heat of water = 651 B.t.u.

Total heat lost = 3716 B.t.u.

Per cent. heat lost $\frac{3716}{12456} = 29.8$ per cent.

8. Interpretation of Analysis of Chimney Gases.—An analysis is of no value unless the sample is representative. Some of the difficulties in sampling are mentioned in Section 2. If the sampling and analysis have been properly performed the conclusions

to be drawn from the preceding paragraphs may be summarized as follows:

Carbon Dioxide.—The higher the percentage of CO_2 in chimney gases without the presence of CO or hydrocarbons, the more efficient is the furnace. When the fuel is coke or anthracite coal the sum of the percentages of carbon dioxide and oxygen should be between 20.5 and 20.8. If the fuel is bituminous coal the sum of the carbon dioxide and oxygen will drop to 19 per cent. and if the fuel is oil or gas the figure will be still smaller. In ordinary practice the percentage of carbon dioxide should be as large as the oxygen, and with well-equipped and operated plants the proportion of CO_2 to O_2 should be as high as 2 to 1. With liquid or gaseous fuels the proportion of CO_2 will be still higher.

The CO_2 as reported includes a small amount of SO_2 from the sulphur of the coal, which does not usually amount to more than a few hundredths of a per cent.

Oxygen.—When solid fuel is burned on an ordinary grate it is necessary to have an excess of air to insure complete combustion. This excess should be kept as small as possible.

Carbon Monoxide and Products of Incomplete Combustion.—These products should be entirely absent from chimney gases. Their presence indicates waste of fuel. Unless the analytical work is carefully done as much as 0.2 per cent. CO may readily be reported through error.

Nitrogen.—Nitrogen is present in air to the extent of 79 per cent. by volume and will be present in at least that percentage in chimney gases. With bituminous coal the percentage will rise to 81 per cent. and with oil or gaseous fuel the percentage will be higher. The percentage of nitrogen can only fall below 79 per cent. through the introduction of some gas which makes the total volume of the chimney gases greater than that of the air from which they were derived. The formation of carbon monoxide will affect this result since it occupies twice as much space as the oxygen from which it was derived. The amount of CO in chimney gases is, however, too small to exert any appreciable influence of this sort.

Loss of Heat in Chimney Gases.—The loss of heat will depend on the temperature and volume of the gases. The volume of the gas is in general indicated by the relative percentage of carbon

dioxide and oxygen. The higher the per cent. of oxygen and the lower the per cent. of carbon dioxide the greater is the loss of heat. The loss will vary in steam-boiler practice between 15 and 45 per cent. With smelting furnaces where the gases escape at high temperatures the loss may be much higher.

CHAPTER XI

PRODUCER GAS

1. Formation of Producer Gas.—Producer gas is formed whenever air is brought into contact with fuel under such conditions that carbon monoxide is an important constituent of the products resulting from their combination. The formation of producer gas is frequently said to be due to incomplete combustion, but the statement is only a half truth, for a limited quantity of air supplied to a fire will not necessarily produce carbon monoxide. The primary product formed when carbon burns in air is carbon dioxide, the equation being written

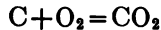

If this carbon dioxide comes into intimate contact with glowing carbon, it unites with more carbon and carbon monoxide is formed according to the equation



These two reactions are frequently combined into one and the typical reaction of the gas producer is usually written

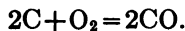

This equation shows that one volume of oxygen is converted into two of carbon monoxide. The composition of the resulting gas may be shown as follows:

$$100 \text{ air} = \begin{cases} 21O_2 = 42CO = 34.7 \text{ per cent. CO.} \\ 79N_2 = 79N_2 = 65.3 \text{ per cent. N}_2. \end{cases}$$

When steam is introduced in the bottom of the producer the reaction desired is:

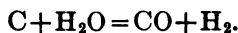

If the temperature of the producer is low, this reaction may proceed in part as follows:

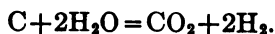

If bituminous coal is placed in the producer there will also be products of destructive distillation including hydrocarbons both saturated and unsaturated, hydrogen and carbon monoxide.

The largest single constituent of producer gas is nitrogen, which will not often fall below 50 per cent. Carbon monoxide and hydrogen rank next in percentage. The hydrocarbons are practically always under 5 and are usually less than 3 per cent. Carbon dioxide should be low. It is, however, frequently as high as 10 per cent.

The following are some analyses of producer gas.¹

TYPICAL ANALYSES OF UP-DRAFT PRESSURE-PRODUCER GAS

(Per cent. by volume)

	From Bituminous Coal	From Lignite	From Peat
Carbon dioxide (CO ₂).....	9.84	10.55	12.40
Oxygen (O ₂).....	.04	0.16	0.00
Ethylene (C ₂ H ₄).....	.18	0.17	0.04
Carbon Monoxide (CO).....	18.28	18.72	21.00
Hydrogen (H ₂).....	12.90	13.74	18.50
Methane (CH ₄).....	3.12	3.44	2.20
Nitrogen (N ₂).....	55.64	53.22	45.50

TYPICAL ANALYSES OF DOWN-DRAFT PRODUCER GAS

(Per cent. by volume)

	From Bituminous Coal	From Lignite	From Peat
Carbon dioxide (CO ₂).....	6.22	11.87	10.94
Oxygen (O ₂).....	0.13	0.01	0.41
Ethylene (C ₂ H ₄).....	0.01	0.00	0.06
Carbon monoxide (CO).....	21.05	16.01	16.91
Hydrogen (H ₂).....	12.01	14.76	10.19
Methane (CH ₄).....	0.49	0.98	0.66
Nitrogen (N ₂).....	60.09	56.37	60.83

¹ From Bulletin 13, U. S. Bureau of Mines. "Résumé of Producer-Gas Investigations by R. H. Fernald and C. D. Smith.

2. Sampling Producer Gas.—The quality of gas yielded by a given producer may change quickly. Soon after a charge of bituminous coal has been added, the amount of volatile tarry vapors and of gaseous hydrocarbons in the gas increases. Within a half hour the larger part of the volatile matters may have distilled off leaving the gas almost free from hydrocarbons and from tar vapors. Rapid changes will also be noted after poking the fire.

An average sample of producer gas may be obtained only by extending the sampling over a long period, as directed in Chapter I. There will be especial difficulty in determining the quantity and heat value of the suspended tarry particles. Yet these values must be ascertained if the heat value of the crude gas is to be determined accurately. The method of collecting the tar particles on filter papers, given in Chapter IX, may be followed and the weight of tar per cubic foot of gas thus obtained. The papers and tar may then be burned in a bomb calorimeter and after deduction of the heat due to the known amount of filter paper, the heating value of the tar may be obtained. This determination is not often made, as it is difficult to carry it out accurately. However, it is not possible to find the true heat balance on a furnace fired with crude producer gas, especially if from a bituminous producer, unless such a determination is made.

Ordinarily the determination of tar and suspended particles is neglected and the sampling then is to be conducted as described in Chapter I.

3. Analysis of Producer Gas.—The constituents to be determined in producer gas are carbon dioxide, unsaturated hydrocarbons, oxygen, carbon monoxide, hydrogen and methane. The methods are given in Chapters II, III and IV. No difficulty will be experienced except with hydrogen and methane. The percentage of these gases, except in water gas, is usually so small that a sample after removal of the absorbable constituents is no longer explosive when mixed with air. It should be emphasized that failure to obtain an explosion does not mean the absence of hydrogen and methane but merely that they are present in less than explosive amounts. Explosion may be brought about by addition of a known volume of pure hydrogen to form an explosive mixture but it is usually simpler to use a method which

does not involve explosion. Combustion with a hot platinum spiral as in the Dennis and Hopkins method (§ 9 of Chapter IV) or with copper oxide as in the Jaeger method (§ 11 of Chapter IV) affords a satisfactory method for determination of these constituents.

4. Interpretation of Analysis.—The important constituents are carbon dioxide and carbon monoxide. Oxygen should be entirely absent, as it should all have been brought into combination in its passage through the producer. Its presence in a producer gas may be an indication of leakage in sampling or of leakage into the flue prior to sampling. Rarely, if operating conditions in the producer are bad, and the fire is thin, there may be such a channel formed in the producer that air will rush through the producer without its oxygen becoming combined. Such a condition will be indicated by extremely high carbon dioxide, with low percentages of combustible gases. When a producer is running under normal conditions its operation may be quite closely checked by the percentage of carbon dioxide alone. High carbon dioxide is in practically all cases an unfavorable symptom. It may be due to a cold fuel bed in the producer caused either by an excess of steam or by slow running, it may be due to a thin fuel bed which does not allow sufficient time and contact for the reduction of the carbon dioxide to monoxide, and it may be due to channels or chimneys in a deep fire which allow uncombined air to get through the fuel bed and burn above the coals.

A cold fuel bed in a producer burning bituminous coal will tend to increase the percentage of unsaturated hydrocarbons, but in no case will they amount to more than a few tenths of a per cent. A hot and thin fuel bed and especially a channeled fuel bed will cause the unsaturated hydrocarbons to practically disappear, since they are decomposed at the high temperature and of all the gases show the greatest avidity for oxygen.

The carbon dioxide is almost a direct measure of the thermal efficiency of the producer, the only exception being its appearance as the result of the interaction of carbon and steam at a relatively low temperature as in the Mond producer where it is accompanied by a high percentage of hydrogen. Under other circumstances high carbon dioxide means low thermal efficiency

for the 70 per cent. of the energy of the carbon which should have been converted into the potential energy of the carbon monoxide is all changed to the sensible heat of the carbon dioxide and accompanying gases.

5. Heating Value of Producer Gas.—The heating value of producer gas may be determined in a calorimeter as described in Chapter VII for illuminating gas. A special tip must be used on the burner and care be taken to see that the flame burns clear. The heating value of producer gas may be as low as 100 British thermal units per cubic foot and it frequently happens that it does not burn readily in a Bunsen burner. The gas must be carefully cooled and cleaned before testing. This operation separates tar whose amount and heat value must be determined as directed in § 2 of this chapter. The heating value of the purified gas may also be calculated from the analysis as indicated in § 17 of Chapter VII. The low percentage of unsaturated hydrocarbons in producer gas makes the errors of calculation less than is the case with illuminating gas. On account of the difficulty in cleaning the gas and in keeping a steady flame in the calorimeter, the heating value is usually obtained by calculation.

It is worth while to emphasize again that the heating value of the cleaned gas from bituminous coal is lower than that of the hot gas which still contains tar vapors and that allowance must be made for the tar vapors in calculating the heat value of the gas which is used while hot.

6. Volume of Producer Gas.—It would be very desirable to be able to calculate the volume of producer gas per pound of coal, as is done in Chapter X for chimney gases. There are, however, so many possible reactions in the gas producer and the changes in volume are so complicated, especially in a bituminous producer, that it is only possible to make such calculations for simple cases.

Assume a producer burning pure carbon in dry air. It is manifest that the only products of combustion will be CO_2 , CO and N_2 . Assume the following composition of the gas

CO_2	5.5 per cent.
CO	25.6 per cent.
N_2	68.9 per cent.

The air entering the producer was composed of 79 volumes of nitrogen for every 21 volumes of oxygen. The change in percentage of the nitrogen in the producer gas is due to changes resulting from the union of oxygen with carbon. The first step is to trace the changes taking place when 100 volumes of air pass through the producer and find the relative volumes of CO₂ and CO for 79 volumes of N₂.

$$\begin{aligned} \text{CO}_2 & 5.5 \times \frac{79}{68.9} = 6.3 = 6.3 \text{ vols. O}_2 \\ \text{CO} & 25.6 \times \frac{79}{68.9} = 29.4 = 14.7 \text{ vols. O}_2 \\ \text{N}_2 & 68.9 \times \frac{79}{68.9} = 79.0 = \frac{79.0}{100.0} \text{ vols. N}_2 \\ & \qquad \qquad \qquad 100.0 \text{ vols. air.} \end{aligned}$$

One pound of carbon burning to carbon dioxide requires 32.1 cu. ft. of oxygen (at 60° F. and 30 in. of mercury pressure) and yields 32.1 cu. ft. of carbon dioxide. One pound of carbon burning to carbon monoxide requires 16.05 cu. ft. of oxygen and yields 32.1 cu. ft. of carbon monoxide. It follows that the weights of carbon burning to CO and CO₂ are proportional to the volumes of the two gases. In the present instance

$$\begin{aligned} \text{CO}_2 & 6.3 = \frac{6.3}{35.7} \times 100 = 17.7 \text{ per cent.} \\ \text{CO} & 29.4 = \frac{29.4}{35.7} \times 100 = 82.3 \text{ per cent.} \end{aligned}$$

One pound of carbon yields

$$\begin{aligned} 0.177 \times 32.1 &= 5.7 \text{ cu. ft. CO}_2 \\ 0.823 \times 32.1 &= 26.4 \text{ cu. ft. CO} \\ 3.76 \times 32.1 &= 120.7 \text{ cu. ft. N}_2 \\ & 152.8 \text{ cu. ft. producer gas.} \end{aligned}$$

The sensible heat will be calculated as in Chapter X.

$$\begin{aligned} 5.7 \times .0268 \times 1000 &= 153 \text{ B. t. u.} \\ 26.4 & \\ 120.7 & \\ \hline 147.1 \times .0180 \times 1000 &= 2647 \text{ B. t. u.} \\ & \qquad \qquad \qquad 2800 \text{ B. t. u.} \end{aligned}$$

Energy in 26.4 cu. ft. of CO	8540 B. t. u.
Sensible heat in gases	2800 B. t. u.
Total energy in gas at 1000° F.	11340 B. t. u.
Efficiency of producer when gas is used at 1000° F. = $\frac{11340}{14600} \times 100$	= 77.6 per cent.

7. Efficiency of a Gas Producer.—In the simple instance cited above it is easy to calculate the energy contained in the gas. The only potential energy in the gas from one pound of carbon is contained in the 0.823 lb., which is now in the form of 26.4 cu. ft. carbon monoxide. The heating value of this is:

$$26.4 \times 323.5 = 8540 \text{ B.t.u.}$$

The total energy of the coal if burned to carbon dioxide would be 14600 British thermal units. If the gas is cooled before being burned so that its only energy is the potential energy of the carbon monoxide the efficiency of the producer is

$$\frac{8540}{14600} \times 100 = 58.5 \text{ per cent.}$$

If the gas is burned while still hot, say at 1000° F., there should be credited to the producer also the sensible heat of the gas, as calculated in the preceding section where the efficiency was shown to be 77.6 per cent.

The above simple relations do not hold when steam is being injected into the producer with the air nor when bituminous coal is being used as a fuel. On account of the varied possibilities of chemical reaction in these cases the volume of the gases cannot be calculated from their chemical composition. If the volume of the gases is measured by a Venturi meter, or otherwise, then it is possible to calculate the sensible and potential energy of the gases as indicated in this chapter and the one preceding.

CHAPTER XII

ILLUMINATING GAS AND NATURAL GAS

1. Introduction.—Chemical analysis plays a minor rôle in testing illuminating gas and natural gas. The determination of heating value is described in Chapter VII and of candle-power in Chapter VIII. The ordinary chemical analysis as described in Chapters III and IV usually includes the determination of carbon dioxide, unsaturated hydrocarbons, oxygen, carbon monoxide, hydrogen and methane, nitrogen being taken by difference. A separate determination of benzene is sometimes desired in illuminating gas and of gasoline vapors in natural gas. Sulphur may be called for in both gases. Naphthalene and ammonia are frequently determined in coal gas.

2. Sampling.—The sampling of natural gas and of purified illuminating gas usually offers little difficulty, since the gases are thoroughly mixed and contain such small amounts of suspended particles that they are usually negligible. The chief point to be observed in sampling from service pipes in cities is to see that the gas is allowed to run long enough to flush out the pipe and bring to the sampling cock gas which is representative of that flowing in the mains. Illuminating gas of high candle-power must not become chilled in the sampling process, for there is danger of condensing the benzene or other hydrocarbon vapors which it contains. Rubber connections are also to be minimized in sampling because of the solubility of the hydrocarbons in rubber. The water used in the sampling vessels must be carefully saturated before use, because unsaturated hydrocarbons are relatively soluble in water.

In case unpurified illuminating gas is to be sampled, additional precautions must be taken on account of the presence of material amounts of ammonia, hydrogen sulphide, carbon dioxide and other very soluble gases, as well as suspended tar particles. In case it is sufficient to determine what the approximate composition of the gas would be after purification it is sufficiently accu-

rate to sample in the usual way and trust the water of the sampling tank to remove the ammonia, hydrogen sulphide and part of the carbon dioxide. In case the actual composition of the unpurified gas is desired, these soluble constituents must be separately determined as indicated in succeeding sections.

3. General Scheme of Analysis.—Carbon dioxide, unsaturated hydrocarbons, oxygen, carbon monoxide, hydrogen and methane are usually determined according to the methods of Chapters III and IV. In the case of unpurified illuminating gas there may be appreciable amounts of hydrogen sulphide absorbed with the carbon dioxide. If it is desired to separate the two the hydrogen sulphide may be estimated according to the method of § 7 of this chapter. The estimation of carbon dioxide, oxygen and carbon monoxide does not present any peculiarities, although emphasis should be laid on the necessity of complete removal of the unsaturated hydrocarbons before the estimation of oxygen by phosphorus. In the case of Pintsch gas it sometimes requires five minutes shaking with bromine water to affect such a complete removal of the hydrocarbons that the phosphorus will smoke when the gas is subsequently passed over it. The determination of hydrogen and methane in illuminating gas offers no marked peculiarity. In natural gas, higher hydrocarbons are present and complicate the calculation. Ethane may be present in natural gas and also in water gas and Pintsch gas. The methods for its determination have been discussed in Chapter IV. Nitrogen is taken by difference and as the analysis is a rather long and complicated one, the errors piling up on the nitrogen are apt to be material. A direct combustion of the gas with copper oxide, as described in § 12 of Chapter IV, gives a more accurate determination of the residual nitrogen.

4. Chemical Composition of Illuminating Gas.—The so-called "coal gas" is made by the destructive distillation of coal in closed retorts. The composition of the gas is dependent on the composition of the coal, the temperature of the retort and to some extent its shape and size. There is nothing, however, which distinctly characterizes gas from the large retort of the by-product coke oven from that of the small horizontal retort of the gas works. The oxygen of the coal appears in the gas partly as carbon dioxide, partly as carbon monoxide, and partly as water vapor.

None of it will be evolved as gaseous oxygen. The carbon monoxide will be greater at a high temperature than at a low one, but will usually stay between the limits of 5 and 9 per cent. A high retort temperature will cause cracking of the hydrocarbons with decrease of their percentage and increase of hydrogen. A fraction of 1 per cent. of free oxygen is normally present in illuminating gas, partly because of air entering during the operation of charging and drawing the retort, partly because of leaks in the long condensing system and partly because of liberation of the oxygen dissolved in the water used in the scrubbers. In so far as this oxygen comes from the air it must be accompanied by four volumes of nitrogen. Nitrogen must always be present in this amount. Less than four volumes of nitrogen for one of oxygen

TYPICAL ANALYSES OF ILLUMINATING GAS

	1	2	3	4	5
C ₂ H ₆**	1.2	0.2*	1.3
CO ₂	1.5	1.4	1.3	2.7	3.5
C _n H _{2n}	4.6	4.0	2.0	6.5	11.6
O ₂	0.3	0.9	0.5	1.1	0.7
CO.....	7.1	4.6	4.8	12.4	31.6
H ₂	46.4	49.6	50.7	38.4	35.7
CH ₄	36.3	35.0	38.1	28.4	9.0
N ₂	3.7	3.3	2.4	10.5	3.7
					C ₂ H ₆ 2.9

* Not separately reported.

1. Coal gas of 17 c.p. and 650 B.t.u.
2. Coke oven gas enriched by benzol to 16.4 c.p. and 626 B.t.u. (*Proc. Am. Gas Inst.*, 6, 519 (1911).)
3. Coke Oven Gas. Fuel Gas (*Proc. Am. Gas Inst.*, 6, 519 (1911).)
4. Mixed Coal and Water Gas 15 c.p. and 615 B.t.u.
5. Carbureted Water Gas of 24 c.p. and 649 B.t.u. (*Proc. Am. Gas Inst.*, 7, 739 (1912).)

indicates a faulty analysis. The unavoidable nitrogen in the gas arising from the destructive distillation of the nitrogenous compounds of the coal will be between 1 and 1.5 per cent. High percentages of nitrogen unaccompanied by a corresponding amount of oxygen indicate that suction has been maintained on the porous retorts, so that air has been sucked in. The oxygen thus brought in contact with the hot gas will at once burn with formation of carbon dioxide or water while the nitrogen will

remain and appear as such in the purified gas. In the manufacture of water gas a high percentage of nitrogen will result if the gasmaker turns the gas into the holder before all the gas produced while blowing air is flushed from the machine by the water gas.

5. Benzene.—Benzene is a normal constituent of coal gas and also probably of water gas, but its amount in unenriched coal gas is always less than 1 per cent., and it is not usually determined. Its solubility in water and in caustic soda is slight so that in the ordinary analysis the benzene is not absorbed by the caustic but passes on to the bromine pipette where it dissolves in the ethylene bromide formed in the reaction between ethylene and bromine and is therefore estimated with the ethylene as "illuminants." As benzene has a very high illuminating power this grouping is logical and sufficiently satisfactory for most purposes.

Hempel recommends that 1 c.c. of absolute alcohol be placed in a pipette otherwise filled with mercury. An explosion pipette answers well for this purpose. A sample of gas is to be passed into the pipette and shaken with the alcohol to saturate it with ethylene, and the sample to be analyzed is later passed into this same pipette and shaken three minutes. The gas is then drawn back into the burette and passed into a second mercury pipette containing 1 c.c. of distilled water which removes the alcohol vapors. The decrease in volume from the initial reading is recorded as benzene. The method is to be considered only an approximate one.

Morton¹ recommends that, after removal of carbon dioxide by caustic soda as usual, the gas be passed into an ordinary simple absorption pipette containing concentrated sulphuric acid (sp. gr. 1.84) and shaken *vigorously* for one minute. The decrease in volume after drawing back into the burette represents benzene. Dennis and McCarthy² dispute the accuracy of this method and propose ammoniacal nickel cyanide as a reagent. The gas after carbon dioxide has been removed by caustic is passed into the pipette containing the ammoniacal nickel cyanide solution and drawn back and forth between the burette and

¹ *Jour. Am. Chem. Soc.*, 28, 1728 (1906).

² *Jour. Am. Chem. Soc.*, 30, 233 (1908).

pipette for about two minutes. It is then passed into a five per cent. solution of sulphuric acid and shaken until the ammonia is absorbed, which requires about two minutes. According to the authors, the absorption is quantitative and the result unaffected by ethylene.

The process of Haber and Oechelhäuser¹ is based on Bunte's observation of the solubility of benzene in ethylene bromide. The authors treat the gas with a fresh solution of bromine water to which is added, immediately after the reaction an excess of strong potassium iodide. The liberated iodine is titrated with thiosulphate and the difference between the figures of this titration and those obtained by a blank test on an equal volume of the original solution represents the bromine which has combined with the ethylene. One cubic centimeter decinormal thiosulphate corresponds to 1.12 c.c. ethylene at 0° C. and 760 mm. or to 1.22 c.c. at 60° F. and 29.5 in. mercury pressure. The diminution in volume of the gas after the usual treatment with bromine water followed by caustic gives the sum of the benzene and ethylene. The difference between this volume and that indicated by the titration for ethylene gives the benzene.

If a more exact method of estimation of benzene is desired and a large sample of gas can be obtained the method of Harbeck and Lunge² may be used. It consists in aspirating 10 liters of the gas through a mixture of equal weights of fuming nitric acid and concentrated sulphuric acid. Part of the resulting dinitrobenzene crystallizes out after the acids are diluted, cooled and neutralized, and may be filtered and weighed. The dinitrobenzene remaining in solution is extracted from an aliquot portion of the filtrate with ether and also weighed.

6. Benzene and Light Oils by Differential Pressure Method.

Davis and Davis³ have described a differential pressure method for determining benzene and light oils which requires relatively small samples of gas. The apparatus as illustrated in Fig. 37 consists of a pair of flasks connected by a differential manometer. The saturation vapor pressure of a liquid is a function of the temperature and is independent of the amount of liquid (provided

¹ *Jour. für Gasbel.*, 43, 347 (1900).

² *Zeit. für anorg. Chem.*, 16, 41 (1898).

³ *J. Ind. & Eng. Chem.*, 10, 709-718 (1918).

there is an excess of liquid after saturation is reached) and of the pressure on the inert gas into which it evaporates. If each of the flasks A and B in Fig. 37 is filled with air and closed, the manometer will show no pressure difference between them. If now

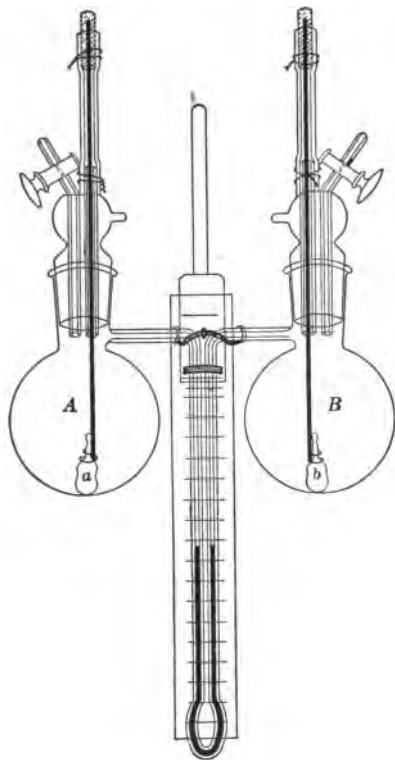

FIG. 37.—Davis differential pressure apparatus for benzene in gas.

the small bulb *a* containing benzene is broken, the benzene will evaporate into A and the manometer will after equilibrium is reached, show an increased pressure in the vessel corresponding to the saturation pressure for benzene; since the flask B contains air with no benzene. If flask B is filled with coal gas at atmospheric pressure and the flasks are closed the manometer will indicate no pressure difference. If the bulbs *a* and *b* containing benzene are now broken the vapor pressure in A will rise as before but the vapor pressure in B will not increase so much since the gas in B had already contained some benzene vapors. The manometer connecting the two flasks will therefore register a pressure equal to the partial pressure of the benzene originally in B, from

which the amount of benzene in the original gas can be calculated. Coal gas carries not only benzene but also toluene and small amounts of other hydrocarbon vapors. The liquid in the bulbs should therefore be light oil instead of benzene and under such circumstances the reading will give percentage of light oil vapors. If benzene alone is to be determined the flasks must be cooled to almost the freezing temperature of benzene, at which temperature the vapor pressure of the other constituents is negligible.

7. Hydrogen Sulphide.—Hydrogen sulphide should be present only in minute traces in purified illuminating gas. The usual test is an approximate one based on the reaction of hydrogen sulphide and lead acetate to form black lead sulphide. A strip of white filter paper moistened with colorless lead acetate is exposed to the gas and the depth of the resulting black stain noted. The details of the test differ widely. The New York State Commission prescribes that gas shall show no hydrogen sulphide when tested by exposing the paper moistened with lead acetate to a current of gas burning at the rate of 5 cu. ft. per hour. The paper must not become discolored after thirty seconds of such exposure. Ramsburg¹ and McBride,² Weaver and Edwards have given a full discussion of the various methods of testing for hydrogen sulphide in gas.

Hydrogen sulphide is always present in unpurified illuminating gas. In the ordinary gas analysis it is absorbed by the caustic soda simultaneously with the carbon dioxide and reported with it. Its quantitative estimation may be carried out as follows. One or more liters of the gas is bubbled through a solution of ammoniacal cadmium chloride and the resultant cadmium sulphide is filtered. If the precipitate contains much tar it may be washed on the filter with benzol. Place filter and precipitate in cold dilute hydrochloric acid till dissolved and titrate with standard iodine. If the iodine solution is made by dissolving 1.0526 grm. iodine to the liter, 1 c.c. will be equivalent to 1/10 c.c. of hydrogen sulphide measured damp at 60° F. and under 30 in. of mercury pressure. A solution of ten times the above strength is more convenient if much hydrogen sulphide is present.

A rapid approximate estimation of hydrogen sulphide may be made in the Bunte gas burette described in § 4 of Chapter V. The burette is first filled with water containing a little thin starch paste to act as indicator, and the sample of gas drawn in and measured rapidly to prevent error due to the solubility of the hydrogen sulphide in the water of the burette. Standard iodine solution is now admitted from the reservoir at the top of the burette, about a cubic centimeter at a time, until the blue color formed by the reaction between the iodine and starch

¹ *Proceedings Am. Gas. Inst.*, 4, 453, 1909.

² *Technologic Papers* 20 and 41, Bureau of Standards.

persists after repeated shaking, showing that the hydrogen sulphide has all been oxidized. If iodine solution of the concentration given above has been used, the volume of hydrogen sulphide may be read directly from the volume of iodine used, which must be obtained by measuring the iodine solution still remaining in the reservoir of the burette. Tutwiler has modified the burette

by making the reservoir longer and graduating it so that the iodine used may be read directly.

8. Total Sulphur Compounds.—Illuminating gas and almost all other gases used for fuel contain, in addition to hydrogen sulphide, compounds of sulphur and carbon such as carbon bisulphide and more complex compounds like the mercaptans. These compounds are usually estimated after complete combustion, in which process all the sulphur, whatever its previous combination, is converted into sulphur dioxide and sulphur trioxide. These gases are absorbed, oxidized to sulphuric acid and weighed as barium sulphate. Care must be taken to see that the air used for combustion, which is usually ten times the volume of the gas, is itself free from sulphur compounds, and that combustion is complete. The form of burner and absorption apparatus is

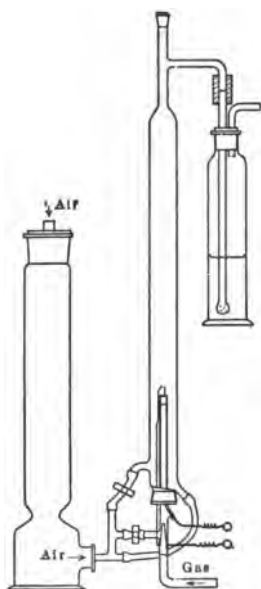

FIG. 38.—Bureau of standards form of sulphur apparatus.

immaterial, except for convenience.

The older design due to Drehschmidt has been modified by Harding,¹ Jenkins,² and the Bureau of Standards.³ Any of these modifications may be made from ordinary laboratory apparatus. The apparatus described and illustrated in Fig. 38 is that of the Bureau of Standards. The entire apparatus consists of pressure regulator, U water gage, meter, sulphur apparatus, wash bottles,

¹ *Jour. Am. Chem. Soc.*, 28, 537 (1906).

² *Jour. Am. Chem. Soc.*, 28, 542 (1906).

³ Circular No. 48, Bureau of Standards.

and jet pump, connected in the order named; soda-lime tower for the purification of the air; and battery and spark coil, connected to the burner. The burner is a porcelain tube of 3-4 mm. internal diameter. The gas is ignited by an electric spark between platinum terminals which are soldered to nickel leads, in order that only a short length of platinum wire will be needed. One of the leads is placed within the burner tube, its lower end being brought out through a small side tube which is sealed to the glass tube just below the rubber stopper; the wire can be held in place and the opening closed by sealing wax. The terminal outside is wired to the porcelain burner tube. The platinum wire becomes heated by the flame and thus reduces the likelihood that the flame will be extinguished by fluctuations in gas pressure. This igniter therefore eliminates the principal difficulty both of lighting and of regulating the burner which is experienced with apparatus of this type.

The stopper which closes the lower end of the combustion chamber also serves as a connector, the porcelain burner tube and the glass T piece being firmly fastened into it by means of Khotinsky or sealing wax. The small tip through which the gas enters just above the primary air inlet is also held in with Khotinsky cement. The tip can be easily removed for cleaning, or tips of various sizes adapted to the gas to be burned can be inserted. The air necessary for complete combustion after being purified by passage through the large soda-lime tower is supplied to the flame in two portions. The primary air is drawn in by the gas as it passes through the small tip; the secondary air enters through the two inlets at the side of the combustion chamber.

The combustion chamber, made of Pyrex glass tubing, is about 360 mm. long and about 25 mm. in internal diameter. The narrow tube at the top may be used for introducing water when it is desired to rinse out the apparatus; when in operation this tube is closed with a small cork. Satisfactory drainage is provided by the sloping layer of paraffin or sealing wax covering the stopper at the bottom. When the burner is lighted the secondary inlet air keeps the base of the apparatus cool, but the rest of the combustion chamber up to the side tube is heated so that no condensation takes place on the walls. For that reason it is usually unnecessary to rinse out the combustion chamber. By

means of a cork connector the first of a series of wash bottles is attached to the apparatus. Rubber tubing must not be used at this point on account of the danger of introducing sulphur from it; but the wash bottles may be connected to each other and to the suction pump by rubber tubing, which may also be used to connect the air inlets to the soda lime-tower. Only one wash bottle is shown in the illustration, but three are usually required for satisfactory operation. In order that the suction may pull the gas steadily through the wash bottles it is necessary that the end of the inlet tube of the first bottle be perforated with a number of small holes. With a single, large opening the operation of the burner is not steady. The wash bottles may be of any of the ordinary forms. Each bottle should contain enough absorbent so that the products of combustion will bubble through a depth of 1 to $1\frac{1}{2}$ inches of liquid. The air is drawn in and the products of combustion are drawn through the apparatus by the suction of a small water jet pump, or its equivalent. The spark for igniting gas is produced by a single dry cell and an induction coil of the size rated as giving a quarter-inch spark.

Before beginning a determination the apparatus should be adjusted to burn gas at the required rate, not more than 2.5 cu. ft. per hour, and to use the proper amount of primary and secondary air. The amount of gas burned should be adjusted by removing the small glass inlet tip from the burner and reducing or enlarging the opening as required. The opening may be reduced by heating carefully in a flame; it may be enlarged by filing back the tip until the required internal diameter is reached. To adjust the air supply the wash bottles are filled with water to the depth of 1 to $1\frac{1}{2}$ inches above the lower end of inlet tubes. The jet pump is then turned on to draw air through the apparatus at a rapid rate, the battery circuit is closed to produce a continuous spark, and the gas is turned on last. This order should be followed every time the burner is lighted. If the gas is turned on before both the air flow and the spark are started, an explosion may result. As soon as the gas has ignited the battery circuit may be opened.

The amount of air entering the burner tube must be regulated rather carefully, so that the flame is entirely nonluminous with a clearly defined inner cone. The amount of secondary air flowing

through the apparatus must, of course, be sufficient to give complete combustion. This is assured when the outer cone of the flame is steady and sharply defined. If the outline of the flame appears "ragged" or indistinct, some of the sulphur is certain to escape oxidation. There is little danger of having too much secondary air, but the amount is limited by the capacity of the wash bottles. To insure complete absorption and prevent mechanical loss of the sulphate solution, it is desirable to keep this rate of air flow reasonably low, but it is better to use too much air than too little. The primary air is regulated by the pinch cock on the inlet tube, but the adjustment of secondary air should be made by regulating the jet pump rather than by closing the air inlet.

When these adjustments have been completed a test for leaks should be made, the gas-supply line purged, and the meter adjusted. While the line is being purged the soda lime tower is filled and sufficient 5 per cent. solution of sodium carbonate (Na_2CO_3), with a few drops of hydrogen peroxide or of bromine water, is introduced into each wash bottle to bring the liquid 1 to $1\frac{1}{2}$ inches above the bottom of the inlet tube.

The burner is now connected to the meter and the meter reading recorded. The suction, spark, and gas are then turned on in order, and pressure and temperature readings are made and recorded. The burner should usually be adjusted to consume about 1 cubic foot of gas per hour. When enough gas has been burned the gas is turned off first; then the valve controlling the jet pump is closed carefully to prevent tap water being sucked back into the wash bottles. The meter, barometer, thermometer, and manometer readings are again recorded. The contents of the wash bottles are transferred to a beaker and the bottles rinsed twice with a little water. It is ordinarily unnecessary to wash out the burner chamber since it is dry at all times and the sulphur is mostly present in the form of sulphur dioxide, which passes on quantitatively. The hot walls prevent the condensation of any sulphur trioxide which may be present. Sulphate is determined in the solution by any of the usual methods. 1 grm. $\text{BaSO}_4 = 0.1373$ grm. S. or 2.119 grains S. The result is usually reported as grains sulphur per 100 cu. ft. of gas measured under standard conditions.

9. Naphthalene.—The amount of the hydrocarbon, naphthalene C_{10}H_8 , usually present in gas is less than one-tenth of 1 per

cent. Its small amount would make it unworthy of consideration were it not for its disagreeable property of causing stoppages in gas mains. Its estimation is therefore sometimes demanded as one of the steps in controlling the manufacturing process.

The usual method for purified gas is that devised by Coleman and Smith,¹ who based their method on Küster's² method for separating naphthalene from other hydrocarbons. The method depends upon the property which naphthalene possesses of combining molecule for molecule with picric acid to form an insoluble compound. In the author's laboratory it has been customary to make the picric acid about 1/20 normal, which is an almost saturated solution, and to use as alkali $\text{Ba}(\text{OH})_2$ 1/5 normal, with phenolphthalein, lacmoid or methyl red as indicator. The color change is not difficult to observe, but the same conditions must always be observed in the analyses that are maintained in the standardization. When the gas to be tested has been purified and there is no danger of naphthalene deposition at room temperature the gas may be passed through a wet experimental meter, then through a wash bottle containing dilute tartaric or other non-volatile acid to remove all traces of ammonia, then through a bottle containing water to stop acid which might have spattered over and then through a bulbed gas washing tube with about ten bulbs containing 50 c.c. of the standard picric acid. A yellow precipitate betrays the presence of naphthalene. After five or more cubic feet of gas have been bubbled through the apparatus, the bulbed tube is disconnected and washed into an Erlenmeyer flask of about 150 c.c. capacity, the bulbed tube being rinsed with 50 c.c. of picric acid from a pipette. The flask is then closed with a rubber stopper carrying a glass tube through which most of the air is sucked from the flask by a filter pump in order that it may not blow up when heated later. The evacuated flask is then placed in a water bath which is maintained at the boiling temperature for an hour. Rutten³ says that it is sufficient to heat to 40° C. for half an hour. The flask is then removed and allowed to cool when the naphthalene picrate will have recrystallized as a definite compound $\text{C}_{10}\text{H}_8 \cdot \text{C}_6\text{H}_2\text{OH}(\text{NO}_2)_3$. This is

¹ *Jour. of Gas Lighting*, 75, 798 (1900); 80, 1277 (1902).

² *Berichte*, 27, 1101.

³ *Jour. für Gasbel.*, 52, 694 (1909).

filtered off and an aliquot part of the filtrate is titrated with alkali. The difference between the amount of alkali required for this titration and that which would have been required on a blank titration gives, when calculated for the whole volume of picric acid present, the naphthalene absorbed. One cubic centimeter of $N/5$ $Ba(OH)_2$ is equivalent to 0.0256 gm. naphthalene. If great accuracy is not required the heating of the naphthalene picrate in its solution may be dispensed with.

When gas freed from tar particles but otherwise unpurified is to be tested for naphthalene, it must be freed from ammonia and hydrogen sulphide, which affect the titration. The gas must not be allowed to cool below the temperature of the main during this purification process or naphthalene may deposit. The purifying train may be placed in an oven such as that shown in Fig. 40, placed so that it is in close proximity to the main and heated to the desired temperature. The first washer may contain lead acetate, the second a dilute acid and the third water. The tube with picric acid must not be placed in the oven since naphthalene will not be absorbed by a warm solution, but must be immediately outside. If naphthalene is deposited in the glass connecting tube it may be vaporized and driven forward by heat. Where much naphthalene is present two bulbed tubes should be used in series and if much precipitate appears in the second tube the liquid in the first tube should be renewed since a dilute solution of picric acid does not remove naphthalene completely. The precipitated naphthalene is estimated in the same manner as in the case of purified gas.

Where naphthalene must be estimated in crude gas containing suspended tar and it is desired to separate the naphthalene present as vapor in the gas from that which is carried in the dissolved tar particles, the method becomes still more complicated. The method devised by the author¹ to separately determine the naphthalene present as vapor in the gas from that which is carried in the dissolved tar particles involves precipitation of naphthalene as the picrate with subsequent recovery of the naphthalene. Considerable care is necessary in sampling gases which contain tar, if it is desired to distinguish between the naphthalene actually present as vapor in the gas and that existing dissolved in the

¹ *Proc. Mich. Gas. Ass.*, 1904; 1905, 83.—*J. Gas Lighting* 88, 262 and 92, 388.

fine, mist-like particles of tar suspended in the gas and which will be removed later by mechanical scrubbing. It is out of the question to collect a tank of gas, say from the foul main, and transport it to the laboratory for examination. The condensation and separation of tarry products in the gas holder would nullify the value of the figures obtained. It is necessary to separate the suspended tar and remove the naphthalene before change of temperature has had time to alter the conditions prevailing at the point of sampling. This requires that the tar vapors shall be mechanically filtered from the gas without any change

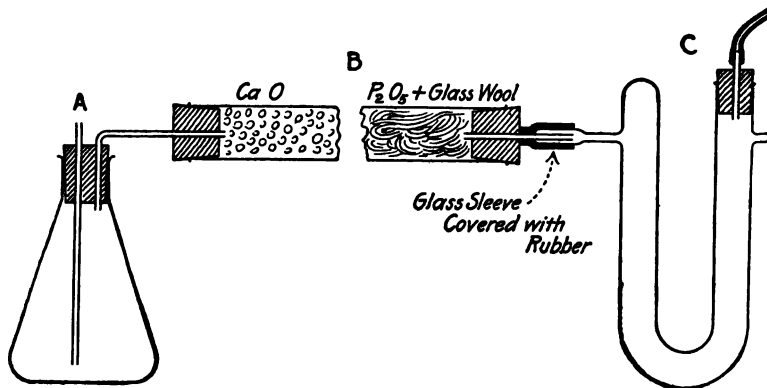

FIG. 39.—Details of naphthalene train.

in temperature. The result is attained by inserting horizontally into the main a glass tube about $\frac{1}{2}$ in. in diameter filled with glass wool or asbestos fiber. This tube should project into the main at least 6 in. and at as short a distance outside the main as possible should connect with the picric acid absorbing train, and then with a gas holder of about 1 cu. ft. capacity and of known volume as shown in Fig. 2 of Chapter I. The strong solvent power of tar for naphthalene renders it absolutely essential that the gas shall not be scrubbed by passing through cold tar, as would be the case if the tube for separation of the tar were placed outside the main and, for example, connected to a pet cock. After the sample has been drawn, the picric acid contains the naphthalene and tar which were still present in the gas as vapor. The solution and precipitate is washed into a 200 c.c. Erlenmeyer flask and treated with alkali to neu-

tralize the picric acid. It is our custom to add here an excess of solid alkali, making an almost saturated solution when hot, merely to prevent so much moisture being carried into the drying tube. As this addition of solid alkali makes the solution hot, it should not be added until just before the apparatus is connected up so as to avoid loss of naphthalene. If the glass connecting tube contains naphthalene deposited from the gas by condensation the tube should be broken into fragments and dropped into the same flask.

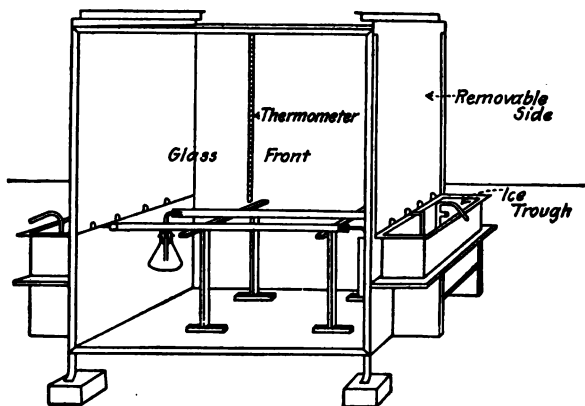

FIG. 40.—Oven for naphthalene determinations.

The flask is then corked with a stopper carrying two glass tubes, one long enough to reach nearly to the bottom of the flask and the other terminating just below the cork and extending above the cork to make connections to the tube containing lime and phosphorus pentoxide as shown at A of Fig. 39. At the other end of the drying tube B close connection is made to a small weighed U tube C which can be immersed in ice water. The tube containing the asbestos and tar is connected directly to a similar drying tube and U tube. The arrangement of the train is shown in Fig. 39 and the whole set in the oven is shown in Fig. 40. The oven is heated to 70°–80° C. and air slowly drawn through the system, volatilizing the naphthalene and moisture in the tar. The moisture is taken up by the dryer—lime and phosphorus pentoxide—while the naphthalene passes on to be frozen out in the U tube placed directly outside of the oven in a trough filled full of cracked ice. The analysis is complete when the

weight of the naphthalene U tube becomes constant or very nearly so at consecutive weighings after a two- or three-hour interval. The volatilization of the naphthalene from the gas is usually complete in six hours. The time required for an analysis of tar thus deposited varies with the amount of tar in the sample and usually takes thirty or forty hours for samples drawn from the standpipe when the weight of tar amounts to 8 or 10 gm. When the analysis is complete, the tar volatilizing tube is again weighed, the loss giving the weight of moisture and naphthalene given off. Having the weight of naphthalene in the U tube, we have the weight of moisture also, which, however, is at best only approximate, because there is always more or less light oil, such as benzene, given off from the tar with the moisture and naphthalene, which cannot easily be estimated. Finally the volatilizing tube is set in a Soxhlet extractor and the remaining contents extracted with chloroform until free of all soluble material. After drying, the tube is weighed, this giving the weight of free carbon in the tar.

The oven used is of galvanized iron and is 20 in. high by 16 in. wide by 14 in. deep. It is shown in Fig. 40 and is arranged so that eight samples may be worked at a time. The drying train consists of a heavy glass tube about $\frac{1}{2}$ in. internal diameter and 12 in. long. It contains broken lime for about two-thirds of its length and phosphorus pentoxide thoroughly incorporated in glass wool for the other one-third. This introduction of the glass wool with the phosphorus pentoxide prevents the gas from forming channels in the latter and thus aids in rendering the extraction of moisture complete before reaching the naphthalene U tube. The lime used must be extremely rapid in its reaction with water in order to avoid too great expense for phosphorus pentoxide. It may be readily made by igniting crushed limestone to a dull red heat for two hours in a muffle. If the lumps of lime are too small, the expansion attendant upon their slacking will crack the tube. If the lumps are too large, the gas will not be dried sufficiently. A satisfactory mixture is obtained by taking everything that will pass a four-mesh sieve and will not pass a twelve-mesh. Connection with the naphthalene U tube is made as shown in Fig. 39 at C, through a glass sleeve made air tight by a piece of rubber tubing placed over the whole. This prevents

the naphthalene from coming in contact with the rubber. It is well known that rubber absorbs naphthalene. Nevertheless, it has been found safe to use rubber stoppers in the volatilizing oven. Rubber stoppers in frequent use absorb all they can take up and after a few runs cause no further trouble.

This method allows the estimation of naphthalene as vapor in the gas, and of water, non-volatile tar, free carbon and naphthalene in the suspended tar. The separation of the water and non-volatile tar is not very accurate, the light oils which are vaporized by the air drawn through being reported as water. The estimation of naphthalene is, however, quite accurate. The air passing through will leave the system saturated with naphthalene at the temperature of ice water, but this loss need not amount to over a milligram for each ten hours run. It is possible that the naphthalene may be contaminated by other hydrocarbons and the naphthalene deposit is sometimes slightly oily and has a low melting point.

10. Ammonia.—Crude coal gas before scrubbing may contain as much as three-quarters of a per cent. of NH_3 by volume. After the gas has traversed the scrubbers the amount of ammonia should be reduced to a trace.

The gas to be tested is bubbled through standard acid, suction being produced by an aspirator holding a cubic foot, which also acts as a measuring device. The excess of acid is then titrated back with standard alkali, cochineal or sodium alizarine sulphonate being used as an indicator. If the gas contains much suspended tar the end of the titration cannot be observed sharply and it is necessary to make the solution alkaline and redistill the ammonia into standard acid before titrating. One cubic centimeter of N/10 acid equals 0.0017 grm. NH_3 .

11. Cyanogen.—Cyanogen compounds exist in small amounts in unpurified gas. In the purification process they are partly removed in the ammonia scrubbers and largely in the iron-oxide purifiers or in special scrubbers containing compounds of iron. The gas is estimated by bringing it into contact with an alkaline solution carrying suspended ferrous hydroxide and titrating the resultant ferrocyanide. The method according to Mueller¹ is as follows:

¹ *Proc. Am. Gas Inst.*, 5, 249 (1910).

“To determine the amount of cyanogen in gas, the cyanogen is converted into potassium ferrocyanide by passing the gas through a caustic potash solution containing freshly precipitated ferrous hydrate in suspension. After filtering, the potassium ferrocyanide is determined in the clear solution by acidifying and titrating with a standard solution of zinc sulphate until all ferrocyanide has been precipitated as zinc ferrocyanide. The end reaction is determined as follows: A drop of a 1 per cent. solution of ferric chloride is put on a piece of white filter-paper absolutely free from iron. A drop of the liquid being tested is then put on the paper near the drop of ferric chloride so that the liquor as it spreads out on the paper will come in contact with the ferric chloride. Care must be taken that the precipitate of zinc ferrocyanide does not come in contact with the iron solution. As long as there is any ferrocyanide left in solution, a blue color will appear where the two drops come in contact due to the formation of prussian blue. When all ferrocyanide has been precipitated this color will no longer appear, which indicates the end point of the titration. The zinc sulphate solution is made by dissolving approximately 5 gm. of pure zinc sulphate in 1 liter of water with the addition of 10 c.c. of sulphuric acid. This solution is standardized with a solution of 10 gm. of potassium ferrocyanide ($K_4Fe(CN)_6 \cdot 3H_2O$) dissolved in water and diluted to 1 liter. Twenty-five cubic centimeters of the potassium ferrocyanide solution are put into a beaker and titrated with the zinc sulphate solution, the end reaction being determined as above. One cubic centimeter of the ferrocyanide solution is equivalent to 0.0570 grains of cyanogen, from which the value of the zinc solution is calculated.

“To test for cyanogen in gas put 15 c.c. of a 10 per cent. ferrous sulphate ($FeSO_4 \cdot 7H_2O$) solution into each of three wash-bottles. Add 15 c.c. of 20 per cent. caustic soda solution to each bottle and pass about 3 cu. ft. of gas through these bottles at the rate of about 1 cu. ft. per hour. Rinse the contents of the bottles into a beaker, add 20 c.c. more of the caustic soda solution and heat to boiling. Filter and wash with hot water until a few drops of the filtrate no longer show a blue color when acidified and tested with a drop of 1 per cent. ferric chloride solution. Transfer the filtrate to a 500 c.c. graduated flask, dilute to the mark and shake well. Take 100 c.c. of this solution and transfer to a beaker by means of a pipette. Slowly add dilute sulphuric acid (sp. gr. about 1.5) stirring constantly until the solution becomes slightly acid toward litmus. Then run in the zinc sulphate solution a few drops at a time until the drop test as explained above shows that the ferrocyanide has all been precipitated. From the amount of zinc sulphate solution used the amount of cyanogen in the gas is calculated.”

12. Specific Gravity.—The simplest method of determining the specific gravity of gases makes use of the law that different gases streaming through a given orifice at the same temperature and pressure flow through the orifice at a rate inversely proportional to the square root of their specific gravity. Since the time of flow is inversely proportional to the rate, the specific gravity becomes proportional to the square of the time of flow. Bunsen devised an ingenious instrument to measure specific gravities in this way and Schilling later gave it the form which is shown in Fig. 41. It consists of a glass cylinder open at the bottom and fastened to a metal base which keeps it vertical within the larger cylinder of water. It is closed at the top by a metal cap carrying two cocks. A is for the introduction of the gas to be tested. B is a three-way cock which in one position discharges the gas through a side arm to flush the apparatus. When this cock is in the vertical position the gas passes through a small opening in a platinum plate at C. The apparatus should be standardized against air each time it is used. The calibration is made by opening the air cock and raising the inner cylinder until it is nearly out of water. It will then be filled with air. After closing both cocks it is to be again lowered into the cylinder of water. The observer opens the cock B so that the air streams out through the capillary platinum opening, starts a stop watch as the meniscus passes the lower mark on the glass tube and stops the watch as it passes the upper mark. The instrument is now thoroughly flushed with gas and the time required for the volume of gas between the two calibration marks to stream out of the opening is determined in the same way. The calculation then follows from the formula

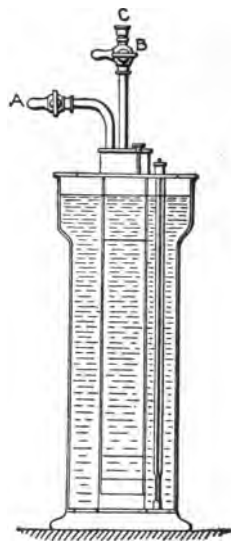

FIG. 41.—Schilling's specific gravity apparatus.

$$\frac{\text{sp. gr. gas}}{\text{sp. gr. air}} = \frac{t^2 \text{ gas}}{t^2 \text{ air}}$$

Edwards¹ has made a careful study of the accuracy of this effusion method of determining gas density and finds that although the apparatus may serve well for control work, errors of ten per cent. in the absolute measurement are not unusual. If calibrated orifices are employed, better results may be obtained. The modification of apparatus shown in Fig. 42 is recommended for approximate work and more elaborate models are illustrated where mercury is to be used as the displacing agent.

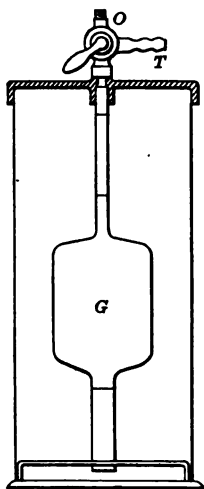

Fig. 42.—Bureau of Standards form of simple specific gravity apparatus.

A more accurate determination of the specific gravity of gas is afforded by the specific gravity balance. Edwards² has reviewed the literature of the subject and has devised a portable apparatus capable of giving the specific gravity with an error of less than one part in a thousand. According to Boyle's law the density of a gas is proportional to its pressure; and the buoyant force exerted upon a body suspended in a gas is proportional to the density of the gas and, therefore, to its pressure. Hence, if the buoyant force exerted upon a body is made the same when suspended successively in two gases, then the densities of the two gases must be the same at these pressures; or the densities of the two gases at normal pressure are in inverse ratio to the pressures when of equal buoyant force. The Edwards gas density balance is illustrated in Fig. 43 and consists of a balance beam *B* carrying a sealed cylinder on one end and a counterweight on the other. The balance beam with its support is mounted in a gas-tight chamber to which is attached a mercury manometer. In operation, the balance case and manometer connections are filled with dry air through the inlet *I* and the pressure adjusted by removing the excess gas through the needle valve *E* until the beam just balances, as determined by observation (through the adjustable lens *L*) of the cross line on the end of the beam. After determining this pressure, the

¹ Bureau of Standards, Technologic Paper No. 94.

² Bureau of Standards, Technologic Paper No. 89.

balance is evacuated through *E* and filled with the gas, the pressure is then adjusted until the beam is again in equilibrium. The specific gravity of the gas is then the ratio of the total pressure (manometer reading plus atmospheric pressure) required to balance the beam in air to the total pressure required to balance it in the gas.

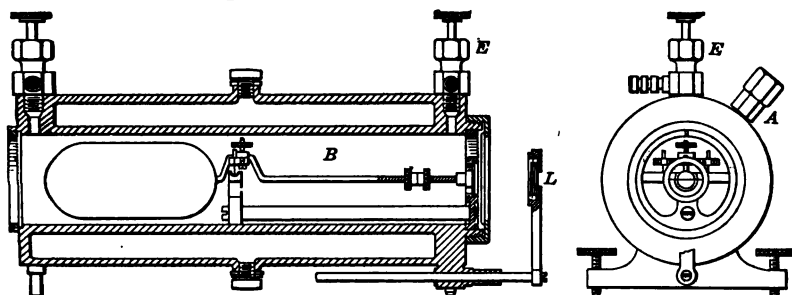

FIG. 43.—Edwards specific gravity balance for gases.

13. Natural Gas.—Natural gas is ordinarily distributed and used without any attempt at purification. There is, therefore, much less call for analysis of this product. The most important determination is that of heating value, which is carried out in a gas calorimeter as described for illuminating gas in Chapter VII. If the burner of the calorimeter is adjusted for coal gas it will have to be readjusted for the natural gas and a different tip may have to be inserted. The volume of the natural gas should be controlled to give about the same rise in temperature in the calorimeter as is desirable for coal gas. When a knowledge of the total sulphur is desired it is estimated by the method of § 8 of this chapter. A few analyses of natural gas selected from the reports of the Bureau of Mines are given below. It will be noted that no mention is made of unsaturated hydrocarbons, oxygen, carbon monoxide, or hydrogen, which are believed to be entirely absent from American natural gas. The small amounts which may be found in an ordinary analysis are due to air, absorption of gases from water, solubility of the gas in reagents, or error in the explosion or combustion of the hydrocarbons. The hydrocarbons in the above table are reported entirely as methane and ethane. Further discrimination is not possible by ordinary methods of analysis.

ANALYSES OF NATURAL GAS*

	Charleston, W. Va.	Altoona, Pa.	Piqua, O.	Los Angeles, Cal.
CH ₄	76.8	90.0	78.3	59.2
C ₂ H ₆	22.5	9.0	12.6	13.9
CO ₂	0.0	0.2	0.2	26.2
N ₂	0.7	0.8	8.9	0.7
Calculated heating value at 60° F.....	1169.0	1065.0	1010.0	841.0
Calculated sp. gr. air = 1...	0.67	0.60	0.66	0.88

* Burrell and Robertson, Bureau of Mines Technical Paper 158 (1917).

The combustion of the hydrocarbons of natural gas offers considerable difficulty. Not only is it difficult to burn hydrocarbons with copper oxide but Anderson¹ states that there is difficulty in burning natural gas with oxygen in a combustion pipette if considerable amounts of gasoline vapors are present. In a later article Anderson² gives detailed corrections to be applied to the results of combustion. The effect of deviation from the theoretical volume has been discussed in Chapter VI. Anderson advocates the expression of the results of analysis of natural gas in the form of the average number of carbon atoms per molecule of paraffine hydrocarbons. If n is the average number of carbon atoms

$$n = \frac{3 \text{ CO}_2}{2 \text{ contraction} - \text{CO}_2}$$

The volume V of paraffine hydrocarbons will then be

$$V = \frac{\text{CO}_2}{n}$$

Corrections for deviation from theoretical formulæ are worked out as curves and formulæ and corrections for calculating specific gravity and heating value from analysis are also given in the paper referred to.

¹ *J. Ind. & Eng. Chem.*, 9, 142 (1917).

² *J. Ind. & Eng. Chem.*, 11, 299 (1919).

Burrell and Seibert¹ have developed a method of analysis of gases by fractional distillation at low temperatures. A comparison of the results of the application of this method to the analysis of a Pittsburgh natural gas as compared with the ordinary analysis is given below. It will be noted that there are material differences.

COMPOSITION OF NATURAL GAS FROM PITTSBURGH

	Analysis by ordinary methods	Analysis by fractional distillation at low temperature
CH ₄	79.2	84.7
C ₂ H ₆	19.6	9.4
C ₃ H ₈	3.0
C ₄ H ₁₀ (mainly).....	1.3
N ₂	1.2	1.6

14. Gasoline in Natural Gas.—Some gases contain enough gasoline vapors to make it pay to condense them by compression and refrigeration. Burrell² reports that the specific gravity of the gas gives good indication of its value for this purpose. Pittsburgh natural gas with a specific gravity of 0.64 when compared with air, does not yield commercial quantities of gasoline. Gases with specific gravity of 0.95 to 1.60 yield commercially from one to five gallons of 75 to 98° Bé. gasoline per thousand cubic feet of gas. Heavy oils of various sorts may also be used as absorbents for gasoline vapors and the process may be successfully applied to gases yielding less than a pint of gasoline per 1000 cu. ft. of gas. Absorption in oil is also used as an analytical method to determine the amount of gasoline in the gas. Dykema³ illustrates various types of commercial testing apparatus. A measured quantity of gas is bubbled through a heavy petroleum oil preferably contained in a series of washers. If only a single washer is used the percentage of saturation should be kept be-

¹ *J. Am. Chem. Soc.*, 36, 1538 (1914).

² *Bull.* 88, U. S. Bureau of Mines.

³ Bureau of Mines *Bull.* 176. Recent developments in the absorption process for recovering gasoline from natural gas. 1919.

low 4 per cent. In another type of apparatus applicable especially to rich gases a cubic foot tank is filled with the gas and about 850 cc. of absorption oil injected through one of the valves. The tank and contents are then violently agitated for twenty minutes to make sure that the oil has extracted all of the gasoline, after which the oil is removed and 800 cc. of the oil is distilled. In any absorption process the amount of gasoline is finally determined by distillation of the absorption oil, using a condenser cooled with ice water.

CHAPTER XIII

LIQUID FUELS

1. Introduction.—The liquid fuel most frequently used is petroleum in either a crude or semi-refined form. Coal tar and tar products rank next in importance. Alcohol may become important in the future. These fuels, which are to be burned directly, are usually blown into the furnace in a fine spray by means of steam or compressed air. The main points to be determined are their heating value, their behavior in the burner and the relative danger which attends their storage. Fuels which are to be vaporized before combustion, as is the case in internal combustion engines, kerosene lamps, etc., require more elaborate tests.

2. Sampling.—The main difficulty in getting a representative sample of liquid fuel is caused by the layer of water and sediment which frequently accumulates on the bottom of a tank of oil or on the surface of one of tar. The main portion of the liquid may also be stratified if various grades have been mixed. The U. S. Bureau of Mines¹ recommends that the oil be sampled as delivered and that either a small stream be run off continuously into a drum from which, after mixing, a smaller sample shall be taken, or that at regular intervals a small dipperful shall be taken from the main stream and placed in a mixing drum. Where it is necessary to sample from a small tank, a proportional sample may be obtained by slowly lowering a glass tube vertically through the oil till the lower end rests on the bottom. If now the upper end be closed by the thumb a column of liquid may be drawn out which represents the composition of the vertical section at the point of sampling. For large tanks the glass tube is replaced by one of tin carrying throughout its length a stiff wire on whose lower end is a tapering cork. When the cork hits the bottom

¹ Technical Paper 3, Bureau of Mines. Specifications for the Purchase of Fuel Oil for the Government with Directions for Sampling Oil and Natural Gas.

of the tank as the tube is lowered, it is forced up into the tube, sealing the latter so that the sample may be drawn to the surface without leakage. In default of a sampling tube a corked empty bottle with a string tied to the cork may be lashed to a stick and be used. When the bottle has been lowered to the desired depth a pull on the string removes the cork and allows the bottle to fill with oil which can be withdrawn and form part of a composite sample.

3. Heating Value.—The heating value of liquid fuels may be determined in either the bomb or Parr calorimeter in accordance with the general directions in Chapters XVI and XVII. Some difficulty in combustion will be experienced since all the compounds volatilize very rapidly during combustion and there is danger that some of the vapors may break through the flame zone without being completely burned. Incomplete combustion may usually be detected on opening the calorimeter by the odor, and the presence of soot on the inside of the cover. The difficulty becomes greater with volatile liquids like gasoline or alcohol, both because of their greater volatility in the calorimeter and because of the difficulty of weighing the sample accurately.

Slightly volatile liquids such as tar and heavy petroleum oils may be weighed directly into the capsule of the bomb calorimeter and burned completely, if oxygen under 25 atmospheres pressure is used. It is advisable to place on the oil a small weighed pellet of sugar or benzoic acid to start combustion. More volatile liquids must be weighed in thin-walled bulbs of about 0.5 c.c. capacity with capillary necks which the analyst may blow for himself out of fine glass tubing. These are filled by warming the weighed bulb and immersing the open neck in the liquid. Contraction of the air in the bulb draws up a little of the liquid and by repetition of the process the bulb may be filled. The capillary neck may then be sealed close to the bulb with a small blow-pipe flame. The increase in weight of the bulb plus the portion of the neck fused off gives the weight of oil in the sample. The sealed bulb is placed on the capsule of the calorimeter and around it is piled about 0.25 gm. of sugar or benzoic acid in contact with the fuse wire. The combustion of this material breaks the bulb and ignites the contents. Richards and Jesse¹ have shown that

¹ *Jour. Am. Chem. Soc.*, 32, 268 (1910).

even this method fails to give complete combustion with volatile liquids like benzene. They recommend the following procedure as successful.

“The benzene in a very thin glass bulb was placed in the bottom of a narrow platinum crucible, 2 cm. in diameter and 2.5 cm. high. A few millimeters above the bulb was fixed a small platform of thin glass bearing a weighed quantity of powdered sugar. The passage of a current through the coil of iron wire ignited the sugar, which in its turn burst the bulb and ignited the benzene at a moment when the whole top of the narrow crucible was filled with flame from the burning sugar. Thus none of the benzene vapor could escape ignition. The trouble with the old method had been that the larger crucible was too wide. Moreover, the sugar had been beneath the benzene instead of above it, so that some of the benzene escaped unconsumed. The amount which thus escaped was greater when there was more nitrogen present than when there was less. Obviously, with non-volatile compounds like sugar the width of the crucible would make no difference.”

Gelatine capsules such as used by pharmacists have also been recommended as containers for volatile oils, but their moisture content changes so rapidly in the air that it is difficult to keep constant the necessary correction factor for the gelatine.

The heating value of oils may also be determined in the Parr calorimeter, which is described in Chapter XVII. Non-volatile oils may be weighed directly into the calorimeter which already contains the peroxide mixture, and mixed thoroughly with the charge by means of a stiff wire. Volatile liquids may be placed in the calorimeter in a thin-walled glass bulb as directed for the bomb calorimeter, and the charge of chemicals placed upon it. The calorimeter is then closed with the cap provided and shaken violently until the bulb is broken and the oil is mixed with the peroxide. A correction in addition to those specified in Chapter XVII must be deducted for the heat liberated by reaction between the peroxide and the glass of the bulb. Professor Parr gives this correction as 0.017° C. per 0.1 gm. glass.

The weight of oil taken should be about 0.3 gm. and the charge 10 gm. of Na_2O_2 and 1 gm. of KClO_3 . The use of 0.2 gm. benzoic acid is also advantageous. Care must be taken that crude petroleum and tars do not carry much emulsified water, for the water reacts with the peroxide with evolution of heat. In ex-

treme cases a violent explosion may take place, wrecking the calorimeter.

If the oil is of such a type that it may be burned without smoke in a burner without a wick and there is at least a pint of the oil available, the most convenient method of determining heat value is in a calorimeter of the type whose use for determining the heating value of gases is described in Chapter VII. The apparatus as modified for liquids requires a suitable burner for the oil which hangs upon a balance during the determination as

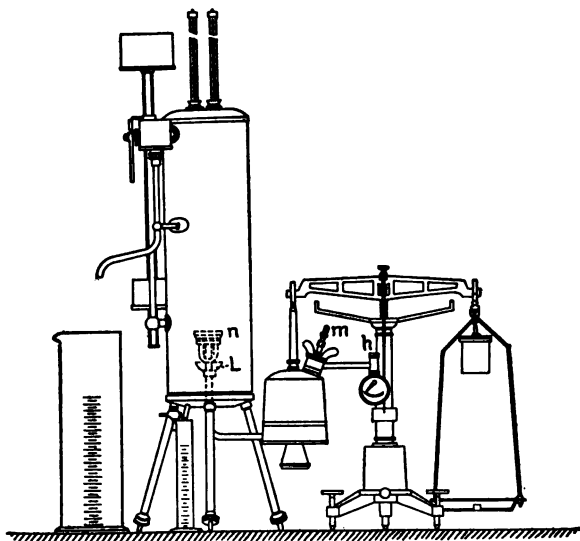

FIG. 44.—Calorimeter for heating value of oils.

shown in Fig. 44. The lamp as shown in the illustration requires 150-200 c.c. of oil. To start the lamp the cup L is filled with alcohol which is lighted to preheat the burner head, n. When the alcohol is nearly burned away, air-pressure is placed upon the liquid by a hand pump connected to m. The oil rises in the burner, vaporizes and ignites in the alcohol flame. The pumping is continued until a freely-burning blue flame results when the pump is disconnected. After the water is flowing normally through the calorimeter, the lighted lamp is inserted and centered in the combustion space. When equilibrium has been reached, the balance

is brought to zero by proper adjustment of weights in the pan and the experiment started. After a definite weight of oil, usually 5 or 10 gm., has been burned, the experiment is interrupted and from the rise in temperature and the weight of water heated the heating value of the fuel may be calculated. The details and precautions are in general the same as given for the gas in Chapter VII. Especial care must be taken that the flame does not impinge directly against the metal of the calorimeter since incomplete combustion will result from the sudden cooling of the gases while combustion is still in progress.

4. Specific Gravity.—The specific gravity of petroleum products is less than 1 and is usually reported on the Baumé scale for liquids lighter than water. Tar is usually heavier than water and its specific gravity is reported directly. If a sufficient quantity of material is available and it is not too viscous, the specific gravity may be determined with approximate accuracy by a hydrometer spindle. If greater accuracy is required or if only a small sample is available a pycnometer or Westphal balance must be used. If a specific gravity on water-free material is demanded, the oil must be put into a flask without the addition of any diluent and distilled slowly till the water is off. The oil distilled is then separated from the water and returned to the residue in the still after it has cooled. A comparison of the Baumé scale for liquids lighter than water and the corresponding specific gravities is given in Table XIII of the Appendix.

5. Moisture.—The various methods for the determination of water in petroleum have been carefully examined by Allen and Jacobs.¹ They recommend a method which involves the measurement of the hydrogen evolved by the action of the water on metallic sodium and also the method of distillation, either with or without the addition of water-saturated toluene or xylene. The latter method will probably give the better results in inexperienced hands. It may be used for tar as well as petroleum products. The toluene is added to diminish the viscosity of the mass and lessen the danger of foaming and bumping. Instead of toluene, xylene or petroleum benzine with a boiling-point of 110 to 150° C. may be used. The diluent must, however, be first shaken with water and then allowed to stand until perfectly clear in order that it may not dissolve

¹Technical Paper 25, U. S. Bureau of Mines, 1912.

any of the water of the sample. The sample of about 100 gm. is weighed into a distilling flask holding at least 500 c.c. and to it is added a roughly measured volume of 100 c.c. of the diluent, or 200 c.c. if the sample is very viscous. The distillation is started slowly and continued until the distillate no longer comes over turbid and approximately as much oil has distilled as was added as a diluent. The distillate is caught in a graduated cylinder and the volume of water read directly after sufficient time has been given for it to settle by gravity. Allen and Jacobs state that the method may be made accurate to approximately 0.033 gm. water for each 100 c.c. of benzene and oil in the distillate.

The details of a similar method for the determination of water in tar as used in the laboratories of the Barret Manufacturing Company have been published by S. R. Church.¹ He specifies exactly the dimensions of the still, the manner of placing the thermometer and other details. The distillation is to be continued until the thermometer in the vapor has reached 205° C. He recommends a convenient form of graduated separatory funnel for the distillate and states that a clean separation of the oil and water can be obtained if 25 c.c. of benzene is introduced into the separatory funnel before the distillation is started.

6. Proximate Analysis.—A proximate analysis in the sense in which it is used in coal analysis is not often made on liquid fuels because they are so largely volatile that the test has little meaning. The ash gives some measure of suspended earthy solids and in the case of tar, the fixed carbon gives an indication of the amount of "free carbon" in the tar. It is necessary to modify the standard method for volatile matter in coal by heating the crucible gently until all foaming has stopped.

7. Suspended Solids.—Suspended solids which in the case of crude petroleums usually are earthy matters and in the case of tars are fine particles of coke forming the so-called "free carbon" are separated by filtration and washing. The oil or tar is first filtered through a 30- or 40-mesh sieve to remove coarse foreign bodies accidentally included. A weighed sample of 5 or 10 gm. is then diluted with pure benzene or toluene until it will filter readily. The solution is filtered through a

¹ *Jour. Ind. and Eng. Chem.*, 3, 228 (1911).

pair of weighed heavy filter papers or through a Gooch funnel and the filter washed with more of the warm solvent until the extraction is complete. The filter is then dried at 105° C. The increase in weight gives suspended solids. If there is much water in the liquid being examined it may be retained on the filter in the form of drops during the first filtration. This water may be driven off by gentle heating and the extraction of soluble material then continued.

8. Flash Point.—The flash point of an oil indicates the temperature at which the oil gives off combustible vapors with sufficient rapidity to form an explosive mixture with the air above it. The flash point will depend upon the rate of heating the oil, the volume of air above it, the rapidity with which the air is replaced and many other variables. It is evident that the conditions must be closely specified in order that the results may be of value. The figure is of great importance with kerosene oil and most of the states have definite and for the most part different regulations on the subject. The older forms of apparatus had open cups, but the more modern forms have closed cups. The American Society for Testing Materials has adopted as its standard the Tag Closed Tester illustrated in Fig. 45. The United States Fuel Administration has adopted the same instrument for testing the flash-point of kerosene. The method of determining flash point is as follows:¹



FIG. 45.—Tag closed tester for flash point of oils.

1. (a) Flash point shall be determined with the Tag Closed Tester, operated in accordance with the directions given below.

¹ *Proceedings* Am. Soc. Test. Mat., 18, 685 (1918).

(b) For unofficial tests any suitable closed type of tester such as the Abel, the Abel-Pensky or the Elliott may be used.

2. (a) If gas is available, connect a $\frac{1}{8}$ -in. rubber tube to the corrugated gas connection on the oil cup cover. If no gas is available, unscrew the test flame burner-tip from the oil chamber on the cover, and insert a wick of cotton cord in the burner-tip and replace it. Put a small quantity of cotton waste in the oil chamber, and insert a small quantity of signal, sperm or lard oil in the chamber, light the wick and adjust the flame, so that it is exactly the size of the small white bead mounted on the top of the tester.

(b) The test shall be performed in a dim light so as to see the flash plainly.

(c) Surround the tester on three sides with an inclosure to keep away draughts. A shield about 18 in. square and 2 ft. high, open in front, is satisfactory, but any safe precaution against all possible room draughts is acceptable. Tests made in a laboratory hood or near ventilators will give unreliable results.

(d) See that the tester sets firm and level.

(e) For accuracy, the flash-point thermometers which are especially designed for the instrument should be used, as the position of the bulb of the thermometer in the oil cup is essential.

3. Put the water-bath thermometers which are especially designed for the instrument in place, and place a receptacle under the overflow spout to catch the overflow. Fill the water bath with water at such a temperature that, when testing is started, the temperature of the water bath will be at least 10° C. below the probable flash point of the oil to be tested.

4. Put the oil cup in place in the water bath. Measure 50 c.c. of the oil to be tested in a pipette or a graduate, and place in the oil cup. The temperature of the oil shall be at least 10° C. below its probable flash point when testing is started. Destroy any bubbles on the surface of the oil. Put on the cover, with flash-point thermometer in place and gas tube attached. Light the pilot light on the cover and adjust the flame to the size of the small white bead on the cover.

5. Light and place the heating lamp, filled with alcohol, in the base of the tester and see that it is centrally located. Adjust the flame of the alcohol lamp so that the temperature of the oil in the cup rises at the rate of about 1° C. per minute, not faster than 1.1° nor slower than 0.9° per minute.

6. (a) Record the barometric pressure which, in the absence of a laboratory instrument, may be obtained from the nearest Weather Bureau Station.

(b) Record the temperature of the oil sample at start.

(c) When the temperature of the oil reaches about 5° C. below the

probable flash point of the oil, turn the knob on the cover so as to introduce the test flame into the cup, and turn it promptly back again. Do not let it snap back. The time consumed in turning the knob down and back should be about one full second, or the time required to pronounce distinctly the words "one-thousand-and-one."

(d) Record the time of making the first introduction of the test flame.

(e) Record the temperature of the oil sample at the time of the first test.

(f) Repeat the application of the test flame at every 0.5° C. rise in temperature of the oil until there is a flash of the oil within the cup. Do not be misled by an enlargement of the test flame or halo around it when entered into the cup, or by slight flickering of the flame; the true flash consumes the gas in the top of the cup and causes a very slight explosion.

(g) Record the time at which the flash point is reached.

(h) Record the flash point.

(i) If the rise in temperature of the oil, from the "time of making the first introduction of the test flame" to the "time at which the flash point is reached" was faster than 1.1° or slower than 0.9° C. per minute the test should be questioned, and the alcohol heating lamp adjusted so as to correct the rate of heating. It will be found that the wick of this lamp can be so accurately adjusted as to give a uniform rate of rise in temperature of 1° C. per minute and remain so.

7. (a) It is not necessary to turn off the test flame with the small regulating valve on the cover; leave it adjusted to give the proper size of flame.

(b) Having completed the preliminary test, remove the heating lamp, lift up the oil cup cover, and wipe off the thermometer bulb. Lift out the oil cup, and empty and carefully wipe it. Throw away all oil samples after once used in making a test.

(c) Pour cold water into the water bath, allowing it to overflow into a receptacle, until the temperature of the water in the bath is lowered to 8° C. below the flash point of the oil, as shown by the previous test.

With cold water of nearly constant temperature, it will be found that a uniform amount will be required to reduce the temperature of the water bath to the required point.

(d) Place the oil cup back in the bath and measure into it a 50-c.c. charge of fresh oil. Destroy any bubbles on the surface of the oil, put on the cover with its thermometer, put in the heating lamp, record the temperature of the oil, and proceed to repeat the test as described above in Sections 4 to 6, inclusive. Introduce the test flame for first time at a temperature of 5° C. below the flash point obtained on the previous test.

8. If two or more determinations agree within 0.5° C., the average of these results, corrected for barometric pressure, shall be considered the flash point. If two determinations do not check within 0.5° C., a third determination shall be made and if the maximum variation of the three tests is not greater than 1° C., their average, after correcting for barometric pressure, shall be considered the flash point.

9. A correction table furnished with each instrument, for converting the results of tests made at varying barometric pressures to equivalent temperatures at the standard barometric pressure of 760 mm.

9. Gasoline.—Gasoline is defined in Webster's new International Dictionary as "a volatile inflammable liquid used as a solvent for oils, fats, etc., as a carburetant, and to produce heat and motive power." The gasoline of commerce has changed its composition markedly within recent years. Originally one of the volatile fractions obtained by "straight" distillation of petroleum, it has changed to be largely a product of destructive distillation with progressively lower Baumé gravity and higher average boiling point. Rather heavy oils are made to flash more readily through mixture with the very volatile casing-head gasolines recovered from natural gas. The definition given above is broad enough to cover benzene and other products derived from destructive distillation of coal, as well as alcohol and other products from destructive distillation of wood or fermentation of grain or molasses.

It is obvious that with such a wide range of chemical composition, only the broadest tests can be applied. The determination of flash point is unnecessary because all gasolines flash at ordinary temperatures. Heating value is of some importance with the mixed products for, as shown by Table IX of the Appendix, the heating values may vary widely. The following figures will illustrate this:

HEATING VALUE OF LIQUID FUELS

Name	Formula	Sp. gr.	Heating value	
			Per pound	Per gallon
Pentane.....	C_5H_{12}	0.6273	21,177	110,670
Hexane.....	C_6H_{14}	0.6640	20,914	115,620
Benzene.....	C_6H_6	0.8846	18,447	135,950
Methyl alcohol.....	CH_3OH	0.8027	10,250	68,540
Ethyl alcohol.....	C_2H_5OH	0.7946	13,325	88,200

Since liquid fuels are usually sold by volume it is the heat units in a gallon which are important. On this basis benzene is seen to be distinctly the best and methyl alcohol the poorest. However, other considerations than heating value enter into the efficiency with which these fuels are used in an internal combustion engine. Benzene with its high carbon content tends to form free carbon in the engine cylinder which cuts down its efficiency. Alcohol with its higher oxygen content is free from this trouble and in admixture with hydrocarbons lessens formation of free carbon. Methyl and ethyl alcohol may both be used with higher compressions than gasoline without preignition, so that a gallon of ethyl alcohol is, in a suitably designed engine, practically the equivalent of a gallon of gasoline. The best test of a motor spirit is an actual operating test in an engine similar to that in which it is to be used. The distillation test is the best laboratory guide in predicting how an oil will behave in the carburetor and cylinder.

10. Specifications for Motor Gasoline.—The committee on Standardization of Petroleum Specifications appointed by the United States Fuel Administration has adopted specifications effective November 25, 1919, of which the following is a copy.

Quality.—Gasoline to be high grade, refined, and free from water and all impurities, and shall have a vapor tension not greater than ten pounds per square inch at 100° F. temperature, same to be determined in accordance with the current "Rules and Regulations for the transportation of explosives and other dangerous articles by freight," as issued by the Interstate Commerce Commission.

Inspection.—Before acceptance the gasoline will be inspected. Samples of each lot will be taken at random. These samples immediately after drawing will be retained in a clean, absolutely tight closed vessel and a sample for test taken from the mixture in this vessel directly into the test vessel.

Specifications.—(a) Boiling point must not be higher than 60° C. (140° F.).

(b) 20 per cent. of the sample must distill below 105° C. (221° F.).

(c) 50 per cent. must distill below 140° C. (284° F.).

(d) 90 per cent. must distill below 190° C. (374° F.).

(e) The end or dry point of distillation must not be higher than 225° C. (437° F.).

(f) Not less than 95 per cent. of the liquid will be recovered in the receiver from the distillation.

Test.—One hundred cubic centimeters will be taken as a test sample. The apparatus and method of conducting the distillation test shall be that adopted by Sub-Committee XI of Committee D-1 of the American Society for Testing Materials¹ (as shown in Fig 46), with the following modifications:

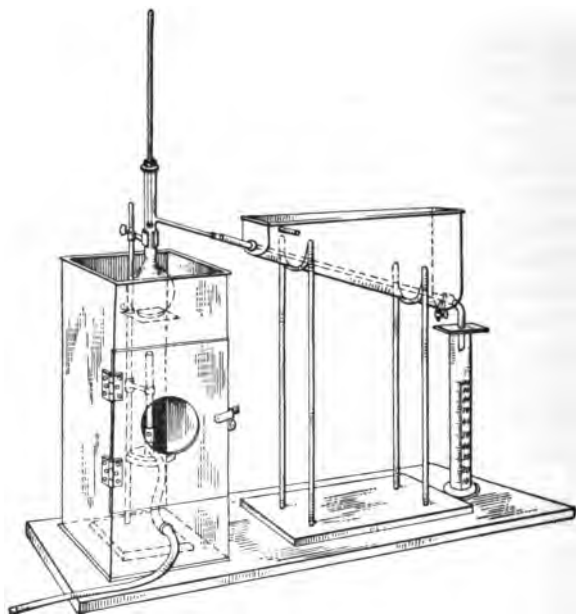

FIG. 46.—Apparatus for distillation of petroleum.

First: The temperature shall be read against fixed percentage points, and, second: the thermometer shall be as hereinafter described:

Flask.—The flask used shall be the standard 100 c.c. Engler Flask, described in the various textbooks on petroleum. Dimensions are as follows:

Dimensions	Cm.	Inches
Outside diameter of bulb.....	6.5	2.56
Outside diameter of neck.....	1.6	0.63
Length of neck.....	15.0	5.91
Length of vapor tube.....	10.0	3.94
Outside Diameter of vapor tube....	0.6	0.24

¹ American Society for Testing Materials, Year Book for 1915, pp. 568-569; or pt. 1, Committee Reports, 1916, vol. 16, pp. 518-521. See also Bureau of Mines Technical Papers Nos. 166 and 214.

① Position of vapor tube, 9 cm. (3.55 in.) above the surface of the gasoline when the flask contains its charge of 100 c.c. The tube is approximately in the middle of the neck. The observance of the prescribed dimensions is considered essential to the attainment of uniformity of results.

The flask shall be supported on a ring of asbestos having a circular opening $1\frac{1}{4}$ in. in diameter; this means that only this limited portion of the flask is to be heated. The use of wire gauze is forbidden.

Condenser.—The condenser shall consist of a thin walled tube of metal (brass or copper) $\frac{1}{2}$ in. internal diameter and 22 in. long. It shall be set at an angle of 75° from the perpendicular and shall be surrounded with a cooling jacket of the trough type. The lower end of the condenser shall be cut off at an acute angle and shall be curved down for a length of 3 inches. The condenser jacket shall be 15 in. long.

Thermometer.—The thermometer shall be made of selected enamel-backed tubing having a diameter between 5.5 and 7 mm. The bulb shall be of Jena normal or Corning normal glass, its diameter shall be less than that of the stem and its length between 10 and 15 mm. The total length of the thermometer shall be approximately 380 mm. The range shall cover 0° C. (32° F.) to 270° C. (518° F.) with the length of the graduated portion between the limits of 210 to 250 mm. The point marking a temperature of 35° C. (95° F.) shall not be less than 100 mm. nor more than 120 mm. from the top of the bulb. For commercial use the thermometer may be graduated in the Fahrenheit scale.

The scale shall be graduated for total immersion. The accuracy must be within about 0.5° C. The space above the meniscus must be filled with an inert gas, such as nitrogen, and the stem and bulb must be thoroughly aged and annealed before being graduated.

Source of Heat in Gasoline Distillation.—The source of heat in distilling gasoline may be a gas burner, an alcohol lamp, or an electric heater.

PROCEDURE AND DETAILS OF MANIPULATION IN CONDUCTING DISTILLATIONS

1. If an electric heater is used it is started first to warm it.
2. The condenser box is filled with water containing a liberal portion of cracked ice.
3. The charge of gasoline is measured into the clean, dry Engler flask from a 100 c.c. graduate. The graduate is used as a receiver for distillates without any drying. This procedure eliminates errors due to incorrect scaling of graduates and also avoids the creation of an

apparent distillation loss due to the impossibility of draining the gasoline entirely from the graduate.

4. The above-mentioned graduate is placed under the lower end of the condenser tube so that the latter extends downward below the top of the graduate at least 1 in. The condenser tube should be so shaped and bent that the tip can touch the wall of the graduate on the side adjacent to the condenser box. This detail permits distillates to run down the side of the graduate and avoids disturbance of the meniscus caused by the falling of drops. The graduate is moved occasionally to permit the operator to ascertain that the speed of distillation is right, as indicated by the rate at which drops fall. The proper rate is from 4 c.c. to 5 c.c. per minute, which is approximately two drops a second. The top of the graduate is covered, preferably by several thicknesses of filter paper, the condenser tube passing through a snugly fitting opening. This minimizes evaporation losses due to circulation of air through the graduate and also excludes any water that may drip down the outside of the condenser tube on account of condensation on the ice-cooled condenser box.

5. A boiling stone (a bit of unglazed porcelain or other porous material) is dropped into the gasoline in the Engler flask. The thermometer is equipped with a well-fitted cork and its bulb covered with a thin film of absorbent cotton (preferably the long-fibered variety sold for surgical dressing). The quantity of cotton used shall be not less than 0.005 nor more than 0.010 g. (5 to 10 milligrams). The thermometer is fitted into the flask with the bulb just below the lower level of the side neck opening. The flask is connected with the condenser tube.

6. Heat must be so applied that the first drop of the gasoline falls from the end of the condenser tube in not less than five or more than ten minutes. The initial boiling point is the temperature shown by the thermometer when the first drop falls from the end of the condenser tube into the graduate. The operator should not allow himself to be deceived as sometimes (if the condenser tube is not dried from a previous run) a drop will be obtained and it will be sometime before a second one falls; in this case the first drop should be ignored. The amount of heat is then increased so that the distillation proceeds at a rate of from 4 c.c. to 5 c.c. per minute. The thermometer is read as each of the selected percentage marks is reached. The maximum boiling point or dry point is determined by continuing the heating after the flask bottom has boiled dry until the column of mercury reaches a maximum and then starts to recede consistently.

7. Distillation loss is determined as follows: The condenser tube is allowed to drain for at least five minutes after heat is shut off, and a

final reading taken of the quantity of distillate collected in the receiving graduate. The distillation flask is removed from the condenser and thoroughly cooled as soon as it can be handled. The condensed residue is poured into a small graduate or graduated test tube and its volume measured. The sum of its volume and the volume collected in the receiving graduate, subtracted from 100 c.c. gives the figure for distillation loss.

11. Kerosene.—Kerosene is usually ranked as an illuminating oil rather than as a fuel oil and tests are framed to determine its suitability for use in lamps. The most important test for this purpose is the flash test which insures safety from explosion caused by accumulation of combustible vapors in the bowl of the lamp. Various specifications have been written for kerosene but the recommendations of the Committee on Standardization of Petroleum Specifications¹ will probably supplant the others. The tests and specifications for water-white kerosene are quoted below. Tests and specifications for long-time burning oil, 300 degree mineral seal oil and signal oil are also included in the same bulletin.

WATER-WHITE KEROSENE. METHODS OF TEST

Flash.—To be taken on the Tag closed cup, A. S. T. M. standard; oil to be heated at the rate of 2° F. per minute; test flame to be applied every 2°, commencing at 105° F.

Color.—To be determined on the Saybolt colorimeter or its equivalent.

Sulphur.—Test to be made by burning at least 2 grams of the oil in a small flask and absorbing the gases of combustion in a standard solution of Sodium Carbonate and titrating the excess of Sodium Carbonate with the standard solution of Sulphuric Acid.

Floc.—Directions for making test: Take a hemispherical iron dish, and place a small layer of sand in the bottom. Take a 500 c.c. Florence or Erlenmeyer flask and into it put 300 c.c. of the oil (after filtering if it contains suspended matter). Suspend a thermometer in the oil by means of a cork slotted on the side. Place flask containing the oil in the sand bath, and heat bath so that the oil has reached a temperature of 240° F. at the end of one hour. Hold oil at temperature of not less than 240° F. nor more than 250° F. for six hours. The oil may become discolored but there should be no suspended matter formed in

¹ Bulletin No. 2, U. S. Fuel Administration, 1918.

the oil. The flask should be given a slight rotary motion and if there is a trace of "floc" it can be seen to rise from the center of the bottom.

Distillation Test.—The oil shall all distill below temperature of 600° F. The test is made as described by the Bureau of Mines, Technical Papers 166, using A. S. T. M. apparatus with wet bulb and total immersion thermometer.

Cloud Test.—Directions for making test: Take a 4-ounce oil sample bottle and introduce therein 1½ ounces of the oil to be tested; insert cork with cold-test thermometer so that thermometer is suspended in the oil. Place bottle in a freezing mixture and cool to 0° F. Keep oil cooled to this temperature for 10 minutes. Bottle should be given a rotary motion occasionally so as not to supercool the sides. The oil should not be clouded from crystals of paraffin wax at the end of 10 minutes.

Reaction.—Two ounces of the oil should be shaken with one-half ounce of warm neutral distilled water and allowed to cool and separate. The water when separated shall react neutral to methyl-orange and phenol-phthalein.

Burning Test.—The oil must burn freely and steadily in a lamp fitted with a No. 1 sun hinge burner. It must give a good flame for a period of 18 hours without smoking or forming "ears" or "toad-stools" on the wick. The chimney must be only slightly clouded or stained at the end of the test.

SUMMARY OF SPECIFICATIONS—WATER-WHITE KEROSENE

Appearance.—Oil must be free from water, glue, and suspended matter.

Flash.—Not less than 115° F., Tag closed cup, A. S. T. M. standard.

Color.—To be 21 color on Saybolt colorimeter or its equivalent on a Lovibond tintometer, these being equal to color of a solution of Potassium Bichromate containing 0.0048 grams per liter.

Sulphur.—Not more than 0.06 per cent.

Floc.—Oil to be free from floc.

Distillation.—Oil to distill below temperature of 600° F.

Cloud Test.—Oil should not show cloud at 0° F.

Reaction.—Must be neither acid nor alkaline.

Burning Test.—As stated above.

12. Fuel Oil.—Tentative regulations for the storage and use of the fuel oil were adopted by the Committee on Inflammable Liquids of the National Fire Protection Association in 1919.¹

¹ Chemical and Metallurgical Engineering 21, 781 (1919).

This committee defined oil-burning equipments as those using only liquids having a flash point above 150° F. in a closed cup tester. Specifications for fuel oil have not been standardized. In addition to flash point a distillation test is sometimes specified, since a mixed product of a heavy residuum and a light naphtha does not behave so well in the burners as a straight product. The oil should be free from water and excessive amounts of sulphur. The latter may be determined by fusion with sodium peroxide according to the method given for coal in Chapter XV.

CHAPTER XIV

SAMPLING COAL

1. **General Consideration.**—However accurate an analysis of coal may be, the results are of little value and are often worse than useless if the sample submitted to the analyst is not a representative one. Elaborate methods have been worked out for sampling gold and silver ores but cost precludes the application of anything but the simplest methods to coal. It is manifest that it is unwise to spend ten cents a ton to determine whether the price is two cents a ton too high. If we assume a shipment of a single car of coal weighing forty tons, which must be sampled and analyzed by itself, it will be seen that a charge of eight dollars for this service will add twenty cents per ton to the price of coal. This is nearly 10 per cent. of the cost of the coal at the mouth of the mine and is an expense which is hardly justifiable.

However if the test is worth making at all it must be on a sample which has fair claim to representativeness. The coal sampler stands eternally between the devil of inadequateness and the deep sea of excessive cost. In large plants where the coal is immediately crushed and removed to storage bins by conveyors a representative sample may readily be obtained. In most cases, however, the coal must be sampled as it comes from the car and the problem is more difficult.

To many people coal is black and all that is black is coal. The more careful observer may detect bits of slate, and streaks or nodules of the brassy looking pyrites. The chemist knows that in addition the fine particles which have crushed because of their greater friability differ in composition from the lump coal and are usually higher in ash, though sometimes the reverse is the case, and that coal is far from being a mass of uniform composition.

2. Difference in Composition of Lump and Fine Coal.—The following tests taken from the author's record of cooperative tests undertaken jointly by the University of Michigan Gas Experiment Station and the United States Bureau of Mines to determine the availability of various coals for gas manufacture show some interesting variations. The coals had mostly been shipped in small lots in sacks and were therefore considerably crushed in transit. They were screened in lots of about 600 lb. on a three-quarter inch bar screen preparatory to gas tests and the screenings and lump coal were separately sampled.

The sampling of the fine coal presented no difficulty since it was already in small lumps and could be crushed as fine as desired. The lump coal could not be finely crushed without detriment to the gas tests and so it was sampled by breaking the large lumps and then taking about two scoopfuls which were crushed and sampled as usual. Of the eleven coals tested in this manner four, one each from West Virginia, Colorado, New Mexico and Wyoming showed very little difference between the lumps and screenings. One coal showed decidedly less ash in the screenings than in the lump coal. Six coals showed noticeable and in some cases notable increases of ash and sulphur in screenings with corresponding decreases of heating value, as shown by the following analyses of the coals calculated to a dry basis.

In the coal from Hellier, Kentucky for which there are three tests, the average heating value of the screenings is 1080 B.t.u. lower than that of the lump. This is entirely due to difference in ash as shown by the figures for heating value figured to coal dry and free from ash, where the difference disappears, the average heating value of the screenings being only 6 B.t.u. below that of the lump. The same thing is true of the other coals of the list—the variation in heating value of lump and screenings disappears almost completely when calculated to a moisture and ash-free basis.

Sulphur is never lower in the screenings than in the lump and is in some cases nearly twice as high.

The last coal in the above table differs from all the others in that the screenings are much lower in ash than the lump. It might be thought that the sample had been labelled incorrectly

5 COMPARISON OF COMPOSITION AND HEATING VALUE OF LUMP COAL SCREENED OVER A 3/4-IN. BAR SCREEN AND THE SCREENINGS

Coal from	Test No.	Per cent. screenings	Dry coal										Coal dry and free from ash	
			Per cent. ash		Per cent. sulphur		B.t.u.		B.t.u.		B.t.u.			
			Lump	Screenings	Lump	Screenings	Lump	Screenings	Lump	Screenings	Lump	Screenings	Lump	Screenings
Allegheny Co., Pa.	32	17.4	5.00	8.44	0.87	1.36	14,386	13,948	15,142	15,234	15,142	15,234		
Hellier, Ky.	21	30.8	6.41	13.24	0.44	0.48	14,234	13,144	15,210	15,149	15,210	15,149		
Hellier, Ky.	30	48.5	3.88	8.22	0.46	0.57	14,665	13,615	15,257	15,194	15,257	15,194		
Hellier, Ky.	54	33.0	3.32	9.91	0.61	0.66	14,820	13,712	15,220	15,328	15,220	15,328		
Blacton, Ala.	33	23.4	4.41	14.91	0.51	0.67	14,380	12,634	15,043	14,848	15,043	14,848		
Saginaw, Mich. ...	34	9.7	5.90	8.40	1.08	1.83	13,730	13,369	14,591	14,594	14,591	14,594		
LaFollette, Tenn. .	31	8.4	2.24	5.38	0.74	1.25	14,706	14,207	15,039	15,016	15,039	15,016		
Harrisburg, Ill. . .	35	27.9	7.54	9.92	2.06	2.68	13,550	13,235	14,656	14,693	14,656	14,693		
Harrisburg, Ill. . .	46-7-8	26.6	6.80	10.86	1.80	3.04	13,676	12,940	14,675	14,517	14,675	14,517		
Oak Creek, Colo. .	24	39.5	15.67	6.97	1.08	1.63	11,799	13,165	13,991	14,152	13,991	14,152		

of it were not for the check afforded by analysis of the coke made from the lump coal. The coke contained 25.3 per cent. of ash, a figure which agrees well with the calculated result of 24.3 per cent. It is evident that in this coal the coal substance is the friable constituent while the ash forms a cementing material. The heating value of the dry screenings is 1366 B.t.u. higher than the lump, but when the ash is eliminated by calculation, the difference drops to 61 B.t.u.

These figures show that the heating value of lump coal may vary as much as 2000 B.t.u. from that of fine coal and that usually the fine coal will contain more ash and have the lower heat value. Occasionally the reverse is the case. The true coal as reckoned to a moisture and ash free basis has practically the same heating value irrespective of its physical fineness.

3. A Scoopful as a Sample.—It is commonly held that a few scoopfuls should be representative of a carload. This question was put to a practical test by Bailey¹ who had a lot of 3 tons of run-of-mine coal carted away in wheel barrows. As each barrow was filled a shovelful of coal was put into, not one, but into each of sixteen sample barrels. After the pile had disappeared there were left the sixteen sample barrels each with about 125 lb. of coal. These samples were crushed and sampled carefully and the ash in each was determined. The results were as follows:

	Per cent. ash
1.....	9.68
2.....	10.28
3.....	13.92 Maximum
4.....	11.22
5.....	10.88
6.....	9.80
7.....	11.84
8.....	10.28
9.....	10.10
10.....	10.64
11.....	10.06
12.....	10.72
13.....	9.46 Minimum
14.....	9.66
15.....	11.08
16.....	11.34

¹ *Trans. Am. Soc. Mech. Eng.*, 27, 639 (1906).

These samples which should have given results in close agreement show an extreme variation of 4.46 per cent. in their ash content. Had the heating values of these samples been determined they would of course have shown similar discrepancies. If this coal had been sold on a premium and penalty basis and the coal with the average ash content of 10.68 had been accepted without premium or penalty, the penalty on a basis of sample No. 3 might readily have been twelve or fifteen cents per ton. And yet in this test the sample consisted of four or five shovelfuls taken from a lot as small as 3 tons and not from a whole car load.

4. Influence of Lumps of Slate.—It is manifest that if all the ash of coal were to be concentrated in lumps the size of a football, that a single scoopful of coal would either show no ash or else an exorbitantly high amount. The error would be much less if the ash were in lumps only the size of walnuts and still less if it were more finely divided. Even if the ash were in large pieces if a sufficient number of scoops should be taken for analysis an average of all the figures would give a correct result. Bailey¹ gives the following table derived partly experimentally and partly mathematically showing the relation between the size of the largest piece of slate and the weight of the sample which must be taken in order that error in sampling shall not cause an error of over 1 per cent. in the ash.

Size of slate, inches	Wt. largest piece of slate, pounds	Original sample should weigh, pounds
4	6.7	39,000
3	2.5	12,500
2	0.75	3,800
1	0.12	600
0.75	0.046	230
0.50	0.018	90

Since there are very few shipments of coal other than the small sizes of anthracite which may not contain pieces of slate weighing a pound it is evident that on this basis a sample of less than 2 tons cannot be considered representative. Any smaller sample whether it be drawn from a wagon load or a

¹ *Jour. Ind. and Eng. Chem.*, 1, 176 (1909).

train of cars cannot be considered as representative of anything except itself.

5. Taking a Sample.—It is fatal for a sampler to try to pick an average sample by taking what seems to him a fair proportion of coarse and fine, and rejecting material that looks either exceptionally good or bad. The only way is to determine how a most representative sample may be secured in a reasonable manner and then to carry out the operation as mechanically as possible.

If the sample is being taken from a wagon the shovel should be run along the bottom of the wagon after enough has been unloaded to allow the coal to assume its natural slope. The same procedure may be followed when coal is being shovelled from flat-bottomed cars. Where cars or wagons are being dumped the scoop may be held in the stream of falling coal. If cars are to be sampled before unloading, a trench, or better two trenches, each 12 in. deep should be dug across the car in order to remove excess of dust and cinder as well as snow which may have collected in the top layers. The sample is to be taken from the bottom of the trench. It is evident that coal sampled in this way will contain too small a proportion of fine coal, most of which will have sifted to the floor of the car. It is therefore preferable to sample during unloading.

If it is necessary to determine the moisture in a car of coal which arrives wet or covered with ice the problem of sampling becomes even more complex. Fortunately, specifications are usually based on dry or air-dry coal so that the accidental moisture acquired in transit is not usually of importance.

6. Mine Sampling.—The methods of sampling coal in a mine as recommended by the U. S. Bureau of Mines have been fully described by Holmes.¹ He recommends that for mines shipping 200 tons or less daily, at least four samples should be taken. In general only clean, fresh coal should be taken and weathered coal should be avoided. Before cutting a sample the face of the bed and the roof is to be cleaned of loose fragments which might drop into the sample and a band 1 ft. wide extending from floor to roof is to be cut back at least an inch to expose fresh coal. The sample as cut from this prepared face should

¹ Technical Paper 1, Bureau of Mines, 1911.

include everything which the miner includes in the coal prepared for the market and should exclude the thick partings and large lenses of pyrite which are thrown out by the miner. The cut should be made perpendicularly about 2 in. deep and 6 in. wide so that there will be about 6 lb. of coal chips for each foot of thickness of the vein. These chips are to be caught on the waterproof sample blanket and crushed to pass a $\frac{1}{2}$ -in. screen. The sample is then quartered down and placed in a tight sample can. All the operations are to be carried on in the mine so as not to expose the coal to the outside atmosphere.

7. Preparation of Sample.—The initial sample must be crushed and subdivided until it is finally ready for the chemical analysis. Care must be taken that it does not change during this process. It is almost impossible to prevent the moisture from changing and where it is necessary to determine this, the whole sample is usually weighed and allowed to dry in a warm room until it has become approximately air-dry, when it is again weighed. It is in any case difficult to sample coal which is very wet or covered with ice and a preliminary air-drying is, where possible, always advisable. The sample must now be crushed and subdivided. Where a well-equipped sampling laboratory is available the crushing will of course be easily accomplished by crushers and the subdivisions either made by mechanical samplers or upon clean iron plates. In such cases there is very little liability to error in this stage of the process. In many cases, however, the crushing and subdivisions must be carried out by hand, often on the floor of the boiler room and frequently under even less favorable conditions. The first requisite is cleanliness of the sampling surface. It is always preferable to sample on a metal plate. A cement floor is to be looked upon with suspicion and not to be used unless it is hard and fails to yield appreciable sand on vigorous sweeping. The liability to error is not great while the sample is large. When it becomes small enough it should be placed on oil cloth if a metal plate is not available. The details of this process are given in section 10 of this chapter.

8. Preservation of Sample.—If the percentage of moisture in the coal is of importance the sample should be placed in an air-tight receptacle and kept in a cool place. Coal which is not finely powdered does not change rapidly but it is advisable to

have the analysis made promptly. Porter and Ovitz¹ have shown that samples of coal evolve methane and carbon dioxide and absorb oxygen for a period of several months. The changes due to the evolution of methane seldom rise above one-tenth of 1 per cent. The changes due to addition of oxygen are less certain but would seem to be possibly as high as 0.5 per cent. Parr has shown that Illinois coals may lose in heat value from 0.5 to 1 per cent. in the first ten days after mining and during the process of preparing the sample for analysis. The rapid changes take place soon after the coal is mined and the rate of change has usually materially decreased before the coal is sampled by the consumer.

9. Usual Accuracy of Sampling.—The figures given by Bailey show that an accuracy of 1 per cent. in the ash is not to be expected by ordinary methods. The following tables give some data resulting from the sampling of two separate carloads of coal. Four separate samples were taken from each car after loading at the mine by an inspector of the Bureau of Mines. The same cars were sampled especially carefully after arrival at their destination, one-sixth of each carload being systematically separated as it was unloaded for the initial sample. This initial sample was cut into four separate ones which were separately sampled and analyzed. There are eight different samples from each carload whose analyses are tabulated in the accompanying table.

PITTSBURG COAL, A. A. 15

		Air-dried coal				B.t.u. of coal free from mois- ture and ash
		Moisture	Ash	S	B.t.u.	
Car at mine	No. 1...	0.95	6.27	0.91	14213	15319
	No. 2...	1.00	5.55	0.72	14315	15318
	No. 3...	0.98	6.23	0.98	14182	15284
	No. 4...	0.96	6.91	0.84	14107	15295
	Average	0.97	6.24	0.86	14204	15304
Car as un- loaded	No. 1...	1.11	5.99	0.82	14215	15301
	No. 2...	0.97	6.54	0.93	14137	15284
	No. 3...	1.01	5.63	0.80	14285	15300
	No. 4...	1.08	5.88	0.81	14206	15269
	Average	1.04	6.00	0.84	14211	15288

¹ Technical Paper 2, Bureau of Mines, 1911.

FAIRMONT COAL, A. A. 16

		Air-dried coal				B.t.u. of coal free from mois- ture and ash
		Moisture	Ash	S	B.t.u.	
Car at mine.	No. 1...	1.10	7.62	0.67	13925	15255
	No. 2...	1.10	7.71	0.64	13874	15216
	No. 3...	1.07	9.23	0.83	13678	15240
	No. 4...	1.17	6.20	0.52	14096	15217
	Average	1.11	7.69	0.66	13898	15232
Car as un- loaded	No. 1...	1.24	8.87	0.64	13671	15209
	No. 2...	1.21	8.98	0.69	13640	15188
	No. 3...	1.28	8.89	0.69	13638	15182
	No. 4...	1.27	9.06	0.73	13604	15160
	Average	1.24	8.95	0.69	13638	15185

The chief variable in these samples is the ash which in turn affects the heating value. The accuracy of the analyses is attested by the close agreement of the heating value referred to coal dry and free from ash. In the Fairmont coal the heating value of the coal taken at the mine is noticeably higher than that sampled from the car, when calculated to an ash and moisture free basis, due possibly to escape of gas from the freshly mined coal.

The average ash content of the Pittsburgh coal is closely the same in the two sets but in the Fairmont coal the average ash as sampled from the car at the mine was 1.6 per cent. lower than that obtained as the car was unloaded. As was pointed out above, this variation is a normal one due to the method of sampling. The variation in the average heating value of these two series amounts to 260 B.t.u., a figure which might easily cause a difference in price of eight cents a ton.

Turning from averages to individual figures we find a better agreement with the Pittsburgh than the Fairmont coal, and in each series the agreement better between the samples taken from the car as unloaded, as should have been the case. The extremes for the Fairmont coal are tabulated as follows:

	Low ash		High ash		Difference	
	per cent. ash	B.t.u.	per cent. ash	B.t.u.	per cent. ash	B.t.u.
Car at mine.....	6.20	14096	9.23	13678	3.03	418
Car as unloaded..	8.87	13671	9.06	13604	0.19	69

The agreement between the samples taken very carefully from the car as unloaded is excellent. The difference between the extremes of the samples taken from the loaded car which amounts to 418 B.t.u. might readily cause a difference of fifteen cents a ton on the settlement price of the coal.

The engineers of the U. S. Bureau of Mines¹ have studied the error in sampling ten different lots of coal. Each of two inspectors collected a sample of 100 lb. from a given lot of coal. In lot *a* their samples differed in heating value by 158 B.t.u. per pound of dry coal. They then each collected a second sample of 100 lb. and averaged the results of this with their first sample. The difference between the two collectors then dropped to 132 B.t.u. In the same way they continued to take successive samples of 100 lb. and average all of their results and after ten of such samples had been taken the differences between the averages for each man was small. As the result of tests on ten different lots of coal they found that it was necessary to collect and average seven different samples of 100 lb. each in order that the result obtained by two collectors should not differ by more than 50 B.t.u. Their average results are given in the following table:

**AVERAGE ERROR IN SAMPLING 10 LOTS OF COAL AS SHOWN
BY THE DISAGREEMENT IN HEATING VALUE OF SUC-
CESSIVE SAMPLES TAKEN BY TWO COLLECTORS**

	Disagreement between two collectors in B.t.u. per pound dry coal
First sample of 100 lb.	251
Average of 2 samples of 100 lb.	200
Average of 3 samples of 100 lb.	125
Average of 4 samples of 100 lb.	111
Average of 5 samples of 100 lb.	75
Average of 6 samples of 100 lb.	78
Average of 7 samples of 100 lb.	51
Average of 8 samples of 100 lb.	53
Average of 9 samples of 100 lb.	44
Average of 10 samples of 100 lb.	37
Average of 11 samples of 100 lb.	32
Average of 12 samples of 100 lb.	32
Average of 13 samples of 100 lb.	25

¹ *Bul.* 63, Bureau of Mines.

10. Standard Methods of Sampling.—Directions for sampling and also specifications for coal as purchased by the United States Government are given in publications of the Bureau of Mines.¹ The American Society for Testing Materials adopted in 1916² a standard method for sampling coal which is quoted below:

FOR ALL DETERMINATIONS EXCEPT TOTAL MOISTURE

1. The coal shall be sampled when it is being loaded into or unloaded from railroad cars, ships, barges, or wagons, or when discharged from supply bins, or from industrial railway cars, or grab buckets, or from any coal-conveying equipments, as the case may be. If the coal is crushed as received, samples usually can be taken advantageously after the coal has passed through the crusher. Samples collected from the surface of coal in piles or bins, or in cars, ships or barges are generally unreliable.

2. To collect samples, a shovel or specially designed tool, or mechanical means shall be used for taking equal portions or increments. For slack or small sizes of anthracite, increments as small as 5 to 10 lb. may be taken but for run-of-mine or lump coal, increments should be at least 10 to 30 lb.

3. The increments shall be regularly and systematically collected, so that the entire quantity of coal sampled will be represented proportionately in the gross sample, and with such frequency that a gross sample of the required amount shall be collected. The standard gross sample shall not be less than 1000 lb. except that for slack coal and small sizes of anthracite in which the impurities do not exist in abnormal quantities or in pieces larger than $\frac{3}{4}$ in., a gross sample of approximately 500 lb. shall be considered sufficient. If the coal contains an unusual amount of impurities, such as slate, and if the pieces of such impurities are very large, a gross sample of approximately 1500 lb. or more should be collected. The gross sample should contain the same proportion of lump coal, fine coal, and impurities as is contained in the coal sampled. When coal is extremely lumpy, it is best to break a proportional amount of the lumps before taking the various increments of a sample. Provision should be made for the preservation of the integrity of the sample.

4. A gross sample shall be taken for each 500 tons or less, or in case of larger tonnages, for such quantities as may be agreed upon.

¹ *Bulletin* 116 and Technical Paper 133 by Geo. S. Pope.

² A. S. T. M. Standards issued by American Society for Testing Materials.

TABLE I

Weight of sample to be divided, lb.	Largest size of coal and impurities allowable in sample before division, inches
1000 or over	1
500	$\frac{3}{4}$
250	$\frac{1}{2}$
125	$\frac{3}{8}$
60	$\frac{1}{4}$
30	$\frac{3}{16}$ or 4-mesh screen

5. After the gross sample has been collected, it shall be systematically crushed, mixed, and reduced in quantity to convenient size for transmittal to the laboratory. The sample may be crushed by hand or by any mechanical means, but under such conditions as shall prevent loss or the accidental admixture of foreign matter. Samples of the quantities indicated in Table I shall be crushed so that no pieces of coal and impurities will be greater in any dimension, as judged by eye, than specified for the sample before division into two approximately equal parts.

The method of reducing by hand the quantity of coal in a gross sample shall be carried out as prescribed in Section 6, even should the initial size of coal and impurities be less than indicated in Table I.

6. The progressive reduction in the weight of the sample to the quantities indicated in Table I shall be done by the following methods, which are illustrated in Fig. 47:

(a) The alternate-shovel method of reducing the gross sample shall be repeated until the sample is reduced to approximately 250 lb., and care shall be observed before each reduction in quantity that the sample has been crushed to the fineness prescribed in Table I. The crushed coal shall be shoveled into a conical pile by depositing each shovelful of coal on top of the preceding one, and then formed into a long pile in the following manner: The sampler shall take a shovelful of coal from the conical pile and spread it out in a straight line having a width equal to the width of the shovel and a length of 5 to 10 ft. His next shovelful shall be spread directly over the top of the first shovelful, but in the opposite direction, and so on back and forth, the pile being occasionally flattened, until all the coal has been formed into one lone pile. The sampler shall then discard half of this pile, proceeding as follows: Beginning on one side of the pile, at either end, and shoveling from the bottom of the pile, the sampler shall take one shovelful and set it aside; advancing along the side of the pile a distance equal to the width of the shovel, he shall take a second shovelful and discard it; again advancing

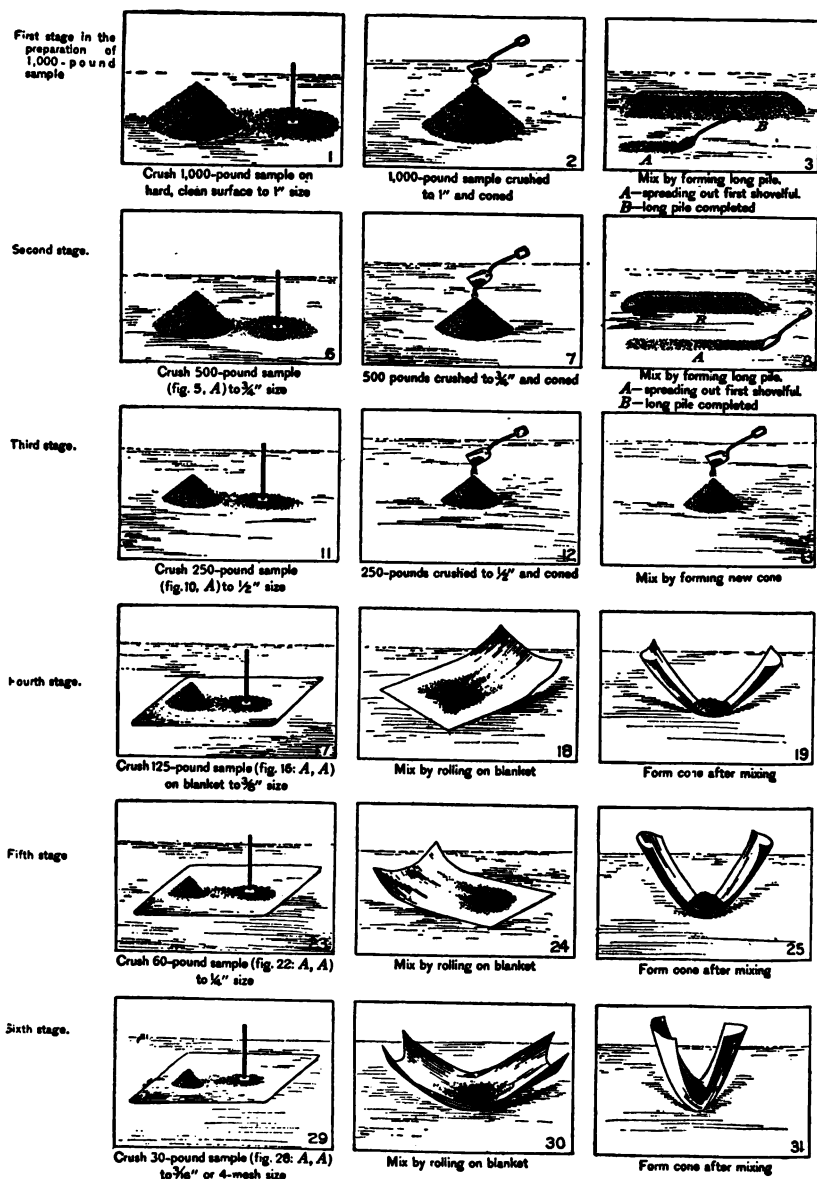

FIG. 47.—Method of preparing a sample of coal by hand. The necessary rake. The coal is raked while being crushed, so that all lumps will be sample is halved or quartered.



4 Halving by alternate shovel method. Shovelfuls 1, 3, 5, etc., reserved as A; 2, 4, 6, etc., rejected as B.



5 Long pile divided into two parts; A—reserve; B—reject



9 Halving by alternate shovel method. Shovelfuls 1, 3, 5, etc., reserved as A; 2, 4, 6, etc., rejected as B.

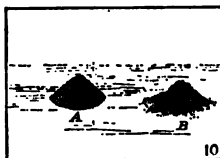

10 Long pile divided into two parts; A—reserve; B—reject



14 Quarter after flattening cone



15 Sample divided into quarters



16 Retain opposite quarters A, A. Reject quarters B, B



20 Quarter after flattening cone



21 Sample divided into quarters

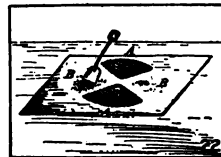

22 Retain opposite quarters A, A. Reject quarters B, B

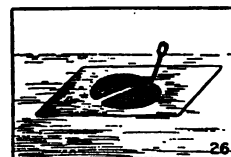

26 Quarter after flattening cone



27 Sample divided into quarters



28 Retain opposite quarters A, A. Reject quarters B, B



32 Quarter after flattening cone

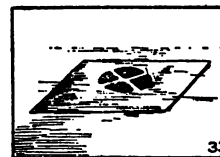

33 Sample divided into quarters

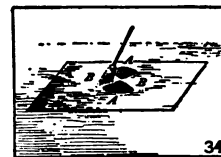

34 Fill two 5-pound sample containers from A, A, one for laboratory, one for reserve

NOTE

SELECT A HARD, CLEAN SURFACE, FREE OF CRACKS AND PROTECTED FROM RAIN, SNOW, WIND, AND BEATING SUN. DO NOT LET CINDERS, SAND, CHIPPINGS FROM FLOOR, OR ANY OTHER FOREIGN MATTER GET INTO THE SAMPLE. PROTECT SAMPLE FROM LOSS OR GAIN IN MOISTURE

tools are a shovel, tamper, blanket measuring about 6 by 8 feet, broom, and crushed. Floor or blanket is swept clean of discarded coal each time after

in the same direction one shovel width, he shall take a third shovelful and add it to the first. The fourth shall be taken in a like manner and discarded, the fifth retained, and so on, the sampler advancing always in the same direction around the pile so that its size will be gradually reduced in a uniform manner. When the pile is removed, about half of the original quantity of coal should be contained in the new pile formed by the alternate shovelfulls which have been retained.

(b) After the gross sample has been reduced by the above method to approximately 250 lb., further reduction in quantity shall be by the quartering method. Before each quartering, the sample shall be crushed to the fineness prescribed in Table I.

Quantities of 125 to 250 lb. shall be thoroughly mixed by coning and re-coning; quantities less than 125 lb. shall be placed on a suitable cloth, measuring about 6 by 8 ft., mixed by raising first one end of the cloth and then the other, so as to roll the coal back and forth, and after being thoroughly mixed shall be formed into a conical pile by gathering together the four corners of the cloth. The quartering of the conical pile shall be done as follows:

The cone shall be flattened, its apex being pressed vertically down with a shovel, or board, so that after the pile has been quartered, each quarter will contain the material originally in it. The flattened mass, which shall be of uniform thickness and diameter, shall then be marked into quarters by two lines that intersect at right angles directly under a point corresponding to the apex of the original cone. The diagonally opposite quarters shall be shoveled away and discarded and the space that they occupied brushed clean. The coal remaining shall be successively crushed, mixed, coned, and quartered until the sample is reduced to the desired quantity.

(c) The 30-lb. quantity shall be crushed to $\frac{3}{16}$ in. or 4-mesh size, mixed, coned, flattened and quartered. The laboratory samples shall include all of one of the quarters, or all of two opposite quarters, as may be required. The laboratory sample shall be immediately placed in a suitable container and sealed in such a manner as to preclude tampering.

7. Only such mechanical means as will give equally representative samples shall be used in substitution for the hand method of preparation herein standardized.

II. FOR THE DETERMINATION OF TOTAL MOISTURE

8. The special moisture sample shall weigh approximately 100 lb., and shall be accumulated by placing in a waterproof receptacle with a tight-fitting and waterproof lid small equal parts of freshly taken increments of the standard gross sample. The accumulated moisture sample

shall be rapidly crushed and reduced mechanically or by hand to about a 5-lb. quantity, which shall be immediately placed in a container and sealed air-tight and forwarded to the laboratory without delay.

9. Only when equally representative results will be obtained shall the standard gross sample be used instead of the special moisture sample for the determination of total moisture.

11. Sampling Coke.—The American Society for Testing Materials adopted in 1916 a standard method for sampling foundry coke which is quoted below from the A. S. T. M. Standards:

I. CHEMICAL PROPERTIES AND TESTS. (A) SAMPLING

1. Each carload, or its equivalent, shall be considered as a unit.

2. (a) The sample shall be taken from the exposed surface of the car, by knocking off with a hammer a piece of approximately the size of a walnut, at regular intervals of 18 in. along three lines running from one end of the car to the other. One of these lines shall pass through the center of the car and the other two lines shall be 2 ft. from the respective sides of the car.

(b) The intervals of sampling along the three lines may be measured by using a hammer with a handle 18 in. long, breaking off a piece of coke the size of a walnut at each point where the head of the hammer rests, regardless of the appearance of the particular piece that happens to occur under the head of the hammer.

3. The total quantity of sample collected in the above manner shall not be less than 2 pecks.

4. When the total moisture content is not to be determined the entire gross sample shall be crushed to pass through a screen having 4 meshes to the linear inch, under such conditions as shall prevent loss or the accidental admixture of foreign matter. The crushing shall be done mechanically with a jaw crusher, or by hand on a chilled iron or hard steel plate by impact of a chilled iron or hard steel tamping bar, hammer or sledge, avoiding all rubbing action, otherwise the ash content of the sample will be materially increased by the addition of iron from the crushing apparatus, even though hardened steel or chilled iron is used.

After all the gross sample has been passed through the 4-mesh screen, it shall be mixed on a strong, closely woven cloth about 5 ft. square by raising successively the four sides of the cloth, thus rolling the sample about until thoroughly mixed. The four corners of the cloth shall then be gathered up, and the sample shall be formed in a conical pile and reduced in quantity by quartering as follows:

The cone shall be flattened, its apex being pressed down so that each

quarter contains the material originally in it. The flattened mass shall then be divided into four equal quarters. The diagonally opposite quarters shall then be removed and discarded and the space that they occupied brushed clean. The two remaining quarters shall be successively mixed, coned and quartered on the cloth as before, until two opposite quarters shall weigh not less than 5 lb., which shall then be placed in a suitable container for transportation to the laboratory. In case duplicate laboratory samples are desired, the rejected portions of the original 4-mesh sample shall be combined, mixed and quartered down to a similar 5-lb. sample.

5. The sample prepared by the above method may, at the option of the purchaser, be used for an approximate moisture determination. In such cases the gross sample shall be immediately crushed and reduced to the 5-lb. laboratory sample as rapidly as possible, to minimize the loss of moisture. The container for shipment to the laboratory shall be moisture-tight. Since the sample obtained by this method will usually show less than the true moisture content of the gross sample, the purchaser shall have the privilege of a special moisture sample as hereinafter provided, if the standard sample shows more than 3 per cent. moisture.

6. The special moisture sample shall consist of not less than 2 pecks of walnut size. It shall be taken in the manner described in Section 2, and shall be placed, immediately after collection, in a moisture-tight container for transportation to the laboratory. The car shall be weighed at the time the special moisture sample is collected.

7. In case of disagreement between buyer and seller, an independent chemist, mutually agreed upon, shall be employed to sample and analyze the coke, the cost to be borne by the party at fault.

The resample shall be taken and prepared as prescribed in the foregoing sections, except that the minimum quantity of gross sample shall be not less than 1 bushel in volume, taken at intervals of 18 in. in six equidistant lines parallel to the side of the car.

(B) CHEMICAL ANALYSIS

8. The sample received at the laboratory shall be prepared for analysis, and the percentage of moisture, volatile matter, fixed carbon, ash, and sulphur shall be determined as specified in the Standard Methods for Laboratory Sampling and Analysis of Coke of the American Society for Testing Materials.

9. The dry coke shall not exceed the following limits in chemical composition:

Volatile matter.....	not over	2.0 per cent.
Fixed carbon.....	not under	86.0 per cent.
Ash.....	not over	12.0 per cent.
Sulphur.....	not over	1.0 per cent.

II. REJECTION

10. (a) In case the original standard sample was taken in accordance with Section 5 and showed more than 3 per cent. moisture, the purchaser shall have the option of taking a special moisture sample according to Section 6, and of deducting the moisture found in excess of 3 per cent. from the weight of coke found on reweighing the car at the time the special moisture sample was taken.

(b) In case the original standard sample was taken with special regard to moisture in accordance with Section 6, the purchaser shall have the option of deducting the moisture in excess of 3 per cent. from the weight of coke, provided that the car was weighed at the time of sampling.

11. Coke which fails to conform to the limits of chemical composition given in Section 9 will be rejected, and the seller shall be notified within 5 working days from the date of sampling.

12. Reliability of Samples.—It is evident from the preceding paragraphs that it is possible to sample crushed coal with fair accuracy, but that it is not possible to sample accurately a single lot of coal containing large lumps without greater expense than is usually warranted. The error is largely an accidental one due to the inclusion or rejection of too many or too few of the larger pieces of slate in the sample. There may also be a systematic error if care has not been taken to get a proper proportion of coarse and fine coal. So far as the error is accidental, it will diminish, according to the law of probabilities, with increasing number of samples, so that although any one sample may be in error by 3 per cent., the average of fifty samples should be quite accurate. Contracts which involve the delivery of coal throughout the year may therefore be equitably settled on a sliding scale based on analysis, for the undue premium on one shipment will be counterbalanced by the undue penalty on another and in the course of a year a fair average will have been reached. If it is necessary to determine accurately the value of a single shipment, greater care and expense is necessary than the sum at issue will usually warrant.

CHAPTER XV

THE CHEMICAL ANALYSIS OF COAL

1. Introduction.—The methods used in analysis of coal may be grouped into two main divisions. In *ultimate analysis* the aim is to report as accurately as may be the percentages of the chemical elements, especially carbon, hydrogen, nitrogen, oxygen and sulphur. These elements are reported as elements without any attempt to indicate the manner in which they are combined in the coal. This method of analysis is scientifically valuable but finds few applications in technical work. In *proximate analysis*, on the other hand, the attempt is made to group the constituents of the coal according to certain physical properties which are technically important such as moisture, volatile matter and ash. This method of analysis is of great commercial importance. These two methods of analysis are applicable to all forms of solid and liquid fuel—peat, lignite, bituminous coal, anthracite, coke, petroleum, tar, etc.—with slight modifications required by the physical properties of the fuel being investigated.

2. Proximate Analysis.—The usual items included in a proximate analysis are moisture, volatile matter, fixed carbon and ash. Sulphur is frequently included in the report, but is determined separately. There is no difficulty in comprehending what is meant by the terms moisture and ash, although the actual determination of their quantities may be difficult. The expressions, volatile matter and fixed carbon, require explanation, for they are merely relative terms which can be interpreted only by reference to certain definite conditions of analysis. If coal be heated to redness the heat will decompose a portion of the coal substance. Part of this decomposed coal will be evolved as a thick black smoke which will burn in the air and part will remain behind as a solid coke or carbonaceous residue. If tar or petroleum be treated in this manner part of the substance will be driven off in the same form in which it existed in the oil. In the case of coal the material volatilized is formed only through

the decomposing action of the heat. In proximate analysis no attempt is made to separate these two classes of products. Everything which is evolved in the process is called "volatile." The residue remaining in the crucible after this process consists of ash and a material which is largely carbon and which forms the so-called "fixed carbon." The percentages reported as volatile matter and fixed carbon will vary with every modification of the conditions of analysis. The moisture and ash are also liable to vary with change in detail of method. It is therefore very important that all chemists should use the same method in order that their results may be comparable. The standard method is given in Section 18 of this chapter.

3. Preliminary Examination of Sample.—In the preceding chapter on Sampling the precautions to be observed in taking the initial sample and in subdividing it were discussed. There is no definite point where the sampler is to stop in his process of subdivision and turn the material over to the chemist, but since the sampler is in general a field worker it is customary to consider his work as ended when the sample has been reduced in weight sufficiently to allow its easy transportation to the laboratory. It is advisable that the sample sent to the laboratory should weigh from 3 to 5 lb.

The chemist receiving a sample should note the nature of the package as well as its marks. Coal shipped in a canvas sack or a paper carton which is not tight will almost certainly have changed in moisture content and will probably have lost some of its finer particles. After opening the package the net weight of sample and an approximate estimate of its physical condition should be recorded. Information as to whether the sample as received was wet or dry, and whether it showed evident pieces of slate or pyrite, is sometimes of importance. The size of the largest lumps relative to the size of the sample shipped will give some indication of the care which has been used in the preparation of the sample. The chemist should, for his own protection, state in his report when the sample is manifestly a non-representative one, and when insufficient care has been exercised in packing it for shipment.

4. Air-drying.—It is inconvenient to handle samples of coal which are wet, since they clog the mills and cannot be mixed

readily. They also change in weight rapidly in the air. It is therefore standard practice to air-dry the sample. This may be accomplished by spreading in a thin layer in a tin pan placed in a warm room for twenty-four hours or longer if necessary to bring it to approximately constant weight. The process may be hastened by placing the samples in an oven such as is used at the Bureau of Mines¹ which is heated to not over 100° F. and

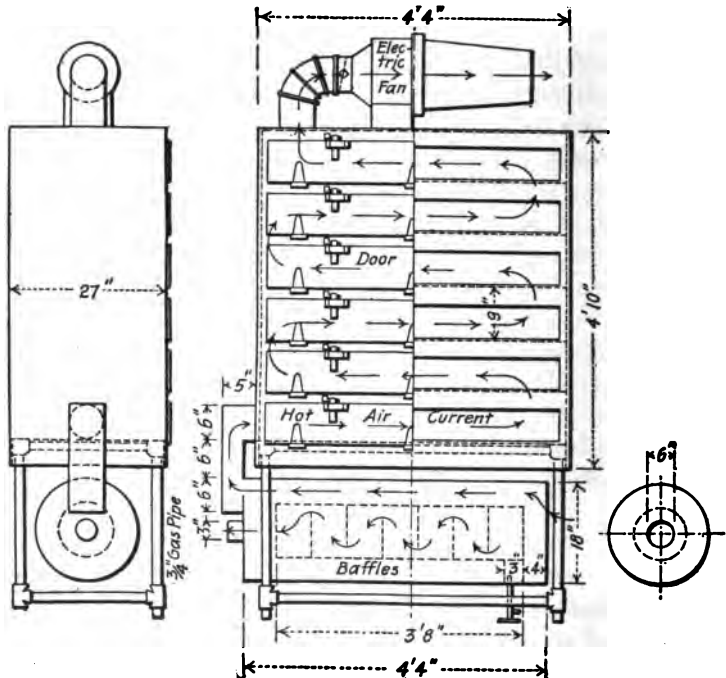

FIG. 48.—Oven for air-drying coal samples

which is provided with forced ventilation. In this oven, which is illustrated in Fig. 48, air is heated by a Bunsen burner and circulated by a small electric fan. The loss in weight during this process is reported as air-drying loss. All analyses are made on this air-dried coal since it may be weighed and handled in the air with relatively slight change of weight. There is evidence that the coal slowly changes in this air-drying process, so that it

¹ *Technical Paper 8, Bureau of Mines, 1912.*

should not be exposed to the air longer than necessary. Porter¹ reports that Pittsburg coal on drying eight days at 35° C. absorbed 0.17 per cent. of oxygen and that a Wyoming coal similarly treated absorbed 0.70 per cent.

5. Grinding and Preserving the Sample for Analysis.—The sample of coal which has been air-dried or is at least so nearly air-dry that it does not change in weight in the air rapidly is to be crushed and subdivided until a portion of 50 or 60 grm. is obtained from which a sample of 1 grm. may be taken which shall be representative of the whole original mass of coal. Bailey in the reference quoted in the preceding chapter gives the following rules for subdivision in the laboratory.

Size of coal mesh	Should not be divided to less than
2	8300 grm.
4	1100 grm.
8	120 grm.
10	55 grm.
20	3 grm.

He recommends that as soon as the sample has been put through an 8-mesh sieve that it be all crushed to 60-mesh or finer.

The crushing to 12-mesh may be done by hand in a mortar or in any type of crusher without much danger of injuring the sample if it is done rapidly. It is necessary to take precautions, however, to prevent injury to the sample during fine grinding, for finely ground coal absorbs oxygen from the air rapidly and gives off water. The exact nature of this reaction is not understood but it is known to affect the heating value appreciably. This change is accelerated if the sample becomes heated during the fine grinding. For this reason disc grinders should be used with great caution. They grind rapidly but the plates get hot, sometimes hot enough to start destructive distillation of the coal, which manifests itself by a tarry odor. If the disc grinder is used the plates must not be set closer than necessary and the coal must be fed very slowly. The best method of finely grinding coal is to use a jar mill. This consists of a heavy porcelain

¹ *Jour. Ind. and Eng. Chem.*, 5, 520 (1913).

jar provided with a cover which may be clamped tight on a rubber gasket. It is filled about one-third full of round flint pebbles or porcelain balls and is placed in a frame where it may be rotated at the rate of 50 to 75 revolutions per minute. The balls tumbling over each other fall with sufficient force to crack the small pieces of coal, but are themselves worn off to only a negligible extent. The longer the coal is left in the jar the finer it becomes and it is easy to get any desired degree of fineness. The size of the jar required and the diameter of the pebbles will vary with the hardness of the material and the size of the lumps. If the lumps have a diameter even as great as one-fourth that of the pebbles, some of the lumps may become simply rounded balls themselves and not be crushed by the impact of the pebbles. If the coal has been put through a 10- or 12-mesh sieve before going into the ball mill a jar of 8 in. internal diameter and with pebbles $\frac{3}{4}$ in. or 1 in. in diameter will grind the sample properly, provided the coal does not occupy over one-sixth of the volume of the jar. When the grinding is completed the jar is emptied onto a coarse sieve which retains the balls. The coal should be tested on a 60-mesh sieve and any portions failing to pass it should be separately ground to pass an 80-mesh sieve and added to the main portion. These coarse particles are likely to be slate or pyrites and therefore especial care must be taken to see that they are finely ground and mixed with the main sample. A coal ground to pass a 60-mesh sieve is fine enough to make a 1-gram. sample as representative of the lot as the various intermediate samples were of the initial sample. It is not desirable to grind the coal much finer because of the increased error due to loss of moisture and absorption of oxygen by the finely powdered coal.

This finely ground sample may now be stored as a whole in a fruit jar or subdivided and an amount of only 50 grm. placed in a wide-mouthed bottle closed with a rubber stopper. The bottle should be filled only half full so that the analyst before weighing out his sample may gently shake and rotate the bottle to mix the contents. Pyrites and slate tend to work to the bottom of a sample bottle and the precaution of mixing before taking a sample should never be omitted.

Even the most carefully preserved coals deteriorate in time.

Parr¹ has shown that in three years' storage in the laboratory Eastern coals lose in heating value to the extent of 0.5 to 1.5 per cent., while Illinois coals deteriorate to the extent of 3 to 5 per cent. Coals which are to be kept for a long period should be sealed as nearly air-tight as possible.

6. Moisture.—The determination of moisture in coals is complicated by the change which the coal substance itself undergoes when subjected to heat and exposure to the air. The standard method of analysis given in Section 18 prescribes that 1 gram of the coal shall be heated for one hour at a temperature of 104° to 110° C. in an oven through which a current of dried air is circulated.

The errors in the determination of moisture in coal have been studied by several investigators, among them Hillebrand and Badger² at the Bureau of Standards. They conclude that the most nearly correct results may be obtained by drying *in vacuo* over concentrated sulphuric acid for a period of two days or more. Results obtained by a method similar to that now adopted as a standard were quite consistent and in most cases approximated those obtained in a vacuum. Hulett³ proposes a method for determining the true moisture in coal by heating in a vacuum so controlled that water is removed from the coal as fast as liberated. At the decomposition temperature of the coal the curve shows a sharp break due to evolution of synthetic water and this point marks the true moisture value. The Hulett method gives results roughly 30 per cent. higher than the standard method. Further discussion of this same subject is found in the report of the Committee on Standardization of Methods presented to the Eighth International Congress of Applied Chemistry.⁴

The 1913 report of the Committee on Coal Analysis recommended that sub-bituminous and lignitic coals are to be dried in a stream of dry carbon dioxide or nitrogen. After the samples were dried they were to be placed in a vacuum desiccator which

¹ Eighth Internat. Congr. Appl. Chem., 10, 225 (1912).

² Eighth Internat. Congr. Appl. Chem., 10, 187 (1912).

³ Mack and Hulett, *Am. J. Sci.*, 43, 89 (1917).

Hulett, Mack, and Smyth, *Am. J. Sci.*, 45, 174 (1918).

⁴ 8th Int. Congr. Applied Chemistry, 25, 41 (1912).

was then exhausted to remove absorbed carbon dioxide. After exhaustion the desiccator was refilled with dry air.

7. Volatile Matter.—There can never be an absolute method for the determination of volatile matter, for only a very small proportion of the material evolved from coal at a red heat was present as such in the coal. Most of this volatile material is a decomposition product whose amount varies with the rate of heating, the maximum temperature attained, the character of the flame, the size of the crucible and other conditions. It is necessary, therefore, in a standard method to fix every possible variable as rigidly as possible.

The 1899 method of the American Chemical Society is as follows:

“Place 1 grm. of fresh, undried, powdered coal in a platinum crucible, weighing 20 or 30 grm. and having a tightly fitting cover. Heat over the full flame of a Bunsen burner for seven minutes. The crucible should be supported on a platinum triangle with the bottom six to eight centimeters above the top of the burner. The flame should be fully twenty centimeters high when burning free, and the determination should be made in a place free from draughts. The upper surface should remain covered with carbon. To find ‘Volatile Combustible Matter’ subtract the per cent. of moisture from the loss found here.”

More recent investigations especially by Fieldner and Davis¹ and by Parr² have thrown some light on the causes of variation. The former authors working in the laboratories of the U. S. Bureau of Mines at Pittsburgh and Washington found that the carburetted water gas of Washington gave a maximum temperature of 970° C. within the crucible which was 120° hotter than could be obtained with the coal gas of Pittsburgh or with natural gas burned under favorable conditions. They summarize the results of their experiments as follows:

“Two laboratories are likely to vary 2 per cent. in volatile matter, both using the official method (of 1899). The percentage of volatile matter obtained from the same sample of coal varies with the temperature and rate of heating. This is not sufficiently defined by height of flame. Temperatures ranging from 760° C. to 890° C. may be attained with a 20-cm. natural gas flame, when the gas pressure is varied

¹ *Jour. Ind. and Eng. Chem.*, 2, 304 (1910).

² *Jour. Ind. and Eng. Chem.*, 3, 900 (1911).

from 1 to 13 in. of water; variations of 2 per cent. volatile matter are thus produced. Differences in type and sizes of burner influence results from 0.3 to 1.5 per cent. Polished crucibles become hotter and yield about 1 per cent. more volatile matter than dull gray ones. Laboratories using natural gas are apt to get results on volatile matter that are considerably lower than those using coal gas, unless the following precautions are observed: (1) Gas should be supplied to the burner at a pressure of not less than 10 in. of water. (2) Natural gas burners admitting an ample supply of air should be used. (3) Gas and air should be regulated so that a flame with a short, well-defined inner cone is produced. (4) The crucibles should be supported on platinum triangles and kept in well-polished condition."

The 1913 report of the Committee on Coal Analysis recommends the following two alternate methods for the determination of volatile matter.

"It is recommended that for volatile matter determinations a 10-grm. platinum crucible be used having a capsule cover, that is, one which fits inside of the crucible and not on top. The crucible with 1 gm. of coal is placed in a muffle maintained at approximately 950° C. for seven minutes. With a muffle of the horizontal type, the crucible should not rest on the floor of the muffle but should be supported on a platinum or nichrome triangle bent into a tripod form. After the more rapid discharge of the volatile matter, well shown by the disappearance of the luminous flame, the cover should be tapped lightly to more perfectly seal the cover and thus guard against the admission of air.

"One gram of coal is placed in a platinum crucible of approximately 20 c.c. capacity (35 mm. in diameter at the top and 35 mm. high). The crucible should have a capsule cover which will readily adjust itself to the inside upper surface of the crucible. The crucible is placed in the flame of a Meker burner, size No. 4, having approximately an outside diameter at the top of 25 mm. and giving a flame not less than 15 cm. high. The temperature should be from 900° to 950° C. determined by placing a thermocouple through the perforated cover which for this purpose may be of nickel. The junction of the couple should be placed in contact with the center of the bottom of the crucible. Or the temperature may be indicated by the fusion of pure potassium chromate in the covered crucible (fusion of K_2CrO_4 , 940° C.). The crucible is placed in the flame about 1 cm. above the top of the burner and the heating is continued for seven minutes. After the main part of the gases has been discharged the cover should be tapped into place as above described.

"For lignites a preliminary heating of five minutes is carried out, during which time the flame of the burner is played upon the bottom of the crucible in such a manner as to bring about the discharge of volatile matter at a rate not sufficient to cause sparking. After the preliminary heating the crucible is placed in the full burner flame for seven minutes as above described."

The present standard method as given in Section 18 prescribes that the volatile matter shall be determined in a vertical electric tube furnace or a muffle furnace.

8. Ash.—The ash of coal is generally defined as the mineral residue remaining after complete combustion. The present standard method is given in Section 18. The 1899 method of the American Chemical Society is as follows:

"Burn the portion of powdered coal used for the determination of moisture, at first over a very low flame, with the crucible open and inclined, till free from carbon. If properly treated, this sample can be burned much more quickly than the dense carbon left from the determination of volatile matter. It is advisable to examine the ash for unburned carbon by moistening it with alcohol."

The errors attending the determination of ash have been studied very carefully by Parr,¹ who has shown that 90 per cent. of the Illinois coals carry as much as 0.2 per cent. of calcium carbonate, nearly half have more than 1 per cent., one-fifth have more than 2 per cent., a considerable number over 4 per cent., and a few isolated cases carry over 10 per cent. of calcium carbonate in the raw coal. Since decomposition of CaCO_3 is rapid at 900°C . and evident at 600° it is apparent that in coals of this type care must be taken to determine the actual amount of CaCO_3 present. Parr has also shown that sulphate in the form of ferrous or ferric sulphate is present in fresh coal in amounts varying from a few tenths up to 1 per cent. and that this amount increases rapidly in the finely ground portions of the laboratory sample. With coals high in lime this sulphate on ignition for ash probably becomes calcium sulphate, as does also the sulphur of pyrites.

The 1913 report of the Committee on Coal Analysis recommends the following method for the determination of ash.

¹ *Jour. Ind. and Eng. Chem.*, 5, 523 (1913). Ill. State Geological Survey, *Bul.* 16, p. 242.

“Unless the coal is of a type known to be free from carbonate the amount of carbon dioxide must be determined. A 5-grm. sample, recently boiled distilled water and dilute hydrochloric acid are employed, making use of any convenient apparatus for collecting, absorbing and measuring accurately the carbon dioxide discharged from the coal. It is most convenient to obtain the factor as in the form of carbon.

“One gram of coal, either freshly weighed or that which has been used for the moisture determination, is ignited in a shallow capsule or porcelain crucible by placing directly in a muffle maintained at a dull or cherry-red temperature between 700 and 750° C. and retained at this temperature for 20 or 30 minutes or until all of the carbon is burned out. The capsule is cooled in a desiccator and weighed. In the absence of a muffle the desired temperature may be obtained by placing the capsule at first just above the tip of a Bunsen flame turned down to about 2 or 3 in. in height. After the larger part of the carbon is burned off in this manner the flame is increased so that the tip comes well into contact with the bottom of the capsule.

“For coals having carbon dioxide present in an amount to exceed 0.2 per cent., the ash after cooling is moistened with a few drops of sulphuric acid (diluted 1 : 1) and again carefully brought up to 750° C. and retained at that temperature for three to five minutes. The capsule is cooled in a desiccator and weighed. Three times the equivalent of carbon present as carbon dioxide is subtracted from the ash as weighed in order to restore the weight of the calcium sulphate formed to the equivalent of calcium carbonate.”

The appearance of the ash gives some indication of its fusing point and hence its tendency to form clinkers. The largest constituents in ash are silica and alumina, all of whose compounds have relatively high melting-point and are white in color. Iron oxide colors ash red and reduces the melting-point of the alumina silica series markedly. Therefore a red ash indicates low melting-point and trouble with clinker while a white ash usually indicates high melting-point. This rule fails with coals such as those from Illinois which carry material amounts of lime, for the lime reduces the melting-point without giving a color. However, the Illinois coals usually carry enough iron to give a red color as well.

A long series of tests conducted by the Bureau of Mines has resulted in the development of a method for determining the fusibility of coal ash which has been adopted by the American

Society for Testing Materials.¹ In this method the finely ground and thoroughly oxidized ash is made into a plastic mass with dextrin and formed into cones. These cones are heated in a special furnace and in a reducing atmosphere until the softening point is reached. An analyst should check his own results within 30° C. and should check a different analyst within 50° C.

9. Fixed Carbon.—Fixed carbon is obtained by adding together the weights of moisture, volatile matter and ash and subtracting this sum from the weight of the initial sample. Since the amount of fixed carbon is obtained by difference, proximate analyses of coal always add up to an even 100 per cent. The percentage of fixed carbon plus ash gives a fair indication of the amount of coke which would be obtained from a coal. An indication of the quality of the coke may be obtained from an examination of the residue remaining after the determination of volatile matter. Good coking coals give a button of hard dense coke. Feebly coking coals give a cracked and weak button while non-coking anthracites and lignites give a powdery or granular residue.

10. Sulphur.—The estimation of sulphur is usually considered as part of a proximate analysis although it is estimated separately and its percentage is not included in the 100 per cent. formed by the sum of the moisture, volatile matter, fixed carbon and ash. Sulphur usually exists in coal as pyrites FeS_2 , but part of it may exist in combination with carbon compounds, part even as free sulphur and especially in weathered coals as calcium sulphate or sulphate of iron. No attempt is ordinarily made to distinguish between these various forms of sulphur, although Powell and Parr² have described methods for separating sulphate sulphur, pyrite sulphur, humus, and resinic sulphur. In the usual methods of analysis, the coal is treated with an agent which finally brings all forms of sulphur into a soluble sulphate form. This is then precipitated as barium sulphate and calculated back to sulphur. The method recommended in 1899 by the American Chemical Society was a modification of that proposed by Eschka in 1874.

¹ Fieldner, Hall and Field, *Bul.* 129, Bureau of Mines (1918).

Proc. Am. Soc. for Testing Mat., 1919, I, 756 (1919).

² *Bul. Am. Inst. Mining Met. Eng.*, 1919, 2041.

The committee on Coal Analysis in its report made in 1913 adopts the report presented by Barker¹ permitting the use of three alternative methods which have shown themselves to be accurate. The methods are:

- (a) the Eschka method.
- (b) the Atkinson method of fusion with sodium carbonate.
- (c) the method of fusion with sodium peroxide

The Eschka method is recommended in substantially the same form as in the standard method of 1899. The substitution of copper oxide for magnesium oxide in the method gives more rapid combustion but it has been objected to on the ground that the black specks of copper oxide look so much like free carbon that it is difficult to tell when the coal is completely burned. Details of the Eschka method are given in Section 18.

The Peroxide Fusion Method.—The decomposition of coal by fusion with sodium peroxide was first proposed by Parr² for calorimetric purposes. The reaction was adapted to the estimation of sulphur by Sundstrom³ and later modified by Pennock and Morton,⁴ and Parr.⁵ The method is entirely reliable and is much more rapid than the Eschka method.

When a mixture of a dry combustible substance and sodium peroxide in proper proportions is ignited by a hot iron wire, the mass fuses with very little spattering and the sulphur, no matter what its initial form of combination, is converted to a soluble sodium sulphate. If the coal is damp or the proportions are not correct there may be violent spattering so the reaction should be carried out in a closed vessel. The residue from the determination of heating value in the Parr calorimeter is of course available at once for the estimation of sulphur. Where a separate combustion for sulphur is to be made a simple crucible of steel or brass provided with a perforated cover which may be clamped in place is used, as shown in Fig. 49. For a charge of 0.7 gm. bituminous coal about 16 gm. of sodium peroxide are required

¹ *Jour. Ind. and Eng. Chem.*, 5, 524 (1913).

² *J. Am. Chem. Soc.*, 22, 646 (1900).

³ *J. Am. Chem. Soc.*, 25, 184 (1903).

⁴ *J. Am. Chem. Soc.*, 25, 1265 (1903).

⁵ *J. Am. Chem. Soc.*, 30, 767 (1908).

while for the same weight of coke or anthracite about 12 grm. of peroxide are best. The charge is mixed, the cover clamped on and the crucible placed on a support in a pan of water, so that its lower half is immersed and yet there is free circulation of water around the bottom. The charge is fired by a stiff iron wire which is heated to redness and thrust through the hole in the cover. If the reaction proceeds properly almost no flame will issue from the hole. If the proportions are not correct there

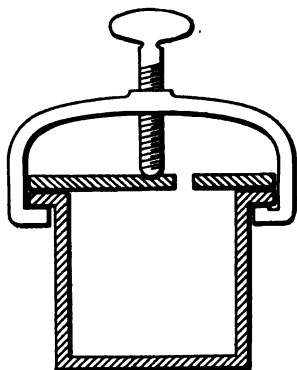

FIG. 49.—Crucible for peroxide fusion.

may be considerable spattering so that the operator should stand at arms length from the crucible when inserting the wire. If the first explosion is too violent, add more sodium peroxide which acts as a diluent. If, on the other hand, combustion has been incomplete as shown by soot on the inside of the lid of the crucible, decrease the amount of sodium peroxide on the next attempt. If there is difficulty in obtaining ignition as is sometimes the case with coke and especially with ashes, add an accelerator. Parr recommends the following

fusion mixture: 10 grm. sodium peroxide, 0.5 grm. potassium chlorate, 0.5 grm. benzoic acid.

To dissolve the fused mass, place the crucible and cover in about 200 c.c. of distilled water. Rinse off the crucible, acidify slightly with HCl, filter out any insoluble matter and proceed with precipitation of BaSO_4 as in the Eschka method.

The details of the Atkinson method as recommended by the Committee on Coal Analysis are as follows:

*The Atkinson Method.*¹—“Thoroughly mix on glazed paper 1 grm. of the laboratory sample of coal with 7 grm. of dry sodium carbonate and spread evenly over the bottom of a shallow platinum or porcelain dish. Place on a triangle slightly elevated above the bottom of a cold muffle. Raise the temperature of the muffle gradually until a temperature of 650° to 700° C. (dull red heat) has been obtained in half an hour and maintain this temperature for ten or fifteen minutes.

¹ *J. Am. Chem. Soc.*, 21, 1128 (1899).

The sodium carbonate should not sinter or fuse. The mixture should not be stirred during the heating process. When the dish has cooled sufficiently to handle, the matter should be examined for black particles of unburned carbon and in case such indications of incompleteness of the process appear, the dish should be replaced and heated for a short time. When all carbon is burned, remove the dish and digest the contents with 100 to 125 c.c. of warm water. Allow the insoluble matter to settle, decant through a filter and wash several times by decantation. Transfer to the filter, adding a few drops of a solution of pure sodium chloride, if the insoluble matter tends to pass through the filter. The washing should be continued until the filtrate shows no alkaline reaction. Make the filtrate slightly acid with sufficient concentrated hydrochloric acid and precipitate the sulphates with barium chloride as described under the Eschka method. No oxidizing agent is required."

Sulphur may also be determined in the water rinsed from the bomb calorimeter after a calorimetric determination, provided proper care is taken in the combustion. Regester¹ has shown that it is necessary to have a pressure of 20 atmospheres and a nitrogen content of 6 per cent. in the bomb before ignition to ensure oxidation of the SO_2 . This is discussed further in Chapter XVI. The sulphuric acid cannot be determined by direct titration since some nitric acid is also formed and some of the acid may have been neutralized by reaction with the metal of the bomb or with particles of ash which were spattered out during combustion. The bomb should be rinsed out very thoroughly with hot water. Even then, Regester shows that the results on sulphur are usually low by from 3 to 5 per cent.

Parr² has developed a rapid photometric method for the determination of sulphur in coal. The residue from the fusion with sodium peroxide is dissolved, acidified, diluted, and precipitated cold with a mixture of barium chloride and oxalic acid. The precipitated barium sulphate is in a very finely divided condition so that it does not settle readily. The photometer consists of a graduated tube of special design which rests upon a diaphragm below which is a candle flame. The emulsion of BaSO_4 and solution is slowly poured into this photometer until

¹ *Jour. Ind. and Eng. Chem.*, 6, 812 (1914).

² *Jour. Am. Chem. Soc.*, 26, 1139 (1904); *Jour. Ind. and Eng. Chem.*, 1, 689 (1909).

the sharp outline of the flame disappears. The height of solution in the photometer tube gives, by reference to a special table, the per cent. of sulphur in the coal. Results on 35 coals quoted by Parr show good agreement with gravimetric methods.

11. Ultimate Analysis.—Carbon and Hydrogen.—Carbon and hydrogen in coal and coke are determined as is usual in the ultimate analysis of organic compounds, by combustion in a stream of dry and pure oxygen and absorption of the resulting carbon dioxide and water. The analysis is a difficult one and should not be attempted by one who has not had practice in the general method. If it is necessary for an analyst without training in this particular line to undertake such an analysis he should practice on the ultimate analysis of such pure compounds as sugar and benzoic acid until he has attained proficiency. Detailed directions for these determinations in coal are given in Technical Paper 8 of the Bureau of Mines. The standard method is given in Section 18.

In a determination of the heating value of coal in a bomb calorimeter, there is complete oxidation of the carbon to carbon dioxide and of the hydrogen to water. An absorption train may be connected to the bomb and the gases allowed to bubble slowly through it. After the pressure in the bomb has fallen to that of the atmosphere the bomb may be immersed in a dish of hot water and suction applied to the absorption train. It is in this way possible to estimate the carbon dioxide and water formed in the combustion. Kroeker¹ proposes a bomb which has an inlet and an outlet valve so that dry and pure air may be passed through the bomb after the pressure has been relieved. The method is capable of giving good results in skilled hands. Great care must be taken to keep the packing on the oxygen valves in perfect condition as otherwise part of the products of combustion will escape during the slow process of emptying the bomb. There is also a minor error due to the oxidation of some of the nitrogen to form nitric acid which is reported as carbon dioxide.

Parr² has proposed a gas volumetric method of determining carbon from the residue of the peroxide fusion in the Parr calor-

¹ *Zeit. d. Vereins f. d. Rübenzuckerindustrie*, 46, 177 (1896).

² *University of Illinois Bulletin* Vol. 1, No. 20 (1904).

imeter. The residue consisting largely of Na_2CO_3 and Na_2O_2 is dissolved in water and treated with acid. Carbon dioxide and oxygen are evolved and the carbon dioxide is estimated by absorption. There are a number of minor sources of error which make it difficult to get accurate results by this method. Sodium peroxide both dry and in solution readily absorbs carbon dioxide from the air and care is necessary in order to keep the correction factors constant. Difficulty has also been experienced in completely boiling off the carbon dioxide from the solution.

12. Nitrogen.—The chief value attaching to a knowledge of the per cent. of nitrogen in a coal is the indication which it is believed to give of the amount of ammonia which the coal will yield on destructive distillation. No attempt is usually made to distinguish between the various forms in which nitrogen may exist in coal. The total nitrogen is best determined by the Kjehldahl method or one of its modifications as regularly used in the ultimate analysis of organic compounds. Details are given in Technical Paper 8 of the Bureau of Mines. The standard method is given in Section 18.

13. Phosphorus.—Phosphorus is usually determined only in fuels which are to be used for metallurgical processes where the fuel is to come in direct contact with the metal. The standard method of analysis is given in Section 18.

14. Oxygen.—There is no direct method for the estimation of oxygen in coal. In an ultimate analysis the percentages of carbon, hydrogen, nitrogen, sulphur and ash are added and the difference between this sum and 100 per cent. is called oxygen. It is thus apparent that any errors in the estimation of the other constituents are reflected in the figure for oxygen and that therefore this figure is to be regarded as the least significant of the analysis. A formula which makes correction for some of the errors is given in Section 18.

15. Methods of Reporting Analyses.—The analysis is usually made on the air-dried sample since the sample in this form is least liable to change. The original figures obtained by the analyst will therefore be for coal in this form. He may now take into account the moisture lost in air-drying and calculate the analysis to a basis of coal "as received," he may mathematically eliminate all the water and report as "Coal free from Mois-

ture," or he may by calculation eliminate both the moisture and ash and report as "Coal free from Moisture and Ash."

Numerous attempts have been made to calculate "true coal"¹ or "coal substance" by elimination, in addition to the moisture and ash, of water of hydration contained in shale, and carbon dioxide contained in carbonates of the ash—both of which are driven off in whole or in part with the volatile matter whereas they really belong to the ash. Such corrections are difficult to apply and are not often made in technical work. In any event the data reported should be sufficient to allow a recalculation of the results to any other basis. Ordinarily the air-drying loss and analysis of air-dried coal are reported since they are the figures actually obtained by the analyst and in addition whatever other forms of report may be called for. The following analysis of a Pittsburg coal shows the form of report.

PERCENTAGE COMPOSITION OF COAL

Proximate analysis	Air-dried	As received	Calculated moisture-free	Calculated moisture and ash-free
Moisture.....	1.07	3.94
Volatile matter.....	34.55	33.55	34.93	37.13
Fixed carbon.....	58.51	56.81	59.14	62.87
Ash.....	5.87	5.70	5.93	
	100.00	100.00	100.00	100.00
Ultimate analysis				
Hydrogen.....	5.16	5.33	5.09	5.41
Carbon.....	79.52	77.21	80.38	85.44
Nitrogen.....	1.41	1.37	1.43	1.52
Oxygen.....	6.97	9.35	6.09	6.48
Sulphur.....	1.07	1.07	1.08	1.15
Ash.....	5.87	5.70	5.93	
	100.00	100.00	100.00	100.00
Air-drying loss.....	2.90

16. Accuracy of Results.—It will be evident from a consideration of this chapter and the preceding one on sampling that the

¹ See The Chemical Examination of Water, Fuel, Flue Gases and Lubricants, by S. W. Parr.

error in sampling is likely to be larger than the error of analysis. The Joint Committee on Coal Analysis in its 1913 report estimates the allowable variations under its methods of analysis as follows:

	Same analyst, per cent.	Different analysts, per cent.
Moisture, under 5 per cent.	0.2	0.3
Moisture, over 5 per cent.	0.3	0.5
Volatile matter, bituminous coals.	0.5	1.0
Volatile matter, lignites.	1.0	2.0
Ash, no carbonates present.	0.2	0.3
Ash, carbonates present.	0.3	0.5
Ash, more than 12 per cent.	0.5	1.0
Sulphur, in coal.	0.05	0.1
Sulphur, in coke.	0.03	0.05

The greatest variation is in the volatile matter and when a contract is to be awarded in which an accurate determination of volatile matter is demanded, it is advisable for the purchaser and the bidder to jointly analyze a single sample of coal and harmonize their differences in analytical procedure before the contract is awarded. Lord,¹ from his wide experience, states that in ultimate analysis the accuracy can be safely stated as within 0.05 per cent. in the case of hydrogen, perhaps 0.3 per cent. on carbon, 0.03 per cent. on nitrogen and 0.05 per cent. on sulphur. Davis and Fairchild² have mathematically investigated the probable errors in coal analysis using the method of least squares and concluded: "It would seem, then, that the limits allowed by the committee on coal analysis of the American Society for Testing Materials are not limits outside which, with ordinary care, determinations could never fall; it would seem rather that the committee means to designate limits within which a large percentage of the errors will fall."

17. Slate and Pyrites.—It is frequently desirable to determine how much of the pyrites and slate is in a form which will permit mechanical separation by coal-washing or otherwise. Lord³

¹ *Jour. Ind. and Eng. Chem.*, 1, 307 (1909).

² Technical Paper 171, Bureau of Mines, 1918

³ *Jour. Ind. and Eng. Chem.*, 1, 308 (1909).

recommends the use of calcium chloride solutions with which a specific gravity as high as 1.35 may be obtained or zinc chloride solutions with which a specific gravity of 2.0 may be reached. The coal is tested by crushing to various degrees of fineness and determining the differences in composition of the portion which floats and that which sinks in solutions of varying specific gravities.

18. Standard Methods for the Laboratory Sampling and Analysis of Coal.—In 1899 a committee of the American Chemical Society¹ which had made a careful study of the subject reported a scheme of analysis which was very generally adopted. In 1910 a joint committee of the American Chemical Society and the American Society for Testing Materials was appointed to revise these methods. The committee made its preliminary report in 1913² and its final report in 1915. Its methods as finally approved by the Society for Testing Materials³ are given below:

PREPARATION OF LABORATORY SAMPLES

Apparatus.—*Air-drying Oven.*—The oven is to be used for air-drying wet samples and may be of the form shown in Fig. 50. This is not absolutely necessary but is economical where many wet samples are received.

Galvanized-iron Pans 18 by 18 by 1.5 In. Deep.—For air-drying wet samples.

Balance or Solution Scale.—For weighing the galvanized-iron pans with samples. It should have a capacity of 5 kg. and be sensitive to 0.5 g.

Jaw Crusher.—For crushing coarse samples to pass a 4-mesh sieve.

Roll Crusher or Coffee-mill Type of Grinder.—For reducing the 4-mesh product to 20-mesh. The coffee-mill type of grinder should be entirely enclosed and have an enclosed hopper and a receptacle capable of holding 10 lb. of coal. This is to reduce the moisture losses while crushing.

Abbe Ball Mill, Planetary Disk Crusher, Chrome-steel Bucking Board, or Any Satisfactory Form of Pulverizer.—For reducing the 20-mesh product to 60-mesh. The porcelain jars for the ball mill should be approximately 9 in. in diameter and 10 in. high. The flint pebbles should be smooth, hard and well rounded.

¹ *Jour. Am. Chem. Soc.*, 21, 1116 (1899).

² *Jour. Ind. and Eng. Chem.*, 5, 517 (1913).

³ A. S. T. M. Standards for 1918, p. 679.

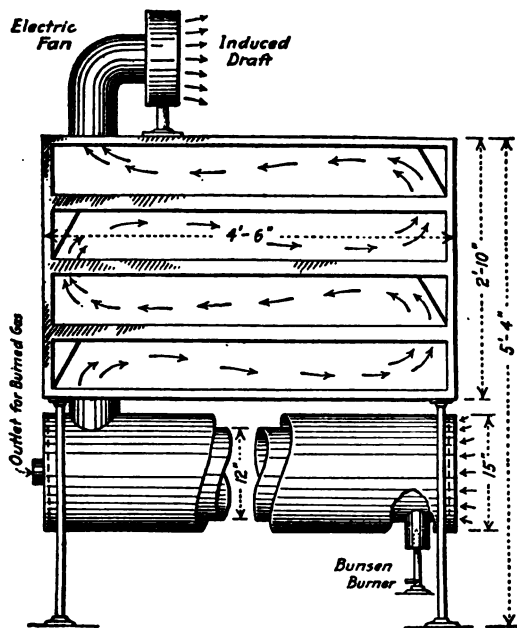

FIG. 50.—Air-drying oven.

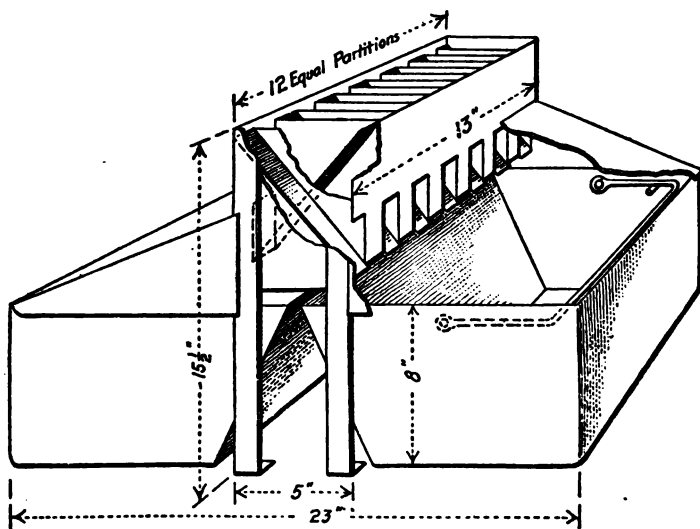

FIG. 51.—Riffle sampler.

A Large Rifle Sampler, with $\frac{1}{2}$ or $\frac{3}{8}$ In. Divisions.—For reducing the 4-mesh sample to 10 lb. (Fig. 51).

A Small Rifle Sampler, with $\frac{1}{4}$ or $\frac{3}{8}$ In. Divisions.—For dividing down the 20 and 60 mesh material to a laboratory sample (Fig. 51).

An 8-in. 60-mesh sieve with cover and receiver.

Containers for Shipment to Laboratory.—Samples in which the moisture content is important should always be shipped in moisture-tight containers. A galvanized-iron or tin can with a screw top which is sealed with a rubber gasket and adhesive tape is best adapted to this purpose. Glass fruit jars sealed with rubber gaskets may be used, but require very careful packing to avoid breakage in transit. Samples in which the moisture content is of no importance need no special protection from loss of moisture.

METHOD OF SAMPLING

(A) When Coal Appears Dry.—If the sample is coarser than 4-mesh (0.20 in.) and larger in amount than 10 lb., quickly crush it with the jaw crusher to pass a 4-mesh sieve and reduce it on the larger rifle sampler to 10 lb.; then crush at once to 20-mesh by passing through rolls or an enclosed grinder, and take, without sieving, a 60-g. total moisture sample, immediately after the material has passed through the crushing apparatus. This sample should be taken with a spoon from various parts of the 20-mesh product, and should be placed directly in a rubber-stoppered bottle.

Thoroughly mix the main portion of the sample, reduce on the small rifle sampler to about 120 g., and pulverize to 60-mesh by any suitable apparatus without regard to loss of moisture. After all the material has been passed through the 60-mesh sieve, mix and divide it on the small rifle sampler to 60 g. Transfer the final sample to a 4-oz. rubber stoppered bottle. Determine moisture in both the 60- and 20-mesh samples by the method given under moisture.

Computation.—Compute the analysis of the 60-mesh coal, which has become partly air-dried during sampling, to the dry-coal basis, by dividing each result by 1 minus its content of moisture. Compute the analysis of the coal "as received" from the dry-coal analysis by multiplying by 1 minus the total moisture found in the 20-mesh sample.

(B) When Coal Appears Wet.—Spread the sample on tared pans, weigh, and air-dry at room temperature, or in the special drying oven, shown in Fig. 50, at 10 to 15° C. above room temperature, and weigh again. The drying should be continued until the loss in weight is not more than 0.1 per cent. per hour. Complete the sampling as under dry coal.

Computation.—Correct the moisture found in the 20-mesh air-dried sample to total moisture “as received,” as follows:

$$\frac{100 - \text{percentage of air-drying loss}}{100} \times (\text{percentage of moisture in 20-mesh coal})$$

plus (percentage of air-drying loss) = (total moisture “as received”)

Compute the analysis to “dry-coal” and “as received” bases as under dry coal, using for the “as received” computation the total moisture as found by the formula in place of the moisture found in the 20-mesh coal.

Notes.—Freshly mined or wet coal loses moisture rapidly on exposure to the air of the laboratory, hence the sampling operations between opening the container and taking the 20-mesh total moisture sample must be conducted with the utmost dispatch and with minimum exposure to air.

The accuracy of the method of preparing laboratory samples should be checked frequently by resampling the rejected portions and preparing a duplicate sample. The ash in the two samples should not differ more than the following limits:

No carbonates present.....	0.4 per cent.
Considerable carbonate and pyrite present.....	0.7 per cent.
Coals with more than 12 per cent. ash, containing considerable carbonate and pyrite.....	1.0 per cent.

DETERMINATION OF MOISTURE

Apparatus.—*Moisture Oven.*—This must be so constructed as to have a uniform temperature in all parts and a minimum of air space. It may be of the form shown in Fig. 52.¹ Provision must be made for renewing the air in the oven at the rate of two to four times a minute, with the air dried by passing it through concentrated H₂SO₄.

Capsules with Covers.—A convenient form, which allows the ash determination to be made on the same sample, is the porcelain capsule No. 2, $\frac{1}{8}$ in. deep and $1\frac{1}{4}$ in. in diameter; or a fused silica capsule of similar shape. This is to be used with a well-fitting flat aluminum cover, illustrated in Fig. 53.

Glass capsules with ground-glass caps may also be used. They should be as shallow as possible, consistent with convenient handling.

Method.—(A) **Sixty-mesh Sample.**—Heat the empty capsules under the conditions at which the coal is to be dried, stopper or cover, cool over concentrated H₂SO₄, sp. gr. 1.84 for 30 minutes and weigh.

¹ Technical Paper No. 76, Bureau of Mines.

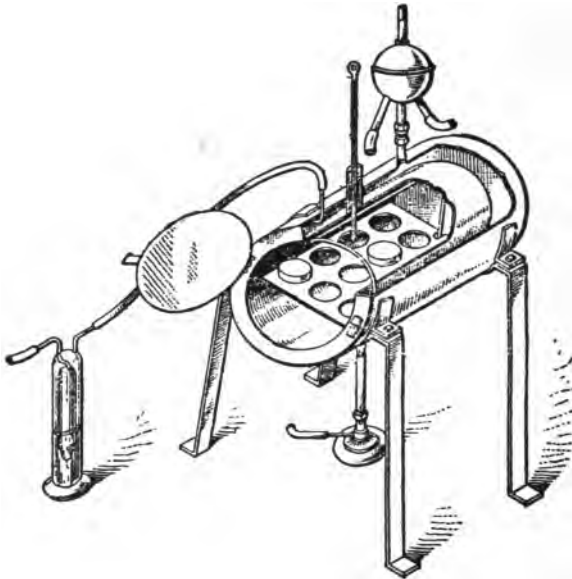

FIG. 52.—Moisture oven for coal, to contain toluene or glycerine and water

Dip out with a spoon or spatula from the sample bottle approximately 1 g. of coal; put this quickly into the capsule, close and weigh at once.

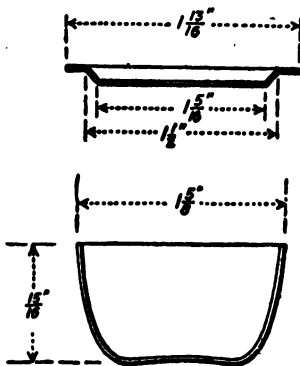

FIG. 53.—Porcelain capsule with flat aluminium cover.

An alternative procedure (more open to error), after transferring an amount slightly in excess of 1 g., is to bring to exactly 1 g. in weight (± 0.5 mg.) by quickly removing the excess weight of coal with a spatula. The utmost dispatch must be used in order to minimize the exposure of the coal until the weight is found.

After removing the covers, quickly place the capsules in a pre-heated oven (at 104 to 110° C.) through which passes a current of air dried by concentrated H_2SO_4 . Close the oven at once and heat for 1 hour. Then open the oven, cover the capsules quickly and place them in

a desiccator over concentrated H_2SO_4 . When cool, weigh.

(B) Twenty-mesh Sample.—Use 5-g. samples, weighed with an

accuracy of 2 mg., and heat for 1½ hours; the procedure is otherwise the same as with the 60-mesh sample. Methods of greater accuracy for the determination of moisture are given in the preliminary report.

The permissible differences in duplicate determinations are as follows:

	Same analyst, per cent.	Different analysts, per cent.
Moisture under 5 per cent.	0.2	0.3
Moisture over 5 per cent.	0.3	0.5

DETERMINATION OF ASH

Apparatus.—*Gas or Electric Muffle Furnace.*—The muffle should have good air circulation and be capable of having its temperature regulated between 700 and 750° C.

Porcelain Capsules.—Porcelain capsules No. 2, ⅜ in. deep and 1¾ in. in diameter, or similar shallow dishes.

Method.—Place the porcelain capsules containing the dried coal from the moisture determination in a cold muffle furnace, or on the hearth at a low temperature, and gradually heat to redness at such a rate as to avoid mechanical loss from too rapid expulsion of volatile matter. Finish the ignition to constant weight (± 0.001 g.) at a temperature between 700 and 750° C. Cool in a desiccator, and weigh as soon as cold.

The permissible differences in duplicate determinations are as follows:

	Same analyst, per cent.	Different analysts, per cent.
No carbonates present.	0.2	0.3
Carbonates present.	0.3	0.5
Coals with more than 12 per cent. of ash, containing carbonates and pyrite.	0.5	1.0

Notes.—Before replacing the capsules in the muffle for ignition to constant weight, the ash should be stirred with a platinum or nichrome wire. Stirring once or twice before the first weighing hastens complete ignition.

The result obtained by this method is “uncorrected” ash. For “corrected” ash see the preliminary report as quoted on p. 230. The actual mineral matters in the original coal are usually very different in weight and composition from the weight of the “uncorrected” ash.

DETERMINATION OF VOLATILE MATTER

Apparatus.—*Platinum Crucible with Tightly Fitting Cover.*—The crucible should be of not less than 10 nor more than 20-c.c. capacity; of

not less than 25 nor more than 35 mm. in diameter; of not less than 30 nor more than 35 mm. in height.

Vertical Electric Tube Furnace; or a Gas or Electrically Heated Muffle Furnace.—The furnace may be of the form as shown in Fig. 54. It is

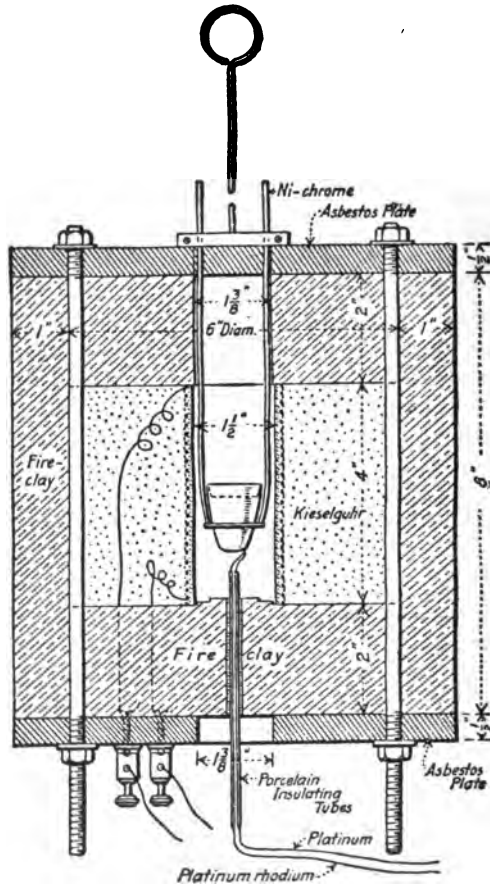

FIG. 54.—Electric tube furnace for determining volatile matter in coal.

to be regulated to maintain a temperature of $950^{\circ}\text{C.} (\pm 20^{\circ}\text{C.})$ in the crucible, as shown by a thermocouple kept in the furnace. A suitable form of electric furnace is shown in Fig. 54. If the determination of volatile matter is not an essential feature of the specifications under which the coal is bought, a Meker burner may be used.

Method.—Weigh 1 g. of the coal in a weighed 10 to 20-c.c. platinum crucible, close with a capsule cover, and place on platinum or nichrome-wire supports in the furnace chamber, which must be at a temperature of 950° C. ($\pm 20^\circ$ C.). After the more rapid discharge of volatile matter has subsided, as shown by the disappearance of the luminous flame, tap the cover lightly to more perfectly seal the crucible and thus guard against the admission of air. After heating exactly 7 minutes, remove the crucible from the furnace and, without disturbing the cover, allow it to cool. Weigh as soon as cold. The loss of weight minus moisture equals the volatile matter.

Modification for Sub-bituminous Coal, Lignite, and Peat.—Mechanical losses are incurred on suddenly heating peat, sub-bituminous coal, and lignite; therefore they must be subjected to a preliminary gradual heating for 5 minutes; this is best done by playing the flame of a burner upon the bottom of the crucible in such a manner as to bring about the discharge of volatile matter at a rate not sufficient to cause sparking. After the preliminary heating, transfer the crucible to the volatile-matter furnace and heat for 6 minutes at 950° C. as in the regular method.

The permissible differences in duplicate determinations are as follows:

	Same analyst, per cent.	Different analysts, per cent.
Bituminous coals.....	0.5	1.0
Lignites.....	1.0	2.0

Notes.—The cover should fit closely enough so that the carbon deposit from bituminous and lignite coals does not burn away from the under side.

Regulation of temperature to within the prescribed limits is important.

DETERMINATION OF FIXED CARBON

Compute fixed carbon as follows:

100 — (moisture plus ash plus volatile matter) equals percentage of fixed carbon.

DETERMINATION OF SULPHUR BY THE ESCHKA METHOD

Apparatus.—*Gas or Electric Muffle Furnace, or Burners.*—For igniting coal with the Eschka mixture and for igniting the BaSO₄.

Porcelain, Silica, or Platinum Crucibles or Capsules.—For igniting coal with the Eschka mixture.

No. 1 porcelain capsule, 1 in. deep and 2 in. in diameter. This capsule, because of its shallow form, presents more surface for

oxidation and is more convenient to handle than the ordinary form of crucible.

No. 1 porcelain crucibles, shallow form, and platinum crucibles of similar size may be used. Somewhat more time is required to burn out the coal, owing to the deeper form, than with the shallow capsules described above.

No. 0 or 00 porcelain crucibles, or platinum, alundum or silica crucibles of similar size are to be used for igniting the BaSO_4 .

Solutions and Reagents.—*Barium Chloride.*—Dissolve 100 g. of $\text{BaCl}_2 \cdot 2\text{H}_2\text{O}$ in 1000 c.c. of distilled water.

Saturated Bromine Water.—Add an excess of bromine to 1000 c.c. of distilled water.

Eschka Mixture.—Thoroughly mix 2 parts (by weight) of light calcined MgO and 1 part of anhydrous Na_2CO_3 . Both materials should be as free as possible from sulphur.

Methyl Orange.—Dissolve 0.02 g. in 100 c.c. of hot distilled water and filter.

Hydrochloric Acid.—Mix 500 c.c. of HCl , sp. gr. 1.20, and 500 c.c. of distilled water.

Normal Hydrochloric Acid.—Dilute 80 c.c. of HCl , sp. gr. 1.20, to 1 liter with distilled water.

Sodium Carbonate.—A saturated solution, approximately 60 g. of crystallized or 22 g. of anhydrous Na_2CO_3 in 100 c.c. of distilled water.

Sodium-hydroxide Solution.—Dissolve 100 g. in 1 liter of distilled water. This solution may be used in place of the Na_2CO_3 solution.

Method.—*Preparation of Sample and Mixture.*—Thoroughly mix on glazed paper 1 g. of coal and 3 g. of Eschka mixture. Transfer to a No. 1 porcelain capsule, 1 in. deep and 2 in. in diameter, or a No. 1 crucible or a platinum crucible of similar size, and cover with about 1 g. of Eschka mixture.

Ignition.—On account of the amount of sulphur contained in artificial gas, the crucible shall be heated over an alcohol, gasoline or natural gas flame as in procedure (a) below, or in a gas or electrically heated muffle, as in procedure (b) below. The use of artificial gas for heating the coal and Eschka mixture is permissible only when the crucibles are heated in a muffle.

(a) Heat the crucible, placed in a slanting position on a triangle, over a very low flame to avoid rapid expulsion of the volatile matter, which tends to prevent complete absorption of the products of combustion of sulphur. Heat the crucible slowly for 30 minutes, gradually increasing the temperature and stirring after all black particles have disappeared, which is an indication of the completeness of the procedure.

(b) Place the crucible in a cold muffle and gradually raise the temperature to 870–925° C. (cherry-red heat) in about 1 hour. Maintain the maximum temperature for about 1½ hours and then allow the crucible to cool in the muffle.

Subsequent Treatment.—Remove and empty the contents into a 200-c.c. beaker and digest with 100 c.c. of hot water for ½ to ¾ hour, with occasional stirring. Filter and wash the insoluble matter by decantation. After several washings in this manner, transfer the insoluble matter to the filter and wash 5 times, keeping the mixture well agitated. Treat the filtrate amounting to about 250 c.c., with 10 to 20 c.c. of saturated bromine water, make slightly acid with HCl and boil to expel the liberated bromine. Make just neutral to methyl orange with NaOH or Na₂CO₃ solution, then add 1 c.c. of normal HCl. Boil again and add slowly from a pipette, with constant stirring, 10 c.c. of a 10 per cent. solution of BaCl₂·2H₂O. Continue boiling for 15 minutes and allow to stand for at least 2 hours, or preferably over night, at a temperature just below boiling. Filter through an ashless filter paper and wash with hot distilled water until a AgNO₃ solution shows no precipitate with a drop of the filtrate. Place the wet filter containing the precipitate of BaSO₄ in a weighed platinum, porcelain, silica or alundum crucible, allowing a free access of air by folding the paper over the precipitate loosely to prevent spattering. Smoke the paper off gradually and at no time allow it to burn with a flame. After the paper is practically consumed, raise the temperature to approximately 925° C. and heat to constant weight.

The residue of MgO, etc., after leaching, should be dissolved in HCl and tested with great care for sulphur. When an appreciable amount is found this should be determined quantitatively. The amount of sulphur retained is by no means a negligible quantity.

Blanks and Corrections.—In all cases a correction must be applied either (1) by running a blank exactly as described above, using the same amount of all reagents that were employed in the regular determination, or more surely (2) by determining a known amount of sulphate added to a solution of the reagents after these have been put through the prescribed series of operations. If this latter procedure is adopted and carried out, say, once a week or whenever a new supply of a reagent must be used, and for a series of solutions covering the range of sulphur content likely to be met with in coals, it is only necessary to add to or subtract deficiency or excess may have been found in the appropriate “check” in order to obtain a result that is more certain to be correct than if a “blank” correction as determined by the former procedure is applied. This is due to the fact that the solubility error

for BaSO_4 , for the amounts of sulphur in question and the conditions of precipitation prescribed, is probably the largest one to be considered. BaSO_4 is soluble in acids and even in pure water, and the solubility limit is reached almost immediately on contact with the solvent. Hence, in the event of using reagents of very superior quality or of exercising more than ordinary precautions, there may be no apparent "blank," because the solubility limit of the solution for BaSO_4 has not been reached or at any rate not exceeded.

As shown in the preliminary report, the Atkinson and sodium-peroxide methods give results in close agreement with the Eschka method. Regester has shown that if 5 per cent. of nitrogen is present in the gases contained in the bomb calorimeter the sulphur of a coal is almost completely oxidized to H_2SO_4 and the washings of the calorimeter may be used for the determination of sulphur.

The permissible differences in duplicate determinations are as follows:

	Same analyst, per cent.	Different analysts, per cent.
Sulphur under 2 per cent.....	0.05	0.10
Sulphur over 2 per cent.....	0.10	0.20

DETERMINATION OF PHOSPHORUS IN ASH

Method No. 1. To Cover All Cases.—To the ash from 5 g. of coal in a platinum capsule is added 10 c.c. of HNO_3 and 3 to 5 c.c. of HF . The liquid is evaporated and the residue fused with 3 g. of Na_2CO_3 . If unburned carbon is present 0.2 g. of NaNO_3 is mixed with carbonate. The melt is leached with water and the solution filtered. The residue is ignited, fused with Na_2CO_3 alone, the melt leached and the solution filtered. The combined filtrates, held in a flask, are just acidified with HNO_3 and concentrated to a volume of 100 c.c. To the solution, brought to a temperature of 85°C ., is added 50 c.c. of molybdate solution and the flask is shaken for 10 minutes. If the precipitate does not form promptly and subside rapidly, add enough NH_4NO_3 to cause it to do so. The precipitate is washed six times, or until free from acid, with a 2-per-cent. solution of KNO_3 , then returned to the flask and titrated with standard NaOH solution. The alkali solution may well be made equal to 0.00025 g. phosphorus per cubic centimeter, or 0.005 per cent. for a 5-g. sample of coal, and is 0.995 of one-fifth normal. Or the phosphorus in the precipitate is determined by reduction and titration of the molybdenum with permanganate.

Note on Method 1.—The advantage of the use of HF in the initial attack of the ash lies in the resulting removal of silica. Fusion with

alkali carbonate is necessary for the elimination of titanium, which if present and not removed will contaminate the phospho-molybdate and is said to sometimes retard its precipitation.

Method No. 2.—When titanium is so low as to offer no objection, the ash is decomposed as under method No. 1, but evaporation is carried only to a volume of about 5 c.c. The solution is diluted with water to 30 c.c., boiled and filtered. If the washings are turbid they are passed again through the filter. The residue is ignited in a platinum crucible fused with a little Na_2CO_3 , the melt dissolved in HNO_3 and its solution, if clear, added to the main one. If not clear it is filtered. The subsequent procedure is as under method No. 1. The fusion of the residue may be dispensed with in routine work on a given coal if it is certain that it is free from phosphorus.

ULTIMATE ANALYSIS

Carbon and Hydrogen.—The determination of carbon and of hydrogen is made with a weighed quantity of sample in a 25-burner combustion furnace of the Glaser type. The products of combustion are thoroughly oxidized by being passed over red-hot CuO and PbCrO_4 , and are fixed by absorbing the water in a weighed Marchand tube filled with granular CaCl_2 and by absorbing the CO_2 in a Liebig bulb containing a 30 per cent. solution of KOH .

The apparatus used consists of a purifying train, in duplicate, a combustion tube in the furnace, and an absorption train. The purifying train consists of the following purifying reagents arranged in order of passage of air and oxygen through them: H_2SO_4 , KOH solution, soda lime, and granular CaCl_2 . One of the trains is for air and one for oxygen. In the H_2SO_4 and KOH scrubbing bottles the air and the oxygen are made to bubble through about 5 mm. of the purifying reagent. Both purifying trains are connected to the combustion tube by a Y-tube, the joint being made tight by a rubber stopper.

The combustion tube is made of hard Jena glass. Its external diameter is about 21 mm., and its total length is 1 meter. The first 30 cm. of the tube are empty; following this empty space is an asbestos plug (acid-washed and ignited), or in its place a roll of oxidized copper gauze may be used; the next 40 cm. are filled with "wire" CuO ; a second asbestos plug separates the copper oxide from 10 cm. of fused PbCrO_4 , which is held in place by another asbestos plug 20 cm. from the end of the tube. The end of the tube is drawn out for rubber-tubing connection with the absorption train.

The absorption train consists, first, of a Marchand tube filled with granular CaCl_2 to absorb moisture. The CaCl_2 should be saturated

with CO_2 before using. The Marchand tube is followed by a Liebig bulb containing a 30 per cent. KOH solution, in which any possible impurities, as ferrous iron or nitrites, have been oxidized by a little KMnO_4 . A guard tube containing granular CaCl_2 and soda lime, is attached to the Liebig bulb to absorb any CO_2 escaping the KOH solution and any water evaporating from that solution.

The train is connected to an aspirator which draws the products of combustion through the entire train. A guard tube of CaCl_2 prevents moisture from running back into the absorption train. The suction is maintained constant by a Mariotte flask. The advantage of aspirating the gases through the train rather than forcing them through by pressure is that the pressure on the rubber connections is from the outside, so that gas-tight connections are more easily maintained than if the pressure is on the inside of the tube. The connections are made as tight as possible. The usual test for tightness is to start aspiration at the rate of about three bubbles of air per second through the potash bulb, and then to close the inlet for air and oxygen at the opposite end of the train; if there is no more than one bubble per minute in the potash bulb, the apparatus is considered tight.

Before starting a determination when the train has been idle some hours, or after any changes in chemicals or connections, a blank is run by aspirating about 1 liter of air through the train which is heated in the same manner as if a determination on coal were being made. If the Liebig bulb and the tube containing calcium chloride show a change in weight of less than 0.5 mg. each, the apparatus is in proper condition for use.

A porcelain or platinum boat is provided with a glass weighing tube of suitable size, which is fitted with an accurately ground glass stopper. The tube and empty boat are weighed. Approximately 0.2 g. of the air-dry coal (60-mesh and finer, or better 100-mesh if much free impurity is present) are quickly placed in the boat. The boat is at once placed in the weighing tube, which is quickly stoppered to prevent moisture change in the coal while weighing, and transferring to the furnace. The absorption tubes are connected and the boat and sample are transferred from the weighing tube to the combustion tube, which should be cool for the first 30 cm. The CuO should be red hot and the PbCrO_4 at a dull-red heat. The transfer of the boat from weighing tube to combustion tube should be made as rapidly as possible. As soon as the boat is in place near the asbestos plug at the beginning of the copper oxide the stopper connecting with the purifying train is inserted and the aspiration started with pure oxygen gas at the rate of three bubbles per second. One burner is turned on about 10 cm. back

from the boat, and the aspiration is continued carefully until practically all the moisture is expelled from the sample. The heat is then increased very gradually until all the volatile matter has been driven off. In driving off the volatile matter the heat must be applied gradually in order to prevent a too rapid evolution of gas and tar, which may either escape complete combustion or may be driven back into the purifying train. The heat should be slowly increased by turning on more burners under the open part of the tube until the sample is ignited; then the temperature can be increased rapidly, but care should be taken not to melt the combustion tube. Any moisture collecting in the end of the combustion tube or in the rubber connection joining it to the CaCl_2 tube is driven over into the CaCl_2 tube by carefully warming with a piece of hot tile. The aspiration with oxygen is continued for 2 minutes after the sample ceases to glow, the heat is then turned off and about 1200 c.c. of air are aspirated. The absorption bulbs are then disconnected, wiped with a clean cloth, and allowed to cool to the balance-room temperature before weighing.

$$\text{Percentage of hydrogen} = \frac{11.19 \times (\text{increase in weight of } \text{CaCl}_2 \text{ tube})}{\text{Weight of sample}}$$

$$\text{Percentage of carbon} = \frac{27.27 \times (\text{increase in weight of KOH bulb})}{\text{Weight of sample}}$$

The ash in the boat is weighed and carefully inspected for any unburned carbon, which would destroy the value of the determination.

Method with Electrically Heated Combustion Furnace.—An electrically heated combustion furnace of the Heraeus type is used by the Bureau of mines. It consists of three independent heaters, two of which are provided with sheave wheels, and are mounted on a track so that they are movable along the tube; the third heater which surrounds the PbCrO_4 , is stationary. The furnace as provided by the manufacturer does not include the small stationary heater. This can be made in the laboratory by winding an alundum tube 12 cm. in length with No. 20 nichrome II wire and enclosing it in a cylinder packed with magnesia asbestos. The movable heaters have very thin platinum foil, weighing about 9 g. in all, wound on a porcelain tube of 30 mm. internal diameter. The larger one which heats the CuO , is 350 mm. in length, and the smaller one, which heats the sample in the boat, is 200 mm. in length. The Jena glass or fused silica combustion tube, about 21 mm. external diameter and 900 mm. in length, is supported by an asbestos-lined nickel trough. The current through each heater is regulated independently by separate rheostats, mounted on the frame of the furnace. The two platinum-wound heaters require an average current

of about 4.5 amperes at a pressure of 220 volts, although for heating rapidly a larger amperage is necessary.

The oxygen or air entering the combustion tube is purified by passing through a Tauber's drying apparatus, which contains the following reagents arranged in order of the passage of air or oxygen through them: H_2SO_4 , for removing possible traces of ammonia, 30 per cent. KOH solution, granular soda lime, and granular CaCl_2 . One side of the train is connected directly to a Linde oxygen tank, which is provided with a reducing valve for regulating the oxygen pressure; the other side of the train is used for purifying the air supply.

The absorption train consists of a 5-in. U-tube, filled with granular CaCl_2 to absorb moisture. Before using, the CaCl_2 should be saturated with CO_2 to avoid possible absorption of CO_2 during a determination by any traces of CaO that may be present. This saturating is done most conveniently by placing a quantity of CaCl_2 in a large drying jar, and filling the jar with CO_2 . After standing over night, dry air is drawn through the jar to remove the CO_2 . The treated CaCl_2 is kept in well-stoppered bottles.

The CaCl_2 tube is connected to a Vanier potash bulb containing a 30 per cent. KOH solution and granular CaCl_2 . Six to eight determinations can be made without recharging this bulb. The potash bulb is connected to an aspirator through a guard tube containing granular CaCl_2 and soda lime, and a guard tube containing granular CaCl_2 and soda lime and a Mariotte flask. The Mariotte flask keeps the pressure constant.

In general, the method of determination is the same as the one used with the gas furnace. By moving the heaters toward the end of the tube where the gases enter, and cutting in the electric current, the air can be warmed enough to thoroughly dry the tube and its contents. The current is then cut off from the small heater, and the large heater is moved over the CuO; about 250 mm. of that part of the combustion tube between the two heaters where the boat containing the sample to be placed is kept exposed. The full current is then turned on the large heater to bring the CuO to a red heat. When this temperature is reached it is necessary to reduce the current with the rheostat to avoid melting the tube. In the meantime the absorption train is weighed and connected, and the boat containing the sample is placed in the exposed and cooler part of the tube between the two heaters.

The current is then passed through the shorter heater. By manipulating the rheostat and by gradually pushing this heater toward the boat, the rate of evaporation of moisture and evolution of volatile matter can be readily controlled.

After combustion is complete, the electric current is turned off the smaller heater and this heater moved back to allow the tube to cool for the next determination. The final aspiration of air and the weighing of the absorption train is conducted as described under the gas-furnace method.

Note.—In place of granulated CaCl_2 , concentrated H_2SO_4 , may be used for collecting the water formed by combustion. In such cases the air and oxygen entering the combustion tube and the gas leaving the potash bulb must also be dried by H_2SO_4 .

Other suitable forms of absorption vessels than those indicated in the above procedure may be used.

NITROGEN

The Kjeldahl-Gunning method is recommended for the determination of nitrogen. This method has the advantage over either the simple Kjeldahl or the Gunning method, in requiring less time for the complete oxidation of the organic matter, and in giving the most uniform results.

The Kjeldahl-Gunning Method.—One gram of the coal sample is boiled with 30 c.c. of concentrated H_2SO_4 , 7 to 10 g. of K_2SO_4 , and 0.6 to 0.8 g. of metallic mercury in a 500 c.c. Kjeldahl flask until all particles of coal are oxidized and the solution nearly colorless. The boiling should be continued at least 2 hours after the solution has reached the straw-colored stage. The total time of digestion will be from 3 to 4 hours. The addition of a few crystals of KMnO_4 after the solution has cooled enough to avoid violent reaction, tends to insure complete oxidation.

After cooling, the solution is diluted to about 200 c.c. with cold water. If the dilution with water has warmed the solution, it should be cooled again and the following reagents added: 25 c.c. K_2S solution (40 g. K_2S per liter) to precipitate the mercury; 1 to 2 g. of granular zinc to prevent bumping; and finally enough strong NaOH solution (usually 80 to 100 c.c.) to make the solution distinctly alkaline. The danger of loss of NH_3 may be minimized by holding the flask in an inclined position while the NaOH solution is being added. The alkaline solution runs down the side of the flask in an inclined position while the NaOH solution is being added. The alkaline solution runs down the side of the flask and forms a layer below the lighter acid solution. After adding the alkaline solution, the flask is at once connected to the condensing apparatus and the solution mixed by gently shaking the flask.

The NH_3 is distilled over into a measured amount (10 c.c.) of standard H_2SO_4 solution, to which has been added sufficient cochineal indicator for titration. Care should be taken that the glass connecting tube on the end of the condenser dips under the surface of the standard

acid. The solution is slowly distilled until 150 to 200 c.c. of distillate has passed over. To avoid mechanically entrained alkali passing over into the condenser, the rate of distillation should not exceed 100 c.c. per hour. The distillate is titrated with standard NH_3 solution (20 c.c. NH_4OH solution = 10 c.c. H_2SO_4 solution = 0.05 g. nitrogen). Standard NaOH or KOH solution with methyl orange or methyl red as indicator may be used instead of NH_3 and cochineal.

A blank determination should be made in exactly the same manner as described above, except that 1 g. of pure sucrose (cane sugar) is substituted in place of the coal sample. The nitrogen found in this blank determination is deducted from the result obtained with the coal sample.

The K_2S and NaOH may be dissolved in a single stock solution. Sufficient K_2S is dissolved in the water before adding the NaOH to make a solution in which the quantity necessary for a nitrogen determination (80 to 100 c.c.) contains 1 g. of K_2S . Twelve grams of K_2S and 500 g. of NaOH in one liter of water are required for the above proportions.

Coke and anthracite should be ground to an impalpable powder as they are very difficult to oxidize. Even if this is done the digestion may require 12 to 16 hours.

OXYGEN

There being no satisfactory direct method of determining oxygen, it is computed by subtracting the sum of the percentages of hydrogen, carbon, nitrogen, sulphur, water and ash from 100. The result so obtained is affected by all the errors incurred in the other determinations and especially by the change in weight of the ash-forming constituents on ignition; iron pyrite changes to ferric oxide, increasing the ash and causing a negative error in the oxygen equivalent to three-eighths of the pyritic sulphur. On the other hand, there is always a loss on ignition, of water of composition from the clayey and shaley constituents, CO_2 from carbonates, etc., which tends to compensate the absorption of oxygen.

Corrected Oxygen.—When a more correct oxygen value is desired, it may be obtained by making the corrections indicated in the following formula:

$$\text{Corrected oxygen} = 100 - [(\text{C} - \text{C}') \text{ plus } (\text{H} - \text{H}') \text{ plus N plus } \text{H}_2\text{O plus S}' \text{ plus corrected ash.}]$$

in which

C equals total carbon

C' equals carbon of carbonates

H equals total hydrogen less hydrogen of water

H' equals hydrogen from water of composition in clay, shale, etc.

N equals nitrogen

H₂O equals moisture as found at 105° C.

S' equals sulphur not present as pyrite or sulphate. This is usually small. In many types of coal it may be disregarded.

CORRECTED ASH

Corrected ash equals mineral constituents originally present in the coal. For most purposes this can be determined with sufficient accuracy by adding to the ash, as found, five-eighths of the weight of pyritic sulphur, the CO₂ of carbonates and the water of composition of clay, shale, etc. See also Determination of Ash.

19. Standard Methods for Laboratory Sampling and Analysis of Coke.¹—The American Society for Testing Materials has issued a standard method for sampling and analysis of coke which in general follows the lines laid down for coal. Coke is so very abrasive that especial care must be taken not to increase the ash of the sample during crushing. The samples may be coarsely crushed with a jaw or roll crusher or by hand on a chilled iron or hard-steel plate by impact of a hard bar or sledge, avoiding all rubbing action. The use of rubbing surfaces such as a disk pulverizer or a bucking board is never permissible for grinding coke. The final grinding to 60 mesh may be made in a porcelain jar mill. No special care is needed in determining moisture which may be done in an ordinary oven at 104–110° C. The other methods follow those for coal quite closely.

The American Society for Testing Materials Standards 1918, p. 709.

CHAPTER XVI

HEATING VALUE OF COAL BY THE BOMB CALORIMETER

1. General Methods of Determining Heating Value.—The heating value of a fuel is determined either directly in a calorimeter or indirectly by calculation from its chemical composition. The direct calorimetric method involves the combustion of the fuel by oxygen supplied either as free oxygen gas or as combined oxygen of some chemical compound, the operation being carried out in a closed vessel immersed in a known mass of water under conditions which ensure that the heat evolved in the oxidation shall be with as little loss as possible transferred to and retained by the calorimetric vessel and the water. —The heat evolved is calculated from the rise in temperature of the system. —

Modern methods of calorimetry really commenced with the invention by Berthelot of his bomb calorimeter described in 1881.¹ This has become the standard method for the determination of heating values and therefore the whole of this chapter is devoted to it. Other methods, especially that of Parr, are described in the following chapter.

2. The Calorimetric Bomb.—Berthelot showed that if combustion of carbon compounds took place in a closed vessel in an atmosphere of oxygen compressed to at least seven atmospheres and with a weight of combustible such that only 30 to 40 per cent. of the oxygen initially present was consumed, combustion was rapid and complete. His bomb was lined with heavy platinum and was very expensive. Hempel in the second edition of his gas analysis published in 1889 described a much cheaper bomb which had no lining and which has been found to be mechanically unsatisfactory. Mahler² in 1892 reported a careful study of Berthelot's method as applied to coals, and described

¹ *Annales de Chimie*, 5 Serie, 23, 160 (1881). *Annales de Chimie*, 6 Serie, 6, 546 (1885).

² *Bul. de la Societe d. Encouragement*, 1892, 319.

a bomb of improved construction with an enamel instead of a platinum lining. This bomb is mechanically better than Hempel's, but there is still the objection that the top as it screws down, roughens the gasket. Atwater¹ in 1894 described a modification of the calorimetric bomb distinctly superior mechanically to the preceding forms. It resembled more closely the Berthelot bomb than either of the others but, whereas the Berthelot bomb was closed by a tapered plug held in place by a screwed cap, Atwater's was closed by a flat cap held in place by a collar slipped over it and screwed over threads on the outside of the bomb after the manner of a union pipe-fitting. In this way all tearing of the gasket was avoided. The Atwater bomb may be provided with a gold or platinum lining. Many modifications of the calorimetric bomb have been made by other workers, but the principle has not been changed. Anyone familiar with one instrument can readily learn to use any other.

3. Details of the Calorimetric Bomb.—The calorimetric bomb which has been in use in the calorimeter laboratory of the University of Michigan since 1908 is shown in Figs. 55 and 56. It is in general patterned after the Atwater bomb, but possesses several improvements. One of these, due to Mr. Edwin H. Cheney, is the octagonal belt on the body of the bomb which fits into a recessed plate and holds the bomb rigidly while the cover is being screwed on. Another, due to Professor S. W. Parr, is the deeply recessed groove for the gasket in the cover of the bomb into which the straight lip of the bomb fits closely so that a rubber gasket may safely be used. Improvements in various details are due to Mr. J. H. Stevenson, instrument maker of the University of Michigan. Details of the bomb are shown in Fig. 55. It consists of a cylinder of about 300 c.c. capacity on which sits a cover carrying the oxygen inlet and needle valve. The original models were made of steel and some of them have withstood continuous use by classes of beginners for ten years. They become coated with a layer of dense adherent scale on the inside and after that show very little change. One of these bombs was cut into sections after ten year's use and showed no measurable decrease in thickness of the metal due to corrosion.

¹ *Storrs Conn. Experiment Station Report*, 1894, 135; also *J. Am. Chem. Soc.*, 25, 659 (1903).

Monel metal was soon substituted for steel as the material from which the heads were made to avoid corrosion of the needle valve, and within the last few years the entire bomb, except the collar, has been made of monel metal. It stays bright both inside and out with no especial care, and the small amount of metal dissolved by the acids formed in combustion introduces only a negligible error in the calorimetric work. Compressed oxygen is admitted through a flexible metal tube soldered at A

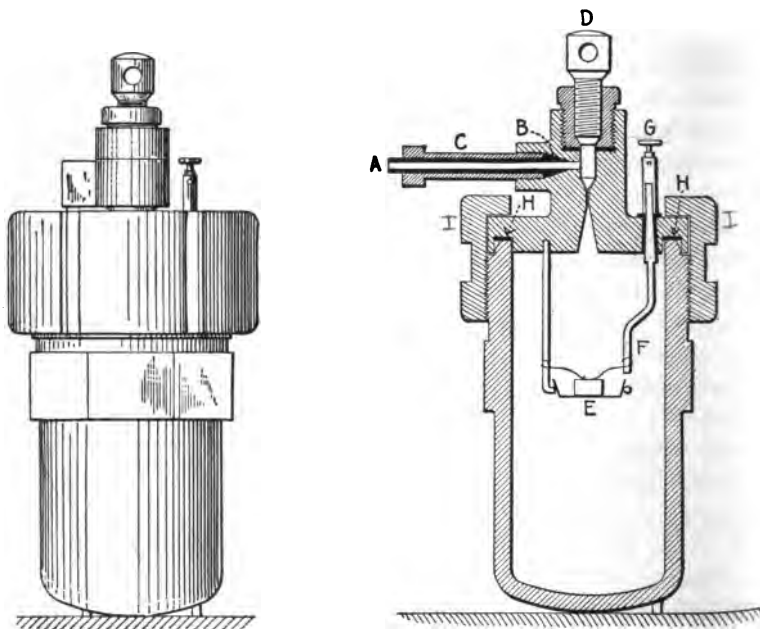

FIG. 55.—Details of calorimetric bomb.

to the steel tube with the coned head B. This tube AB slides freely in the threaded sleeve C. Its coned head makes a gas tight joint with the bomb when C is screwed up. The needle valve D closes the bomb when it is screwed down. The coal sits in a flat nickel or quartz capsule E supported on a ring which screws into the head piece. The insulated electrical connection FG is a rod coned where it passes through the head piece from which it is insulated by a bit of thin rubber tubing. The binding post G screwing down on the threaded end of F which projects

through the cover pulls the cone tightly into its seat and makes a gas tight joint. A mica disc placed between the binding post and the bomb completes the electrical insulation of the electrode from the bomb. The gasket which fits into the groove H may be of lead, hard fiber or rubber. Rubber gives a tight joint with the least pressure of the spanner and is therefore to be preferred. If it is cut to fit the groove accurately the inner lip of the bomb projecting into the recessed head will effectually protect it from the hot gases evolved in the bomb during combustion.

Fig. 56 shows the various parts of the calorimeter. Two bombs are shown, one assembled and one taken apart and with

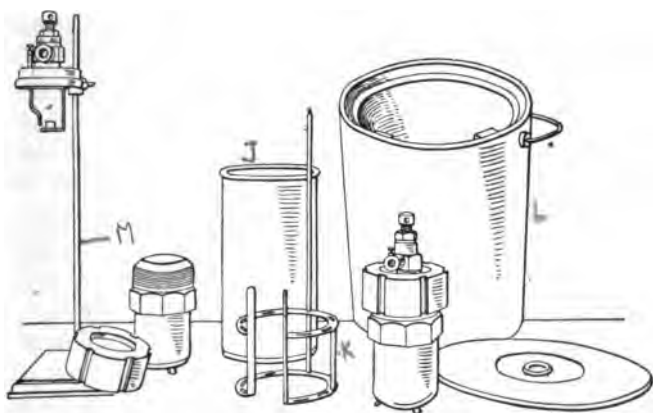

FIG. 56.—Bomb calorimeter.

the head sitting on a stand in position for adjustment of the fine iron firing wires. The nickel-plated copper can, the stirrer and the insulating buckets are also shown.

The insulating buckets as shown in Fig. 56 consist of two concentric fiber pails with air in the space between them. It is in some ways preferable to have this space filled with water, whose temperature may be set at any desired point. This minimizes the effect of draughts in the room and enables the operator to use a Beckman thermometer without having to shift its zero when the room temperature fluctuates. The temperature of the water must not, however, be so far below room temperature

that dew will deposit on the walls of the calorimeter vessel. When a water jacket is thus used in the calorimeter, it should be provided with a stirrer and its temperature should be recorded. Where a large number of calorimetric determinations are to be made in a laboratory the multiple unit installation designed by the Bureau of Mines¹ may profitably be installed.

4. Thermometers.—Thermometers for the calorimeters should be made especially for the purpose with a stem long enough to allow the bulb of the thermometer to be opposite the center of the bomb and should be carefully calibrated. It is necessary that it be possible to read the rise in temperature to at least 0.01° C. The best thermometers are those of the Beckman type with a scale length of 6° and a zero point adjustable between 12° and 25° . This type of thermometer is always to be recommended where the calorimeter room is of relatively constant temperature so that it is not necessary to change the zero point often. Where this desirable condition is not fulfilled calorimetric thermometers with a fixed scale running from 15° to 30° C. must be used. These are usually divided only into 0.02° to avoid the excessive length of stem which would otherwise result. The thermometer should in any case have been carefully calibrated since an error of 0.01° on the average rise of 3° means 0.3 per cent. or approximately 40 B.t.u. per pound of coal.

5. Preparation of Sample.—The methods to be followed in obtaining a representative sample from a large quantity of coal and the precautions necessary in grinding, sampling, and drying this large sample have been given in Chapters XIV and XV. It is assumed here that the sample is already ground to a fineness of at least 60-mesh and has been air-dried. The amount of moisture is immaterial so far as the operation of the bomb calorimeter is concerned, but an air-dried sample is less likely to change during the operation of weighing.

When powdered bituminous coal is burned in compressed oxygen, combustion is so violent that there is danger that gas and even solid particles will be projected unburned through the flame zone. The rate of combustion may be materially lessened by reducing the surface of coal exposed to the oxygen. This is best accomplished by briquetting the coal. Most bituminous coals

¹ David and Wallace, Technical Paper 91, Bureau of Mines (1918).

may be readily compressed into pellets in a screw press. The pressure should be slowly applied and allowed to remain for a few minutes. The resulting pellet may be trimmed to approximate weight with a penknife. It is advantageous to break it into two or more pieces and discard the dust before weighing. The advantage of cutting the pellet lies in the readier ignition, for pellets which have been pressed very hard are sometimes so dense on the surface that they fail to ignite. It is possible to compress some bituminous coals so firmly on the surface that the gas evolved in the interior of the briquette by destructive distillation explodes the briquette and blows a cap of coke out of the crucible. If these dense briquettes are cut into several pieces, as directed above, the trouble will be obviated. It is not necessary to briquet anthracite coals or coke. Indeed, it is not possible to do so without the addition of a binder such as sugar or bituminous coal.

6. Manipulation of Bomb Calorimeter.—The bomb is taken apart and examined to see that it is in good condition and that the gasket is not cut. A few drops of water are placed in the bottom part of the bomb which is set in its receptacle in the table-top. The top part of the bomb is placed on a ring of an ordinary ring stand as shown in Fig. 56 which allows the heavy terminals to drop through in a convenient position for adjustment of the fuse wire and sample. The weighed sample of coal is placed on a shallow thin quartz, nickel or platinum capsule resting on the supporting ring suspended from the head of the bomb. The capsule must be almost flat to allow free access of oxygen from the edges as the flame flares up. Otherwise combustion may be incomplete. It must be thin or it will chill the flame and prevent complete combustion. It is advisable with anthracite and coke to place a thin pad of ignited asbestos on the metallic capsule in order to decrease still further the cooling effect of the metal.

A measured length, preferably not more than two inches, of the fine iron ignition wire 34 B. & S. gage is attached to the heavy wire terminals by winding the ends of the fine wire several times around the heavy ones, leaving the fine wire in the form of a loop between the terminals. After making connections the loop is pushed down until it rests on the fragments of coal. Care

is to be taken that the wire does not touch the metal capsule and form a short circuit.

The cover with the sample in position is placed carefully on the bomb and the threaded collar slipped over it and screwed down, pressure finally being applied with the spanner. A novice will nearly always screw the cover down harder than necessary, thus shortening the life of the gasket. A moderate pressure will suffice if the gasket is a good one. Gaskets cut from ordinary red fiber packing are too porous to be tight unless screwed down with great pressure. They may be much improved by vacuum impregnation with a solution of 5 grm. of glue in 5 c.c. of glycerine and 100 c.c. of water. After impregnation the gaskets are to be dried in air and rubbed with paraffine or graphite to keep them from sticking to the metal.

The loose joint on the end of the flexible metal tube from the oxygen tank is screwed into the head of the bomb, the needle valve of the bomb opened at least a full turn, and then the valve on the oxygen tank is opened slightly, the gas entering in a slow stream from the tank until the gage shows 20 atmospheres pressure. If the valve on the tank is opened relatively more than the one on the bomb the gage between the two may show 20 atmospheres before there is that much pressure in the bomb. The oxygen valve on the tank is to be closed first and after that the valve on the bomb. If the valve on the bomb is closed before that on the tank, the pressure on the gage will rise very quickly to the full pressure of the oxygen tank which may be 2000 lb. and the gage may be blown up.

The bomb is disconnected and placed in the water of the calorimeter or in a separate vessel of water to test for leaks. If bubbles of gas appear around the threaded ring the cover must be screwed down more tightly, and possibly the gasket may have to be replaced. If bubbles of air come from the head it is evident that the needle valve is leaking. It is worse than useless to try and force it to become tight by screwing down the needle with great pressure. A needle valve ground truly into its seat is tight with slight pressure. If a particle of grit comes between the metal surfaces the application of pressure causes it to scour the polished surface and the valve will leak until it has been again ground to a true surface. In case of a leaking needle valve

the pressure must be relieved, the bomb opened and the needle valve unscrewed entirely out of the head. The lock nut into which it was threaded is also to be removed. The coned seat into which the needle valve is ground may now be seen in a strong light. The best policy is to grind the needle valve into its seat, an operation requiring not more than ten minutes if the valve has not been abused. The needle valve is dipped into a paste of fine emery or carborundum in water and ground into its seat by rotating it back and forth with the fingers. A polished ring will soon be visible on the cone point and a corresponding ring in the seat. When this appears, unless the metal has been badly scratched, the process may be considered complete and the grinding interrupted. The valve is to be thoroughly cleaned from grit and dried, when it is ready for use.

The bomb when charged is to be carefully centered in the calorimeter vessel which is in turn centered in the outer vessels. The stirrer and thermometer are placed in position and two liters of water whose temperature is approximately 3° below room temperature is added. A glass flask which holds 1000 c.c. of water, contains the following weights of water, when balanced against brass weights in air.¹

15° C.....	998.05 gm.
20° C.....	997.18 gm.
25° C.....	996.04 gm.
30° C.....	994.66 gm.

The liter flasks of various makers differ in the amount of water which they discharge and the flask should be calibrated by direct weight for some one temperature. It is more convenient for calculation purposes to calibrate the flask to deliver 2000 gm. of water at the temperature most frequently used or sometimes to deliver such an amount of water that the sum of the water added and the water value of the calorimeter shall be 2500 gm. It is in many ways better to weigh the water directly into the counterpoised calorimeter vessel as it sits on the balance.

Especial care is to be taken to see that the thermometer is centered in the space between the bomb and the edge of the

¹ Bureau of Standards Bull. 4, 600 (1907-08)

vessel. If it touches either, or even if it is a little off center, the rise of the thermometer will not be even and the result may be in error.

After the adjustments are complete the stirrer is operated for at least two minutes before the first temperature reading is made on an even minute. Readings are to be made each minute thereafter for at least five minutes, the stirrer being kept going steadily at 30-40 strokes per minute and the temperature slowly and steadily rising with each reading as heat is absorbed from the air of the room, or dropping if the calorimeter is above room temperature. This ends the preliminary period, which must show at least five readings changing by regular increments due solely to heat transfer to or from the outside air.

The firing circuit is closed simultaneously with the last reading of the preliminary period. The iron wire becomes heated to redness, the coal ignites and the iron wire fuses almost instantly. It is well to have an electric lamp in the firing circuit which lights when the current is turned on and is extinguished when the wire fuses. An ammeter in the circuit answers the same purpose showing that the ignition is prompt and that an undue amount of heat is not imparted to the calorimeter by the electric current. Current for ignition may best come from a storage battery or group of dry cells giving about 12 volts. Higher voltages are apt to cause insulation troubles.

Within a half minute after ignition the thermometer begins to rise so rapidly that it is not possible to make the thermometer readings accurately. They should be taken as accurately as possible, and regularly on each minute. After about three minutes the thermometer reaches its maximum, but the stirring and temperature readings must be kept up without intermission for a total of ten minutes after ignition to obtain data for the radiation corrections.

After the termination of the thermometer readings the bomb is removed from the calorimeter, wiped dry, and placed in its receptacle on the table. The needle valve is opened and after the pressure is relieved the top is removed. The coal should be perfectly burned and the ash should appear as fused beads. The iron wire has burned as far as the heavy conductors and in accurate work the length of the wire unburned should be deter-

mined to enable the proper correction to be made for the weight of wire burned. The weight of wire burned comes to be almost a constant for each operator and may be taken as such in ordinary work. If soot appears in the bomb or on the capsule, the determination should at once be rejected. With inexperienced operators this trouble is frequently caused by opening the valve on the oxygen tank too fast when filling the bomb, with the result that the gage on the connecting tube jumps to the proper reading before the indicated pressure is reached in the bomb. If trouble persists it may be necessary to increase the oxygen pressure to 25 atmospheres. The bomb is to be rinsed out carefully and unless it is to be used again at once, is to be dried best in an oven at a temperature of about 35–40° C. Careful drying is especially necessary unless non-corrodible alloys are used throughout the construction of the bomb.

7. Thermometer Corrections.—The calorimetric thermometer should have the certificate of the Bureau of Standards. In addition to the corrections indicated on the certificate as inherent in the thermometer on account of variation in the diameter of the capillary tube, etc., minor corrections must be made in accurate work for variations due to the conditions under which the thermometer is used. The Bureau of Standards calibrates thermometers when totally immersed in a bath of the temperature indicated. In calorimetric work the bulb and part of the stem is within the calorimeter, while part of the stem projects through the cover of the calorimeter into the air of the room. A small correction must be made for this emergent stem. In the case of Beckmann thermometers an additional "setting factor correction" must be used in case the thermometer is set for a different zero from that used in the calibration. The formulæ for these corrections vary with different sorts of glass and are given in full in the certificate of calibration accompanying each thermometer. The corrections rarely amount to more than a few thousandths of a degree.

8. Radiation Corrections.—The combustion of the coal in a bomb calorimeter is probably a matter of only a few seconds, but it requires several minutes for the heat to be transmitted to the water and for the thermometer to register the rise in temperature. With the usual type of instrument radiation corrections must

be made in spite of careful jacketing of the calorimeter. Their magnitude is lessened by adjusting the temperature of the water placed in the calorimeter with reference to room temperature and to the rise in temperature expected. If the rise in temperature is to be 3° , the water poured into the calorimeter should be about 3° below room temperature. When equilibrium is reached at the time of ignition the temperature will be about 2.5° below that of the room and after combustion it will be about 0.5° above room temperature. This arrangement minimizes the errors. The temperature rises very rapidly after ignition to one so nearly that of the room that changes due to radiation are slight and repeated readings may be made to obtain the final temperature. If the final temperature of the calorimeter is slightly above that of the room there should be a maximum point in the thermometer readings with a slow decrease thereafter.

It is common practice to consider that the actual maximum thermometer readings represent the actual maximum temperature of the calorimeter, but it is not a safe assumption, for if the thermometer bulb is unduly close to the bomb or if the stirring is inefficient the thermometer may rise too high and fall rapidly again to the temperature representing the true average value of the system, after which it will change slowly and regularly through radiation. It is, therefore, unsafe to use the maximum temperature in calculations. The final temperature of the combustion period should be taken only after sufficient time has elapsed so that it is certain that the system has come to equilibrium. Five minutes is usually sufficient.

Radiation corrections are based on the principle that the interchange of heat between the room and the calorimeter is proportional to the difference in the temperature between them. The temperature of the room is assumed to be a constant during any one operation and need not even be known. The formula for the correction as used by Regnault and developed by Pfaundler¹ is somewhat complicated in appearance, but is simple in use.

Regnault-Pfaundler Formula.—Three sets of temperature readings are to be made. The initial set must not start until after the temperature of the calorimeter has commenced to change regularly due to radiation. It consists of at least five readings

¹ *Poggendorf's Annalen*, 129, 115 (1866).

made one minute apart. Only the first and last readings and the time interval enter into the calculation, but it is advisable to record the intermediate readings as a check on the accuracy of the two important ones and to make sure that the change of temperature is uniform as it should be. At the moment of taking the final reading of the initial period the firing key is pressed and the reading just taken is recorded, both as the final reading of the initial period and the first reading to the combustion period. It is to be marked T_0 .

During the combustion period readings are to be made and recorded regularly not only till the thermometer reaches its maximum, but also till it is certain that the changes in temperature are again due solely to radiation. This period may be five to ten minutes. There follows a final period of five minutes to fix the radiation losses for the latter portion of the test.

The derivation of the Regnault-Pfaundler formula is as follows:

Let t = mean temp. of initial period.

t' = mean temp. of final period.

v = loss per time interval in initial period.

v' = loss per time interval in final period.

T_0, T_1, T_2, T_n = temperature readings in combustion period.

t_1, t_2, \dots, t_n = average temp. of each interval during combustion period; *i.e.*, $t_1 = \frac{T_0 + T_1}{2}$, etc.

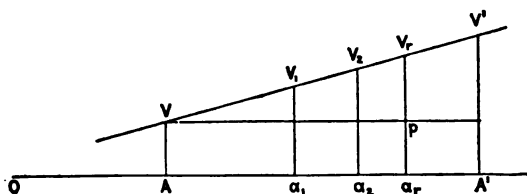

FIG. 57.—Diagram showing derivation of Regnault-Pfaundler formula.

The special case assumed by Pfaundler is one where the initial temperature is only slightly different from room temperature, giving a small value for v . The final temperature is considerably above room temperature and the value of v' is larger than v . The geometrical construction for the Regnault-Pfaundler formula is shown in Fig. 57. The demonstration is as follows:

Lay off $OA = t$.

Lay off $OA' = t'$.

Lay off $Oa_1 = t_1$. $Oa_2 = t_2$ $Oa_n = t_n$

At A erect perpendicular $AV = v$.

At A' erect perpendicular $A'V' = v'$.

Join V and V' by a straight line and at $a_1 a_2$ a_n erect perpendicular intersecting VV' .

Any ordinate $a_r V_r = AV + p_r V_r$.

On account of similar triangles $p_r V_r = \frac{A'V' - AV}{AA'} p_r V$.

$$\begin{aligned} a_r V_r &= AV + \frac{A'V' - AV}{AA'} p_r V \\ &= v + \frac{v' - v}{t' - t} (t_r - t). \end{aligned}$$

C = the algebraic sum of all the ordinates = correction sought.
 n = the number of observations in the combustion period proper.

$$\begin{aligned} C &= nv + \frac{v' - v}{t' - t} (t_1 + t_2 \dots t_n - nt). \\ &= nv + \frac{v' - v}{t' - t} (T_1 + T_2 + T_3 \dots T_{n-1} + \frac{T_0 + T_n}{2} - nt). \end{aligned}$$

Heat received by the calorimeter from the outside air is considered as negative and therefore in the especial case assumed by Pfaundler where the initial temperature was slightly under room temperature v was negative.

The correctness of the formula is independent of the relative values and signs of v and v' .

The corrected rise in temperature of the calorimeter

$$R = T_n - T_0 + C$$

The need of an elaborate correction for radiation is naturally less when the calorimeter is provided with an adequate stirrer so that the heat interchange between the bomb and the water is quickly effected, and also less when the insulating jacket is good than when it is poor. With a well designed calorimeter the largest part of the rise in temperature occurs in the first minute and if the final temperature is only slightly above room temperature radiation in succeeding minutes is almost negligible. The

Proximate Analysis of Coal	
Moisture	0.32 per cent.
Volatile Matter	22.87
Fixed carbon	72.67
Ash	4.14 %
}	
95.5 per cent.	
100.00	

Heat evolved per pound coal dry and free from ash = $\frac{15219}{.955} = 15936$ B.t.u.

Radiation Correction by the Dickinson Formula.—Dr. H. C. Dickinson¹ has worked out a simple method for determining radiation corrections whose use is recommended in the Standard Method of the American Society for Testing Materials,² from which the following quotation is made:

Observe (1) the rate of rise (r_1) of the calorimeter temperature in degrees per minute for five minutes before firing, (2) the time (a) at which the last temperature reading is made immediately before firing, (3) the time (b) when the rise of temperature has reached six-tenths of its total amount (this point can generally be determined by adding to the temperature observed before firing sixty per cent. of the expected temperature rise, and noting the time when this point is reached), (4) the time (c) of a thermometer reading taken when the temperature change has become uniform some five minutes after firing, (5) the final rate of cooling (r_2) in degrees per minute for five minutes.

“The rate r_1 is to be multiplied by the time $b - a$ in minutes and tenths of a minute, and this product added (subtracted if the temperature were *falling* at the time a) to the thermometer reading taken at time a. The rate r_2 is to be multiplied by the time $c - b$ and this product added (subtracted if the temperature were *rising* at the time c, and later) to the thermometer readings taken at the time c. The difference of the two thermometer readings thus corrected, provided the corrections from the certificate have already been applied, gives the total rise of temperature due to the combustion. This multiplied by the water equivalent of the calorimeter gives the total amount of heat liberated. This result, corrected for the heats of formation of nitric and sulphuric acids observed and for the heat of combustion of the firing wire when that is included, is to be divided by the weight of the charge to find the heat of combustion in calories per gram. Calories per gram multiplied by 1.8 give the B.t.u. per pound.

Example:

¹ *Jour. Ind. and Eng. Chem.* 5, 525 (1913).

Scientific Paper No. 230, Bureau of Standards.

² A. S. T. M. Standard, 1918.

OBSERVATIONS

Water equivalent 2550 gm.
 Weight of charge 1.0535
 Approximate rise of temp. 3.2°
 60 per cent. of approximate rise 1.9°

Time	Temp.	Corrected temp.
10-21	15.244°	(Thermometer corrections from the certificate.)
22	15.250	
23	15.255	
24	15.261	
25	15.266	
(a) 26	15.272	15.276°
		Charge fired
(b) 27-12	17.2° ¹	
(c) 31	18.500° ^d	18.497°
32	18.498°	
33	18.497	
34	18.496	
35	18.494	
36	18.493°	

COMPUTATION

$r_1 = 0.028^\circ \div 5 = 0.0056^\circ$ per minute. $b - a = 1.2$ minutes

The corrected initial temperature

is $15.276^\circ + 0.0056^\circ \times 1.2 = 15.283^\circ$.

$r_2 = 0.007^\circ \div 5 = 0.0014^\circ$ per minute; $c - b = 3.8$ minutes.

The corrected final temperature is $18.497^\circ + 0.0014 \times$

3.8.....	= 18.502°	
Total rise $18.502^\circ - 15.283^\circ$	= 3.219°	
Total calories 2550×3.219	=	8209
Titration, etc.....		- 7
Calories from 1.0535 gm. coal.....		8202
Calories per gram.....	7785	
or B.t.u. per lb.....	14013	

In practice, the time $b - a$ will be found so nearly constant for a given calorimeter with the usual amounts of fuel that b need be determined only occasionally.

9. Corrections for Oxidation of Nitrogen.—When coal is burned on a grate minute amounts of oxides of nitrogen are formed by the combination of some of the nitrogen of the air and possibly also of the fuel, with the oxygen of the air. At the

¹The initial temperature is 15.27°; 60 per cent. of the expected rise is 1.9°. The reading to observe is then 17.2°.

higher temperature of combustion in the compressed oxygen of the calorimeter more oxides of nitrogen are formed and account should be taken of the heat evolved in their formation. The heat of formation of aqueous nitric acid from nitrogen, oxygen, and water is represented, according to Thomsen, by the following equation.



This corresponds to 1058 calories per gram of nitrogen or 238 calories per gram of HNO_3 . The American Society for Testing Materials adopts the value 230 instead of 238. The nitric acid formed may be estimated in bombs with platinum or gold linings by rinsing out the bomb and titrating the washings with standard alkali. From this total acidity is deducted the sulphuric acid formed and the balance is considered nitric acid. The amount of nitrogen oxidized is roughly about one per cent. of the total nitrogen present whether introduced as free nitrogen with the oxygen or as combined nitrogen of the coal. The correction is not usually more than 8 calories and may be considered to be offset by the heat absorbed in keeping the gases in the calorimeter at constant volume. (See § 12.)

10. Corrections due to Oxidation of Sulphur.—When sulphur or pyrites burns in the air only about 5 per cent. of the sulphur is oxidized to SO_3 , the rest of it remaining as SO_2 . When combustion takes place under high oxygen pressure in the bomb calorimeter a much larger percentage burns to SO_3 and correction must be made for it. The equations are.

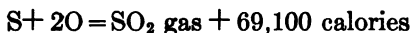

One gram of sulphur burning to SO_2 evolves 2165 calories and to dilute H_2SO_4 evolves 4410 calories. There should therefore be a deduction made of 2245 calories for each gram of sulphur thus oxidized in the bomb. The difficulty is enhanced by the fact that sulphur may be present in coal as free sulphur, as sulphur in organic combination, as pyrites or as calcium sulphate and that the corrections will vary for each of these various forms. For free sulphur burning to H_2SO_4 the correction will be 2245 calories per gram as given above, for sulphur as pyrites 2042¹

¹ Somermeier *J. Am. Chem. Soc.*, 26, 566 (1904).

calories, while for sulphur as gypsum or sulphate of iron no correction is to be made since it is already in the oxidized form.

The conditions governing the oxidation of sulphur in the bomb calorimeter were studied by Regester¹ who found that the oxidation of SO_2 to SO_3 in the bomb was largely a function of the quantity of oxides of nitrogen which were present. The oxides of nitrogen are derived in part from the combined nitrogen of the coal and in part from the free nitrogen in the gases contained in the bomb. Commercial oxygen may contain very little nitrogen and therefore the air which is originally present in the bomb should not be flushed out but should be left in the bomb to ensure the presence of a sufficient quantity of nitrogen to provide for the oxidation of the sulphur. It is customary to assume that all of the sulphur in coal exists in the form of pyrites and to deduct two calories for each milligram of sulphur in the sample of coal. This procedure is not above criticism for Parr² has shown that the amount of sulphate in fresh coal may be as high as one per cent. and that it doubles after six months storage of the ground sample in the laboratory.

A source of error which should be considered here is that due to the possible action of the dilute sulphuric acid formed upon the inner surface of an unlined bomb. A steel bomb soon becomes coated with oxide on its inner surface so the action will be between iron oxide and sulphuric acid. According to Thomsen the reaction $\text{Fe}_2\text{O}_3 \cdot x\text{H}_2\text{O} + 3\text{H}_2\text{SO}_4$ (dilute) evolves 33,840 calories. This means 353 calories for each gram of sulphur involved or 3.5 calories as the maximum error involved for 1 grm. sample of a coal containing 1 per cent. of sulphur. If the acid acts upon steel rather than iron oxide the heat evolved is even less. The error from this source is totally negligible. An expensive calorimeter lined with gold or platinum is unnecessary except where the greatest refinements of accuracy are sought.

11. Correction Due to Combustion of Iron Wire.—The iron fuse wire which burns to Fe_3O_4 evolves 1600 calories per gram, or 1.6 calories per mg. of iron burned.

12. Reduction to Constant Pressure.—Combustion in the bomb calorimeter takes place at constant volume whereas in

¹ *Jour. Ind. and Eng. Chem.*, 6, 812 (1914).

² *Jour. Ind. and Eng. Chem.*, 5, 523 (1913).

ordinary furnace work combustion takes place at constant pressure. Wherever a decrease in volume takes place on combustion as where oxygen unites with hydrogen to form water which condenses, the gases in the calorimeter which should normally have contracted after combustion have had work done upon them to keep them at constant volume with the disappearance of an equivalent amount of heat. The correction amounts to 541 calories for each gram molecule of gas which disappears.

When gaseous oxygen combines with carbon to form CO_2 there is no change of volume and hence no correction. The oxygen in the organic matter of the coal, may for the purposes of this calculation be considered to unite with the hydrogen of the coal to form water. No correction is needed here since both the hydrogen and the oxygen were in the solid state before combustion and the water formed is a liquid.

There is always present in coal an excess of hydrogen over that sufficient to combine with the oxygen and this so-called available hydrogen burns with gaseous oxygen to form water which condenses. The change in volume is shown by the equation

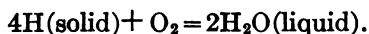

The gas which disappears is oxygen in the proportion of one gram molecule for each 4 gm. of hydrogen. The amount of available hydrogen in coals varies from 3 to 5 per cent. so that on a gram sample there would be on an average 0.04 gm. of hydrogen which would unite with 0.01 gm. molecule of oxygen causing a correction of 5 calories—a negligible amount except as it may be considered as balancing other minor errors such as that due to the oxidation of nitrogen. With petroleum the correction will be about three times as great as with coal.

13. Water Value of Calorimeter.—When combustion occurs in a calorimeter there follows a rise in the temperature of both the water and of the calorimeter vessel. It is necessary to find how many calories are required to heat the metal parts of the calorimeter one degree and when this has been accomplished the value is translated for convenience of calculation into grams of water and called the water value of the calorimeter. The water value is usually determined in one of four ways. The first

is by calculation from the weight of the metal parts and their specific heats; the second is by the combustion of a pure substance, such as sugar, benzoic acid or naphthalene, whose heating value is known; and the third is by the addition to the calorimeter of a definite amount of hot water with the determination of the rise in temperature resulting; the fourth is by the input of a definite amount of electrical energy. The first method is simple but of only approximate accuracy. The second method has the advantage of tending to compensate for any errors such as the oxidation of nitrogen in combustion and even errors in the thermometer and in radiation corrections in so far as these are constant. The third method has the advantage of being an absolute one, but it is difficult to get it accurate. The fourth method is accurate but requires considerable equipment, such as described by Dickinson.¹

First Method.—The first method requires simply that the weights of each of the several different materials contained in the bomb, the stirrer, the thermometer and the water-containing vessel be known. By multiplying these weights by the specific heats as given in the following table the number of calories is obtained directly.

TABLE OF SPECIFIC HEATS*

	Sp. ht.
Tool steel.....	0.1087
Gun steel.....	0.1114
German silver.....	0.094
Platinum.....	0.032
Lead.....	0.030
Oxygen (constant vol.).....	0.157
Brass.....	0.094
Mercury.....	0.033
Glass.....	0.19

The inaccuracy of the method lies partly in the fact that it is not possible to determine the individual weights of each of these constituents—*e.g.*, the mercury in the thermometer, and partly in the fact that not all of the materials thus weighed are heated in actual practice to the temperature indicated by the thermom-

¹ Scientific Paper No. 230, Bureau of Standards.

² Atwater and Snell, *J. Am. Chem. Soc.*, 25, 694.

eter immersed in water. A large part of the thermometer is outside of the calorimeter, a part of the stirrer is, in some types of apparatus, constantly passing in and out, and the top of the calorimeter vessel although within the calorimeter is not in contact with the water. On the other hand there is some transfer of heat from the calorimeter vessel to its jackets of which no account is taken. Fortunately all these errors are minor ones but the method can hardly be considered accurate within 3 per cent.

Second Method.—The method of determining the water value of a calorimeter by the combustion of a substance of known heating value is the most commonly employed and the most reliable one. Sugar, naphthalene and benzoic acid are substances which are readily obtained in a state of purity and whose heating value has been determined by a number of independent observers. Dickinson¹ has accurately determined the heats of combustion of these substances and gives the following figures as the heat of combustion per gram of substances weighed in air:

Sucrose 3940 ± 2 calories (20°)

Naphthalene 9622 ± 2 calories (20°)

Benzoic Acid 6329 ± 2 calories (20°)

Benzoic acid is recommended as the most desirable for a combustion standard.

The procedure in determining the water value is exactly the same as for the combustion of a fuel. A sufficient amount of the pure material is pressed into a pellet so that the heat evolved by its combustion will be 7000–8000 calories. This is placed in the bomb which is charged with oxygen, set in the calorimeter and fired, the temperature readings being made as usual. In the final calculations the unknown to be solved for is the mass of water equivalent to the calorimeter which has been heated. The difference between this value and the mass of water actually added gives the water value of the calorimeter.

The method of conducting the combustion is the same as that for coal and should be recorded according to the form, § 8. The following example gives the method of calculation.

¹ Scientific Paper No. 230, Bureau of Standards (1914).

Total heat evolved

from benzoic acid..... $1.0856 \times 6320 = 6870$ caloriesfrom iron wire..... $0.022 \times 1600 = 35$

6905

Corrected rise in temperature 2.854°C .Heat absorbed by water $2000 \times 2.854 = 5708$

Heat absorbed by calorimeter

1197 calories

Water value = $\frac{1197}{2.854} = 419 \frac{\text{cal}}{\text{C}}$

The accuracy of this process is dependent first on the purity of the materials used as a standard. Samples of pure substances with certified heat value should be obtained from the Bureau of Standards. The accuracy is also affected by errors in the thermometer, errors due to oxidation of nitrogen, etc., but in this very fact lies one of the valuable points of the method. For if it be assumed that with a thermometer set at a given zero there is an error of 0.02° in a rise of three degrees and that there is a correction of 8 calories to be made with oxygen from a certain tank when a sample of benzoic acid which gives a rise of 3° , is burned, and both of these corrections be neglected, it is evident that the water value obtained will be in error. But if this erroneous water value be used in the calculations of the heating value of a coal where the errors due to the thermometer and the oxidation of nitrogen are the same as in the combustion of sugar, and where the total rise in temperature is approximately the same, the erroneous water value will compensate for the errors on the coal test and the result of the coal test will be correct.

14. Adiabatic Calorimeters.—Corrections for transfer of heat between the calorimeter and its jacket must always be made with the ordinary type of instrument. If the calorimeter bomb is placed in a Dewar vessel, the heat interchange may be lessened but not eliminated. Corrections may only be avoided by completely surrounding the calorimeter by a vessel whose temperature changes constantly during the test to keep pace with the changing temperatures in the calorimeter. The temperature of the jacket may be varied by addition of warm water or by electrical means. Such adiabatic calorimeters are somewhat complicated in operation but allow simple calculations. They do not necessarily give more accurate results.

15. Precision Calorimetry.—The requirements for precision in calorimetric work have been considered by Dickinson¹ and W. P. White.² It is useless to try to attain precision merely by increasing accuracy of thermometric readings as by substitution of an electric for a mercurial thermometer. All sources of error must be reduced to a minimum and correction must be made for them. When it is considered that the error in sampling coal is usually over one per cent., it will be seen that methods of high precision are not called for in coal calorimetry.

16. Accuracy of Results.—It is the aim to determine by combustion in the bomb calorimeter the amount of heat which would be evolved by the combustion of a fuel in the outside air. This standard is not an absolute one, for not only will carbon be burned to carbon dioxide and hydrogen to water in an ordinary fire but also sulphur will be burned, in part to SO₂ and in part to SO₃, and small amounts of nitrogen will be burned. In applying corrections to the figures obtained in the bomb calorimeter it is customary to assume that all of the sulphur of the coal burns to SO₃ in the bomb, and that all of it burns to SO₂ in the air, and that no nitrogen is oxidized on combustion of coal in air. The errors introduced by these assumptions are small and are usually neglected. The accuracy of the estimation of the amount of heat evolved by combustion in the bomb will depend on the accuracy with which the water value of the system is known, the care taken in making radiation corrections and the accuracy with which the rise in temperature is measured. This last usually involves the largest error. If the error is 0.01°, it will amount to about 0.3 per cent. or 40 British thermal units. When care is taken in every detail and apparatus of superior quality is used the agreement between duplicate determinations will be closer than this but it is certainly not safe to claim a closer absolute accuracy since according to Jesse³ the highest authorities differ by 0.25 per cent. as to the absolute heating value of sugar and benzoic acid. The Committee on Coal Analysis states that in its judgment results obtained by a single analyst should not differ more than 0.3 per cent. and that

¹ Scientific Paper No. 230, Bureau of Standards.

² *Jour. Franklin Inst.*, 186, 279 (1918).

³ *Jour. Ind. and Eng. Chem.*, 4, 748 (1912).

results obtained by different analysts should not vary by over 0.4 per cent. This high standard can only be attained when every precaution is observed.

7. Total and Net Heating Values.—The heating value of the fuel computed by the method given above gives the total heat developed when the water formed condenses to a liquid within the calorimeter. This gives the total heat. In most industrial operations the water escapes as steam, and if deduction is made for its latent heat, a lower net heating value is obtained. This net figure gives a closer approximation to the heat which is ordinarily utilized, but it does not give it accurately, because an arbitrary assumption has been made as to the temperature of the escaping gases. It is customary to report the total heating value of the coal and allow the consumer to put such a factor on it as will indicate its relative efficiency for the purpose to which he intends to put it. The net heating value is obtained by deducting from the total heating value the latent heat of the water present in the fuel or formed in combustion. The water is determined from the hydrogen as shown by ultimate analysis. The formula for calculation of net heating value is:

$$\text{Net heating value} = \text{total B.t.u.} - 1040 (\text{hydrogen} \times 9)$$

Attempts have frequently been made to calculate the total heating value from the proximate analysis. Very little success has attended these efforts, but Fieldner and Selvig¹ have shown that the correction to be applied to the total heat of combustion to obtain the net heating value may be calculated with considerable accuracy. By the use of curves constructed from 2000 analyses, the hydrogen content of bituminous coal, semi-bituminous coal and anthracite may be estimated from the volatile matter to within 0.6 per cent. With sub-bituminous and lignitic coals the error is somewhat greater. The original paper must be referred to for details.

¹ Technical Paper 197, Bureau of Mines.

CHAPTER XVII

HEATING VALUE OF COAL BY THE PARR CALORIMETER AND OTHER METHODS

1. Introduction.—The preceding chapter was devoted to a discussion of the bomb calorimeter as the standard instrument for the determination of the heating value of coal. The present chapter will deal with other methods, such as combustion in a stream of oxygen, combustion with chemicals like sodium peroxide, and calculation of the heating value from the chemical composition of the coal.

2. Combustion in a Stream of Oxygen.—Calorimeters of this type have become obsolete on account of difficulties of manipulation and sources of error. The temperature of the oxygen flowing in must be accurately measured and also the temperature of the gases flowing out, for correction must be made for the heat which these streams of gas carry. The great source of error is the incomplete combustion of the coal. With bituminous coals smoke may frequently be seen issuing from the instrument and even with anthracite and coke, carbon monoxide may always be found in the escaping gases. Accurate results have been obtained with this type of calorimeter but only after laborious correction for the large number of errors.

3. The Thompson Calorimeter.—A very crude form of calorimeter which has also become obsolete was that of Lewis Thompson. He mixed powdered coal with potassium chlorate and nitrate, placed the mixture in a calorimeter vessel and fired the charge. The method and apparatus were crude throughout but the greatest source of error lay in the heat absorbed in the decomposition of the chlorate and nitrate. When coal burns under a boiler it unites with gaseous oxygen to form CO_2 and H_2O . Essentially the same result takes place in a bomb calorimeter. When, however, the oxygen is taken from one form of chemical combination and is made to combine with the coal to form a different compound, the result is not at all the same as that

obtained in the combustion of the coal with gaseous oxygen and the corrections to be applied must be worked out with great care. Scheurer-Kestner¹ determined that if 15 per cent. was added to the heating value obtained with the Thompson calorimeter, the results never differed by more than 4 per cent. from those obtained by the Favre and Silverman calorimeter which burns the coal in a stream of oxygen.

4. The Parr Calorimeter.—Parr² proposed sodium peroxide as a chemical to be used in oxidizing coal in a calorimeter, worked out the corrections to be applied, and devised a very practical calorimeter. He writes the probable reactions in the calorimeter as follows:

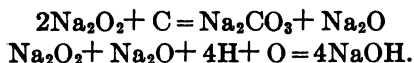

There is more heat evolved in each of these reactions than in the combustion of carbon and hydrogen with gaseous oxygen but fortunately the reduction factor is closely the same for both of them. The heat evolved by the combustion of carbon and hydrogen in the Parr calorimeter multiplied by 0.73 gives the true heat value. Smaller corrections are to be made for the dissociation of the KClO_3 used, for the oxidation of sulphur, the combustion of the fuse wire, the fusion of the ash, and the hydroxyl or combined water present in coal.

Since the oxygen is introduced as a solid and the Na_2CO_3 and NaOH formed in the reaction are also solids, the bomb need not be made to resist high gas pressures but may be made of thin metal.

The general arrangement of the calorimeter is shown in Figs. 58 and 59. Fig. 58 shows a section of the fibre buckets which act as heat insulators and of the can which holds the water. The fusion cup is shown in position. The stirring is accomplished very effectively by the removable wings attached to the bomb which force the water down the annular space between the fusion

¹ *Bull. Soc. Ind.*, Mulhouse, 506, 1888.

² *Jour. Am. Chem. Soc.*, 22, 646 (1900).

Jour. Am. Chem. Soc., 24, 167 (1902).

Jour. Am. Chem. Soc., 29, 1606 (1907).

The Chemical Engineer, 6, 253 (1907).

J. Ind. and Eng. Chem., 1, 673 (1909).

cup and the centering cylinder, out of openings at the bottom and up again on the outside.

Details of the fusion cup are shown in Fig. 59, where C is the brass fusion cup closed at the top by the headpiece and the rubber gasket G. The outer shell A and the removable bottom B are separated by an air space from the fusion cup which prevents too rapid cooling of the charge during the first stages of fusion.

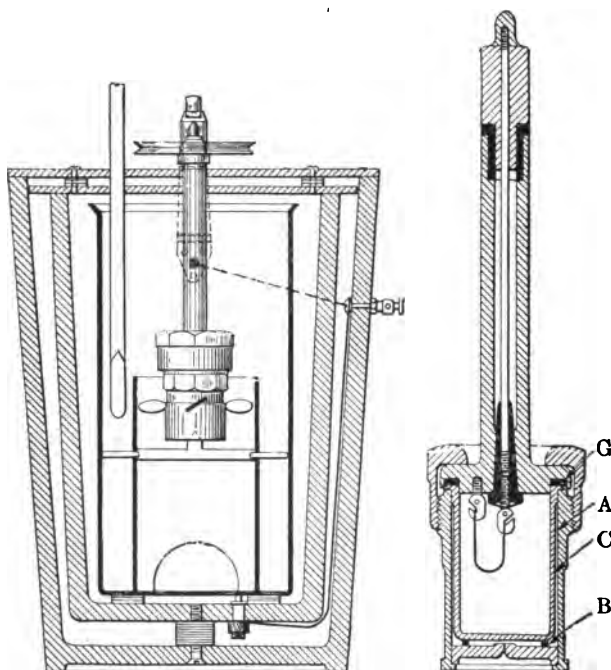

FIG. 58.—Parr calorimeter. FIG. 59.—Details of Parr calorimeter.

5. Preparation of Parr Calorimeter.—The bomb must be thoroughly dry and the gasket in good condition. It is best to dry the parts after each test in an oven and to examine them carefully before putting them together. The lower cap B is fitted into place, the fusion cup is inserted in its shell, and the head piece firmly screwed down with the wrench provided. Water leaking into the bomb always spoils the determination and may cause an explosion.

The coal is to be ground to pass a 100-mesh sieve in order that it may react rapidly with the peroxide. Anthracite coal, coke, semi-bituminous and eastern bituminous coals in which the moisture will not exceed 3 per cent. may be used in an air-dry condition. Other bituminous coals, lignites, peats, etc., must be dried at 105° C. before use to avoid the reaction between the hygroscopic moisture and the peroxide with evolution of heat in the calorimeter. The danger of change in the coal sample during the processes of drying and grinding is treated in Chapter XV on Chemical Analysis.

It is necessary to secure very intimate mixture of the coal, the Na_2O_2 and the KClO_3 added as an accelerator of combustion. The charge consists of 1 gram. of the dry and finely ground KClO_3 , 0.5 gram. of the coal prepared as directed above and approximately 10 gram. of sodium peroxide which may be measured with sufficient accuracy in the scoop provided with the instrument. The contents of the bomb are next to be thoroughly mixed by shaking. If this were done after the regular top and firing wire were in place the firing wire would almost certainly become twisted and short circuited, so it is better to use the false top provided. It is well at the beginning of the shaking process to invert the cartridge and tap it sharply on the desk to dislodge any coal which may have stuck to the bottom. When the mixing is complete the bottom of the cartridge may be tapped lightly against the desk to dislodge any material sticking to the cap. The regular top to which about 3 in. of fine iron wire (32 or 34 American gage) has been attached in a loop as shown in Fig. 59 is now placed carefully in position and screwed into place. Care should be taken after this has been adjusted, not to tip the bomb since the fine iron wires are easily crossed. The spring stirring clips may now be adjusted and the apparatus set up as shown in Fig. 58.

The strength of the firing current will vary between 2 and 4 amperes. It should be adjusted by trials in the open air until the wire fuses promptly on closing the switch.

6. Care of Sodium Peroxide.—Sodium peroxide is hygroscopic and absorbs moisture from the air, even when preserved in apparently well-stoppered bottles, forming $\text{Na}_2\text{O}_2 \cdot 2\text{H}_2\text{O}$. The effect of this hydrate formation is illustrated by an experiment

made by Professor Parr. He exposed 10 grm. of sodium peroxide on a watch glass in the laboratory for an hour and found that it had gained in weight nearly 0.5 grm. This peroxide when used in the calorimeter gave a rise in temperature higher by 0.194° than the pure peroxide. As the total correct rise of temperature in this experiment was only 2.180° it will be seen that the error was almost 9 per cent.

The sodium peroxide should not only be pure and anhydrous but should also be in grains of the proper size. If the peroxide is too coarse the powdered coal tends to sift to the bottom of the bomb and escape combustion. If peroxide is too fine the reaction is sometimes very violent. The manufacturers of the calorimeter furnish reliable peroxide in small hermetically sealed cans and also furnish a clamp-top fruit jar which is said to preserve the contents of a single can during its use.

Sodium peroxide reacts at ordinary temperatures with all organic substances in presence of moisture with evolution of heat often sufficient to produce flame or explosion. Mixtures of sodium peroxide and coal which may have to be disposed of are not to be thrown into waste jars. They may be cautiously and slowly poured into a vessel containing considerable water which will absorb the heat and prevent violent reactions. Sodium peroxide causes bad burns on the skin.

7. Operation of Parr Calorimeter.—The fusion cup prepared as above directed is placed in the calorimeter vessel and properly centered. Two thousand grams of water are then added to the calorimeter vessel. It is preferable that the temperature of the water should be about 2.0° C. below room temperature for the radiation correction will be less under these conditions. The thermometer is adjusted and the bomb started to rotating at the rate of about 150 revolutions a minute. Temperatures are to be read at the end of each minute. Within two or three minutes the readings of the thermometer should become almost constant except for the regular and very slight change due to radiation. Should the thermometer rise irregularly and more rapidly than 0.01 or 0.02° per minute during this preliminary period, there is probably a slight leak of water into the bomb. The operation must be at once stopped, the bomb taken out, wiped dry on the outside, opened and emptied. A leaky bomb is

not only inaccurate but dangerous. After five readings at intervals of one minute each in the preliminary period have shown only this slight and regular change of temperature, ignition is effected by closing the switch on the cover of the instrument. The thermometer rises very rapidly owing to the thin walls of the fusion cup and the efficient stirring and usually reaches its maximum after two minutes. Nevertheless observations should be continued for at least eight minutes after ignition to allow corrections for radiation to be made.

The bomb is then removed from the water, wiped dry and opened. There should be no trace of unburned carbon visible, nor any odor. The lower plug is removed and the inner vessel with its fused contents placed in a casserole containing about 500 c.c. of water, until all the fused peroxide has dissolved. It is then removed, rinsed out and dried.

The solution in the casserole is to be tested for unburned carbon. As an alkaline solution it contains black flakes of oxides of iron and copper. After acidification it becomes a clear yellow solution, with carbon as the only matter in suspension, the silicic acid remaining in solution in the large volume of water. If any unburned carbon is visible it should be filtered on a Monroe or Gooch crucible, dried and weighed. A correction of 8.1 calories must be made for each milligram of unburned carbon. This precaution should never be omitted by a beginner nor where accurate work is important.

The corrected rise of temperature may be calculated according to the formulas given in Chapter XVI, but a simpler method will usually suffice since this calorimeter is not used where the greatest accuracy is required. It is sufficiently accurate to assume that the average change in temperature per minute during the final period represents also the change due to radiation for each minute during the combustion period. The errors involved in this assumption are small since the temperature in the combustion period rises to almost its full value in the first minute. The temperature at the end of the fourth minute after ignition, may be taken as the end of the combustion period and corrections as shown by the next four minutes' readings, applied to it. Corrections for potassium chlorate, sulphur, ash, etc., as given in

the following section are to be deducted from this reading, the result being the corrected final temperature.

The older model of instrument furnished by the makers had a standard water equivalent of 135 grm. The corrected rise in temperature multiplied by 2135 and by the factor .73 and divided by the weight of the sample in grams gave the heat value in calories per gram. The figure may be converted into British thermal units per pound by multiplying it by 1.8. The present model is heavier and has a water value of 3100 grams when ready for a test.

8. Corrections to be Applied with Parr Calorimeter.—Parr has worked out very carefully the correction to be applied and published his results in the journals cited as references at the commencement of this chapter. He has shown that the ratio of the heat evolved in the combustion of carbon and hydrogen with gaseous oxygen to that evolved on combustion with sodium peroxide is very closely represented by the factor 0.73. The $KClO_3$ used as an accelerator evolves an additional amount of heat. Similar corrections are required for ash, sulphur, fuse wire, and hydroxyl constituents of the coal. Since the calorimeter is always furnished with a standard water value these corrections may be calculated in terms of temperature. The corrections for the earlier model¹ have been modified to conform to the altered water equivalent of the new apparatus and are now given as follows:

Electric fuse wire equals.....	0.0030° C. or 0.005° F.
Per cent. ash is multiplied by	0.0025° C. or 0.005° F.
Per cent. sulphur is multiplied by.....	0.0050° C. or 0.010° F.
1 gram accelerator equals.....	0.1500° C. or 0.270° F.
Hydrogen factors:	
For all Bituminous coals.....	0.0400° C. or 0.070° F.
For black lignites.....	0.0560° C. or 0.100° F.

9. Accuracy of Parr Calorimeter.—The work of Professor Parr has shown definitely that accurate results may be obtained with this calorimeter, but it has also shown that this accuracy can be gained only by the observation of precautions and the use of corrections which deprive the process of much of the simplicity

¹ *J. Ind. and Eng. Chem.*, 1, 673 (1909).

which formerly characterized it. Accurate results are dependent on the quality of the peroxide used, a point which must usually be taken on faith. The calculations involve a knowledge of the ash, sulphur, and volatile matter of the coal and the application of corrections for these constituents. These points prevent the method from being a standard one as is combustion in the bomb calorimeter, but do not prevent it from being a useful commercial instrument where the highest accuracy is not required.

10. Calculation of the Heating Value from Chemical Analysis.—If an ultimate analysis is available, the heating value of a coal may be calculated with fair accuracy from the Dulong formula which is usually given as

$$\text{Calorific power} = \frac{8080C + 34460 \left(H - \frac{O}{8} \right) + 2500S}{100}$$

where C, H, O and S represent the respective percentages of these various elements shown by the analysis. This formula gives results in Calories per kilogram which when multiplied by 1.8 are converted into British thermal units per pound. Tests of 57 coals made by the U. S. Geological Survey¹ show an average error of 87.5 calories in the calculated result and a maximum error of 312 calories. Inasmuch as it is much simpler to determine the calorific value directly than to make an ultimate analysis, the value of this formula has come to lie largely in its confirmation of the correctness of the ultimate analysis.

A formula which would correlate proximate analysis and heating value would be much more useful, but on account of the variable composition of the volatile matter in different types of coal no general formula can be devised which will fit all cases. The combustible matter of coal from a given seam is, however, quite constant in composition and after its value has been experimentally determined this figure may be used with considerable accuracy as a basis for the calculation of the heating value of similar coals whose moisture and ash content are known.

¹ U. S. G. S., Professional Paper 48 (1906); *Bulletin* 382 (1909) p. 24.

TABLE I.—SATURATION PRESSURE OF WATER VAPOR

From 0–50° C. in millimeters of mercury. Scheel and Heuse, *Ann. d. Phys.* (4), 31, 731 (1910).

Temp.° C.	mm. Hg.	Temp.° C.	mm. Hg.
0	4.579	26	25.217
1	4.926	27	26.747
2	5.294	28	28.358
3	5.685	29	30.052
4	6.101	30	31.834
5	6.543	31	33.706
6	7.014	32	35.674
7	7.514	33	37.741
8	8.046	34	39.911
9	8.610	35	42.188
10	9.210	36	44.577
11	9.845	37	47.082
12	10.519	38	49.708
13	11.233	39	52.459
14	11.989	40	55.341
15	12.790	41	58.36
16	13.637	42	61.52
17	14.533	43	64.82
18	15.480	44	68.28
19	16.481	45	71.90
20	17.539	46	75.67
21	18.655	47	79.62
22	19.832	48	83.74
23	21.074	49	88.05
24	22.383	50	92.54
25	23.763		

TABLE II.—REDUCTION OF GAS VOLUMES TO 0° AND 760 MM. MERCURY PRESSURE AND DRYNESS

If the gas is already dry the reduction formula is

$$V_0 = \frac{V}{1 + .00367 t} \frac{h}{760}$$

where t is the temperature and h the barometric pressure corresponding to the volume V .

If the gas is saturated with moisture there must be deducted from the observed barometric reading the value e for the vapor pressure of water corresponding to the temperature t as given in Table I. The reduction formula then becomes

$$V_0 = \frac{V}{1 + .00367 t} \frac{h - e}{760}$$

The following table gives the values for $1 + 0.00367t$ for each degree from 0° to 50° C.

t	$1 + 0.00367t$	t	$1 + 0.00367t$
0	1.00000	26	1.09542
1	1.00367	27	1.09909
2	1.00734	28	1.10276
3	1.01101	29	1.10643
4	1.01468	30	1.11010
5	1.01835	31	1.11377
6	1.02202	32	1.11744
7	1.02569	33	1.12111
8	1.02936	34	1.12478
9	1.03303	35	1.12845
10	1.03670	36	1.13212
11	1.04037	37	1.13579
12	1.04404	38	1.13946
13	1.04771	39	1.14313
14	1.05138	40	1.14680
15	1.05505	41	1.15047
16	1.05872	42	1.15414
17	1.06239	43	1.15781
18	1.06606	44	1.16148
19	1.06973	45	1.16515
20	1.07340	46	1.16882
21	1.07707	47	1.17249
22	1.08074	48	1.17616
23	1.08441	49	1.17983
24	1.08808	50	1.18350
25	1.09175

III.—FACTORS FOR REDUCTION OF GAS VOLUME TO 60° F. AND 30 IN. OF MERCURY PRESSURE AND SATURATION WITH MOISTURE

		BAROMETER																			
		28.6	28.7	28.8	28.9	29.0	29.1	29.2	29.3	29.4	29.5	29.6	29.7	29.8	29.9	30.0	30.1	30.2	30.3	30.4	30.5
107	0.816	0.820	0.823	0.826	0.829	0.832	0.835	0.838	0.841	0.844	0.847	0.851	0.854	0.857	0.860	0.863	0.867	0.870	0.874	0.878	0.881
106	0.820	0.823	0.826	0.829	0.832	0.835	0.838	0.841	0.844	0.847	0.851	0.854	0.857	0.860	0.863	0.867	0.870	0.874	0.878	0.881	0.884
105	0.823	0.827	0.830	0.833	0.836	0.839	0.842	0.845	0.848	0.851	0.855	0.858	0.861	0.864	0.867	0.871	0.874	0.878	0.881	0.884	0.887
104	0.827	0.830	0.833	0.836	0.839	0.842	0.845	0.848	0.851	0.854	0.858	0.861	0.864	0.867	0.871	0.874	0.878	0.881	0.884	0.887	0.891
103	0.830	0.834	0.837	0.840	0.843	0.847	0.849	0.852	0.855	0.858	0.862	0.865	0.868	0.871	0.874	0.878	0.881	0.885	0.888	0.891	0.894
102	0.834	0.837	0.840	0.843	0.847	0.850	0.853	0.856	0.859	0.862	0.865	0.868	0.871	0.874	0.878	0.881	0.885	0.888	0.891	0.894	0.898
101	0.837	0.840	0.843	0.846	0.850	0.853	0.856	0.859	0.862	0.865	0.868	0.872	0.875	0.878	0.881	0.885	0.888	0.891	0.895	0.898	0.901
100	0.840	0.843	0.846	0.849	0.853	0.856	0.859	0.862	0.865	0.868	0.872	0.875	0.878	0.881	0.885	0.888	0.891	0.895	0.898	0.901	0.905
99	0.844	0.847	0.850	0.853	0.857	0.860	0.863	0.866	0.869	0.872	0.875	0.878	0.881	0.885	0.888	0.891	0.895	0.898	0.901	0.904	0.908
98	0.847	0.850	0.853	0.856	0.860	0.863	0.866	0.869	0.872	0.875	0.878	0.881	0.885	0.888	0.891	0.895	0.898	0.901	0.904	0.908	0.911
97	0.850	0.853	0.856	0.859	0.863	0.866	0.870	0.873	0.876	0.879	0.882	0.885	0.888	0.891	0.894	0.898	0.901	0.904	0.908	0.911	0.914
96	0.854	0.857	0.860	0.863	0.867	0.870	0.873	0.876	0.879	0.882	0.885	0.888	0.891	0.894	0.898	0.901	0.904	0.907	0.910	0.914	0.918
95	0.857	0.860	0.863	0.866	0.870	0.873	0.876	0.879	0.882	0.885	0.888	0.891	0.894	0.898	0.901	0.904	0.907	0.910	0.914	0.918	0.921
94	0.860	0.863	0.866	0.869	0.873	0.876	0.879	0.882	0.885	0.888	0.891	0.894	0.898	0.901	0.904	0.907	0.910	0.914	0.918	0.921	0.924
93	0.863	0.866	0.869	0.872	0.876	0.879	0.883	0.886	0.889	0.891	0.895	0.898	0.901	0.904	0.907	0.910	0.914	0.918	0.921	0.924	0.928
92	0.866	0.869	0.872	0.875	0.879	0.882	0.885	0.888	0.891	0.894	0.898	0.901	0.904	0.907	0.910	0.914	0.917	0.921	0.924	0.928	0.931
91	0.869	0.872	0.875	0.879	0.882	0.885	0.888	0.891	0.894	0.898	0.901	0.905	0.908	0.911	0.914	0.917	0.921	0.924	0.928	0.931	0.934
90	0.872	0.875	0.878	0.881	0.885	0.888	0.892	0.895	0.898	0.901	0.905	0.908	0.911	0.914	0.917	0.920	0.924	0.927	0.931	0.934	0.937
89	0.875	0.878	0.882	0.885	0.889	0.892	0.895	0.898	0.901	0.904	0.907	0.910	0.914	0.917	0.920	0.923	0.926	0.930	0.934	0.937	0.940
88	0.878	0.881	0.885	0.888	0.892	0.895	0.898	0.901	0.904	0.907	0.910	0.913	0.916	0.920	0.923	0.926	0.929	0.933	0.937	0.940	0.943
87	0.881	0.884	0.888	0.891	0.895	0.898	0.901	0.904	0.907	0.910	0.913	0.916	0.919	0.923	0.926	0.929	0.933	0.937	0.940	0.943	0.946
86	0.884	0.887	0.890	0.894	0.898	0.901	0.904	0.907	0.910	0.913	0.916	0.919	0.923	0.926	0.929	0.933	0.937	0.940	0.943	0.946	0.949
85	0.887	0.890	0.893	0.896	0.900	0.903	0.906	0.909	0.913	0.916	0.919	0.922	0.925	0.928	0.932	0.935	0.939	0.942	0.946	0.949	0.952
84	0.889	0.893	0.896	0.899	0.903	0.906	0.909	0.912	0.915	0.919	0.922	0.925	0.928	0.932	0.935	0.939	0.942	0.946	0.949	0.952	0.955
83	0.892	0.895	0.899	0.902	0.906	0.909	0.912	0.915	0.918	0.921	0.924	0.928	0.931	0.935	0.938	0.942	0.945	0.948	0.951	0.954	0.958
82	0.895	0.898	0.901	0.904	0.908	0.911	0.914	0.918	0.921	0.924	0.927	0.931	0.934	0.937	0.941	0.944	0.948	0.951	0.954	0.958	0.962

TEMPERATURE ° F.

SATURATION WITH MOISTURE.—(Continued)

BAROMETER

	28.6	28.7	28.8	28.9	29.0	29.1	29.2	29.3	29.4	29.5	29.6	29.7	29.8	29.9	30.0	30.1	30.2	30.3	30.4	30.5
86	0.901	0.904	0.907	0.910	0.914	0.917	0.920	0.923	0.927	0.930	0.933	0.937	0.940	0.943	0.946	0.950	0.954	0.957	0.960	0.963
79	0.904	0.907	0.910	0.914	0.917	0.920	0.923	0.926	0.930	0.933	0.936	0.939	0.943	0.946	0.949	0.953	0.956	0.960	0.963	0.967
78	0.906	0.909	0.913	0.916	0.919	0.923	0.926	0.929	0.933	0.936	0.939	0.942	0.946	0.949	0.952	0.956	0.959	0.963	0.966	0.969
77	0.909	0.912	0.915	0.919	0.922	0.925	0.928	0.931	0.935	0.938	0.941	0.945	0.948	0.951	0.955	0.958	0.962	0.965	0.968	0.972
76	0.911	0.915	0.918	0.921	0.925	0.928	0.931	0.935	0.938	0.941	0.944	0.948	0.951	0.954	0.958	0.961	0.964	0.968	0.971	0.975
75	0.914	0.917	0.921	0.924	0.928	0.931	0.934	0.937	0.940	0.943	0.947	0.950	0.954	0.957	0.960	0.963	0.967	0.971	0.974	0.978
74	0.917	0.920	0.924	0.927	0.930	0.933	0.937	0.940	0.943	0.947	0.950	0.953	0.957	0.960	0.963	0.966	0.970	0.973	0.977	0.980
73	0.920	0.923	0.926	0.930	0.933	0.936	0.940	0.943	0.946	0.949	0.953	0.956	0.960	0.963	0.966	0.969	0.972	0.976	0.980	0.983
72	0.922	0.925	0.929	0.932	0.935	0.939	0.942	0.945	0.949	0.952	0.955	0.959	0.962	0.965	0.968	0.972	0.975	0.979	0.982	0.986
71	0.925	0.928	0.931	0.935	0.938	0.941	0.945	0.948	0.951	0.954	0.958	0.961	0.965	0.968	0.971	0.975	0.978	0.981	0.985	0.989
70	0.927	0.931	0.934	0.937	0.941	0.944	0.947	0.950	0.954	0.957	0.960	0.963	0.967	0.970	0.974	0.977	0.980	0.984	0.988	0.991
69	0.930	0.933	0.937	0.940	0.944	0.947	0.950	0.953	0.957	0.960	0.963	0.967	0.970	0.973	0.977	0.980	0.983	0.987	0.990	0.994
68	0.932	0.936	0.939	0.942	0.945	0.949	0.952	0.955	0.959	0.962	0.966	0.969	0.972	0.976	0.979	0.983	0.986	0.989	0.993	0.997
67	0.935	0.938	0.942	0.945	0.949	0.952	0.955	0.959	0.962	0.965	0.968	0.972	0.975	0.979	0.982	0.985	0.989	0.992	0.996	1.000
66	0.938	0.941	0.944	0.948	0.951	0.954	0.958	0.961	0.964	0.968	0.971	0.974	0.978	0.981	0.985	0.988	0.992	0.995	0.998	1.002
65	0.941	0.944	0.947	0.950	0.954	0.957	0.960	0.963	0.967	0.970	0.973	0.977	0.980	0.984	0.987	0.991	0.994	0.997	1.001	1.005
64	0.943	0.946	0.949	0.953	0.956	0.959	0.963	0.966	0.969	0.973	0.976	0.980	0.983	0.986	0.990	0.994	0.997	1.000	1.004	1.008
63	0.945	0.949	0.952	0.955	0.959	0.962	0.965	0.969	0.972	0.975	0.979	0.982	0.985	0.989	0.993	0.996	1.000	1.003	1.006	1.010
62	0.947	0.951	0.954	0.958	0.961	0.964	0.968	0.971	0.975	0.978	0.981	0.985	0.988	0.991	0.995	0.999	1.002	1.005	1.009	1.013
61	0.950	0.954	0.957	0.961	0.964	0.967	0.971	0.974	0.977	0.981	0.984	0.987	0.991	0.994	0.998	1.001	1.005	1.008	1.011	1.015
60	0.952	0.956	0.959	0.963	0.966	0.969	0.973	0.976	0.980	0.983	0.986	0.990	0.993	0.997	1.000	1.004	1.007	1.010	1.014	1.017
59	0.955	0.959	0.962	0.966	0.969	0.972	0.976	0.979	0.983	0.986	0.989	0.992	0.995	0.999	1.002	1.005	1.009	1.012	1.016	1.020
58	0.957	0.961	0.964	0.968	0.971	0.975	0.978	0.981	0.985	0.988	0.992	0.995	0.998	1.002	1.005	1.009	1.012	1.016	1.019	1.023
57	0.960	0.963	0.967	0.970	0.974	0.977	0.980	0.984	0.988	0.991	0.994	0.997	1.000	1.004	1.007	1.011	1.014	1.018	1.021	1.025
56	0.962	0.966	0.969	0.973	0.976	0.979	0.982	0.986	0.990	0.993	0.996	1.000	1.003	1.007	1.010	1.014	1.017	1.021	1.024	1.028
55	0.965	0.968	0.972	0.975	0.979	0.982	0.985	0.989	0.993	0.996	0.999	1.002	1.006	1.009	1.013	1.016	1.020	1.023	1.027	1.030
54	0.967	0.970	0.974	0.977	0.981	0.984	0.988	0.991	0.995	0.998	1.001	1.005	1.008	1.012	1.015	1.019	1.022	1.026	1.029	1.033

TEMPERATURE °F.

TABLE III.—FACTORS FOR REDUCTION OF GAS VOLUME TO 60° F. AND 30 IN. OF MERCURY PRESSURE AND SATURATION WITH MOISTURE.—(Continued)

		BAROMETER																			
		28.6	28.7	28.8	28.9	29.0	29.1	29.2	29.3	29.4	29.5	29.6	29.7	29.8	29.9	30.0	30.1	30.2	30.3	30.4	30.5
53	0.969	0.973	0.976	0.980	0.983	0.986	0.990	0.993	0.997	1.000	1.004	1.007	1.011	1.014	1.018	1.021	1.025	1.028	1.031	1.034	1.038
52	0.971	0.975	0.978	0.982	0.985	0.989	0.992	0.996	0.999	1.003	1.006	1.010	1.013	1.017	1.020	1.024	1.027	1.031	1.034	1.037	1.040
51	0.974	0.977	0.981	0.984	0.988	0.991	0.995	0.998	1.002	1.005	1.009	1.012	1.016	1.019	1.023	1.026	1.030	1.033	1.037	1.041	1.044
50	0.976	0.980	0.983	0.987	0.990	0.994	0.997	1.001	1.004	1.008	1.011	1.015	1.018	1.022	1.025	1.029	1.033	1.036	1.040	1.043	1.046
49	0.979	0.982	0.986	0.989	0.993	0.996	1.000	1.003	1.007	1.010	1.014	1.017	1.021	1.024	1.028	1.031	1.035	1.038	1.042	1.045	1.048
48	0.981	0.985	0.988	0.992	0.995	0.999	1.002	1.006	1.009	1.013	1.016	1.020	1.023	1.027	1.030	1.034	1.038	1.041	1.045	1.048	1.052
47	0.984	0.987	0.991	0.994	0.998	1.001	1.005	1.008	1.012	1.015	1.019	1.022	1.026	1.029	1.033	1.036	1.040	1.043	1.046	1.050	1.053
46	0.986	0.990	0.993	0.997	1.000	1.004	1.007	1.011	1.014	1.018	1.021	1.025	1.029	1.032	1.036	1.040	1.043	1.046	1.050	1.053	1.057
45	0.989	0.992	0.996	0.999	1.003	1.006	1.010	1.013	1.017	1.020	1.024	1.027	1.031	1.034	1.038	1.041	1.045	1.048	1.052	1.055	1.059
44	0.991	0.994	0.998	1.001	1.005	1.008	1.012	1.015	1.019	1.022	1.026	1.029	1.033	1.036	1.040	1.043	1.046	1.050	1.053	1.057	1.060
43	0.993	0.997	1.001	1.004	1.008	1.011	1.015	1.018	1.022	1.025	1.029	1.032	1.036	1.039	1.043	1.046	1.050	1.053	1.057	1.060	1.064
42	0.995	0.999	1.003	1.006	1.010	1.013	1.017	1.020	1.024	1.027	1.031	1.034	1.038	1.041	1.045	1.049	1.052	1.056	1.059	1.063	1.066
41	0.998	1.001	1.005	1.009	1.012	1.016	1.019	1.023	1.026	1.030	1.034	1.037	1.041	1.044	1.048	1.051	1.055	1.058	1.062	1.065	1.069
40	1.000	1.004	1.007	1.011	1.014	1.018	1.021	1.025	1.028	1.032	1.036	1.039	1.043	1.046	1.050	1.053	1.057	1.060	1.064	1.068	1.071
39	1.002	1.006	1.010	1.013	1.017	1.020	1.024	1.028	1.031	1.035	1.038	1.042	1.045	1.049	1.052	1.056	1.059	1.063	1.066	1.070	1.073
38	1.005	1.009	1.012	1.016	1.020	1.023	1.027	1.030	1.034	1.037	1.041	1.044	1.048	1.051	1.055	1.058	1.062	1.065	1.069	1.073	1.076
37	1.007	1.011	1.015	1.018	1.022	1.025	1.029	1.032	1.036	1.039	1.043	1.046	1.050	1.053	1.057	1.060	1.064	1.068	1.072	1.076	1.079
36	1.009	1.013	1.017	1.020	1.024	1.027	1.031	1.035	1.038	1.042	1.045	1.049	1.052	1.056	1.060	1.063	1.067	1.071	1.074	1.078	1.081
35	1.012	1.015	1.019	1.022	1.026	1.030	1.033	1.037	1.041	1.044	1.048	1.051	1.055	1.058	1.062	1.065	1.069	1.073	1.077	1.081	1.083
34	1.014	1.018	1.022	1.025	1.029	1.032	1.036	1.040	1.043	1.047	1.050	1.054	1.057	1.061	1.064	1.068	1.072	1.075	1.079	1.083	1.086
33	1.016	1.020	1.024	1.027	1.031	1.034	1.038	1.042	1.046	1.049	1.053	1.056	1.060	1.063	1.067	1.070	1.074	1.078	1.082	1.085	1.089
32	1.019	1.023	1.027	1.030	1.034	1.037	1.041	1.044	1.048	1.051	1.055	1.058	1.062	1.066	1.069	1.073	1.077	1.081	1.085	1.089	1.093
31	1.021	1.025	1.029	1.032	1.036	1.039	1.043	1.047	1.050	1.054	1.057	1.061	1.064	1.068	1.072	1.075	1.079	1.083	1.087	1.091	1.095
30	1.023	1.027	1.031	1.034	1.038	1.042	1.045	1.049	1.053	1.056	1.060	1.063	1.067	1.071	1.074	1.078	1.082	1.086	1.090	1.094	1.098

TEMPERATURE °F.

SATURATION WITH MOISTURE.—(Continued)

BAROMETER

	28.6	28.7	28.8	28.9	29.0	29.1	29.2	29.3	29.4	29.5	29.6	29.7	29.8	29.9	30.0	30.1	30.2	30.3	30.4	30.5
80	0.901	0.904	0.907	0.910	0.914	0.917	0.920	0.923	0.927	0.930	0.933	0.937	0.940	0.943	0.946	0.950	0.954	0.957	0.960	0.963
79	0.904	0.907	0.910	0.914	0.917	0.920	0.923	0.926	0.929	0.933	0.936	0.939	0.943	0.946	0.949	0.953	0.956	0.960	0.963	0.967
78	0.906	0.909	0.913	0.916	0.919	0.923	0.926	0.929	0.932	0.936	0.939	0.942	0.946	0.949	0.952	0.956	0.959	0.962	0.966	0.969
77	0.909	0.912	0.915	0.919	0.922	0.925	0.928	0.931	0.935	0.938	0.942	0.945	0.948	0.951	0.955	0.958	0.962	0.965	0.968	0.972
76	0.911	0.915	0.918	0.921	0.925	0.928	0.931	0.935	0.938	0.941	0.944	0.948	0.951	0.954	0.958	0.961	0.964	0.968	0.971	0.975
75	0.914	0.917	0.921	0.924	0.928	0.931	0.934	0.937	0.940	0.943	0.947	0.950	0.954	0.957	0.960	0.963	0.967	0.971	0.974	0.978
74	0.917	0.920	0.924	0.927	0.930	0.933	0.937	0.940	0.943	0.947	0.950	0.953	0.957	0.960	0.963	0.966	0.970	0.973	0.977	0.980
73	0.920	0.923	0.926	0.930	0.933	0.936	0.940	0.943	0.946	0.949	0.953	0.956	0.960	0.963	0.966	0.969	0.972	0.976	0.980	0.983
72	0.922	0.925	0.929	0.932	0.935	0.939	0.942	0.945	0.949	0.952	0.955	0.959	0.962	0.965	0.968	0.972	0.975	0.979	0.982	0.986
71	0.925	0.928	0.931	0.935	0.938	0.941	0.945	0.948	0.951	0.954	0.958	0.961	0.965	0.968	0.971	0.975	0.978	0.981	0.985	0.989
70	0.927	0.931	0.934	0.937	0.941	0.944	0.947	0.950	0.954	0.957	0.960	0.964	0.967	0.970	0.974	0.977	0.980	0.984	0.988	0.991
69	0.930	0.933	0.937	0.940	0.944	0.947	0.950	0.953	0.957	0.960	0.963	0.967	0.970	0.973	0.977	0.980	0.983	0.987	0.990	0.994
68	0.932	0.936	0.939	0.942	0.946	0.949	0.952	0.956	0.959	0.962	0.966	0.969	0.972	0.975	0.979	0.983	0.986	0.989	0.993	0.997
67	0.935	0.938	0.942	0.945	0.949	0.952	0.955	0.959	0.962	0.965	0.968	0.972	0.975	0.979	0.982	0.985	0.989	0.992	0.996	1.000
66	0.938	0.941	0.944	0.948	0.951	0.954	0.958	0.961	0.964	0.968	0.971	0.974	0.978	0.981	0.985	0.988	0.992	0.995	0.998	1.002
65	0.941	0.944	0.947	0.950	0.954	0.957	0.960	0.963	0.967	0.970	0.973	0.977	0.980	0.984	0.987	0.991	0.994	0.997	1.001	1.005
64	0.943	0.946	0.949	0.953	0.956	0.959	0.963	0.966	0.969	0.973	0.976	0.980	0.983	0.986	0.990	0.994	0.997	1.000	1.004	1.008
63	0.945	0.949	0.952	0.955	0.959	0.962	0.965	0.969	0.972	0.975	0.979	0.982	0.985	0.989	0.993	0.996	1.000	1.003	1.006	1.010
62	0.947	0.951	0.954	0.958	0.961	0.964	0.968	0.971	0.975	0.978	0.981	0.985	0.988	0.991	0.995	0.999	1.002	1.005	1.009	1.013
61	0.950	0.954	0.957	0.961	0.964	0.967	0.971	0.974	0.977	0.981	0.984	0.987	0.991	0.994	0.998	1.001	1.005	1.008	1.011	1.015
60	0.952	0.956	0.959	0.963	0.966	0.969	0.973	0.976	0.980	0.983	0.986	0.990	0.993	0.997	1.000	1.004	1.007	1.010	1.014	1.017
59	0.955	0.959	0.962	0.966	0.969	0.972	0.976	0.979	0.983	0.986	0.989	0.992	0.995	0.998	1.003	1.006	1.010	1.013	1.016	1.020
58	0.957	0.961	0.964	0.968	0.971	0.975	0.978	0.981	0.985	0.988	0.992	0.995	0.998	1.002	1.005	1.009	1.012	1.015	1.019	1.023
57	0.960	0.963	0.967	0.970	0.974	0.977	0.980	0.984	0.988	0.991	0.994	0.997	1.001	1.004	1.007	1.011	1.014	1.018	1.021	1.025
56	0.962	0.966	0.969	0.973	0.976	0.979	0.982	0.986	0.990	0.993	0.996	1.000	1.003	1.007	1.010	1.014	1.017	1.021	1.024	1.028
55	0.965	0.968	0.972	0.975	0.979	0.982	0.985	0.989	0.993	0.996	0.999	1.002	1.006	1.009	1.013	1.016	1.020	1.023	1.027	1.030
54	0.967	0.970	0.974	0.977	0.981	0.984	0.988	0.991	0.995	0.998	1.001	1.005	1.008	1.012	1.015	1.019	1.022	1.026	1.029	1.033

TEMPERATURE °F

TABLE IV.—RELATIVE HUMIDITY.—(Continued)
All temperatures in Fahrenheit degrees.

Air temp.		Depression of wet bulb thermometer (t-t')																												
		26	27	28	29	30	31	32	33	34	35	36	37	38	39	40	41	42	43	44	45	46	47	48	49	50				
75	8																													
80	13	11	8	2																										
85	18	16	13	8	6																									
90	22	20	18	16	14	11	9	7	5	3																				
95	26	24	22	20	18	16	14	12	10	8	6	4	2																	
100	29	27	25	23	21	19	18	16	14	12	10	9	7	6	3	2	1													
105	32	30	28	26	24	22	21	19	17	16	14	13	11	9	7	6	4	3	1											
110	34	32	30	29	27	25	24	22	20	19	17	16	14	13	11	10	8	7	5	4	3	2								
115	36	34	33	31	29	28	26	25	24	22	20	19	17	16	14	13	12	10	9	7	6	5	4	3	1					
120	38	36	35	33	31	30	28	27	25	24	22	21	19	17	16	15	13	12	10	9	8	7	6	5	4	3	2	1		

TABLE V.—CORRECTIONS, IN B.t.u., TO BE APPLIED TO OBSERVED HEATING VALUES IN CALCULATING TOTAL HEATING VALUES OF ILLUMINATING GAS (ABOUT 600 B.t.u.)¹

(The tabular corrections are applicable when inlet water, air, gas, and products are all at approximately the same temperature, and when the calorimeter is operated at *normal rate* of gas consumption. For definition of *normal rate*, see p. 101.)

Temperature of room, etc. deg. F.	Relative humidity of air									
	10 per cent.	20 per cent.	30 per cent.	40 per cent.	50 per cent.	60 per cent.	70 per cent.	80 per cent.	90 per cent.	100 per cent.
40	+ 2	+ 2	+ 1	+1	+1	+1	0	0	0	-1
45	+ 2	+ 2	+ 2	+1	+1	+1	0	0	0	-1
50	+ 3	+ 3	+ 2	+2	+1	+1	0	0	0	-1
55	+ 3	+ 3	+ 3	+2	+1	+1	+1	0	0	-1
60	+ 4	+ 4	+ 3	+2	+2	+1	+1	0	0	-1
65	+ 5	+ 4	+ 4	+3	+2	+2	+1	0	-1	-1
70	+ 6	+ 5	+ 4	+3	+3	+2	+1	0	-1	-2
75	+ 7	+ 6	+ 5	+4	+3	+2	+1	0	-1	-2
80	+ 8	+ 7	+ 6	+5	+4	+3	+1	0	-1	-2
85	+10	+ 9	+ 7	+6	+4	+3	+2	0	-1	-3
90	+12	+10	+ 9	+7	+5	+4	+2	0	-2	-3
95	+14	+12	+10	+8	+6	+4	+2	0	-2	-4

¹ Technologic Paper 36, Bureau of Standards.

TABLE VI.—CORRECTIONS, IN B.t.u., TO BE APPLIED TO OBSERVED HEATING VALUES IN CALCULATING TOTAL HEATING VALUES OF NATURAL GAS (ABOUT 1000 B.t.u.)¹

(The tabular corrections are applicable when inlet water, air, gas, and products are all at approximately the same temperature, and when the calorimeter is operated at *normal rate* of gas consumption. For definition of *normal rate*, see p. 101.)

Temperature of room, etc., deg. F.	Relative humidity of air									
	10 per cent.	20 per cent.	30 per cent.	40 per cent.	50 per cent.	60 per cent.	70 per cent.	80 per cent.	90 per cent.	100 per cent.
40	+ 4	+ 3	+ 3	+ 2	+ 2	+1	+1	0	0	-1
45	+ 4	+ 4	+ 3	+ 3	+ 2	+1	+1	0	0	-1
50	+ 5	+ 5	+ 4	+ 3	+ 3	+2	+1	0	0	-1
55	+ 6	+ 6	+ 5	+ 4	+ 3	+2	+1	0	-1	-1
60	+ 8	+ 7	+ 6	+ 4	+3	+2	+1	0	-1	-2
65	+ 9	+ 8	+ 7	+ 5	+ 4	+3	+2	0	-1	-2
70	+11	+ 9	+ 8	+ 6	+ 5	+3	+2	+1	-1	-2
75	+13	+11	+10	+ 8	+ 6	+4	+3	+1	-1	-3
80	+15	+13	+11	+ 9	+ 7	+5	+3	+1	-1	-3
85	+18	+16	+13	+11	+ 9	+6	+4	+1	-2	-4
90	+21	+19	+16	+13	+10	+7	+4	+1	-2	-5
95	+25	+22	+19	+15	+12	+8	+5	+1	-2	-6

¹ Technologic Paper 36, Bureau of Standards.

TABLE VII¹.—EMERGENT STEM CORRECTIONS TO READING OF OUTLET-WATER THERMOMETERS FOR DIFFERENT IMMERSIONS OF THERMOMETERS IN CALORIMETER FOR DETERMINING HEATING VALUE OF GAS

(Table applicable when temperature of inlet water is approximately equal to room temperature.)

	Temperature rise of water, deg. F.	Temperature of room					
		50°	60°	70°	80°	90°	100°
Thermometer immersed to 30° F. . .	10	+0.02	+0.03	+0.04	+0.05	+0.05	+0.06
	15	+0.04	+0.05	+0.06	+0.07	+0.09	+0.10
	20	+0.06	+0.07	+0.09	+0.11	+0.13	+0.15
Thermometer immersed to 40° F. . .	10	+0.01	+0.02	+0.03	+0.03	+0.04	+0.05
	15	+0.03	+0.04	+0.05	+0.06	+0.08	+0.09
	20	+0.04	+0.05	+0.07	+0.09	+0.11	+0.12
Thermometer immersed to 50° F. . .	10	+0.01	+0.01	+0.02	+0.03	+0.04	+0.05
	15	+0.02	+0.03	+0.04	+0.05	+0.07	+0.08
	20	+0.02	+0.04	+0.06	+0.07	+0.09	+0.11
Thermometer immersed to 60° F. . .	10	+0.00	+0.01	+0.02	+0.02	+0.03	+0.04
	15	+0.00	+0.01	+0.03	+0.04	+0.05	+0.06
	20	+0.00	+0.02	+0.04	+0.05	+0.07	+0.09

This table is not applicable if the emergent portion of the stem includes an enlargement in the capillary.

Instead of using the above table, it will probably be somewhat more convenient to make out a stem-correction table for the particular outlet-water thermometer that is to be used with the calorimeter, the data for this separate stem-correction table being interpolated from the above table.

Suppose, for example, the outlet-water thermometer to be used was one that was immersed to the 30° F. mark on the scale, and a stem-correction table were wanted for an 18° F. rise in temperature, then from the above table we obtain the following stem-correction table:

STEM CORRECTION FOR OUTLET-WATER THERMOMETER NO.—

(Table applicable when inlet water is approximately at room temperature, when thermometer is immersed to the 30° F. mark, and when the temperature rise is approximately 18° F.)

Inlet-water temperature, deg. F.	Stem correction, deg.	Inlet-water temperature, deg. F.	Stem correction, deg.
50	0.05	80	0.09
60	0.06	90	0.11
70	0.08	100	0.13

¹ From Circular 48, Bureau of Standards.

In the same way a table could be made out for any outlet-water thermometer by interpolation in the general table. The table so prepared would apply for the particular point to which the thermometer was immersed and for the particular rise in temperature with which the observer had chosen to work.

TABLE VIII.—CORRECTIONS FOR DIFFERENCE BETWEEN INLET-WATER TEMPERATURE AND ROOM TEMPERATURE IN DETERMINING HEATING VALUE OF GAS

(In this table are given the data from which to determine the amounts by which the total and the net heating values, calculated from the observed heating value as if the inlet water had been at room temperature, must be corrected on account of any difference in temperature between inlet water and room. The correction calculated from this table may be applied without sensible error to heating values of illuminating gas of about 600 B.t.u. as determined with any of the flow calorimeters listed in this circular except the Doherty calorimeter. The correction is added if the inlet water is warmer than the room; subtracted if the inlet water is colder. In calculating the observed heating value, the stem corrections to both the inlet and outlet water thermometers must be taken into account when the inlet-water temperature differs from room temperature.)

Room temperature, deg. F.	Corrections in B.t.u. per 1° F.	
	For calculating total heating value	For calculating net heating value
50	0.5	0.4
60	0.6	0.4
70	0.7	0.4
80	0.8	0.4
90	0.9	0.5
100	1.0	0.5

¹ From Circular 48, Bureau of Standards.

TABLE IX.—A TABLE OF CONSTANTS FOR CERTAIN GASES AND VAPORS¹

The temperature of products of combustion is reduced to 18° C. = 64.4° F.

All volumes of gases and vapors are given at 60° F. and 30" pressure.

I Name of gas or vapor	II Formula	III Molecular weight	IV Sp. gravity gas or vapor at 60° F. air = 1.0	V Boiling point in deg. F.	VI Sp. gravity liquid at 60° F. water = 1.0	VII Sp. heat eq. wts. at const. pr. water = 1.0	VIII Cubic feet per pound	IX Weight, 1 cubic foot in pounds	X Calorific value		XII Per lb.
									British thermal units		
									Heat of combustion		
									per molecu-	per cu. ft.	
									lar wt. in		
									grams		
Carbon to CO	C	24	0.8202				15.749	0.08350	29,000	276.2	4,250
Carbon to CO ₂	C	24	0.8202				15.749	0.08350	69,960	615.5	14,540
Carbon to O ₂	CO	28	0.9671				13.553	0.07507	66,960	358.5	8,168
Hydrogen	H ₂	2	0.0692			0.2450	158.550	0.04570	68,360	358.2	8,168
Methane	CH ₄	16	0.5529			0.5829	23.626	0.07634	21,430	1,000.0	23,938
Ethane	C ₂ H ₆	30	1.0368	-13°			12.284	0.07640	27,240	574.4	23,938
Propane	C ₃ H ₈	44	1.5208	+33°			8.587	0.11655	52,240	372.1	21,451
Butane	C ₄ H ₁₀	58	2.0048	+100°			5.514	0.15050	87,110	257.1	21,326
Pentane	C ₅ H ₁₂	72	2.4883	+100°			4.233	0.20765	96,200	4,054.8	21,377
Hexane	C ₆ H ₁₄	86	2.9721	+156°			3.395	0.27410	332,300	4,759.8	20,914
Ethylene	C ₂ H ₄	28	0.9676			0.4040	13.395	0.07110	452,740	5,358.0	21,320
Propylene	C ₃ H ₆	42	1.4514				8.777	0.11820	182,740	3,097.2	21,320
Butylene	C ₄ H ₈	56	1.9353	+23°			5.265	0.14820	637,630	3,096.2	20,913
Acetylene	C ₂ H ₂	26	0.8984	+102°			16.334	0.08825	310,060	3,476.7	21,465
Alylene	C ₂ H ₄	40	1.3823				8.495	0.10285	467,550	2,227.1	21,040
Acetylene series	CH ₂ n	54	1.8661	+64°			6.995	0.12980			
Propylene series	C ₃ H ₆ n	78	2.8493	+177°		0.3754	4.945	0.20640	700,350	3,807.5	18,447
Butylene series	C ₄ H ₈ n	102	3.8325	+230°		0.3720	3.705	0.23345	955,680	4,552.0	18,689
Aromatic Series	C ₆ H ₆ n	106	3.6630	+287°		0.8692	3.165	0.26055			
CaH ₂ n series	C ₆ H ₆ n	120	4.1468	+326°			2.659	0.31755	1,282,310	6,108.0	19,235
Methylene	CH ₂	14	0.5714	+424.4°		1.1517	8.095	0.09010	140,900	673.2	7,450
Napthalene	C ₁₀ H ₈	128	4.4230				22.178	0.04509	60,650	432.8	9,598
Hydrogen sulphide	H ₂ S	34	1.1769			0.2433	13.668	0.07159	159,620	737.0	10,775
Ammonia	NH ₃	17	0.5888			0.5083	17.258	0.07779	260,620	1,238.2	8,986
Cyanogen	C ₂ N ₂	52	1.8000				4.665	0.20139	265,130	1,264.2	6,270
Carbon di-sulphide	CS ₂	76	2.6298	+114.8°			11.745	0.08516	182,230	873.0	10,250
Methyl alcohol	CH ₃ O	32	1.1121	+131.2°		0.8027	8.516	0.13172	340,530	1,622.0	13,225
Ethyl alcohol	C ₂ H ₅ O	46	1.5804	+172.9°		0.7946	8.203	0.11637			
Carbonic acid	CO ₂	44	1.5195			1.4534	8.516	0.11637			
V. aer.	H ₂ O	18	0.6217	+212°		1.0000	21.004	0.04761			
Sulphur dioxide	SO ₂	64	2.2128			0.1553	5.904	0.16949			
Oxygen	O ₂	32	1.1052			0.2174	11.816	0.08465			
Nitrogen	N ₂	28	0.9701			0.2438	13.460	0.07428			
Air			1.0000			0.2374	13.059	0.07658			

¹ Calculated for C₂ as a gas.
² From Gas Chemists Handbook of American Gas Institute. Data from United Gas Improvement Co.

TABLE IX.—A TABLE FOR CONSTANTS OF CERTAIN GASES AND VAPORS.—(Continued.)

All volumes of gases and vapors are given at 60° F. and 30" pressure. The temperature of products of combustion is reduced to 18° C. = 64.4° F.

XIII	XIV	XV	XVI	XVII	XVIII	XIX	XX	XXI	XXII	Heat of formation at const. pres.			Name gas or vapor	
										XXIII	XXIV	XXV		XXVI
Cu. ft. per cu. ft. of combustible											B.t.u.			
Req. for combustion			Products of combustion			Pounds per pound of combustible			Calories per molecular wt. in grams			Per cu. ft.		Per pound
Air	Oxygen	CO ₂	CO	H ₂ O	Air	Oxygen	CO ₂	CO	H ₂ O	CO—2.333+				
4.785	1.0	2.0	2.0	5.771	1.333+	2.666+	3.666+	9.000	CO—2.333+	21,750	+138.4	+1869.2	Carbon, to CO	
9.570	2.0	1.0	1.0	11.541	2.666+	2.666+	1.571	9.000	CO—2.333+	35,560	+103.1	+2435.6	Carbon, to CO ₂	
2.393	0.5	1.0	1.0	2.471	8.000	8.000	2.750	2.250	CO—2.333+	35,560	+136.0	+1713.6	Carbonic oxide	
9.570	2.0	1.0	3.0	34.624	3.733	3.733	2.933	1.800	CO—2.333+	35,560	+167.2	+1436.3	Hydrogen	
16.748	3.5	2.0	3.0	17.312	3.636	3.636	3.000	1.636	CO—2.333+	42,450	+202.2	+1713.6	Methane	
23.925	5.0	3.0	4.0	15.737	3.586	3.586	3.034	1.552	CO—2.333+	47,850	+227.9	+1317.3	Ethane	
31.103	6.5	4.0	5.0	15.329	3.555	3.555	3.055	1.500	CO—2.333+	61,080	+290.9	+1196.2	Propane	
38.290	8.0	5.0	6.0	15.386	3.554	3.554	3.069	1.465	CO—2.333+	2,710	+127.4	+1278.4	Butane	
45.458	9.5	6.0	7.0	15.295	3.428	3.428	3.142	1.286	CO—2.333+	3,220	+12.9	+1278.4	Pentane	
14.355	3.0	2.0	2.0	14.836	3.428	3.428	3.142	1.286	CO—2.333+	10,660	+15.3	+1278.4	Hexane	
21.533	4.5	3.0	3.0	14.836	3.428	3.428	3.142	1.286	CO—2.333+	18,970	+113.7	+1278.4	Ethylene	
28.710	6.0	4.0	4.0	14.836	3.428	3.428	3.142	1.286	CO—2.333+	47,770	+188.8	+1278.4	Propylene	
35.888	7.5	5.0	5.0	14.836	3.428	3.428	3.142	1.286	CO—2.333+	12,510	+47.3	+1278.4	Butylene	
11.963	2.5	2.0	1.0	13.313	3.076	3.076	3.384	0.692	CO—2.333+	3,520	+16.7	+1278.4	Acetylene	
19.140	4.0	3.0	2.0	13.850	3.259	3.259	3.300	1.300	CO—2.333+	490	+2.3	+1278.4	Allylene	
26.318	5.5	3.0	3.0	14.105	3.076	3.076	3.384	0.782	CO—2.333+	4,740	+22.6	+1278.4	Crotonylene	
35.888	7.5	6.0	4.0	13.313	3.130	3.130	3.348	0.849	CO—2.333+	11,890	+56.7	+1278.4	Benzene	
43.065	9.0	7.0	4.0	13.547	3.130	3.130	3.311	0.849	CO—2.333+	27,480	+131.1	+1278.4	Toluene	
50.243	10.5	8.0	5.0	13.720	3.170	3.170	3.311	0.849	CO—2.333+	65,700	+124.0	+1278.4	Xylene	
57.420	12.0	9.0	6.0	13.850	3.200	3.200	3.300	0.900	CO—2.333+	85,000	+124.0	+1278.4	Meatylene	
57.420	12.0	10.0	6.0	12.984	3.000	3.437	3.437	0.563	CO—2.333+	1,883	+2.6	+1278.4	Naphthalene	
7.178	1.5	1.0	1.0	6.111	1.412	1.412	1.630	0.529	CO—2.333+	518	+22.6	+1278.4	Hydrogen sulphide	
3.589	0.75	1.0	0.5	6.111	1.412	1.412	1.630	0.529	CO—2.333+	518	+56.7	+1278.4	Ammonia	
5.981	1.25	1.0	0.5	6.410	1.481	1.481	1.692	0.333	CO—2.333+	1,684	+22.6	+1278.4	Hydrocyanic acid	
9.570	2.0	2.0	1.0	5.323	1.230	1.230	1.579	0.333	CO—2.333+	1,684	+22.6	+1278.4	Cyanogen	
14.355	3.0	1.0	1.0	5.466	1.263	1.263	1.375	1.125	CO—2.333+	1,684	+22.6	+1278.4	Carbon bi-sulphide	
7.178	1.5	1.0	2.0	6.492	1.500	1.500	1.375	1.174	CO—2.333+	1,684	+22.6	+1278.4	Methyl alcohol	
14.355	3.0	2.0	3.0	9.033	2.087	2.087	1.913	1.174	CO—2.333+	1,684	+22.6	+1278.4	Ethyl alcohol	
14.355	3.0	2.0	3.0	9.033	2.087	2.087	1.913	1.174	CO—2.333+	1,684	+22.6	+1278.4	Carbonic acid	
14.355	3.0	2.0	3.0	9.033	2.087	2.087	1.913	1.174	CO—2.333+	1,684	+22.6	+1278.4	Water	
14.355	3.0	2.0	3.0	9.033	2.087	2.087	1.913	1.174	CO—2.333+	1,684	+22.6	+1278.4	Sulphur dioxide	
14.355	3.0	2.0	3.0	9.033	2.087	2.087	1.913	1.174	CO—2.333+	1,684	+22.6	+1278.4	Oxygen	
14.355	3.0	2.0	3.0	9.033	2.087	2.087	1.913	1.174	CO—2.333+	1,684	+22.6	+1278.4	Air	

TABLE X.—MEAN SPECIFIC HEATS OF GASES AT CONSTANT PRESSURE IN B.T.U. PER CUBIC FOOT AT 60° F. AND 30 IN. OF MERCURY CALCULATED FOR THE INTERVAL

60° F.—T

T, deg. F.	Carbon dioxide	Water vapor	Nitrogen, oxygen and other diatomic gases
200	0.0237	0.0220	0.0174
400	0.0246	0.0220	0.0175
600	0.0253	0.0221	0.0177
800	0.0260	0.0222	0.0178
1000	0.0268	0.0224	0.0180
1200	0.0275	0.0226	0.0181
1400	0.0282	0.0229	0.0183
1600	0.0287	0.0232	0.0184
1800	0.0292	0.0236	0.0186
2000	0.0298	0.0240	0.0187
2200	0.0302	0.0245	0.0189
2400	0.0306	0.0250	0.0190
2600	0.0309	0.0256	0.0192
2800	0.0312	0.0263	0.0194
3000	0.0314	0.0270	0.0196
3500	0.0317	0.0288	0.0201
4000	0.0319	0.0312	0.0206

TABLE XI.—MEAN SPECIFIC HEATS OF GASES AT CONSTANT PRESSURE IN B.T.U. PER POUND CALCULATED FOR THE INTERVAL 60° F.—T

T	Carbon dioxide	Water vapor	Nitrogen
200° F.	0.2067	0.4653	0.2365
400° F.	0.2143	0.4657	0.2386
600° F.	0.2216	0.4673	0.2407
800° F.	0.2285	0.4698	0.2428
1000° F.	0.2348	0.4735	0.2449
1200° F.	0.2406	0.4782	0.2470
1400° F.	0.2462	0.4841	0.2491
1600° F.	0.2512	0.4910	0.2512
1800° F.	0.2559	0.4990	0.2534
2000° F.	0.2601	0.5081	0.2555
2200° F.	0.2638	0.5182	0.2576
2400° F.	0.2670	0.5294	0.2597
2600° F.	0.2698	0.5420	0.2618
2800° F.	0.2722	0.5557	0.2639
3000° F.	0.2742	0.5702	0.2660
3500° F.	0.2770	0.6093	0.2707
4000° F.	0.2790	0.6599	0.2755

TABLE XII.—VOLUME OF WATER VAPORS TAKEN UP BY ONE CUBIC FOOT OF AIR WHEN SATURATED AT VARIOUS TEMPERATURES

Temperature	Cubic feet of water vapor
0° F.	0.001
12° F.	0.002
22° F.	0.004
32° F.	0.006
42° F.	0.009
52° F.	0.013
62° F.	0.019
72° F.	0.027
82° F.	0.038
92° F.	0.053
102° F.	0.073

TABLE XIII.—COMPARISON OF THE BAUME SCALE FOR LIQUIDS LIGHTER THAN WATER AND SPECIFIC GRAVITIES

Degrees Baumé	Specific gravity	Degrees Baumé	Specific gravity	Degrees Baumé	Specific gravity
10	1.0000	36	0.8433	62	0.7290
11	0.9929	37	0.8383	63	0.7253
12	0.9859	38	0.8333	64	0.7216
13	0.9790	39	0.8284	65	0.7179
14	0.9722	40	0.8235	66	0.7142
15	0.9655	41	0.8187	67	0.7106
16	0.9589	42	0.8139	68	0.7070
17	0.9523	43	0.8092	69	0.7035
18	0.9459	44	0.8045	70	0.7000
19	0.9395	45	0.8000	71	0.6965
20	0.9333	46	0.7954	72	0.6931
21	0.9271	47	0.7909	73	0.6897
22	0.9210	48	0.7865	74	0.6863
23	0.9150	49	0.7821	75	0.6829
24	0.9090	50	0.7777	76	0.6796
25	0.9032	51	0.7734	77	0.6763
26	0.8974	52	0.7692	78	0.6731
27	0.8917	53	0.7650	79	0.6699
28	0.8860	54	0.7608	80	0.6667
29	0.8805	55	0.7567	81	0.6635
30	0.8750	56	0.7526	82	0.6604
31	0.8695	57	0.7486	83	0.6573
32	0.8641	58	0.7446	84	0.6542
33	0.8588	59	0.7407	85	0.6512
34	0.8536	60	0.7368	90	0.6364
35	0.8484	61	0.7329	95	0.6222

SUBJECT INDEX

- Absorption methods in gas analysis, 28-42
- Acetylene,
absorption of, 85
inhibiting reaction between phosphorus and oxygen, 32
solubility in water, 85
- Adiabatic coal calorimeters, 279
- Air and water vapor, table of volumes, 304
- Air,
determination of relative humidity, 113
dissolved in water, change in composition, 7
required for combustion of one pound carbon, 150
impure affecting candle power, 136
- Alcohol as fuel, see liquid fuel
- Alkaline pyrogallate, reagent for oxygen, 33
- Ammonia, estimation in illuminating gas, 179
- Ammoniacal copper solution as reagent for oxygen, 35
- Amyl acetate for photometric purposes, 125
- Analysis, see coal, gas, etc.
- Argand gas burners, 128
- Argon group of gases, 91
- Ash in coal, composition, 230
corrected, 257
standard method of analysis, 245
- Aspirators, 5
- Automatic instruments for analyzing chimney gases, 72
- Bar photometer, 120, 132
- Barium hydroxide as reagent for carbon dioxide, 84
- Baumé scale for liquids lighter than water, table, 304
- Benzene in illuminating gas, 166
and light oils in illuminating gas, 167
inhibiting reaction between phosphorus and oxygen, 32
- Benzoic acid as standard in calorimetry, 278
- Blast furnace gases, sampling, 144
- Bomb calorimeter, 258
see also heating value of coal
- British thermal unit defined, 104
- Bromine water reagent, 29
- Bulbed gas burette for exact analysis, 79
- Bunte's gas burette, 68
- Burners, standard gas, 128
- Calculation of candle power, 135
of explosion analysis, 49, 50
of heat lost in chimney gases, 150
of heating value of coal, 273
of heating value of gas, 103, 107, 117
of volume of chimney gases, 146, 149
- Calibration of gas burette, 22, 83
of gas meter, 94
- Calorimeter, see heating value,
for coal, 258
for gases, 97
for oils, 190
- Calory, definition of, 104
- Candle power, accuracy of photometric work, 137
atmospheric conditions influencing, 137
bar photometer, 120
Bray's burner, 129
Bunsen screen, 129

- Candle power, calculation, 135
 candle balance, 123
 candles as standards, 122
 decreasing significance of, 119
 details of a test, 134
 Edgerton standard, 127
 Elliot lamp, 127
 equipment of photometer bench, 132
 flicker photometer, 132
 gas meter, 132
 Harcourt lamp, 126
 Hefner lamp, 123
 humidity of air, 136
 impure air, 137
 incandescent electric standard, 121
 jet photometer, 137
 Leeson screen, 129
 Lummer-Brodhnm screen, 129
 method of rating, 120
 Metropolitan No. 2 burner, 129
 pentane lamp, 126
 photometer room, 136
 photometric units, 122
 photometer bench, 132
 saturating water of meter, 132
 secondary standards, 127
 setting flow of gas, 135
 solubility of illuminants, 132
 standard candles, 122
 standard gas burners, 128
 standard lights, 121
 Sugg D burners, 127
 table photometer, 121
 types of photometer, 119
 units, 120
- Capillary tube preventing explosion, 52
- Carbon in coal, method of determination, 251
- Carbon dioxide, determination of, 28
- Carbon dioxide, formation in chimney gases, 145
- Carbon dioxide, recording instruments for chimney gases, 72
- Carbon dioxide, specific heat, table, 303
- Carbon monoxide, causing change in blood, 86
 combustion with copper oxide, 56
 estimation of by acid cuprous chloride, 36
 estimation of by ammoniacal cuprous chloride, 38
 estimation of by iodine pentoxide, 86
 evolved from pyrogallate solution, 33
 explosion analysis, 50
 formation in chimney gases, 147
 fractional combustion with copper oxide, 56
 fractional combustion with pallodinitised, asbestos, 53
 hydrogen and methane, simultaneous explosion, 51
 initial combustion temperature, 56
 incomplete absorption, 37
 quiet combustion with oxygen, 51
 small quantities in air, 60
- Carbonates in coal ash, 230, 245
- Carbonic acid, see carbon dioxide
- Carbonic oxide, see carbon monoxide
- Carburetted water gas, composition, 165
- Caustic soda, reagent, 28
- Chemical analysis, see coal, gas, etc.
- Chimney gases, 144
 calculation for loss of heat in, 150
 calculation of volume changes, 146, 148
 carbon dioxide formation, 145
 carbon dioxide percentage, 154
 carbon monoxide, 154
 carbon monoxide formation, 147
 change in composition in contact with water, 7

- Chimney gases, continuous recording instruments for analysis of, 72
- effect of hydrogen in coal on composition, 145
- interpretation of analysis, 153
- loss of heat in, 150, 154
- loss of heat due to water vapor, 151
- nitrogen percentage, 154
- oxygen percentage, 154
- problem illustrating loss of heat in, 152
- sampling, 144
- solubility in water, 7
- specific heats, table, 303
- volume of air per pound of carbon, 148
- volume of, per pound of carbon, 148
- Chollar tubes for gas analysis, 70
- Clinkering properties of ash, 232
- Coal analysis, 222
- accuracy of results, 238
- air-drying, 223
- air-drying sample, 223
- ash composition, 230
- ash fusibility, 232
- ash, standard method for, 245
- carbon, total, 251
- combined water in, 151
- corrected ash, 257
- deterioration of samples, 227
- Eschka method for sulphur, 247
- fixed carbon, 232, 247
- fusibility of ash, 232
- grinding and preserving sample, 25
- hydrogen, 251
- method of reporting, 237
- moisture, 227
- moisture, standard method, 243
- nitrogen, 237
- nitrogen, standard method, 255
- oxygen, 237, 256
- phosphorus, 237
- phosphorus in ash, 250
- Coal analysis, preliminary examination of sample, 223
- preparation of laboratory samples, 240
- preservation of sample, 226
- proximate analysis, 222
- slate and pyrites, 239
- standard method, 240
- sulphur, 232
- sulphur, standard method, 247
- true coal, 238
- ultimate analysis, 236
- ultimate analysis, standard method, 251
- volatile matter, 228
- volatile matter, standard method, 245
- Coal, briquetting sample for bomb calorimeter, 262
- changes after mining, 211
- changes in air-drying, 224
- chemical analysis, see coal analysis
- combined water, percentage, 151
- difference in composition of lump and fine, 204
- effect of hydrogen in, on chimney gases, 145
- grinding, see coal sampling
- heating value of, see heating value
- washing, 239
- Coal gas, see gas analysis, heating value, candle power, etc.
- Coal sampling, 204
- accuracy, 211
- a scoopful as a sample, 207
- difference in composition of lump and fine coal, 204
- from cars, 209, 214
- from wagons, 209, 214
- grinding and preserving sample, 218, 227
- influence of slate, 208
- mine sampling, 209
- preparation of sample, 210, 215

- Coal sampling, preservation of sample, 210, 218
 reducing gross sample, 215
 reliability of samples, 221
 standard method, 214
 size of sample, 207, 215
 taking of sample, 209
 variation in results, 211
 washing, 239
- Coal tar, see liquid fuels,
- Coke, chemical analysis, 220, 257
- Coke, sampling, 219
 specification of chemical composition, 221
 standard method for chemical analysis, 257
 standard method of laboratory sampling, 257
- Coke oven gas, composition, 165
- Colorimetric tar determination, 142
- Combustion, see gas analysis, chimney gas, producer, gas, etc.
 tabular data on volumes, heats, etc., 302
- Constants of gases and vapors, table, 301, 302
- Continuous recording instruments for analyzing chimney gases, 72
- Conversion factors for heating value of gas, 104
- Copper oxide method of fractional combustion, 56
- Copper solution, ammoniacal as reagent for oxygen, 35
- Corrections in gas volume for temperature and pressure, 75, 95, 291, 292-5
- Cuprous chloride,
 acid solution, 36
 ammoniacal solution, 38
 preservation of, 36
 reagent for carbon monoxide, 36, 86
 reagent for oxygen, 35
 regeneration, 36
- Cyanogen in illuminating gas, 179
- Diffusion, errors due to, 84
 prevention of, 84
- Distillation test for gasoline, 200
- Dulong formula, 289
- Electrical precipitation of suspended particles, 143
- Ethane, analysis by combustion with copper oxide, 59
 variation from gas laws, 91
- Ethylene, absorption of, 29
 initial combustion temperature, 56
- Exact gas analysis, see gas analysis
- Explosion analysis, see gas analysis
- Explosion, not prevented by capillary tube, 52, 55
- Filters for solid particles in gas, 141, 142
- Fixed carbon in coal, analysis, 232
 standard method of analysis, 247
- Flash point of oils, 193
- Flue gases, see chimney gases
- Form of record of gas analysis, 61
 heating value of gas, 105, 109
- Fractional combustion, see gas analysis
- Fuels, liquid, see liquid fuel
- Fuel oil, 202
- Fuming sulphuric acid for olefines, 29
- Fusibility of coal ash, 232
- Gas, analysis of, see gas analysis
- Gas, candle power of, see candle power
- Gas, heating value of, see heating value
- Gas, suspended particles, see gas analysis
- Gas, table of properties, 301, 302
- Gas, table of specific heats, 303
- Gas, see also illuminating, natural, producer, etc.

- Gas analysis, absorption methods, 28-42
accuracy of technical, 27
acetylene, 85
alkalinity of burette water, 26
apparatus—Allen-Moyer form, 67
 Bunte's, 68
 Chollar's, 70
 Orsat's, 65
 White's, 16, 43, 77, 79
calibration of burette, 22, 83
carbon dioxide, 28, 84
carbon monoxide by absorption, 36
carbon monoxide by explosion, 50
carbon monoxide, hydrogen, and methane by explosion, 50
carbon monoxide by iodine pentoxide, 86
combustion methods, 43, 51
continuous recording instruments, 72
corrections for temperature and pressure, 75
details of simple analysis, 25
errors due to diffusion, 84
errors in explosion of hydrogen and methane, 88
exact methods, 74-91
explosion analysis, accuracy, 48
explosion analysis, calculations, 49
explosion pipette details, 43
explosion analysis manipulation, 46
explosion analysis, hydrogen and methane, 48
form of record, 61
fractional combustion with copper oxide, 56
fractional combustion with palladinised asbestos, 53
gas burette, simple, 16
gas burette, bulbed, 79
- Gas analysis, gas pipettes, 24
general methods, 14
general absorption methods, 28
general scheme, 40
historical, 74
humidity, table, 295, 296
hydrogen by absorption, 38
hydrogen by colloidal palladium, 39
hydrogen by explosion, 48, 87
illuminating gas, 163
initial combustion temperature of different gases, 56
methane by explosion, 50, 89
minute quantities of combustible gas, 60
natural gas, 183
nitrogen, 61
olefines, 29, 85
optical methods, 73
order of absorptions, 41
explosion analysis, oxidation of nitrogen, 47
oxygen by explosion or combustion, 61
oxygen, 30-35, 86
oxygen, commercially pure, 32
palladous chloride for hydrogen, 38
pipettes, White's, 24
producer gas, 158
quiet combustion with oxygen, 51
quiet combustion of hydrocarbons, 52
recording types of apparatus, 72
reduction of volume to standard conditions, 75, 291
saturating burette water, 18
suspended particles, 138
thermal conductivity methods, 73
transferring gas from holder, 19
see also carbon monoxide and hydrogen and other individual gases

- Gas analysis, table of constants of certain gases and vapors, 301, 302
 tables for reduction of volume to 0° and 760 mm. dry, 291
 tables for reduction of volume to 60° and 30 in. wet, 292-4
 tar fog, 138
 unsaturated hydrocarbons, 28, 85
 variation from gas laws, 90
- Gas burette, calibration, 22
 cleaning, 17
 description of simple form, 15
 drawing sample of gas, 18
 measuring gas volume, 21
 saturating water of, 18
 for exact analysis, 79
 see gas analysis
- Gas burners, standard for photometry, 128
- Gas calorimeters, continuous flow, 92-116
 automatic and recording, 117
 various types, 116
 see also heating value of gas
- Gas holders, for samples, 13
 transferring gas for analysis, 19
- Gas mains, sampling from, 140
- Gas meters, calibration, 94
 description of wet, 93
 for candle power tests, 132
- Gas pipettes, see gas analysis
- Gas producers, see producer gas
- Gas Referees, 122, 126, 128
- Gas sampling, 1-13
 apparatus for aspirating sample of gas, 9
 aspirators, 5
 collecting average sample, 8
 collecting instantaneous sample, 11
 continuous apparatus, 10
 errors due to solubility, 7
 fair sample, 1
 forms of sampling tubes, 2
- Gas sampling, glass gas holders, 12
 illuminating gas, 163
 influence of bends in mains on suspended particles, 140
 materials for sampling tubes, 2
 point of mean velocity in cross section of gas main, 139
 producer gas, 158
 saturating water in sampling tubes, 8
 solubility in water, 6
 storage of samples, 11
 velocity of gas in sampling tubes, 140
- Gas volume, corrections for temperature and pressure, 95
 table for reduction to 0° and 760 mm. dry, 291
 60° and 30 in. wet, 292-4
 defined, 196
- Gasoline, in natural gas, 185
 specifications, 197
- Heat of combustion, table for various materials, 301
- Heat of formation, table for various materials, 302
- Heat lost in chimney gases, 150
 lost in chimney gases problem, 152
- Heating value of coal in bomb calorimeter
 accuracy of results, 280
 action of acid on calorimeter bomb, 275
 adiabatic calorimeters, 279
 calorimeter bomb, 258
 calculation of heating value, 273
 correction for combustion of iron wire, 275
 corrections for oxidation of nitrogen, 273
 corrections for oxidation of sulphur, 274
 corrections for radiation, 268-273

- Heating value of coal in bomb calorimeter
 details of calorimetric bomb, 259
 form of record, 271
 manipulation, 263
 net heating value, 281
 oxidation of nitrogen, 273
 oxidation of sulphur, 274
 precision calorimetry, 280
 preparation of sample, 262
 radiation corrections, 267-273
 Regnault-Pfaundler formula, 268
 Dickinson formula, 272
 standard method, 272
 reduction to constant pressure, 275
 sample of record, 271
 thermometers, 262
 thermometer corrections, 267
 total heating value, 281
 water value of calorimeter, 276
- Heating value of coal in Parr calorimeter
 accuracy, 289
 care of sodium peroxide, 285
 corrections, 288
 description, 283
 operation, 286
- Heating value of coal in Thompson calorimeter, 282
- Heating value of coal
 calculation from chemical analysis, 289
 combustion in a stream of oxygen, 282
 general method of determination, 258
 peroxide method, 283
- Heating value of gas, 92-118
 accuracy of method, 108
 automatic calorimeters, 117
 calibration of meter, 95
 calculated from chemical composition, 117
- Heating value of gas, calculation of
 observed heating value, 103
 calculation of total heating value, 107
 calculation of net heating value, 106
 gas calorimeters, various types
 see gas calorimeters
 conversion factors from metric to British units, 104
 corrections to be applied to observed heating value of illuminating gas, table, 297
 corrections to be applied to observed heating values of natural gas, table, 298
 corrections for difference between inlet water temperature and room temperature, table, 300
 corrections for emergent stem of thermometer, table, 299
 corrections for temperature and pressure, 95
 description of calorimeter, 97
 description of test, 102
 errors itemized, 108
 form of record, 105, 109
 gross heating value, 106
 Hempel calorimeter, 116
 humidity of air, influence, 113
 illustrations of calculations, 105
 Junkers calorimeter, 97
 measurement of mass of water, 96
 measurement of temperature, 96
 net heating value, 106
 normal rate of gas flow, 101
 observed heating value, 103
 preliminaries of a test, 99
 recording calorimeter, 117
 saturating water in meter, 102
 Test Record of Bureau of standards, 109
 total heating value, 106
 uncondensed water vapor, 112

- Heating value of liquid fuels, 188
 Humidity of air, affecting candle power, 136
 Humidity of air, determinations, 113
 relative tables, 295, 296
 Hefner lamp, 123
 Hydrogen, accuracy of estimation
 affected by explosive ratio, 88
 analysis by absorption, 38
 carbon monoxide and methane, simultaneous explosion, 51
 affecting compositions of chimney gas, 145
 method of analysis, 251
 fractional combustion with palladinised asbestos, 53
 fractional combustion with copper oxide, 56
 explosion analysis, 48, 87
 initial combustion temperature, 56
 quiet combustion with air, 51
 Hydrogen sulphide
 arsenious acid as reagent, 72
 in illuminating gas, 169
 with carbon dioxide, 28
 Hydrometers, comparison of Baumé scale for liquids lighter than water and specific gravity, table, 304
 Hydrosulphite as reagent for oxygen, 33
 Illuminants, average composition, 85
 solubility of, 132
 Illuminating gas, 163
 ammonia, 179
 benzene, 166
 benzene and light oils, 167
 candle power, see candle power
 chemical composition, 164
 cyanogen, 179
 general scheme of analysis, 164
 hydrogen sulphide, 169
 naphthalene, 173
 sampling, 163
 Illuminating gas, scheme of analysis, 164
 specific gravity, 181
 suspended tar, 179
 total sulphur compounds, 170
 typical analyses, 165
 Incomplete combustion in chimney gases, 147
 Initial combustion temperatures of various gases, 56
 International candle, 122
 Iodine pentoxide for carbon monoxide, 61
 Iron, heat of combustion, 275
 Jet photometer, 137
 Kerosene, flash point, 193
 tests, 201
 Kjekildahl method for nitrogen in coal, 255
 Liquid fuels, 187
 distillation test, 198
 flash point, 193
 fuel oil, 202
 gasoline, 196
 heating value, 188
 kerosene, 201
 moisture, 191
 proximate analysis, 192
 sampling, 187
 specific gravity, 191
 suspended solids, 192
 Loss of heat in chimney gases, 150
 Lubricant for stop cocks, 17
 Measuring gas in burette, 21
 Meter for candle power determination, 132
 Meter, wet gas, 93
 Methane, accuracy of estimation
 affected by explosive ratio, 89
 carbon monoxide and hydrogen, simultaneous explosion, 50

- Methane**, by combustion with copper oxide, 59
by explosion, 48, 89
small quantities in air, 60
variation from gas laws, 91
initial combustion temperature, 56
quiet combustion with air, 51
- Mine air**, examination, 60
- Mine sampling of coal**, 209
- Moisture in air**, see humidity
- Moisture in coal**, 227
standard method of analysis, 243
- Moisture in gas**, correction for, 75
- Moisture in liquid fuels**, 191
- Naphthalene**, estimation in illuminating gas, 173
estimation in tar, 176
as standard in calorimetry, 278
- Natural gas**, analysis, 183
analysis by fractional distillation at low temperatures, 185
errors in analysis due to variations from gas laws, 91
typical analysis, 184
gasoline vapors in, 185
specific gravity, 182
- Net heating value of gas**, 106
- Net heating value of coal**, 281
- Nitrogen in gas analysis**, 61, 91
- Nitrogen in coal**, 237
method of analysis, 255
- Nitrogen**, oxidation in bomb calorimeter, 273
oxidation in explosion analysis, 47, 88
table of specific heats, 303
- Olefines**, absorption of, 29
estimation of mean composition, 85
- Optical methods in gas analysis**, 73
- Orsat apparatus**, 65
- Oxidation of nitrogen**, error caused by in gas analysis, 47, 88
corrections for in coal calorimetry, 273
- Oxygen**, always present in industrial gases, 31
analysis of commercially pure, 32
determination of by ammoniacal copper solution, 35
determination of by alkaline pyrogallate, 33
determination of by hydrosulphite, 33
determination of by phosphorus, 30
by explosion or combustion, 61
- Oxygen and phosphorus**, poisons inhibiting reactions, 29, 31
- Oxygen**, table of specific heats, 303
- Oxygen in coal**, 237
method of analysis, 256
- Palladinised asbestos**, 53
- Palladinised copper oxide** for fractional combustion, 56
- Palladium**, colloidal reagent for hydrogen, 39
- Palladous chloride**, reagent for hydrogen, 38
- Parr calorimeter**, see heating value of gas
see heating value of coal
see liquid fuels
- Pentane**, combustion with copper oxide, 59
- Pentane lamp**, 126
- Permanganate** as reagent for reducing gases, 84
- Peroxide**, sodium, care of, 285
- Peroxide calorimeter**, see Parr calorimeter
- Peroxide method** for sulphur in coal, 233
- Petroleum**, see liquid fuels, gasoline, kerosene, etc.

- Phosphorus, as reagent for oxygen, 30, 185
- Phosphorus as reagent showing absence of unsaturated hydrocarbons, 29, 85
- precautions in handling, 30
- sometimes inactive, 32
- Phosphorus in coal, 237
- standard method of analysis, 250
- Photometry, see candle power
- Pintsch gas, 29
- Pipettes for gas analysis, see gas analysis
- Poisons affecting reaction between oxygen and phosphorus, 32
- Portable gas analysis apparatus, 64-72
- Pressure of gases, correction for, 95, 291, 292, 293
- Pressure of water vapor, table, 290
- Producer gas, analysis, 158
- efficiency of producer, 162
- formation, 156
- heating value of, 160
- sampling, 158
- interpretation of analysis, 159
- typical analyses, 157
- volume per pound of carbon, 161
- Proximate analysis of coal, 222
- Proximate analysis of liquid fuels, 192
- Psychrometer, 113
- Pyrogallate, as reagent for oxygen, 33, 86
- Quartz combustion tube for copper oxide, 57
- Quartz combustion tube with platinum spiral, 51
- Radiation corrections, see heating value of coal, and gas
- Record form for gas analysis, 61
- heating value of coal, 271
- heating value of gas, 105, 109
- Reduction of gas volumes to 60° and 30 in. table, 292-4
- 0° and 760 mm. dry, table, 291
- Relative humidity, table, 295, 296
- Rubber connections, danger of, in gas analysis, 18
- Sampling, apparatus for gas, 1-13
- blast furnace gas, 141
- chimney gases, 144
- crude illuminating gas for naphthalene, 175
- coal, see coal sampling
- coal, standard method for laboratory sampling, 240
- coke, 219
- standard method of laboratory sampling, 257
- see gas sampling
- liquid fuels, 187
- producer gas, 158
- suspended particles in gas, 140
- tubes for gases, 2
- Saturating water in sampling tubes, 8
- Saturating water of burette, 18
- Saturation pressure of water vapor, table, 290
- Saturating water in gas meter, 102, 132
- Slate, as cause of error in coal sampling, 208
- separation by washing, 239
- Sodium hydrosulphite, as reagent for oxygen, 33
- Sodium hydroxide, reagent, 28
- Sodium peroxide, care of, 285
- Solubility of gases in water, 6
- Specific gravity compared with Baumé scale for liquids lighter than water, table, 304
- Specific gravity of gas, determination of, 181
- Specific gravity of gases, table, 301
- Specific gravity of liquid fuels, determination, 191

- Specific heat of gases, determination of, 150
- Specific heats of
gases, tables 303
material in bomb calorimeter, 277
- Stack gases, see chimney gases
- Standard method of coal analysis, 240
coke analysis, 257
coal sampling, 214
coke sampling, 216
- Standard conditions for measurement of gases, 76, 95
- Stopcocks, care of, 17
- Storage of gases, 11
- Sugar as standard in calorimetry, 278
- Sulphates in coal ash, 230
- Sulphur, analysis of in coal, 232
Atkinson method, 233
Parr's photometric method, 235
Peroxide method, 233
in washings from bomb calorimeter, 235
- Sulphur, corrections for oxidation in bomb calorimeter, 274
total in illuminating gas, 170
- Sulphur dioxide, removal with carbon dioxide, 28, 84
- Sulphuretted hydrogen, see hydrogen sulphide
- Sulphuric acid, fuming as reagent, 29
- Suspended particles in gas, 138
- Suspended particles in gas, distribution in main, 138
- Suspended particles in gas, mean velocity, 139
- Suspended particles in gas, sampling, 140
- Suspended solids in liquid fuels, 192
- Suspended tar in gas, estimation, 142
- Tar, estimation of naphthalene in, 176
moisture in, 192
- Tar suspended in gas, estimation, 142
- Temperature of gases, corrections for, 95
- Temperature of initial combustion of various gases, 56
- Temperature measurement in calorimetry, errors in, 108, 267, 280
- Thermal conductivity as method of gas analysis, 73
- Thermometers, table of corrections for emergent stem, 299
- Ultimate analysis of coal, 236
standard method, 251
- Unsaturated hydrocarbons, determination of, 28, 85
- Variations from gas laws, 90
- Volatile matter in coal, 228
standard method of analysis, 245
- Volume of gases, formula for reduction to standard condition, 76
- Volume of chimney gas per pound of coal, 148
- Volume of gases, tables for reduction to standard conditions, 291-4
- Volume of producer gas per pound coal, 160
- Water, combined in coal, 151
saturated with air, composition of dissolved gases, 7
- Water value of calorimeter, see heating value of coal
- Water vapor, table of saturation pressure, 290
- Water vapor, table of specific heats, 303

- Water vapor, volume taken up by
one cu. ft. air, table,
304
weight per cu. ft. of saturated air,
112
- Water, weight of one liter at various
temperature, 265
- Water, weight of one cubic foot at
various temperatures, 94
- Weathered coal, changes in, 224, 262
- Wet gas meter, see gas meter
- Wet and dry bulb thermometers, 113
- Wiring rubber connections, 19
- Wiring stopper into burette, 78

INDEX OF AUTHORITIES CITED

- Allen and Jacobs, 191
Allen and Moyer, 67
American Chemical Society, see
Committee on coal analysis,
American Gas Institute, 108, 111,
136
Anderson, 34, 184
American Society for Testing Ma-
terials, 193, 198, 214, 219,
240, 257, 272
Atkinson, 234
Atwater, 259
Atwater and Snell, 277
- Badger, 35, 227
Bailey, 208
Barker, 233
Barkley and Flagg, 73
Bartlett, 87
Benton, 10
Berthelot, 32, 258
Blauvelt, 141
Bleier, 79
Brady, 141
Brodhun, 129
Bunsen, 129, 181
Bunsen and Playfair, 74
Bunte, 68, 167
Bureau of Mines, 144, 157, 187,
213, 214, 224, 243
Bureau of Standards, 106, 108, 109,
170, 182, 265, 297, 298
Burrell, 185
Burrell and Robertson, 184
Burrell and Seibert, 73, 90, 185
- Campbell, 16, 38, 44, 56
Cheney, 259
Chollar, 70
Church, 192
- Coleman and Smith, 174
Committee on coal analysis, 228,
229, 239, 240, 280
Coquillion, 51
Cottrell, 143
- Davis, see Fieldner
Davis and Davis, 167
Davis and Fairchild, 239
David & Wallace, 262
Dennis, 52
Dennis and Hopkins, 88
Dennis and McCarthey, 166
Dickinson, 272, 277, 280
Doherty, 116
Doyere, 74
Drehschmidt, 170
Dykema, 185
- Earnshaw, 85, 117
Edwards, 73, 182
Eschka, 232, 247
- Fairchild, 239
Favre and Silverman, 283
Fernald and Smith, 157
Field, 232
Fieldner and Davis, 228
Fieldner, Hall and Field, 232
Fieldner and Selvig, 281
Flagg, 73
Franzen, 34
- Gas Chemists hand book, 301, 302
Gill, 44, 47
Gill and Bartlett, 87
Graefe, 116
- Haber and Oechelhauser, 167
Hall, 232
Harbeck and Lunge, 167

- Harcourt, 126
 Harding, 170
 Hart, 38
 Hartmann, 39
 Hartley, 93
 Hefner, 121
 Hempel, 38, 39, 51, 53, 55, 75, 116,
 166, 258
 Henning, 150
 Hillebrand and Badger, 227
 Hinman, 47
 Heuse, 290
 Holborn and Henning, 150
 Holmes, 209
 Hopkins, 52, 88
 Hulett, 227

 Jacobs, 191
 Jaeger, 56
 Jenkins, 170
 Jones, 36
 Jesse, 280
 Junkers, 93

 Kinnicut and Sanford, 86
 Klumpp, 137
 Krauskopf, 37
 Kreisinger, Augustine and Ovits, 144
 Kroeker, 236
 Küster, 174

 Lavoisier, 74
 Le Chatelier, 150
 Leeson, 129
 Lord, 239
 Lummer, 129
 Lunge, 167

 McBride, Weaver and Edwards, 169
 McCarthy, 166
 McWhorter, 87
 Mack and Hulett, 227
 Mahler, 258
 Mallard, 150
 Morgan and McWhorter, 87
 Morton, 166
 Moyer, 67
 Mueller, 179

 National Fire Protection Association, 202
 Nesmjelow, 55
 Nicloux, 86
 Noyes, 50

 Oechelhauser, 167
 Ovitz, 211
 Orsat, 35, 65

 Paal, 39
 Parr, 116, 228, 230, 233, 235, 236,
 238, 259, 283
 Pennock and Morton, 233
 Petterson, 77
 Pfaundler, 268
 Playfair, 181
 Pope, 214
 Porter, 225
 Porter and Ovitz, 211
 Purdy, 37

 Ramsburg, 169
 Regester, 235, 250
 Regnault and Reiset, 74
 Regnault and Pfaundler,
 268
 Reiset, 74
 Richards and Jesse, 188
 Robertson, 184
 Rolland, 64
 Rutten, 174

 Sanford, 86
 Scheel and Heuse, 290
 Scheurer-Kestner, 283
 Schilling, 181
 Schlösing and Rolland, 64
 Seibert, 73, 90, 185
 Selvig, 281
 Shepherd, 50
 Silverman, 283
 Small, 33
 Smith, 157
 Snell, 277
 Somermeier, 274
 Steere, 142

Stevenson, 259
Sundstrom, 233

Thompson, 282
Threlfall, 139
Tutwiler, 170

U. S. Fuel Administration, 201
United Gas Improvement Co., 301,
302

U. S. Geological Survey, 289
U. S. Weather Bureau, 113

Waidner and Mueller, 106
Wallace, 262
Weather Bureau, 113
Weaver, 73, 169

White, A. H., 16, 44, 53, 77, 88, 139,
175
White, W. P., 280

