

Techno

LIQUID FUEL AND ITS APPARATUS

By Wm. H. BOOTH, F.G.S.

MEMBER OF THE AMERICAN SOCIETY OF CIVIL ENGINEERS; FORMERLY
OF THE NEW SOUTH WALES GOVERNMENT RAILWAYS AND
TRAMWAYS, OF THE MANCHESTER STEAM USERS'
ASSOCIATION, OF THE BRITISH ELECTRIC
TRACTION COMPANY, ETC.

126578
4. 3. 13

LONDON
CONSTABLE & COMPANY LTD
10 ORANGE STREET S.W.

1911

BUTLER & TANNER,
THE SELWOOD PRINTING WORKS,
FROME, AND LONDON.

TABLE OF CONTENTS

PART I

THEORY AND PRINCIPLES.

	PAGE
Preface	13

INTRODUCTION

Historical Notes ; Advantages of Liquid Fuel ; Petroleum ; General Notes ; Economies possible by the use of Liquid Fuel	21
--	----

CHAPTER I

The Geology of Petroleum ; Petroleum Drilling ; Pumping	28
---	----

CHAPTER II

The Economy of Liquid Fuel ; The Dangers of Petroleum ; Air necessary for Combustion ; General Principles of Liquid Fuel Combustion ; Flame Analysis ; Refractory Furnace Linings ; The Weir Boiler ; Liquid Fuels ; The necessity for Atomizing ; Vapourizing ; Varieties of Liquid Fuel ; Ameri- can Petroleum ; Russian Petroleum ; Creosote Oils ; Tar Distillates ; Blast Furnace and Shale Oils	35
---	----

CHAPTER III

Texas Oil ; Analysis of Oil ; Physical Properties ; Russian Oil ; Calorific Capacity of Oils ; Advantages of Liquid Fuel ; The Use of Oil on Locomotives ; The World's Oil Production ; The Limits of Liquid Fuel ; Equivalence of Oil and Coal ; Tests of Texas Oil	48
--	----

CHAPTER IV

Chemical and other Properties of Petroleum ; Water in Oil ; Petroleums suitable for Fuel ; Physical Properties of Petro- leum ; Specific Gravity of Petroleum ; Materials ; Cast Iron ; Steel ; Firebricks ; Fireclay ; Clay Analysis ; Special Forms of Bricks ; Classification of Clay Goods	62
--	----

CHAPTER V

	PAGE
Combustibles and Supporters of Combustion. Carbon: its Forms and Origin; its Calorific Properties; its Combustion and Chemistry. Hydrogen: its Physical and other Properties; its Compounds with Carbon; its Combustion; Air; The Atmosphere; Properties of Air. Oxygen: its Compounds with Carbon; its Properties; Water; its Properties; Origin and Sources of Water Impurities; Solubility of Salts; Sea Water; Useful Data	78

CHAPTER VI

Calorific and other Units; Thermo Chemistry; Heat; Temperature; Thermometers; Specific Heat; Latent Heat; Dissociation; Units of Heat; Units of Work; Units of Weight; Gravity; Compound Units; Calorific Power of Fuels; Calculation of Temperatures; Effects of Dissociation and of Variation of Specific Heat; Relative Volumes produced by Combustion; Evaporative Power of Fuel; Temperatures due to Combustion; Calculation of Calorific Capacity of Fuels; Smoke and Combustion; Varieties of Smoke; Its Prevention; Influence of Refractory Furnaces; The Combustion of Bituminous Fuels; Carbon Vapour; Liquid Fuels; Furnace Temperatures; Theoretical Flame Temperature; Total Heat generated; Air Supply; The Heat Properties of Carbon; The Process of Coal Combustion; Effect of Vaporizing Solid Fuels; Flame Analysis; The Principles of Combustion; The Necessity of Temperature; Smoke due to Loss of Heat of Burning Gases; The Use of Coloured Glass for Flame Inspection; The Weir Boiler; Ringelmann's Smoke Chart	90
--	----

PART II

PRACTICE.

CHAPTER VII

Oil Storage on Ships; Example of Improvised Tank Steamer; Example of Cargo Steamer; Example of New Tank Steamer; Use of Liquid Fuel at Sea; Supply of Oil at Ports; Safety and Flash Point; Advantages for War Ships; Economic Advantages of Liquid Fuel	127
--	-----

CHAPTER VIII

Marine Furnace Gear; Arrangement of Shell Line Steamers; Interchange of Coal and Oil; The Flannery-Boyd System; The Orde System; Results of Use of Liquid Fuel at Sea; Wallsend Slipway Company's Arrangement; The Lancashire Boiler with Orde's System; Körting System; Howden System	133
--	-----

TABLE OF CONTENTS

7

CHAPTER IX

	PAGE
Liquid Fuel Application to Locomotives ; The Holden System ; Advantage of Oil ; Method of Working ; Management of Fire ; Particulars of Oil Burning Locomotive ; Regulation of Oil Supply ; The Atomizer ; Life of Fire Boxes ; Heating the Oil ; Air Heater	154

CHAPTER X

Application of Liquid Fuel to Stationary and other Boilers ; The Lancashire Boiler ; Cornish Boiler ; Water Tube Boiler ; Locomotive Boiler ; Level of Atomizer in Mixed System ; Management of Fire ; United States Navy Tests ; The Meyer System ; The Mixed System of Coal and Liquid Fuel Combustion : its use in the Italian Navy ; M. Bertin's Calculations	167
---	-----

CHAPTER XI

Russian and American Locomotive Practice ; The Baldwin Company's System ; The Equivalence of Coal and Oil ; Comparisons of Cost of Liquid Fuel ; The Danger of Crude Oil ; The Urquhart System ; General Arrangements ; Management of Furnace ; Firebox Designs ; Smoke Results on Grazi and Tsaritsin Railway	178
--	-----

CHAPTER XII

American Stationary Practice with Liquid Fuel ; The Billow System ; Fuel Oil Pumping Systems ; Double Pumping Systems ; Furnace Construction ; Operating a Fuel Oil Plant ; Examples of Boilers with Liquid Fuel Furnaces	195
---	-----

CHAPTER XIII

English Stationary Practice with Liquid Fuel ; The Kermode System ; Analysis of Borneo Oil ; Tests of Borneo Oil ; The Hydroleum System ; Tests ; The Sprayer ; Air Supply	208
--	-----

CHAPTER XIV

The Combustion of Vaporized Liquids ; The Clarkson-Capel Burner : its Various Applications ; Starting Devices	218
---	-----

CHAPTER XV

Comparison of Air and Steam Atomization ; The Ellis and Eaves System ; Steam Atomization ; Air Atomization ; Tests	222
--	-----

TABLE OF CONTENTS

CHAPTER XVI

	PAGE
The Storage and Distribution of Liquid Fuel ; Tanks ; Piping ; Ventilation ; Great Eastern Railway System ; Grazi and Tsaritsin Railway System ; Oil Pumps ; Flue Gas Analysis ; Calculation of Volumes ; The Orsat Apparatus ; CO ₂ Recorders ; Calorimetry and Draught ; Calorimetric Deter- minations ; Draught ; Gauges ; Difference of Solid and Liquid Fuel in Relation to Draught	228

CHAPTER XVII

Compressed Air ; Air Compressors ; Principles of Compression ; Weight of Air necessary for Liquid Fuel Atomization ; Adia- batic Calculation of Air ; Compound Air Compression ; Volumetric Efficiency ; Power to Compress Air ; Outflow of Air	242
---	-----

CHAPTER XVIII

Atomizing Liquid Fuels ; Various Atomizers ; Elementary Forms ; Vaporizers ; The Symon-House Burner ; Atomizing Agents ; French Trials ; Air Compression ; Certain Advantages of Steam ; d'Allest Atomizer ; Fvardofski System ; Russian Atomizers ; Object of Atomizing ; American Practice	250
--	-----

CHAPTER XIX

Application of Liquid Fuel to Metallurgy ; The Höveler System	266
---	-----

CHAPTER XX

The Oil Engine ; The Diesel and other systems	270
---	-----

PART III

Tables and Data	281
---------------------------	-----

INDEX TO ILLUSTRATIONS

FIG.	PAGE
0. Hypothetical Section of Oil-bearing Strata	30
1. Kiln Furnace	74
2. Form of Baffle	74
3. Brick Fire Arch	75
4. Shaped Bricks	76
5. Shaped Bricks	76
6. Unshaped Arch Bricks	76
7. Weir Boiler	121
8. Ringelmann Smoke Chart	122
9. Furnaces, s.s. <i>Murex</i>	134
10. Furnace Brickwork, s.s. <i>Murex</i>	135
11. Furnace, s.s. <i>Trocas</i>	136
12. Service Tank, Flannery-Boyd System	137
13 and 13a. s.s. <i>New York</i>	138
14. Water Tube Boiler, Orde's System	141
14a. Fuel Bunker, Draw-off Pipe	142
15. Orde's Atomizer	144
16. Detail Arrangement for Lancashire Boiler, Orde's System	145
17 and 17a. Design for Oil Furnace, Wallsend System	146
18. Wallsend Pressure Burner	148
19. Diagrammatic Arrangement, Wallsend System	150
19a. Detail Arrangement, Wallsend System	150
20. Water Tube Boiler, Wallsend System	151
21. Furnace, s.s. <i>F. C. Laeisz</i>	152
22. Atomizer, Körting System	153
22a. Atomizer, Körting System	153
23. Great Eastern Locomotive, Atomizer, Holden's System	158
24. Atomizer, Form (1911), Holden's System	159
25. Atomizer, Locomotive Type, Holden's System	160
26. Great Eastern Locomotive, Holden's System, Firedoor	161
27. American Locomotive Firebox for Liquid Fuel	163
28. Great Eastern Locomotive	165
29. Lancashire Boiler, Holden's System	168
30. Water Tube Boiler without Grate, Holden's System	169
31. MacAllan Variable Blast Pipe Cap	170
32. Locomotive Boiler, Southern Pacific R.R.	171
33. Meyer System	173
34. Atomizer, Baldwin System	179
35. Oil Regulator, Baldwin System	179
36. Locomotive Firebox, Baldwin System, Old	180
37. Locomotive Firebox, Baldwin System, New	181

FIG.		PAGE
38.	Goods Locomotive, Urquhart System	188
39.	Goods tender, Urquhart System	190
40.	Firebox, Urquhart System	191
41.	Locomotive Firebox, Urquhart System	192
42.	Atomizer, Urquhart System	193
43.	Locomotive Performance Chart, Urquhart System	194
44.	Atomizer, Billow System	196
45.	Double Pumping System, Billow	198
46.	Tuyere, Billow System	199
47.	Tuyere Block, Air Regulator, etc., Billow System	200
48.	Tank Car Hose Connection	201
49.	General Furnace Mouthpiece Arrangement, Billow System	202
50.	Underfired Boiler, Billow System	205
51.	Water Tube Boiler, Billow System	206
51a.	General Arrangement, Billow System	207
52.	Liquid Fuel Furnace, Kermodé's System	209
52a.	Enlarged Details, Kermodé's System	210
53.	Furnace Arrangement, Kermodé's System	211
54.	Furnace Arrangement, Kermodé's System, Babcock Boiler	213
55.	Furnace Arrangement, Hydroleum System	215
56.	Furnace Arrangement, Hydroleum System	216
57.	Clarkson-Capel Burner for Fire Float	219
58.	Clarkson-Capel Burner for Automobile	220
59.	Air Heater, Ellis and Eaves System	223
60.	Ellis and Eaves Furnace Door	223
61.	Oil Supply Tank	231
62.	Weir Pump	232
63.	Diagram of Adiabatic Compression.	244
64.	Diagram of Compound Compression with Intercooling	244
65.	Atomizer, Höveler System	267
66.	Atomizer, Rusden-Eeles	251
67.	Atomizer, Aërated Fuel Process	252
68.	Atomizer, Kermodé's Pressure System	253
69.	Atomizer, Kermodé's Hot-Air System	254
70.	Atomizer, Kermodé's Steam System	255
71.	Atomizer, Hydroleum System	255
72.	Atomizer, Elementary Form	256
73.	Atomizer, Swensson	256
74.	Symon-House Vaporizer	257
75.	Atomizer, Guyot	258
76.	Atomizer, Nozzle Incorrect Form	259
77.	Atomizer, Nozzle Correct Form	259
78.	Furnace of French Torpedo Boat No. 22	260
79.	Atomizer, d'Allest	261
80.	Atomizer, Double, d'Allest	262
81.	Atomizer, Soliani	263
82.	Torpedo Boiler tried at Cherbourg	264
83.	Hornsby-Akroyd Engine	272
84.	Cross Section, Vaporizer, Hornsby-Akroyd	273
85.	Griffin Engine Vaporizer	276

INDEX TO TABLES

TABLE	PAGE
I Composition of Crude Oils	281
II Calorific Capacity of Liquid Fuel Oils	281
III Coefficient of Expansion of Crude Oil	281
IV Calorific Capacity of Crude Oil	284
V Table of the Properties of Gases (Kempe)	282
VI Temperature Table	284
VII Specific Heat of Gases	284
VIII Equivalentents, Various	285
IX Calorific Properties of Carbon	285
X Tension of Aqueous Vapour	286
XI Relative Economy Oil and Coal	286
XII Russian and Pennsylvanian Oils, Analysis of	286
XIII Comparative Trials of Petroleum Refuse	287
XIV Conversion Table, Degrees Baumé	288
XV Heat of Combustion (B. Th. U.) and Air per Pound of Fuel	288
XVI Theoretical Flame Temperatures	289
XVII Weight and Volume of Gases	289
XVIII Weight and Volume of Oxygen and Air for Combustion. Metric	290
XIX Weight and Volume of Oxygen and Air for Combustion. English	290
XX Theoretical Evaporative Value of Petroleum and Coal	291
XXI Ignition Temperature of Gases	292
XXII Conversion Tables for Evaporation and Combustion	292
XXIII Temperature Determination by Fusion of Metals	293
XXIV Volume and Weight of Dry Air	293
XXV B. Th. U. in Water	294
XXVI Saturated Steam Data	294
XXVII Factors of Evaporation	295
XXVIII Heat Balance Table	296
XXIX Heat Lost in Chimney Gases (Diagram)	297

PREFACE TO LARGER EDITION OF 1903

THE subject of Liquid Fuel is one that has now been before the public about twenty-five years, but little had been done in this country until about twelve years ago, when Mr. Holden, of the Great Eastern Railway, began to use the tar of his oil-gas process, and found many advantages in using this hitherto almost unsaleable product. The success of this tar led him on to the use of creosote and other hydrocarbon by-products, and now he is using Texas oil.

In this book the Author has endeavoured to put together what has been done in the burning of liquid fuel, and at the risk of repetition has given descriptions of various systems and apparatus; and while no statements have been accepted unconsidered, he has not hesitated to use descriptions and statements of manufacturers in some cases with little alteration where such statements were sound and reasonable. The Author is not only indebted to the many whose names appear in the text, but also to many others who have furnished him with information, particularly Professor W. B. Phillips, Ph.D., of the University of Texas, from whose bulletins the Author has drawn so copiously for information on Texas oil; to Mr. Thomas Urquhart, of Dalny, who, as Locomotive Superintendent of the Grazi and Tsaritsin Railway, first placed liquid fuel burning on a sound basis in locomotive work, and whose papers on the subject may be found in the Proceedings of the Institution of Mechanical Engineers; to his friend Mr. B. H. Thwaite, whose researches in combustion have been so extensive.

The work of the United States Naval Department, under Rear-Admiral Melville, has been so valuable that special appendices have been devoted to a copious abstract of the coal and oil tests made by the Bureau of Steam Engineering upon a water-tube boiler as well as tests upon the s.s. *Mariposa*

The Author has also drawn liberally upon the bulletins of the U.S. Geological Survey for information on petroleum production.

To Mr. Alfred J. Allen acknowledgment is due for information on tar and creosote, and for tabular matter to Mr. Poole, whose excellent treatise on the Calorific Power of Fuels deals so exhaustively with coal.

Appendices are added giving the Rules of the National Board of Fire Underwriters (U.S.), and also the Rules of Lloyd's Register of Shipping.

Acknowledgments are due to the *Electrical Review* (London) for permission to reproduce portions of the Author's articles in that Journal on questions of combustion. To Mons. L. Bertin, of the French Navy, the Author is indebted for information as to the use of liquid fuel in the French Military Marine.

The means for utilizing Liquid Fuel are very varied, yet all practically result in, or at least aim at, one end. It has been impossible within two covers to do more than select a number of such apparatus to illustrate the principles which have been followed in achieving success. The successful combustion of liquid hydrocarbon is but an extension of the principles necessary for bituminous or hydrocarbon coal. The difference is that coal is burned partly upon the grate, and air, to burn the hydrocarbon distillates, cannot well be introduced from below, as it can with liquid fuel which is burned in a floating condition, and can be fed with air from below very easily.

The difference is but one of degree, but with liquid fuel the fact that all the fuel is floating, and would produce a specially foul black smoke under the conditions in which coal is burned, has compelled the adoption of means that ought to be adopted with coal-fired furnaces.

The Author has endeavoured to connect the two practices, for in the present state of liquid fuel supply it is more than probable that its use will be parallel with the use of coal, especially in dealing with the sudden and high load peaks of electric stations. Liquid fuel cannot be universal unless the supply increases to many times what it is at present, and this points to a good future for the mixed system of firing, oil and coal being burned together in the same furnace.

It has been difficult to make a selection of apparatus to be described, but the Author trusts that he has selected a sufficient number of types practically to cover the ground and show the general trend of practice without unduly multiplying examples. Indeed the tendency seems to him to be in the direction of one general type. As regards special boilers, oil does not appear to require anything more than what is required by coal, though coal is not treated to the necessary

appliances, and oil is so treated, and gains success where coal is allowed to fail.

Much that perhaps ought to appear in such a book as this has been omitted, as it appears to the Author that the question of draught, for example, is not of the same importance with liquid fuel as it is with solid fuels.

More might be said on the subject of flue-gas proportion, but this again has been so fully treated by other writers that it did not seem desirable at present to deal with it more fully. The most important detail of liquid fuel apparatus is the furnace and the provision of air, and of means to secure combustion and conserve temperature to enable combustion to be made perfect.

Mr. Horace Allen kindly revised the section on gas analysis. Students of liquid fuel combustion will find enormous masses of information in the past volumes of the *Engineer*, *Engineering*, and other technical papers. Much of this information is duplicated and historical, and the Author has found it necessary to eliminate almost all such matter and confine his space to systems now living or of recent use, or of a form recognized as useful to-day. Undoubtedly Aydon and the late Admiral Selwyn did much to urge the use of liquid fuel, but the latter injured the value of his best work by regarding steam as a combustible.

The Author is also indebted to Messrs. Colonne and Lordier, the French engineers, for excellent information on liquid fuel, and indirectly no doubt to many others who are not directly traceable.

Finally, his grateful acknowledgments are due to his Publishers for the manner in which they have facilitated his labours throughout.

WESTMINSTER.

PREFACE

THE object of this book is to present in a handy form the more immediate practical points of the Author's larger work on the same subject.¹

In that book the Author endeavoured to present not merely the subject of liquid fuel combustion but such side issues as water softening, and considerably more on the general theory of combustion and the physical properties of materials than can be found room for in this present work.

The larger work is still available for those who may desire the fuller presentation of the subject, but it was written at a time when the popular idea of liquid fuel was very hazy, and when the world's production of petroleum was very much less than it is to-day. The ideas then presented by the Author have since received very general acceptance. Over parts of the world liquid fuel will continue to take the place of coal. In other parts it will be used because by its means things may be accomplished that would not be possible with coal. This was amply demonstrated during the naval manœuvres a year or two ago, when the stokehold crew of one of the rival fleet divisions were worn out and unfit for further effort. Liquid fuel was then resorted to and the ships simply ran away from the "enemy" and ravaged the south coast.

Much of what appears in the larger work is eliminated because of the foregoing reasons as well as the fact that the subject of liquid fuel is now quite removed from controversy and has entered more fully upon the commercial stage, for liquid fuel will now be used wherever it is cheaper than coal or possesses circumstantial advantages which outweigh expense. For the peak loads of electric light supply undertakings liquid fuel presents itself so favourably that only surprise can be felt that this particular field has so far been neglected.

This book will therefore be fairly closely confined to the use of liquid fuel in steam raising and in direct power production in the internal combustion engine. This engine has in the last few years made great advances and bids fair soon to

¹ *Liquid Fuel and Its Combustion.* Constable & Co., 1902.

find itself employed as the motive power producer in ships of great size and tonnage.

While bringing up to date the examples of apparatus these have been reduced in number. Tabular matter has been abridged in numbers and detail and much experimental record has had to be cut out in order to bring the book within its intended compass.

Finally it may be added that since the issue of the Author's larger book, there has been little change in the methods or apparatus employed, though there is a steady extension, chiefly abroad, in the uses to which liquid fuel has been put.

The Author trusts he has given sufficient examples of apparatus to enable any engineer to adapt liquid fuel to his own conditions. He wishes to make it clear that the examples and illustrations are chosen as examples and are not put forward as being other than typical. It is not possible to make a book into a complete catalogue of apparatus, and only a few can be selected as types.

WM. H. BOOTH.

38, BROAD STREET AVENUE, E.C.

Oct., 1911.

Part I
THEORY AND PRINCIPLES

INTRODUCTION

THE first really practical and efficient employment of liquid fuel for steam-raising purposes appears to be due to Mr. Thomas Urquhart, of the Grazi and Tsaritzin Railway of Russia. Mr. Urquhart used the spraying system and obtained good results, and his paper of 1884¹ marks the beginning of the period of really useful work.

The application of liquid fuel in the Caucasus owes its success to a combination of causes. Russian petroleum has less light oil in its composition, and therefore produces more astatki, i.e. mazut or residuum; coal is dear in the district, and the man was present in Mr. Urquhart to render the application of liquid fuel successful, previous applications not having proved so.

Urquhart placed the use of liquid fuel on a sound basis.

The Chicago Exhibition in the early nineties gave great impetus to the use of liquid fuel in America, for all the boilers there were arranged with oil fuel only.

In Great Britain the use of liquid fuel has not been extensive, but it has been marked by good practice, and only bids fair to become extensive since the introduction of mineral oil. Previously the tendency had been to use the products of distillation of coal or oil in the shape of tars or creosotes.

To-day liquid fuel is well established and recognized as a fuel of extreme elasticity, and one that can be burned smokelessly. The days of experiment are past, and no serious difficulties remain to be overcome. Since 1902 liquid fuel has been adopted in the British Navy, and it is understood that very satisfactory results have been secured.

At the same time the question must be considered from a conservative standpoint, because for years to come, if ever, the output of petroleum will not be sufficient to make it a serious rival of coal in every use. There is no certainty of extensive petroleum production in the future. Petroleum wells do not endure indefinitely. They are not like water wells, fed from

¹ Institution of Mechanical Engineers, *Minutes of Proceedings*, 1884.

surface rainfall, and geology does not assure us that they are being fed from still deeper sources, nor is it decided whether petroleum is of mineral or of organic origin. The future of petroleum is thus uncertain.

GENERAL CONSIDERATIONS

A general idea of the liquid fuel problem should therefore be obtained before attempting to gauge its merits.

There is a lack of the sense of proportion in many who discuss the question of liquid fuel.

In Great Britain alone over 250 million tons of coal are raised each year. In the United States the amount is still greater. The present production of mineral oil is a mere fraction of the millions of tons of coal produced in the world.

Liquid fuel has undoubted advantages in many cases, and probably nowhere could it be used to better advantage than in an electric light station.

One of the principal advantages of oil is its high calorific value per pound. This, with the best oils, is double the capacity of the inferior coals, and 30 per cent. better than the best coal. The ease with which it can be stored and moved from point to point is an advantage. It can be fired mechanically, makes no ash or clinker, can be burned at maximum rate or entirely turned off in a moment. Further, a very large power of boilers requires very little labour in the stokehold. Petroleum consists of a very large variety of constituents, gaseous, liquid, or solid. The gas is marsh gas, CH_4 , and at once disappears; the lighter liquids are very volatile, and finally there are solid bodies at the end of a long series of liquids of varying degrees of volatility and specific gravity.

The chemical formulæ which cover most of the constituents of petroleum are C_nH_{2n} and $\text{C}_n\text{H}_{2n+2}$. These formulæ continue throughout the whole range from marsh gas, CH_4 , onwards.

Texas oil is used chiefly as it is found.

Russian oil is used in the form of *astatki*, the residuum after distilling off the lighting and lubricating oils. Much of the American oil is also used in the form of residuum.

The proportion of carbon in all the liquids used as fuel varies very little from 84 per cent., the hydrogen amounting to 16 per cent. There is little else, so that petroleum is practically all combustible.

It is well established that there is at present only one way to burn liquid fuel for steam raising, and that is by atomizing the fuel in company with a sufficient amount of air around

each atom. In order that oil may atomize freely, it should be deprived of viscosity by heat. Heat also causes any water in the oil more easily to separate out, first, because heated oil, being more limpid, offers less resistance to the freeing of the water; and secondly, there is greater expansion of oil than of water due to the heat, and the water gains a relatively greater specific gravity.

Warming is done by a steam coil, and may be merely local warming in the vicinity of the take-off valve in the tank. It is essential that water be fairly well separated, because if it comes through the burners in any quantity it may extinguish the fires, and the next following oil is apt to ignite explosively.

In storing oil there is always apt to be some vapour given off, and an empty tank ought not to be entered with a light.

Though not nominally of double the calorific capacity of average fair coal, oil is found in practice to be worth double the price of coal, owing to the labour cost which it saves.

This is as regards marine service, for the oil can be carried in ballast tanks, and paying cargo is carried in the coal bunker space.

For land purposes, these latter considerations do not weigh, and the relative values must be based on the performance ratio of about 16 to 10, together with the economy of labour, cleaning, ash cartage, etc.

Above and beyond all these things, however, is the power which liquid fuel gives of immensely increasing the steam-production of a boiler at short notice.

In general practice a steam-boiler is designed with a given ratio of heating surface per unit of fuel burned. Any reduction of this ratio is accompanied by a poorer performance. Less steam is produced per pound of oil consumed. A reduction of the heating surface ratio does not, however, reduce the performance by anything like the same ratio.

If a large demand for steam is made upon a boiler for a short fraction of its working hours, it may be cheaper to consume fuel at a high rate for a fraction of the time than to employ two or even three boilers at normal rates during a fraction of the day, the extra boilers remaining idle during the rest of the day; albeit when the heavy load is past these extra boilers are retired hot and full of energy. The saving by the first method is very considerable in respect of space occupied, buildings and capital cost generally, and if not carried too far it will outweigh the fuel cost of the short run at heavy output.

For this system of working, coal can, of course, be employed. Coal, however, cannot be fired at abnormal rates with special

ease. A mechanical stoker does not readily increase its rate of working. The better forms of stoker—on the coking principle—cannot put their whole grate surface into the new and forced condition. The sprinkler class, again, do not work well at abnormal rates. Coal combustion is only to be regulated by draught intensity. With oil, the supply is instantly variable to suit the steam required, and a boiler can rapidly give its fullest output. With boilers of the smaller tube type especially, their small water contents enables the engineer to leave them standing cold to within a short time of maximum output. Oil is then turned on, and in a few minutes the boiler is in full work. When a boiler is already at work the mere turn of a handle puts it into its maximum steam-producing condition.

So soon as the demand ceases the oil can be turned off, and the normal coal fire continued, or the boiler laid off entirely. By means of liquid fuel great elasticity is possible.

In a lighting station the load factor is very usually about 12 per cent. That is to say, about one-eighth of the plant is, on the average, at work all the working hours.

This excessive misproportion is remedied to any desired extent by means of accumulators, but it is not yet commercially economical to instal so high a proportion of battery power as to enable the power-plant to run at steady load all day. The peak of the load, however short in duration, cannot be surmounted without the aid of power, and it is to the height and small duration of the maximum load curve that the poor load factor of a lighting station is due. Accumulators for heavy output of short duration greatly improve the load factor, but, in any case, the number of boilers at work to tide over the peak is several times the mean number.

If, by means of liquid fuel, boilers can be heavily pushed for two, three, or four hours, the capital outlay on boilers will be much reduced. When the various points are taken into account, the boiler scheme that will probably suggest itself will be, first, some boilers of the Lancashire type, economical and steady steamers; secondly, large tube boilers with a moderate water contents and large grate area, and with efficient steam driers or superheaters. These boilers can be heavily forced with some sacrifice of economy, but the priming due to heavy forcing must be eliminated by a good superheater. This is essential to economy. Thirdly, small tube boilers of very small water capacity, capable of being heavily forced, delivering their steam preferably above water level in the steam drum. If all these boilers are fitted with oil sprayers, the maximum

demand for steam will be met with the minimum of capital outlay.

It is a fallacy to suppose that boilers of small water capacity respond most readily to a sudden demand for steam.

When a boiler is at work under full pressure, the whole of its water is at a temperature which corresponds with the pressure. Any addition to the furnace activity cannot add to the heat contents of the boiler, unless the pressure is allowed to rise; obviously, therefrom, given the continuance of the same pressure, the boilers of large water contents will answer to an urged fire just as rapidly as a boiler of small water contents. When boilers are standing at rest, however, and cold, the boiler which contains the least water will, *ceteris paribus*, become most quickly hot. Such a boiler as the Solignac, which holds almost no water, can be made, by aid of oil fuel, to produce its maximum power in a few minutes after lighting up.

In this respect oil has a decided advantage over solid fuel. To secure a good fire with solid fuel there must be a thick bed of incandescent fuel on the grate, and this can only be built up with comparative slowness, and when its duty is over it remains a more or less wasted force. With oil, however, the maximum fire is instantaneous, and the only drawback is the cold brickwork of the setting, which must become hot before the maximum furnace duty is attained.

For ordinary economical work the number of heat units that a boiler can absorb per square foot of heating surface will not be changed when liquid fuel is employed, except so far as liquid fuel can be burned without smoke more easily than can solid hydrocarbons, such as coal, and thereby the heating surface is maintained clean and free from dust and soot, and more efficient. Evaporative efficiency must not be allowed to outweigh the overall, or commercial, efficiency. Exactly what governs the relation between evaporative and commercial efficiency cannot be stated positively. Indeed, commercial efficiency alone should be considered as the true basis of design. It may, however, be stated in general terms that plant which is on duty for long hours may be designed to work more economically as regards fuel than plant intended to work very short hours.

Let it be assumed that the boilers which are economical of fuel have an efficiency of 72 per cent., and that the small highly pushed boilers are run at 60 per cent. efficiency for three hours.

Then, in course of a year, fuel is wasted which represents 12 per cent. difference of efficiency lost for three hours daily.

To enable this loss to be avoided there would be so many

thousands of pounds extra capital cost in boilers, buildings, etc., and where oil is not employed, so much more labour cost as compared with oil. Properly equated at a suitable rate of interest and depreciation, the relative value of the alternative systems may be found after the manner of the Kelvin law applied to cable work. In many stations the extra labour for the heavy duty period is difficult to arrange satisfactorily. Men are employed more hours than they really work, and where it may be best to use coal for 10 hours, the labour cost may make it cheaper to use oil for 4 hours of a peak load, even if, in mere fuel cost per unit, the oil is more expensive.

Trials with liquid fuel show that there is still much to be done in reducing the air supply. The air required to burn 1 unit weight of carbon is $11\frac{1}{2}$ units. An ordinary oil fuel requires fully 15 units, with, of course, some additional excess as with solid fuel. But with oil fuel there ought to be better mixture of air and fuel, and therefore better combustion with less excess of air.

If we regard air as the fuel and coal or oil as the sustainer of combustion, as we have a *chemical* right to do, we shall arrive at the conclusion that, approximately, the calorific value of a fuel in actual duty done will not differ much from the chemical ratio of air required in the combustion process. The large amount of air per pound of oil arises from the large percentage of hydrogen in the oil, and it is the large capacity for oxygen possessed by hydrogen which renders the theoretical temperature of combustion so nearly like that of carbon, in spite of the high calorific capacity of hydrogen.

As regards the production of petroleum, that of the United States in the year 1901 was 69,389,194 barrels, valued at $66\frac{1}{2}$ million dollars. If each barrel is assumed to contain 360 lb., or say 6 barrels per ton, the total tonnage will be 11,565,000, and the value, therefore, something under 23s. per ton, or practically \$1 per barrel. Thus the weight of oil produced in the United States was about 5 per cent. of the weight of coal, or say $7\frac{1}{2}$ per cent. of the calorific capacity. After the removal of the lighting and lubricating oils, the amount of fuel oil remaining was quite small as compared with the coal output. It may be assumed that the total oil production of the world is not five per cent. of its coal production. Any idea of entirely displacing coal must be out of the question, unless the yield of oil be increased beyond present prospects, and the use of fuel must therefore be undertaken with common sense caution, and not in any wholesale manner, to the expected exclusion of coal.

At the same time, when the limitations of the subject are recognized, it cannot be denied that liquid fuel lends itself to certain conditions as to steam raising which must render it extremely valuable and of great convenience. Marine work and electrical work are, *par excellence*, the two lines along which liquid fuel appears likely to advance most successfully, and in the author's opinion steam-driven motor cars may eventually discard the dearer oils and employ the heavy oils and residuum as fuel by means of atomizers. According to present appearances, the motor car or tractor offers one of the finest fields for the use of the heavy fuel oils as distinguished from the petrols or even the cheap lamp oils, such as are already used on steam cars. Little has yet been done in this direction. It may, however, be added that the commoner grades of paraffine are at present so cheap that such vehicles as steam omnibuses are not tempted to depart from paraffine in favour of heavier oils. † Such cheapness appears to arise from fighting competition, and if so will not last.

CHAPTER I

THE GEOLOGY OF PETROLEUM

IN this book very short reference only is needed to the subject of the Geology of Petroleum and the method of procuring it.

Petroleum is found in various geological formations, from the Silurian and Carboniferous in the United States, to the Tertiaries in the eastern hemisphere. It indicates its presence sometimes by the escape of inflammable gas at the surface, sometimes by the existence of deposits of pitch or asphaltum, as at La Brea in Trinidad, where a large lake of pitch has been recently proved to have indicated petroleum below. Sometimes petroleum oozes from surface outcrops. Where there are no surface indications petroleum may be inferred to exist where the geological conditions resemble those of known and proved fields. But no geological knowledge can go beyond this. In a proved field there is greater certainty of success along any particular line of country with each successful boring that has been made along that line.

Petroleum is very usually found to lie along an anticlinal fold, more or less inclined, the oil having been forced into such ridged or domed formations by the superior gravity of water pressure behind it. A natural sequence of this is that, when an oil well becomes exhausted, the oil is frequently succeeded by a flow of water—often salt.

This frequent presence of salt water with petroleum lends colour to the supposition that petroleum is of marine origin, and formed by the action of heat and pressure on marine organisms of animal or vegetable origin.

Porous strata are the most favourable for the storage of oil owing to their porosity. When overlaid by impermeable beds of clay, gas usually accompanies the oil when first struck. When oil occurs in clay, as in the oil shales of Scotland and of New South Wales and in the Kimeridge Clay of England, the clay has merely absorbed the oil and holds but a comparatively small quantity. The gas has often escaped. At Heathfield in

Sussex the author bored a well in 1896 for the London and Brighton Railway Co., upon an anticlinal fold of the Weald. Very little water was found, but gas at considerable pressure had been enclosed by the impermeable dome, and has since been used to light the Company's station. But the oil with which it is associated is probably only that small amount which was proved by the subwealden boring in Limekiln Wood, near Battle, and has long been known to be contained in the Kimeridge Clay which has for years been worked for oil at Wareham in Dorsetshire.

Surprise is sometimes expressed that within a small distance of each other some borings yield good supplies of oil, while others close by are barren. But we cannot know the hidden geology of any area, even if the surrounding outcrops appear to point to continuity and conformity. Thus who was to know, until the classical bore-hole was made at Meux's brewery in Tottenham Court Road, London, that when the lower Greensand was being deposited in a salt sea the site of London was an uprising above sea level of a mound or ridge of Devonian rock, so that the greensand Sea extended only to a point under the above brewery. Take the map of Ireland and look at the deep indentations of the south-west coast, Bantry Bay, Dingle Bay, the Kenmare River and Dunmanus Bay. Imagine this area gradually to sink deep below sea level and to be wholly covered with clay. Then according as a bore-hole was put down from the surface above what is now hard rock, or above what is now the sea, so would the thickness of the surface stratum of clay vary by many hundred feet. The cliffs being vertical in places, this difference of thickness might occur in a distance of a few feet. A fault would possibly be declared to exist, whereas the difference would merely be due to the ancient marine action, which has left standing these upturned hard rocks whose synclinal folds may have an equal dip below the waves that the anticlinal folds have a rise above them. Such natural features as appear in present day surface geology may be fairly assumed to have formed the ancient floor on which more recent strata have since been deposited.

The presence of oil in any stratum does not necessarily indicate that it was formed in that stratum. It may have found its way there by reason of the superincumbent pressure of the overlying strata, or it may have reached such stratum vaporized by heat and there condensed to liquid. Or again, it may have been forced to leave some earlier location, no matter how it reached such earlier location, by the superior pressure of water. Water indeed has much to do with what, for lack of a better

term, may be called the hydrogeology of petroleum. When a petroleum well gushes, it does so because the oil is being pressed upon by water, which, but for the presence of oil, would itself rise near to or above the surface.

A case may be pictured, as in Fig 0, where a porous stratum *m* is fed with water from the surface at *S*. This water escapes by some opening to the surface, or it may flow away in the direction of *c* to some surface spring at the level of the water line marked *W.L.1*.

In the anticlinal fold or dome under the point *A* there would be a reservoir of oil under a water pressure equal to *P*. A bore-hole at *A*, right above the ridge of this buried anticline, would

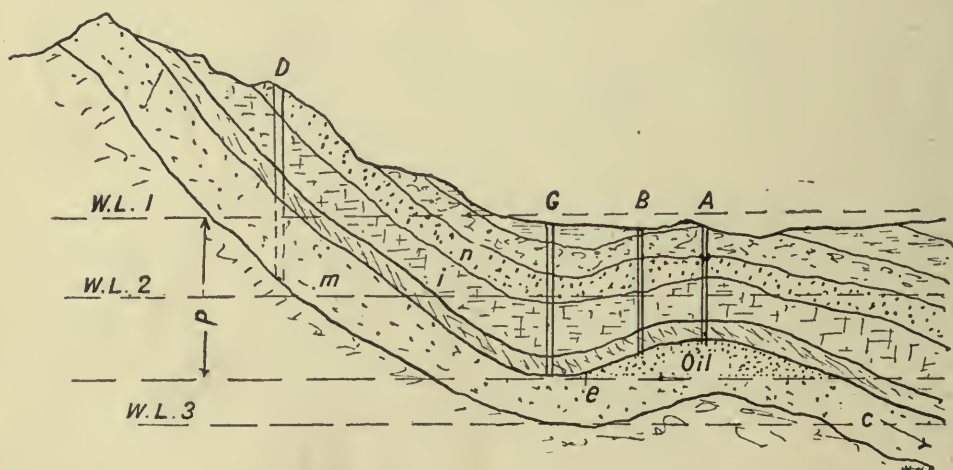

Fig. 0.—HYPOTHETICAL SECTION OF OIL-BEARING STRATIFICATION.

allow this pool of oil to escape at the surface as a gusher. And when all the oil had escaped the well would yield water.

Similarly a boring at *B* would yield oil equally freely, but water would follow while still the crown of the dome contained oil above the upper dotted line. A well at *G* would yield water from the first, while at *D* neither oil nor water would be found unless the bore-hole was carried down below *W.L.1*.

Let all the conditions remain the same, except that the water level stands at the line *W.L.2*. The same results would happen, except that the wells would not yield above the surface. They would be known as pumping or baling wells. The hole *D* would pass through the water-bearing stratum on to the left of the water level, and would therefore be dry. It is easy to multiply these assumed geological forms in order to account for every peculiarity that may be met with.

Readers can picture for themselves the very much wider fields over which boring would be successful if the water only

stood at *W.L.3*, for with suitable stratification to the right of *c*, it would be possible for oil to fill the stratum *m* even to the surface, and the whole of the oil could be finally baled, and without meeting with water. Nor is it necessary to assume the existence of a buried anticlinal. A mere frustrum may alone have been left by surface denudation and borings along the side slopes of this frustrum may reach oil. But a gushing well demands artesian pressure or gas as its acting force.

The boring of an oil well is complicated by the occurrence of water-bearing strata above the oil-bearing stratum, and it is possible to let down this upper water into the oil stratum below in such a way as to force away the oil and render large areas barren of oil. Hence the extreme importance of shutting out such water by casing tubes tightly inserted.

Thus if *n* was a water-bearing stratum the casing pipe must pass through this and enter well into an impermeable stratum below, such as let it be supposed *i* may be.

Where the slopes of an anticline are steeply inclined the oil fields will be very narrow, and this explains the closely spaced derricks seen on some fields extended in a narrow line along the anticlinal ridge. Every bore-hole that is put down affords figures from which the underground contour of the rocks can gradually be worked up, and plots of land gain or lose in value as it becomes easier to make definite statements as to the depth to the oil stratum and the certainty of being to the left or right of points, such as *e*, on which yield depends. An inspection of Fig. 1 will serve to show how easy it may be to drive casing so as to shut off a supply of oil, and how it might also happen that instead of oil, water would be obtained. It is also clear that a well may cease to yield oil sooner than it would do if the casing had not been driven too far. Thus a well that has ceased to yield might, on occasion, be again brought in by perforating the casing at a suitable horizon.

Any attempt to prove oil or find it without some surface indication is considered to be speculative or of a "wild cat" order. But there can be very little doubt that great deposits of oil are lying hidden beneath rocks which are completely shut down below superincumbent strata and have no outlet to the surface by which they can give the faintest indication of their presence. Oil exploitation so far has been carried out on the lines of working coal seams from their outcrop only. Coal is a regular geological stratum, and its presence may be inferred at long distances from any outcrop, as it was inferred at Dover as a result of the artesian boring in Tottenham Court Road. But oil is not a geological positive fact, for it may be

found to-day far from its point of formation, as stated above, having suffered lateral or vertical transfer by the agencies of heat, water, gas or gravity. It is therefore liable to be found in strata of all geological periods. If present in Great Britain in serious quantity it is probable that it will only be found at very great depths. Very little is known of the deep-seated rocks of Britain below the coal measures, and the deepest coal mine is not much over half a mile. But the recent strata of the south-east of England are now known to lie unexpectedly and unconformably upon ancient rocks of Devonian and Silurian and also Carboniferous age. So that the unexpected may yet happen in the shape of a petroleum field in Great Britain, possibly in the deep-seated Old Red Series which are known to yield salt water and suspectedly petroliferous.

Petroleum Drilling and Pumping

Oil wells are bored by the aid of a derrick about 50 to 80 feet in height ; 72 feet being a very usual height. A derrick is built up of four stout inclined corner posts, braced by horizontal struts and diagonals. Many modern derricks are of steel.

The tool usually employed is a heavy chisel attached to a heavy sinker bar. Sinker bars vary in size from $2\frac{1}{2}$ inches square by 30 feet long up to $7'' \times 15$ feet. They are raised and lowered, by a rope or by a line of iron rods or poles. A rapid up and down stroke is given by means of a walking beam to which the rope or rods are attached by a long screw frame or temper screw, or by a chain from a winch carried on the beam itself. The rope is let out by turning the temper screw as the chisel cuts the rock and the rods are lowered gradually by the winch. Débris is removed by drawing up the line of tools and lowering the sand pump or shell,—a long tube with a valve at its foot, by means of a winch and rope over a pulley at the top of the derrick. The walking beam and the winch barrel are set in motion by means of belts from pulleys on shafts driven by an engine, such belts being slack, but tightened up to working tension by pressure from lever-actuated jockey pulleys. Other levers control the band brakes which hold the mechanism securely at rest when needed. A second winch raises and lowers the casing tubes. In Russia wells may start with casing as big as 24 or 36 inches diameter. In America wells are usually 8 and 10 inches, finishing as small as 4 inches.

Another system of boring is the rotary system, by which the casing itself forms the tool and is rotated by gearing at the

surface and sinks through loose strata by the aid of a flush of water forced down the casing, and escaping into the strata through which the casing penetrates, or making its way to the surface outside the pipe.

Boring operations are simple while things go well, but ropes and rods break, the bore-hole walls fall in, the chisel is jammed fast or the casing collapses under heavy pressure from without, and a great variety of salvage or fishing tools are made to combat these contingencies. Hence the need for strength and the reliability given by Low-moor or Farnley iron for special items.

Owing to the inflammability of the gas and oil which a well may yield, the boiler is kept well back from the derrick, and the engine is connected by a long belt to the mechanism of the rig.

Derricks are now frequently formed entirely of steel.

Casing consists of lengths of steel pipe screwed to a butt joint and socketed. They are used in random lengths, unlike the English artesian system of using dead lengths of 10 or 12 feet, which render it so much easier to know the exact depths to which casing has been driven.

When oil has been obtained, but does not flow to the surface, it is raised by the baler, a long pipe with a valve at its base, which is lowered by a winch and rope into the oil and hauled up full of oil. Baling may be continuous night and day at maximum possible yield, or, if supplies are poor, baling will be done morning and evening for as long as desirable, the oil accumulating in the day and night between baling times.

Or pumps may be employed, and on some fields many pumps are worked from one central engine by means of a crank rotating on a vertical spindle and hauling upon a number of tension ropes attached to the pumps like spokes radiating from a central hub. When the oil is not too deep below surface the air lift pump may be employed, though this is expensive to work, owing to the general low efficiency of compressed air, but it has some very serious advantages.

Given that the oil is present in a well, more can be raised by the air lift in a given time than by any other system. This is specially valuable where there is a free supply of oil and the well is of small diameter.

There are no moving parts down the well. Any number of wells can be pumped from a single power station, the compressed air being carried to each well by a branch from an air main.

The central power station may be at any distance from the wells, so avoiding all risk of fire.

Oil containing sand can be raised with ease. Sand causes a good deal of wear in pumps. Both pumps and balers can be

worked with safety by enclosed electric motors, the current being brought from a safely distant power-generating station.

In using boring systems which involve the employment of water flushing for débris removal, there is risk in some circumstances that the oil when reached may be driven away by the water flush and passed by without its presence being suspected. Engineers should always be alive to this danger.

Diamond rotary drilling is not employed for oil drilling, for the "crowns" become too expensive for the size of holes required to be drilled.

Hard rocks may be easily penetrated by the rotary process with chilled steel shot. But this system requires a flush of water with its possible disadvantages. The ordinary method with heavy crushing chisel has the very serious disadvantage that it smashes everything to a pulp, and destroys the best of the fossil evidences of the rocks passed through.

CHAPTER II

THE ECONOMIES OF LIQUID FUEL

IN considering the application of liquid fuel every case must be taken by itself and the costs evaluated. In favour of oil there is, first, the ease and rapidity with which a liquid can be taken into store and delivered to the bunkers of a ship or the tank of a locomotive. Next there is the economy of labour, which may be almost nil in case of a single boiler with one attendant to the engine and boiler, or it may be very great where there are many boilers.

The superior calorific power of oil must then be equated with the price, and the cost per unit of evaporation found from this.

The removal of cinders and ash may or may not be a matter of cost, according to the demand for them locally.

Liquid fuel possesses great elasticity of use and fits well with sudden and varied demands for power. Hence its value in railroad work, electric light work, and other power stations where loads vary greatly.

Where the mixed system is employed, as with the Great Eastern Railway, the mere question of economy, as based on the actual weight of fuel consumed, is to be found as follows :

A locomotive consumes N units of coal per unit distance. When running with coal and oil, it is found to consume

M units of coal.

O „ „ oil.

The price of coal is y ; of oil x per unit.

$$\text{Then } O \times \frac{x}{1,000} + M \times y \leq N \times \frac{y}{1,000}, \text{ or } x \leq \frac{y}{O} (N - M).$$

The cost of oil is largely a matter of carriage. What costs three francs = 2s. 6d. per ton at Baku costs 185 francs = £7 8s. 6d. in France. The difference of 182 francs is made up of railway and sea carriage, handling, customs, warehousing. The customs stand for ninety francs, so that the same oil at an English port should not cost over £3 16s.

American residues cost five to six francs more than Russian mazut, whence MM. Colonne and Lordier, who give the above figures, dismiss oil as an economical fuel in France pending the reduction of the tariff.

On the Southern Pacific Railroad the relative evaporation of oil and coal is 365 : 274, or 33 per cent. in favour of oil.

On the International and Great Northern four barrels of oil proved more than equal to a ton of coal, and at 12s. 6d. per ton and 2s. 4d. per barrel the economy of oil was 13 to 14 per cent., including the economy of handling and storing.

To produce 1,000 units of steam, coal gives out more carbonic acid than oil, though the oil destroys quite as much oxygen and reduces the life-supporting power of the air to probably equal extent. So long as combustion is perfect and no actual poisons are made, there is not much to choose between the two fuels beyond their sulphur contents. As regards the safety of oil, it has been shown that oil with $117^{\circ}\text{C.} = 239^{\circ}\text{F.}$ flash-point did not ignite if fired at with shell, nor did dynamite exploded in a reservoir of this oil do more than throw up jets of oil which did not ignite.

Any danger with liquid fuels is with the oils which have not parted with their inflammable and volatile gases. This is a danger with oils when used absolutely crude. Purged of these portions, however, oil is safe, and, moreover, unlike coal, it contains no power of spontaneous combustion. Though it is claimed by some that oil does not deteriorate if kept in tanks, others do claim that a certain deterioration is produced which renders it difficult to atomize, the oil becoming more thick and viscid.

In Russia circular atomizers are often employed which give out a large hollow flame. The Béreznef atomizer, is one of these. They have the disadvantage of being out of reach in the middle of the fire of a locomotive, and they become burned also through being in such close contact with the flame.

Steam enters below a central disc, and oil flows under a head of two to three metres on the upper side of the disc.

The advantage of this form is said to be its constant output.

Too much mazut produces smoke, too much steam is wasteful. There is a certain fixed ratio of oil and steam to give the best result. The Issaïef atomizer, which resembles the Béreznef, will feed 50 to 100 kilos. of oil per hour (110 to 220 lb.), and it consumes nearly 0.4 kilos. = 88 lb. of steam at 4 to 5 atmospheres pressure per kilo. of oil (2.2 lb.). The table,

DATA.	NO. OF TEST.				
	1 3 atomizers Béreznef	2 4 atomizers Kroupka	3 1 atomizer Béreznef	4 3 atomizers Béreznef	5 3 atomizers Baschinine
Duration of trial. Hours .	12 hrs.	10h 30m.	10h 30m.	7 hrs.	9 hrs.
Total kilos. of oil consumed.	2193 k.	795·7	1,104	1,183	1,183
Mean boiler pressures in atmospheres	4·5	5·0	4·5	5·0	4·75
Mean temperature of feed water	41°C.	38°C.	46 6°C.	19 2°C.	20·2°C.
Litres of water fed to boilers	31,096	11,912	16,232	16,284	16,832
Kilograms of water fed to boilers	29,140	11,122	15,071	15,805	16,310
Kilograms of steam produced at feed temperature per kilo. of oil	14·17	14 9	14·7	13·76	14·22
Kilograms of steam produced from 0°C. per kilo. of oil .	13·28	1 9	13·65	13·36	13·78
Oil per hour per square metre of grate surface. Kilos. . .	0·987	1·131	1·569	1·469	1·143
Steam per hour per square metre of grate surface. Kilos.	13·1	15·81	21·42	19·633	15·758
Temperature of of feed water of chimney gas of air above boilers	120°C.	85°	87·3°	63·9°	64·6°
	132°C.	130°	139·1°	90°	80°
	27°C.	27°	20°	27°	26·8°
Atomizing steam per kilo. of oil. Kilos.	—	0·422	0·364	—	—
Heating surface. Sq. metres	185	60	60	115	115

1 square metre = 10·76 square feet. Kilograms per square metre ÷ 5 = pounds per square foot nearly.

above, is given by M. Keller, of Moscow, as the result of tests made with various atomizers.

M. Bertin, in dealing with the efficiency of liquid fuels, points out that a fuel containing 85 per cent. of carbon and 14 per cent. of hydrogen, will consume the oxygen of 7·56 cubic metres of air to satisfy the carbon, and of 2·72 metres to satisfy the hydrogen, or 10·28 cubic metres in all. By adding 40 per cent. excess of air, or 14·4 cubic metres = 18·7 kilos. of air per kilo. of oil, then combustion will be perfect and smokeless.

The Author's own figure for the weight of air chemically necessary for the above sample would be 14·7 nearly, and 40 per cent. excess would increase this to 20·56. M. Bertin's figure of 18·7 appears to represent about 27 per cent. air excess.

The theoretical temperature of combustion will be—

$$\frac{11,000}{(18·7 + 1) \times 0·23} = 2,480°C. = 4,496°F.$$

If the gases leave the boiler at $300^{\circ}\text{C.} = 572^{\circ}\text{F.}$ the loss of heat will be $\frac{300}{2,480} = 12.10$ per cent. of the total, which is equi-

valent to an increased efficiency of 6.65 per cent. as compared with coal. He further estimates a gain of 1.9 per cent. over coal in the absence of ashes and their cooling (on board ships).

The efficiency of a boiler estimated at 75 per cent. for coal, becomes 0.835 for oil firing, or $0.75 + 0.0665 + 0.019 = 0.835$.

But good combustion and utilization still further favour oil

in the ratio $\frac{.835}{.65} = 1.28 = m$; m becoming then $r = 1.20 \times$

$1.28 = 1.53$; the figure 1.20 being the chemical ratio of power of coal and oil. In Torpedo-boat No. 62 (French) M. Bertin, however, only obtained $m = 1.11$ and $r = 1.33$. The causes of the difference are found in the nature of the flame of oil, which has less radiating power than the flame of coal, and the powerful effect of the directly heated coal furnace is sacrificed, and to secure the same results an undesirable extension of heating surface would be necessary.

Secondly, the flame of oil is long if care be not taken suitably to arrange the burners. It may pass between the tubes and become extinguished, and the gases partly burned may even relight in the chimney. The chemical action and reactions of a burning spray of oil may be very much complicated by dissociation or even by exothermic formations, which may delay heat production. Later when combustion becomes active as shown by the light giving power of the flames, it will be more or less rapid according to the perfection of air admixture, and will last for a time $= t$, during which the jet, travelling at a high velocity, v , passes through a distance $L = vt$, which may be yards in length.

Thus the course of the gas must be long, or it may escape too hot to the chimney. Hence arises the necessity of cutting short the flame by early admixture and high temperature, so as not to lose the benefit of the boiler-heating surface.

It is for this purpose that in most successful oil-burning furnaces the jet of atomized oil is directed upon a brick obstruction of some kind so as to spread the flames and cause them to fill the furnace space and lick round the plate surface. Locomotive fireboxes may be studied, as in Fig. 26 to show how this effect is secured before the gases escape to the small tubes.

General Principles of Liquid Combustion.—A review of the

whole subject, in the light of chemical knowledge, of the claims of manufacturers and of users of liquid fuel, shows that successfully to burn a liquid it must be finely pulverized, to do which it must be heated sufficiently to destroy its viscosity and enable the spraying agent, air or steam, to tear it up and disperse it in a fine spray intimately mixed with air. The correct amount of air must be admitted to burn the liquid, and this is one of the advantages of employing air as the atomizing agent. Where sufficient air cannot be introduced with the fuel, it must be admitted from below, as through grate bars covered with broken bricks. Steam, preferably superheated, is the most convenient to employ as the atomizing agent, but on the salt seas has the disadvantage of wasting from 3 to 5 per cent. of the steam made by the boilers, and this loss must be made good by evaporators.

As with bituminous coal, which, like oil, is a complex hydrocarbon, liquid fuel should be burned in furnaces more or less protected from immediate loss of heat to the boiler surfaces by means of linings or baffles of firebrick. Liquid fuel, however, is more easy to burn completely than is coal, because it can be more intimately mixed with the necessary air. The interior of a combustion chamber should show a clear white incandescence with little apparent flame, and no smoke or unburned gases coming from the chimney. If looked into through a piece of violet-coloured glass, the interior of the combustion chamber with its brick linings should show a light lavender colour indicative of perfect combustion, with the production of actinic rays indicative of high chemical action. A chilled fire, such as is produced where a boiler is placed close upon the furnace of a coal fire, will show very little light indeed through a violet glass, its flames being cut down from several feet in length to a few inches only in many instances, the flames of yellow and reddish intensity being resolved into streams of dun-coloured gas which throw off no light of sufficient actinic power to penetrate the glass.

Much difference of opinion exists in regard to the flash-point of the oil to be used. Crude oil is so widely different a product, according as it comes from one or another locality, that no rule can be laid down as to its safety or otherwise. Those crude oils which, like the Pennsylvania oil, give a large proportion of gasolene and other volatile compounds, are not used in their crude form because they pay better to refine, the heavier residuum being used as fuel and being much safer. The use of volatile liquids is only undesirable on the score of safety. Some of the crude oils, as for example those of the Beaumont

field of Texas, contain so little of the lighter oils that they are used as fuel in their crude form. The one thing to note is that the more highly volatile oils have an element of danger from which the heavy oils are free, and this danger intensifies the results of every possible accident that may occur, especially such as arise from rupture of an overhead tank and the gravitation of the oil to lower points. The whole question is really very simple, and resolves itself into an intimate mixture with air in sufficient quantity and a proper conservation of the temperature pending full combustion. Fortunately for liquid fuels, these items are not only easy to realize, but failure, when they are not realized, is far more disastrous and complete than in the case of solid fuels. Hence the really simple problem of burning bituminous coal has never been properly solved, except in a few cases. At the same time it is easy of solution, but if not solved it does not produce the same bad effects as does the faulty combustion of liquid fuel. In regard to this question, the Author would like to point out that, where coal is burned in a refractory furnace, it should be capable of burning perfectly, with less excess of air, and coal ought to give results more nearly approaching its true value than it does do in ordinary faulty daily practice. Probably all the comparisons given in this book, except, perhaps to some extent those of locomotives, are too favourable to liquid fuel, which is supplied with those essentials of perfect combustion that are withheld from coal.

This question of refractory linings is essential, and it is secured by bridge walls, overarching and, where fire-bars are left in place, by covering these with broken firebrick or by whole bricks laid on edge.

It does not seem possible to introduce all the necessary air with the fuel. A chemical minimum of fifteen pounds of air is necessary to supply the oxygen for the average hydrocarbon liquids, but probably at least 5 to 10 per cent. excess is required in the best practice, and this must come in below the oil spray, and should not be introduced in a single large stream, but divided up into numerous fine streams through perforated plates, or through a mass of broken bricks or loosely laid brickwork. In Fig. 51 is shown the arrangements of air admission at the floor of a water-tube boiler furnace which is in the right direction. The Weir boiler, Fig. 7, p. 121 is also suitably arranged for liquid fuel, as regards the lining of the furnace and combustion-chamber. Where liquid fuel is used alone the fire-grate would be covered with bricks laid on edge or simply broken into pieces of 2-inch cubes, and the atomizers would be arranged similarly to those of Fig. 51. The general conditions that have

been evolved are well shown in the various locomotive and stationary boiler furnaces illustrated in Part II.

In the Weir small water-tube boiler the sides of the Λ -shape furnace are lined in firebrick blocks which are threaded upon the middle widely spaced tubes which form the walls of the furnace proper.

The first row of the main body of tubes is similarly protected to form a refractory wall for the combustion chamber. Thus both the furnace and combustion-chamber are fully refractory on two sides. Such a boiler as this can be worked with coal entirely, with oil alone, or upon the mixed system, the brick linings enabling combustion to be carried out with smokeless and economical perfection.

By means of sight-holes the furnace can be examined, and the admission of air gradually increased until the gases become clear, clean, brightly incandescent red, and the opposite end of the furnace shows up clearly. So long as there is smoke-formation the opposite brickwork cannot be seen. As soon as combustion is perfect it appears clear and bright red, and the air should then be cut down in quantity until an occasional streak of dark-coloured gas begins to show, thus proving that under the conditions of the furnace the air has been reduced to a possible minimum.

Under some conditions of boilers it would appear that to ensure smokeless combustion of liquid fuel, not more than 2 to 3 lb. should be consumed per hour per cubic foot of combustion space. This will have considerable bearing upon the question of furnaces with or without fire-grates, the latter type more easily securing the requisite volume. The above figure may be borne in mind when considering the question of furnace dimensions. More recent practice is claimed to give a nearly smokeless combustion with a rate of 20 lb. of oil per cubic foot per hour.

The term liquid fuel is herein limited to—

1. Coal gas tar, creosote, coke oven tars, blast furnace tars, and the tar from oil gas manufacture and other products of the destructive distillation of fuels, including the more volatile naphthas.
2. Petroleum and other mineral oils found liquid in nature or distilled from bituminous shales.

In a work of this nature, also, it would not be possible to take notice of all the uses of liquid fuels. For the purposes of this book, therefore, liquid fuel includes the products under sections 1 and 2 which do not possess a volatility or refinement greater than those of the heavy paraffin series or lighting oils.

The crude mineral oils of course contain such volatile consti-

tments, and may be used in their crude form, but usually the superior value of the distillates leads to these being first separated, the coarse residuum known as *astatki* or *mazut* being the oil so much used as fuel. Having been deprived of its more volatile portions, it is safer to carry and to use.

A liquid will not burn when cold, and cannot be ignited in mass. If heated to the point of ebullition and supplied with air, it will of course burn fiercely and uncontrollably. The art of burning liquid fuel consists in heating only the portion which is to be immediately burned and exposing it to contact with air. Unlike coal, it is not possible to burn it at many surfaces. A coal fire is made up of many pieces of coal, each burning over its whole surface. Liquid fuel will not lie on a grate in separate pieces. If, however, a layer of liquid were heated to vaporizing point, or nearly so, on a finely perforated plate, and highly heated air were forced through the perforations, the liquid would no doubt burn freely with strong flame, but the mass of heated liquid would be difficult to control. Hence in practice we arrive at those systems which employ a jet of air or steam to split up a stream of liquid into fine globules in presence of a sufficient supply to air. Each globule burns superficially and becomes heated by its own combustion and the general heat of the furnace, and this principle appears to be the best and most effective method of burning liquids. Indeed, it is perhaps the best method of burning anything, first to reduce it into particles so fine that their bulk bears a small ratio to their surface area, whereby each particle is brought close to the air which it requires.

Atomizing.

The necessity for atomizing arises purely from the insufficient surface area of the fuel otherwise treated. A fire composed of lumps of coal is full of interstices, and the area of the fuel exposed to air is much greater than the area of the fire-grate.

Liquid fuel would fall through the grate. It cannot be burned on a flat surface, because, being liquid, it tends to flow together and presents only an upper surface to the air. The use of trough-shaped bars along which the liquid flows and through which streams of air are admitted, does not get over the difficulty of small exposure of surface.

There is no incandescent mass through which air is flowing to carry off the fuel in a burned state and to maintain the mass incandescent. If the whole of the liquid mass in a furnace did become incandescent, or even approached that point, it would

distil in the form of vapour, and, if provided with air, would burn away uncontrollably, probably with great evolution of smoke. The more easily combustible or volatile portions would disappear first and the remainder would probably be left over unconsumed. Thus if the fire is to be controllable, the fuel must be supplied as it is consumed, so that at no time is there any serious amount of burning fuel in the furnace, and the production of steam is at once regulated by a simple regulation of the fuel supply. This end is secured by atomizing the fuel and discharging it into the furnace mixed with air, so that each atom of fuel is in contact with air, and combustion is easily effected. It will be found that with all the heavy liquid fuels atomizing is essential.

Vaporizing.

With lighter oil, as the cheap lamp oils used in steam motor cars, the liquid is supplied through a coil of pipe heated by the flame itself and is converted into vapour, which burns freely when mixed with air. With this oil it is not found that a deposit of carbon takes place in the retort coil, as might be the case with heavier oils. The lighter oils already prepared by distillation at a moderate temperature can thus be burned without atomizing, but, after all, their resolution into the form of vapour may be taken as the most complete form of atomization, and atomization is really a substitute for vaporization.

Varieties of Liquid Fuel.

In nature liquid hydrocarbon is found both free and absorbed. The free liquid is obtained from bore-holes put down to the oil-bearing stratum. When not free it is obtained by distillation from bituminous shales. The latter have been more employed for lighting or illuminating and lubricating purposes. The free oil or petroleum has forced its way into consideration as a fuel, having been employed now for many years in Russia. In addition to the natural oils, there are many hydrocarbons formed in the arts which have a high value as fuel. Of these there is the tar of the gas-works, a black viscous liquid which separates out from the gas in the process of cooling. It is formed in the hydraulic main and in the pipe coolers and condensers. A thinner tar is produced in the condenser of oil-gas plant as a product of the destructive distillation of oil in the Pintsch gas process. Where blast furnaces are fed with coal in place of coke, tar is produced in the condenser pipes of the

residuals plant, and in modern coke ovens a tar is also produced from the gas driven off the coal.

Crude petroleum contains many hydrocarbon compounds varying from the formula CH_4 up to $\text{C}_{11}, \text{H}_{37}$, the general formulæ being C_nH_{2n} and $\text{C}_n\text{H}_{2n+2}$ in an isomeric series of many numbers. When subject to distillation some of the compounds are split up, and certain compounds have been found to contain as much as 95 per cent. of carbon.

American Petroleum Fuels.

In the United States the oils principally sold for fuel purposes are the by-products of crude oil; their gravity varies from 23° Baumé to about 34° .

The oils of lower gravity are known usually under the name of Reduced Fuel Oil, and one of gravity 23 was found to analyse as follows—

Carbon	87.72
Hydrogen	11.45
Weight per gallon	7.62 pounds
Weight per imperial gallon	9.14 "
B.Th.U. per pound	19,800
Calories, per kilo.	11,000

The oils of higher gravity are known as Distillate Fuel Oil, and one at the extreme end of the scale, or 34° Baumé, analysed as follows—

Carbon.	86.19
Hydrogen	12.51
Weight per gallon (American)	7.11 pounds
Weight per imperial gallon	8.53 "
B.Th.U. per pound	20,250
Calories per kilo.	11,250

Oil being sold by the gallon an oil of 23 gravity contains 151,066 B.Th.U., and one of gravity 34 contains 143,988 B.Th.U. per U.S. gallon. ($8\frac{1}{3}$ lb. of water).

The heavier oil possesses the greater calorific capacity per gallon. It would be better practice to sell oil by weight or to state calorific capacities per gallon. For marine work the best oil contains the greatest heat-producing capacity per unit of volume, for this implies so much more efficiency of bunker capacity.

Approximately the two extreme oils named contain per imperial gallon (of 10 lb. water)—

Gravity 23°B	= 181,340 B.Th.U.
„ 34°B	= 172,870 B.Th.U.

An average oil measures about one million B.Th.U. per cubic foot, or 35,000,000 units per 35 cubic feet of space. A ton of coal which occupies about 35 cubic feet contains about 33,000,000 units of heat. In heat capacity, oil has the advantage over coal, apart from the fact that oil can be stored in small ballast tanks, and the coal bunker capacity of a ship can then be used for paying cargo.

Texas and California Oils.

These oils are used as they are found, that is to say, principally in crude form.

Determinations have been made of the calorific effect of these, and two are subjoined—

	B.Th.U.	Calories.
Lucas Well-Jefferson Co.	19,574	10,874
Higgins Oil & Fuel Co.—Jefferson Co. . . .	19,785	10,992

Texas oil is high in sulphur, containing this to the extent of 2 per cent. It is said that no injurious effects are produced upon fire-boxes or boiler-plates generally, and it appears rational that this should be so. The furnace products never pass away except at a temperature above that of saturated steam, and it appears unlikely that the dry hot furnace gases should condense to moisture on the boiler-plates, especially of highly heated high pressure boilers. Care is of course always necessary that furnace gases shall not make contact with any surface water cooled below 100° F. = 38°C. Otherwise corrosion may occur. Dry sulphur oxides, however, seem to be innocuous.

The Tables I, II, III, and IV are given by Sir Boverton Redwood, whose works may be consulted in all that relates to the chemistry of petroleum, which is too wide a subject fully to be dealt with here.

Six thousand heat units are, states Dr. Engler, rendered latent in liquefying carbon, but this appears doubtful, for the conversion of solid carbon into gaseous carbon is not proved to render latent more than 5,817 B.Th.U. per pound, though Berthelot states that there may be a further amount, which he denotes as *e*. It is improbable that the liquid form of carbon will absorb so much as 6,000 units. As regards water, the latent heat of liquid is only about one-seventh the latent heat of vaporization. It is probable that a considerable difference exists also in the case of carbon. Against this is to be placed

the fact that carbon has no intermediate state between solid and gaseous, but passes directly from one to the other when burned. It can only be said to be liquid when combined with other elements.

Russian Petroleum.

Russian oils are the inverse of the American oils, for while the latter contain about 25 per cent. of residuum, the former may contain 75 per cent. Astatki or residuum varies from 35 to 60 per cent. of the crude oil, and is really the chief product of the Russian oils.

The specific gravity of crude petroleum varies from 0.771 to 1.020, and the following general values are given by Sir Boverton Redwood.

	Sp. Gr.
Crude petroleum (Redwood)	0.771 to 1.020
American (Hofer)	0.785 to 0.936
Wyoming	0.945
Galician	0.799 to 0.902
Baku	0.854 to 0.899
Canada	0.859 to 0.877

The percentage of residue in various oils is given as follows—

Pennsylvania	5 to 10%
Galician	30 to 40%
Roumanian.	25 to 35%
Alsace	35 to 60%
Baku	36 to 60%

The composition of oils is thus very varied.

Creosote Oils.

Properly speaking, creosote is that distillate from coal tar which is intermediate between crude naphtha and pitch.

It is sometimes called dead oil and heavy oil, because its specific gravity is greater than unity.

In a wider sense creosote oil is understood to include the heavier oils from bituminous shales as well as the liquid deposited from coke oven and blast furnace gases. These various oils are all combustible, and though by no means properly called creosote, the distinction is not of importance as regards their value as fuel.

True creosote is probably too valuable as an antiseptic in wood preservation to allow of its very extensive use as fuel.

Coal tar creosote consists of that part of the tar which distils between 200°C. and 300°C., and includes various naphthalene bodies, etc. In colour it is yellow green and fluorescent. Its specific gravity is 1.10 to 1.024, according to quality, the

London made oils being heavier than provincial oils, simply because London is supplied largely with Newcastle coal, while country oils are from Midland coals of different quality.

As regards the constituents of creosote, the chief are naphthalene, carbolic acid and cresylic acid, and the composition of these bodies is as follows—

Creosote.

Constituent.	Formula.	Percentage composition.			
		Carbon.	Hydrogen.	Sp. Gr.	Melting Point.
Naphthalene . .	$C_{10}H_8$	93.75	6.25	0.978	79°C.
Carbolic acid . .	C_6H_6O	76.5	6.3	1.056	42°C.
Cresylic acid . .	C_7H_8O	77.78	7.4	1.04	33°C.

The foregoing is a very brief summary of the properties of creosote oils. Full information is to be found as regards the chemistry of the coal tar compounds, in vol. ii. of Allen's *Commercial Organic Analysis*. The above will serve to show that these tar products are largely combustible, and may be burned in the same way and with the same apparatus as used for petroleum.

The fuel oil of the Anglo-American Co. is crude oil deprived of its more volatile constituents. Its specific gravity is 0.893 to 0.910 at 60°F., and the closed test flash point is 220° to 250°C., and the calorific value 19,000 to 19,800 B.Th.U. per lb.

Blast furnace oil has a specific gravity of 0.988; shale oil creosote is similar. Coal tar from gas works has a specific gravity of 1.10 to 1.20, and is very complex in composition. London tar contains from 2.5 to 8 per cent. of ammoniacal liquor, 0.5 to 3.4 per cent. of light oils, 17 to 23 per cent. of creosote and carbolic oils, 13 to 17 per cent. of anthracene oils, and 58 to 62 per cent. of pitch.

The distillates from coal, bituminous shale and wood all contain more or less oxygenated bodies. Coal and shale distillates contain some nitrogenized bodies. Petroleum, on the other hand, contains only hydrocarbons.

Shale tar has a specific gravity of 0.865 to 0.894 according to the method of retorting practised. It consists of a complex mixture of hydrocarbons of the paraffin order C_nH_{2n+2} ; of the olefin order C_nH_{2n} , and of hydrocarbons C_nH_{2n-2} with some oxygenated bodies.

About thirty gallons of oil can be distilled from each ton of shale.

CHAPTER III

THE CHEMISTRY OF TEXAS PETROLEUM

IN *Bulletin No. 4 the Chemical Laboratory of the University of Texas*, Dr. E. Everhart gave the results of an examination of the Nacogdoches oil, the analysis having been made by Mr. P. H. Fitzhugh. The report says—

“The oil has a brownish-red colour. The odour is peculiar, but not so offensive as the crude petroleum of Pennsylvania. At ordinary temperature the oil is mobile, but not so much so as ordinary petroleum. Submitted to extreme cold, the oil still retains its liquidity, but becomes less mobile. The temperature of the oil was reduced to less than zero (Fahrenheit) without it losing its flowing qualities.

“At no temperature attainable in the laboratory by artificial means could any solid paraffin be separated. The oil does not gum on exposure to the air. It is not adapted to the production of illuminating oil; its value consists in its use as a lubricant.

“About four pounds of oil was subjected to distillation over the naked flame in a retort connected with proper condensers. The temperature was carried up to 680°F. At intervals of 45° each distillate was removed and its weight determined. The results of the distillation were as follows—

Analysis of Nacogdoches Oil.

	Per cent. by weight.
Below 300°F..	0·04
300° to 345°F.	0·37
345° to 390°F.	1·38
435° to 480°F.	3·14
480° to 525°F.	6·25
525° to 615°F.	7·07
615° to 680°F.	5·63
Remaining in the retort	74·03

“The above figures show that the crude petroleum is practi-

cally free from naphtha, which distils off below 250°F. Four pounds of this oil carried to a temperature 50° higher yielded only a few drops of a light oil, amounting to 0·04 per cent. of the total amount taken. In the Pennsylvania crude petroleum the illuminating oil comes off between 250° and 500°F., and, on an average, amounts to about 55 per cent. The Nacogdoches petroleum between the same degrees of temperature yields only a little over 7 per cent. Three-fourths of the oil does not boil until a temperature above the boiling point of mercury is reached. Above 400°F. and even lower the distillate is not pure white, but is somewhat coloured. This colour deepens on exposure to the atmosphere. The distillate exhibits fluorescence.

“The density at 62·6°F. is 0·9179. That of Pennsylvania oil is usually about 0·794 to 0·840. The co-efficient of expansion is 0·02568.”

Properties of Petroleum.

W. B. Phillips, Ph.D., of the University of Texas, says—

“In weight (specific gravity), taking water as 1,000, it varies from 650, as in certain oils from Koudako, Russia, to 1,020, as in the oil from the island of Zante. The range is, however, for the most part, between 770 and 940. A gallon of crude petroleum will vary from 6·41 pounds to 7·83 pounds for the United States gallon, and from 7·20 to 9·40 pounds for the Imperial gallon. Exclusive of the barrel, the 40 gallons, ordinarily spoken of as a barrel of oil, will weigh from 269·22 pounds to 328·86 pounds.

“With regard to its flow, crude petroleum may be quite mobile, as in the light-coloured varieties, or quite viscid, as in the black varieties. The temperature at which it becomes solid ranges from 82°F., as in oil from Burma, to several degrees below zero. The flash-point (the lowest temperature at which inflammable vapours are given off) varies from below zero, in certain oils from Italy, Sumatra, etc., to 370°F. in oils from the Gold Coast, Africa. The ordinary range of the flash-point, however, does not show such extreme limits.”

For oils whose flash-point lies below 60°F. the specific gravity ranges from 771 to 899, the average being 838. On the other hand, the oils whose flash-points are above the boiling-point of water have a range of specific gravity from 921 to 1,000, the average being 959. It is remarkable that a Roumanian oil with a flash-point of 24°F. should have had a specific gravity

of 899. As a general rule low specific gravity accompanies a low flash-point. In none of the examples examined, whose flash point was above the boiling-point of water, did the specific gravity fall below 921, the average being 959. There is a close connection between specific gravity and flash-point, for the presence of lighter oils, which are given off at a low temperature and are more inflammable, tends to reduce the weight of the oil as compared with water. This is not always so.

The boiling-point of crude petroleum varies from 180°F. with certain Pennsylvania oils, to 338°F. with oil from Hanover, Germany. The point at which oils become solid varies from 82°F. with oil from Burma, to below zero with oil from Italy and Sumatra.

The content of carbon varies from 79.5 per cent. to 88.7 per cent. ; of hydrogen from 9.6 per cent. to 14.8 per cent. ; of sulphur from 0.07 per cent. to above 2.00 per cent., and in rare cases even above 3.00 per cent. ; of nitrogen from 0.008 per cent. to 1.10 per cent.

Hydrocarbons of the olefin series occur in nearly all kinds of petroleum, but are specially characteristic of Russian petroleum from Baku.

Mabery has shown that the distillate from Beaumont oil coming over between 266° and 275°F., gave hydrocarbons of the acetylene and benzine series, and the same was true of the distillate coming over between 311° and 320°F. He also found this oil to contain 2.16 per cent. of sulphur and more than 1.00 per cent. of nitrogen.

There is no hard and fast line of demarcation. The chemical properties shade into each other, and only a general statement can be made that the oils from Pennsylvania fall into the paraffin series and the Russian into the olefin series, while the Beaumont oil is a third class distinguished by the presence of members of the acetylene and benzine groups.

Bituminous coal contains much less carbon and hydrogen and much more oxygen than petroleum. Anthracite coal has about the same amount of carbon as petroleum, but much less hydrogen and oxygen.

Mr. E. H. Earnshaw made an analysis of Corsicana oil, as follows:—

Analysis of Petroleum from Corsicana, Texas.

Fractions.	Temperature, F.	Per cent.		Sp. Gr. at 60°F.
		By Vol.	By Weight.	
Colourless				
A	130°-200°	2.80	2.24	0.6653
B	200°-250°	5.10	4.31	0.7017
C	250°-300°	7.60	6.69	0.7302
D	300°-350°	8.20	7.44	0.7527
E	350°-400°	9.40	8.75	0.7718
F	400°-450°	7.40	7.07	0.7920
G	450°-500°	8.30	8.09	0.8088
Very faint yellow				
H	500°-550°	6.45	6.43	0.8260
I	550°-600°	7.75	7.85	0.8404
Yellow, J	600°-650°	14.95	15.43	0.8555
Deep reddish yellow, K	650°-665°	17.25	18.07	0.8687
Deep red (solid), L, over	650°	1.30	1.41	0.8972
Dark red-brown (solid), M, over	650°	1.40	1.63	0.9669
Residue		2.63		
Total		97.90	98.04	

Mr. Thiele's remarks on the oil were as follows—

“The oil is very dark brown and opaque, but thin and fluid at 60°F. The specific gravity at 60°F. is 0.8292. The oil is closely related to the oil from Washington district, Penn., but contains asphaltum or bodies similar to it.

“Nacogdoches oil is heavy, specific gravity 0.915. The colour is black, and there is much sulphuretted hydrogen.

“Oil from Saratoga, Hardin county, is heavier, the specific gravity being 0.995. It is black and rich in asphaltum.

“Oil from Sour Lake, Hardin county, has a specific gravity of 0.963, and analyses as follows—

Analysis of Petroleum from Sour Lake, Hardin County, Texas.

Fractions.	Temperature F.	Per cent. by Vol.	Specific Gravity.	Colour, etc.
1				
2	212°-266°	0.07		Yellow
3	266°-320°	0.03		Yellow
4	320°-392°	1.59	0.684	Yellow
5	392°-572°	19.49	0.840	Yellow ; blue fluorescence
6				
7	572°-641°	5.15	0.782	Dark yellow
Residue .		71.11	0.978	Black
Total .		97.44		

In the *Journal of the Society of Chemical Industry*, vol. xix., No. 2, February 28, 1900, Mr. Clifford Richardson has the following—

Corsicana Oil.

Specific gravity, 68°F.	0.8457
Baumé	35.6 (about)
Flash	Ordinary temperature.
Volatile, 212°F.	10.8 per cent. (naphtha).
Volatile 324°F., 7 hours	35.7
Volatile 339°F., 5 hours	11.2
	57.7
Total	57.7

Residue, after heating to 323°F., flows readily at 68°F., appears to contain paraffin. After heating to 399°F. residue has a quick flow at 77°F.

Sour Lake Oil.

Specific gravity, 68°F.	0.9458
Baumé	18.0
Flash	244°F.
Volatile, 212°F.	22.8 (water with trace of oil)
Volatile, 324°F., 7 hours	12.6
Volatile, 399°F., 5 hours	14.4
	49.8
Total	49.8

Residue after heating to 324°F. flows readily at 70°F. After heating to 399°F., residue flows readily at 77°F.

The specific gravity of Corsicana petroleum is a little greater than that from near Dudley, Noble county, Ohio, 0.8457 to 0.8333.

Distilled under ordinary pressure, without particular precautions to prevent cracking, Mr. Thiele found—

Naphtha, 10.8 per cent.	Sp. Gr. 0.710
Kerosene, 54.5 per cent.	0.796
Residue, 34.7 per cent.	0.905

Twenty grams of the oil, heated for seven hours in an air bath at various temperatures in a crystallizing dish $2\frac{1}{4}$ inches in diameter by $1\frac{1}{2}$ inches high, left a residue of 43.3 per cent., which flowed readily at 77°F. The residuum resembles that from Pennsylvania and Ohio petroleum, and apparently contains paraffin scale. It is to a certain extent asphaltic. The crude, when distilled under a pressure of 1 inch of mercury, volatilized 51.2 per cent. at a temperature of 356°F., but began to "crack." Ohio oil did not begin to "crack" until 455°F.

at atmospheric pressure ; but the Sour Lake oil broke up at the same point as did the Corsicana. It is, therefore, a less stable oil than eastern petroleum.

The Sour Lake oil is a very heavy crude petroleum, 18B, and corresponds in many respects with some of the heavier California oils of Summerland and Los Angeles in appearance and properties. It flashes at a low point for such a heavy oil, 244°F.

Properties of various Petroleum.

The following table is taken from *Sadtler's Industrial Organic Chemistry*—

Crude Oil from	Sp. Gr. at 63°F.	Began to boil at °F.	Under 302°F. per cent.	302° to 572° per cent.	Over 581° per cent.
Texas-Corsicana	0·821	176	34·6	40·0	15·8
Pennsylvania . . .	0·818	180	21·0	38·0	40·7
Galicia	0·824	194	26·5	47·0	26·5
Baku	0·859	196	23·0	38·0	39·0
Alsace	0·907	275	33·0	50·0	47·0
Hanover.	0·899	238		32·0	68·0

Dr. W. H. Harper, Professor of Chemistry in the University of Texas, gives an analysis of a sample of Corsicana oil—

Colour, very dark brown, almost black ; opaque except in thin layers ; greenish fluorescence.

Viscosity, not determined, but the oil very mobile at 32° F. Sediment, none.

Water, none.

Flash-point, 73°F.

Specific gravity at 63·5°F., 0·8586, equivalent to 33° Baumé.

Calorific Capacity of Petroleum.

The B.Th.U. in petroleum vary from 17,000 to 20,000, one experiment giving 20,110. The value taken in Texas is 18,500 B.Th.U., or 10,277 calories. The scientific investigation of the coals, etc., used there, with respect to their heat units, has not progressed very far ; but it is not thought that, on the average, the B.Th.U. in the coals will be above 12,600, if indeed above 10,800, and are taken, for the present, at 11,700. For the lignites a lower value must be taken, and for the present this will be 9,900.

Some of the Alabama coals have 13,500 B.Th.U. ; good

McAlester coal (Indian Territory) may be taken at the same ; New Mexico coal at 12,000 ; and lignite at 9,900. On this basis one barrel of crude petroleum, weighing 320 lb. net. would be equivalent to 438 lb. of Alabama coal, and the same amount of McAlester coal, 493 lb. of New Mexico coal, and 598 lb. of lignite. A ton, 2,000 lb., of Alabama coal would then be equivalent to 4.56 barrels of petroleum ; a ton of McAlester coal to 4.56 barrels ; a ton of New Mexico coal to 4.06 barrels ; and a ton of lignite to 3.34 barrels. In other words, from $3\frac{1}{3}$ to $4\frac{1}{2}$ barrels contain as many heat units as a ton of the best coals and lignites of American Southern States.

Experiments made in California with a view to testing the relative value of the California oil and the coal with which it comes into competition, showed that a ton of Nanaimo coal, giving 12,031 B.Th.U., was equivalent to a minimum oil consumption of 3.45 barrels and a maximum consumption of 3.87 barrels. Experiments on Texas petroleum showed it to have 19,160 heat units, and this would be equivalent to 4.29 barrels per ton of Indian Territory coal. In Russia the usual equivalent is 3.12 barrels per ton of coal.

There is considerable variation in the quality of coal, and these differences are often observable in coal from the mine, due, perhaps, to carelessness in mining and handling, and to the absence of rigid inspection. In countries where coal is sold on the basis of heat units these discrepancies are less. Variations in the quality of oil from the same well are by no means so marked as in the case of coal from the same mine. The practice of piping different oil into the same storage tanks tends to advance uniformity.

The value of oil as compared with coal varies with the nature of the work to be done. It has been observed that in puddling and steel-heating furnaces $2\frac{1}{2}$ barrels of Los Angeles oil were equivalent to 2,000 pounds of Wellington coal from British Columbia, while for steaming purposes it took three barrels of the oil for one ton of the coal. In some establishments in Los Angeles the proportion rose to 3.62 barrels per ton ; in others, to 3.10. On the Southern Pacific Railway it has been found that four barrels of California oil were equivalent to one ton of Nanaimo, British Columbia, coal. The lowest consumption of oil per ton of coal that has been found is $2\frac{1}{2}$ barrels, while the highest is 4 barrels. In a general way, from $3\frac{1}{2}$ to 4 barrels of oil should be equivalent to a ton (2,000 pounds) of good soft coal. The lower figures may be reduced under good practice and management and the best appliances to $3\frac{1}{3}$ barrels ; while under bad management, etc., the higher figure may reach $4\frac{1}{2}$ barrels.

Advantages of Liquid Fuels.

The advantages to be derived from the use of liquid fuel are—

1. Diminished loss of heat up the funnel (or chimney), owing to the clean condition in which the boiler tubes can be kept, and to the smaller amount of air which has to pass through the combustion-chamber for a given fuel consumption.

2. A more equal distribution of heat in the combustion-chamber, as the doors do not have to be opened, and a higher efficiency is obtained; unequal strains on the boiler tubes, etc., due to undue heating, are also avoided.

3. No danger of having dirty fires on a hard run.

4. A reduction in the cost of handling fuel.

5. No firing tools or grate-bars are necessary; consequently the furnace lining, brickwork, etc., last longer.

6. Absence of dust, ashes and clinkers.

7. Petroleum does not deteriorate on storing, while coal does, especially soft coal. This opinion is not universal, however.

8. Ease with which the fire can be regulated from a low to a most intense heat in a short time.

9. Lessening of the amount of manual labour in stoking.

10. Great increase of steaming capacity, the difference being as much as 35 per cent. in favour of oil.

11. The absence of sulphur or other impurities, and longer life to plates, etc.; but considering the fact that the amount of sulphur in some of the oils now being used as fuel is in excess of the sulphur in ordinary coals, this point is not well taken. Sulphur is objectionable in any fuel, whether coal or oil, and of the two may be more objectionable in oil than in coal, for a portion of the sulphur in coal remains in the ashes, and is not consumed.

If crude petroleum, or the residue from refining plants, is to come into use on a large scale as fuel, there are some considerations that must be weighed, in addition to its fuel value, viz., its initial price, f.o.b. tanks or wells, transportation charges, and the like.

Profiting by the experiences in California and elsewhere in the use of oil for fuel, many industrial establishments in Texas changed from coal to oil. Among the first was the American Brewery, Houston, with two 200 h.p. and two 350 h.p. boilers. The oil was the residue from the refining plant at Corsicana, and it was estimated that 75 barrels a day would be required, as the coal consumption was about 25 tons a day. After running for a while, it was stated that the steaming capacity of the two 200 h.p. boilers using oil was equivalent

to that of the two 350 h.p. boilers using coal, and the saving of oil was about 33 per cent. The Star Flour Mills, Galveston, installed oil burners in April, 1901, using about 35 barrels a day for a 350 h.p. engine.

The first locomotive equipped for burning oil was delivered to the Gulf, Beaumont and Kansas City Railway, June 20, 1901, and belonged to the Gulf, Colorado and Santa Fé Railway. Up to the time of its reaching Beaumont it had travelled 450 miles, and consumed 42 barrels of oil, the tank having this capacity. The Southern Pacific Railway burns oil west of El Paso.

TESTS OF TEXAS OIL EFFICIENCY.

A report by Professor Denton states that the number of barrels of oil equivalent to 2,240 pounds of coal was 4.23 for one h.p. per about twenty square feet of heating surface, and 4.12 for one h.p. per 10 square feet of heating surface; and it appears that the average consumption of oil per ton of coal is four barrels, and that under some conditions this falls to 3.50 barrels. There may be consumers who use even less than this, but it is not thought that they represent the average practice.

Beaumont oil was used to operate a boiler at the plant of the West Side Hygeia Ice Company, West 19th Street, N.Y. City. There were three return tubular boilers, each 6 feet in diameter and 18 feet long, containing about 1,900 square feet of heating surface, two being used at a time to provide about 180 boiler h.p. from buckwheat coal, with natural draught under a very steady load throughout each 24 hours. One of these boilers was fitted for the tests with the Williams Oil Burner.

Effect of the Oil on the Boiler and Furnace.

After the steam-raising test, the boiler was operated 24 hours with oil, to use up all that remain of the 117 barrels provided for the evaporative test. It was then cooled, and the oil-burning apparatus removed to prepare the furnace for coal tests. The boiler and furnace were then examined. No trace was found of any action of the oil on the boiler. There was no oily matter on the internal brickwork, nor any discolouration of the latter, and there was less than $\frac{1}{64}$ of an inch of soot in the tubes, which had been swept clear of ashes at the beginning of the use of the oil.

The tests with oil were made at from 112 h.p. to 220 h.p. The boiler was 6 feet in diameter and 18 feet long of the horizontal return tube type. It had 100 tubes $2\frac{1}{2}$ inches in diameter,

and a grate surface of 45.5 square feet, i.e. 6 feet 6 inches by 7 feet 0 inches. Height of chimney, 70 feet high by 42 inches square. The *résumé* of the tests is as follows—

Résumé of Tests with Beaumont Crude Oil.

Duration, hours	3.5	8	11	13	11
Horse power	146.9	122.7	189.7	138.0	220.1
Steam pressure (gauge), lb..	87	86	86	86	86
Feed temperature, degs. F.	69°	90°	70°	90°	74°
Chimney temperature, degs. F.	374°	360°	398°	370°	425°
Quality of steam.	dry	dry	dry	dry	dry
Oil per hour per sq. ft. of heating surface, lb.	0.181	0.135	0.226	0.063	0.263
Dry steam per hour, from and at 212° per sq. ft. of heating surface, lb.	2.73	2.09	3.52	2.56	4.08
Heating surface per h.p., sq. ft.	12.6	16.5	9.8	13.5	8.45
Total dry steam per lb. of fuel as fired from and at 212°F., lb.	15.29	15.53	15.55	15.71	15.49
Per cent. of steam used by burner	3.6%	3.1%	4.8%	3.5%	4.8%
Net lb. of dry steam per lb. of fuel fired from and at 212°F.	14.74	15.05	14.80	15.16	14.75

Other figures are as follows—

Dimensions and Proportions.

Grate surface, sq. ft.	45.5
Water heating surface	1,860
Position of damper	Wide open
Area of opening of ash pits, sq. ft.	1.8

Average Pressures.

Steam pressure, by gauge, lb.	86.5
Draught pressure, inches of water	0.37

Average Temperatures, Fahr.

Fire room	53.1
Feed water entering boiler	74.0
Chimney gases	42.5

Fuel.

Weight of fuel as fired, lb.	5,393
--------------------------------------	-------

Steam.

Quality of steam	dry
----------------------------	-----

Water.

Total weight of water fed to boiler, lb.	70,798
Factor of evaporation	1.180
Equivalent water evaporated into dry steam from and at 212°F.	83,542

Economic Results.

Feed water per lb. of fuel as fired, lb.	13.13
Equivalent evaporation from and at 212°F. per lb. of fuel as fired, lb.	15.49
Equivalent evaporation from and at 212°F. per lb. of combustible, lb.	15.49

Efficiency.

Efficiency of boiler and furnace, or heat per lb. of fuel as fired, divided by calorific value per lb. of fuel	78.5%
Efficiency of boiler, or heat absorbed by boiler, per lb. of combustible, divided by calorific value per lb. of combustible	78.5%

Hourly Quantities.

Fuel as fired per hour, lb.	490.3
Fuel as fired per hour per sq. foot of grate, lb.	10.78
Combustible per hour per sq. foot of heating surface, lb.	0.263

Horse Power.

Horse power at 34.5 lb. from and at 212°	220.1
Heating surface per horse power, sq. feet	8.45

Compositions of Fuel.

	Per cent.
Carbon	85.03
Hydrogen	12.30
Oxygen and nitrogen	0.92
Sulphur	1.75

Heat Balance.

	B.Th.U.
Utilized in production of steam	14,963
Due to combustion of hydrogen	1,245
Wasted in superheating water products	113
Wasted in dry chimney gases	1,837
Radiation and imperfect combustion	902
Heat per lb. of fuel as fired, by calorimeter	19,060
Heat per lb. of combustible, by calorimeter	19,060

The weight of oil per gallon was 7.66 pounds, or 322 pounds per barrel of 42 American gallons of 231 cubic inches. The net evaporation, per pound of oil, from and at 212°F., was 15.1 pounds; per pound of Pennsylvania bituminous coal, in the best boilers at 10 square feet of heating surface per h.p. is 9.5 pounds; of the semi-bituminous coals, such as Pocahontas,

New River, Cumberland and Clearfield, it is 10·0 pounds, which may be increased to 10·5 and 11 pounds by mechanical stokers, or smoke-preventing devices.

Professor Denton calculates the comparative costs of oil and coal as follows—

Price of coal per ton of 2,240 lb.	Equiv. price of oil per barrel. of 42 gallons.
\$1.00 = 4/-	\$0.29 = 1/2½
1.50 = 6/-	0.43 = 1/9½
2.00 = 8/-	0.56 = 2·4
2.50 = 10/-	0.71 = 2/11½
3.00 = 12/-	0.85 = 3/6½
3.50 = 14/-	0.99 = 4/1½
4.00 = 16/-	1.13 = 4/8½
4.50 = 18/-	1.28 = 5/4

These figures apply to bituminous coals mined west of Ohio. In comparison with small sizes of anthracite, Pittsburg bituminous and Maryland and West Virginia semi-bituminous coals, and most or all British coals, oil must be sold at a less price, inasmuch as these fuels are of a better quality than Western and South-Western coals.

Evaporative Duty.

Professor Denton's results show that the net evaporation ranged from 14·74 to 15·16 pounds of water per pound of oil, the h.p. varying from 112 to 220 and the burner steam consumption from 3·1 to 4·8 per cent. of the boiler output. The boiler utilized about 78 per cent. of the heat of the fuel, which may be considered the best average boiler practice. It is also to be observed that the results in actual practice showed that 98 per cent. of the total heat of combustion of the oil, as determined by the calorimeter, was accounted for by the steam production, the chimney gases and a reasonable allowance for radiation. Professor Denton thinks that for a higher horsepower a net evaporation of 14·8 pounds of water is the best economy that can be expected from the use of oil as fuel with steam jet burners. This may be contrasted with 11·79 pounds yielded by excellent No. 1 buckwheat coal.

Considering the objections that have been raised against the use of crude oil, on account of its content of sulphur, it may be said that many excellent steam coals carry from 1·5 to 2 per cent of sulphur, and that the average life of a boiler does not seem to be impaired by their use. The amount of sulphur in the oil used by Professor Denton was 1·63 per cent. Allowing that a coal contains 1·7 per cent., an oil would have to contain 2·6 per cent. in order to put as much sulphur into the products of com-

bustion as the coal, equal horse-powers being assumed. It has been ascertained that the use of coal carrying more than 3 per cent. of sulphur does not cause any greater depreciation of fire-boxes, etc., than a coal of 1·7 per cent. of sulphur, and the sulphur equivalent in oil corresponding to 3 per cent. in coal is above 6 per cent. The objections to the use of crude oil, based on its sulphur content, do not appear to be well founded, in so far, at least, as concerns the integrity of fire-boxes, etc. Probably sulphur products are only seriously harmful when cooled to moisture point.

The inflammability of crude oil has been the subject of critical investigation. There was no inflammable vapour given off below 142°F. in Professor Denton's experiments; and he does not think that a pool of oil in a boiler room would become ignited from a lighted match or from the dropping of a live coal into it. It is also stated that a surplus of oil at the burner gave rise merely to a thick smoke; there was no explosion or excess of pressure.

One more point of a most important nature was brought out by the test. It was not a new point, for other tests have established the fact, and it is well known to those who study the economies of fuel consumption. It is the comparative efficiency of oil and coal referred to the heat balance.

	Oil.		Coal.	
	B.Th.U.	Per cent.	B.Th.U.	Per cent.
Utilized in production of steam. . .	14,963	78·5	8,636	71·4
Evaporation of moisture in fuel and due to combustion of hydrogen . .	1,245	6·5	277	2·3
Wasted in superheating water products	113	0·6	23	0·2
Wasted in dry chimney gases	1,837	9·7	1,981	16·4
Wasted in unconsumed carbon in ash	—	—	768	6·3
Radiation and imperfect combustion	902	4·7	415	3·4
Heat per pound of fuel as fired, by calorimeter	19,060	100·0	12,100	100·0
Heat per pound of combustible, by calorimeter	19,060	—	14,680	—

This table shows that more heat units were given off by the oil than corresponded with the total number of heat units in the coal, and that the percentage of heat units used was 78·5 of those in the oil, as against 71·4 of those in the coal; in other words the oil was more efficient than coal. The saving of the heat ordinarily wasted in dry chimney gases is especially noteworthy, for the oil shows a waste of 9·7 per cent., as against

16.4 for the coal. In comparison with coal yielding 12,100 B.Th.U. per pound as fired, and 14,680 per pound of combustible, there is a decided economy in the use of crude oil under the conditions maintained in this test.

That returns from consumers of oil show a difference of 43 per cent. (i.e. from 3.5 to 5) in the number of barrels of oil equivalent to a ton of good soft coal, is evidence that ordinary experience cannot be relied on to afford anything more than a rough approximation. If the ordinary steam installations were provided with smoke-preventing devices and mechanical stokers, it is very probable that the economy in the use of oil would not be so pronounced.

If all the economies possible in the use of the solid fuels were maintained, the comparison between these and oil would not be so strongly in favour of the latter. When smoke-preventing appliances are installed alone or in connection with mechanical stoking more particularly, a saving of more than 20 per cent. has been regularly obtained, with ordinary coals. It is to be doubted whether ordinary practice with solid fuels has attained its maximum economy. Establishments where great attention is paid to all possible economies in fuel consumption form the exceptions.

We may allow that the heat units in oil are more easily available for steam-raising purposes than the heat units in coal, and that, per unit of heating power, we get better results from oil than from coal. When we have once ascertained what we can get from the oil, we can calculate the relative advantages in the use of the two. It is, after all, a matter of cost, and each particular installation must be considered on its merits.

CHAPTER IV

THE CHEMICAL AND OTHER PROPERTIES OF PETROLEUM

IN a work of this description a deep study of the chemistry of liquid fuels is not necessary. For fuller information on petroleum chemistry the works of Sir Boverton Redwood may be studied.

Petroleum is a mixture of a series of hydrocarbons of the following types—

1. C_nH_{2n+2} Methane Series.
2. C_nH_{2n} Olefin Series.
3. C_nH_{2n-2}
4. " -4
5. " -6 Benzene Series.
6. " -8
7. " -10
8. " -12

Those named occur in the greatest quantity and most frequently. The first is a light gas in the form CH_4 , and as the values of n in each series grow larger, the members of the various series become liquid and finally solid.

Thus of the first or Methane series the first four are gaseous, Methane, Ethane, Propane, and Butane. Series 1 is liquid when $n = 5$ to 25. Above $n = 25$, the solids begin and generally in all the series a higher value of n implies a higher boiling point, and this rises with some regularity from $n = 9$, by about $20^\circ C. = 36^\circ F.$ for each additional carbon atom. Hence the ease with which fractional distillation can be carried on, the light oils (gasoline, ect.) distilling off up to $150^\circ C.$, the illuminating oils up to $300^\circ C.$, and the residuum being fuel oil, which still contains the lubricating oils.

Dr. Paul, in discussing Aydon's paper, suggested that liquid fuel had an advantage over solid fuel to the extent of 6,000 B.Th.U. per pound, which he claimed as the latent heat of liquefaction, but this is elsewhere shown to be nearer the latent heat of evaporation of carbon, while the latent heat of liquefaction is scarcely credited with more than 5 per cent. extra calorific power, and, as pointed out by Mr. C. E. L. Orde, the

Bombe calorimeter does not show anything like Dr. Paul's figure. It is also probable that when carbon and hydrogen of the liquid hydrocarbons united, they produced heat which more than counterbalances the effect of the latent heat of liquefaction. Indeed, methane gas, CH_4 , is known to produce, when burned, very much less heat than calculation would appear to indicate. Acetylene, on the contrary, produces more heat than calculable, being endothermic.

Water in Oil.

Fuel oil and water do not readily separate. They do not differ much in specific gravity, and oil is so viscous that the globules of water cannot force their way out of it. But oil is rendered more liquid by heat; it expands more than water, and separation is better effected by heating the oil. This is best done locally near the surface of the oil in the bunker, so that the heated oil is at once drawn off for use, and heat is not wasted in raising the temperature of the whole bunker.

The heat value of oil is reduced 13·14 B.Th.U. for each one per cent. of water.

Thus 1 pound of oil worth 18,831 B.Th.U. mixed with 10 per cent. of water, gives a mixture the value of which per pound is $(18,831 \times 0\cdot9) - 131\cdot4 = 16,816\cdot5$ B.Th.U., a difference of 1,915·5 B.Th.U., or a loss of nearly two pounds of evaporation from and at 212°F. Water also reduces the flame temperature, lengthens the flame and moves the point of highest temperature further along the flues, and so diminishes the values of the heating surface. Mr. Orde lays down the conditions which show perfect combustion as an opaque dazzling white flame for six inches from the nozzle, becoming semi-transparent and almost violet in colour at middle length, shading off to red at the end. With water mixed in, the violet colour does not appear (see chapter on Smoke) and the flame becomes dark red and smoke-fringed. He states that at a temperature of 140°F. = 60°C. it required seven days to separate the water completely in a tank of oil. Hence the use of a surface float as in Fig. 14a.

His figures for the calorific value of various oils, as found by the calorimeter, are as follows, and show a practical identity of value in all, as may be expected from their chemical composition—

Borneo	18,831 B.Th.U.
Texas	19,242 „
Caucasus	18,611 „
Burma	18,864 „

According to Pelouze and Cahours, there are thirty different hydrocarbons in petroleum, principally of the type C_nH_{2n+2} . For $n = 1$ and $n = 2$ the substance is a gas. For $n = 3$ the boiling point is $0^\circ C. = 32^\circ F.$ For $n = 5$ the liquid is very volatile, the lightest isolated by the above chemists being C_5H_{12} , boiling at $30^\circ C. = 77^\circ F.$ The fuel oils commence at C_8H_{18} , and go on to $C_{15}H_{32}$, beyond which $C_{20}H_{42}$ to $C_{28}H_{58}$ are semi-solid. The point of ebullition rises $20^\circ C. = 36^\circ F.$ for each increment of carbon from C_8H_{18} , which boils at $117^\circ = 242.6^\circ F.$ to $197^\circ C. = 386.6^\circ F.$ for $C_{12}H_{26}$; and $257^\circ C. = 494.6^\circ F.$ for $C_{15}H_{32}$. Similarly the specific gravity increases continually, though less regularly, than the boiling point from C_5H_{12} , for which it is 0.63, to $C_{15}H_{32}$, for which it is 0.83. The density of the hydrocarbon vapours relative to air are 0.5 for $n = 1$ to 7.5 for $n = 15$, or a growth of 0.5 for each grade.

The Russian oils do not follow the same empirical composition as the American, but belong rather to the ethylene series C_nH_{2n} and the isomers, and to the benzene series C_nH_{2n-6} , of which benzene C_6H_6 , is the characteristic member. In "cracking" the oils during distillation even lower forms are found: C_nH_{2n-8} ; C_nH_{2n-10} , which occur in the residues of distillation. Water may exist in the proportion of 5 per cent. for Baku oil to 10 per cent. for Borneo, but mineral matter is always small, and ash scarcely exceeds 0.3 to 0.4 per cent., but is an undesirable constituent for an engine, causing cylinder scoring.

By "cracking," the distilled liquid becomes more and more stable, and the final residue is a mere coke.

Petroleum distils more easily when superheated steam is blown through the still while below the "cracking" point. The effect is peculiar to steam and cannot be secured with air. It appears to be a sort of solution of the petroleum by the steam, and Mr. Bertin, of the French Marine Militaire, considers that this affords an explanation of the superior power of steam in atomizing liquid fuel. A study of distillation shows three sorts of petroleum suitable for fuel.

(A) Natural oils which have parted with their volatile portions under the influence of sun and air and become natural mazut.

Borneo oil which flashes at $100^\circ C. = 212^\circ F.$ is directly employed as fuel, and Texas oil appears to possess little other value than as fuel.

(B) Distillation residues, or mazut, which result from boiling off all the more volatile portions.

(C) American distilled oils as per page 44. These oils are very homogeneous and regular, but they emit inflammable vapours below the temperatures at which they boil.

The Physical Properties of Petroleum.

These have already been partly treated of under the previous head, but it may be added that in common with all hydrocarbons and fats, petroleum and other liquid fuels become more fluid and lose much of their viscosity when heated. Their fluidity increases rapidly with heat. Hence the better atomization possible with heated oils. Tests at Cherbourg on mazut at different temperatures show that flow of oil through an orifice of annular form half a millimetre wide was as follows in cubic centimetres per minute—

Temperature	6°C.	15°	35°	70°	100°
Flow	2.5	6.5	32	188	466

With water at 19°C., the flow was 4,300 c.cm.

Mazut is easily heated, its specific heat being 0.42.

Petroleum has a rapid expansion coefficient, as much as 0.0007 per degree Centigrade. This helps it to rid itself of water because, by heating the oil, both its sp. gr. and its resistance are reduced, and water can the more easily gravitate out.

Though petroleum has been supposed to be unaffected by storage, mazut changes when exposed to air even more rapidly than coal, according to M. Bertin, losing its fluidity and parting with some of its calorific power ; experiment seems to be wanting in regard to such changes taking place in closed tanks and not exposed to air. Any loss that may have been experienced may perhaps be attributed to a gradual evaporation of lighter oils still remaining. The lighter oils do possess the highest calorific capacity, and their loss would therefore to some extent reduce the calorific capacity of the residue.

In Russia the sp. gr. of oil for steam raising purposes at 17.5°C. = 63.5°F. must not exceed 911 to 912, and oil must contain no water, sand or alkali. When received the temperature must not exceed 50°C. = 122°F. and the flash point must be above 140° or 150°C. = 284° to 302°F.

Certain railroads stipulate a density of 905 to 915 at 14°R. = 63.5°F. There is no viscosity clause.

The Navigation Co. Caucase Mercure ask for a density of 926. The Russian Navy accepts a flash point of 100°C. = 212°F. and a density of 950. In America the minimum flash point of 200°F. is usual = 93.3°C.

Water in Oil.

To determine the water q the density d is found of the sample. After heating for some time at $103^{\circ}\text{C.} = 217.5^{\circ}\text{F.}$ the density is again found $=d_2$. The quantity of water q is determined by this relation $(1-q)d_2 + q = d$.

The coefficient of expansion per degree C. is assumed to be $0.000735 = 0.000408$ per degree F.

MATERIALS.

In the utilization of fuels for steam-raising it is necessary to have a knowledge more or less full of the whole of the materials which will be employed either as fuels or structurally. Something must also be known of the environment in which such substances will be employed.

A list of substances with which the engineer will be required to deal therefore includes, besides the fuel itself, air, water, cast-iron, steel, fire-brick, etc.

The conditions include the ordinary atmospheric temperatures and moisture, the pressure of the atmosphere, and so on.

The units in which ideas are expressed must also be clear.

With this object separate sections have been given to the subjects of Water, Air, and Heat in its various forms, to carbon and hydrogen, the only two practicable fuels. A few notes are given below concerning some of the other materials.

Cast-iron cannot be employed in the furnace, for it is rapidly destroyed by the action of fire, even when not directly in the flame. It should not be employed in the retort in which to heat and to gasify even the light-burning oils. Cast-iron tubes have been tried for this purpose, and have been found to become choked by a deposit of carbon, which may probably be due to some affinity between the carbon in the iron and that in the oil.

Cast-iron should never be employed as a material for any vessel exposed to internal pressure.

Steel.

Steel is *par excellence* the material for all parts of boilers. Like cast-iron, it will not withstand furnace temperatures except when backed by water, as in the case of the plates of a boiler.

Steel tubes only $\frac{1}{16}$ in. thick are employed by Clarkson as the retort coil in which paraffin is vaporized. These coils are in the zone of flame, and vaporize the oil on its way to the

burner which they surround. They possess a fair durability owing to the heat absorbing power of the vaporizing liquid, and they are found to keep free of carbon deposit.

Fire-Bricks.

The most important material for the furnace engineer is fire-clay, a material which is found beneath seams of coal.

In a properly-set boiler for coal burning the whole interior of the furnace and combustion chamber will be more or less fluxed and run partially into drops or stalactites, which hang from projecting edges. With liquid fuel, fire-brick is a most necessary material for promoting combustion. It is a bad conductor of heat, and has the property of resisting high temperatures known as refractoriness. High furnace temperatures will render even many fire-clays liquid at the surface.

Ordinary fire-clays contain 58 to 62 per cent. of silica, 36 to 38 per cent. of alumina, and from 1 to 3 per cent. of ferric oxide.

A large content of silica denotes a good and refractory brick.

Dowlais fire-brick contains $97\frac{1}{2}$ per cent. of silica and less than 2 per cent. of alumina, the remainder being oxide of iron, with a trace of lime and magnesia.

Ganister, which is so much used in steel work, contains 89 per cent. of silica, $5\frac{1}{2}$ of alumina, $2\frac{1}{2}$ of iron oxide, and $2\frac{1}{2}$ per cent. of material which is lost in burning.

A brick used in France is made from diatomaceous earth which is nearly pure silica. These French bricks are very porous and light, and when dry will float in water.

The best fire-clay comes from Stourbridge and Newcastle in England, Glenboig in Scotland, and Dinas in Wales.

Makers of fire-brick supply a great variety of shapes, and blocks can be had for seating purposes or for furnace work, notably for over-fire arches and combustion chambers.

Fire-bricks are also made for threading on water tubes, so as to build up refractory walls upon water tubes for the purpose of securing the correct direction of gases and for promoting perfect combustion and smokelessness. It is said that carborundum is very refractory indeed, and that when finely powdered and made into a paint with soluble glass or silicate of soda, and painted on bricks, it will greatly assist in their preservation. Or the bricks may be dipped in the solution. The carborundum surface is then most refractory.

Too little attention is paid by engineers to the fire-bricks they use, and heavy expenses are incurred in maintaining furnaces, expenses quite needless if proper attention is paid to the selection of the bricks.

When a furnace is to be repaired bricks are often purchased from the nearest wharf, where they have lain exposed to weather for weeks. In their water-saturated condition they are built into the furnace and exposed to the full heat, with the result that the interior of the bricks is disintegrated and the bricks split up at once.

When a fire-brick is made it should be fired at a temperature as high as that to which it will be exposed when at work.

The composition of bricks has a great influence upon their durability in certain surroundings. A silica brick will run like treacle in certain surroundings, and an alumina brick will fail in others, but a brick of alumina is as refractory as one of silica—indeed, more so as regards its ability to withstand high temperatures.

Having secured the right kind of brick, a sufficient supply ought to be kept in store to enable them to become dry before use. When built into place, a slow fire only must be made and the heat got up gradually, so as to allow the bricks to dry thoroughly before being highly heated. When a boiler is laid off from work it should be closed up completely by shutting the dampers and leaving the boiler and its brickwork to cool as slowly as possible.

The most troublesome detail of a furnace is the arching over the fire of a water tube boiler. The usual form of water tube boiler is very smoky, and to cure this furnace must be covered by a brick arch, and a capacious combustion chamber must be employed beyond this, so that the furnace gases and the air admitted above the fire may become well mixed and burned at a high temperature. Even with the best of bricks these arches are apt to fail when first fired, the face of the bricks dropping off.

Messrs. E. and J. Pearson, of Stourbridge, make a special brick for these wide flat arches, and supply a special cement for use in putting them together. The cement is easily fluxed by heat, and cements the whole surface of the arch into a solid face, so that pieces of the brick cannot fall out. In time the whole arch welds into a solid mass.

Such an arch ought to be built of properly-shaped bricks. If plain rectangular bricks are used the arch pressure becomes concentrated upon the intrados, and tends to flake off the bricks and deprive the arch of its sustaining power. The bricks should be of taper form so that they fit close in the arch. What are known as blocks are used for these arches and for similar purposes, and the above fire-brick manufacturers make

special arch blocks with a tongue and groove joint for better security.

In the formation of all important fire-clay blocks that will be exposed to stress, as is an arch, it is of serious importance that the clay be properly pugged into the mould. It is bad practice to put a block of clay into the mould and put it under mechanical pressure so as to force it to fill the mould. When this pressure method is followed the plastic clay will be internally fractured. Shearing planes are developed which form planes of cleavage or fracture. The movement may be very slight, but lines of weakness will be developed and the homogeneous continuity of the mass of the clay will be destroyed. When burnt, the adhesion along these planes of weakness will be imperfect and when at work such a block will fail.

A really good arch should last a year if built from a firm springing. The thrust of an arch is considerable and must all be taken by the side walls, which, not as a rule carrying the weight of the boiler, may not be very stable, and it is desirable to tie them down to the foundation by through vertical bolts, so as to form a stiff unyielding support for the arch springing.

The subject of fire-brick is one that has not been much studied by engineers. Steel melters and others who deal with high temperatures have paid attention to the question. The burning of coal for steam raising purposes has, however, been so invariably carried out at comparatively low temperatures that the importance of fire-brick has not been perceived. When a steam engineer begins to experience trouble with his furnace side wall lining he casts about him for some means of meeting that trouble, and his efforts may take the shape of a water box. High temperature he regards, when it occurs, as a disagreeable incident, to be checked and avoided. If he understood combustion he would welcome the temperature as a means of securing more perfect combustion, and would endeavour to meet the trouble by the provision of suitable fire-brick.

The high temperatures obtainable with oil fuel bring the fire-brick problem into greater prominence, and direct attention to this most important material.

Some fire-bricks in a very hot furnace will soften and melt away under long sustained heat. Others, more refractory or infusible, crack and split up under sudden temperature changes. A good brick becomes surface glazed, but the body remains rough and porous. A granular nature and porous structure are considered essential, and fire-bricks are not made of all new clay. Old bricks are granulated and mixed up with the new clay, so that the necessary texture is secured.

Fire-clay is a mixture of silica and alumina in varying proportions, each constituent possessing its own peculiar characteristics. Usually silica exists in the proportions of about two-thirds to one-third of alumina. The presence of alkaline matter is prejudicial and induces fluxing. Thus lime is intensely refractory of itself, and so is magnesia, but both of these infusible substances fuse easily with silica, as also do oxides of iron, soda, potash and other alkalis. These impurities of fire-clays must be avoided. Mixing two clays of good quality will not necessarily prove a success.

Silica, if otherwise pure, gives perhaps the most refractory bricks, and certain French fire-bricks are made from infusorial earth which consists of the minute siliceous shells of the diatomaceæ. These French bricks, when dry, will float in water, their specific gravity being under 1,000, owing to the numerous voids and pores, but they are very tender and do not stand well at the fire-grate level, where a tougher and harder brick is necessary. The Dinas bricks of South Wales are very siliceous, but are liable to split up if suddenly cooled, and are therefore somewhat unsuitable for hand-fired furnaces, but should be excellent for mechanically-stoked furnaces with self-cleaning grates. Probably the best boiler furnace brick is one high in silica, yet containing a fair proportion of alumina and free from alkalis. Such a brick combines infusibility and toughness for puddling furnaces, coke ovens, gas retorts and other high temperature uses, and it must be remembered that the kind of furnace advised by the author for bituminous fuel combustion, and adopted from sheer necessity with liquid fuel, is exposed to temperatures more resembling those of metallurgical furnaces than the starved temperatures of the common unscientifically set steam boiler.

A sample of the clay from the Glenboig Star Mine, as analysed by Edward Riley, F.C.S., after calcination, gave the following results—

	Per cent.
Silica	65·41
Titanic acid	1·33
Alumina	30·55
Peroxide of iron	1·70
Lime	0·69
Magnesia	0·64
Potash and soda	0·55
	100·87

Sir Frederick Abel analysed a Glenboig brick, at the Royal

Arsenal, Woolwich, as follows. The brick was taken from stock—

	Per cent.
Silica	62·50
Alumina	34·00
Iron peroxide.	2·70
Alkalies, loss, etc.	0·80
	100·00

Mere analysis, however, does not tell everything. For instance, in this last analysis the silica and alumina were largely in chemical combination, and this is more valuable than the mere mechanical combination of the constituents.

To make a good brick the clay must be suitably weathered so that any iron nodules may separate out. The clay is rendered smoother and more solid for articles requiring such qualities, as seating blocks; for high temperatures, porosity is given by the addition of old bricks.

All defects of shape are produced in the drying stove after moulding. Stoving is therefore a most important operation, and a brick must be practically dry before firing, which is gentle at first until the bricks are hot and perfectly dried out. Then the kiln is put on to full fire, and the temperature must be maintained until the bricks cease to shrink. A brick which has not been fired at a full temperature will shrink further if put to work at a higher temperature. The total shrink from the moulded size is about $8\frac{1}{2}$ per cent. of the bulk, or about 2 per cent. linear measure. In any case no shrinkage should remain in a brick, or it will shrink when put to work and pull the brickwork in pieces.

Professor Abel, F.R.C., gave various analyses of fire-clays as per the annexed table, from which the excellence of Stourbridge and Glenboig bricks is plainly evident in the small percentage of alkalies.

Description of Fire-clay.	Silica.	Alumina.	Iron Peroxide.	Alkalies, Loss, etc.
Kilmarnock	59·10	35·76	2·50	2·64
Stourbridge	65·65	26·59	5·71	2·05
„	67·00	25·80	4·90	2·30
„	66·47	26·26	6·33	0·64
„	58·48	35·78	3·02	0·72
„	63·40	31·70	3·00	1·90
Newcastle	59·80	27·30	6·90	6·00
„	63·50	27·60	6·40	6·50
Glenboig	62·50	34·00	2·70	0·80

For the following miscellaneous information the author is indebted to the Glenboig Company—

Shape and Size.		Weight.
	Inches.	Tons.
1,000 Square Bricks	$9 \times 4\frac{1}{2} \times 3 =$	4
1,000 „	$9 \times 4\frac{1}{2} \times 2\frac{1}{2} =$	$3\frac{1}{3}$
1,000 „	$9 \times 4\frac{1}{2} \times 2\frac{1}{4} =$	3
1,000 End or Side Arch	$9 \times 4\frac{1}{2} \times 3$ and 2	$3\frac{1}{3}$
1,000 „ „	$9 \times 4\frac{1}{2} \times 2\frac{1}{2}$ and $1\frac{1}{2}$	$2\frac{2}{3}$
1,000 „ „	$9 \times 4\frac{1}{2} \times 3$ and $2\frac{1}{2}$	$3\frac{2}{3}$
1,000 Cupola	$9 \times 4\frac{1}{2}$ and 3×3	$3\frac{1}{3}$
1,000 Pup Bricks	$9 \times 3 \times 2\frac{1}{4} =$	2
1,000 „	$9 \times 2\frac{1}{2} \times 2\frac{1}{4} =$	$1\frac{2}{3}$
1,000 Scone Blocks	$9 \times 4\frac{1}{2} \times 2 =$	$2\frac{2}{3}$
1,000 „	$9 \times 4\frac{1}{2} \times 1\frac{1}{2} =$	2
1,000 Crown or square	$9 \times 6 \times 3 =$	$5\frac{1}{3}$

One inch = Millimetres 25.4.

One Ton = Kilogrammes 1,016.

Miscellaneous Weights and Measurements.

STACKED LOOSE.

1,000 9 in. \times $4\frac{1}{2}$ in. \times $2\frac{1}{2}$ in. = 66 cub. ft.

1,000 9 in. \times $4\frac{1}{2}$ in. \times 3 in. \times 3 in. = 80 cub. ft.

BUILT WITH FIRE-CLAY.

1 square yard 9 in. work requires:—

109 bricks 9 in. \times $4\frac{1}{2}$ in. \times $2\frac{1}{2}$ in. and 2 cwts. ground fire-clay, or 92 bricks 9 in. \times $4\frac{1}{2}$ in. \times 3 in. and $1\frac{2}{3}$ cwts. ground fire-clay.

A rod (English) of brick = $11\frac{1}{2}$ cub. yds.

A rood (Scotch) of brick = 16 cub. yds.

FOR PAVING.

1 yard superficial requires 16 tiles 9 in. \times 9 in.

18 tiles 12 in. \times 6 in. \times 2 in.

32 bricks 9 in. \times $4\frac{1}{2}$ in. \times 3 in. laid flat.

48 bricks 9 in. \times $4\frac{1}{2}$ in. \times 3 in. laid on edge.

One 9 inch \times $4\frac{1}{2}$ in. \times 3 in. = 9 lb.

$17\frac{1}{2}$ cub. ft. blocks = 1 ton.

334 bricks = 1 load.

1,500 to 2,000 = 1 railway truck.

3,100 to 3,200 9 in. \times $4\frac{1}{2}$ in. \times $2\frac{1}{2}$ in. bricks = 1 railway truck (Continental)

6 to 8 tons ground fire-clay = 1 railway truck.

8 bags ground clay = 1 ton.

3 casks ground clay = 1 ton.

21 cub. ft. of dry ground fire-clay, firmly packed = 1 ton.

Fire-clay suffers no deterioration of quality from rain.

For shipment it is packed in barrels or bags.

The usual shipping size of fire-brick is 9 in. \times $4\frac{1}{2}$ in. \times $2\frac{1}{2}$ in.

The Glenboig Company make special silica bricks from English chalk flints; they weigh 2 tons 12 cwt. per 1000,

9 in. × 4½ in., × 2½ in. They also make a highly refractory brick from Gartcosh clay, which analyses as below, according to W. Wallace and Jno. Clark, Ph.D., F.C.S., etc.—

	Per cent.
Silica	61·90
Titanic acid	2·09
Alumina	32·34
Peroxide of iron	3·02
Lime	0·37
Magnesia	0·20
Potash	0·06
Soda	0·30
	100·28

The proportion of alkalies is thus small and the brick is solid and has small shrinkage from the mould and weighs 131 pounds per cubic foot. The ganister bricks of the Company, which are made from what appears to be a soft sandstone, analyse as below—

	Gartcosh Ganister.	Gartcosh Silica.
Silica	87·06	74·10
Titanic acid	Trace	0·20
Alumina	11·24	22·32
Oxide of iron	0·69	2·28
Lime	Trace	0·48
Magnesia	Trace	0·34
Potash	0·61	
Soda	0·33	0·38
	99·93	100·00

Bricks for Oil-fired Furnaces.

Where bricks are applied to oil-fired furnaces the intense local heat of the oil furnace of course burns the brickwork away in time, or rather melts it on the surface immediately in contact with the flame, causing it to run down and hang in the form of stalactites, but it takes a considerable time to wear through nine inches of brickwork, and the cost of the bricks is more than compensated for in the increased efficiency of the furnace.

It is often the case that furnaces and combustion chambers lined with fire-brick come to grief through being badly built rather than from the bad quality of the bricks used ; at the same time, good work will not make up for bad bricks. The usual type of liquid fuel furnace for kilns is as shown in the

annexed illustration, Fig. 1, the burner being so set that the fuel in vaporized form is more or less concentrated in the centre arch at x . The consequence is that the intense heat is localized and the brickwork runs down into slag. Various methods have been tried to get over the difficulty—one is to cover the grate with broken fire-brick, or coke, but this was not altogether successful. Another idea is to protect the piers

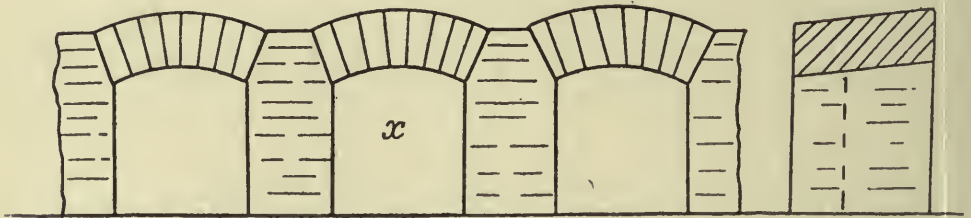

Fig. 1.

of the arches with bricks piled up loosely in semicircular form, with the concave side facing the burner, stacking them with a space between, and crossing the open space with another row of bricks, as shown in plan, Fig. 2, thus distributing the heat over a large area of brick surface.

The bricks would melt after a time, but they could be raked out and a fresh lot put in, and the arches would be saved considerably.

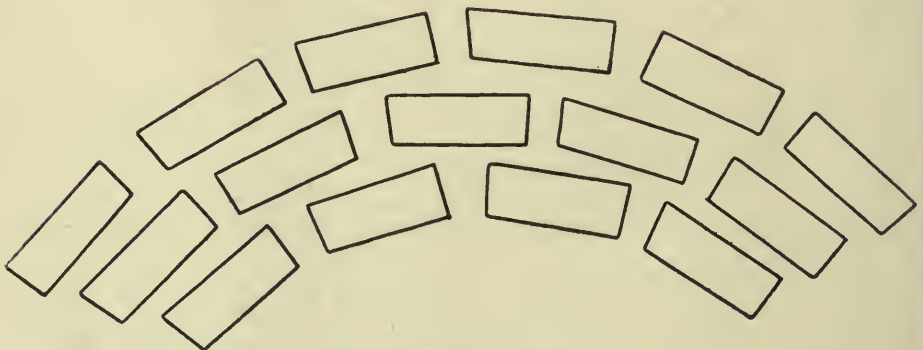

Fig. 2.

In the case of over-fire arches, Fig. 3, for water tube boilers having a wide span, the best type of brick to use is what is known by the name of the Bullhead or End-wedge, as shown in Fig. 4, or the special bricks of Fig. 5.

In all cases fire-bricks should be set with as little jointing material as possible, and for arches the bricks should be specially made to work to the desired radius. Any attempt to use

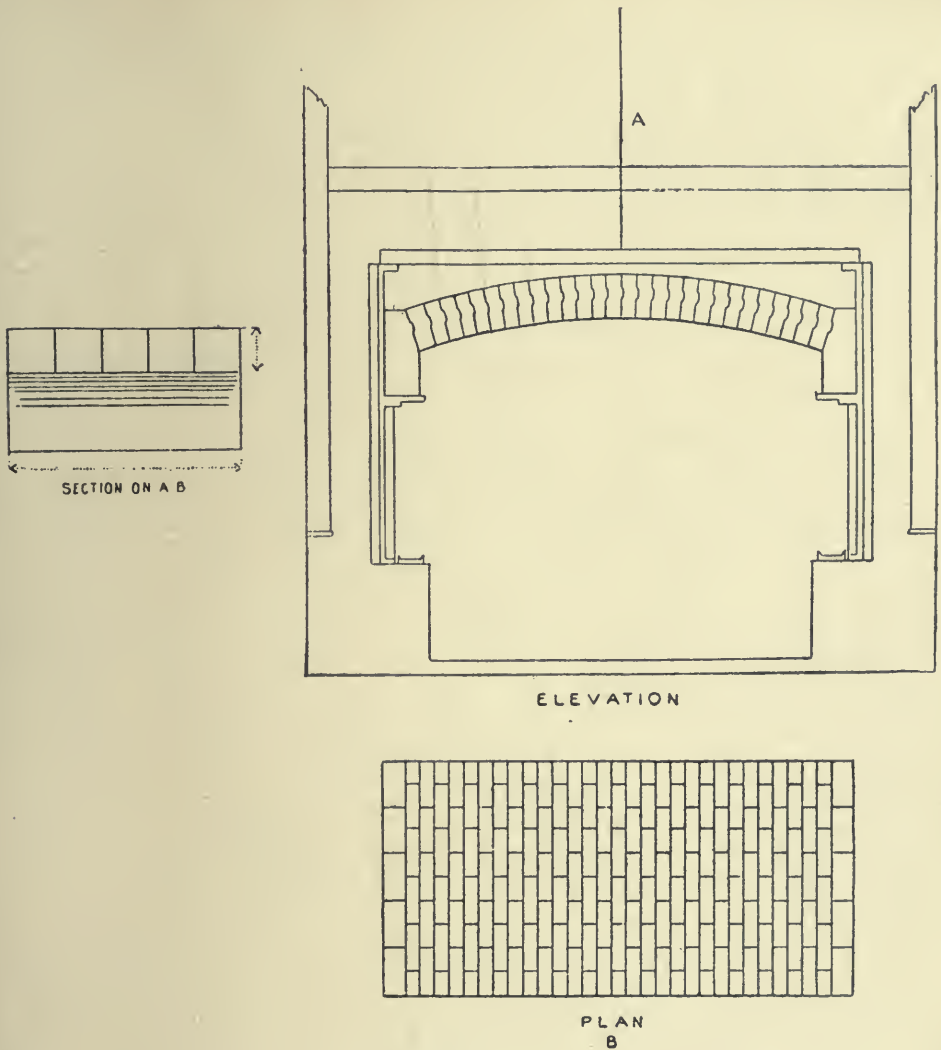

Fig. 3.

ordinary rectangular bricks is fatal. The pressure becomes concentrated on the underside of the arch, as in Fig. 6, and the mass has no rigidity—bricks begin to fall out and the arch is ruined.

The bricks should be set with finely ground fire-clay made up with water to the consistency of thick paint. The brick should be dipped in this, and then rubbed into contact with its neighbours.

Fire-clay is made up into specially shaped bricks and lumps for different purposes, and bricks and blocks can be made to meet the special requirements in furnace work, but unequally proportioned lumps must be avoided on account of internal stresses, fire-clay having its limitations in this respect, as explained above, just as cast-iron has. The best plan is to con-

sult a reputable maker. The most usual course is to decide on all other points of construction and make the best job

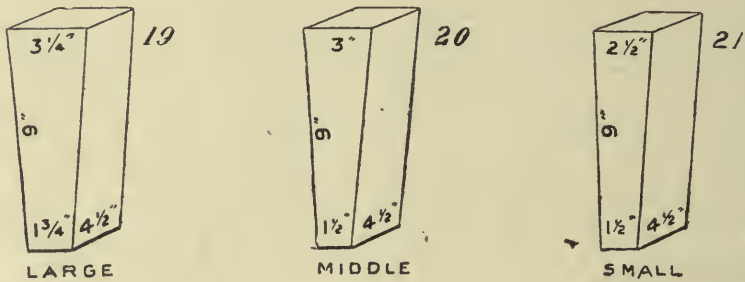

Fig. 4.

possible on what are generally considered incidentals, such as furnace linings, whereas by taking the limitations of a necessary material into consideration in the first place, much expense and trouble may be saved.

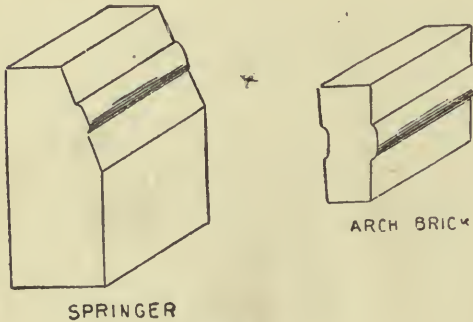

Fig. 5.

Good fire-bricks should have sharp angles, and give a metallic ring on being rubbed together. They should be kept some time before use in a dry place. Bricks sodden with rain and heated up quickly will tend to burst.

Various substances having been suggested as substitutes for fire-brick, it may not be out of place to say something as to the varieties of fire-clay goods.

The following is the classification generally adopted—

- I Siliceous fire-clay goods.
- II Aluminous " "
- III Argillaceous " "
- IV Carboniferous " "

Nos. I and II are the most generally used.

No. IV is a mixture of carbon and clay, the carbon being in a crystallized state as used for arc lamps, etc., or amorphous as graphite, the latter being used for the manufacture of crucibles, etc. Carbon blocks have

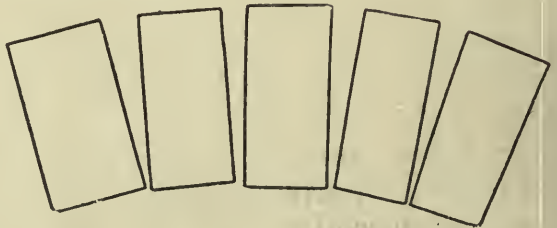

Fig. 6.

been suggested, but, apart from the excessive cost, the carbon combines with any free oxygen in the furnace gases and is consumed.

No. II. A mixture containing a greater portion of alumina than pure clay. This also is too costly for general use.

Lime is sometimes used as furnace lining for electrical kilns and will withstand the intense heat of the voltaic arc, but as it retains the property of being hydrated in air, its use is necessarily very limited. This class of fire-clay goods is known as basic.

Siliceous fire-clay goods are composed almost exclusively of silica.

Argillaceous fire-clay goods are composed of silica and alumina, and are next in degree of refractoriness to aluminous goods.

It should be borne in mind that the foregoing are each adapted to particular purposes, and the proper admixture of clays for any desired purpose is a matter that only long experience and scientific knowledge can determine, the physical as well as the chemical properties of clay having to be taken into account.

Siloxicon.

A very refractory material is Siloxicon, a product of the electric furnace, consisting of carbon, silicon and oxygen formed at a temperature of 4,000° to 5,000°F., and therefore very refractory at ordinary temperatures. It is a loosely coherent mass as formed and is ground to pass a 40² sieve. It is an amorphous grey-green compound when cold, becoming light yellow at 300°F. It is insoluble in molten iron, neutral to acid and basic slag, indifferent to all save hydrofluoric acid, and is unattacked by hot alkaline solutions. It is formed into bricks by simple pressure, when damp, and fired. It is neutral to clays and will not oxidize, and appear likely to form a valuable furnace lining where oil fuel is employed.

CHAPTER V

COMBUSTIBLES AND SUPPORTERS OF COMBUSTION

Carbon.

CARBON is an element which has the following properties. Its atomic weight is 12 and it is tetravalent in chemistry.

It is found free in nature in various forms, but is usually considered to exist only in three allotropic modifications, viz.—

(1) The Diamond, which is practically pure crystallized carbon.

(2) Graphite, not entirely amorphous.

(3) Charcoal, an amorphous substance, is considered to include all other forms of carbon.

The following figures give the values of the various forms of carbon in calorific value or heat absorption—

COMBUSTION.

State of 1 pound or 1 kilo. of Carbon.	Product of Combustion.	Calories per kilo.	B.Th.U. per pound.
Diamond.	CO	2,175	3,915
”	CO ₂	7,859	14,146
Graphite	CO ₂	7,900	14,222
Amorphous	CO	2,453	4,415
”	CO ₂	8,137	14,647
Ideal Gaseous	CO	5,684 + e	10,232 + e
” ”	CO ₂	11,370 + e	20,463 + e
2½ pts. of CO per part of C.	CO ₂	5,683	10,231

HEAT ABSORBED BY METAMORPHIC CONVERSION.

Diamond. to	Vapour	3,508	6,316
Graphite ”	”	3,468	6,241
Amorphous ”	”	3,231	5,817
Diamond. ”	Graphite	41·5	74·7
” ”	Amorphous	277·0	499·0
Graphite ”	”	235·7	424·3

The above figures are calculated from the determinations by Berthelot of the heat of combustion and formation of the molecule (see *Thermochimie*, par M. Berthelot, Paris, 1897).

Except that these figures point the lessons that form and state are dependent upon heat, apparent or latent, no further interest centres on the crystalline modification of carbon, which is too scarce to employ as a commercial fuel.

The first oxidation of ordinary carbon with one atom of oxygen to CO produces 4415 B.Th.U.=2,453 cal. per pound and per kilogram respectively.

The second oxidation produces a further 10,231 B.Th.U.=5,684 cal. The total heat produced by complete combustion is thus 14,647 B.Th.U.=8,137 cal.

The difference (5,684-2,453) between the two oxidations is 5,817 B.Th.U.=3,232 cal., and Berthelot considers that this difference is less than the latent heat of vaporizing carbon by some unknown amount. In the absence of a knowledge of what it amounts to, it is usual to say that the difference is the latent heat of vaporizing carbon, just as 967 is the latent heat of steam.

In order to liquefy, carbon must absorb heat, but free liquid carbon is unknown. Solid carbon burns directly to dioxide gas without going through the intermediate liquid state, exactly as a piece of ice will disappear in a dry cold wind below freezing temperature without passing through the intermediate state of water. The liquid state is not imperative, and carbon is only found liquid when combined with other substances. It forms a liquid with sulphur as carbon bisulphide CS_2 . It is liquid with hydrogen and oxygen in alcohol, and it is liquid with hydrogen alone in the many hydrocarbons with which we are at present concerned. By so much as the liquid form already represents heat rendered latent in reducing a solid to a liquid, by just so much should liquid fuel possess a greater calorific value per unit of its contained carbon than a similar weight of solid fuel. The same argument applies with equal force to the hydrogen, but to some extent conversely. The calorific capacity of hydrogen is given in terms of the gas burned as gas. In solid coal the hydrogen is part of a compound solid, and it is scarcely correct to calculate the caloric capacity of a solid fuel in terms of its hydrogen at gas value, for undoubtedly heat is absorbed in rendering the hydrogen gaseous from its solid combined state in coal. Similarly, in liquid fuel the hydrogen is in liquid form and must be gasified. It is possible that the benefit derived from the liquidity of the carbon is neutralized by the liquidity of the hydrogen.

The properties of carbon are summarized in the following table—

PROPERTIES OF CARBON.

Atomic weight	12
Specific heat	0.1468 to 0.285
Heat of combustion per kilo. to CO ₂	8,137 cal. = 32,285 B.Th.U.
" " " " pound to CO ₂	14,647 B.Th.U. = 3,691 cal.
Temperature of vaporization	3,600°C. = 6,512°F.
" " combustion to CO	
In air	1,485°C. = 2,705°F.
In oxygen	4,292°C. = 7,757°F.
Air required to burn 1 unit to CO	5.797
Oxygen " " 1 " " "	1.334
" " " 1 " " CO ₂	2.667
Air " " 1 " " CO ₂	11.594
Temperature of combustion to CO ₂	
In air	2,753°C. = 4,988°F.
In oxygen	10,226°C. = 18,440°F.
Heat of combustion to CO	
per pound	4,415 B.Th.U. = 1,112 cal.
per kilo.	2,453 cal. = 9,733 B.Th.U.
Weight of vapour per cubic metre (ideal)	1.072 k. = 0.06696 per cubic foot.

The atomic weight of carbon being 12 and that of oxygen 16, the formula for carbon monoxide = CO tells that there are 12 parts of weight by carbon in each 28 parts of the gas. Hence 1 pound of carbon unites with $1\frac{1}{3}$ pounds of oxygen to produce $2\frac{1}{3}$ pounds of gas.

When burned to dioxide = CO₂ there are 12 parts of carbon to each 32 parts of oxygen, and 1 part of carbon unites with $2\frac{2}{3}$ parts of oxygen to produce $3\frac{2}{3}$ parts of gas.

As oxygen is not available for combustion except in the form of air, and as it is not desired to produce CO, the essential figures to remember are that each unit weight of carbon demands a minimum of nearly 11.6 units of air.

In the foregoing table the temperatures are those calculated on the assumption that the specific heat of the gases produced remains the same at all temperatures and that combustion is complete. Neither assumption represents actual facts, for the process of combustion is delayed as temperature rises, and even if it were not, the specific heat increases and holds back the temperature. Since in practice there are so many effects of dilution, the calculation of total heat can be correctly done on a basis of constant specific heat. If a final temperature of great intensity is found, a correction can always be applied after all calculation has been made.

The various figures given in this book differ somewhat from many previously accepted figures, owing to the progress of the science of thermo-chemistry. The figures given herein are those given by Berthelot in his work, *Thermochimie*, 1897.

Carbon burned to CO or directly to CO₂ does so with simple incandescence. No flame is produced. Carbonic oxide = CO, however, if formed by the burning of carbon with insufficient air, will burn with a blue flame if provided with air.

The hydrocarbon gases burn with a reddish, a yellow, or a white flame, according to surroundings and temperature, the flame consisting of glowing carbon in an atmosphere of hot gas.

Hydrogen.

Hydrogen shares with carbon the monopoly of the term fuel, for there are no commercial fuels except carbon and hydrogen or their joint compounds. Hydrogen is a gas. Its atomic weight is 1, and being the lightest known element, it serves as the unit of atomic comparison.

Its physical and other properties are as follows—

Atomic weight and density	1
Specific heat. Constant vol.	2.4146
" " " pressure	3.410
Weight per litre	0.08961 grams = 0.000089 k.
" " cubic foot	0.00559 pound = 0.002536 k.
Cubic feet per pound	178.83 = 5,063.4 litres.
Litres per kilogram	11,160 = 394.15 cubic feet.
Heat of combustion per kilo. } " " pound } " " cubic foot } " " litre }	To 0°C. { 34,500 cal. = 136,900 B.Th.U. 62,100 B.Th.U. = 15,650 cal. 347 B.Th.U. = 87.45 cal. 3.091 cal. = 12.264 B.Th.U.
Specific gravity, water = 1	0.0714 when liquefied.
Point of vaporization	33° abs. C. = 60 abs. F.
" freezing or liquefaction	16.7° abs. C. = 30° abs. F.
Temperature of combustion— (nominal) in oxygen	6,762°C. = 12,202°F.
" air	2,513°C. = 4,554°F.
Ratio of air required to burn 1 unit weight	34.785
" " " 1 unit vol.	2.39
" " " oxygen weight	8.00
" " " oxygen vol.	0.50
Heat of combustion per kilo. (result in vapour)	29,150 cal. = 115,434 B.Th.U.
Heat of combustion per pound (result in vapour)	52,290 B.Th.U. = 13,177 cal.

The heat of combustion of hydrogen is 62,100 B.Th.U. per pound. This assumes that the products of combustion are rejected in a liquid state. In furnace work, however, the gases of combustion always leave at temperatures above 100°C.,

and consequently the gases carry off with them the latent heat of evaporation. This reduces the available heat to 52,290 B.Th.U. per pound, or 29,150 cal. per kilogram, or say 293 B. Th.U. per cubic foot and 2.612 cal. per litre. This fact must be borne in mind when calculating results.

SMOKE PRODUCTION.—Hydrogen ignites at a temperature below that necessary to ignite carbon. Its affinity for oxygen is greater and, in presence of an insufficient supply of air, the hydrogen of a hydrocarbon fuel will first secure its share of oxygen and the carbon will appear as soot. Sudden cooling of a hot hydrocarbon gas is also said to produce soot, but it is questionable if soot is really produced without a certain amount of combustion of the hydrogen.

The following table gives the temperature of ignition of a few of the hydrocarbon gases, according to Mayer and Munch—

Marsh gas	CH ₄	667°C.	1,232°F.
Ethane	C ₂ H ₆	616°C.	1,141°F.
Propane	C ₃ H ₈	547°C.	1,017°F.
Acetylene	C ₂ H ₂	580°C.	1,076°F.
Propylene	C ₃ H ₆	504°C.	1,004°F.

Hydrogen burns with a transparent blue flame. Its compounds with carbon burn with a light-giving flame consisting of incandescent carbon particles carried in an atmosphere of gas.

These hydrocarbons are exceedingly numerous, and range from gases of small density through every shade of liquid to solids like naphthalene and paraffin wax.

The percentage of carbon and hydrogen in a petroleum of any degree of refinement does not vary far from 84 of carbon and 16 of hydrogen, corresponding with a mean formula of C₇H₁₆

Air.

Oxygen being necessary for combustion, there is only one source whence it can be obtained in large quantity, viz., the atmosphere.

The atmosphere contains by volume—

20.84 vols. of oxygen	}	ratio 1 to 3.8.
79.16 „ „ nitrogen		

There are also small quantities of other gases, the principal of which is carbon dioxide, CO₂, present to the extent of only 0.0004, and negligible for present purposes.

By weight the atmosphere contains—

23·15 parts of oxygen)	}	ratio 1 to 3·3196.
76·85 „ „ nitrogen)		

The mean atmospheric pressure at sea-level is assumed by Rankine to be 14·704 pounds per square inch, at a temperature of 32°F. = 0°C. The mercury barometer then stands at 29·922 inches. At this pressure water boils at 212°F. = 100°C. The metrical atmosphere also measured at 0°C. is 760 mm. of mercury column = 29·922 inches. At the ordinary temperature of 57·8°F. the mercury barometer of 30" = 1 atmosphere, and at all ordinary temperatures and for purposes of steam engineering it may be called 30 inches.

Expressed in metric measures, one atmosphere is 1·0333 kilos per square centimetre at Paris.

A mercury column giving 14·704 at London will give 14·6967 = 1·0333 kilos at Paris and 14·686 at New York.

The pressure and density of the atmosphere varies with the elevation above sea level, and may be thus calculated—

$H = 60,000 (1·477 - \log R)$, where

R is the elevation in feet above sea level;

H is the barometric height in inches at elevation R, and $1·477 = \log 30$.

High elevation requires consideration in regard to the relative volume of air for furnace supply.

Air at all temperatures for purposes of furnace work behaves as a perfect gas.

The weight of a cubic foot of dry air at 62°F. is 532·5 grains. If saturated with moisture the weight is 529 grains. The specific gravity of air is 819 times less than water, and one pound of air measures 13·146 cubic feet at 62°F.

The standard barometric pressure of 1 atmosphere or 14·6967 pound per square inch at Paris = 1·0333 k. per cm. is curiously approximate to 1 k. per cm₂. or to 14·21 per square inch.

Approximately 1 atmosphere is equal to a pressure of 1 k. per square centimetre.

The density of air relative to hydrogen is 14·44, its specific heat is 0·2375 at constant pressure, and 0·1686 at constant volume. One pound of air measures 12·385 cubic feet at 0°C. = 32°F., and 1 cubic foot weighs 0·08073 pound. One litre of air weighs 1·292743 grams at 0°C. and 760 mm.

Oxygen.

Oxygen is the active constituent of the atmosphere in promoting combustion. It combines with most elements to form

oxides with evolution of heat. The atomic weight of oxygen is 16 and it forms one stable oxide with hydrogen = H_2O (*see Water*) and two oxides with carbon, viz.—

- (1) Carbon monoxide or carbonic oxide = CO , which contains 12 by weight of carbon and 16 by weight of oxygen, and
- (2) Carbonic acid or carbon dioxide = CO_2 , containing 12 by weight of carbon to 32 of oxygen.

The density of oxygen is 16; its weight per cubic foot is 0.08926 pound at 0°C . = 32°F . and 11.203 cubic feet weigh one pound.

Its specific heat at constant pressure is 0.217 and at constant volume 0.1548. One litre of oxygen at 0°C . and 760 mm. weighs 1.4293 grams.

Nitrogen.

This gas constitutes about four-fifths of the atmosphere. It is a colourless gas and very inert. It does not support combustion, but acts by dilution to restrain its intensity and to reduce the temperature.

Its density is 14, specific heat = 0.244 at constant pressure, and 0.173 at constant volume. It weighs 0.07845 per cubic foot and 1 pound equals 12.763 cubic feet. One litre of nitrogen weighs 1.2505 grams at 0°C . and 960 mm.

The weight of nitrogen in the atmosphere is 3.32 times that of oxygen. It is, therefore, the cause of much dilution of the products of a furnace, and reduces the theoretical temperature of combustion to a figure much below that of combustion in oxygen.

WATER AND STEAM.

Steam is produced by heating water to such a temperature that the elasticity of the water vapour becomes greater than the superincumbent air pressure of about 14.7 pounds per square inch at the level of the sea. (*See Air.*)

Pure water is not found in nature, but is closely approximated in rain caught on hill-tops distant from towns, and in streams which flow off the barren country associated with granitic rocks, the millstone grits, and certain other geological strata. Water is an oxide of hydrogen, and its chemical formula is H_2O . It consists of 2 parts by weight of hydrogen to 16 parts of oxygen, and it is produced when hydrogen is burned, the combustion setting free a large amount of heat. (*See Hydrogen.*)

Water is used as the unit point in many physical data. The specific gravity of all other substances is referred to that of

water as unity. So also is the specific heat of all other substances, and excepting hydrogen, the specific heat of water is the highest of any known body. The amount of heat necessary to raise the temperature of 1 kilogram of water from 0°C. to 1°C. is called the great calorie or simply the calorie, the little calorie having reference to the weight of one gram only, and being employed by chemists and physicists.

Similarly the heat necessary to raise the temperature of one pound of water from 32°F. to 33°F. is called the British Thermal Unit or B.Th.U. Thus 1 calorie = 3.9683 B.Th.U. and 1 B.Th.U. = 0.252 calorie.

Weight.

One gallon of pure distilled water at 62°F. weighs 10 pounds by Act of Parliament. The American or old wine gallon weighs 8½ pounds and measures 231 cubic inches, as compared with the British Imperial 10 lb. gallon of 277.479 cubic inches (Chaney). One cubic decimetre of water or 1 litre weighs, by law, 1 kilogram, the kilo. being 2.204 pounds. Thus 1,000 k. weigh very nearly 1 ton.

A column of water 1 foot high exerts a pressure at the base of 0.434 pounds per square inch. Thus a pressure of 1 pound per square inch represents a column of 2.3 feet. Hence an atmosphere of pressure is equivalent to 33.8 feet of water column.

Compressibility.

Water is nearly incompressible, the coefficient at 0°C. = 32°F. being .000052, and at nearly 53°C. = 127°F. = 0.0000441. It is thus negligible.

Expansion.

Water changes its volume with change of temperature, but not to an amount that is of serious account in steam engineering.

Temp.	Weight.	Temp.	Weight.	Temp.	Weight.
212°F.	59.71	350°	55.52	500°	49.61
250	58.81	400	53.64	550	47.52
300	57.26	450	50.66	62	62.2786
102	62.00	158	61.00	203	60.00

The foregoing table gives the weight per cubic foot of water

at various temperatures, showing that the maximum expansion in the open air does not reach 5 per cent.

Water attains its maximum density at $4^{\circ}\text{C.} = 39.1^{\circ}\text{F.}$

It becomes solid at a temperature of $0^{\circ}\text{C.} = 32^{\circ}\text{F.}$, the freezing point of water being employed in fact as the 0° of the Centigrade thermometers.

Ice has a specific gravity of 0.922 and a specific heat of 0.504. To reduce 1 pound of ice at $32^{\circ}\text{F.} = 0^{\circ}\text{C.}$ to water also at 32°F. requires 142 B.Th.U. = 35.78 calories. The latent heat of water is thus said to be 35.78 calories or 142 B.Th.U. per pound, or 78.86 calories per kilogram.

Specific Heat.

The specific heat of water, called 1.00 at $0^{\circ}\text{C.} = 32^{\circ}\text{F.}$, is not uniform, but increases slightly with increase of temperature, as per the following table :—

Temp. F.	Specific Heat.	Temp. F.	Specific Heat.
32°	1.0000	248°	1.0177
50	1.0005	266	1.0204
68	1.0012	284	1.0232
86	1.0020	302	1.0262
104	1.0030	320	1.0294
122	1.0042	338	1.0328
140	1.0056	356	1.0364
158	1.0072	374	1.0407
176	1.0089	394	1.0440
194	1.0109	410	1.0481
212	1.0130	428	1.0524
230	1.0153	446	1.0568

As at the above temperature the bulk of water is increased in a much greater ratio than the specific heat, the total heat per cubic foot will decrease somewhat with rise of temperature.

As the total heat contained in one pound of steam measured from 32°F. is nearly 1,200 B.Th.U., this amount of heat is more or less thrown away when steam is used to atomize liquid fuel. The gases never leave a furnace below 212°F. , and every pound of steam carries off its load of 967 units of latent heat to the chimney. Air being already a gas, and necessary to combustion, causes no loss in this manner, but it requires power to compress air, and some steam is thereby used, but, especially at sea, such steam can be condensed and does not therefore lead to a loss of fresh water. No extra work is

thrown upon the evaporation plant. Water may be split up by heat into its two constituent gases. In this process of dissociation or decomposition exactly as much heat is absorbed as was produced by the combination of the gases when the water was formed. This plain chemical fact is ignored by those who dream of steam as fuel, and imagine that steam jets introduced into a furnace will decompose and burn with any effect in increasing the total heat production of the furnace. Steam thus employed is useful as a mechanical draught producer only, or there may be some truth that hydrocarbons burn better in the presence of moisture. But no further claim is tenable.

Useful Figures.

In the calculations of the steam engineer it is convenient to remember that the square of the diameter of a pipe or a pump barrel gives the weight of water in a yard length of pipe. Thus a six-inch pipe holds 36 pounds or 3.6 gallons per yard. Again, 1 pound of coal should evaporate 1 gallon of water; 1 gallon of water will give steam to work in the best engine yet made at the rate of 1 h.p. hour. Two gallons will serve an ordinary compound engine per h.p. hour, and 3 gallons a good non-condensing engine for each h.p. hour. Approximately, too, 1,000 B.Th.U. generated represents one pound of steam, so that the number of thousands of units capacity of a pound of fuel represents the theoretical evaporation in pounds of water.

Solubility of Salts.

As a rule this increases with the temperature, but at a slow rate, except for sodium chloride and a few other exceptions. For the sulphates of magnesium and potassium and the chlorides of barium and of potassium, solubility is proportionate to the increase of temperature.

With sulphate of soda the solubility first increases and then falls off again.

The solubility of calcium sulphate decreases with temperature.

The following table gives the solubility of a few salts at various temperatures in parts per 100.

The solubility at 212°F. is really at a higher temperature, being the solubility at boiling point, which is always raised slightly by the solution of a salt.

	Temperature.		
	32°F.	70°F.	212°F.
Calcium chloride	400.0	—	—
Magnesium sulphate	24.7	35.0	130.0
Potassium carbonate	100.0	80.0	—
„ chlorate	3.33	8.0	60.0
„ chloride	29.21	34.0	60.0
„ nitrate	13.32	30.0	240.0
„ sulphate	—	12.0	26.0
Sodium carbonate	6.97	21.7	45.1
„ bicarbonate	6.9	9.6	—
„ chloride	35.5	36.0	39.6
„ sulphate	5.02	22.0	42.6
Barium chloride	35.0	—	60.0
Calcium carbonate0036	—	—
„ sulphate23	—	.21
Magnesium chloride	200.0	—	400.0
„ carbonate02	—	—

Sea Water.

Sea water contains 38 parts per 1,000 of dissolved matter ; of this from 25 to 28 parts are common salt, NaCl.

The Black Sea contains only 17.7 parts, the Caspian Sea 14.0, and the Baltic 6.7, owing to the large fresh water rivers which flow into them. The other salts of sea water are magnesium chloride, calcium sulphate, magnesium sulphate, potassium sulphate and chloride, bromide of soda, the carbonates of lime and magnesia, and traces of other salts and organic substances.

Hardness.

By this term is meant 1 grain per gallon of lime carbonate, CaCO_3 . Temporary hardness is that which can be reduced by boiling. Permanent hardness is not reduced by boiling. Water is softened by chemical means.¹

Pipes.

The ordinary velocity of flow in water in pipes may be taken at 72 inches per second. This velocity is to be reduced 1 inch per second for each 20 pounds pressure. Thus in feed pipes at 160 pounds pressure, the velocity will be $72 - 8 = 64$ inches. Practical considerations demand, except where several boilers are fed through one pipe, that the pipes should be much larger than would give such a velocity in many cases.

¹ See *Water-Softening and Treatment*, by the Author ; Constable & Co. See also *Liquid Fuel and its Combustion*, by the Author ; Constable & Co.

Pipes less than $1\frac{1}{2}$ inches are rarely advisable for feed pipes, and if pipes are liable to be scaled up they ought to be made initially larger than necessary to allow of a considerable deposit of scale without unduly diminishing their capacity.

Useful Data regarding Water.

1 gallon	10 pounds.
1 American gallon	8.321 pounds.
1 cubic foot	62.2786 lb.
1 gallon	277.479 cubic inches.
1 American gallon	231 cubic inches.
1 litre	2.204 pounds.
1 foot column	0.434 per square inch.
1 pound per square inch	2.304 feet head.
1 gallon	0.1606 cubic feet.
1 pound	0.01606 „ „
1 cubic foot	0.0278 ton.
1 ton	35.97 cubic feet.
(Diameter of pipe in inches) ²	Pounds per yard nearly of water contents.
1°C. per kilogram.	1 calorie.
1°F. per pound	1 B.Th.U.
Specific heat at 0°C.	1.00.
„ „ Ice	0.504.
Specific gravity at 0°C.	1.000.
„ „ Ice	0.922.
1 atmosphere	33.8 feet.

CHAPTER VI

CALORIFIC AND OTHER UNITS

Thermo-Chemistry.

THE subject will only admit of slight treatment in a work of this description. It has been exhaustively treated by Berthelot, especially in his *Thermochimie* of 1897; therein he gives the thermalequivalent of almost all known hydrocarbons and other elements and compounds. When the calorific capacity of a fuel is tested it will often be found to depart from expectation. Two fuels may have the same composition, yet produce very different effects. Thus acetylene and benzene have exactly the same ratio of hydrogen to carbon in their composition, their formula being C_2H_2 and C_6H_6 but their atoms are differently put together, and they produce very different amounts of heat when burned. Acetylene is very much more endothermic than benzene, that is to say, it actually absorbs heat when first compounded, and this latent heat adds to its calorific output when burned. Benzene and ethylene are also endothermic, but the other fuel hydrocarbons and alcohol are exothermic, and having given out heat when formed they give out correspondingly less when destroyed by combustion. Thermo-chemistry teaches us to consider all substances from a monistic point of view, seeing in every gas latent heat to preserve it as a gas, without which heat it would fall to the state of a liquid. Similarly, we recognize that latent heat prevents liquids becoming solid.

We realize that the conversion of solid coal into gas, such as occurs when coal is burned, demands an enormous heat absorption. Thus it is that the first oxidation of solid carbon to monoxide develops less than half the heat of the second oxidation. The same or even more heat is developed by the first oxidation, but disappears in changing the solid carbon and solid hydrocarbons into gas. We are enabled to appreciate the difficulties that stand in the way of perfect combustion of bituminous fuels, when we perceive the heat absorption of the gasification they endure before they burn, Thermo-chemis-

try points out why the calorific capacity of liquid and of gaseous fuels is better than of solid fuels; it teaches us to study the phenomena of specific heat, and helps us to understand and account for an infinite variety of apparent inconsistencies and to clear away the mists from our earlier views. As, however, in engineering we can only deal with approximations, it is sufficient for ordinary purposes to base most calculations on approximations, and it is useful to be able to calculate the approximate expectation of calorific capacity of a fuel of any type. The formula of the French chemist Dulong may still be employed as substantially accurate. It is—

Calories = $x = 8,080C + 34,500(H - \frac{O}{8})$ where C = weight of carbon, H = weight of hydrogen and O = weight of oxygen in 1 kilo. of the fuel; or, if expressed in British Thermal Units, B.Th.U. = $x = 14,500C + 62,100(H - \frac{O}{8})$, where x = the thermal units, C = the weight of carbon, H = the weight of hydrogen, and O = the weight of oxygen in one pound of the fuel.

The Verein Deutscher Ingenieure use a modified formula—
 $x = 8,100C + 29,000(H - \frac{O}{8}) + 2,500S - 600E$, thus allowing for the sulphur and for the hygroscopic water and for the fact that the hydrogen products are produced as steam.

Mahler found an average of 44 fuels as follows—

$$x = \frac{8,140C + 34,500H - 3,000(O + N)}{100};$$

which in B.Th.U. becomes when simplified—

$$x = 200.5C + 675H - 5,400.$$

Calculation has now given way to actual measurement of a sample in the Berthelot bomb or other form of calorimeter.

We learn from thermo-chemistry why it is that the latent heat of steam diminishes with higher pressure, realizing that the difference is due to the absence of performance of external work.

A few of the leading particulars referring to the gases most related to power engineering are re-tabulated in Table 5 from the author's more extended table in Kempe's *Year Book*.

As a science thermo-chemistry recognizes no fuel as such. It has regard merely to the heat effects of chemical combination. Combustion is usually restricted to carbon and hydrogen, simply because these are the two substances we find in Nature on a sufficiently large scale to burn by means of the atmospheric oxygen. Both produce harmless gases, namely, steam and carbonic acid. Neither will support life, but they are not poisonous.

By aid of thermo-chemical researches we learn that the various hydrocarbons have either absorbed or given off heat when they combined. If the former, they are said to be endothermic, if the latter exothermic. We learn to make allowance for the different states of fuel, and to realize that a gas ought to be superior to the same relative proportions of liquid fuel, and this again to solid fuels. But methane, CH_4 , is a gas, and yet it produces when burned an amount of heat less than it ought to produce, seeing that its hydrogen is still gaseous and its carbon is also gaseous. Instead of about 16,600 units of heat, it produces 13,343 units only, despite the benefit of vaporization of its carbon.

The explanation is that when its elements combined they gave out actually more heat than was necessary to vaporize the carbon, and the excess of heat was dissipated at the time, and before methane can burn with oxygen, its constituents must be separated by means of heat. The heat necessary to do this reduces the heat of combustion. The different behaviour of acetylene arises from its absorption of heat in formation, such heat becoming apparent when the gas is burned.

Heat.

We do not know what heat is, but we know its effects, and we assume it to consist in atomic or molecular vibrations.

The effects of heat, as they are apparent to our senses or to our reasoning powers, are variously named. First may be placed temperature. When a body is hot it can communicate heat to bodies at a less temperature. Temperature and quantity of heat have no particular relation to each other. A pound of lead may be hotter or have a higher temperature than a pound of iron or of water, and may be able to part with heat to those bodies. Yet it may possess much less quantity of heat, because lead has a lower specific heat.

The same substance in two different states at the same temperature, as ice at 32° and water at 32° , possesses a different amount of heat in these two states. The difference is expressed as latent heat, and quantity of heat generally is expressed as units of heat, and we speak of the heat of combustion and the mechanical equivalent of heat, and must therefore define all these.

Temperature.

The boiling point at which the 212° of the Fahrenheit thermometer is fixed is that of pure water under the mean atmo-

spheric pressure of 14·7 pounds per square inch. The Centigrade thermometer is marked zero at the temperature of melting ice and 100° at the boiling point, the atmosphere being the pressure of 760 millimetres of a mercury column. Thus $1^{\circ}\text{F.} = \frac{5}{9}$ of a degree Centigrade. The mercury thermometer is available from 40°F. to 600°F. , and even higher if the upper part of the tube be filled with compressed nitrogen. For higher temperatures it is necessary to employ pyrometers, which act by recording the difference of expansion of diverse metals or the pressure of heated air, or by electrical means. Metallic thermometers are not very satisfactory. In steam engineering, temperatures are met with from 32° to 600°F. in the engine-room, from 350° to $3,000^{\circ}\text{F.}$ between the chimney and the furnace. By temperature is meant that state of a body due to heat, in which the said body can transfer heat to other bodies of less temperature. Temperature is a heat effect apparent to the sense of touch, and only by temperature can heat be transferred from one body to another, and the transfer is always from the hotter body to the less hot body. In this way heat can be transferred from a body containing less actual heat to one that contains more heat. Thus a mass of one pound of iron heated to a temperature of 132°F. contains 12·98 heat units. A similar mass of water at a temperature of 82° contains 50 heat units, the heat content being in each case measured from a datum of 32°F. Yet if we immerse the iron in the water, heat will leave the iron which contains so little heat and will enter the water that contains so much heat, and will raise the temperature of the water. A clear distinction must be made between temperature and quantity of heat. Temperature can be measured by a thermometer, but specific heat can only be ascertained by equalizing the temperature of the substance whose specific heat is sought with that of a mass of water. The final temperature enables the specific heat of the substance to be compared with that of water.

There are three thermometric scales, namely—

The Celsius or Centigrade, which divides the distance between freezing and boiling of water at sea level into 100 degrees, the freezing point being 0° .

The Reaumur scale, still much used in Russia, divides the same distance into 80 parts, also starting from $0^{\circ} =$ freezing point of water.

The Fahrenheit scale divides the same distance into 180 parts, but starts the zero mark at 32° below freezing. Hence the boiling point is 212° . It is frequently necessary to convert one reading to another. The following are the formulæ

for doing so, C., R. and F. being the respective readings on each scale.

To convert C. to R.—

$$C.^{\circ} \times \frac{4}{5} = R.^{\circ}$$

To convert R. to C.—

$$R.^{\circ} \times \frac{5}{4} = C.^{\circ}$$

To convert C. to F.—

$$(C.^{\circ} \times \frac{9}{5}) + 32^{\circ} = F.^{\circ}$$

To convert F. to C.—

$$(F.^{\circ} - 32^{\circ}) \times \frac{5}{9} = C.^{\circ}$$

To convert F. to R.—

$$(F.^{\circ} - 32^{\circ}) \times \frac{4}{9} = R.^{\circ}$$

To convert R. to F.—

$$(R.^{\circ} \times \frac{9}{4}) + 32^{\circ} = F.^{\circ}$$

It is particularly necessary not to forget the addition or subtraction of the 32° of the Fahrenheit freezing point when converting temperatures, but it is also necessary to remember *not* to do so when converting mere statements of differences of temperature. Thus if water is cooled $50^{\circ}C.$, this means it has been cooled through $90^{\circ}F.$, not through $90^{\circ} + 32^{\circ}$. This point is often confused by writers and leads to very erroneous statistics.

By temperature we thus understand that a body in a certain state is in a certain condition of molecular vibration. Different bodies are differently affected by heat. Some bodies are placed in the state of molecular vibration known as temperature with less heat than others. Thus water requires more heat than any other substance, excepting only hydrogen. The relative amounts of heat to place bodies in a given state of vibration are called their capacity for heat or specific heat.

In Table VI are given a few characteristic temperatures.

Furnace temperatures can now be measured by the Fery radiation pyrometer. This instrument is stood at any convenient and comfortable distance from the furnace, and the hottest of furnaces may thus easily be measured. The instrument is not exposed to high temperature, though it measures this from its distant standpoint. It can be obtained, with explanation of use, from the Cambridge Scientific Instrument Co.

Specific Heat.

By specific heat is meant the number of heat units necessary to raise 1 pound of a substance 1° Fahrenheit, and as water has the highest specific heat of any solid or liquid, it is taken as the basis. The specific heat of water is measured at the temperature of maximum density, $39.1^{\circ}F.$, by some writers,

including Rankine, but 32° is probably more usual. The difference is unimportant. The specific heat of all bodies increases slightly with increase of temperature, a fact due to the increased molecular movement, and there is often very considerable difference between the specific heat of the same body solid and liquid, notably in the case of water, the specific heat of ice being only 0.504° .

Since 1 pound of water requires 1 unit of heat to raise its temperature 1° , its specific heat is thus said to be unity. All other substances are referred to water as a basis. Thus when we say that lead has a specific heat of 0.0314, we mean that to heat a pound of lead to a certain temperature only requires about 3 per cent. of the amount expressed in B.Th.U. that would be required to raise the temperature of an equal weight of water by the same amount. It is necessary to know the value of the specific heats of brick, iron, fuel and its products, in order to calculate pyrometric effects, furnace temperatures, etc. For the purpose Table VII of specific heats will usually serve. More extended tables are found in most pocket-books.

Gases have two specific heats; that at constant volume and that at constant pressure, the latter being greater and due to the work done in expanding to constant pressure. Table VII gives the specific heat of the more usual gases met with in combustion.

The specific heat of all substances appears to increase with heat, more especially in the case of the gases. This is not of much importance in boiler work, but is considerable in gas engine research. In high temperature work the increase must be considered, but no error is introduced by neglecting the change when results are finally stated at low temperatures. The increase of specific heat with temperature is most marked in the case of the more easily liquefied gases.

Specific heat, then, is the relative amount of heat necessary to give to bodies a given temperature. The specific heat of other bodies is stated as the fraction of unity relative to water. Most substances about a furnace, as fire-brick, have a specific heat of about 0.2. The total heat in a body is the product of its mass, its temperature and its specific heat as compared with some substance at another temperature and in the same state physically. Thus ice, water and steam which are chemically identical, differ in their physical states and cannot be so compared. The specific heat of ice is only about 0.504, and that of steam is 0.480. Ice at 32°F. may have heat added to it until it becomes water at 32°F.

Water at 212°F. will absorb heat and become steam at 212°F.

In both these cases we see no change of temperature due to the additional heat, but we see a change of physical condition. One pound of ice has absorbed 142 B.Th.U. of heat to enable it to exist as water. Any further heat then added will increase the temperature until 212°F . is reached. Then we may add 966.7 B.Th.U. to the water with no change of temperature, but we get the water in the still higher physical state of steam. In each case the heat has become hidden or latent. It is not apparent as temperature, but is occupied in keeping the molecule liquid or gaseous, as the case may be. Heat which thus disappears in changing the state of a body is termed latent heat.

Latent Heat.

Latent heat is thus the heat enivalent of the changed state of a body. It is not stated, however, as is specific heat, in terms of the ratio to water, but in actual heat units per unit of weight, as in calories per kilogram or B.Th.U. per pound. Thus the latent heat of water is said to be 142.6, because the melting of 1 pound of ice demands 142.6 B.Th.U. It is important to know the latent heat of a few substances. Some are given in the table below, those marked * being hypothetical and not definitely determined.

	Per Pound.		Per Kilo.	
	B.Th.U.	Cal.	Cal.	B.Th.U.
Ice to water, both at 32°F	1,426	35.93	792	314.3
Water to steam, 212°F	966	243.3	536.4	212.8
Carbon to gas	5,817	1,466	3,231	1,282
Oxygen to gas *	444	111.9	246.7	9,784
Hydrogen to gas *	7,320	1,845	4,066	1,613
Nitrogen to gas *.	521	131.3	289.4	114.8
Water to gas ¹	6,900	1,739	3,833	1,521

Heat becomes latent not merely by such a process as actual boiling of water. It becomes latent equally when water is converted to vapour by absorption in dry air: the heat must come from somewhere in such a case, and it comes primarily from the air or from the wooden floor on which water has been sprinkled for cooling purposes. If steam be heated above its saturation temperature, it will now only absorb about 0.480 of a unit. Hence the specific heat of steam is barely half that of liquid water. After a very considerable further addition of heat, a point is reached where the temperature again ceases to rise; but again here is a change of state. The water is

¹ From solid condition in coal.

split up into constituent elements of oxygen and hydrogen, and one pound of steam will absorb 6,900 thermal units during the splitting up of its chemical affinities, showing the great energy of chemical changes, for to melt ice requires 142 heat units per pound; to vaporize the water requires 966.7 heat units, and to decompose it demands 6,900. No matter how it occurs that a body change its state, heat is given out or absorbed. To set free the solid hydrogen or solid water locked up in a piece of coal demands heat which is rendered latent. Thus heat is rendered latent when carbon is vaporized, and when again carbon is reduced from its state of carbonic acid gas to the solid form of wood by the action of the living forces of a tree, the heat is again set free by the solidification of the carbon; but the heat rendered latent in the decomposition of a body is known as the heat of dissociation, and, like latent heat, is expressed in actual heat units.

Dissociation.

The heat absorbed in any process of chemical dissociation is an exact equivalent of the heat which is set free when the same substances combine. Thus if 1 pound of hydrogen unite with 8 pounds of oxygen to produce 9 pounds of water, the heat of combination is 62,100 B.Th.U., and therefore the heat of dissociation of water is $62,100 \div 9 = 6,900$ B.Th.U.

There now remains to consider only the

Unit of Heat.

The unit of heat is merely an arbitrary measure of comparison. In British measures it is the amount of heat necessary to raise the temperature of 1 pound of water through 1°F . at or near 32°F .

In the metric system it is the amount of heat necessary to raise the temperature of 1 kilogram of water through 1°C .

As 1 kilogram = 2.204 pounds and $1^{\circ}\text{C} = \frac{9}{5}^{\circ}\text{F}$. the ratio of the two units is $2.204 \times 9 \div 5 = 3.968$, the reciprocal of which is 0.252.

The British Thermal Unit is written B.Th.U., and the metric unit is called the calorie and is written cal. Therefore 1 cal. = 3.968 B. Th.U., and 1 B.Th.U. = 0.252 cal. For near approximation the ratio of 4 : 1 may be employed.

The heat unit is employed to express latent heat of combustion or of dissociation.

It is necessary to have a statement of the relation of the heat form of energy and the unit of mechanical work.

Unit of Work.

The unit of work is expressed in the form of the earth's attraction.

For the purpose of the engineer the attraction of the earth is measured by the pull exerted at sea level in the latitude of London upon a piece of metal which is called the pound. The work done in lifting one pound through a height of one foot is a unit of work and is called the foot pound. Heat and mechanical work are mutually convertible. Dr. Joule, of Manchester, by the agitation of water by means of falling weights, ascertained that the unit of heat or B.Th.U. is the equivalent of 772 pounds raised one foot, or 772 foot pounds at the latitude and elevation of Manchester, and, with very slight variation, of no account in engineering, at any spot on the earth's surface. Joules' determination of 772 was made by means of thermometers less perfect than those now procurable, or his figure would have been 778 foot pounds, as since found by Rowland.

The mechanical equivalent of 772 foot pounds per degree Fahrenheit becomes 1,389·6 foot pounds per degree Centigrade.

Expressed in terms metrical altogether or in kilogram Centigrade units, the equivalent is 3,063·54 foot pounds or 423·55 kilogram metres.

Thus the calorie is $423\cdot55 \text{ km.} = 3\cdot968 \text{ B.Th.U.}$

With the more modern figure of 778 foot pounds = 1 B.Th.U. = 3,087·3 foot pounds. Per calorie = 426·84 kilogram metres, so that 1 B.Th.U. = 107·78 metre kilograms.

Weight.

Like the British pound, the kilogram is simply a piece of metal, and work units are done in raising it against the pull of gravity. Hence the kilogram metre, whose relation to the foot pound is 7·231 : 1.

The kilogram is 2·2 pounds (actually 2·2046212). The pound is thus 0·4536 kilos.

The metre or unit of length is 39·370432 inches, or say 3 feet 3 inches, and $\frac{3}{8}$ very nearly for easy remembrance and mental calculation.

Errors in converting units are most likely to occur when units are compound, as when converting pounds per square inch to kilos per cm.²

Very closely the English ton of 2,240 pounds resembles the French *tonne* of 1,000 k. = 2,204·6 pounds.

Also 1 k. per linear metre is equal nearly to 2 pounds per linear yard, and 9 calories per cubic metre is very closely 1 B.Th.U. per cubic foot.

Gravity.

Gravity = G at Greenwich is 32.19078 feet per second acceleration per second, usually written 32.2 per sec².

The expression $\sqrt{2G}$ may be approximated as 8.

Metrically, $G = 9.8117$ metres per second² at Greenwich.

The true value at any other latitude (L), in centimetres per second² is—

$$980.6056 - 2.5028 \text{ Cos}^2(L) - 0.000003 \text{ H},$$

where H is the height above sea level in centimetres.

Other compound units that are useful are as follows—

1 B.Th.U. per sq. ft. = 2.713 cal. per square metre.

1 „ „ pound = 0.556 cal. per kilogram.

To find the number of cubic feet of air at 62°F. chemically consumed for one pound of fuel, take the percentage of carbon, hydrogen and oxygen in fuel. To the carbon add three times the hydrogen and subtract four-tenths of the oxygen and multiply the remainder by 1.52. The product is the cubic feet of air (A).

$$\text{Thus } A = 1.52 (C + 3 H - 0.4 O).$$

The weight of air per cubic foot is $\frac{1}{13.14}$ pounds, or 13.14 cubic feet = 1 lb.

The total weight of gaseous products per pound of fuel is found by multiplying the percentage of carbon by 0.126 and that of the hydrogen by 0.358. The sum gives the total gases (W), thus $W = 0.126 C + 0.358 H$.

The total volume is found by multiplying the carbon percentage by 1.52 and the hydrogen by 5.52; the sum of these is the total volume (V) in cubic feet at 62°F., thus $V = 1.52 C + 5.52 H$.

The volume at any other temperature (T) is $V' =$

$$V \frac{T + 461}{523}.$$

THE CALORIFIC POWER OF FUEL.

Calorific Formula.

Dulong and Petit and subsequently Favre and Silbermann determined the calorific capacity or heat of combustion of many substances with more or less accuracy. Dulong endeavoured to find a formula for calculating the heat of combustion of any fuel of which the chemical composition was known.

The capacity given by him to carbon was 7,295 calories. The latest determination of Berthelot is 8,137 and that for hydrogen is 34,500.

Dulong's formula for fuel according to its composition is, with the correction to modern coefficients—

$$\text{Cal.} = 8,137, C + 34,500 \left(H - \frac{O}{8} \right) \text{ where}$$

C is the carbon in 1 kilogram of fuel, and H and O are the hydrogen and oxygen respectively, it being assumed that the oxygen is already combined with hydrogen and that so much of the hydrogen is already useless. Any error would appear to be on the safe side, and the formula assumes the return of all the gases to 0°C.

In actual practice, the gases pass at a temperature of over 100°C., and the water is in the form of vapour, and the calorific capacity of hydrogen is often taken as only 29,150 B.Th.U., to allow for the heat absorbed in vaporization of the water.

In Germany, Dulong's formula is thus used in the form—

$$\text{Cal.} = 8,100 C + 29,000 \left(H - \frac{O}{8} \right) + 2,500S - 600W,$$

where S is the sulphur present, and W is the weight of hygroscopic water.

Seeing that in coal the hydrogen is as solid apparently as the carbon, it appears correct to take something off the co-efficient of hydrogen to allow for the heat absorbed in gasifying it, and in the above formula the subtraction of 150 calories perhaps helps to make this formula coincide very closely with calorimetric results.

Possibly also the rounding off of the co-efficient for carbon from 8,137 to 8,100 helps to correct for the vaporization of the carbon compounds which are exothermic when first formed, and do not give up the full heat value of their separate hydrogen and carbon. Both marsh gas, CH_4 , and ethrane, C_2H_6 , give out heat when formed and require it again when dissociated, and coal is so complex a body, as are also liquid fuels, that very little positive knowledge can be assumed: it is sufficient to know that the formula last given is a very fair approximation to the truth.

The Calculation of Temperatures.

The temperature of combustion of any substances depends upon the calorific capacity of the burning material, the total weights of the products formed, and the specific heat of the products. The calculation of the theoretical temperature is therefore simple.

The specific heat of all bodies, and particularly of gases, increases with temperature, and this reduces the temperature actually obtained. Though hydrogen has so high a calorific capacity, it does not produce a specially high temperature as compared with carbon, for in the first place it demands 8 times its own weight of oxygen, and secondly the specific heat of the product, steam gas, is also high, viz., 0.479.

The calculation of temperature for hydrogen burned with oxygen is—

$$T = \frac{29,150}{9 \times 0.479} = 6,762^{\circ}\text{C.} = 12,202^{\circ}\text{F.}$$

These are temperatures very much in excess of anything secured in the laboratory, which has not reached 3,000°C. (even under a pressure of 10 atmospheres).

With air, however, the oxygen is accompanied by a weight of nitrogen 3.32 times its own weight, and to burn 1 unit of hydrogen requires 8 pounds of oxygen and 26.56 of nitrogen, the specific heat of which is 0.244. The calculation for temperature is thus—

$$T = \frac{29,150}{(9 \times 0.479) + (26.56 \times 0.244)} = 2,513^{\circ}\text{C.} = 4,554^{\circ}\text{F.}$$

The calculation for carbon turned to carbonic oxide is similarly derived from the heat capacity = 2,453 cal. The oxygen necessary is $1\frac{1}{3}$ times the weight of the carbon consumed, and as the calorific effect of the first oxidation of carbon is 2,453 calories per kilogram, we obtain—

$$T = \frac{2,453}{2.333 \times 0.245} = 4,292^{\circ}\text{C.} = 7,757^{\circ}\text{F.}$$

when burned with oxygen, the total product being 2.33 k. of carbonic oxide of 0.245 sp. heat. Then, with air containing 3.32 times as much nitrogen as oxygen, we have—

$$T = \frac{2,453}{(2.333 \times 0.245) + (1.333 \times 3.32 \times 0.244)} = 1,485^{\circ}\text{C.} \\ = 2,705^{\circ}\text{F.}$$

Where the amount of air is in excess of the chemical minimum, a further term must be inserted in the denominator; as neither the nitrogen nor the oxygen of the excess air is altered, they may be considered together. The sp. heat of air is 0.237, and the weight per unit of fuel being W , we have the new term in the denominator ($W \times 0.237$), and the temperature of the final product is reduced simply because of the greater weight of final gases over which the heat generated per unit of fuel is

distributed. In Table V are given the calorific capacities of the various forms of carbon and of hydrogen, together with the resulting temperatures of combustion with a minimum of oxygen or equivalent air. The values are given per gram, litre, pound and cubic foot for combustion to carbonic oxide = CO and to carbonic acid = CO₂ for carbon, and to water (vapour) and water (liquid) for hydrogen.

These temperatures are not attained in practice. St. Clair Deville considers that they are prevented from occurring by the dissociation which is said to occur at high temperatures. A certain temperature is attained and further combustion ceases until some of the heat has been dispersed, when further combustion proceeds. Berthelot, while not ignoring dissociation, is rather of the opinion that the inability to attain theoretical temperature arises from the proved increase of the specific heat of all bodies, and especially of gases at high temperatures. Probably both causes have effect.

With liquid fuels, which contain so much hydrogen, the calorific capacity of the hydrogen cannot exceed 29,100 cal. or 52,290 B.Th.U., because the aqueous vapour always passes away as vapour.

One pound of water vapour contains—

$1,091.7 + 0.305 (T - 32^\circ)$ B.Th.U., where T is the temperature Fahrenheit.

Similarly where T is the temperature Centigrade 1 kilogram contains $606.5 + 0.305 T^\circ$ calories, whence can be calculated the heat lost where saturated steam is thrown away. But in a furnace the waste gases are much above saturation temperature, and all vapour above 212°F. must be calculated to absorb at least 0.480 of a thermal unit or calorie per pound or per kilogram for each degree Fahrenheit or Centigrade beyond 212°F. or 100°C. respectively.

In calculating furnace temperatures there must always be added the temperature of the atmosphere to the calculated temperature, which is based on the datum of 0°C. The usual atmospheric temperature is 15°C. = 60°F. for convenience, a sufficient approximation. The total amount of water to be allowed for in any fuel sample is nine times the weight of hydrogen in the sample plus all the water. Water should be nil with liquid fuel warmed sufficiently to cause the water to separate.

In calculations of the hydrocarbon gases the figures given above are combined; thus for benzene, C₆H₆, the calorific capacity is 10,052 from the gas or 9,960 cal. from the liquid,

This substance requires in all 3.077 times its weight of oxygen, and produces 3.385 parts of CO_2 and 0.6923 of H_2O , or 4.077 in all.

The calculation for temperature is therefore—

$$\frac{9,960}{(0.6923 \times 0.479) + (3.385 \times 0.217)} = 9,343^\circ\text{C.} = 16,849^\circ\text{F.}$$

when burned in oxygen.

With air there is an added weight of nitrogen equal to 3.077×3.32 , the specific heat of which is 0.244.

This product, $3.077 \times 3.32 \times 0.244$ is added in the denominator, and the resulting temperature is found to be $2,798^\circ\text{C.} = 5,040^\circ\text{F.}$

Any excess of air above that chemically necessary is then allowed for by means of the extra term in the denominator ($W \times 0.237$), as above explained.

Relative Volume of Gases produced by Combustion.

When a fuel contains carbon only the volume of the gases produced by perfect combustion is identical with the air admitted to the furnace, for in producing carbon dioxide two volumes of oxygen produce two volumes of carbonic acid, or $\text{C} \times \text{O}_2 = \text{CO}_2$, which, like almost all compound gas, occupies two volumes.

When combustion is imperfect and carbonic oxide is formed, the result is $\text{C} + \text{O} = \text{CO}$, or *two* volumes from only *one* volume of oxygen, and the waste gases exceed the volume of air supplied.

Sulphur in a fuel leads to no change in volume. Hydrogen, 2 volumes, forms with 1 volume of oxygen 2 volumes of gas, or $\text{H}_2 + \text{O} = \text{H}_2\text{O} = 2$ volumes of water vapour. But when flue gases are collected the water vapour condenses and there is a diminution of volume.

Each unit of hydrogen in fuel requires 8 units of oxygen.

Expressed metrically, 1 gram of hydrogen will consume 8 grams of oxygen. As oxygen weights 1.43 grams per litre, each 1 gram of hydrogen will cause to disappear 5.6 litres of oxygen or nearly 0.2 cubic feet.

This volume disappears and the total volume of gases must be increased by the addition of the volume of oxygen destroyed by hydrogen.

Though not of much account in respect of coal, the large percentage of hydrogen in liquid fuel renders the waste gases, when cooled, very much less in volume than the original volume of air. Thus an ordinary oil may contain 12 per cent. of

hydrogen, or 120 grams per kilogram. This will destroy 960 grams of oxygen or 672 litres for each kilogram of liquid fuel. In calculating the percentages of the total gases this volume of vapour must be allowed for. Per pound of fuel containing say $12\frac{1}{2}$ per cent. of hydrogen exactly one pound of oxygen will be used measuring 11.2 cubic feet. Thus should the apparent volume of air be 260 cubic feet, the actual volume would be 271.2.

The Table of gases (V) will be useful in such calculations.

Evaporative Power of Fuel.

The evaporative power of fuel is usually stated in terms of the water evaporated from and at, $100^{\circ}\text{C}.=212^{\circ}\text{F}.$, at which temperature all the added heat becomes latent and disappears at the rate of 537 calories per kilogram of water, or 966.7 B.Th.U. per pound. The theoretical duty is thus obtained by dividing the calorific power of the fuel by these numbers—

Hydrogen should evaporate $\frac{29,150}{537} = 54.28$ times its weight

of water. Carbon should evaporate $\frac{8,137}{537} = 15.15$ times, and

the best coals have a capacity of about $15\frac{1}{2}$ times, the highest values corresponding with the highest proportion of hydrogen when this is not neutralized by being already in combination with oxygen. Liquid fuel may run as high as 22 evaporation.

The actual evaporation secured will fall short of the theoretical by 15 per cent. in the very best exceptional cases to 30 per cent. in good but heavily worked boilers, the results obtained depending upon the perfection of combustion, the avoidance of excessive air and the proportions and condition of the boiler. A good result with coal is $10\frac{1}{2}$, which corresponds with about 15 for good liquid fuel. Coal often falls as low as 8 and liquid fuel as low as 12.

Reference is made elsewhere to the supposed superior efficiency of liquid fuel as compared with solid fuel, in regard to the fact that Nature has supplied the latent heat of liquidity, but it is also shown that probably the effect is small, the latent heat of liquidity being only a fraction of that of vaporization. Gaseous fuels, therefore, should be expected to give higher values than liquid fuels. The formulæ for calculating the calorific effect of a fuel give a result greater than the actual calorimetric values of hydrogen and carbon. In a liquid fuel the carbon should give more than its nominal solid rating, but, on the other hand, the rating of hydrogen at 29,150 cal. is

obtained from hydrogen gas, and, in a liquid fuel, the hydrogen has been deprived of its latent heat of gasification, and by so much must lose effect when burned, and, per pound, the hydrogen loses much more than is gained per pound of carbon. Solid fuels, of course, lose still more, but the difference between liquid and solid fuels is not very great in respect of their difference of physical condition. Where liquid fuel secures its high calorific value is in its very high percentage of hydrogen, and its freedom from oxygen and ash. The absence of oxygen is a proof of the full efficiency of the hydrogen, except so far, of course, that the hydrogen is combined with the carbon and the combination when effected was exothermic.

As a sample of liquid fuel calculation, a petroleum may be taken, such as a heavy Baku oil, with 87.0 per cent. of carbon and 13 per cent. of hydrogen. The excess of air will be assumed to be 50 per cent. beyond theoretical requirements. The oil was tested to give 10,843 calories by Mahler.

Calculated by the improved Dulong formula we have—

$$\text{Cal.} = (8,100 \times 0.87) + (29,000 \times 0.13) = 10,817 \text{ cal.}$$

which corresponds very closely with the calorimetric test.

Had the full values of 8,137 and 29,150 been employed, the result would have been slightly above the actual finding, and for a very pure hydrocarbon it is probable that calculation and tests will not prove to be far apart.

The temperature secured by this oil with the 50 per cent. air excess will be—

$$10,817$$

$$\frac{(\cdot 87 \times 3.66 \times 0.217) + (\cdot 13 \times 9 \times 0.479) + (3.36 \times 3.32 \times 0.244) + (5.575 \times 0.237)}{5.296}$$

In the formula the first term of the denominator gives the heat absorbed by the CO₂ formed from 0.87 of carbon, and the oxygen consumed is 0.87 = 2.66 = 2.32. The second term gives the heat absorbed by the steam produced from 0.13 of hydrogen, and the oxygen consumed is 0.13 = 8 × 1.04. The third term gives the heat in the nitrogen which accompanies the consumed 3.36 of oxygen.

The total weight of air used is thus 3.36 + (3.36 × 3.32) = 11.15. Then 50 per cent. of this, or 5.575, is put into the fourth term with the specific heat co-efficient of air. Working out, the result is—

$$\frac{10,817}{5.296} = 2,042^{\circ}\text{C.} = 3,708^{\circ}\text{F.},$$

as the theoretical temperature of the fuel when supplied with

50 per cent. excess of air. This shows how temperature is reduced by excessive air. Granted that this temperature is more than would actually be attained owing to the rise of the specific heat of gases with the temperature, the fact remains that the furnace temperature would be more nearly maintained along the flues. The absorption of heat by the boiler, lowering the temperature, would set free the heat which has become latent under the term specific heat, and the curve of temperature drop would be less steep.

But beyond all this there is a final chimney temperature beyond which it is not commercially practicable to reduce the gases, and if by using too much air we double the weight of rejected gases, these, at a given temperature, will carry off just twice as much heat as would be carried off by half the weight. Thus, if the chimney temperature is 950°F . or 400° above the atmospheric temperature, each pound of gas runs away with approximately $400 \times 0.237 \text{ B.Th.U.} = 94.8 \text{ B.Th.U.}$, which is about $1,560 \text{ B.Th.U.}$ per pound of carbon fuel burned or approximately 9 per cent. of the heat, on the assumption that the chemical minimum of air has been used. But had the air supply been doubled the heat thrown away would have been doubled also, and a loss of about 18 per cent. would have been incurred.

Excepting that it is important to have clear ideas upon the effect of air supply, it does not much concern the engineer to know what theoretical temperatures are secured, though he must be on his guard against unduly low temperatures in the furnace, and be prepared to guard against this by proper design, such as keeping heat-absorbing surface away from the gases until combustion is sufficiently perfect to enable this to be done.

The engineer is usually concerned with the evaporative efficiency of a fuel, and calculates this from and at the boiling point of $100^{\circ}\text{C.} = 212^{\circ}\text{F}$. The heat of evaporation of a kilogram of water is 536.5 cal. or 965.7 B.Th.U. per pound. The evaporative power of a fuel is therefore to be directly obtained by dividing its unit calorific capacity by the heat of vaporization of water from and at 100°C .

For pure carbon the figure obtained is—

$$E = \frac{8,137}{536.5} = 15.165, \text{ or, in British figures,}$$

$$E = \frac{14,647}{965.7} = 15.167,$$

the slight discrepancy being due to errors in the equivalents for want of unimportant decimals.

The actual evaporation of a steam boiler never approaches the calculated figure within 20 per cent. This 20 per cent. of loss of effect is due to several causes—

- (1) The whole of the fuel is not burned perfectly.
- (2) The waste gases are sent away to the chimney at a temperature considerably above that of the atmosphere at which the fuel and air is supplied.
- (3) There is a large excess of air in the waste gases.
- (4) Much heat is lost by radiation from the boiler and brickwork; and, with solid fuels, in ashes and clinkers.

M. Clavenad has a peculiar method of calculating calorific capacities. He points out that the figures of 8,000 and 34,500 for the solid and gaseous states of carbon and hydrogen respectively are incorrect for liquid hydrocarbons. The heat disengaged by gaseous carbon when burned is equal to that disengaged by four atoms of hydrogen gas.

The atomic weight of carbon being 12, and one kilogram of hydrogen having a power of 34,500 calories, then 1 kilo of carbon in a gaseous hydrocarbon will possess—

$$\frac{34,500 \times 4}{12} = 11,500 \text{ calories.}$$

In the complete combustion of carbon the first reaction, $C + O = CO$, produces as much heat as the second, $CO + O = CO_2$. The weight of carbon in one kilo of CO being 0.428 kilo, and the combustion of this from CO to CO_2 producing 2,431 calories, therefore 1 kilo of carbon completely burned must produce—

$$\frac{2,431 \times 2}{0.428} = 11,360 \text{ calories.}$$

Hence M. Clavenad takes the calorific power of gaseous hydrocarbon as 11,500 or 11,360 for the carbon, and 34,500 for the hydrogen, figures which, however, will not fit with actual determination, because of the disturbing effects of exothermism, as in the case of marsh gas, CH_4 , which falls much short of calculation.

Mahler has shown in the table below that the calculated calorific capacity on the assumption of $H = 34,511$ and $C = 7,860$ is greater than experiment shows to be the case.

The difference $P - p$ is less for crude oil than for products industrially produced. The calorific power of the various oils studied ranges from 10,300 calories for crude Russian to 11,100 for American crude.

According to Colonne and Lordier, the relative weights of different fuels to give equal evaporation are—

Petroleum residue	100
Peat	320
Coke	142
Good coal briquettes	140
Anthracite (Donetz)	139
Coal	153
„ Moscow Basin	276
„ Ural Basin	176
„ Kauban Basin	140
„ Poland	165
„ Silesia	167
„ English	139

Goutal's formula for calculating the calorific value of fuel from its composition is—

$$P = 82 C + aV ; \text{ where}$$

P = calorific power in calories.

C = percentage of fixed carbon.

V = percentage of volatile matter.

a = a variable co-efficient depending on the amount of ash and water in the fuel.

Using the formula—

$$V' \times = \frac{V \times 100}{C + V}$$

the following values are obtained for (a).

V' = 5, 10, 15, 20, 25, 30, 35, 38, 40.

a = 145, 130, 117, 109, 103, 98, 94, 85, 80.

This formula is applicable to solid fuels.

SMOKE AND COMBUSTION.

The Combustion of Hydrocarbons.

When hydrocarbon fuels are burned there may be formed smoke of two distinct varieties. The first is the greenish-yellow fume which is driven off coal when placed upon a fire. This fume is simply hydrocarbon gas with its contained tars, and can be burned. It is the usual smoke produced by the domestic fireplace, and burns freely when an under fire becomes hot and the gases are once fairly alight.

The other variety of smoke is the black smoke which deposits soot. Soot is a flocculent variety of carbon which is produced by the sudden cooling of heated hydrocarbon gases. In the furnace of a boiler wherein the green gases are well ignited they are allowed to come into contact with the cold surfaces

ANALYSIS
AND HEAT OF COMBUSTION OF VARIOUS PETROLEUMS.

	C.	H.	O + N.	Water.	Ash.	C.	H.	O + N.	Observed.	Calorific Power. Calories.		
										After allowing for Cinders, etc.	P 345 H + 78.6C	Difference P-P.
Heavy American Oil	86,894	13,107	—	—	—	86,894	13,107	—	10,913	11,352	439	
Refined "	85,491	14,216	0,293	—	—	85,491	14,216	0,293	11,047	11,624	577	
American Petrol	80,583	15,101	4,316	?	?	?	?	?	11,086	11,543	457	
" Crude.	83,012	13,889	3,099	?	—	?	?	?	11,094	11,316	222	
Heavy Baku Oil	86,700	12,944	—	—	0.35	87,005	12,989	—	10,805	11,320	477	
Novorossisk Oil	84,906	11,636	3,458	?	—	?	?	?	10,328	10,688	360	
N.S.W. Sekest Oil	74,574	10,576	3,913	?	10,937	83,732	11,875	4,393	9,246	10,678	297	
Ozokerite (Boryslav)	83,510	14,440	0,100	?	1.95	85,170	14,720	0.11	10,946	11,773	610	

of the boiler, and soot is formed. Had the green gases been supplied with air intimately mixed, they would have burned completely with no smoke, if they were not cooled down by the boiler. When a boiler furnace is of correct form, the combustion of the hydrocarbon gases can be secured when a proper admixture of air is carried out, and in the Lancashire, Cornish, and other shell boilers, smokeless combustion can be approximated if the draught is good. The means of admitting air is usually a grid in the furnace door. The air thus admitted sweeps over the whole surface of the fire and becomes blended with the gases given off the green coal, and perfect combustion will take place if there is sufficient free space beyond the bridge in which flame can burn unhindered by cold water pipes.

If, however, the draught is poor, the air drawn in over the fire through the door will be insufficient, and smoke will be produced. About 3 to 4 square inches of air openings are necessary for each square foot of grate surface.

When insufficient draught is due to the smallness of the chimney or flues, or to bad brickwork, it can be remedied by repairs, or by the use of a small steam jet, to induce a flow of air through the door grid.

If the poor draught is due to the necessity of closing the dampers to moderate the intensity of the fires, it is then necessary to reduce the area of the fire-grate, so that the chimney draught may be made more intense on the smaller area, the damper being kept open. This keeps up the draught sufficiently to compel the air to flow in at the door grids in ample volume. The same effect may sometimes be secured by fitting dampers to the ash-pit opening, so as to control the intensity of the fires even with a full open chimney damper. The full draught power then remains available to draw in air through the door grids to burn the hydrocarbon gases above the fire. Any draught less than $\frac{1}{2}$ -inch water-gauge, or say a velocity of 30 feet per second, will usually make it impossible to burn coal without smoke.

In no case can smoke be prevented where the gases rise vertically from the fire and pass directly between the tubes of a water-tube boiler, for the necessary mixture of air has not been secured. Belleville tried to effect a mixture by blowing high-pressure air jets into the furnace in order to mix up the gases, but the method is faulty, and cannot be a success where the tubes are so close above. The same principles apply to the combustion of liquid fuel, with certain differences due to the method of firing. With liquid fuel the supply of gas is uniform and continuous, and the fuel is supplied in exceedingly small

particles intimately mixed with air to begin with, and supplied with a further volume of air from below. A uniform high temperature is maintained in the locus of combustion by a sufficient mass of fire-brick work in the form of arches or chequer work.

The production of soot is well illustrated by the system of manufacture of lamp-black, which is carried on by burning a large number of oil lamps in a confined space with an insufficient supply of air at a low temperature. Soot is thus formed, not alone by cooling heated hydrocarbon gas, but by attempting to burn it with an insufficient air supply.

Oil fuel will produce dense smoke when not supplied with sufficient air, but in all the approved methods of combustion the requisite air is supplied, and can be regulated very exactly. Combustion also takes place at a high temperature, and the flame produced is comparatively short, and combustion can be completed in a comparatively restricted space, as in the firebox of a locomotive, which can be perfectly fired by oil fuel without any change from the conditions found necessary with coal. All manner of contrivances have been patented for the prevention of smoke, but few, if any, have realized the all-important detail of temperature, for without sufficient temperature in addition to the proper mixture of air in a furnace of correct form, there can be no perfect combustion.

All smoke troubles may be attributed in general terms to the too early application of the heat absorbing surfaces of the boiler to the yet unconsumed gases. While the foregoing arguments apply more particularly to coal, their principles are equally applicable to oil. Anthracite coal, which contains no hydrocarbons, burns away altogether at the grate surface with an intensity of temperature very much in excess of that of any bituminous coal.

The latter must be distilled on the grate, and much heat is absorbed in the gasification of the hydrocarbons. The zone of combustion is very much extended, the temperature at the grate is less, and it is necessary to conserve the heat generated on the grate in order to keep hot the hydrocarbon gases, so that these also may burn and not be wasted. With liquid fuel the gasification is already partially effected, and combustion is rendered more perfect by heating the liquid and also heating the air by which it is atomized. Thus, if the oil and air be both heated to 200°F., the temperature of combustion will be higher by about 150°F. than if both oil and air were supplied at the ordinary atmospheric temperature. The following extract from the Author's paper on the subject of hydrocarbon com-

bustion in the *Electrical Review*, of August 30, 1901, may be of interest in this connexion with the subject of furnace temperatures.

Furnace Temperatures.

An argument in favour of the necessity of refractory furnaces for bituminous fuel is that only a proportion of the total calorific capacity of a bituminous coal is generated on the grate, and therefore the fuel which burns on the grate is debited, not only with its own combustion, but also with the splitting up of the hydrocarbons and other volatiles, and raising them to such temperatures as will enable them to burn at a second zone of combustion.

An average of 18 analyses of Newcastle coal gives the following figures—

Fixed carbon	48.84 per cent.
Volatile carbon.	33.29 „ „
Hydrogen	5.31 „ „
Oxygen	5.69 „ „
Nitrogen	1.35 „ „
Sulphur	11.24 „ „
Ash	3.77 „ „
Calorific capacity	15,203 B.Th.U.

The calorific capacity of amorphous carbon is about 14,647 B.Th.U. per pound; therefore the capacity of the 48.84 per cent. of fixed carbon in the above samples must be 7,150 B.Th.U. As regards the fire upon the grate, these 7,150 heat-units are all we have to work with. We have to draw on them for the heat which becomes latent in converting the solid coal to the gaseous hydrocarbon. A piece of coal is all solid, and excepting the ash, it all becomes gaseous. Subtracting for cinders 3.77 per cent., there remains 47.0 per cent. of volatile solid matter, which ultimately passes off in a gaseous state. The customary allowance of air is about 18 pounds per pound of coal. This also must be heated up to the general temperature by the heat developed on the grate by the fixed carbon only.

The theoretical flame temperature of carbon when burned in an exact sufficiency of air (i.e. $11\frac{1}{2}$ pounds per pound) is $4,892^{\circ}\text{F}$. We can readily calculate the net temperature of all the products in the usual manner, though the result will be approximate only. We may assume 1 pound of coal, and we will add the customary 18 pounds of air, so as to produce a final 19 pounds of the total furnace products. As the temperature of combustion of carbon in air is $4,892^{\circ}\text{F}$., when using 11.6 times its weight in air, the temperature with 18 pounds of air will be $\frac{12.6}{19} \times 4,892 = 3,245^{\circ}\text{F}$. But with the heat produced by

48.84 per cent. of the coal, we have to carry the further load of volatile fuel and inert ash that is not burned on the grate, together with its similar proportion of excess air. The temperature of $3,245^{\circ}\text{F.} \times .4884 = 1,584^{\circ}\text{F.}$, and this is the maximum temperature of the products of combustion, assuming that they escape uncooled. This is a maximum figure, because whereas the temperature of combustion in air, namely $4,892^{\circ}$, is that due to a minimum of air, the reduced temperature involved by the use of excess of air as above calculated is really too great in part proportion as the specific heat of nitrogen is greater than that of carbonic acid; nitrogen, of course, forms by far the greater proportion of the furnace products, and it has a specific heat of 0.244, as compared with carbonic acid 0.217. Steam also, which is formed on the grate and does its share in reducing the temperature, has the high specific heat of 0.480, any free hydrogen that may escape has 3.410, and the hydrocarbons have also very high specific heats, for example, olefiant gas, 0.418; marsh gas, 0.593.

It is thus clear that the temperature of the gases as they flow to the bridge is quite low, and so far no deduction has been suggested for the vaporization of fully half the solid fuel into gaseous form. What, in fact, is the effect of the latent heat of evaporating carbon, hydrogen, oxygen, from the solid? for this is really what happens when bituminous coal is burned.

To evaporate carbon requires 5,817 British Thermal Units per pound, this being the difference between the calorific capacity of carbon burned to its monoxide, and of this monoxide burned to dioxide respectively. Hydrogen and oxygen combined require 11,000 heat-units per pound of hydrogen to raise them from the solid to the gaseous state.

Let the figure of 7,000¹ units of latent heat per pound be assumed for the whole of the volatile constituents of coal, that

¹ Possibly the figure of 7,000 may be too high, except for the carbon and hydrogen compounds. The value of carbon is as above about 6,000, as evidenced by the difference between the heat produced by burning carbon to its first oxide, and then again to its second oxide. That for hydrogen must be over 7,300, but the values for oxygen and nitrogen are low. Lechatelier determined the molecular specific heats of the elements as $6.65 + at$, where a is the constant, and t is the absolute temperature at which the measurement is taken. a was given by him as 0.001 for a considerable number, but he gave values for $a = 0.008$, and there is ample proof in Berthelot's great work that at high temperatures the specific heats of some substances may be double and treble the customary figure of 6.65. As the distillation of coal in a furnace is desired to be effected at at least $1,000^{\circ}$ or $1,500^{\circ}\text{F.}$ (say 550°C. to 800°C.) the specific heats will be something higher than 6.65.

is to say, for all that part which does not burn directly on the grate. This proportion was found above to be 47.0 per cent. of the whole, so that, per pound of fuel, 3,290 heat-units ($.470 \times 7,000$) must disappear in evaporating the volatile carbon, the oxygen, hydrogen, and other gases which exist in combined solid form in coal.

But we have already found that the total heat generated by the 48.84 per cent. of fixed carbon produces 7,150 heat-units. The difference between the heat generated by the fixed carbon and that absorbed by the volatile hydrocarbons of these particular Newcastle coals is thus only 3,870 units. This is all the heat that remains available for raising the temperature.

Now we have found an ultimate temperature of 1,584 when not allowing for the latent heat of gasification. We must correct this. It is less in the ratio of 3,870 : 7,150, or 857°F. That is to say, if bituminous coal be burned on a grate and those parts of the coal which volatilize and burn as flame be gathered unburned, the temperature of the whole production of the furnace, including 18 pounds of air per pound of fuel, would only be 857°, or considerably less than that necessary for ignition.

In the first place, this tells us that it is of the first importance to diminish the supply of air to a minimum.

By passing only half the air through the grate and adding the remainder as required to the evolved gases at a subsequent point, we can at once practically secure double the above temperature, or say 1,600°, a temperature at which ignition is possible. Moreover, even 9 pounds of air is 35 per cent. in excess of the allowance necessary to burn the fixed carbon of a pound of bituminous coal, so that it would be liberal practice to pass only half the total air through the grate. Some of the heat developed on the grate is at once radiated to the boiler surfaces; hence my constant contention that furnaces should be lined wholly or partially with refractory material in order to conserve the necessary temperature.

It must not, again, be overlooked that some of the evolved hydrocarbons do burn on the grate and at the fire surface. In fact, they commence to burn at once, and continue to burn to the end so long as conditions are maintained favourable to continuous combustion.

Rankine's estimate of air as found in ordinary practice was 25 pounds per pound of fuel. The so-called chemical minimum is $11\frac{1}{2}$ pounds. I have assumed 18 pounds as good practice, but as low or lower than 15 pounds has already been recorded by Mr. Michael Longridge.

If, however, we pass 9 pounds of air through the grate and, say, a further 6 pounds over the grate, in fine streams, to assist the combustion of the hydrocarbons, and take care that we do not abstract heat faster than it is generated by the burning gases, we ought to be able to secure perfect combustion with less than 18 pounds of air per pound of coal. There is no known reason why we should not. The impossibility of smokeless combustion has been widely and influentially urged, but never so much as by those engineers who cram their heating surfaces right upon the fire and never trouble their brains to inquire why it is that a thermometer shows the same continuous reading of 32°F. in a vessel of melting ice with a flame under it until all the ice is melted. A piece of coal, like a piece of ice, is simply so much solidified gas, and absorbs heat greedily while vaporizing, but it cannot be burned like so much solid carbon, but must have length and space in which to mix and combine with the oxygen of the air.

The following figures, based on Berthelot's investigations, will be useful in this connexion, for they show the enormous differences which exist between matter in its several states. Carbon, existing as it does free in Nature in at least three solid allotropic modifications, is a peculiarly interesting example. We do not know it as a liquid or as a gas except in combination. Its three solid forms of crystalline, graphitic, and amorphous, show by their variations of "latent" heat how great is the effect of form, even when the various forms affect one state alone. The gaseous state of carbon and the heat necessary to put it into that state are easily argued from the difference of heat disengagement in the two oxidations. As the table shows, the oxidation of 1 pound of carbon (diamond) produces 3,915 British thermal units when the product is monoxide. The heat disengaged by complete oxidation is 14,146 units. The difference of $10,231 - 3,915 = 6,316$ units, and this is obviously the minimum heat of vaporization of the diamond. Similarly, for the amorphous forms of carbon, the first oxidation produces 4,415 units, and the complete oxidation produces 14,647. Here the same difference is 5,817, and the greater heat evolution represents the energy necessary to recrystallize the diamond. Thus we learn that when the diamond crystallized it evolved heat, and we learn that the difference between graphite and the diamond is less than between graphite and amorphous carbon. In fact graphite is about six-sevenths along the road to becoming diamond.

Heat generated by the Combustion of 1 pound of Carbon.

State of Carbon.	Product of Combustion.	British Thermal Units per pound.
Diamond.	Carbon monoxide . .	3,915
"	" dioxide . .	14,146
Graphite	" " . .	14,222
Amorphous	" monoxide . .	4,415
"	" dioxide . .	14,647
Gaseous	" monoxide . .	10,232
"	" dioxide . .	20,463
2½ carbon monoxide .	" " . .	10,231

Metamorphic Conversions.		Heat absorbed.
Carbon (diamond) . .	Gas	6,316
" (graphite) . .	"	6,241
" (amorphous) . .	"	5,817
" (diamond) . .	Carbon (amorphous) .	499
" (diamond) . .	" (graphite) . .	74.7
" (graphite) . .	" (amorphous) . .	424

Stated briefly, about half the weight of a bituminous fuel burns upon the grate itself, and produces half the total heat of combustion; but that owing to the heat of formation of gaseous hydrocarbons, and generally to the vaporization of solid fuel, which absorbs so much heat, only about one-fourth of the total heat of combustion is sent off from the grate as sensible heat. The remaining three-fourths are developed between the fire surface and the extreme range of combustion. This range varies, of course, with the short or long flaming quality of the coal. Anthracite coal, which is entirely of solid carbon, and is therefore almost wholly burned upon the grate, will produce a temperature at the surface of the grate very considerably higher than bituminous coal will produce continuously. This is the reason why so much trouble is experienced with the grate bars when anthracite is used. It is evident that every fresh charge of bituminous coal has a very chilling effect upon the fire, and this is especially the case with intermittent firing. The chilling effect of a fresh charge of anthracite is merely that due to the heating of solid fuel, and is comparatively trivial. The bad effect of anthracite coal upon grate bars is usually attributed to some specially bad quality in the coal itself; but this is probably erroneous, the real cause being simply the high temperature, which melts the cast-iron bar. This explanation receives confirmation in the fact that bars go very quickly when they stand above the general surface of the

grate, projecting their upper edge into the body of the fire.

The question of combustion is further complicated by the variation of the specific heat of gases at high temperatures.

The subject has been most thoroughly investigated by M. Berthelot, to whose great work, *Thermochimie*, it is hardly necessary to say the Author is much indebted. That the specific heat of gases does increase with temperature there is now no doubt. At ordinary furnace temperatures the effect is not great, but such as it is, is in the direction of keeping down temperatures below what they would appear to be when calculated on the basis of constant specific heat at all temperatures.

First, only half the coal is burned actually on the grate; secondly, the other half and the excess of air work ever to reduce the temperature; thirdly, there is the reducing effect of vaporizing half the fuel, and this is simply enormous, and has never before been recognized as considerable, if indeed it has even been allowed to suggest itself; fourthly, there are the very active heat-absorbing surroundings of water-cooled plates or pipes. All these causes work together, with the further assistance of the increment of specific heat, to reduce the products of bituminous coal to a temperature below that at which perfect combustion is possible. The combined action is so powerful that even so-called smokeless Welsh coal will smoke in boilers of the Belleville type.

In any case, even if the effect of vaporizing the solid fuel has been over-estimated, the fact remains that it nearly approaches the figures given, and must prejudicially affect the furnace temperature. It teaches us at once the complication involved in burning bituminous coal, and the hopelessness of those forms of furnace that attempt to extract heat from the fire within a short distance of the fire itself, and this is equally applicable to liquid fuels which indeed are so very offensive if badly burned that they usually are furnished with brick linings for heat conservation and are burned without smoke.

Flame Length.

The length of flame from a burning hydrocarbon is largely determined by the intensity of the combustion, as well as by the perfection of the air admixture. A well mixed gas burning at a high temperature will produce a short flame, whereas the same gas burned in water-cooled boiler flues will produce exceedingly long flames. By using suitable furnaces with refractory linings, combustion may be made to complete itself in a short

distance. It does not follow because a certain fuel produces a flame 60 or 80 feet in length that it will be necessary to line the combustion space to a distance of 60 or 80 feet.

The very fact of lining it for one-tenth that length might so promote rapid combustion as to shorten the flame to even less than one-tenth. Once, however, that the initial temperature is reduced below a certain figure, the length of flame cannot be kept within bounds. This is important to remember, for even a hot flame will be extinguished after it has encountered the cold tubes of a water tube boiler. In comparing water tube and cylinder boilers, it should be noted that the area of cold surfaces over the fire of a cylinder boiler, either internally or externally fired, is a very small proportion of the whole heating surface. In the ordinary form of water tube boiler, where the gases rise directly between the water tubes, the proportion of cold surface at once encountered by them is very great. Apart from the errors already pointed out, the vertical rise of the gases from the fire is bad practice.

The water tube boiler need not of necessity be thus badly arranged. It can be set to give the most perfect combustion. Perfect combustion only takes place at a high temperature.

Flame Analysis.

The vibration velocity of light, by which is meant those etheric waves which are capable of making their existence felt to our organs of vision, varies from four hundred billion oscillations per second to nearly eight hundred billions; that is to say, about one octave alone comes within the capacity of the eye to discern. The lower number corresponds with the extreme red of the spectrum, the higher frequency with the extreme violet. Beyond the extreme red is a long range of oscillations—rays invisible to the eye—which manifest themselves as heat. Beyond the extreme violet rays exist a long series of invisible rays known as actinic or chemical rays. These are the rays which are most energetic in producing chemical effects. They are the active rays in photography, and are those which produce sunburn and the like effect from exposure to electric light. As these ultra-violet rays produce chemical effects, so are they produced by chemical action. The more intense the act of chemical combination, as in the burning of carbon, the greater will be the actinism of the light produced. Very high temperatures produced by combustion approach a white colour the more closely as the temperature rises, and to some eyes—fatigued by too much observation of molten cast-iron—

the clearance of the final hot slag gives a peculiar neutral light lavender colour indicative of the high temperature of a common foundry cupola.

The proportion of rays of any particular colour in a furnace will indicate the intensity of the action which is going on within that furnace. It is extremely difficult for the most highly experienced eye to discern the full action of a furnace at high temperature—not perhaps so much because of inability to estimate the relative amounts of colour present as because of the superabundance of heat rays which accompany the chemical rays, and generally the dazzling effect of even moderate temperatures.

The extreme brightness of the steel furnace has necessitated the use of blue or violet coloured glass to enable the workmen to watch the progress of the melt without discomfort.

Engineers have not accepted as they ought to accept the teachings of physics as an aid to correct practice. Science and practice have been kept apart. In the combustion of fuels, this neglect of scientific teaching is almost universal. The combustion of fuel, especially of bituminous coal, is carried out along extremely unscientific lines. The assertion is sometimes made that the hydrogen of bituminous coals cannot be counted upon as useful calorifically. This conclusion is erroneous.

Hydrogen ignites so very much more readily than carbon, and at so low a temperature, that the probability is the hydrogens do burn, and in doing so they snatch the available oxygen from the surrounding air and deprive the nascent carbon of any opportunity of combustion, causing it to deposit as soot. Unless there is sufficient temperature there is no hope of burning bituminous coal or oil, as it very easily can be burned, without the formation of smoke. Temperature is so closely connected with actinism that the analytical investigation of the light of a furnace will give a fair insight into its conditions of temperature. By means of transparent media of suitable composition light may be analysed in a manner that will afford great assistance in arriving at sound engineering conclusions and practice. Such media are coloured glasses. A ruby-coloured glass will cut off all rays of light of higher vibration than ruby colour. Only the lower end of the spectrum will be visible through such a glass. On the other hand, by means of a violet-coloured glass, all the less active rays than violet will be eliminated, and the most brilliant of furnaces may be thereby rendered easily visible, its interior being coloured the peculiar lavender grey colour, or approaching this tint, which

marks the ultra-violet end of the spectrum. The more perfect the combustion, the larger will be the proportion of violet light emitted by the flames.

In a well-designed furnace, the whole internal surface of which is brilliantly incandescent, light proceeds from every portion of the area and from the flame itself. There are no non-luminous areas. Occasionally in the mass of flame dark streaks may be seen. These represent streams of burning gas, which, while incandescent, are below the violet stage. They may be traced to a point of disappearance, and they would probably radiate some light if the colour of the glass were less violet and more blue.

Let the observation now be transferred to a less perfect furnace, such as that of the common setting of the water tube boiler, where the flames rise vertically among the tubes from the grate surface, and good combustion is impossible. With the unprotected eye the flames will appear to be giving light all the way from the fire surface to between the tubes. Combustion appears fair. If, however, these light-giving flames be examined by the aid of violet glass, they will be cut down to short tongues of flame projecting but little above the fire surface. Even these tongues of flame give forth little illumination. Above the flames the gases appear to be simply dark-coloured streams of gas, soot laden and murky. The violet glass or analyser has cut out all the rays of small actinic power and small temperature, with the result that the only remaining light rays are those immediately above the furnace.

The effect of radiation is to cool the flames below the range of violet long before they have risen to the level of the tubes. Apparently there is nothing but radiation to explain the reduction of temperature.

This method of analysis of the products of the fire is useful not merely because it enables a furnace interior to be visually examined with ease and comfort, but because it shows so clearly the effect of a good design and the bad influence of premature cooling. It affords most conclusive testimony to the benefits that accrue from proper design, and should be an effectual silencer of those who argue that smoke is one of the unfortunate inevitables of combustion in place of being but a proof of ignorant and careless design and neglect of the plainer principles of chemical science.

▶ The use of violet-coloured glass is essential. It is not simply that it is requisite to reduce the amount of light which meets the eye and renders vision impossible. Such a result could be attained by means of glass otherwise coloured, as by

smoke, so that it is less transparent, but still not diffusive, as is ground glass.

Violet glass or the higher blue colours are necessary because

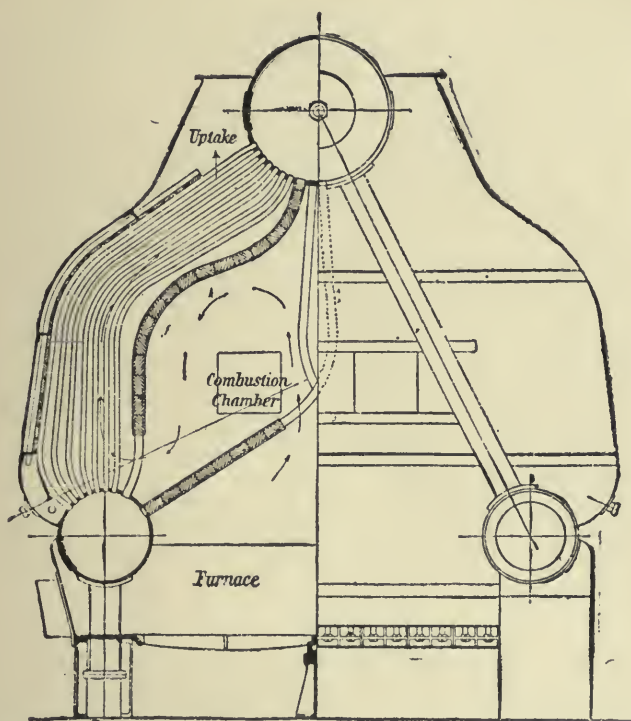

Fig. 7. WEIR SMALL TUBE BOILER, WITH REFRACTORY COMBUSTION CHAMBER.

The walls of the furnace are lined with fire-brick slabs, threaded on the inside row of tubes, and beyond the furnace chamber is a further combustion chamber also lined with fire-brick. The hydrocarbon gases have thus a long distance to travel before they reach any serious area of cool tube surface; the furnace is maintained at a high temperature, and there is large space for the combustion of the gases in a hot chamber, whereby alone combustion can be secured perfect. This boiler can be fixed either from side or ends, and represents the latest and most improved practice in water tube boilers, recognizing the principles essential to perfect combustion. The hot gases travel along the length of the tubes, completely enveloping them. The outer casing is of fire-brick slab with an outer sheet of steel. The following shows result of tests of two of these boilers with coal—

	Single-ended.		Double-ended.	
Grate surface	48.75	48.75	53	53
	1	1	1	1
Ratio to heating surface	45	45	41.3	41.3
Funnel draught	3.21 forced	0.6 nat.	3.5 forced	0.625 nat.
Calorific value of coal	13.38	13.38	13.2	13.2
Coal per square foot per hour	62.2	29	63.4	29.1
Evaporation per lb. of coal from and at 212°	9.05 lb.	10.7 lb.	8.65 lb.	9.76 lb.
Ditto per square foot heating surface	12.5 lb.	6.918 lb.	13.27 lb.	6.86 lb.
Boiler efficiency	67.65	80.0	65.5	74
Fire thickness	12 in.	12 in.	9 in.	9 in.
Funnel temperature.	—	789°F.	920°F.	780°F.
Steam pressure, lb.	285	251	275	276

of their specially analytical properties. I am not prepared to say that perfect combustion cannot occur at temperatures below those which are associated with the light rays that can traverse violet glass. It is, however, very probably true that

the violet degree of actinism must be very fully developed if combustion is to be perfect, and this degree of actinic effect cannot be associated with temperatures that can be secured in any furnace so arranged that the gases rise vertically from the grate surface to pass between the water pipes before they have been thoroughly commingled and burned in a free space.

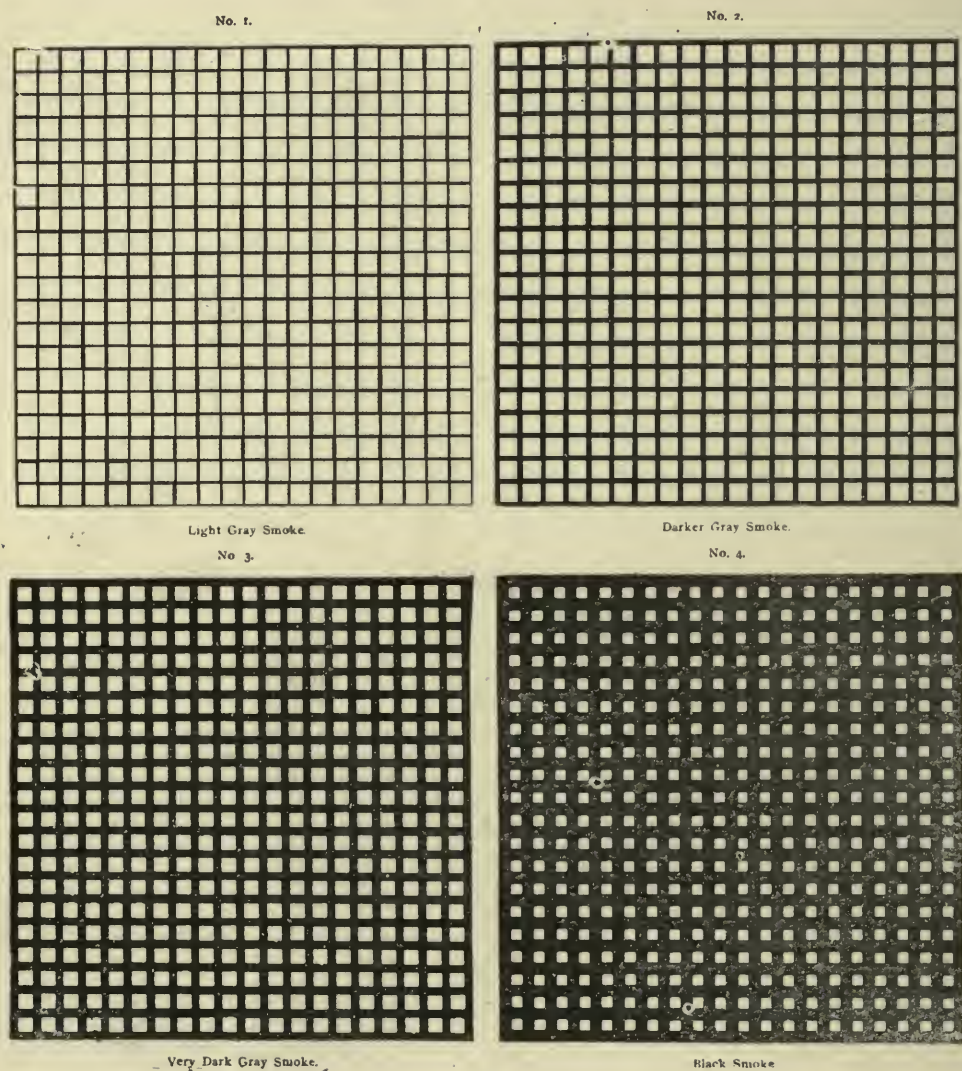

Fig. 8. RINGELMANN'S SMOKE CHART. No 0—ALL WHITE. NO. 5—ALL BLACK.

Thus the ordinary arrangement of water-tube boilers is absolutely hopeless and impossible. A single inspection of such a furnace through the analyser will effectually convert any open mind, and point the necessity for better practice.

Mr. Weir, of Glasgow, designed the small tube boiler shown in the Fig. 7, with the necessities for combustion before him.

It will be observed that in this boiler the gases from the coal must pass through a large firebrick-lined furnace and combustion chamber before they reach the tubes. Combustion is thus assured by a sufficient conservation of temperature. The principles which underlie perfect combustion are here assured, and smokelessness results. The same principles applied to liquid fuel are followed by equally happy results.

But in recent practice with liquid fuel it is found possible to attain very good combustion with little or no smoke without fire-brick lining to the furnace. See the latest practice of the Wallsend Slipway and Engineering Co.

Ringelmann's Smoke Chart.

This chart (fig. 8) is very useful as a means of comparing smoke. The chart should be ruled in squares of about eight inches, and hung about 50 feet from the observer, at which distance each square assumes a uniform tint all over, the rulings being indistinguishable. There are six cards in a set, No. 0 being all white and No. 5 all black.

The proportion of the lines is as follows—

No. 1.	Black lines 1 mm. thick, spaces	9 mm. wide
No. 2.	„ „ 2.3 mm. „ „	7.7 „ „
No. 3.	„ „ 3.7 „ „	6.3 „ „
No. 4.	„ „ 5.5 „ „	4.5 „ „

The illustrations are reduced from a larger size, and the proportion of black and white is of course preserved.

In marine work smoke may be observed by means of windows placed in the uptakes. An incandescent lamp on the other side of the uptake should be visible through the smoke. It should not be perfectly clear, for an entire absence of smoke may indicate an excess of air. A slight smoke indicates, when conditions generally are good, that air is not greatly in excess.

Part II
PRACTICE

CHAPTER VII

OIL FUEL AT SEA.

Oil Storage on Ships.

OBVIOUSLY the double bottom of a ship now used for water ballast is the place in which to carry oil fuel, leaving other spaces free.

As each fuel tank is emptied it can be filled with water. Lloyds' *Register of Shipping* publishes certain rules applicable to existing vessels, which should be studied. As they may be changed from time to time, they are not given in this book. Both Lloyds and the Board of Trade place only necessary safeguards, and do not oppose the use of liquid fuel. Sir Fortescue Flannery states that the peculiarly penetrative qualities of refined petroleum do not attach to the more viscous fuel oil, which he avers to be as easy to retain as water by the same class and quality of riveted work.

Additional water-tight subdivision is, however, advised as a safeguard against the scend of a half-empty oil tank, but in small or medium ships the usual subdivision is thought sufficient.

In the system of storage adopted on the s.s. *Murex*, a vessel with all her tanks adapted to carry either general cargo or refined oil, but not originally planned for using liquid fuel, for which purpose she was converted by the Wallsend Slipway and Engineering Company. there is no double bottom below the cargo tanks, which extend to the skin of the ship, but the bottom is double below the engines and boilers, and coffer-dams are put in at the fore and aft ends of the cargo space, and, with the fore and aft peaks, have been arranged to take the fuel oil. Service tanks were placed in the 'tween decks.

A flange on deck is coupled up to the pipe from the store tank, and oil passes by pipes to the various tanks, whence a pump lifts it to the service tanks, which are provided with overflow pipes, steam heater coils, and water drain pipes.

All leakage in the power compartment is intercepted by the drainage wells, so that the ordinary bilge is kept free. These intercepting wells have their own suction and delivery pipes.

In a regular oil tank steamer on the Flannery-Boyd system, the oil to be used is carried in the fore and aft peaks and in the ballast tanks under the engines and in the division bulkheads, the cargo of oil being carried in the remainder of the ship.

Between the oil tanks and the remainder of the ship it is considered necessary to place a coffer-dam. In a tank steamer the rest of the ship means the engine and boiler compartments. This coffer-dam is two transverse stiffened bulkheads extending across the ship and properly filled with water as a safeguard against leakage of oil. In practice this coffer-dam is often filled with fuel oil, a practice upon which doubts may be expressed, for apparently this destroys much of the safety intended to be given. Oil fuel is also carried in the double bottom below the engine compartments, which again is a point open to discussion, for a vessel might be so injured by going aground as to flood the boiler compartment with oil with risk of explosion.

It is safer practice to exclude oil from both the power compartment bottoms and from the coffer-dams, the latter being kept perhaps narrower than they are now.

Where the oil is of a specially heavy class, there might not be much risk if it did leak into the firehold, and good residuum or astatki would be something of a safeguard between the main tanks of crude oil and the boiler room. Be this as it may, the presence of a narrow water space outside the oil fuel coffer-dam gives a better margin of safety.

The riveting of oil-tight plating is usually 3 to $3\frac{1}{4}$ diameters in pitch. Old ships, to be rendered fit for oil carrying, which have rivet spacings of 7 to 8 diameters, may thus have a new rivet put into each spacing. Such ships usually require additional deck beams, as a rule. Ships should have not less than eight water-tight compartments, and the separating bulkheads, if oil tanks, ought to be connected directly to the skin of the ship, all possible empty spaces being avoided. Oil is filled into tanks so as to stand 2 feet above the upper deck level in the expansion trunks. The gases driven off from oil are heavy, and settle at the bottom of any space into which they obtain access. Ventilation is required to get rid of such gases. Air should be admitted through cowl heads to the upper part of the place to be ventilated and removed from the lower part. It will dilute and carry off the accumulated gas. Such air outlets should have induction openings to assist the current. The general direction of air movement in a ship is from aft forward, and advantage may be taken of this in arranging the ventilation.

Great care is needed to joint all oil pressure pipes carefully. The screw threads should be good, and ought to make tight joints with only a little smear of litharge and glycerine, or Venetian red and shellac. Pipes must not be concealed beneath floor plates, in bilges, or behind casings, but ought to be fully exposed to view.

An oil cargo being so easily mobile with movement of the ship, it is necessary that the tanks should be full, so that there may be no surging. Hence the use of expansion trunks to permit of this, and allow expansion without waste or pressure being the result. Surging plates must be employed in those compartments, which may not be always full, as the fuel tanks, and no compartment should occupy too much of the length of a ship without a bulkhead. Similarly bulkheads are stiffened from one to the other by longitudinal plates, which check transverse surging, or scending. The ordinary cargo boat, when fitted for fuel oil, is re-riveted when necessary, and the oil fuel is carried in the double bottom, and can be replaced, as consumed, with water ballast. Oil is also carried in the fore and aft peaks.

Oil Steamers.

One of the best examples of an oil steamer is the s.s. *Trocas*, which has been fitted for liquid fuel by the Wallsend Slipway and Engineering Company, Ltd., the system adopted being the Flannery-Boyd with Rusden & Eeles burners.

The ship is an oil-carrying vessel of 347 feet in length and 45.7 feet beam, and at full load carries 6,000 tons of oil.

One of the greater obstacles in the way of fitting old steamers with liquid fuel-burning arrangements is the difficulty of constructing suitable spaces to carry the liquid fuel. Ordinary coal bunkers are of course not suitable, as the riveting and plating is not oil-tight. In the Flannery-Boyd system the oil is carried in all the ballast tank spaces throughout the ship, namely, the fore and aft peaks, the double bottom ballast tanks under the engines and boilers, the forward ballast tank adjacent to the fore peak, and the forward and aft coffer-dam.

The main difficulty in carrying liquid fuel in these spaces is that some water always remains in a ballast tank, owing to the difficulty of completely draining it. This water becomes mixed with the liquid fuel, and passing to the burners causes dangerous explosions, and generally puts out flame. It is therefore necessary to eliminate the water. To do this two settling tanks of large capacity are placed in the 'tween decks amidships, adjacent to the boiler room bulkhead. These tanks

are fitted with heating coils to enable the liquid fuel to be heated to a sufficient temperature to allow of the water freely separating. The water then settles to the bottom of the tank, and can be drained off.

Each tank is made of sufficient size to contain half a day's supply, so that half a day is allowed for the water to become separated. From these separation or service tanks the oil gravitates to the burners, and is sprayed by a jet of steam.

Each furnace is fitted with two burners, and the furnace arrangements are such that the complete coal burning gear remains intact when burning liquid fuel, so that the system of either coal burning or liquid fuel burning can be resorted to at will.

If the vessel is burning liquid fuel, and it is found necessary from economical reasons to resort to coal burning, it is only necessary to rake a few broken fire-bricks from the bars and disconnect the burners and light a coal fire. This operation can be carried on without stopping the vessel at sea; the whole operation in a large vessel can be carried out within an hour.

The s.s. *Trocas* has three large single-ended boilers and one donkey boiler. The large boilers have each three furnaces, and the small boiler has two furnaces. All are fitted for liquid fuel.

The question of safety and flash-point is of importance. The British Admiralty did require a flash-point of 270°F., but now accept a minimum of 200°: Lloyds' register, of 200°, now reduced to 150°, while the German authorities have accepted as safe 150°. Fuel of the lower flash has been in constant use for four years in British and Dutch mercantile vessels, with complete immunity from accident. It is not desirable to fix a flash-point higher than is really necessary for safety, because high-flash points are obtained by removing the more volatile parts of the liquid, so as to leave a thick and sluggish residuum, which requires much power to pulverize it.

Comparative Advantages for War Vessels.

Sir Fortescue Flannery says: "The problem that confronts every designer of a warship is the combination of the maximum speed, armament, ammunition supply, protection, and range of action in the smallest and least expensive hull, and any reduction of weight and space of these is a saving which acts and reacts favourably upon the problem. The comparisons between coal and oil fuel realized in recent practice are that

2 tons weight of oil are equivalent to 3 tons weight of coal, and 36 cubic feet of oil are equivalent to 67 cubic feet of coal as usually stored in ships' bunkers; that is to say, if the change of fuel be effected in an existing war vessel, or applied to any design without changing any other of the data than those affecting the range of action, the range of action is increased 50 per cent. upon the bunker weight allotted, and nearly 90 per cent. upon the bunker space allotted.

“The coal protection of cruisers, if an advantage—a matter of opinion—would disappear with the use of liquid fuel, because it would be for the most part stowed below the water line, if not wholly in the double bottom. The double bottom and other spaces, quite useless except for water stowage, would be capable of storing liquid fuel, and the space now occupied by coal bunkers would be available for other uses.

“The ship's complement would be reduced by the almost complete abolition of the stoker element and the substitution of men of the leading stoker class to attend to the fuel burners under the direction of the engineers, and the space of stokers' accommodation, their stores and maintenance, would be saved. The number of lives at risk and of men to be recruited and trained over a long series of years would be reduced, without reducing the manœuvring or offensive or defensive power of vessels of any class in the fleet.

“Re-bunkering at sea—so anxious a problem with coal—would be made easy, there being no difficulty in pumping from a store ship to a warship in mid-ocean in ordinary weather. Three hundred tons an hour is quite a common rate of delivery in the discharge of a tank steamer's cargo under ordinary conditions of pumping.

“The many parts of the boiler fronts and stokehold plates, now so quickly corroded by the process of damping ashes before getting them overboard, would be preserved by the action of the oil fuel, and the same remark applies to the bunker plating, which now so quickly perishes by corrosion in way of the coal storage.

“Liquid fuel, if burned in suitable furnaces with reasonable skill and experience on the part of the men in charge, is smokeless. It is easy to produce smoke with it, but this is evidence of its being forced in combustion, or of the detailed arrangements of the furnace being out of proper proportion to each other. In regard to smokelessness, it is, when used under conditions customary in the merchant service, not inferior to Welsh coal, and superior to any other coal ordinarily in use.

“The cost of oil in the East is less than the cost of Welsh

coal when the cost of transport and Suez Canal dues are added to the original price of coal as delivered in a Welsh port.”

It is only since Texas oil has been discovered that the successful competition of oil has appeared probable to the west of the Suez Canal. In the mercantile marine advantage is gained by a reduction of the stokehold complement, a crew of thirty-two being reducible to eight.

Fast Atlantic liners find it difficult to get coal to their boilers for the firemen to burn, and they lose time in consequence, even when their engines and boilers are in perfect order. This difficulty disappears with oil, and there is a saving of space previously occupied by men and stores.

Allowing 3 tons of coal to be equal to 2 tons of oil, a first-class Atlantic liner will gain 1,000 tons for freight, as well as the whole of the bunker space. That is, with oil in the peaks and ballast tanks, there will be a gain of 100,000 cubic feet of paying space, and for most ships at least a fourth of the coal bunker space could be used for cargo. There is in addition the saving in time when coaling. Oil is pumped in without the help of a man. No fires require to be cleaned; there are no ashes to be removed.

Fires made by oil are perfectly steady, the steam pressure is constant, while the temperature of the stokehold in steamships is lower, since the furnace doors are never opened and hot cinders are not pulled out into the room.

The loss of heat up the stack is reduced owing to the clean condition of the tubes and to the smaller amount of air which has to pass through the furnaces for a given calorific capacity of fuel, and there is a more equal distribution of heat in the combustion chamber, as the doors do not have to be opened; consequently there is a higher efficiency. The heat is easier on the metal walls of the boiler, being better diffused over the whole surface.

The cost of handling fuel, by pumps, is reduced.

No firing tools or grate bars are used,¹ to damage the furnace lining.

1 No dust fills the tubes to diminish the heating surface.

[The fire can be regulated from a low to an intense heat in a short time.

Many factories in Pennsylvania and Ohio had to increase their boiler capacity by about 35 per cent. when returning to the use of coal on account of the high cost of oil.

¹ Grate bars may be employed, under certain conditions, as explained elsewhere.

CHAPTER VIII

MARINE FURNACE GEAR

THE use of steam or of air for atomizing is a mixed question. Steam is more convenient, and is naturally first used, but it becomes so severe a drain on the fresh water supply that it is practically inadmissible at sea.

The claim that its oxygen is set free by the fire and burned with advantage to the evaporative efficiency of the boiler cannot be allowed. The dissociation of water or steam absorbs exactly as much heat from the fire as is given back by the recombination.

Some makers of atomizing apparatus claim to secure a softer flame with steam, but so far as our chemical and physical knowledge extends, air ought to be superior. It requires, however, to be first compressed, and it is desirable that it should be heated to near the oil flash-point, so that the oil may burn freely as soon as atomized.

Ships in the Caspian Sea use steam, but are never far from land. Fuel may be injected under pressure and break up against an obstacle at the furnace mouth, or it may be vaporized by heat before reaching the furnace mouth.

In Mr. Howden's modification, fuel is injected under pressure mixed with air previously heated by the waste chimney gases, and this system has been fitted to the North German Lloyd steamers *Tanglier* and *Packman*; by Workmán, Clark & Co., of Belfast.

In the s.s. *Murex* already named, which arrived in the Thames in the spring of 1902 from a voyage of 11,800 miles, from Singapore via the Cape, the furnaces were never touched. Her coal consumption averaged 25 tons per day. With oil fuel the daily consumption is 16 tons only. The fuel supply arrangements, Fig. 9, consist of steam pipes *AAAA*, oil pipes *BBBB*, and burners *CCCC*, hung on swivels *D*, so as to be adjustable in position, and to allow the doors to open upon the same axis or hinge centre. Coal can be reverted to, when the burner orifices *FFFF* are closed by the pivoted slides. In Fig. 10 is shown

the brick work *H H* in the form of pillars and arches against which the flames first impinge. At *K K* are further baffle bridges to keep the flame from too severely striking the back of the combustion chamber carrying the stay nuts, the tube ends, rivet seams and parts liable to injury from excessive local heat.

The form of burner is the

Rusden-Eeles

type, Fig. 67, with adjustable annular orifices both for steam and oil (see Chapter XIX). They possess the quality of adjustability while at work essential to secure the most perfect

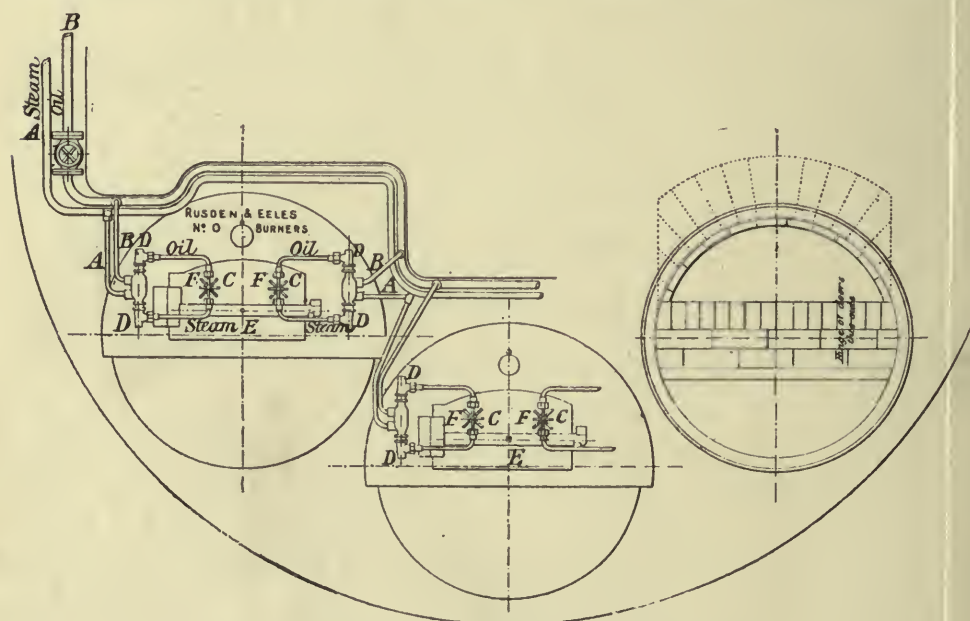

Fig. 9. FURNACE FRONTS OF S.S. "MUREX."

possible conditions of combustion. The oil annulus is surrounded by a steam jacket, and steam enters the middle chamber and escapes into the furnace round the central stem, which is drawn back by revolving the end wheel and allows an annular spreading steam jet to escape round the flaring end of the stem. Oil finds its way to the little ring chamber immediately at the nozzle, and is directed down the sloping ends of the slide directly upon the steam jet which pulverizes it and spreads it in the furnace. The oil slide is drawn back by rotating the larger handle.

Interchange of Coal and Oil.

To permit the ready interchange of coal and oil the s.s. *Trocas* with fitted as in Fig. 11, the coal grates remaining and being

covered with 8 inches of broken brick. The brickwork *B*, *C*, and *D* always remains in place.

To change over from oil to coal the burners are swung back to clear the furnace door, the broken brick is raked out, and

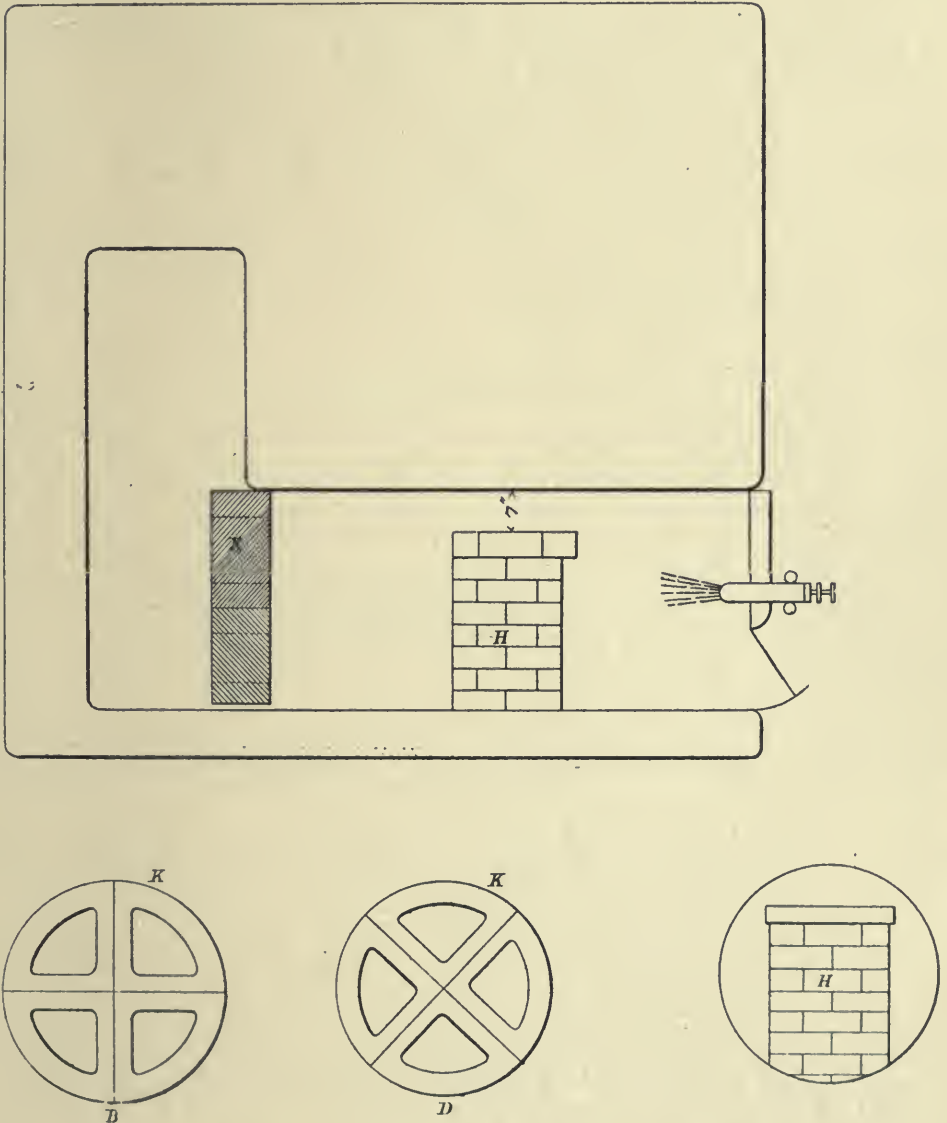

Fig. 10. ARRANGEMENT OF FURNACE BRICKWORK, S.S. "MUREX."

ordinary coal firing resumed. In twenty-eight minutes after steaming full speed under oil the *Trocas* was again at full speed under coal.

It is, however, found as the result of experience of long voyages that it is better not to let the firebars remain in when

using oil, for, at the worst, the change over can be made in a few hours, and better results obtained from oil with the more approved arrangement. The general arrangement of the s.s. *Trocas* is that of Fig. 10.

It is estimated by Sir Fortescue Flannery that the atomizing steam will amount to 0.2 pound per i.h.p. per hour. The waste is made up by large evaporators, usually in three interchangeable sections which should be worked steadily.

Two burners in each furnace are found to give better results than one larger burner, being more easily adjustable and maintaining continuity of flame. There is also greatly dimin-

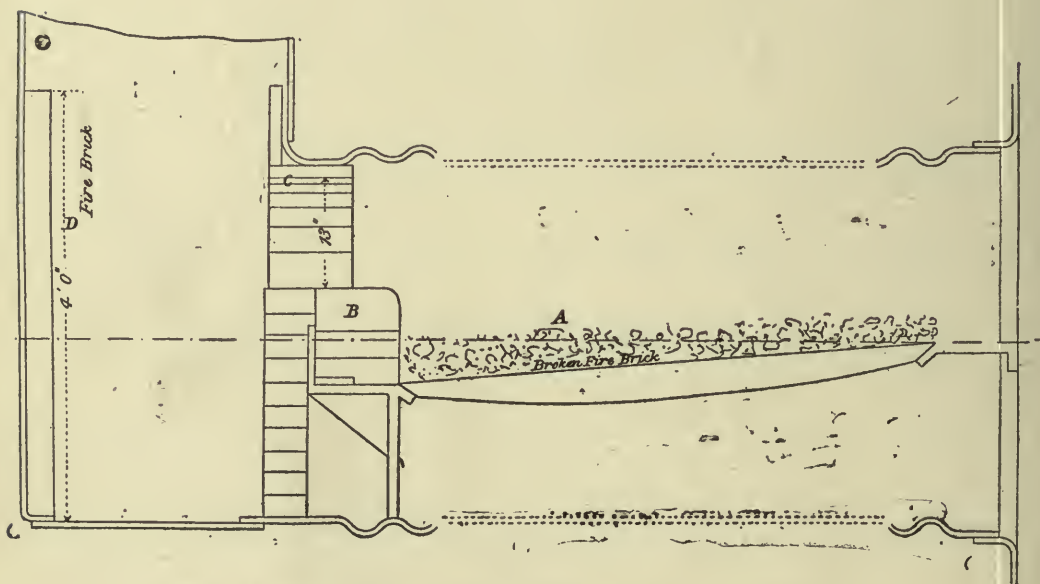

Fig. 11. FURNACE ARRANGEMENT OF S.S. "TROCAS."

ished chance of extinguishment of the flames by an accidental access of water from imperfectly dried oil.

The Flannery-Boyd System for Steamships.

The chief object of the system is to separate from the oil fuel the water which may have become mixed with it in any manner and also to enable oil fuel to be carried in ballast tanks or other compartments where water is usually carried.

To get rid of the water two or more settling tanks are used, in which the oil remains a sufficient length of time to permit of the water depositing. In each tank is a heating apparatus to assist the action, for by heating the oil the water is more quickly deposited, owing to the expansion of oil being greater than that of water, and because the oil is made less viscous by

heat. Two or more tanks must be used, so that while the water is being deposited in one tank the dried oil in the other may be fed to the burners. The system is applicable to any system of burning oil.

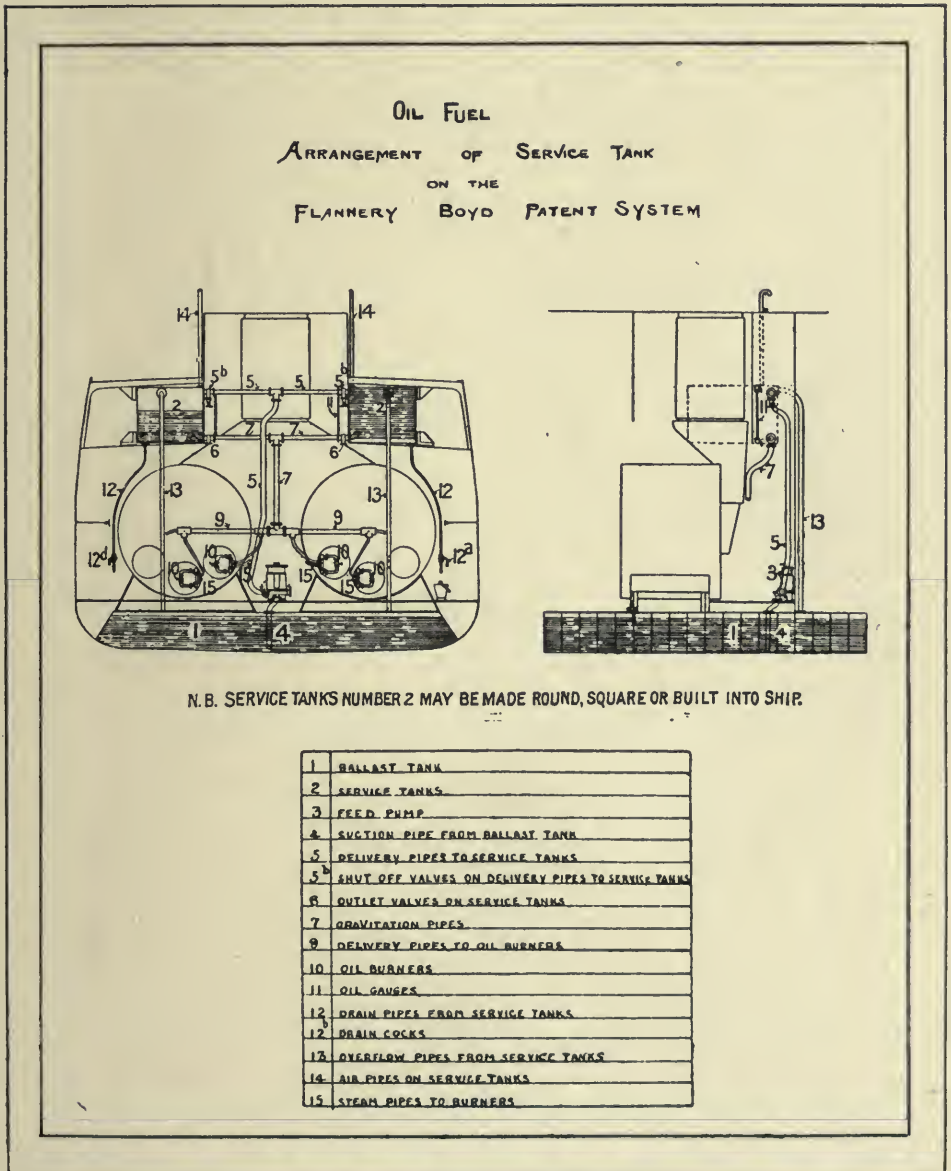

Fig. 12.

Fig. 12 shows the various pipe arrangements, the oil feed pump 3 drawing from the ballast tank 1 through a pipe 4 and delivering by pipes 5 to the service tanks 22, whence the oil gravitates by way of pipes 7 to the oil burner supply pipes 9.

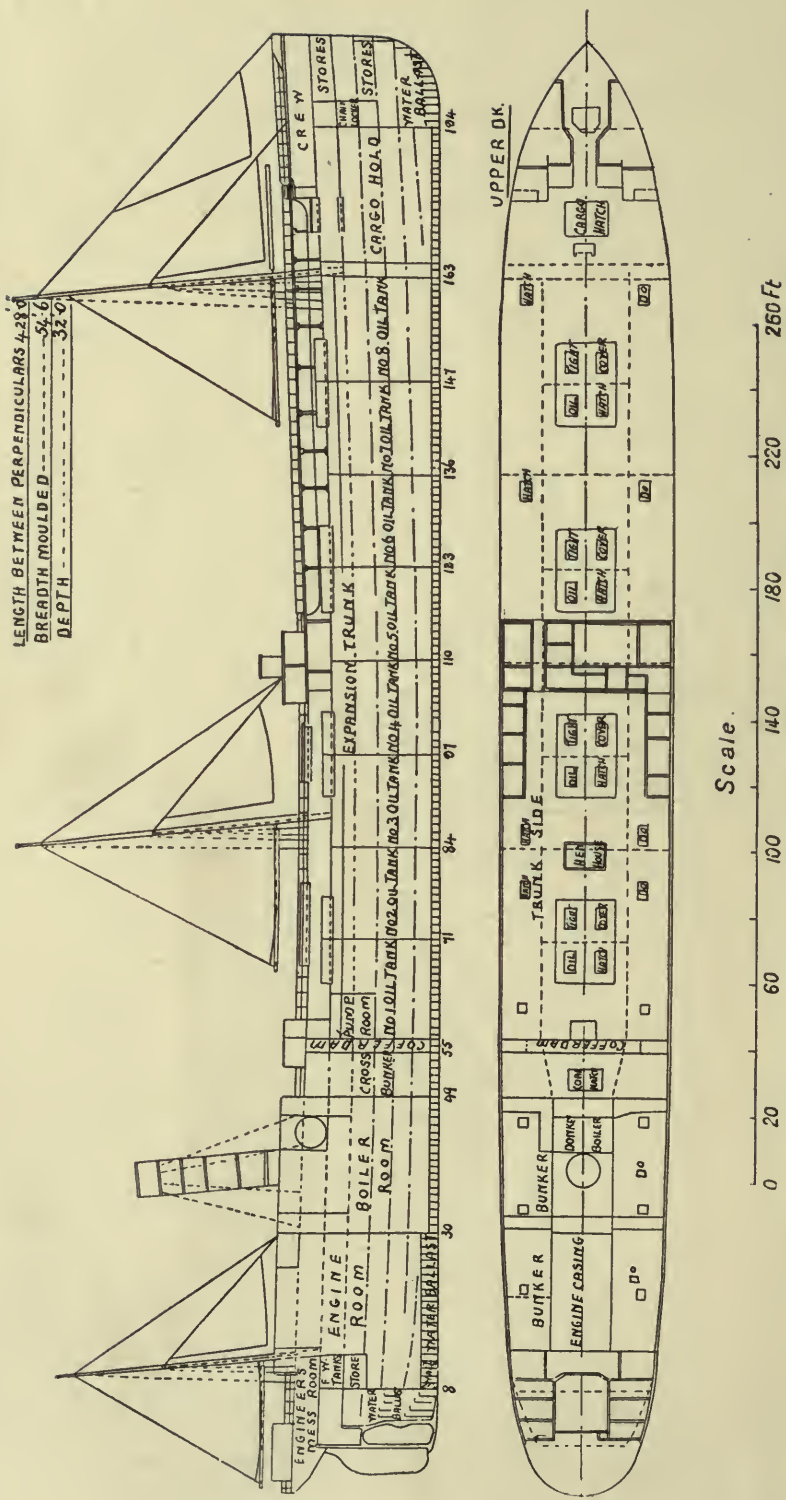

Fig. 13. GENERAL ARRANGEMENT OF OIL TANK STEAMER, S.S. NEW YORK.

Overflow pipes 13 carry back any surplus oil to the main tanks, and separated water is discharged by pipes 12.

The service pipes are kept free of pressure by vent pipes 14, carried up several feet.

The general arrangement of an oil ship is shown by a fairly

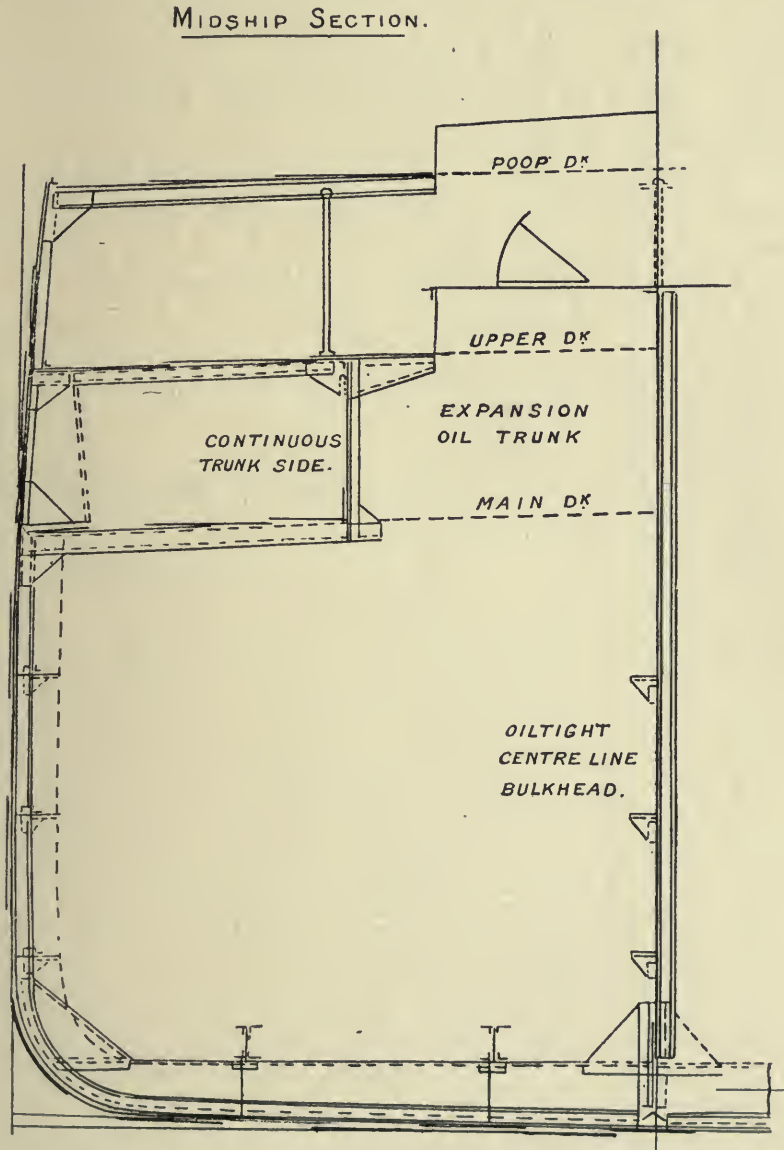

Fig. 13a. MIDSHIP SECTION OF OIL TANK S.S. NEW YORK.

recent example, the s.s. *New York*, Figs. 13, 13a, built by the Palmer's Shipbuilding and Iron Company, Ltd., of Jarrow-on-Tyne. In this class of vessel all the seams and butts of the shell plating, decks, and bulkheads are riveted, and the rivets are spaced, for oil tightness, $3\frac{1}{2}$ diameters centre to centre, instead

of 4 diameters as required for water-tight work. Special care is also taken to avoid as far as possible any rivet passing through more than two thicknesses of plating. The vessel is divided into eight pairs of oil tanks with expansion trunks for each pair. There is a coffer-dam at the back of No. 1 tank, separating it from the power department. A small hold for miscellaneous cargo is placed forward by No. 8 tank, from which it is separated by a coffer-dam. The oil tanks are divided along the centre line of the vessel by an oil-tight bulkhead, so that there are really sixteen oil cargo tanks. The length of the *New York* is 428 feet between perpendiculars, the breadth 54 feet 6 inches, and the depth 32 feet. The water ballast tanks extend the full length of the ship below the oil tanks. Coal bunkers are provided on each side of the engine and boiler compartments and also forward of the boilers, between the boiler compartment and the after coffer-dam.

The Orde System.

In Figs. 14, 14a, 15, are shown various arrangements of oil fuel burning by Sir W. E. Armstrong, Whitworth, and Co., of Newcastle-on-Tyne, according to the system of Mr. C. E. L. Orde.

Fig. 14 shows the general arrangement for a water tube boiler. Steam, superheated in the casing by means of a pipe carried round the steam dome, is taken to a subsidiary steam header, whence branch pipes issue to five separate burners. Oil is fed by similar pipes from a second header supplied from the bunker or oil tank through a heater on the right. This contains exhaust steam, and heats the oil on its way to the burners. The oil is drawn off from the tank as in Fig. 14a, by means of a floating arm, which always takes the highest oil from an area which is heated by a steam pipe coil placed under the intake of the oil pipe. A small pump forces the oil to the distribution system, a relief pipe carrying any excess back to the pump suction. Air, heated in the ashpit through which the pipe is laid, is supplied to the burners by a separate pump on the left. The copper steam pipe to the float is flexible to allow for the float movement, and the float is kept steady laterally by a piece of angle iron bent to a circular form to suit the path of the float arm. Blow-through steam pipes are fitted for clearing the oil pipes when required. The atomizer, Fig. 15, is triple, oil entering through the centre passage, with needle regulating spindle. Steam comes outside the oil through an annular passage and air is introduced outside the whole, the

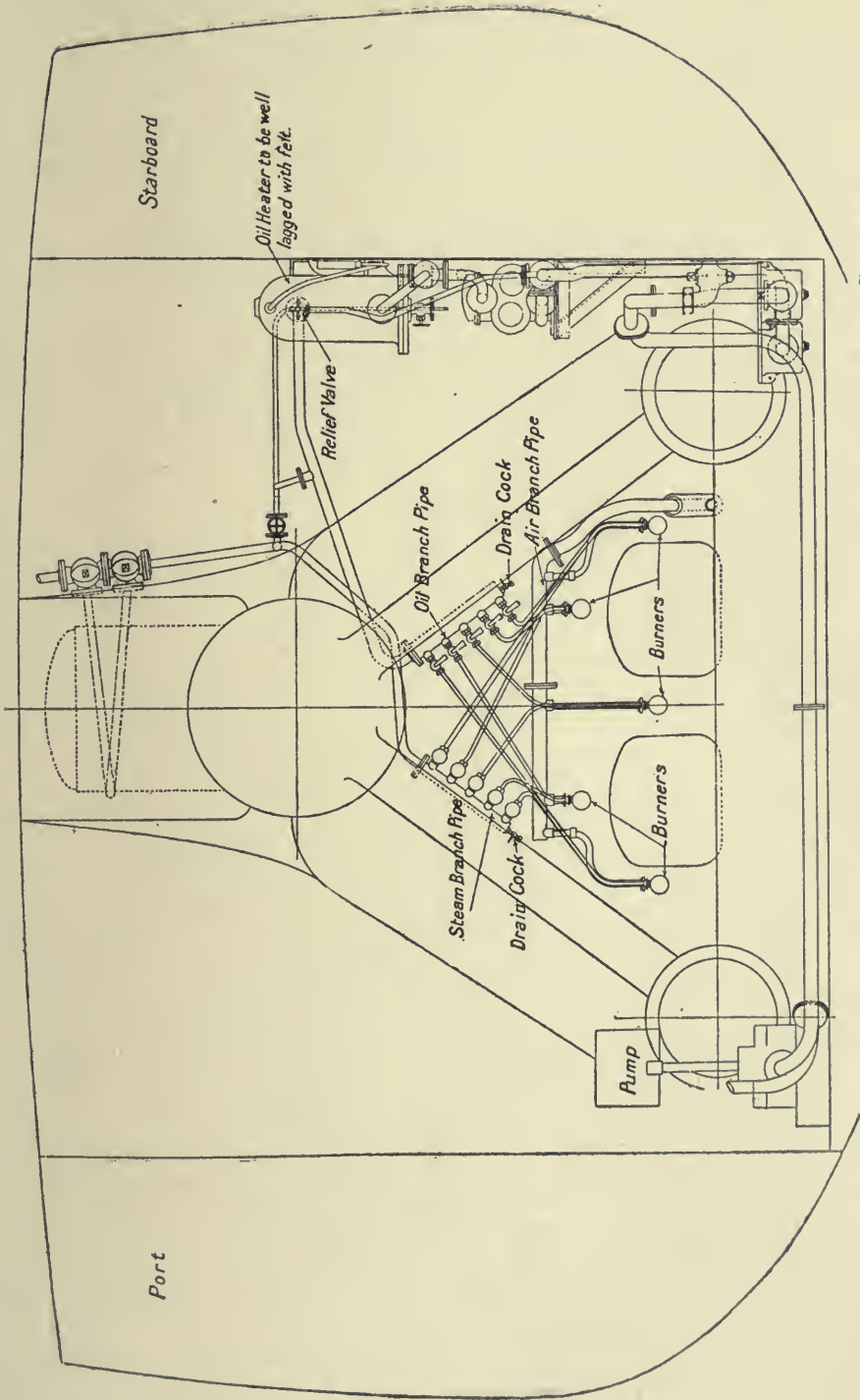
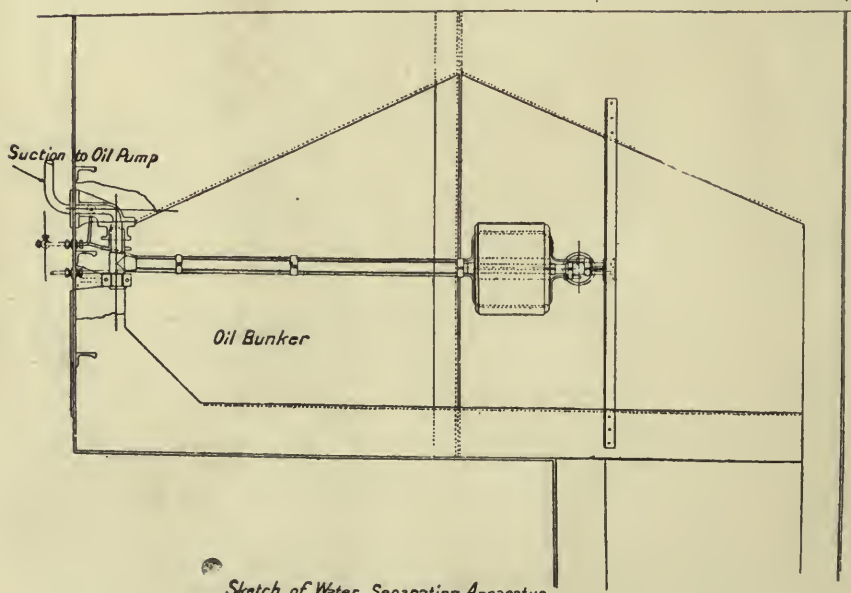
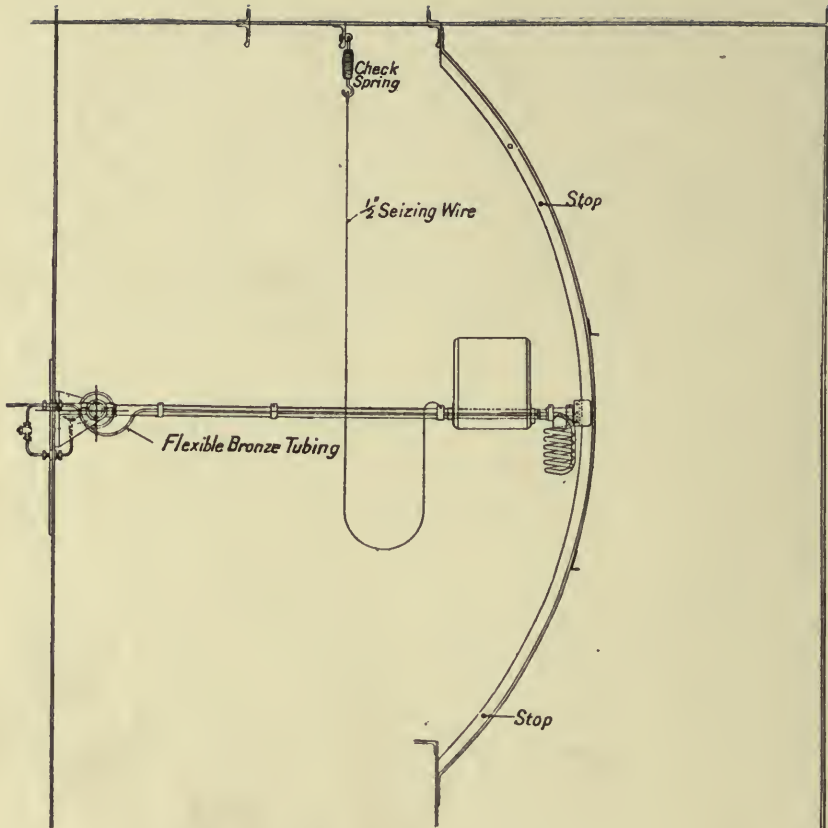

Fig. 14. ARRANGEMENT OF WATER TUBE BOILER. ORDE'S LIQUID FUEL SYSTEM.



Sketch of Water Separating Apparatus.

Fig. 14a. FUEL OIL BUNKER. DRAW-OFF PIPE AND FLOAT.

mixture being blown through the spreading orifice as spray. The oil does not come through as a solid jet into the combining nozzle, but as a thin annular shell jet easily atomized. The atomizer, however, differs from some others which admit air at the centre. The illustration shows the latest pattern (1911).

Highly superheated steam is intended to be used (preferably 600°F.).

The annexed table from a paper by Sir F. Flannery, in the *Transactions of the Institution of Naval Architects*, gives a few results.

Ship.	System.	Oil per I.H.P. per hour.	Coal per I.H.P.	Heating Surface.	I.H.P.	Per cent. of gain by use of Oil.
F. C. Laeisz	Körting .	lb. 1.408	lb. 1.93	sq. ft. 7,560	2,200	27.0
Sithonia . .	Howden .	1.065	1.49	6,924	2,500	28.6
Murex . . .	Rusden-	1.3	25 tons	5,202	—	36.0
	Eeles	16 tons p.d.	per day			
Syrian . .	” ”	1.32	—	2,480	800	—
Khodoung.	Orde . .	1.08	1.67	2,700	960	35.5

In each case, except the *Sithonia*, which had quadruple engines, the engines were triple expansion.

Lancashire Boiler with Orde's System.

The Lancashire boiler as arranged by the Wallsend Slipway and Engineering Company, for burning oil with or without a grate, is given in Fig. 16.

A single injector is applied to each furnace door, the grate is covered with broken brick, and at the middle of its length a brick baffle is built, round and through which the flames escape, and after passing a low bridge at the rear of the grate escape unimpeded.

Without a grate, the furnace is fitted with a brick oven and striking bridge, beyond which is a cellular baffle of brick which gives a final mixing to the gases before they are quite consumed.

A gravitation tank is placed about 10 feet above the level of the atomizers, with suitable valves, vent pipe, overflow and gauge. The supply pipe to the atomizer has a strainer in its course.

These various arrangements differ very little from those of other engineers, the chief object being the atomizing and the arrangement of the fire-brick oven and bridges.

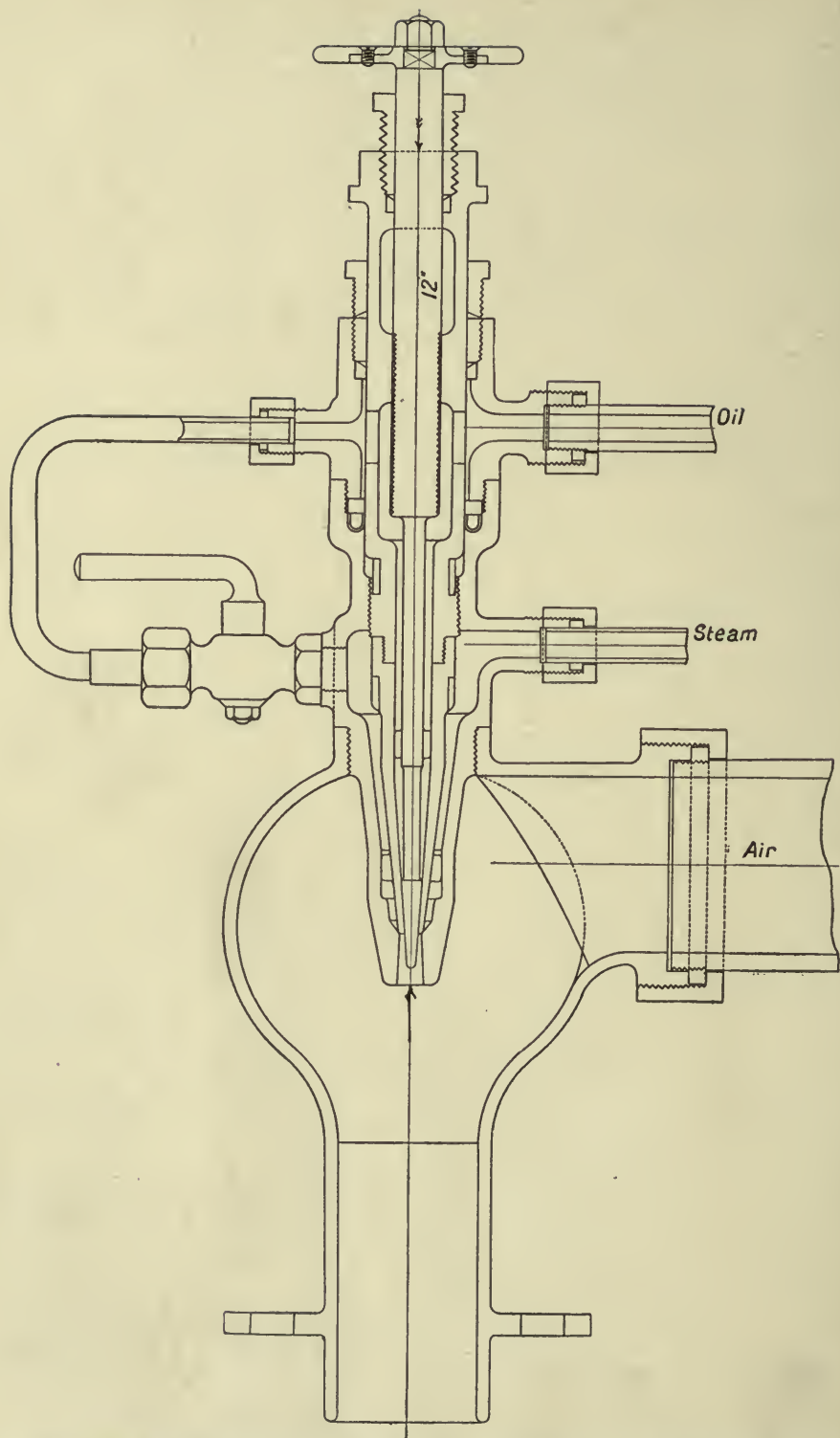

Fig. 15. ORDE AND SODEAU'S ATOMIZER, ARMSTRONG WHITWORTH & CO.

The Wallsend System of Oil Burning.

In the latest practice of the Wallsend Slipway and Engineering Co. the oil is injected into the furnaces (Fig. 17) under pressure by means of pumps, no steam being used in atomizing the oil, but only steam to drive the fuel pumps and to heat the oil in the heaters.

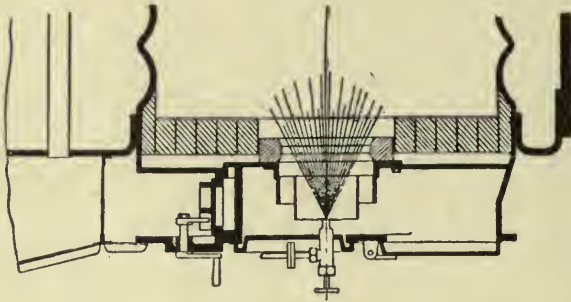

Fig. 17a. HAWDEN'S
FORCED DRAUGHT.

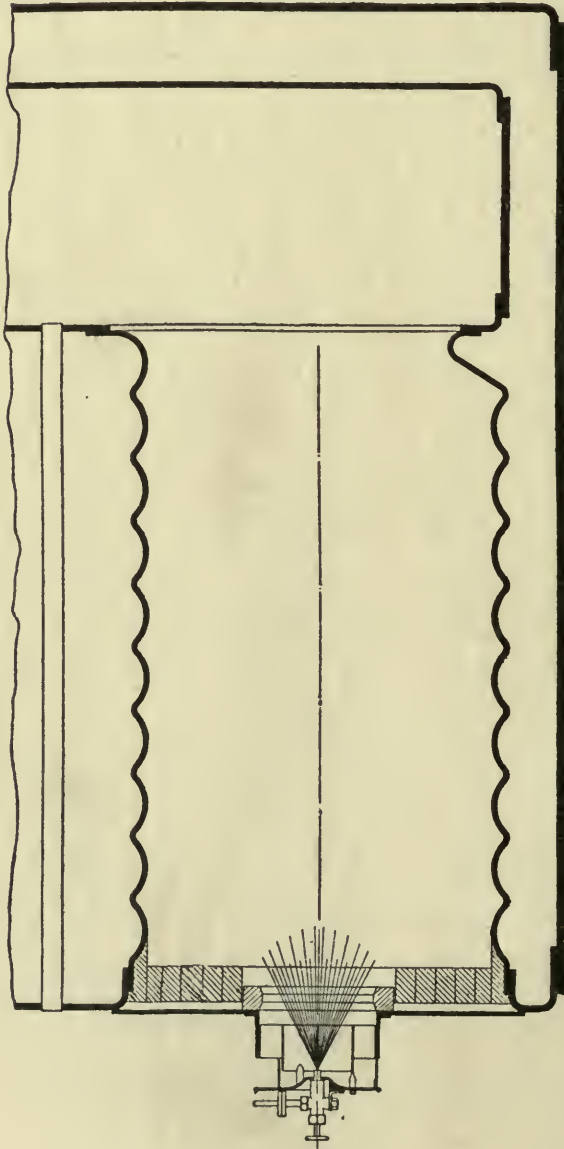

Fig. 17. FURNACES WITH WALLSEND OIL BURNING APPARATUS
NATURAL DRAUGHT.

After the steam has done its work it is delivered to the condenser and there is no loss of fresh water.

There are no air compressors or blowers required, the only working parts being the oil fuel pumps themselves, so that wear, tear and breakdowns are reduced to a minimum.

The liquid fuel is drawn from the storage tanks by duplex pumps. On its way to the pumps the oil passes through a duplex filter, arranged that each side can be cleaned whilst the other side is in use.

The liquid fuel is drawn from the storage tanks by duplex pumps. On its way to the pumps the oil passes through a duplex filter, arranged that each side can be cleaned whilst the other side is in use.

The pump delivers the oil first to a receiver of sufficient capacity to ensure its discharge to the burners under a steady pressure. From the receiver the oil passes through the main steam heater.

The temperature of the oil on leaving the heater is recorded and the oil then passes through a discharge duplex strainer of a similar design to the suction strainer and thence to the burners (Fig. 18), to which are fitted special air distributors. These consist of an inner and outer cylinder having vanes fitted between them.

These vanes are arranged specially and give a rotatory motion to the air and oil spray.

Two sets of nozzles are supplied to allow a wide range of power being developed by the boilers.

The air distributors are adjustable so that the amount of air entering the furnaces can be regulated to a nicety and complete combustion obtained.

Tests carried out on this system by Professor Barr on Messrs. J. Howden & Co.'s works boiler at Glasgow showed 16.22 lb. of water evaporated per lb. of oil burnt from and at 212°F.

As a result of Messrs. J. Howden & Co's experience with the system they have decided to fit the Wallsend System as shown in Fig. 17a in conjunction with their closed system of forced draught.

In this and Fig. 17 it will be noticed that there is now very little brickwork in the furnace of a marine boiler, and that the whole circumference of the furnaces is available as heating surface.

This is possible with the fine atomization and air mixture, combustion being well advanced before the conical spray reaches the furnace plates. When there are no firebars the whole of the furnace surface is efficient as heating surface and the lower part of the boiler is thus kept hotter than when the ashpit bottom is shielded by a grate. Each spray nozzle has its surrounding annular air passage with whirl vanes, and this keeps the outer trunk cool. A protecting face of brickwork is employed as shown.

The annexed table gives the results of the tests above referred to and made on Messrs. Howden's works boiler of 11 ft. diameter \times 11 ft. 6 in. long with two 39 inch furnaces and a total heating surface of 1,358 sq. ft. The steam was stated to be dry, or nearly so.¹

¹ The dryness was tested by calorimeter, but the author places no reliance on any known system of taking samples of steam out of a steam pipe. The sample passed to the calorimeter cannot be known to be accurate.

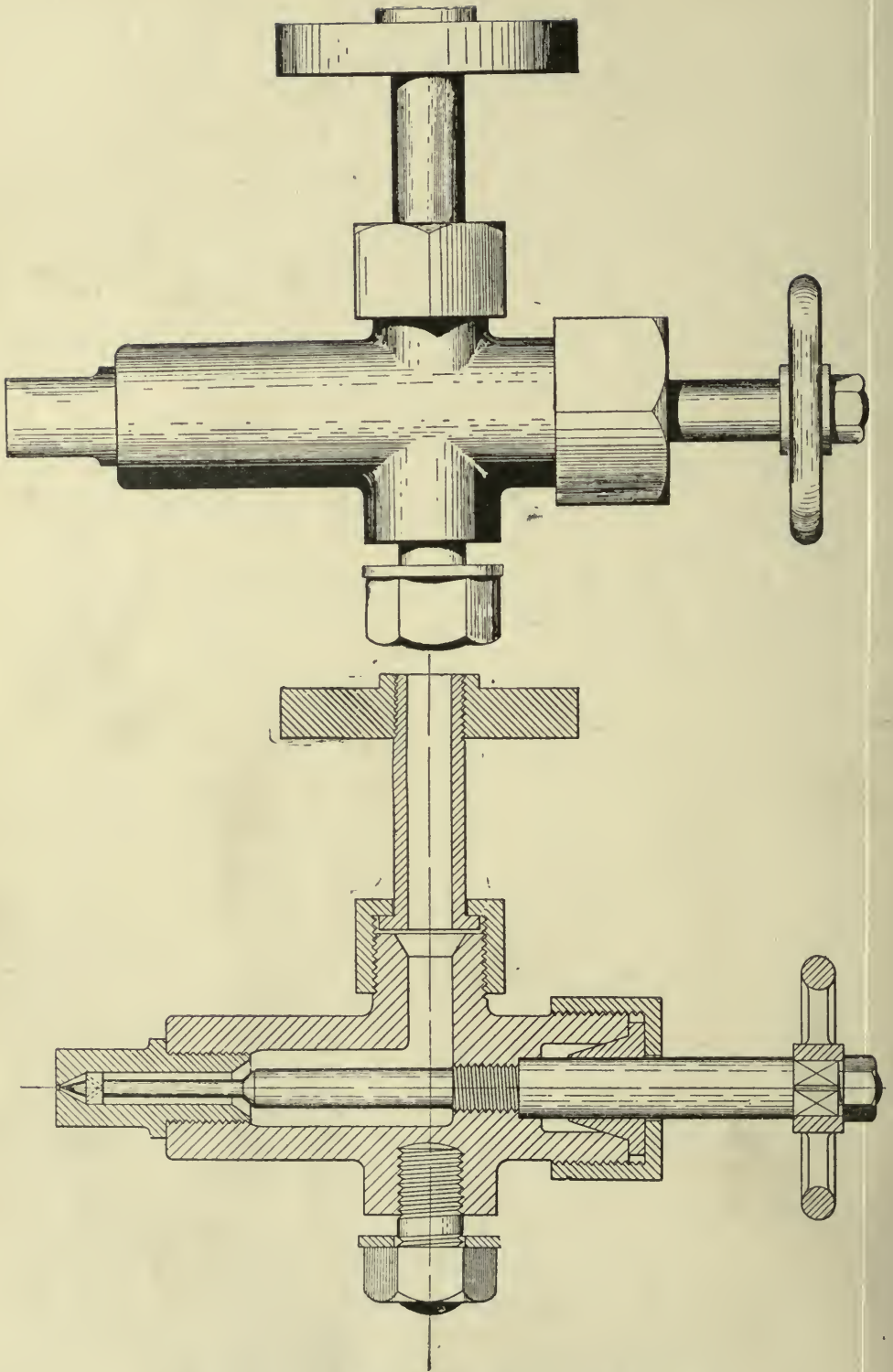

Fig. 18. THE WALLSEND PRESSURE BURNER.

It will be noted that the weight of oil per hour figures out at nearly 46 lb. per square foot of cross section of furnace in trial 1, and 31 lb. in trial 2 with lighter draught. Reckoned on the longitudinal section of the furnace as though each furnace had 20 sq. ft. of grate area, as it might have with grates, the fuel per square foot per hour works out at about 23 and 16 lb. respectively, or a heat production per square foot of "grate" of about the equal of 30 and 21 lb. of coal.

SUMMARY OF RESULTS OF TRIALS OF THE WALLSEND PATENT LIQUID FUEL BURNING SYSTEM WORKING WITH HOWDEN'S FORCED DRAUGHT.

Duration of trial . . . hours	3½	2
Number of burners per furnace .	One No. 18	One No. 16
Class of oil used . . . (Scotch)	Pumpherston	Pumpherston
Calorific value (nett) of the oil B.T.U.	18,770	18,770
Specific gravity of the oil at 60°F.	0·868	0·868
Steam pressure . lb. per sq. in.	155	155
Average temperature of feed waterdeg. F.	115	120
Pressure of air entering furnaces in. of water	2¼ in.	⅞ in.
Temperature of air entering fur- nacesdeg. F.	190°	185°
Description of smoke at chimney top	Very light to none	Very light to none
Temperature of gases at the foot of chimneydeg. F.	488°	420°
Weight of oil burned per hour lb.	932	633
Weight of oil burned per hour per burner lb.	466	316·5
Weight of water evaporated per hour lb.	13,050	9,000
Weight of water evaporated per lb. of oil burnt lb.	14·00	14·22
Equivalent evaporation from and at 212°F. lb.	15·91	16·22
Equivalent evaporation from and at 212°F. per sq. ft. of heating surface per hour lb.	10·92	7·55
Thermal efficiency of boiler . .	82·3%	83·9%

The arrangement of the Wallsend System to a marine boiler of Scotch type is given in Figs. 19, 19a, and the general arrangement for a water-tube boiler is given in Fig. 20.

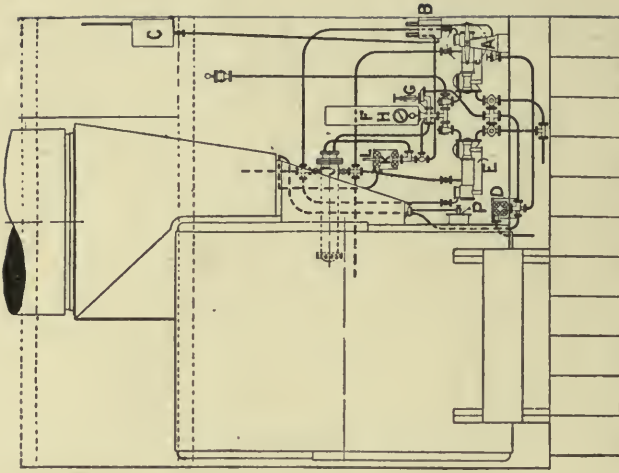

Fig. 19a.

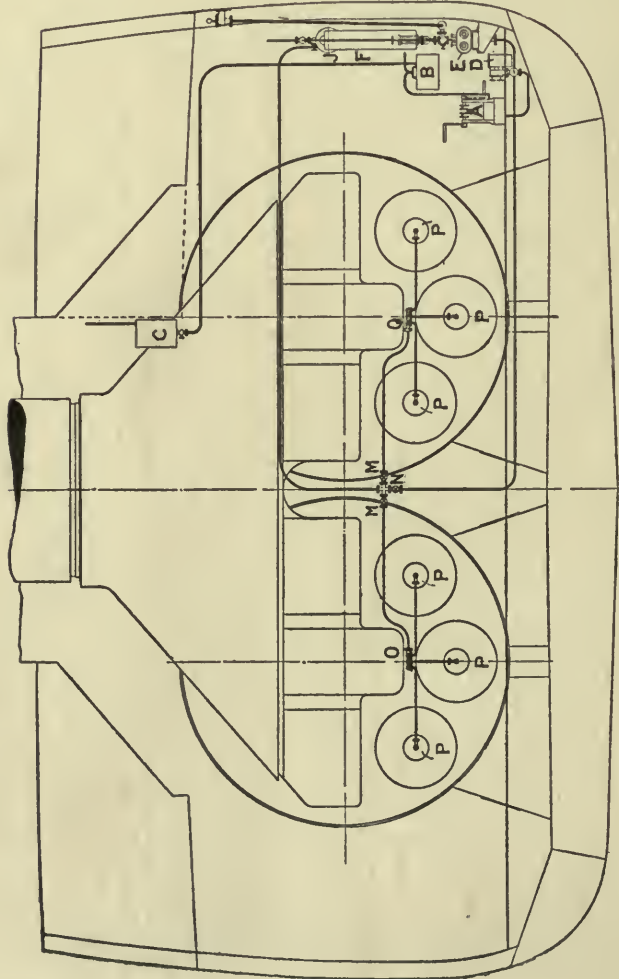

Fig. 19.

GENERAL ARRANGEMENT OF OIL BURNING SYSTEM. TWO MARINE BOILERS. THE WALLSEND SLIPWAY
AND ENGINEERING CO.

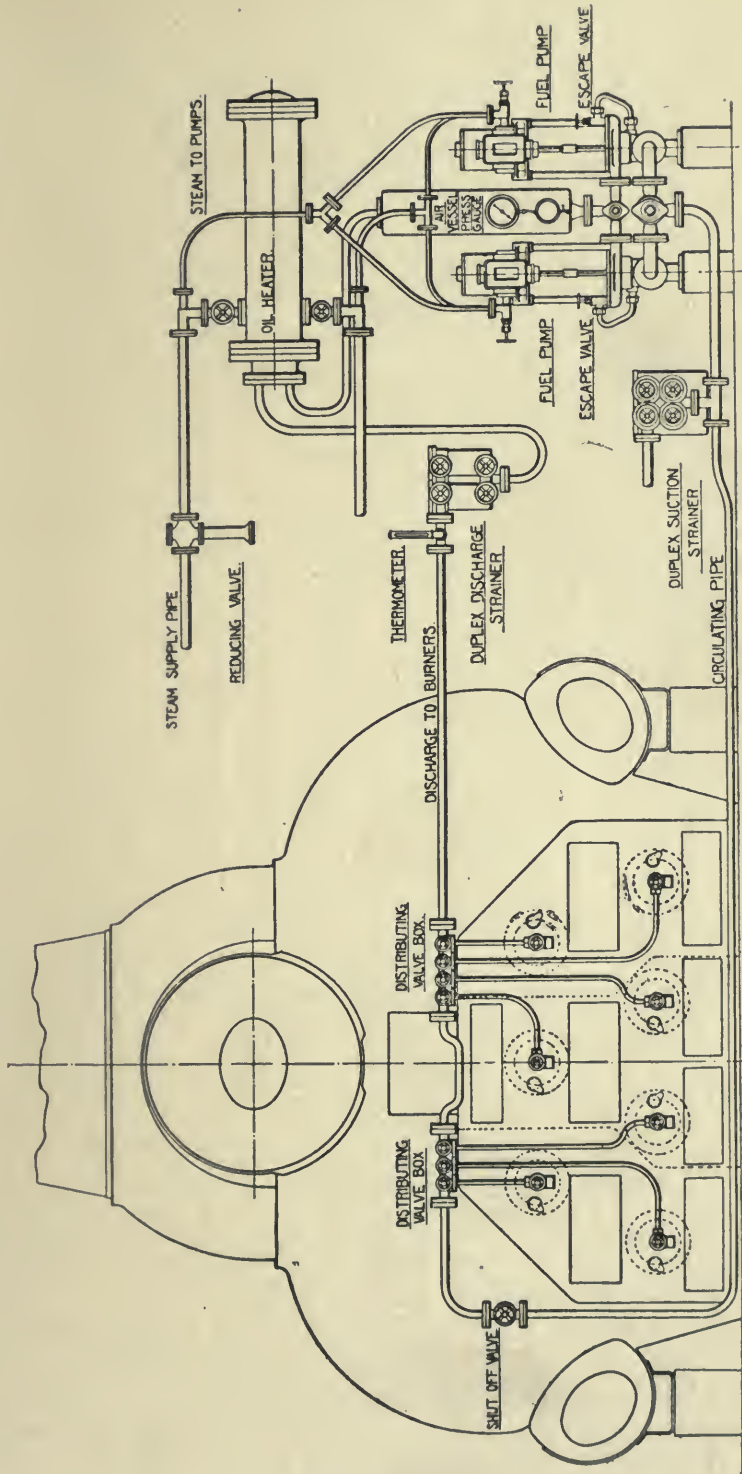

Fig. 20. WATER TUBE BOILER WITH WALLSEND OIL BURNING SYSTEM.

The Körting System.

In this system, as fitted to the Hamburg-American s.s. *F. C. Laeisz* several years ago, the water was first separated out of the oil which is raised by a pump, and heated to $60^{\circ}\text{C.} = 140^{\circ}\text{F.}$ by a heater on the suction pipe, and filtered before it reaches the pump valve, and thence delivered to a second heater, which raises its temperature to $90^{\circ}\text{C.} = 194^{\circ}\text{F.}$, and after a second filtration and under a pressure of thirty pounds per square inch, injected round a screwed needle, which causes the hot oil to spray itself. The bars are omitted, and the furnace lined in fire-brick and the air is admitted through adjustable perforated gratings.

The front of the oven is a disc of fire-brick with a small open-

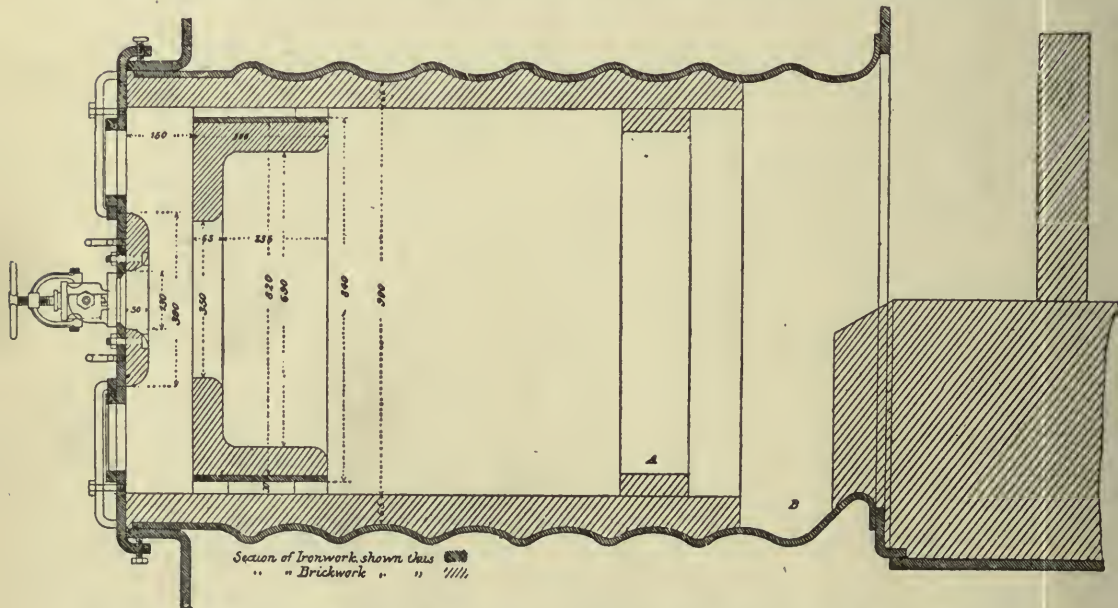

Fig. 21. FURNACE OF S.S. "F. C. LAEISZ," WITH BRICKWORK. KÖRTING SYSTEM.

ing through which the spray is delivered and air is admitted. In this system the oil is made to spray itself and is sufficiently atomized by the pressure and the action of the screwed needle round which it escapes.

The furnace of s.s. *F. C. Laeisz* is shown in Fig. 21 with the furnace lining and the brickwork of the combustion chamber also. In Fig. 22 the Körting sprayer is shown in section, with its spirally wound needle which throws the oil into rapid rotation and causes it to spread widely at the nozzle, exactly as in the case of the Körting water cooling sprayers. It was then considered essential to line the furnace in order to secure perfect combustion and insure that all the oil is vaporized before it

reaches the chilling zone of unprotected water cooled plates, but later practice by the Wallsend Co. appears to have succeeded in securing combustion without smoke in an unlined furnace as in Fig. 17.

The diameter of the jet orifice is 1 to 3 mm., and in later forms there is a crown or disc set round the nozzle and pierced with holes of 1.25 mm. diameter,

through which air is intrained. The output under a pressure of six kilos=84.4 pounds, was as follows when tried at Cherbourg—

Orifice	1 mm.	1 mm. 25	1 mm. 5
Oil per hour	65 k.	100 k.	135 k.
	143 lb.	220 lb.	297 lb.

Tried on the locomotives of the Vladi-Kavkaz Railway these atomizers with double jets sprayed 230 kilos = 506 lb. per hour under a pressure of only 4.2 k. = 59.8 lb. From the

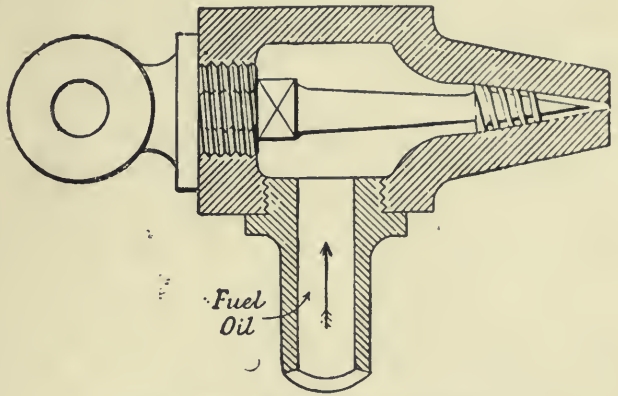

Fig. 22. KÖRTING ATOMIZER.

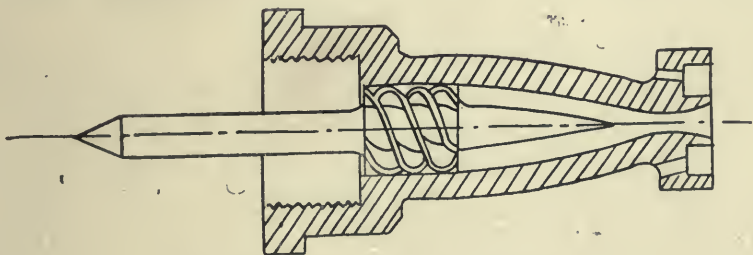

Fig. 22a. KÖRTING ATOMIZER.

trials made by the French Navy it appears that these mechanical atomizers work very regularly and, moreover, silently, if the oil is first filtered and heated to 80°C. = 176°F. They are recommended for getting up steam, the force pump being hand worked until such time as steam is produced sufficiently to work the pulverisers.

M. Bertin lays stress on the benefit of supplying oil to a burner at a considerable pressure and at a high velocity, for even with air or steam atomizers the fine jet will atomize more easily, for an oil pressure of three kilos, for example, permits of a velocity four times as much as is given by a head of 2 metres.

CHAPTER IX

LIQUID FUEL APPLICATIONS TO LOCOMOTIVE BOILERS

The Holden System.

IN this system, the first to come into extensive use in Great Britain, the object has been to combine liquid and solid fuels so that either or both can be used indifferently without a moment's notice of the change.

Mr. Holden, of the Great Eastern Railway of England, primarily devised his system for getting rid of the tars produced by oil gas apparatus ; but he has used many liquids for fuel, including coal tar, blast furnace tar and oil, shale oil, creosote and green oils, astatki and crude petroleum. Locomotives thus fitted are clean to work, make no dust, smoke or sparks, have little wear of tubes or fire-boxes and have little ash and clinker to remove. Steam can be raised rapidly, adjusted at an even pressure, and waste at the safety valve is prevented. Any boiler can be fitted for liquid fuel without alteration of furnace, though it is desirable to add a fire-brick lining on the tube plate below the arch.

The fire is made up thin with coal and about 120 pounds of broken fire-brick. The ashpit damper is kept sufficiently open to maintain the fire bright.

There is nothing striking to be seen from the footplate, with the exception of an extra fitting on the fire-box casing, carrying four steam cocks and two small wheel valves about the fire-door level on each side thereof.

A hinged plate appears under the fire door, and on lifting this there are visible two holes, through the fire-box outer casing, leading into the firebox, and equidistant on each side of the centre line 21 inches apart ; they are 5 inches diameter and 10 inches above the grate surface. In each hole is a ring of pipe perforated on the front side so as to direct numerous jets of steam forward into the fire-box. In the latest atomizers this ring is not employed, the nozzle of the atomizer being enclosed in a box perforated on the face with several holes through which

the spray jets issue at converging angles. These cause an induced current of air. In the centre of each of the rings is the nozzle of an injector. These are steam worked and inject oil into the fire-box, mixed with air, which enters at the rear of the injectors by an india-rubber hose connexion from the vacuum brake if this is used.

The steam inlet to each injector is on the inside, steam coming by a single pipe, which branches off by square turns right and left to the injectors. Oil enters by separate pipes worked by two independent regulating wheel valves, which stand above the footplate at the fire door level. Each valve is thus independently adjustable, but both can be worked together, instantly to open and close, if necessary, at stations and other stops. Otherwise the oil apparatus is controlled from the four cocks mentioned above. One turns steam on to the injector supply; another, by right and left branch pipes, turns steam to the air injecting rings; and a third admits steam into a warming coil in the oil tank for the purpose of bringing the oil to a state sufficiently liquid to flow freely, and to be sprayed sufficiently fine. The fourth serves to blow back steam through the oil fuel pipes to the tank to clear any obstruction or to blow back oil which has cooled in the pipe or to warm the pipe, and to blow through the oil passages of the injectors.

The mode of working is as follows: the engine comes up from the shed with the light coal fire with which steam has been made. It is clear and red, the fire-brick arch well heated, and the fire made up with brick lumps as usual. When desired to burn oil, steam is first set blowing through the injector. The delivery of the injectors is directly forwards and sideways, the nozzle having two orifices. No oil is sent against the fire-box sides, but only towards the brick arch and towards the middle of the box, the two inclined jets approaching each other. After the steam is turned on, the oil admission valves are slowly opened and the oil is sprayed and ignites at once, the whole firebox being filled with a dazzling white flame.

There is now smoke at the funnel from insufficient air supply. This is instantly checked by turning steam into the ring jets which draw in a further large quantity of air through the five inch openings, and smoke can be reduced to any extent down to nil. This is a specially valuable feature in economy, for, while it is so desirable to prevent smoke, it is equally undesirable to admit too much air, and this can be regulated to a nicety, merely enough air to stop the smoke being injected, or even only enough to reduce the smoke to an occasional suspicion of it. There need be no waste due to excess of air.

The light coalfire is kept going by an occasional shovel of coal.

Though the apparatus is simple, if it were possible for it to be put out of order in the middle of a trip, the fireman would commence to shovel coal upon the existing bed of fire, and the engine would run as an ordinary coal burner without a hitch or stoppage.

On a trip, if steam is high, the injectors can be instantly stopped on arriving at a station, or, if the steam is low, continued at full blast as when running, and the fire kept up to a maximum efficiency, and steam got up during the wait. There is less dependence on the blast pipe, and a variable blast nozzle is used, the simple movement of a lever in the cab swinging a hinged cap over the pipe top and reducing the nozzle from $5\frac{1}{4}$ to $4\frac{3}{4}$ inches diameter for coal burning.

Should any oil travel unburned so far as the brick arch, and even run down it, it cannot travel over the firebrick protection of the lower tube plate without vaporization and combustion, hence this protection, which is the one slight difference from common practice, a difference, however, of no importance or injury to the engine's coal burning properties.

There is no projection of any oil upon the fire-box sides, neither is there local intense combustion to produce local plate wasting. On the contrary, the whole interior of the fire-box is filled with flame, and no special ignition point, or rather, combustion area, is apparent. Heating is therefore general, and temperature even.

Though nominally a pound of oil has not the steam making power of two pounds of coal, nor perhaps could it be shown to have on a prolonged test; yet in practice, one pound of oil is found to be equal to double the quantity of coal, owing to the facility of regulation and the saving at the safety valve and of the back pressure from reduced blast pipe resistance. Oil has the advantage of cleanliness and reduced labour all round, for it makes no unconsumable refuse, requires no stoking beyond the keeping up of the small bed of coal fire, which seems to be a good system where liquid fuel supplies are doubtful in quantity and uncertain in price, over any system of oil burning which rejects coal entirely.

In the ordinary work of the Great Eastern Railway the run between London and Cambridge—about 56 miles—was made with one firebox full of coal made up ready for the run and untouched. This brought the train to its destination, and if it were known that the engine would be shedded at once the steam might be pretty well reduced and the fire left to finish

nearly dead. Here came in the advantage of liquid fuel. Even if steam was down and the fire nearly out, the turning of a handle or two would put the engine in readiness to take out any train in five minutes after notice, and thus an engine may be worked to the economy it would be if about to be shedded, and yet be ready for a full-power run almost instantly.

For lighting up, however, the fire started in a clear grate, as usual, and the month's average of fuel, including lighting up, was 12.2 pounds of oil per mile and 11 pounds of coal, or a total of 23.2 pounds of fuel. Nine other engines of the same class and the same range of duties averaged 34 pounds of coal per mile for the same month. Thus one pound of oil was practically equivalent to two pounds of coal.

Mr. Holden states that for oil burning to be a success, the apparatus must be independent of any firebox alterations, or of anything which would prevent instant return to coal or solid fuel, or its use in lighting up. Hence his special injector to spray the oil without the use of special brickwork, hitherto common as a means of giving an extended hot surface. The several small ring jets which converge on the jet of oil, both spread and mix it with air and diffuse the flame, so preventing local heating.

The injector, of gun metal, is clearly shown in section in Fig. 23. Oil enters at the side some way back of the steam nozzle and outside this. Steam, therefore, comes inside a thin ring of oil at the mixing nozzle and through the inner tube comes the vacuum brake air which, expanding as it becomes heated, still further aids the breaking up of the oil into spray. The ring jets of steam induce a further supply of air on the exterior of all, and so is obtained an alternation of air, oil and air, which promotes admixture and thorough combustion. The inside of the injector is removable and can be replaced with a spare set in a few minutes when running. Removal of the brake hose connexion allows the injector nozzle to be cleared by a wire while actually at work, this being the main reason of the through passage which has been utilized—also for the purposes of the vacuum brake. The latest atomizer is that of Fig. 24 (1911). Compared with Fig. 23 and 25 it shows how comparatively little change has been made in the last nine years. The new pattern is found to use less steam. The ring jets of this pattern (Fig. 25) seemed to use a good deal of steam.

In the newest pattern (Fig. 24) there is a small box end enclosing the nozzle, and the flat end of the box has seven perforations inclined to each other so as to give a converging jet. The

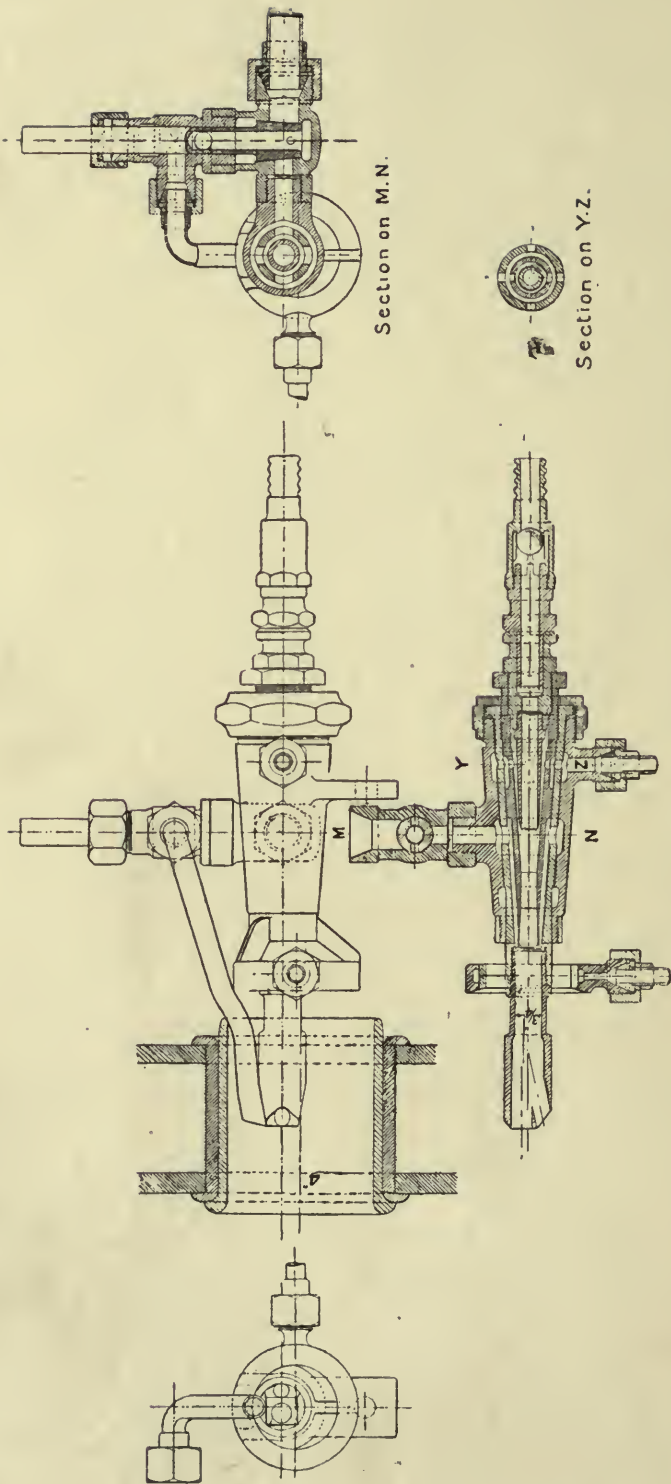

Fig. 23. HOLDEN'S ATOMIZER (1900.)

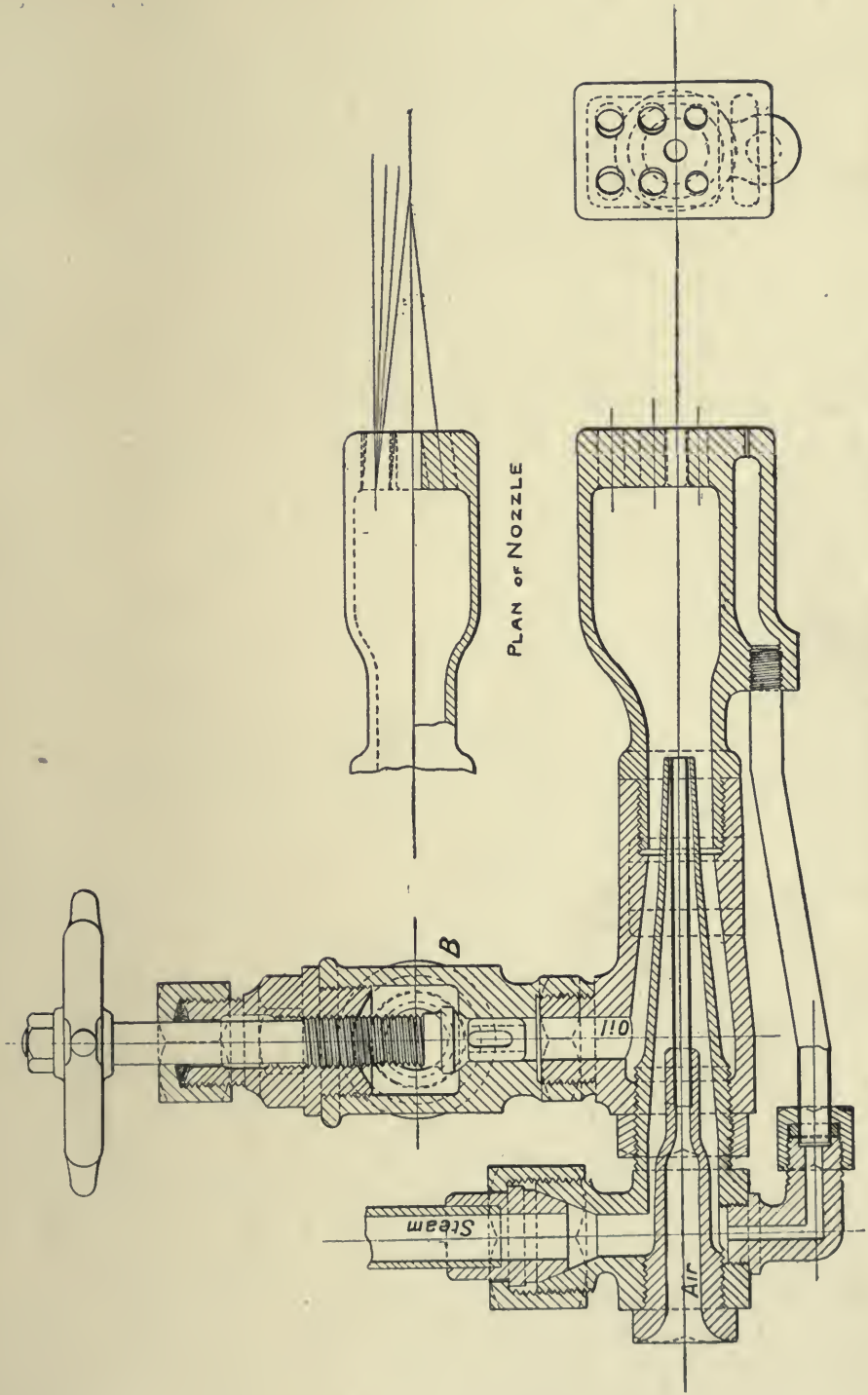

Fig. 24. HOLDEN'S LIQUID FUEL INJECTOR, D PATTERN, 1911.

oil, air and steam are mixed in the box and issue together. Small supplementary steam jets issue from small holes as shown at the base of the nozzle box.

The brackets of the oil regulating valves are movable vertically. The two brackets are connected to a hand wheel common to both, and dropped by a single movement of the wheel, thus shutting off both oil valves and putting them again in action without varying their individual adjustment. Later arrangements differ somewhat, the combined motion being given by a lever, as in Fig. 26.

This lever is used for the station stoppages, after which each injector can be set going again exactly as before the stop, so dispensing with fresh regulation.

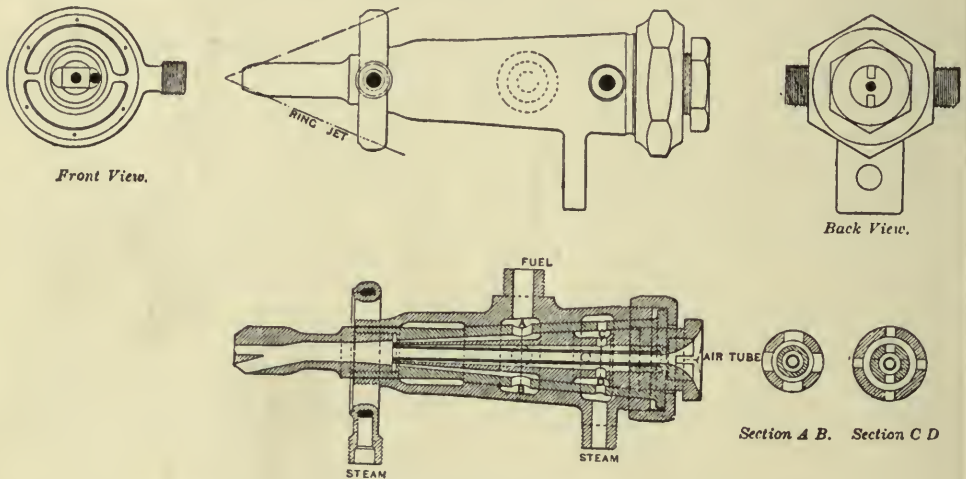
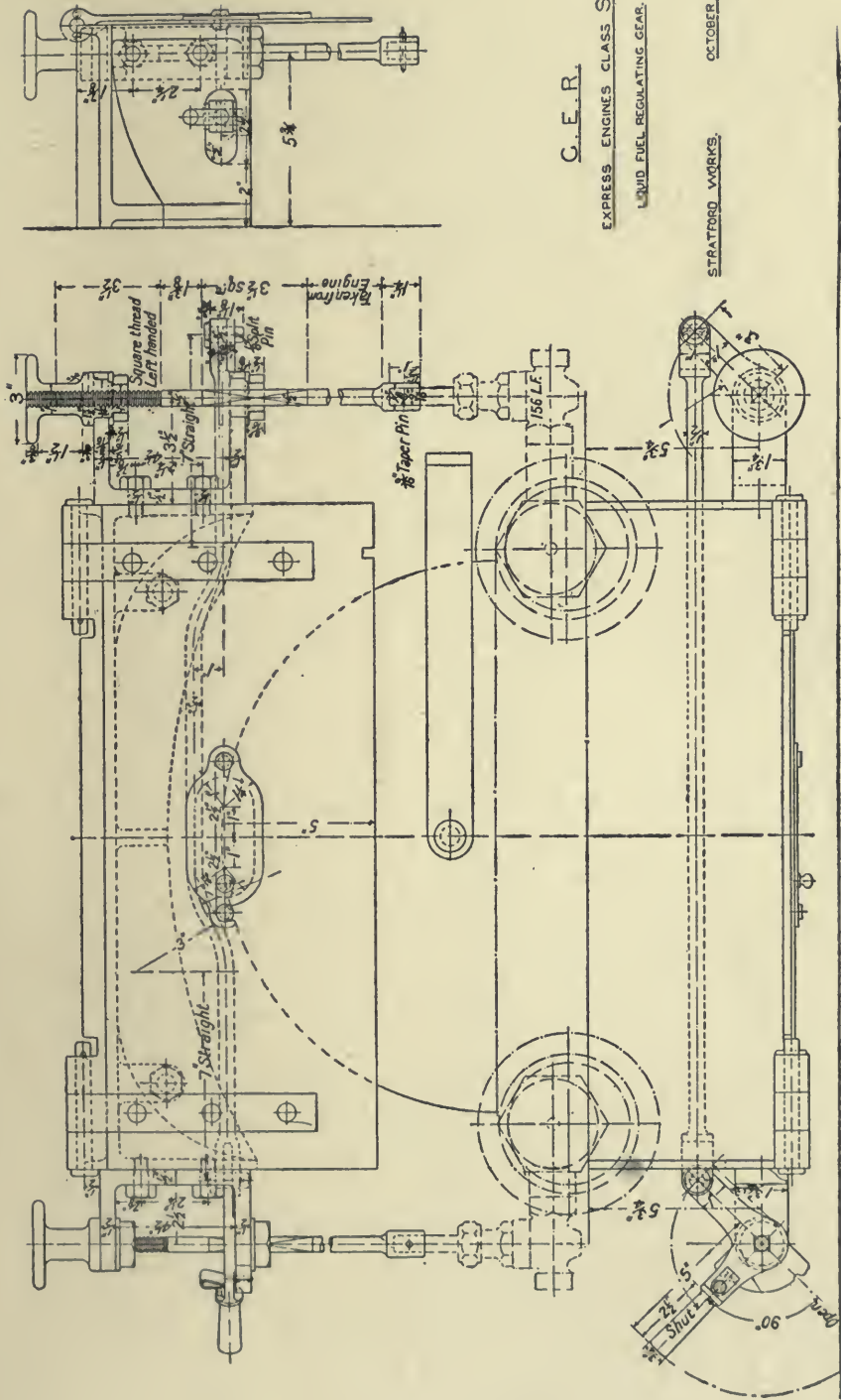

Fig. 25. ATOMIZER. OLD FORM, HOLDEN SYSTEM.

In locomotive work, the absence of a bed of incandescent fuel on the grate is a cause of very serious temperature range in the firebox when the oil is shut off at stops. Where a solid fire is maintained on the combined system, there is always an incandescent fire to prevent undue cooling when the oil is stopped, and this is a valuable feature apart from the question of lighting up in the ordinary way and the power of using solid fuel if necessary at any time so to do.

Fig. 24 is the latest form of atomizer.

The valve *B* used for regulating the flow of the oil fuel is of special construction, found desirable after many attempts with different forms of cocks and valves. To pass regular quantities of thick viscous fluid through the "crooked passage" formed by the half open plug of a common cock is impossible, and some form of "Straightway" valve is necessary. In the



C. E. R.

EXPRESS ENGINES CLASS S. 46

LIQUID FUEL REGULATING GEAR.

STRATFORD WORKS.

OCTOBER 3 1899.

Fig. 26. OIL FEED REGULATING GEAR, HOLDEN'S SYSTEM.

example, a small reservoir of oil is formed by the body of the valve, and a tube with a slit in it is moved up and down inside. The proportion of cut exposed in the oil reservoir regulates the supply. With this valve very fine adjustments in the flow of oil are possible.

The Holden apparatus is now largely used on stationary, locomotive and marine boilers, but its application on English railway work has been reduced by the comparative scarcity of oil since the demands of the Navy have absorbed so much. In short, liquid fuel is not yet produced to supply the demand.

In Fig. 27 is shown the firebox, about 8 feet long, of an American locomotive. The tube plate and sides are lined with brick, and there are two air inlets at the bottom of the box opening into the ash pit, which has the usual front and back dampers. In these narrow boxes there is only room for one atomizer. Oil alone is intended to be used in this furnace, and the area of brickwork is necessarily larger than in the mixed system, where the bars are covered with more or less self-incandescent fuel. The fire-brick arch, but slowly adopted in American coal burning engines, is of necessity a part of the oil burning furnace. In some locomotives there is also a small arch over the atomizer to protect the fire door. In certain locomotives with still longer boxes there will be a wall of brick about 6 feet in front of the atomizer, and the arch springs from this wall, so that there is a combustion space between the wall and the tube plate.

With Texas oil the Great Eastern locomotives, class 1900, have hauled fast trains on a consumption of 24.7 pounds of coal tar per mile plus 9.6 pound of coal for lighting up, etc., as against 40 to 45 pounds of coal. On a test run with a train of 620 tons a four-coupled passenger engine consumed 31 pounds of Texas oil per mile. These engines were fitted with air heating arrangements. On the Japanese Government railways, Borneo oil on the Holden system showed an evaporation as high as 14.42 and averaged 12.6 the year round as against 6.4 pounds for coal.

An important item is the lengthened life of the internal fire-box. After some service the sides of an ordinary firebox present a series of convex surfaces between the stays, which are subjected to abrasion by the small ashes, sparks, etc., drawn from the fire by the action of the blast. As a result of this wearing away of the surface of the plate, it gradually becomes thinned, and eventually cracks develop between the stay holes, with the consequence that the box must be patched or renewed after a comparatively short existence. With oil

fired engines an extension of time of some 50 per cent. can be secured, as no such destructive action exists. These remarks on abrasion apply equally to the tubes, smoke box, chimney, etc., and the economies in this direction are of considerable value when large numbers of locomotives are affected.

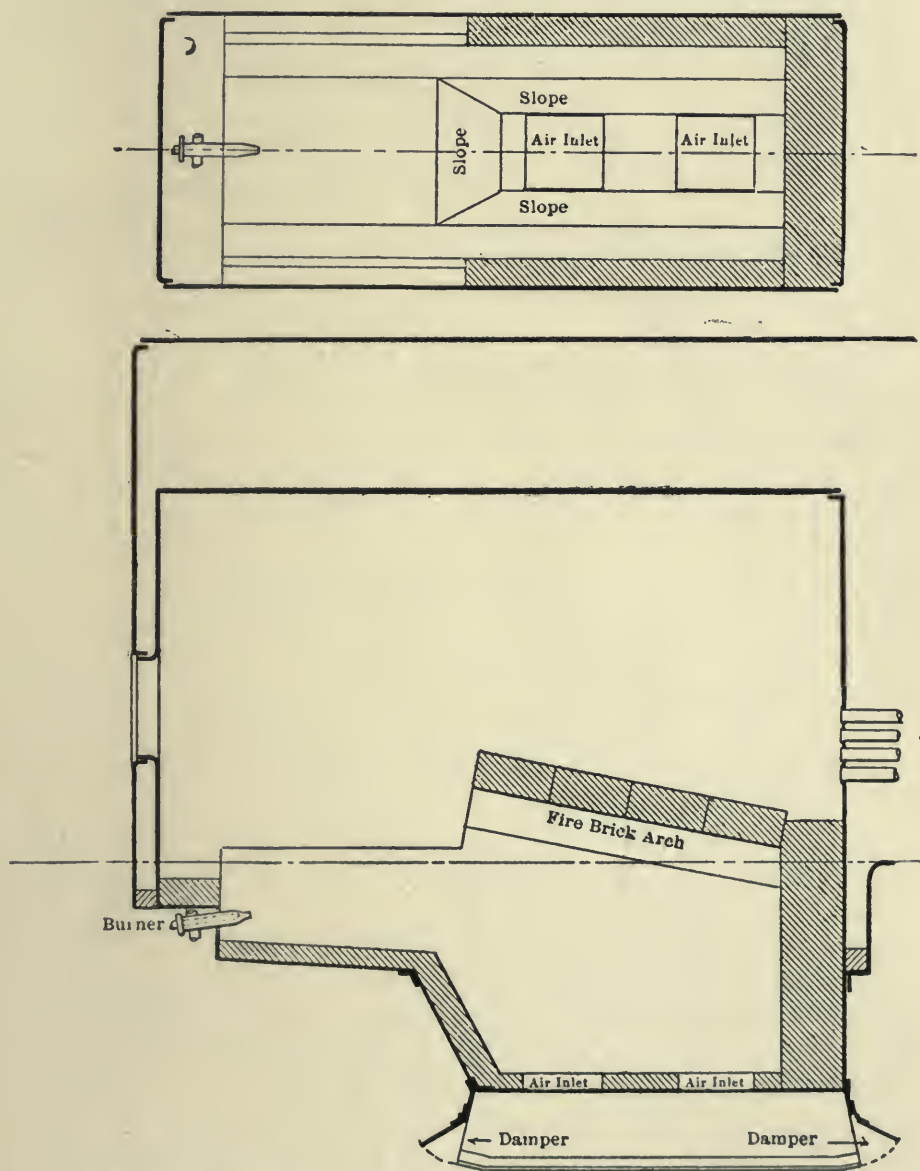

Fig. 27. FIREBOX OF AMERICAN OIL-BURNING LOCOMOTIVE.

With oil burners the fire is of equal intensity, and as clean at the end of the day as at the start, and an engine can be run indefinitely as regards the fire.

The average life of copper fire-boxes of five G.E. Rly. engines,

No. 754 to 758, with coal, was found to be $5\frac{1}{2}$ years, and that of two other sister engines, No. 760 and 765, using liquid fuel, was respectively 8 years 4 months and 8 years.

In fitting these burners to ordinary stationary boilers they are connected by means of pipes to a hinged joint or trunnion so arranged that when the burner is swung out of position, the supplies of steam and oil are cut off, so as to prevent the risk of fires in the stokehold.

Where, as often the case, oil contains water in such quantities as to extinguish the fires there is considerable danger. The oil following after is—if the furnace temperature is sufficiently high—violently exploded, or, if the furnace is allowed to become too cold, the oil falls through the ashpits and on to the stokehold floor, where it spreads out into a thin film probably at a temperature approaching the flash point, and therefore in a highly inflammable state.

The specific gravity of most fuel oils being 0.86 to 1 the rate of settling at low temperatures is very slow, but the difference in the specific gravity becomes much more marked if the temperature is raised, and very usual practice has been to heat up the whole contents of the oil bunker to such a temperature as, without approaching the flash point of the oil, will make the density difference sufficient to accelerate the settling.

The objection to this is that a large amount of heat is required, the radiation surface of a bunker of any size being considerable; the heating process is slow, and unless completed before any of the contents are drawn off, the lower layers of the tank will consist either of pure water or oil with a large percentage of water mixed up with it.

To obviate this, a floating suction is used consisting of a long pipe pivoted upon the side of the bunker or tank, and guided in the vertical plane by means of a tee or angle iron set to correct radius.

The suction pipe has a small steam-pipe led along its side, which terminates in a coil immediately below the suction opening. The steam passes through this and heats the oil immediately below the orifice, and this oil rises into the pipe and leaves the water behind. The float is proportioned and arranged to keep the mouth of the pipe about 6 inches below the level of the oil in the tank.

This apparatus is certain in action and requires but little heat, since this is only applied to that portion of the oil immediately under the mouth of the suction pipe, and there is little radiation from the bunker side, and the heated oil at once moves off to be used while still hot.

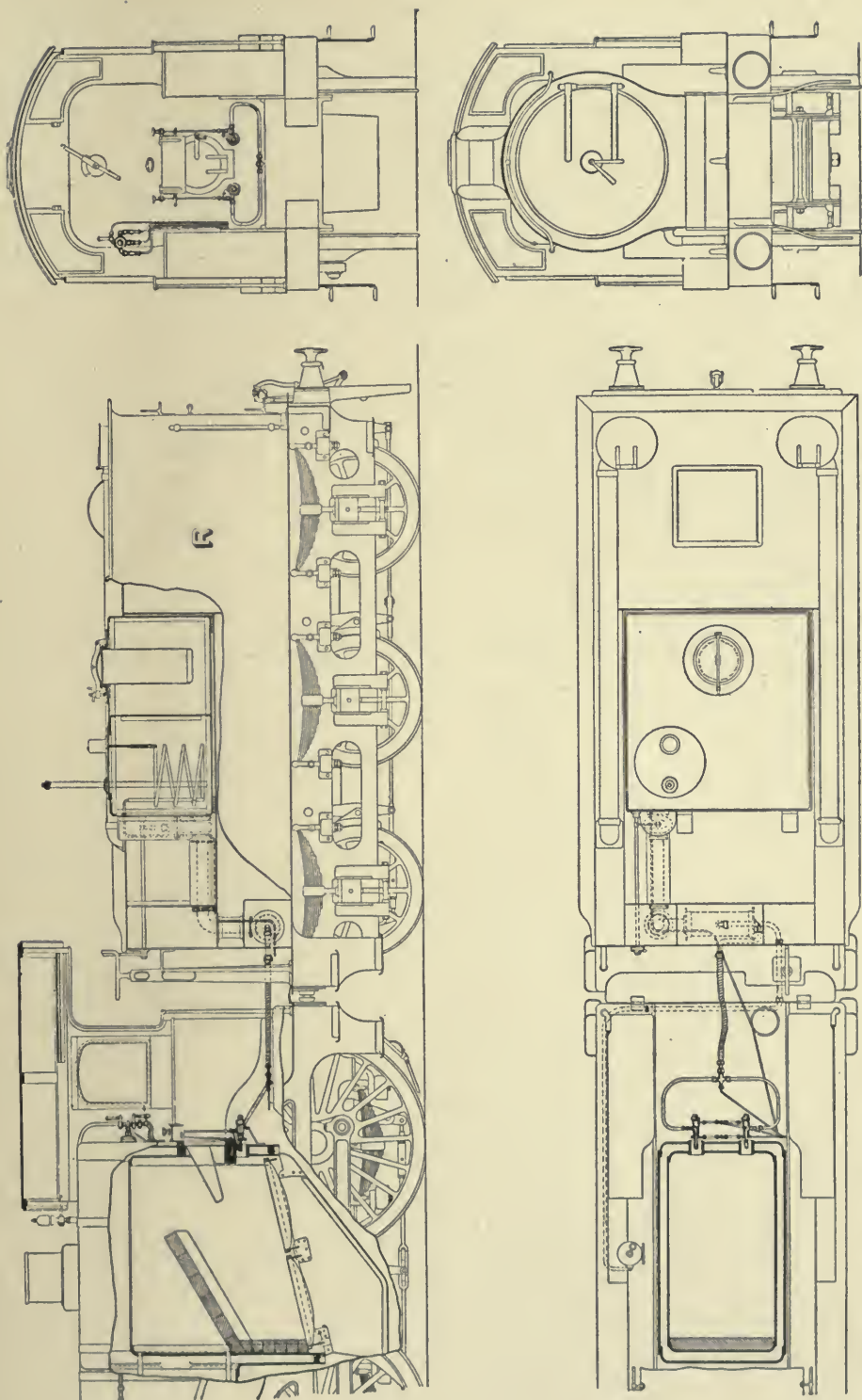

Fig. 28. LIQUID FUEL APPARATUS ON 4-COUPLED GREAT EASTERN RLY. CO.'S LOCOMOTIVE. HOLDEN'S SYSTEM.

Fig. 28 shows the application to a locomotive with fire-box 3 feet $4\frac{1}{4}$ inches wide. For a smaller fire-box one atomizer only is necessary.

The apertures in the fire-box are made by screwing a copper ferrule into the tapped plate and beading over at the ends; into this is drifted a wrought iron ferrule, which makes a perfectly tight joint.

The nozzle of the atomizer is placed about $\frac{1}{2}$ in. above the centre of the aperture, and the face of the ring $\frac{3}{4}$ inches from the front of same.

When liquid fuel is used alone, steam is first raised in the boiler by a wood and a coal fire to 25 pounds or 30 pounds pressure, the fire is levelled and covered with a layer of broken fire-brick of not more than 3 inches cube, spread thinnest about the centre of the fire-box, and well packed round the sides and corners. A few pieces of waste or wood are thrown in to cause a flame before the fuel is introduced.

An air heater formerly was used, but has been abandoned in recent practice.

The regulating gear is so arranged that a simple movement of the lever closes both oil valves without affecting their separate adjustment when open.

CHAPTER X

LIQUID FUEL APPLICATION TO STATIONARY AND OTHER BOILERS

The Lancashire Boiler.

FIG. 29 shows the arrangement of Holden's Burners on a Lancashire type boiler. The burners are placed at the front of the brick lined extensions, to which heated air is conveyed from large tubes passing down the outer flues. The fire-brick construction is simple and easily introduced for an ordinary sized boiler with a grate of, say, 7 feet long. A striking bridge pillar with inclined face is built up about 2 feet 6 inches inside the furnace; next, a screen with large clear opening about 1 foot 6 inches behind the former; and finally, a second screen with oblique perforations to direct the gases along the inner surface of the flue. The central portion of this last screen is recommended to be built solid. On boilers thus arranged, with fair working conditions, an evaporation of from 14 to 15 pounds of water per pound of Texas fuel oil (from and at 212°F.) is readily obtained.

On a large boiler of this type burning north country "small" and evaporating only 6.5 pounds of water per pound of coal, the Texas fuel oil has secured an evaporation of 15.25 pounds of water per pound of fuel.

If desired the fire bars are left in and covered by a layer of fire-brick or chalk as a base for the fire in case it may be necessary to return to solid fuel at any time. Any internally fired boiler may be treated by either method. Where the bars are left in there ought to be a damper fitted to the opening of the ash-pit to regulate the admission of air.

In these furnaces the injector is placed about 8 or 10 inches above the grate surface and about $\frac{1}{2}$ inch above the centre of the 4-inch opening cut through the furnace door. The injector is inclined so as to point to the second or third brick from the top of the bridge. Dry steam, preferably superheated, is admitted.

Generally, in the firing of internal furnace boilers, the fuel is blown in parallel with the grate surface and 8 to 10 inches

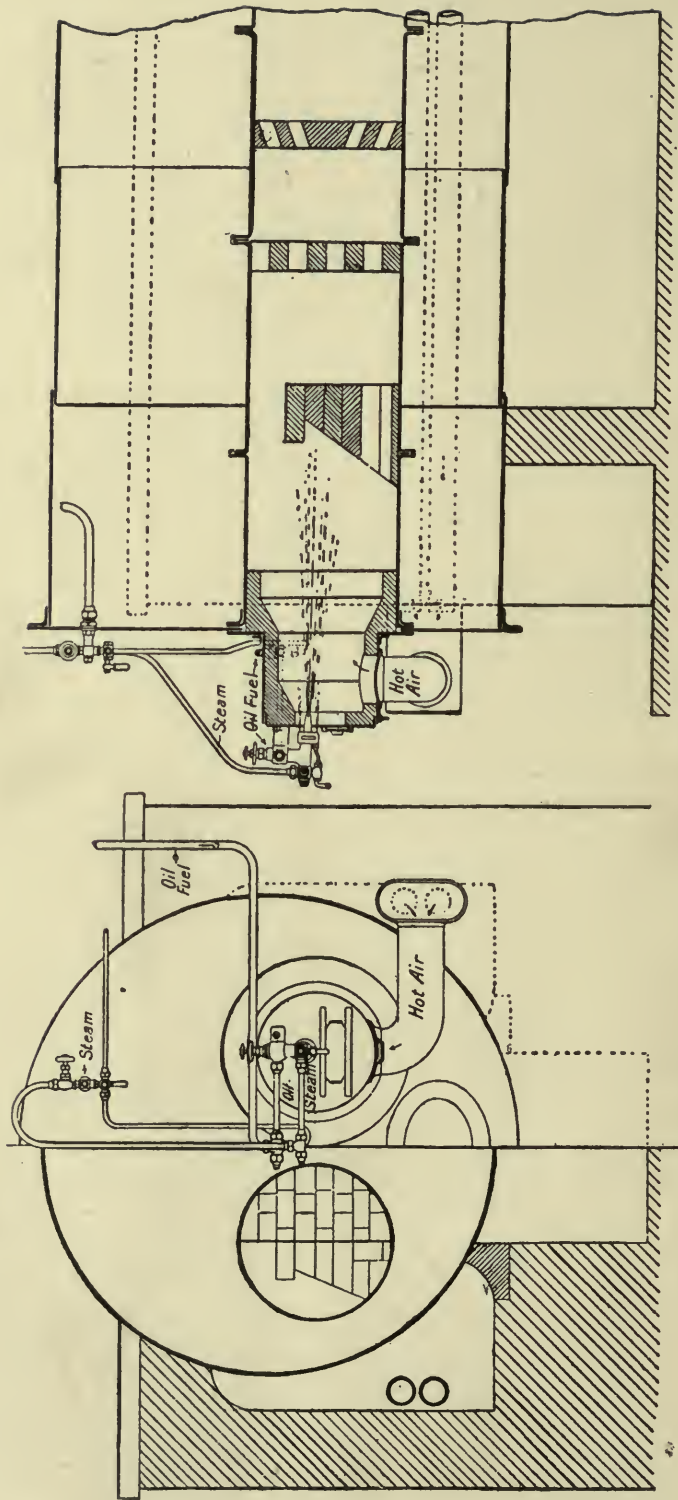

Fig. 29. LANCASHIRE BOILER WITHOUT GRATE. FURNACE WITH HOLDEN'S ATOMIZER.

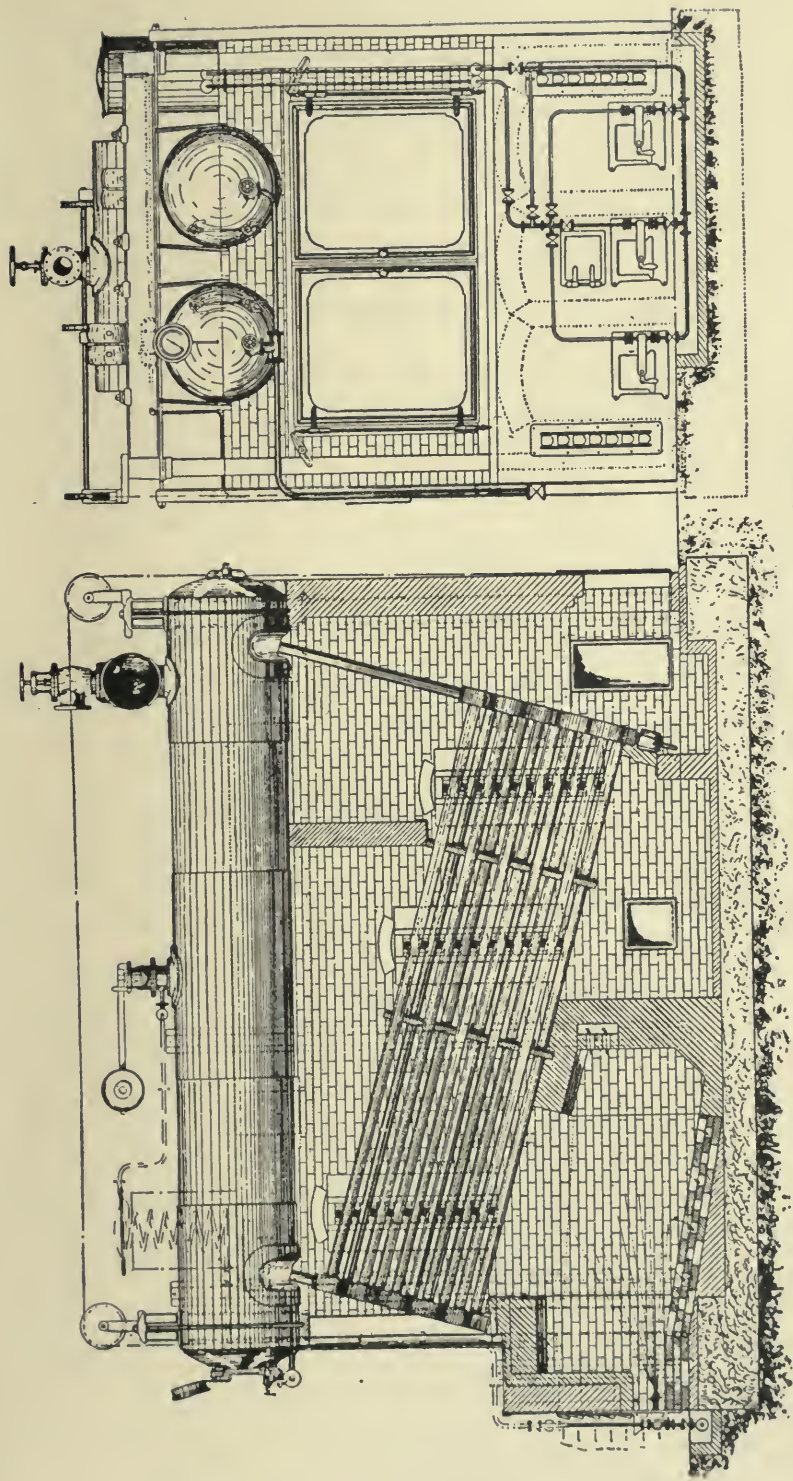

Fig. 30. WATER TUBE BOILER WITHOUT GRATE.

above it. In the large vertical boiler the atomizer is usually placed below the fire-door opening, but in small vertical boilers it must be placed through the door. In either case the opposite half circle of the furnace must be lined with fire-brick to the height of about half the furnace diameter to form the necessary incandescent surface on which any unburned oil can strike.

The Water Tube Boiler.

For the water tube boiler without grate bars the arrangement of Fig. 30 is employed, there being an additional arch of fire-brick brought forward from the bridge to prevent too early a passage of the gases among the tubes. The author would extend this (and also the first arch) further than shown in Fig. 30, it being impossible either with coal or oil to secure smokeless

results where the hydrocarbon gases pass too quickly among cold tubes. Nor is there space and time for such complete combustion as is desirable.

The steam blast may be made less intense when oil fuel is used by the MacAllan movable cap (Fig. 31). This is folded over the blast pipe orifice, which it reduces from $5\frac{1}{4}$ to $4\frac{3}{4}$ inches diameter.

The position of the atomizer is important. If too high the combustion is vibratory, and an intolerable

humming sound is produced by the many rapid explosions due to non-continuous combustion. The oil fire must be along the plane of the coal fire for the best results, and not too high above it.

Owing to its large proportion of hydrogen, the production of carbon dioxide is less, and this is held to be an advantage of liquid fuel for working tunnels, and the Arlberg tunnel was so worked by 32 engines. It must not, however, be overlooked that hydrogen destroys three times as much oxygen as is destroyed by a pound of carbon, and produces but little more calorific effect per pound of oxygen consumed, so that it is equally destructive of the vital properties of the air and introduces an excess of nitrogen in place of an excess of carbon dioxide. The physiological effect of the carbon dioxide is less to be feared than the absence of oxygen which it implies. Too much, therefore, should not be made of this supposed advantage of liquid fuel, the danger being due to the absence of

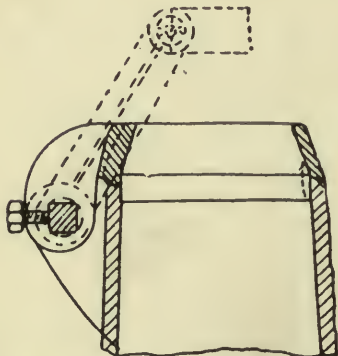

Fig. 31. MACALLAN VARIABLE BLAST CAP.

oxygen. The Arlberg tunnel is now electrically worked. No very large installations have been made lately, owing to the difficulty in obtaining a large and continuous supply of oil at a price low enough to meet the competition of coal. But many heavy locomotives have been fitted for special work on mountain sections with many long tunnels, as on the Italian State Railways. It is particularly desirable to avoid smoke in tunnels.

Locomotive Boiler.

Fig. 32 is the fire-box used for liquid fuel on the Southern Pacific Railroad, the oil being sprayed into the front of the fire-box below the mud ring and under the usual brick arch and directed against a sloping brick lining of the back plate. The sides of the box are cased in bricks, and there are openings for air in the brick bottom to admit air under the flame. A central brick arch baffle is thrown across the middle of the fire-box, and an arch is thrown across just below the fire-door. The plates of the upper part of the box are bare, and the results are said to be satisfactory.

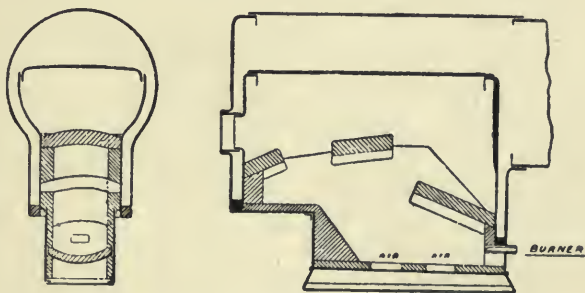

Fig. 32. LOCOMOTIVE FIRE-BOX FOR OIL FUEL,
SOUTHERN PACIFIC RAILROAD.

According to Mr. Holden the fuel tank should be above the level of the atomizers. This is a point with which all do not agree; some consider that the fuel ought to be pumped to the atomizers, and no oil should be able to flow by gravity with the attendant risks in case of rupture.

Unless an independent source of steam is available, steam should be raised in the boiler by an ordinary fire to a pressure of, say, 25 pounds, when the liquid fuel apparatus may be started.

Oil burners must not be started before there is a flame in the furnace; if doubtful, a few pieces of wood or some oily waste should be set alight in the furnace before applying the oil.

The above rules are applicable to all systems of oil burning. A common danger is the risk of gases accumulating in the furnace and leading to explosion when the dampers are opened and flame produced. As with coal, the accumulation of gas

may be prevented by drilling a two-inch hole near the top of the damper, so that when the damper is closed there is always a vent through it which will stop any accumulation of gas.

The atomizing agent, whether steam or air, should be hot; high pressure steam is better than low pressure steam; the tendency is to force the oil forward at a considerable pressure to the burners and compel it to escape, by a fine opening, thereby probably tending to atomize itself somewhat.

The practice in America generally is towards pumping oil to the burners rather than allowing it to flow by gravity.

Air at a moderate pressure appears to be as competent to atomize oil as steam at a high pressure. No explanation of this is given, but it is partially due to the greater density of air and probably in part to the fact that air is a supporter of combustion and induces earlier combustion or ignition.

The Meyer System.

This is shown in Fig. 33, and is a modification of the Körting system. Oil is supplied by the Körting system and air is admitted through specially placed blades in an extension of the furnace front, the air being heated in a surrounding jacket, which is arranged with spiral divisions. The air is delivered to the surface in a whirling manner, and the system has been at work on several Dutch steamers with success and similar general types of apparatus have been running in Roumania.

THE MIXED SYSTEM OF COAL AND LIQUID FUEL COMBUSTION

There is more in the mixed system than mere convenience. The simultaneous use of solid and liquid fuel in the same furnace modifies the conditions for each.

For coal the efficiency of combustion is better; for oil the heat is better utilized.

Combustion on the grate may be imperfect, but the oil atomizer so mixes up the gases from the grate with the air admitted through and above it, that combustion is much improved and the excess of air is used by the oil.

Where the oil is only a fifth of the coal, the coal equivalents of the oil appears enormous.

According to M. Bertin, where 5 kilos. of coal would ordinarily develop each 7,800 calories, they will produce 9,200 calories, a gain of 7,000 calories. The excess of air supplied with the 5 kilos. of coal would be 20 cubic metres, and this would suffice for the added kilogram of oil, which would produce 11,000

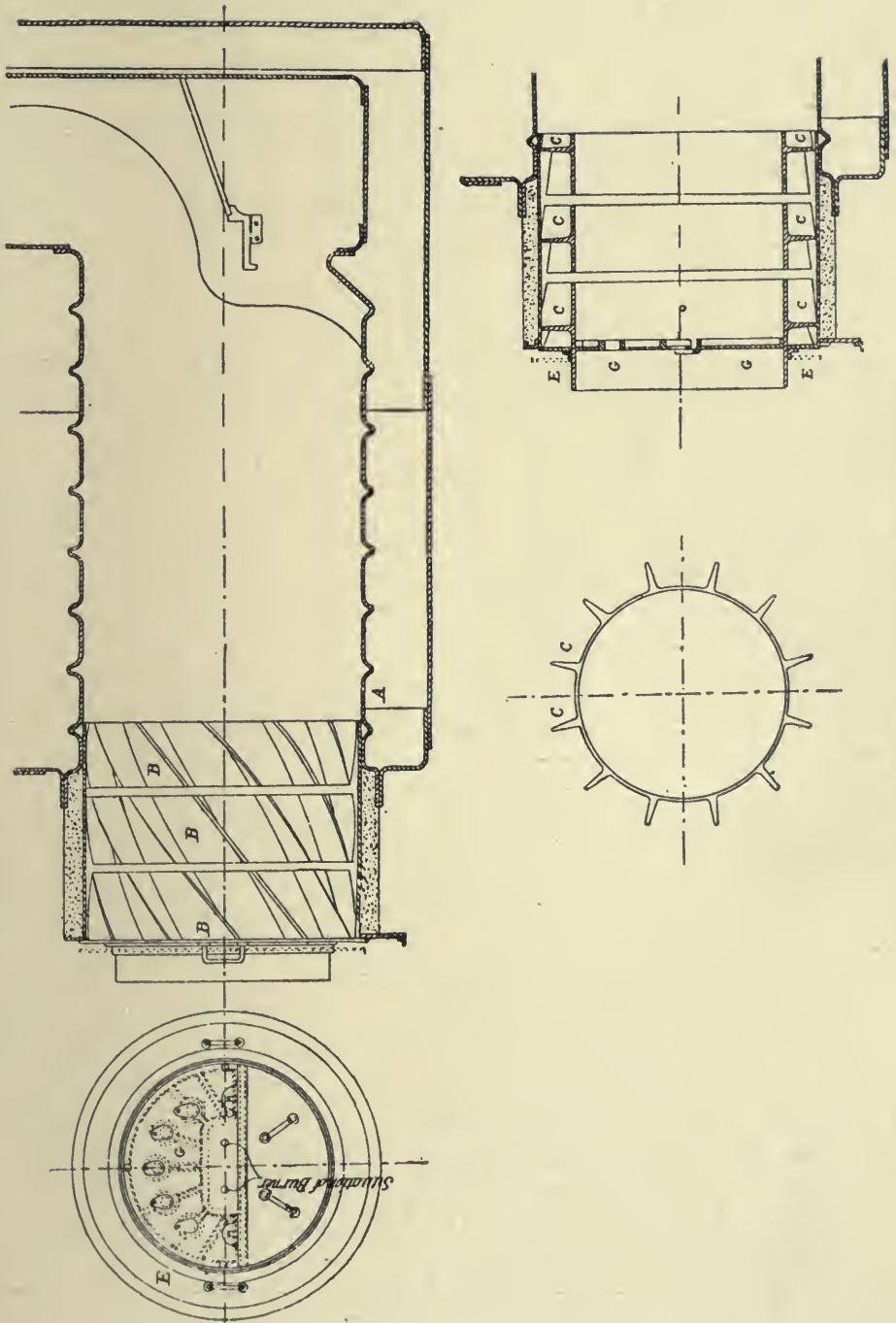

Fig. 33. MARINE FURNACE, MEYER SYSTEM.

calories with no further air supply. A total of 18,000 calories, compared with the original output of 7,800 calories per kilo. of coal, makes the ratio of oil to coal appear 2.31. Obviously a part of this is due to coal, but it may fairly be credited to the system.

The limit of perfect use of air is found when the oil is one-third of the coal, and the ordinary four cubic metres of excess air still furnishes the theoretical 11 cubic metres for the oil: the apparent equivalence of coal and oil becomes—

$$\frac{1,400 \times 3 + 11,000}{7,800} = 1.95$$

These ratios are not perhaps secured in practice, but serve to point to the possible advantages of the mixed system and what should be aimed at.

With half and half coal and oil the ratio becomes 1.77, a figure that has been approached in certain experiments at Indret. Ratios of 3 and over, what have been claimed, cannot, as Mr. Bertin says, be justified on any hypothesis. Nor is the total consumption of the oxygen supplied at all closely approached in general practice.

The proportion of free oxygen to carbonic acid is an indication of the excess of air admitted. The ratio of the air admitted to that used is—

$$\frac{\text{CO}_2 + \text{O}}{\text{CO}_2} = 1 + \frac{\text{O}}{\text{CO}_2} \text{ per volume, and}$$

$$\frac{\text{CO}_2 + \text{O}}{\text{N}} = \frac{20.8}{79.2} \text{ per volume.}$$

These figures neglect the hydrogen.

With coal burned at the rate of 100 kilos. per metre² of grate, if the oxygen measures 8 per cent., and with 200 kilos., say 5 per cent., the fire is too thin or the draught too great. With 1 or 2 per cent. of carbonic oxide the fire is too thick and the draught poor. Both oxygen and CO present together indicate bad furnace arrangements.

A test at Indret of the trial boiler of the *Jeanne d'Arc* with coal alone gave the following results—

Coal per hour per metre ² of grate.	Percentage in volume.				$1 + \frac{\text{O}}{\text{CO}_2}$
	CO ₂ .	CO.	O.	N.	
90 k.	11	1	6	82	1.54
140	11	1	5	83	1.45
200	13	0.5	4	82.5	1.30

The same boiler on the mixed system gave the results below—

Per hour per metre ² of grate.		Air Pressure.	Percentage of Gas.				$1 + \frac{O}{CO_2}$
Carbon.	Petroleum.		CO ₂ .	CO.	O.	N.	
75k.	37 k.	10 mm.	10	0	8	82	1.80
	30	10	10	0	8	82	1.80
	37	10	10	0	8	82	1.80
100	50	20	8.5	0	9.5	82	2.12
	66	25	8.5	0	9.5	82	2.12
150	35	25	11	0	7	82	1.64
	55	30	11	0	7	82	1.64
	75	40	11	0	7	82	1.64

With oil alone Mr. Orde found as below—

	CO ₂ .	CO.	O.	N.	$1 + \frac{O}{CO_2}$
Test No. 1	13.2	0	3.6	83.2	1.27
Test No. 2	12.6	0	4.0	83.4	1.32
Average	12	0	3.8	83.3	1.285

a better result, after all, than the mixed system produced.

In calculating the apparent effect of mixed fuel, M. Bertin assumes the case of a boiler working 1 hour and a weight of water = *a* per kilo. of coal ordinarily,

b = the water evaporated per kilo. of mixed fuel,

x = the evaporation attributed to one kilo. of oil,

C = weight of coal burned per metre² of grate,

D = " " oil " " " " " "

The vapour produced by *C* + *D* of mixed fuel, assuming *a* to be as in the ordinary coal fired boiler, will be *Ca* + *Dx*.

Then per kilo. of mixed fuel we have

$$\frac{Ca + Dx}{C + D} = b, \text{ which gives } x = \frac{(C + D)b - Ca}{D} = b + \frac{C}{D}(b - a),$$

Whence, if *R* is the ratio of oil to coal, we have

$$R = \frac{x}{a} = \frac{b}{a} + \frac{C}{D} \left(\frac{b}{a} - 1 \right)$$

Tests in the *Furieux* made to determine *R* gave the following results—

$\frac{D}{C}$	<i>a</i>	<i>x</i>	$R = \frac{x}{a}$
0.00	9.05	—	—
0.45	9.05	11.34	1.25
0.64	9.05	14.2	1.56

The figure 1.56 was greater than the figure found for oil used alone, but was not confirmed by tests at Cherbourg of a Godard boiler with too forced a draught and badly arranged oil sprays, for the effect *b* of the mixed fuel was even inferior to that of coal alone, which shows how much the efficiency depends on arrangements.

The value of *R* was sought at Indret by Mr. Brillie in a series of tests extending from the end of 1896 to early in 1900, in view of applying mixed firing to boilers of Du Temple Guyot type.

The atomizers had air induction passages as in the Orde atomizer, Fig. 15, but no air heating. The flames kept short and the heat kept well in the furnace, and high values of *R* were reached, as 1.6 for a rate of combustion of 100 kilos. of coal and 50 kilos. of oil per metre² of grate.¹

The tests, however, were too short for exactitude.

Other tests made only upon engine power are, however, available.

Let *c* be the coal per horse power ordinarily.

„ *e* „ „ „ „ in the mixed system.

„ *d* „ oil „ „ „ „ „ „

Then *d* takes the place of *c* — *e* in the production of one horse power so that

$$R = \frac{c - e}{d}$$

The following table is a *résumé* of Navy tests on the locomotive type of boiler or torpedo boat No. 109 at Cherbourg.

	h.	1st Series.			2nd Series.			3rd Series.
		15mm.	13mm.	12mm.	25mm.	26mm.	29mm.	50mm.
Air pressure. . . .								
Coal alone	<i>c.</i>	1,337k	1,337k	1,337k	1,354k	1,354k	1,354k	1,506k
Mixed System { Coal	<i>e.</i>	0,979	6,914	0,581	0,713	0,721	0,652	1,219
{ Petrolm. } . . .	<i>d.</i>	0,379	0,388	0,494	0,405	0,474	0,655	0,434
{ Total } <i>e</i> + <i>d</i>		1,358	1,302	1,075	1,118	1,195	1,307	1,653
Equivalent = $R = \frac{c-e}{d}$		0,94	1,09	1,53	1,58	1,33	1,07	0,66

The interest lies in the falling off at high pressures, the furnace being too short satisfactorily to burn the oil at such rapid draught.

Where 60 kilos. of oil were used to 80 kilos. of oil with draught but little forced, *R* was found to be 1.5, and the mixed system took the place of forced draught, with a result equal to the combustion of 170 kilos. of coal only, a result thought very encouraging. Very discordant results were obtained on the

¹ Kilos. per metre² ÷ 5 = pounds per square foot nearly.

Milan, the *Surcouf*, the *Pakin*, and the *Forbin*. On the *Milan* especially oil proved very unsuitable to the furnaces of the Belleville boiler, as might be anticipated. On the *Surcouf*, on the contrary, the result of mixed fuel was to reduce total fuel consumption nearly to half that of coal alone.

M. Bertin does not express any final opinion on mixed systems, but claims that where employed it is essential to success that all the details should be simple so as to avoid the danger of error on the part of a little-trained personnel, such as the opening or closing of certain valves, always in their power to do.

Generally little information is public on liquid fuel in any Navy. Nobody knows why a secret is made of it, for the efficiency attained with liquid fuel outside naval practice is such that better results are scarcely likely to have been attained within it.

CHAPTER XI

RUSSIAN AND AMERICAN LOCOMOTIVE PRACTICE

The Baldwin Co.'s System.

THE Baldwin Locomotive Co. consider that, while opinions upon atomizers differ as to central jet burners such as the Urquhart, the relative position of the oil supply and other details, their own burner (Fig. 34) is a satisfactory one, and has been applied to many locomotives in Russia and the United States.

It is rectangular in section, with two longitudinal passages, the upper one for oil, the lower one for steam. The oil is regulated by a plug cock on the feed pipes, the handle of which extends to the cab within easy reach of the fireman.

Steam is admitted to the lower part of the burner through a pipe so connected to the boiler as to ensure dry steam. The control valve is in the cab close to the fireman's seat. A free outlet is allowed for the oil at the nose of the burner; the steam outlet, however, is contracted at this point by an adjustable plate which partially closes the port, and gives a thin wide aperture for the exit of the steam. This wire-draws the steam increasing its velocity at the point of contact with the oil, and giving a better atomization. A permanent adjustment of the plate is made for each burner after the requirements of service are ascertained. The moving of the plate is not then required except for cleaning purposes. The oil, as it passes through the burner, is heated by the steam in the lower portion, and flows freely in a thin layer over the orifice. It is there caught by the jet of steam and completely broken up and atomized at the point of ignition, and carried into the fire-box in the form of vapour, where it is thoroughly mixed with air and burns freely.

It is computed that one inch of breadth of slit will serve for 100 square inches of cylinder area, so that the breadth of a burner is $B = D^2 \times .007854$. As only one burner is used,

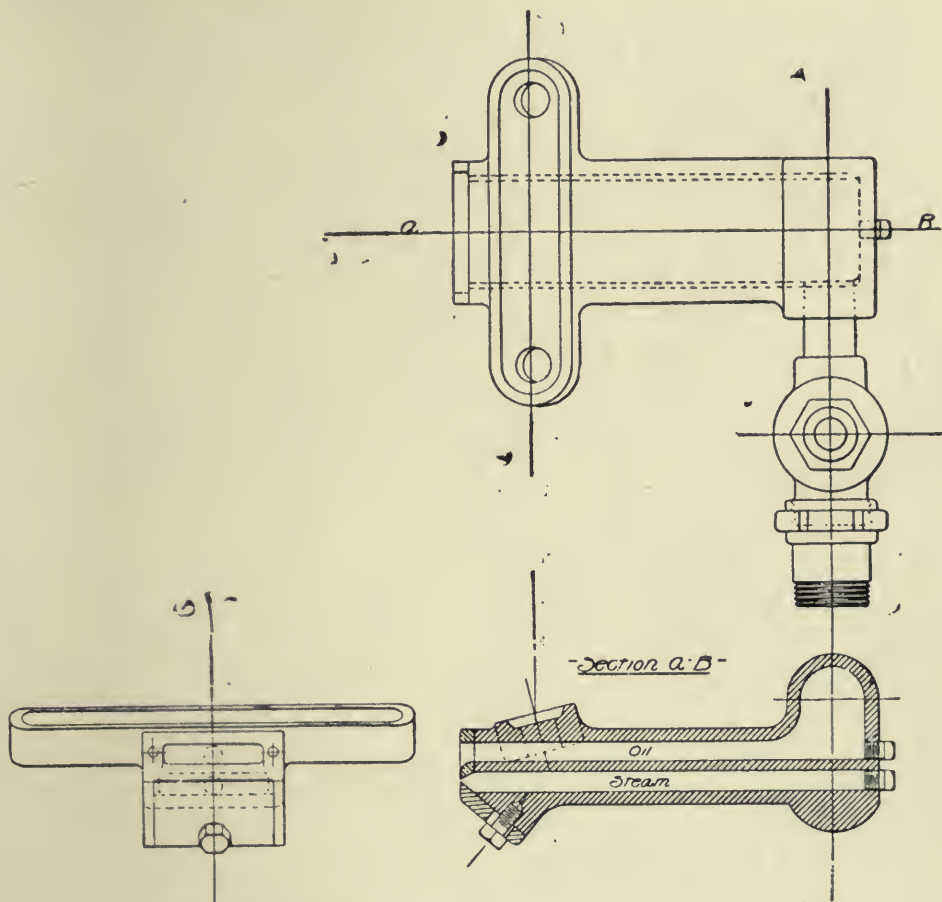

Fig. 34. ATOMIZER. BALDWIN LOCOMOTIVE CO.

American fire-boxes being narrow, it is apparently the case that one cylinder is intended to be taken, and not the area of both cylinders. $D =$ diameter of cylinder.

Large oil-pipes deliver a full supply as far as the regulating cock, to permit of fine adjustment of which its orifice is not circular but square, with the diagonals as in Fig. 35.

The necessary changes to fit an engine to use liquid fuel are shown in Fig. 36. The atomizer is attached below the mud ring, and the spray is directed upwards into the fire-box,

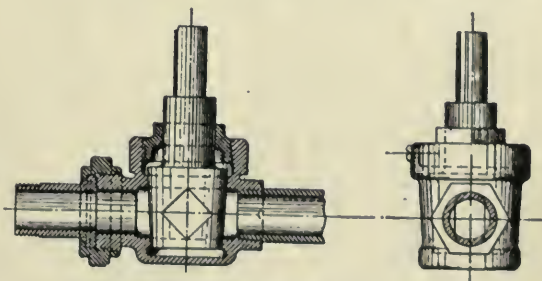

Fig. 35. OIL REGULATING COCK. BALDWIN LOCOMOTIVE CO.

which is fitted with a brick arch, a liner of fire-brick and a base filling the front

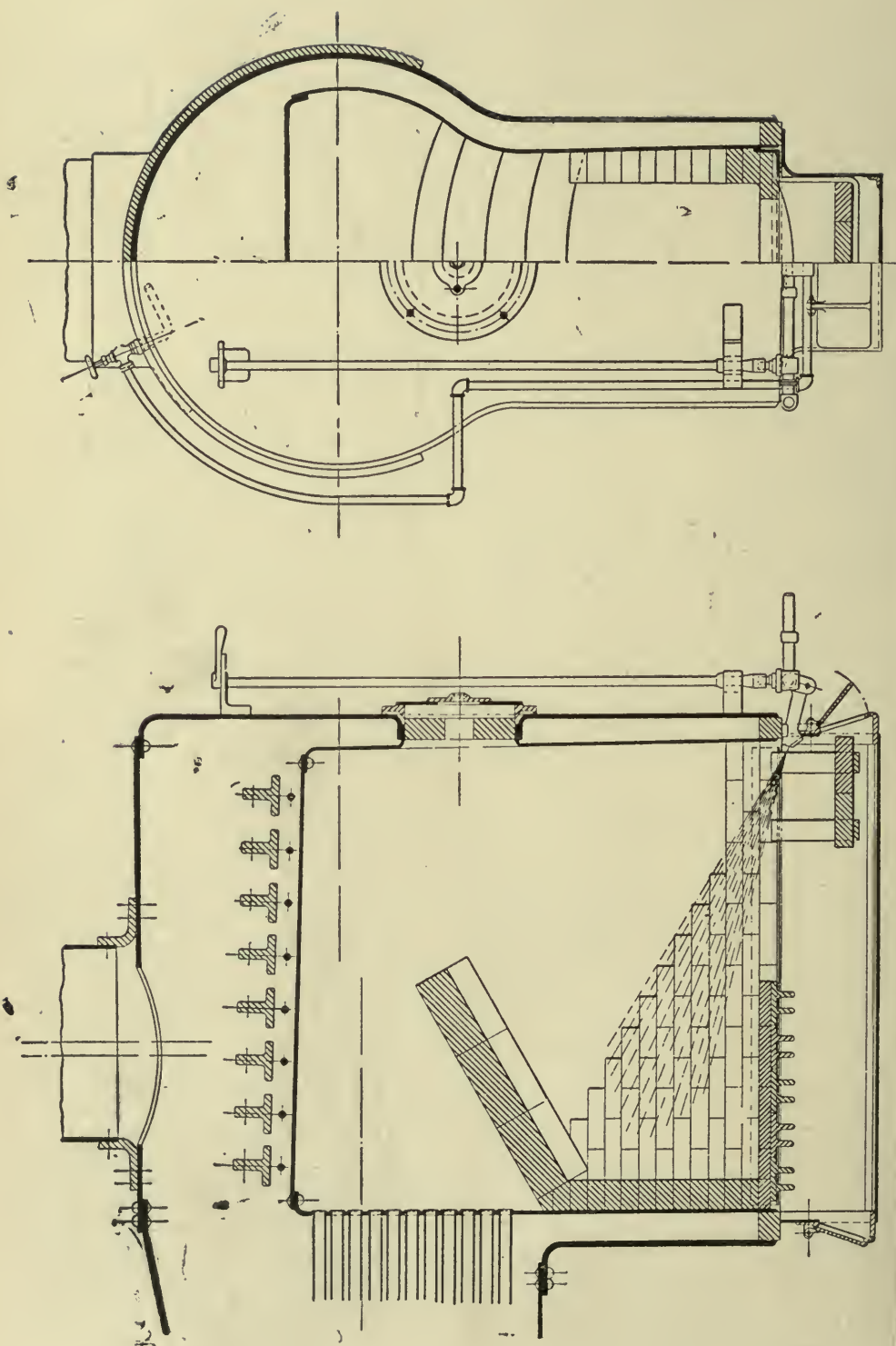

Fig. 36. LOCOMOTIVE FIRE-BOX FOR LIQUID FUEL. BALDWIN LOCOMOTIVE CO. (OLD TYPE.)

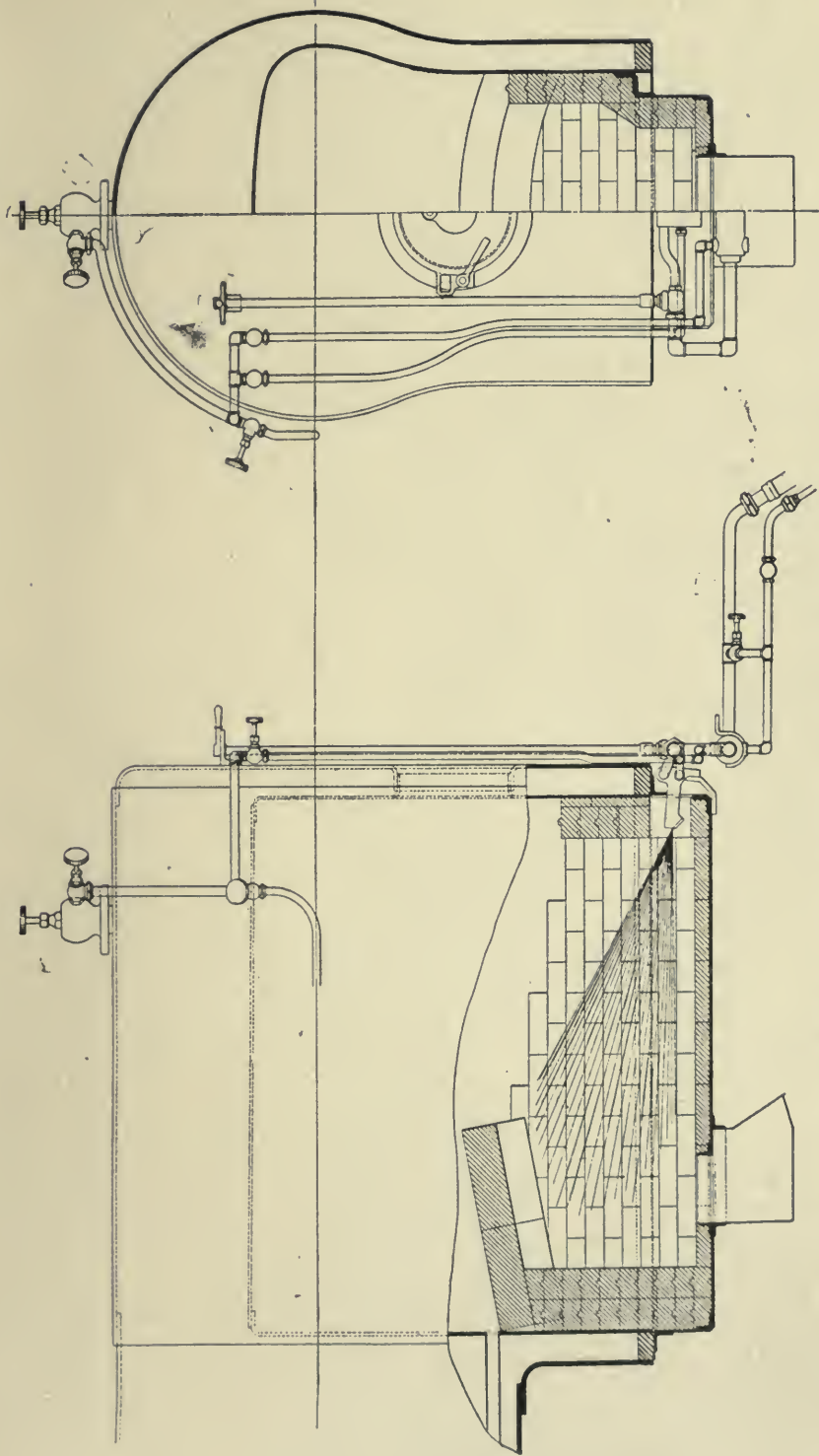

Fig. 37. FIRE-BOX FOR LIQUID FUEL. BALDWIN LOCOMOTIVE CO. (NEW TYPE).

half of where the grate usually is placed. A small hearth is placed to catch any drip from the burner, and from the lower corner of the bridge there is built, to protect each side sheet, a triangular wall of bricks extending with its lower point to the back plate. The side walls form the sides of the fire-brick combustion chamber. The "ash-pan" is retained with its air dampers to admit air below the fires, and the dampers should shut tight. The inner side of the fire-door is lined with a plate of fire-brick.

The latest form of fire-box (1911) is that of Fig. 37. This differs but little from that of Fig. 36, which represents a coal fire-box. The arch is kept low and the upper space of the box is large. It is recommended not to leave too little space between the arch and the crown sheet; otherwise the flames will be too severe upon the crown sheet and generate too severe a local heat. The ashpan is of modified form as shown. The weight and volume of oil for a given mileage will be about half that necessary for coal.

A report of the Committee of the American Railway Master Mechanics' Association says—

Fuel oil can be used in almost any form of fire-box, the best place for the burner being just below the mud ring, spraying upward into the fire-box. In some recent experiments with oil of 84° gravity, 140°F. flash, and 190°F. fire test, in which the boiler had 27 square feet grate area and 2,135 square feet of heating surface, 8 per cent. being in the fire-box, it was found that there were about 39 pounds of oil burned per square foot of grate area, about 0.45 pounds per square foot of heating surface per hour, the equivalent evaporation from and at 212° being about 12½ pounds of water per pound of oil. It was also computed that there should be about one-third of an inch width of burner for each cubic foot of cylinder volume.

Or volumes of both cylinders in cubic feet $\div 3 =$ width of burner in inches for ordinary locomotives. For compound engines the amount of steam is 10 per cent. and of fuel 20 per cent. less, and in the foregoing formula only the h.p. cylinder volume ought to be considered.

For compound locomotives a guide to an approximate idea of the value of oil fuel as compared with coal is as follows:—

Cost of coal per ton (of 2,000 lb.) + cost of handling (say 50 cents)
 $\times 10.7 \times 7$

2,000 \times evaporative power of coal

= Price per American gallon at which oil will be the equivalent of coal. To find the price per English gallon multiply by 1.2.

In these computations the cost of both oil and coal is considered at the engine, and not at the place of purchase.

The weight and volume of crude petroleum based on a specific gravity of 0.91, which is about the average of the Texas oil, as well as that received from South America, is given below.

WEIGHT AND VOLUME OF CRUDE PETROLEUM.

Pound.	U.S. Liquid Gal.	Barrel.	Gross Ton.	Imp. Gal.
1	.13158	.0031328	.0004464	.1096
7.6	1.00	.02381	.003393	.83.
319.2	42.00	1.00	.1425	35.00
2,240.0	294.720	7.017	1.00	245.60

For convenience in obtaining the correct approximate weight of oil, the gravity conversion table, No. XIV, may be useful.

In American practice where railroads are so dirty with ash and cinders thrown from the locomotives by the powerful blast employed, oil should give an advantage to any line adopting it that cannot be so securely counted on in Great Britain, where ash throwing is less prevalent.

Oil puts a stop to the choking of the tubes of the boiler and permits tubes to be employed smaller than now admissible on account of liability to choke.

Tubes of one inch diameter might be used if enough could be got in to give the requisite area.

The economy of oil is not merely a question of fuel economy.

Table No. XI gives the economy of oil at its relative value compared with coal on both the fuel account and all ascertained economies, the second value being based on 1 pound of oil being worth 2 of coal in place of $1\frac{3}{4}$, as on the mere fuel account. The extra economies include repairs on locomotives and ash handling.

Dr. Dudley's formula for relative price is—

$$\frac{2,000 \times P}{W \times N \times R} = C; \text{ where } \begin{cases} P = \text{price of oil per barrel.} \\ W = \text{weight per gallon in pounds.} \\ N = \text{gallons per barrel.} \\ R = \text{ratio of oil to coal} = 1\frac{3}{4} \text{ or } 2, \\ \text{according to conditions.} \\ C = \text{price of coal per ton of } 2,000. \end{cases}$$

For tons of 2,240 lb. use this number in the numerator in place of 2,000. The weight W multiplied by N will be the same in either American or English gallons, and the barrel is always the same, so that only the pounds per ton need be changed,

the price of coal and oil of course being given in the same equivalents, either dollars or shillings.

$$\text{Hence } P = \frac{W \times N \times R \times C}{2,000 \text{ (or } 2,240 \text{ for long tons).}}$$

The Baldwin Co. do not recommend crude oil : it is more dangerous ; it has an exceedingly unpleasant odour, and it is not so economical. Crude oil contains more or less volatile matter which vaporizes quite readily. With the necessary use of lanterns and open lights round about locomotives, there would be more or less danger of explosions. In the case of a wreck, if the oil tank was ruptured, it would be almost impossible to prevent a fire. As to the odour of the crude oil, it would certainly be extremely unpleasant to ride behind a locomotive fed with Lima crude oil. Crude oil is not so economical as reduced oil, because oil is sold by volume, and a gallon of crude, instead of weighing 7.3 pounds, weighs from say 6.25 to 6.5 pounds, and, as the heat is proportionate to the weight, a barrel of crude will not give so much heat as a barrel of reduced oil. The oil used on the Grazi-Tsaritzin Railway, and believed to be quite safe to use, is an oil not below 300°F. fire-test. Crude oil can be used on stationary boilers, where it is kept in tanks and brought to the boilers in pipes.

The arguments appear sound, in view of the disastrous American experiences of burning railway wrecks, and the English experience at Abergele ; but all crude oils are not so unpleasant as the Lima oil referred to, and the odour should not live through the furnace. Still the fire risk of crude oil, with its volatile constituents left in, is to be avoided.

In experiments on the Pennsylvania Railroad, it was found with oil at 30 cents per barrel, that it cost nearly 50 per cent. more to take the same train of cars 100 miles by means of oil than by means of coal.

The Urquhart System.

To the late Thomas Urquhart, of Dalny, Scotland, the former Locomotive Engineer of the Grazi-Tsaritzin Railway of Russia, is due the first notable success in liquid fuel combustion.¹

Urquhart brought the system to the notice of engineers in a paper read at Cardiff in 1884.

According to this paper, the percentage of astatki in Russian oil is 70 to 75 per cent., while Pennsylvania oil contains but 25 to 30 per cent., the two products being the complement of

¹ *Proceedings of the Institute of Mechanical Engineers*, 1884.

each other. This fact is quite consistent with approximately equal proportions of carbon and hydrogen, and Table XII is given to illustrate this. The following is an abstract of Urquhart's paper—

“Comparing naphtha refuse and anthracite, the former has a theoretical evaporative power of 16.2 pounds of water per pound of fuel, and the latter of 12.2 pounds at a pressure of 8 atm. or 120 pounds per square inch; hence petroleum has, weight for weight, 33 per cent. higher evaporative value than anthracite. In locomotive practice a mean evaporation of from 7 pounds to $7\frac{1}{2}$ pounds of water per pound of anthracite is generally obtained, thus giving about 60 per cent. of efficiency, while 40 per cent. of the heating power is lost. But with petroleum an evaporation of 12.25 pounds is practically obtained, giving

$$\frac{12.25}{16.2} = 75 \text{ per cent. efficiency.}$$

Thus petroleum is theoretically 33 per cent. superior to anthracite in evaporative power; and its useful effect is 25 per cent. greater, being 75 per cent. instead of 60 per cent. Weight for weight, the practical evaporative value of petroleum is at least from

$$\frac{12.25 - 7.50}{7.50} = 63 \text{ per cent. to } \frac{12.25 - 7.00}{7.00} = 75 \text{ per cent.}$$

higher than that of anthracite.

Spray Injector.

“Steam, not superheated, being the most convenient for injecting liquid fuel into the furnace, it remains to be proved how far superheated steam or compressed air is superior to saturated steam—taken from the highest point inside the boiler, by a special internal pipe. In using several systems of spray injectors, he invariably noticed the impossibility of preventing leakage of tubes, accumulation and inequality of heating of the fire-box.

“The work of a locomotive is very different from that of a marine or stationary boiler, owing to the frequent changes of gradient on the line, and the stoppages at stations, which render firing with petroleum very difficult; and were it not for properly arranged brickwork inside the fire-box, the spray jet alone would be quite inadequate. The efforts of engineers have been mainly directed towards arriving at the best kind of spray injector for so minutely sub-dividing a jet of petroleum

into a fine spray, by the aid of steam or compressed air, as to render it easy of ignition. For this object nearly all the known spray injectors have very long and narrow passages for petroleum as well as for steam; the width of the orifice does not exceed from $\frac{1}{2}$ mm. to 2 mm., or 0.02 in. to 0.08 in., and in many instances is capable of adjustment.

“ With such narrow orifices any small solid particles which may find their way into the spray injector along with the petroleum will foul the nozzle and check the fire. Hence in many steamboats on the Caspian Sea, although a single spray injector suffices for one furnace, two are used, in order that when one gets fouled the other may still work; but, of course, the fouled orifices require incessant cleaning out.

“ *Locomotives.*—In arranging a locomotive for burning petroleum, several details require to be added in order to render the application convenient. For getting up steam, to begin with, a gas pipe of 1 in. internal diameter is fixed along the outside of the boiler, and at about the middle of its length it is fitted with a three-way cock, having a screw nipple and cap. The front end of the longitudinal pipe is connected to the blower in the chimney, and the back end is attached to the spray injector. Then by connecting to the nipple a pipe from a shunting locomotive under steam, the spray jet is immediately started by the borrowed steam, by which at the same time a draught is also maintained in the chimney. In a fully equipped engine-shed the steam would be obtained from a fixed boiler conveniently placed and specially arranged for the purpose. Steam can be raised from cold water to 3 atm. pressure in twenty minutes. Auxiliary steam is then dispensed with, and the spray is worked by steam from its own boiler; a pressure of 8 atm. is then obtained in from 50 to 55 minutes from the time the spray jet was first started. In daily practice, when it is only necessary to raise steam in boilers already full of hot water, the full pressure of 7 to 8 atm. is obtained in twenty to twenty-five minutes. While experimenting with liquid fuel for locomotives, a separate tank was placed on the tender for carrying the petroleum, having a capacity of about 3 tons. But a separate tank on the tender, even though fixed in place, would be a source of danger from the possibility of its moving forwards in case of collision. As soon as petroleum firing was permanently introduced, the tank for fuel was placed in the coal spaces of the tender between the two side compartments of the water tank. For a six-wheeled locomotive the capacity of the tank is $3\frac{1}{2}$ tons of oil, a quantity sufficient for 250 miles,

with a train of 480 tons gross, exclusive of engine and tender. In charging the tank with petroleum, it is important to have strainers of wire cloth in the manhole of two different meshes, the outer one having openings of, say, $\frac{1}{4}$ in., the inner say of $\frac{1}{8}$ in. [In later English practice the strainer is much finer than this.—AUTHOR.] These strainers are occasionally taken out and cleaned. If care be taken to prevent solid particles from entering with the petroleum, no fouling of the spray injector is likely to occur, and if an obstruction should arise, the obstacle, being of small size, can be blown through by screwing back the steam cone in the spray injector far enough to let the solid particles pass and be blown into the fire-box. This expedient is easily resorted to even when running and no more inconvenience arises than an extra puff of dense smoke for a moment, in consequence of the admission of too much fuel. Besides the two strainers in the manhole of the petroleum tank on the tender, there should be another strainer at the outlet valve inside the tank, having a mesh of $\frac{1}{8}$ in. holes.

“In lighting up, precise rules must be followed to prevent explosion of any gas accumulated in the fire-box. First clear the spray nozzle of water by letting a small quantity of steam brow through, with the ash-pan doors open; at the same time start the blower in the chimney for a few seconds, and any gas will immediately be drawn up the chimney. Next, place on the bottom of the combustion chamber a piece of cotton waste or shavings, saturated with petroleum and burning with a flame. Then open first the steam valve of the spray injector, and next the petroleum valve gently; the first spray of oil coming on the flaming waste ignites without any explosion whatever, after which the fuel can be increased at pleasure. By looking at the top of the chimney, the supply of petroleum can be regulated by observing the smoke. The general rule is to allow a light blue smoke to escape, showing that neither too much air is being admitted nor too little. The combustion is under the control of the driver, and the regulation can be effected so as to prevent smoke altogether. While running the driver and fireman should act together, the latter having at his side of the engine the four handles for regulating the fire, namely, the steam wheel and the petroleum wheel for the injector, and the two ash-pan door handles in which are notches for regulating the air admission. Each alteration in the position of the reversing lever or screw, as well as in the degree of opening of the steam regulator or the blast pipe, requires a corresponding alteration of the fire. Generally the driver passes the word when he intends shutting off steam, so that the alteration

in the firing can be effected before the steam is actually shut off ; and in this way the regulation of the fire and that of the steam are virtually done together. This care is necessary to prevent smoke and waste of fuel. When, for instance, a train arrives at the top of a bank which it has to go down with the brakes on, exactly at the moment of the driver shutting off steam and shifting the reversing lever into full forward gear the petroleum and the steam are shut off from the spray injector, the ash-pan doors are closed, and if the incline be a long one, the revolving iron damper over the chimney top is moved into position, closing the chimney, though not hermetically. The

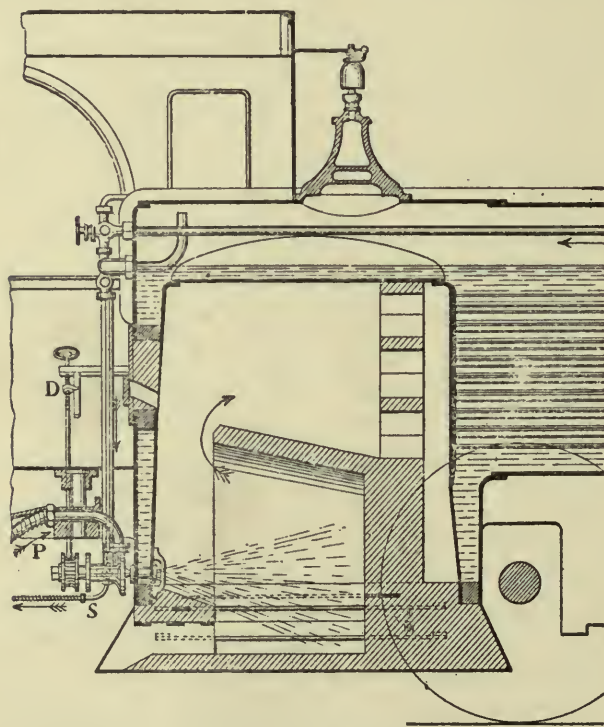

Fig. 38. GOODS LOCOMOTIVE, URQUHART SYSTEM, GRAZI-TSARITZIN RAILWAY.

accumulated heat is thereby retained in the fire-box ; and the steam even rises in pressure, from the action of the accumulated heat alone. As soon as the train reaches the bottom of the incline and steam is again required, the first thing done is to uncover the chimney top ; then the steam is turned on to the spray injector, and next a small quantity of petroleum is admitted, but without opening the ash-pan doors, a small fire being rendered

possible by the entrance of air around the injector, as well as by leakage past the ash-pan doors. The spray, immediately on coming in contact with the hot chamber, ignites without audible explosion ; and the ash-pan doors are finally opened, when considerable power is required, or when the air otherwise admitted is not sufficient to support complete combustion. By looking at the fire through the sight hole, it can always be seen at night whether the fire is white or dusky ; in fact, with altogether inexperienced men, it was found that after a few trips they could become quite expert in firing with petroleum. The better men burn less fuel than

others, simply by greater care in attending to the essential points.

“Several points have arisen which must be dealt with to ensure success. The distance ring between the plates around the firing door is apt to leak in consequence of the intense heat and the absence of water circulation ; it is therefore protected by having the brick arch built up against it, or, better still, a flanged joint is substituted. This arrangement occasions no trouble whatever.”

The fire-box arrangement of the goods locomotive is shown in Fig. 38. The sprayer points downwards upon the hearth which is built in the ash-pan, and continuous with the bridge and arch. A block of brickwork is placed under the sprayer, and below that is a passage for air. The bridge is continued up to the crown of the box, but is perforated and the whole of the front tube plate is exposed to heat. The fire-box surface is 82 sq. ft. Total heating surface, 1,248 sq. ft. “Grate” area, 17 sq. ft. Weight, 36 tons in running order. Pressure, 120 to 135 pounds. 151 tubes 13 ft. 10 in. long \times 2 in. outside diameter.

Fig. 39 shows the petroleum tank in the tender, the heating coil C surrounding the filter whence the oil is drawn through a cock V and pipe P to the sprayer. Steam goes by way of the pipe S and escapes at T. W is the collector for water.

Fig. 40 shows another furnace arrangement, in which the brickwork of the fire-box sides is made cellular, and air is admitted also below the sides by lateral openings K with regulating dampers. The fire-doors are quite blocked, and only a sight hole left at H.

A later design is that of Fig. 41. This includes a lined ash-pan, bridge and over-arch, with a passage through it for air admitted by the forward ash-pan damper. Lateral arches are provided in order that the side sheets of the fire-box may be exposed to the heated gases. No part of the fire-box is actually in touch with the fire-brick, yet the burning oil is completely enclosed with a brick oven. As very usual in Continental practice, the engines had the closing cap to the chimney top. This is used to retain heat in the fire-box at times of standing, and should be a most effectual damper. With liquid fuel employed without solid fuel, the closing of the chimney is very efficient in retaining the heat of the brickwork, and this damper is used when running down hill, and, on again turning the oil spray into the furnace it is at once ignited by the hot brickwork. There is a pointer and scale on the spindle of the regulating

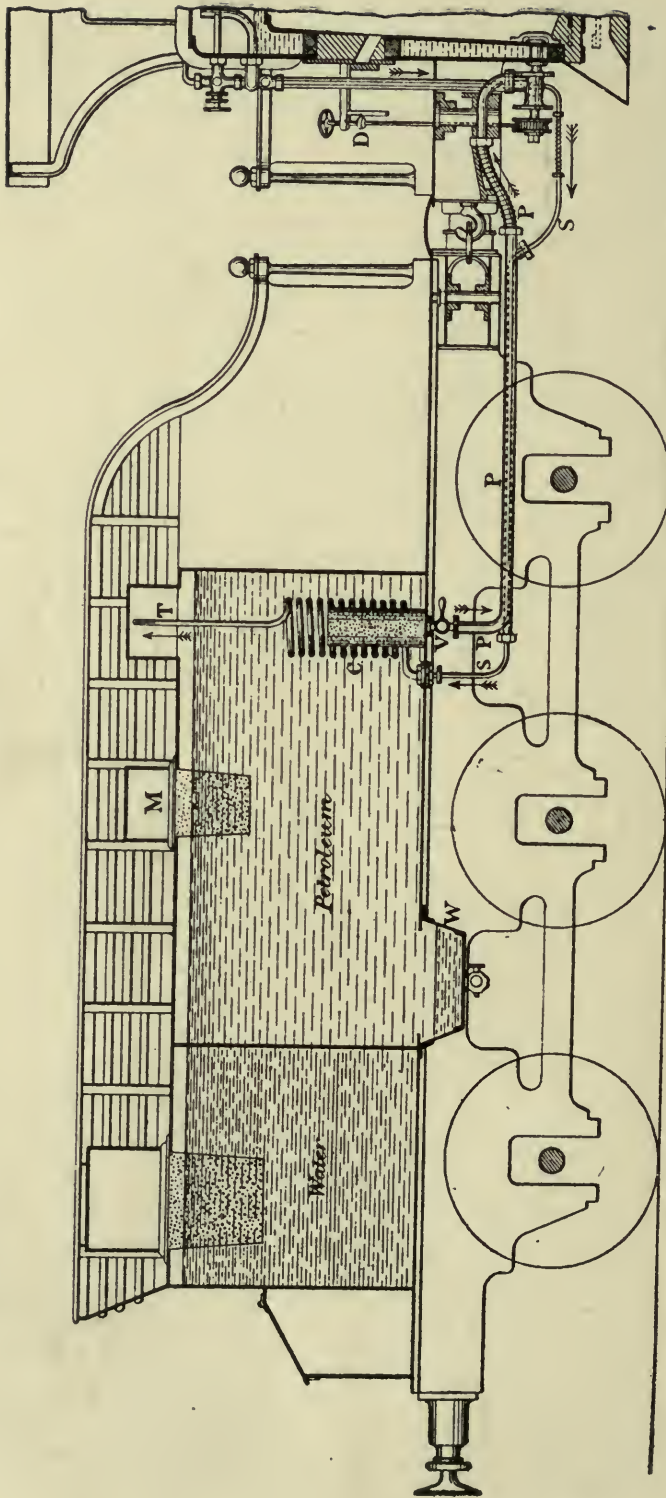

Ins. 12 6 0
 1 2 3 4 5 6 7 8 9 10 11 12 13 14 15 Feet.
 Fig. 39. FUEL TANK IN TENDER, URQUHART SYSTEM, GRAZI-TSARITZIN RAILWAY.

valve D for use by night. The Author has noticed on the Great Eastern Railway, that when apparently quite dark, the chimney top can be seen sufficiently to judge of smoke.

The injector is shown in Fig. 42. It consists of a central steam jet, an annular passage for oil and an outer annulus for air. The steam jet is regulated by screwing the steam cone

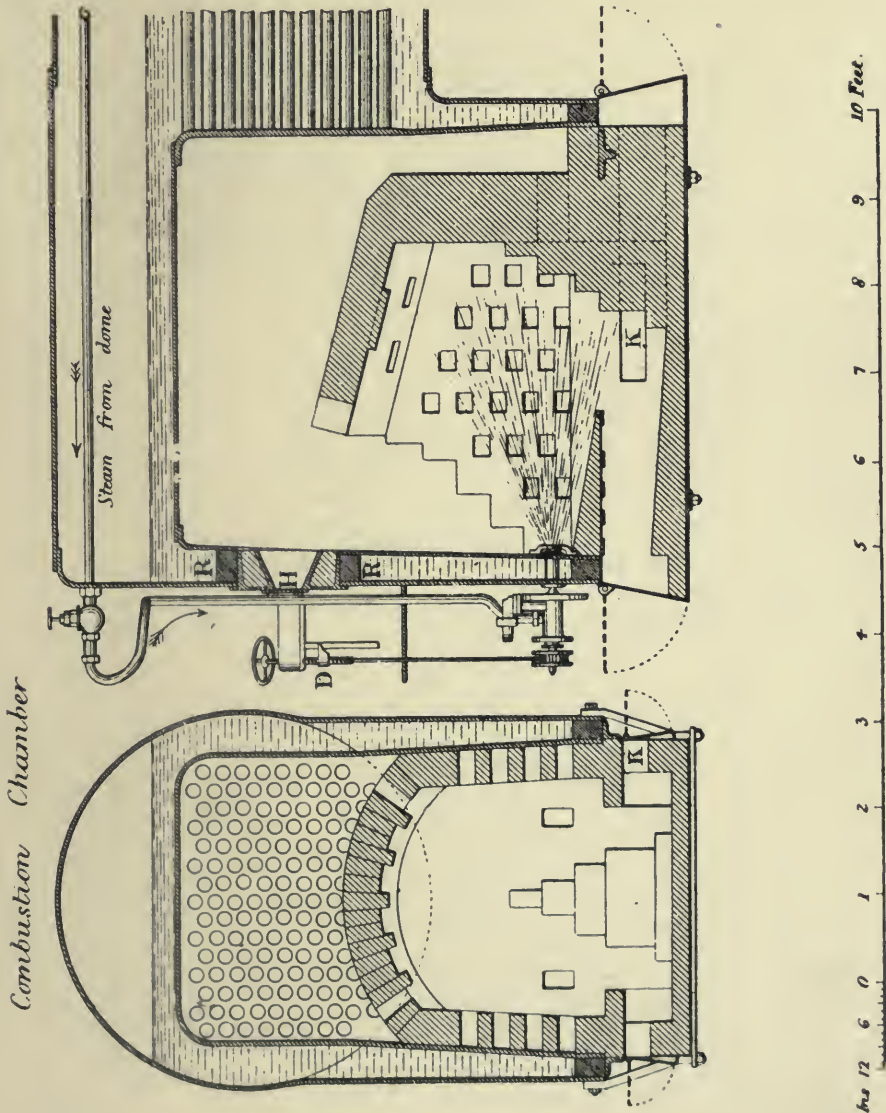

Fig. 40. ALTERNATIVE FIRE-BOX ARRANGEMENT. URQUHART SYSTEM.

to and fro by a worm and wheel on the regulating handle and spindle. The steam cone can readily be removed for clearing purposes, or the back plug can be taken out while the sprayer is at work, with little delay, a wire being introduced to remove any possible obstruction that the steam will not discharge.

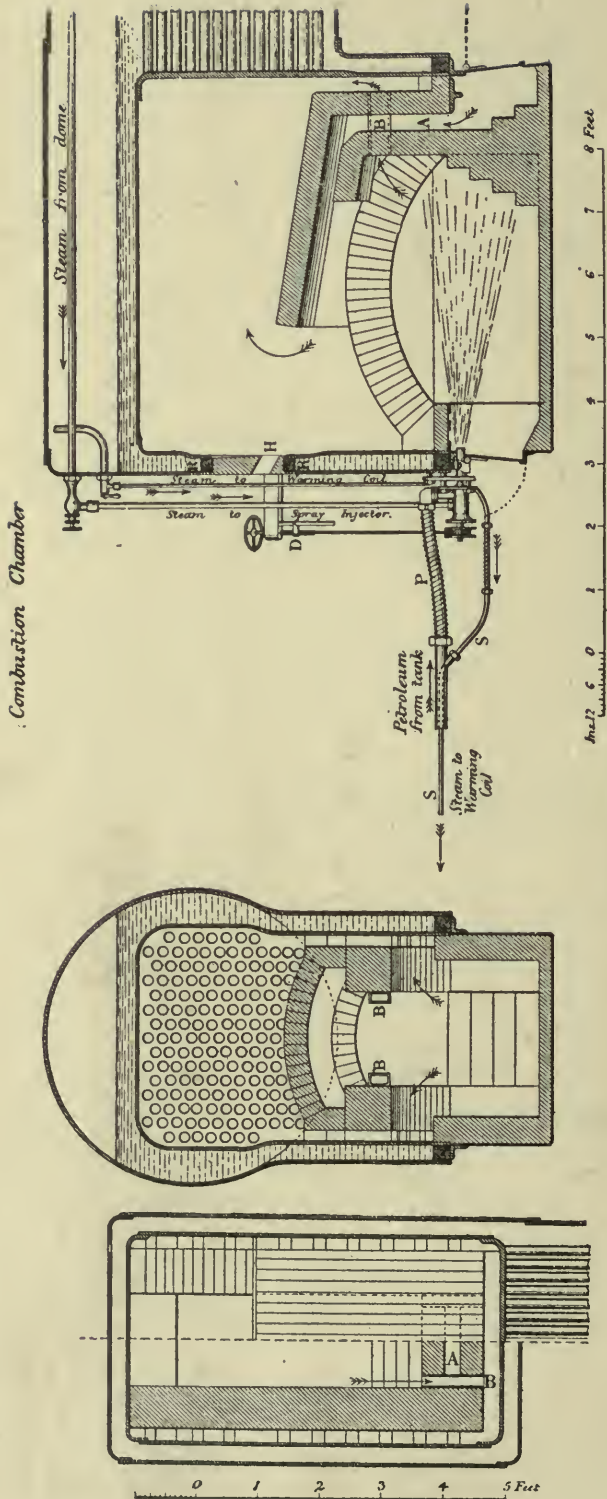

Fig. 41. LIQUID FUEL FIRE-BOX. URQUHART SYSTEM.

Plan of Spray Injector.

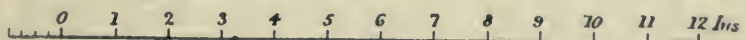
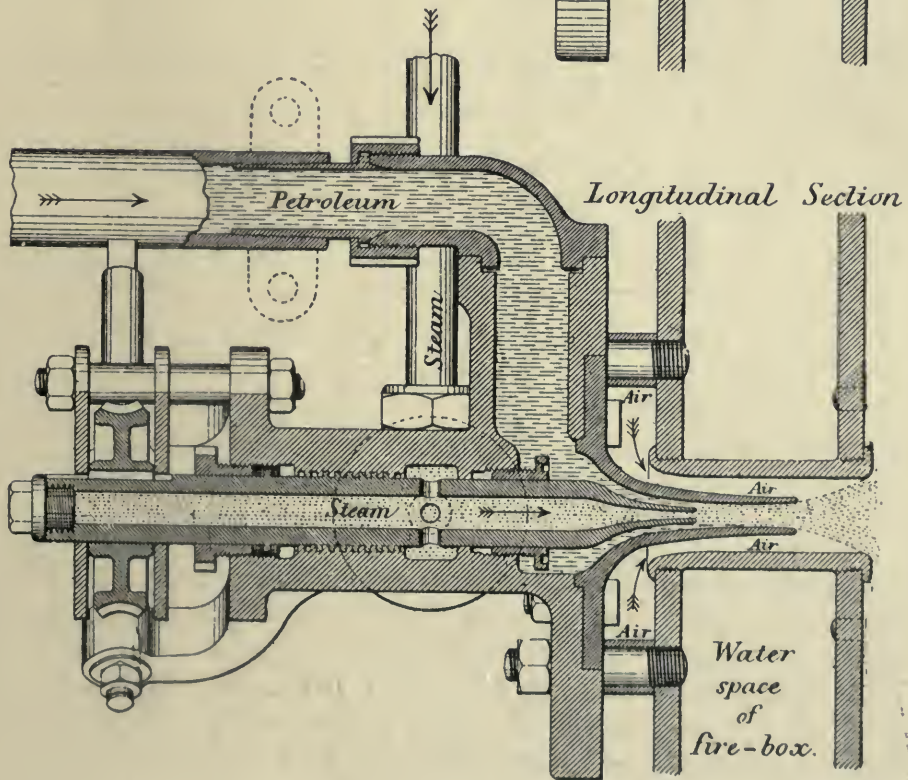
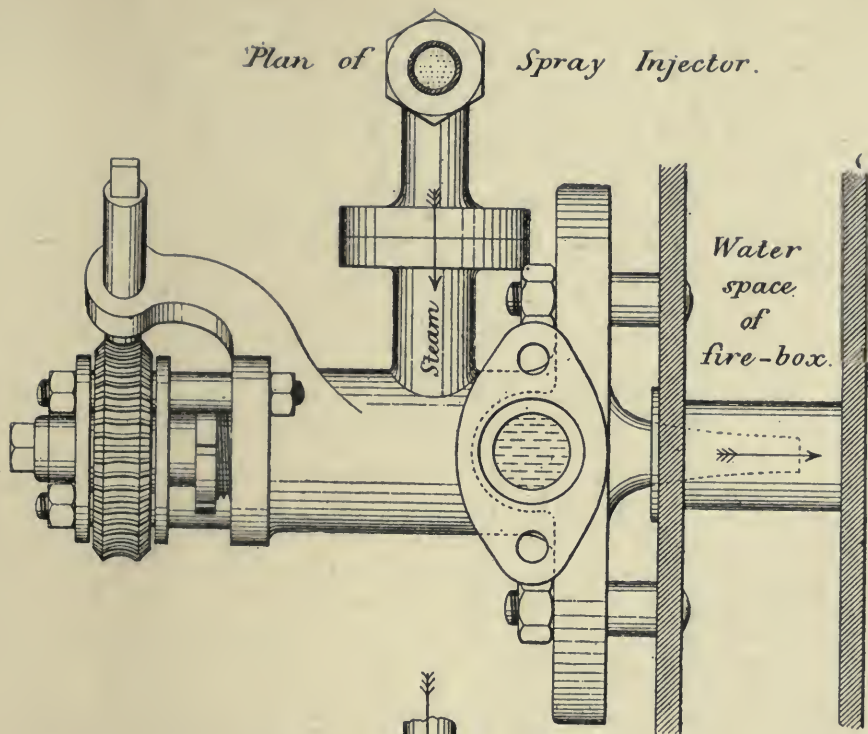

Fig. 42. ATOMIZER. URQUHART'S.

Economies of 45 and 57 per cent. over anthracite and bituminous coal changed to 57 and 67 in an engine arranged to warm the air slightly, and Urquhart thought the air ought to be heated, and this is well established as good practice.

The fuel consumption of all kinds appears high, but this is attributable to long waiting on a single line and to the weight of trains, often as much as 720 tons, and the exposed country, with strong side winds.

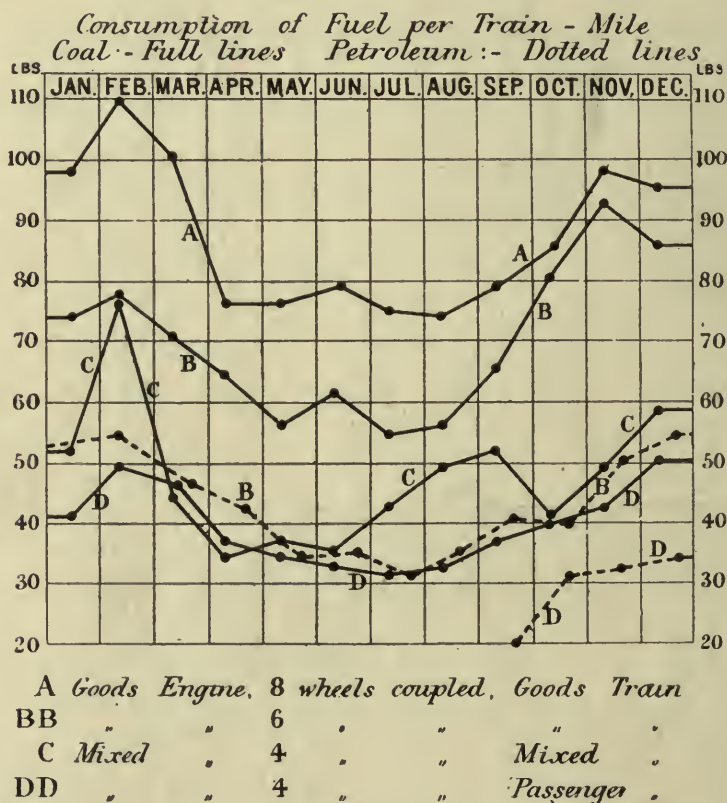

Fig. 43. LOCOMOTIVE PERFORMANCES WITH COAL AND OIL FUEL.
URQUHART'S SYSTEM, GRAZI-TSARITZIN RAILWAY.

Considerable space has been given to this system and to the figures and drawings, because though now old and dating back nearly 30 years, Urquhart had the correct principles of combustion fully before him, and laid out his arrangements with a perfection that cannot be much improved upon to-day. He saw clearly what was necessary, and this may be summed up in the words, Atomizing, Air and Temperature. Hence the success he attained, and the correctness of his arrangements and conclusions.

In Fig. 43 are curves showing the consumption of oil and coal, and in Table XIII are some useful data on specific gravity.

CHAPTER XII

AMERICAN STATIONARY PRACTICE

The Billow System.

THE fuel oil appliances of the National Supply Company of Chicago consist of pumps and atomizers.

Atomizers are actuated in one or a combination of the following ways—by steam, by air supplied by an air compressor, or from a positive blast blower or fan.

An oil burner becomes more efficient and approaches nearer to perfection which will pulverize the greatest amount of oil with the least energy, and will vaporize oil at the point of expansion of the agent used for that purpose.

Atomizers are constructed with various shaped openings—annular, flaring, slotted, semicircular or fan-shaped, producing either a long, round, or a broad spreading flame.

Annular openings are said to be more economical in steam or air than other forms, as a more intimate association of the oil and the vaporizing agent is afforded.

By actual experiment atomizers consume from 3 to 15 per cent. of the entire product of the boiler in vaporizing sufficient oil to develop the capacity of the boiler.

The number of atomizers required for each boiler or furnace is directly proportionate to its size. Of atomizing agents steam is considered the best for boilers, air from a positive blast blower for furnaces where heat of medium intensity is required, and air from a compressor for small furnaces. These are opinions not held universally as regards boiler furnaces.

The Billow Atomizer (Fig. 44) is designed to vaporize the greatest amount of oil with the least expenditure of energy, is automatic in its operation within a 5 per cent. steam variation. It is of a form which it is claimed precludes the possibility of choking, clogging, dripping or the wasteful use of steam, air or oil. It is self contained. The fuel and the atomizing agent are controlled within the burner. It has ground joint union pipe connexions placed on an axis transverse to the body, a

feature which permits the flame to be directed as desired. It has a wide range in adjustment, and will vaporize a few drops of oil per minute or many gallons per hour. It is constructed with various shaped nozzles or outlets of the retort type, when desired, but these are not recommended on account of their wasteful steam or air consumption. Only in special

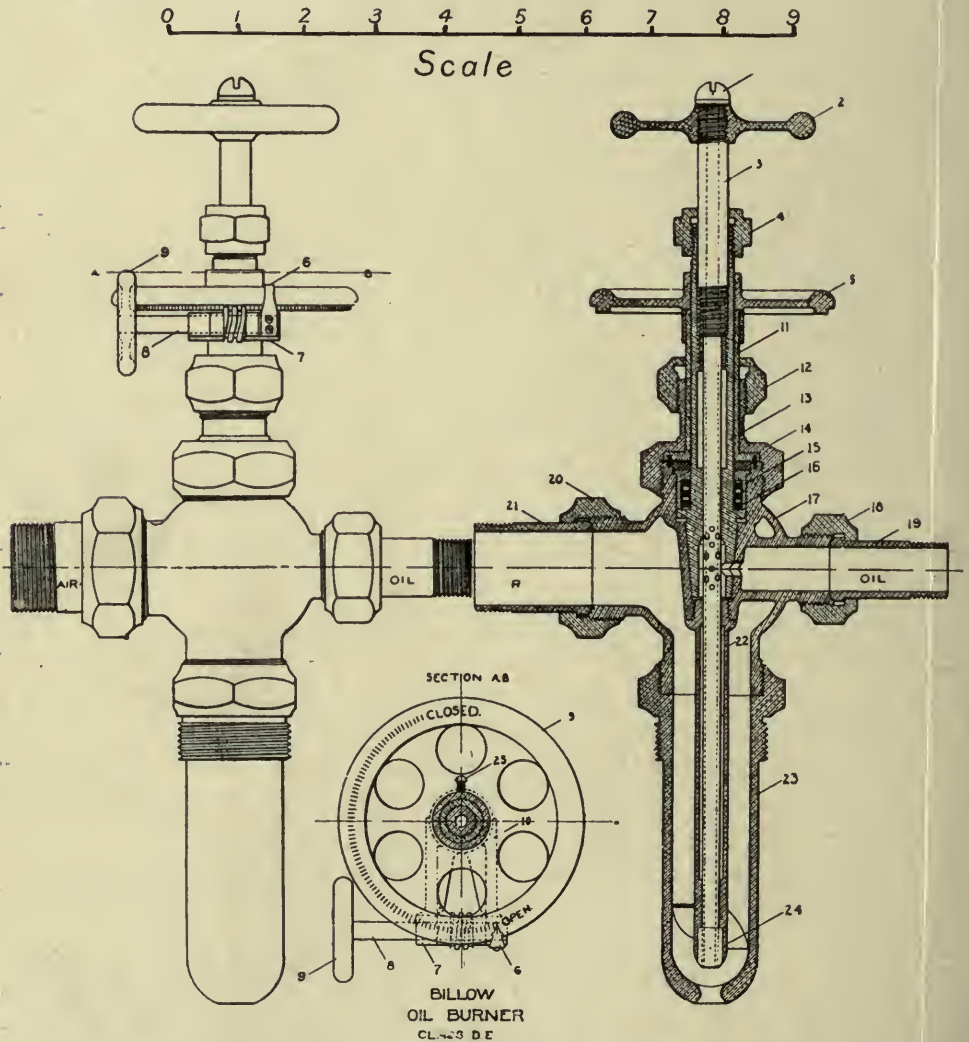

Fig. 44. ATOMIZER. BILLOW SYSTEM.

instances should atomizers other than those with annular openings be employed.

Fuel Oil Pumping Systems.

In America oil is pumped to the atomizer, not gravitated. The system for oil handling and control between the storage

tank and the atomizers is an important factor. This system is designed to heat the oil, free it from mechanical impurities, and deliver it to the atomizer at a constant pressure and temperature under the control of the operator. The amount of oil necessary for feeding the atomizers should be automatically controlled, and the system sufficiently flexible to pump the oil to one atomizer or any number within its capacity without useless expenditure. It should handle all grades of oil fuel equally well.

Residuum, or manufactured fuel oil, often contains particles of coke and sand. All grades may have dirt and other matter which disturb the adjustment of the atomizers at the furnace door, necessitating their frequent cleansing. These impurities clog the feed lines, necessitating frequent blowing-out. An oil pumping system provides against this by filtering out these accumulations and cleaning the filtering medium without disturbing the continued performance of the pump.

Feeding the oil at a temperature nearly approaching the point of distillation ensures speedy vaporization, with a resultant flame soft and diffusing, and not sharply impinging upon the boiler surfaces. The pumping system is designed to give the desired heat, and is provided with automatic governing valves to ensure uniform delivery.

The National Supply Co. have designed oil fuel pumping systems for modern fuel oil non-gravity equipments. They are compact, and so dripped and drained that no oil can reach the floor.

Any oil fuel produces the best results when heated to a temperature just under its distilling point, and oil is atomized with less energy when heated to such a temperature and delivered under constant pressure.

When air is used as an atomizing agent, carbonization is not liable to occur at the outlet of the burner in the furnace because the oil is passed through water heated with exhaust steam in the receiver, and minute quantities of water vapour are carried over with the oil and prevent carbonizing.

Double Pumping System.

These oil pumping systems (Fig. 45) consist generally of two duplex steam pumps, specially brass fitted for oil, and of a cast-iron receiver, tested to two hundred pounds pressure, mounted on a cast-iron drip pan and base frame upon which the mechanism is fastened. A partition divides the receiver into two chambers. Projecting into the rear chamber and screwed

to the partition are tubes with fine gauze heads, accessible through the rear head of the receiver. These heads act as a straining medium, and there is a blow-off pipe and valve for removing deposit.

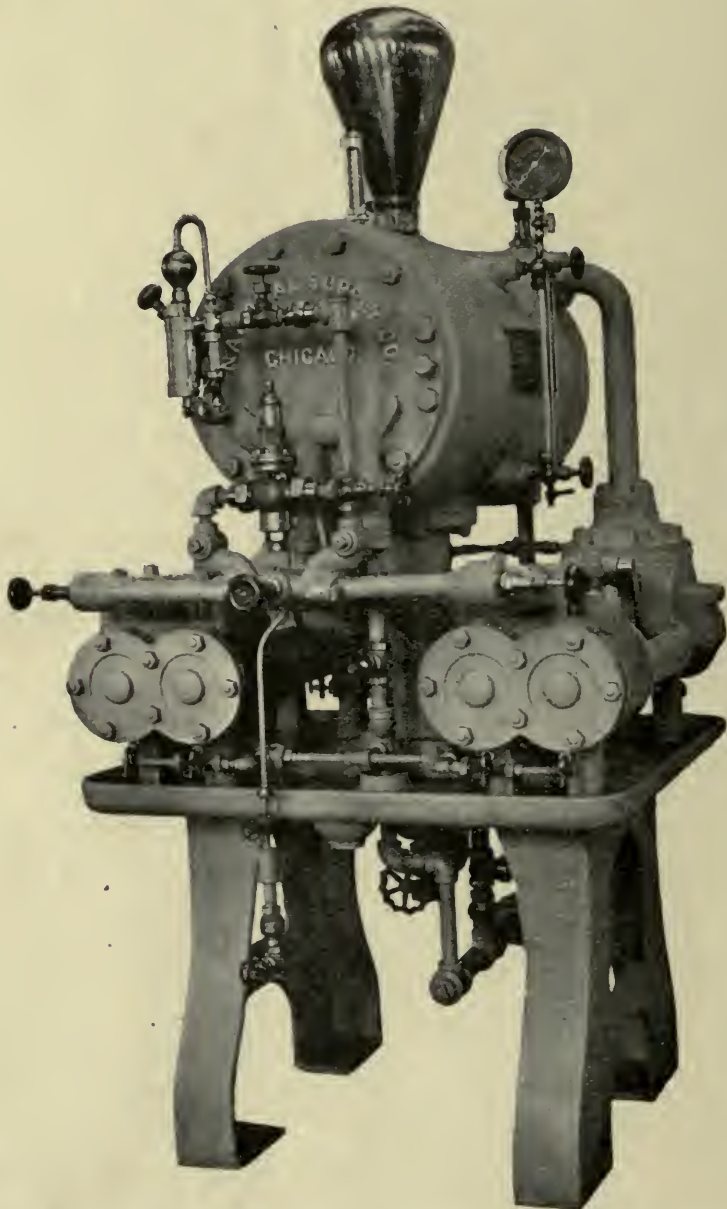

Fig. 45. DOUBLE PUMPING SYSTEM. CAPACITY, 1_ to 5,000 BOILER H.P.

The forward chamber is usually two-thirds full of water, and contains a coil of pipe through which flows live steam or exhaust steam from the pump. The coil has controlling valves, permitting the use of steam from either of these sources or both at the same time.

One pump is in reserve against contingencies or accident to the other.

The apparatus is provided with a pump governor, or regulator, actuated by the pressure in the receiver to maintain a constant pressure on the oil in the receiver ; an adjustable relief valve placed between the suction and the delivery side of the pump through which all oil in excess of the requirements of the

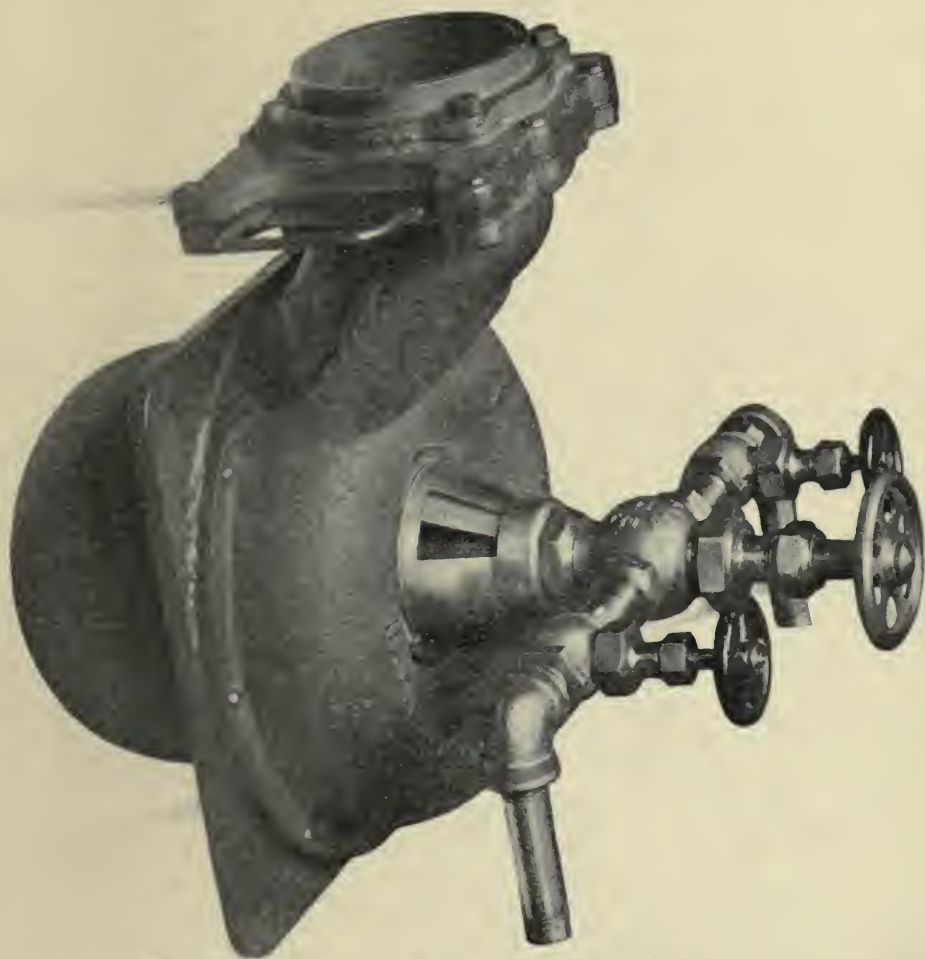

Fig. 46. COMPOUND TUYERE FOR AIR ADMISSION.

atomizer may pass in case of accident to the governor ; a thermometer, steam, oil, pressure, and automatically closing sight gauge.

The oil is discharged through the force chamber of the pump into the forward chamber. The oil flowing through the hot water becomes heated and passes out through an inner tube to the point of consumption.

These pumping systems are made up to sizes of ten to eighteen thousand boiler horse-power.

Thus No. 5 Double, employing two $5\frac{1}{4}$ -in. by $3\frac{1}{2}$ -in. by 5-in. duplex steam pumps, has a capacity of five to fifteen thousand boiler horse-power, or twenty to forty gallons per minute.

In attaching fuel oil atomizers to furnace or boiler fronts it is sometimes necessary to admit all the air for vaporization

and combustion at the atomizer, for the reason that at no other point can a sufficient amount of air be induced into the furnace to complete combustion, owing to conditions of draught or construction. The device of Fig. 46 answers this purpose, by providing the air for combustion irrespective of the atomizing agent used. This air for combustion is intimately mixed with the oil at the point of admission into the furnace. It is intended for boilers where oil is burned as an auxiliary to some other form of fuel, making it impossible to dispense with the grate bars, and is therefore useful in connexion with the burning of bagasse, sawdust and material of like character. It is also the form used aboard vessels that employ water tube boilers.

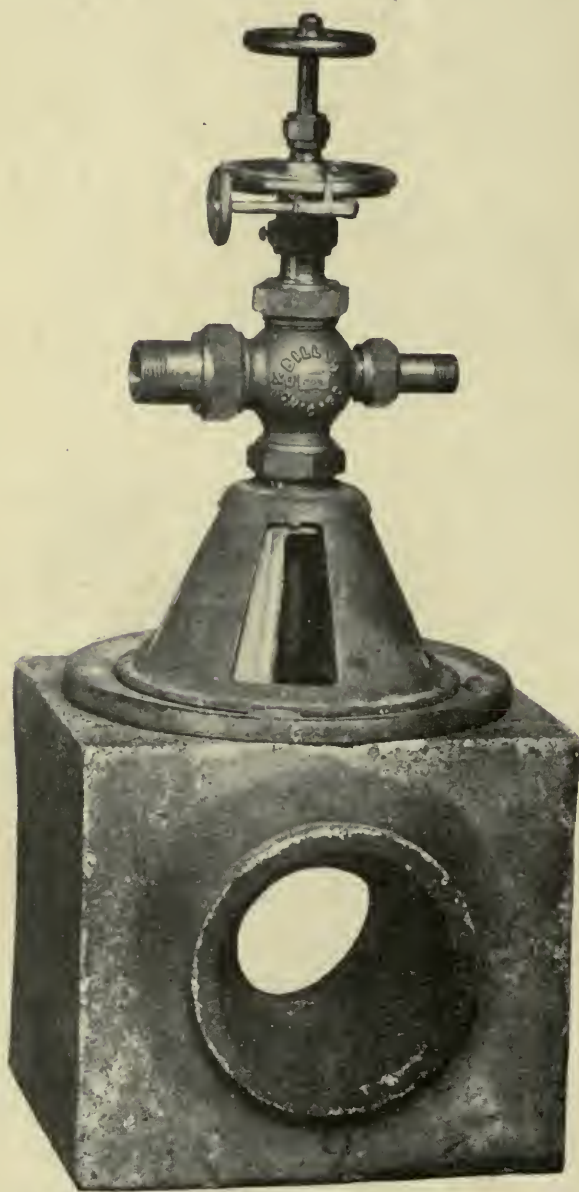

Fig. 47. AIR REGULATOR, ATOMIZER AND TUYERE BLOCK FOR FURNACE FRONT.

The tuyere or air regulator attached is shown enlarged in Fig. 47, the outer part being revolvable so as to close the air slots and regulate the air admitted round the atomizer. These

duplex pump, having $3\frac{1}{2}$ -in. steam cylinder, $4\frac{3}{4}$ -in. oil cylinder, and a 5-in. stroke. This pump has a 3-in. suction and a $2\frac{1}{2}$ -inch discharge.

From the stand pipe header the oil is conveyed to the oil atomizer loop, by two No. 5 oil heating and circulating systems, set upon the boiler room floor. These automatically maintain a uniform pressure and temperature, and a constant flow of oil. They consist of a battery of duplex pumps with $5\frac{1}{4}$ -in. packed pistons having $3\frac{1}{2}$ -in. oil cylinders, a 5-in. stroke, a $2\frac{1}{2}$ -in. suction and a 2-in. discharge. Each pump has a copper air

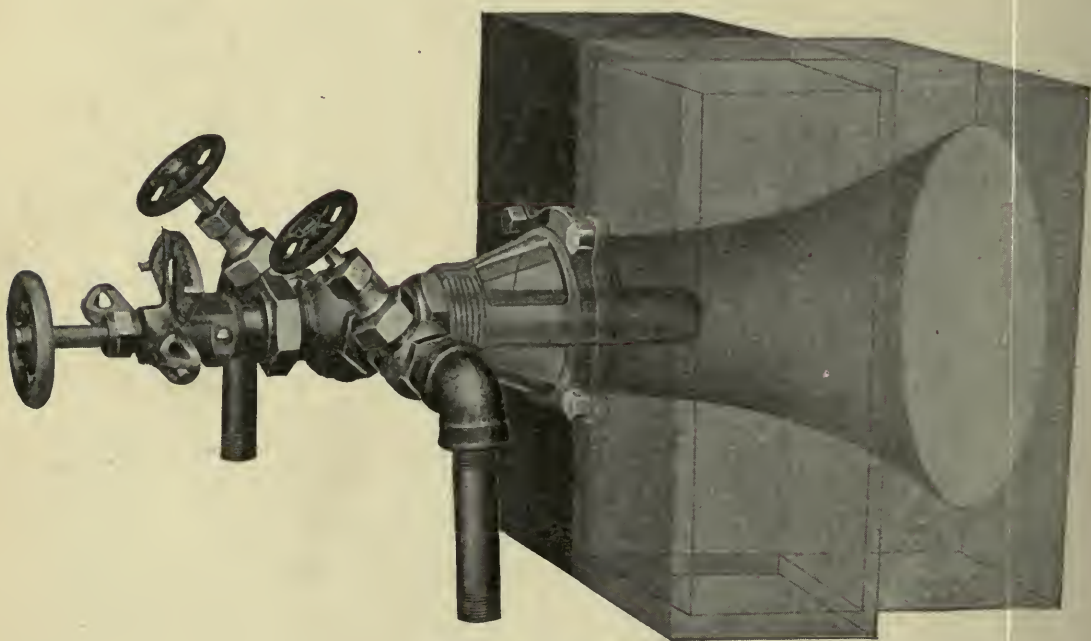

Fig. 49.

chamber and is mounted on a cast-iron base and drip pan, to dispose of all leakage of glands. The base is attached to a cast-iron frame, supporting one combined steel receiver, heater and condenser, 24 inches in diameter, and 36 inches high, surmounted by the 7-in. copper air chamber 24 inches high. The receiver has two diaphragms riveted to its shell, and expanded full of tubes (125 1-in. boiler tubes, having their ends caulked and beaded), around which passes the exhaust from the pumps. The receiver also has provision for the introduction of water, through which the fuel oil flows, under a high pressure, for the purpose of breaking it up, in order that all foreign substances may be precipitated; the oil passing through the heated tubes is thoroughly cleansed, and deposits water and settlings.

The drips from the pumps receiver, drip pans, and exhaust have catch basin connexions.

The whole system is as nearly automatic in its action as is desirable, and is duplicate throughout.

Each system is capable of delivering sufficient fuel oil to develop 15,000 horse-power, and occupies a floor space of 30 sq. ft., and is 8 ft. in height.

Four atomizers are placed in the combustion chamber of each boiler, or a total of sixty-four oil burners compose the installation. These oil burners receive their oil from a loop, beneath the boiler room floor, which is divided by valves into five distinct headers.

The furnaces are erected upon the grate bars of an Acme stoker, and consist of a series of fire-brick flues for heating and circulating the incoming air, chequer work for distributing flame, and baffle walls for directing same.

Oil at the same uniform pressure and temperature can be delivered to a single burner or to the entire sixty-four.

Furnace Construction.

“Too often it happens that complete combustion is impaired not from the lack of air, but on account of the method of its introduction into the furnace, often from such points as to render it ineffective, producing losses as great as 50 per cent. For economic reasons no more air should be supplied than is necessary.

“During the early stages of combustion of any fuel the gases of a highly volatile nature distil at a low temperature, rise rapidly, hug the boiler, enter the tubes or flues and pass away unconsumed. The combustion chamber should therefore be arranged with fire-brick, so that the incoming air may be heated to the required temperature, the flames retarded, diffused, and distributed, and the velocity impeded. There will be no concentration or localization, and the danger of blistering or burning is avoided.

“The furnace construction varies according to the type of boiler or furnace. The question may be asked, ‘Will an apparatus work if no change is made in the combustion chamber or furnace of a boiler other than that of covering the grate bars?’ A furnace so arranged will not average so high economical results as when constructed for diffusing the heat and retarding the flow of the gases. Fuel oil appliances can only vaporize the oil; in the furnace it is consumed. Therefore the statement is not unreasonable that a scientifically

arranged combustion chamber with a shovel to feed the oil is preferable to a poorly constructed furnace to which is attached the highest type of atomizing device.

Operating a Fuel Oil Plant.

“The results to be secured from a properly designed fuel oil plant depend largely upon the amount of intelligence exercised in its manipu'ation. All the mechanism that can be supplied, outside of the furnace, is designed to perform the single function of delivering the oil to the furnace in a finely divided, nebulized condition with as little cost to the operator as possible, and to give insurance against accidents or possible shut-downs, with ease and facility in manipulation. Other economical results depend wholly upon the draught. This should be regulated by the ash-pit doors, or other proper means. The flame may be increased or diminished at will by the simple opening or closing of a valve, but it is only by experiment or long-continued contact with fuel oil that the oil, the atomizing agent, and the air necessary for combustion will be properly combined and the beneficial results of this combination be obtained. The operator should continue the opening and closing of the ash-pit doors, or the manipulation of the damper and the increasing or diminishing of the flame until he can produce a fire large or small, without the least indication of smoke. When this condition is attained he will have no more occasion for handling any of the apparatus provided the elements of combustion are perfectly balanced.

“The gases should not pass from the furnace at two high a temperature. This can be controlled and regulated largely by the damper. A clear flame consumes less oil than a smoky flame, and has greater efficiency. Smoke is evidence of imperfect combustion, but the absence of smoke does not necessarily prove that perfect combustion is being attained. Too much steam produces a light grey vapour ; too little, a smoky flame ; too great a draught, an intensely vibrating flame accompanied with a roaring noise ; too little draught produces a dull red smoky flame. When the elements are properly united the result is a reddish orange flame.

“The temperature of the escaping gases from a boiler will increase as the excess of air becomes greater, provided the same amount of fuel is being burned. This is because the furnace temperature is less, owing to the greater amount of air present which results in a less rapid transfer of the heat to the boiler and consequently allows more heat to escape to the chimney.

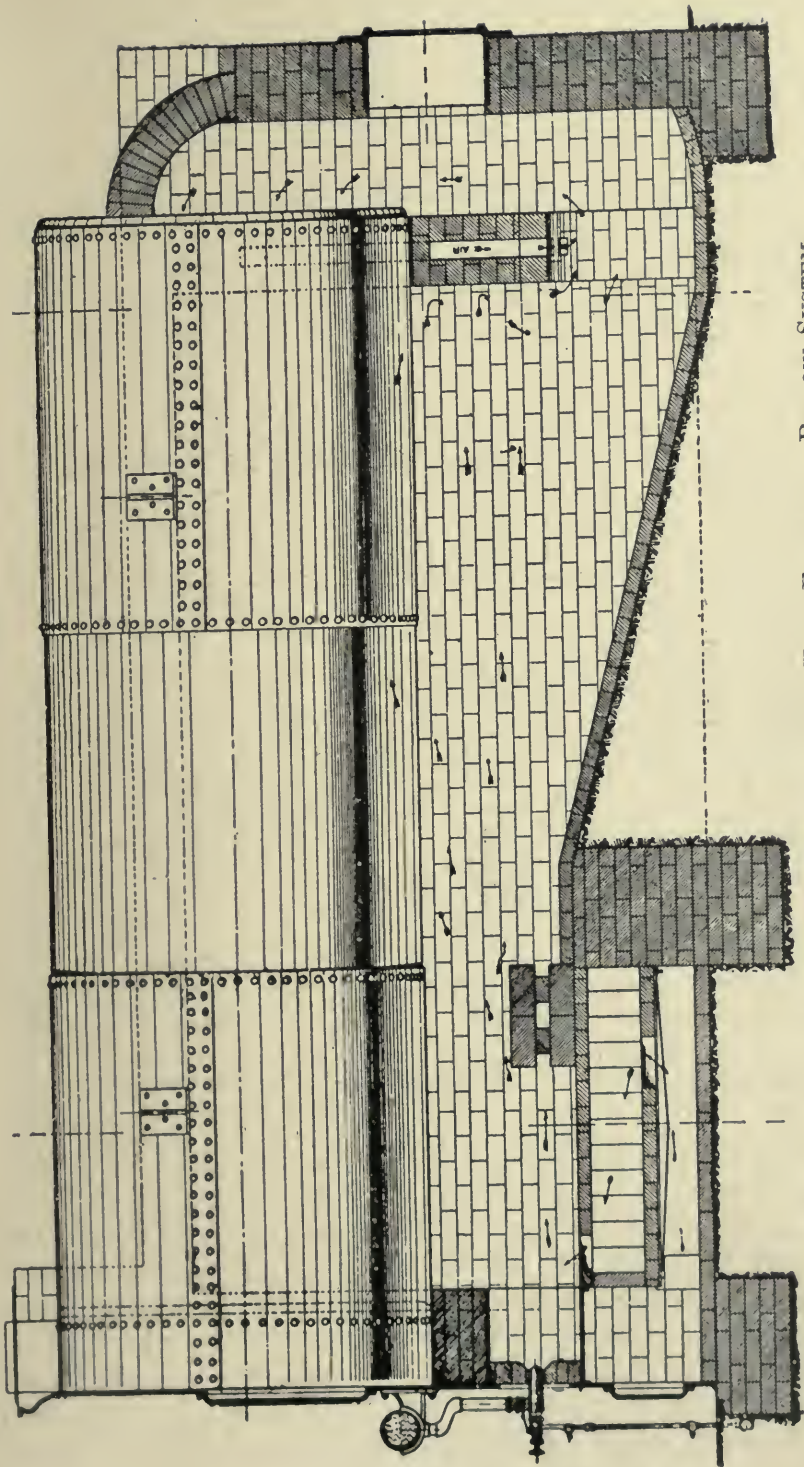

Fig. 50. UNDER-FIRED BOILER WITH LIQUID FUEL FURNACE. BILLOW SYSTEM.

“On the other hand, with a uniform excess of air, if more fuel is burned, the temperature of the escaping gases will increase, owing to the heat produced being greater in proportion to the absorbing capacity of the boiler.”

It is only through close application that the theory of oil burning can be fully understood and mastered and as high an efficiency as 80 per cent. of the theoretical value of the fuel transmitted from the furnace to the boiler. Mr. C. O. Billow has designed furnaces for many types of boilers. Fig. 50 is the ordinary American under-fired tubular boiler with the bars replaced by a fire-brick air casing, through which air flows to

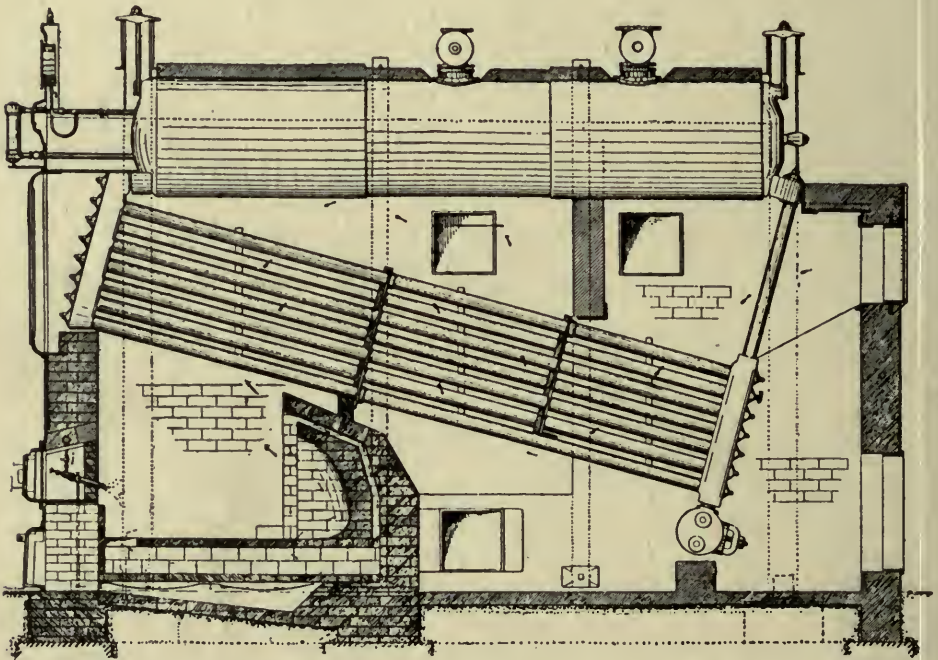

Fig. 51. WATER-TUBE BOILER. BILLOW SYSTEM.

the furnace through the “ash-pit” door and comes up under the atomized jet. The furnace widens out laterally from front to rear, the atomizer being placed at the narrow end of this brick furnace. The grate bars are ten inches lower than usual, and the air casing of brick occupies this ten-inch space. The ash-pit doors regulate the air admission. The atomized oil is directed upon the chequer work brick bridge, which breaks up and diffuses the flame throughout the furnace and directs it upon the boiler. A hanging bridge is placed at the extreme end of the combustion chamber. If too little air has been admitted at the front, a further supply is let in through this rear bridge, which also serves further to retard the flow

of the hot gases. Either steam or air may be used as the atomizing agent, and though air is the more efficient, the cost of the air compressor detracts from its advantage, but a good compressor saves steam. Mr. Billow considers that steam atomizing should be done with 3.3 per cent. of the total steam; that a positive air blast blower will only use 1.36 per cent. of the boiler output, but when air is compressed above 30 pounds absolute, it costs 6 per cent. with ordinary compressors. Hence the importance of good compressors. The same system is carried out in the ordinary water-tube boiler (Fig. 51). This furnace is applicable to the many forms of water-tube boiler. The same grate cover of fire-brick is employed, but the bars

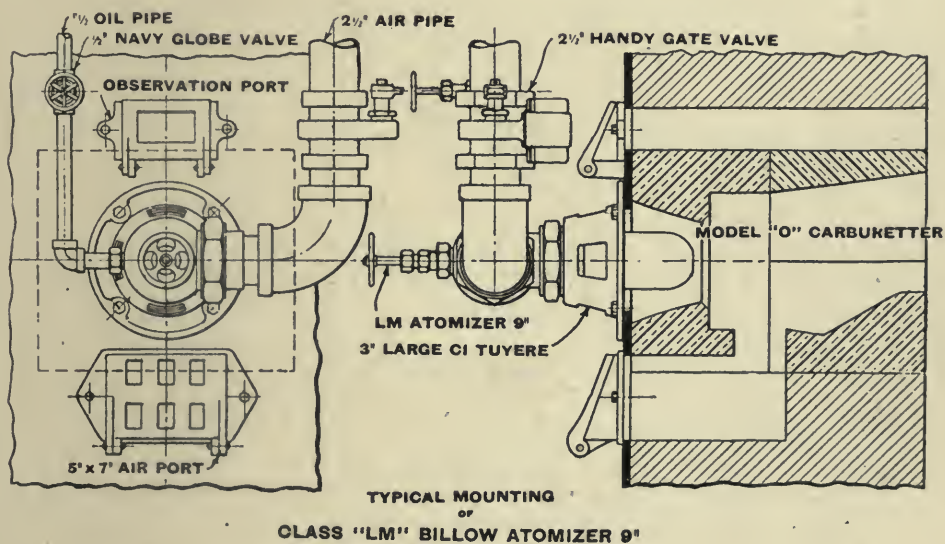

Fig. 51a.

are lowered considerably to provide room for the concave bridge, which is also split to admit air. The burner points somewhat down so as to strike on the brick floor at about half length, the flames curving round the bridge hollow.

It may be added that for English practice the containers of oil pumping systems, if employed in preference to gravity feeds, of Fig. 45 type should be of boiler plate and not of cast-iron—a material, the use of which for pressure work, and especially for pressure work with liquid fuel, is considered indefensible, and would probably not be passed as safe by the English boiler insurance companies. Fig. 51a shows a typical boiler mounting on the Billow system.

CHAPTER XIII

ENGLISH STATIONARY PRACTICE WITH LIQUID FUEL

The Kermode System.

IN this system air at low pressure is the atomizing agent, the air being heated in a thick retort pipe, which is carried round the furnace or uptake.

Oil gravitates from an overhead tank, as very usual in marine work. It flows thence by a $1\frac{1}{4}$ -in. pipe to the furnace front and separates to the two burners by equal branching pipes. Where two burners are supplied off one pipe the branches to each must be symmetrically arranged in order that equal supplies of oil may reach each burner.

The illustrations represent one form of the furnace arranged by the Wallsend Slipway Co. for this system, the lower part of the marine furnace being filled with special fire-brick blocks through which air enters the furnace beneath the flame. These blocks are covered with asbestos lumps similar to the ordinary grate of Fig. 53, which shows an alternative arrangement including also an oil heating pipe in the furnace in addition to the air heating pipe.

The accompanying table of tests and copy of analysis of Borneo oil are given from results of trials at the Wallsend Company's Works—

COPY OF ANALYSIS BY DR. GEORGE TATE, F.I.C., F.G.S.,
NOVEMBER 9, 1899.

Sample.	Astatki.	Borneo Crude Oil as received.	Borneo Crude Oil dried.
	p. c.	p. c.	p. c.
Water	trace	11.75	
Carbon	79.92	73.60	83.40
Hydrogen	12.00	9.08	10.29
Oxygen and undetermined elements	8.08	5.57	6.31
Total	100.00	100.000	100.00
Calorific power in B.Th.U.	18.434	15.894	18.010
Equivalent evaporative power	19.0 lb.	16.4 lb.	18.6 lb.

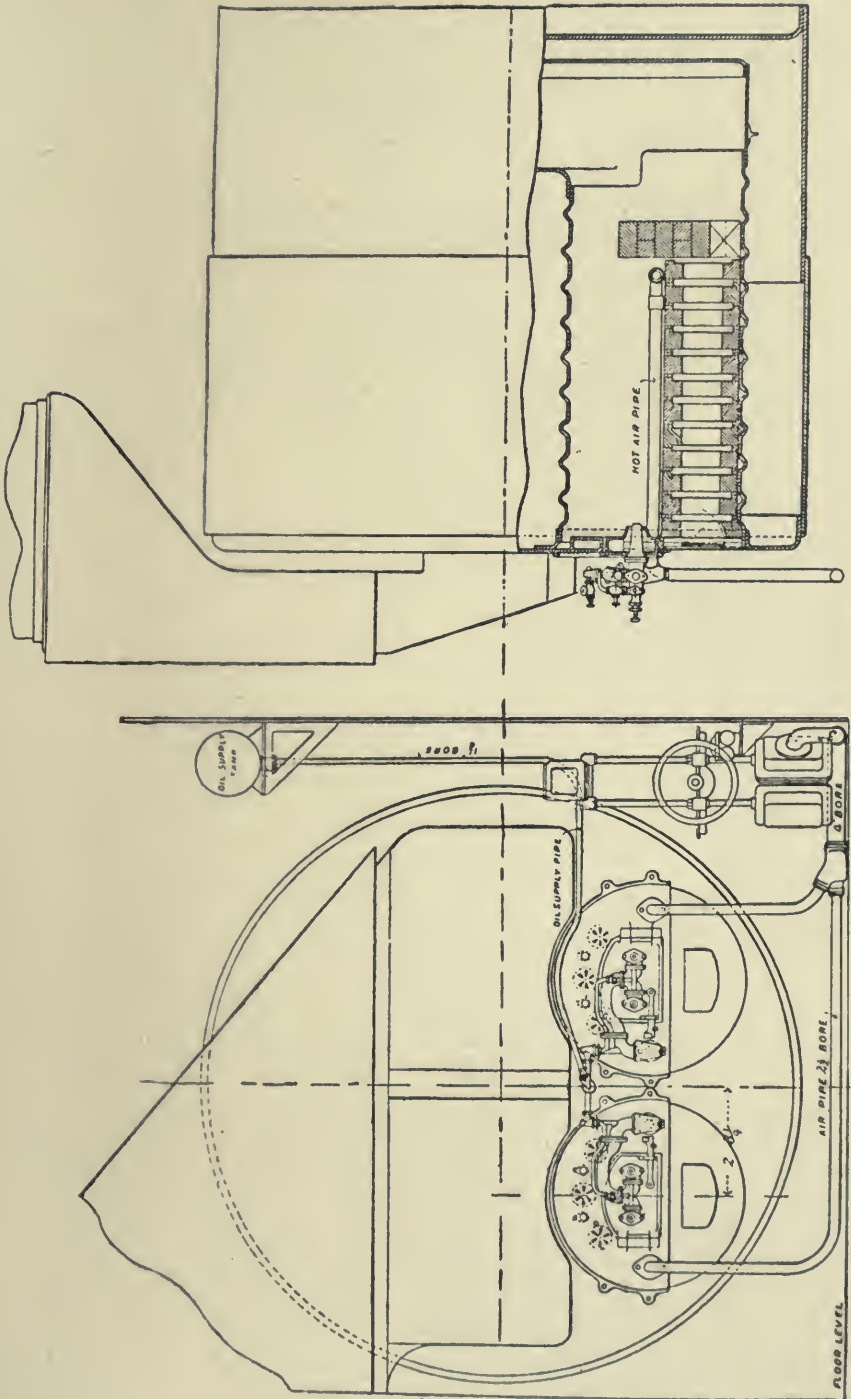

Fig. 52. LIQUID FUEL FURNACE. KERMODE'S SYSTEM.

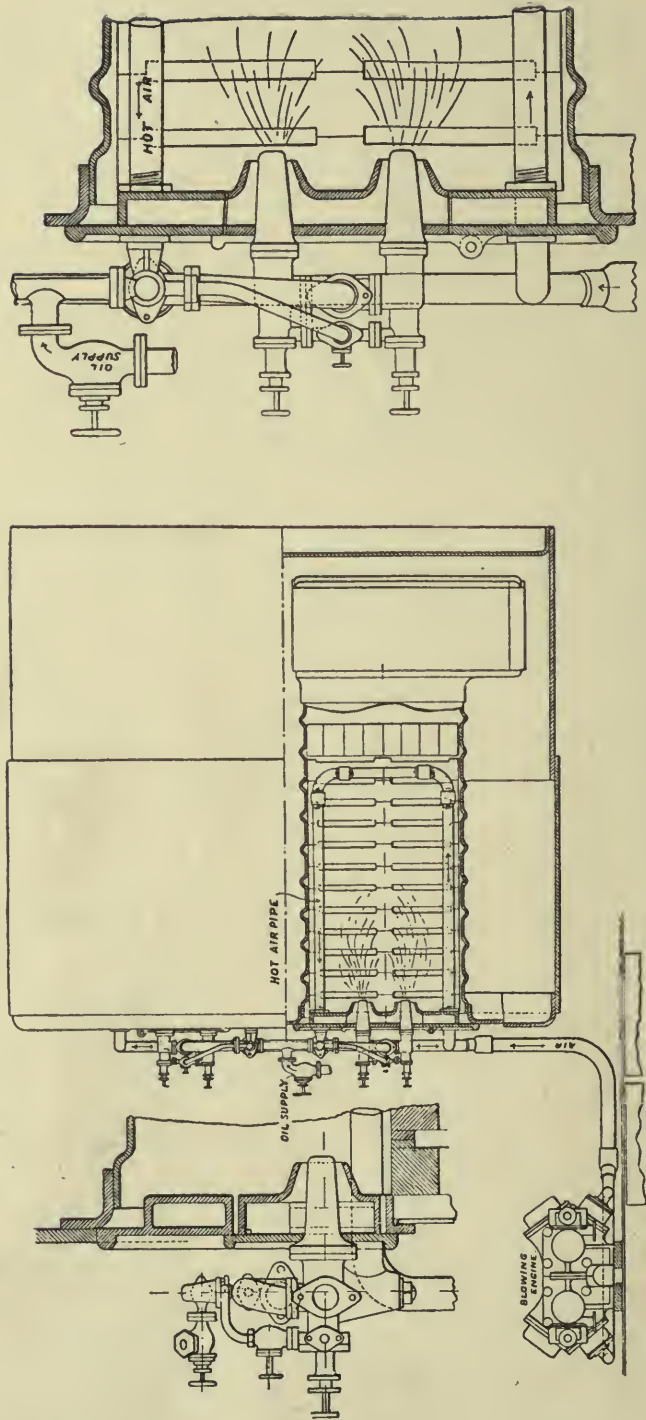

Fig. 52a. ENLARGED DETAILS. KERMODE'S SYSTEM.

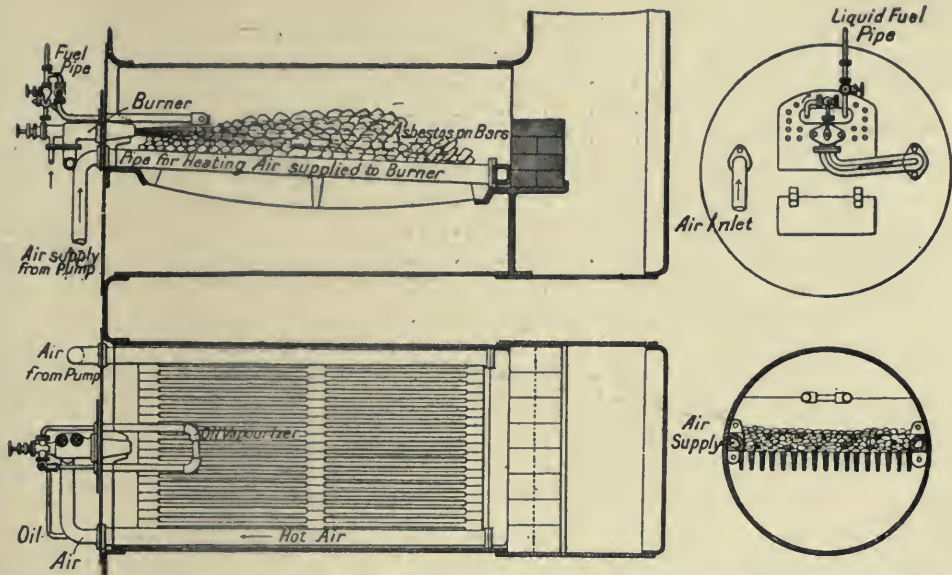

Fig. 53. LIQUID FUEL FURNACE. KERMODE'S SYSTEM. ALTERNATIVE ARRANGEMENT.

Date of Trial.	Sept. 6, 1899.	Sept. 14, 1899.	Sept 10, 1899.	
Duration of trial	3 hours	4 hours	2 hours	
Class of oil used	Borneo crude	Borneo crude	Borneo crude	
			First hour	Second hour
Mean pressure on boiler, lb. . .	111	110.5	109.8	110.4
Total lb. of water evaporated .	24,161	35,323	9362.5	9511
Pounds evaporated per hour . .	8053.7	8830.75	9362.5	9511
Pounds of water per pound of oil	11.1	10.9	10.93	10.92
Ditto from and at 212°F.	12.9	12.75	12.85	12.84
Mean temperature of feed water deg. Fahr.	89°	89°	83°	83°
Temperature of oil in measuring tank, deg. Fahr.	68°	68°	67°	67°
Total gallons of oil consumed . .	225.3	337	88.8	90.2
„ pounds of oil consumed	2174	3244	856.5	870.3
Gallons consumed in 1 hour . . .	75.1	84.2	88.8	90.2
Pounds consumed in 1 hour . . .	724.7	811	856.5	870.3
Pressure on oil at burner pound.	4.3	4.3	4.3	4.3
Specific gravity of oil965	.965	.965	.965
Temperature of uptake deg. F. . .	650°	665°	720°	720°
Smoke at funnel top.	Light brown	Light brown	Light brown	
Air pressure in burner, pounds	3.2	3.2	3	
Revolutions of blowing engine . .	310	350	320	
Pounds of oil per sq. ft. of grate	18.1	20.3	21.5	
Pounds of water per sq. ft. of heating surface	4.75	5.5	5.5	

7.5 per cent. of water in the oil is allowed for in the above results. This seems rather excessive, but probably explains the results.

The boiler had the following dimensions:—

Mean diameter.	12 ft. 6 ins.
Mean length	11 ft.
Two furnaces	3 ft. 7 ins. inside diameter.
262 tubes $2\frac{1}{2}$ ins. external diameter, 8 feet between tube plates	
Heating surface of tubes	1,372 sq. ft.
Furnaces	123 „
Combustion chambers.	125 „
Tube plates	75 „
Total	1,695 „
Grate area of one surface.	20 „
Diameter of chimney	5 ft.
Height from bars	55 „

The burners are arranged so as to be readily swung back when coal firing is to be resumed, and there is very little change to the furnace in the system of Fig. 53. Probably the light smoke which is made might be reduced by the use of somewhat more fire-brick in the furnace or combustion chamber.

Tests made at Birkenhead are said to have shown an evaporation as high as 15.5 pounds from and at 212°F. per pound of Russian astatki and without smoke. Borneo oil is credited by Dr. Tate with less hydrogen than usually is found in petroleum fuels, the average formula apparently being C_7H_{10} . The latest burner for this system is described under the head of atomizers, Fig. 68.

The remarkable thing in this system is the satisfactory results obtained with only 3 pounds of air pressure, but it must be noted that this air is highly heated. The above trials, made many years ago, show what improvements have since been made for to-day (1911).

The following figures show the results which can be obtained on a steam boiler fitted with any one of the three systems of atomization used in the Kermodé system.

Oil fuel, which has a theoretical calorific value of 19,320 British thermal units per pound, is capable of evaporating 20 lb. of water from and at 212° F. (theoretically) for every pound of oil consumed, and if the air-jet system is used, from 15.6 to 16.6 lb. of water can be evaporated per lb. of oil consumed under practical working conditions. That is to say, from 78 per cent. to 83 per cent. of the theoretical calorific value of the oil is recovered for useful work.

The pressure-jet system will recover from 70 per cent. to 75 per cent. of the theoretical calorific value of the oil fuel used in actual practice. That is to say, with oil fuel of 19,320 B.Th.U.'s

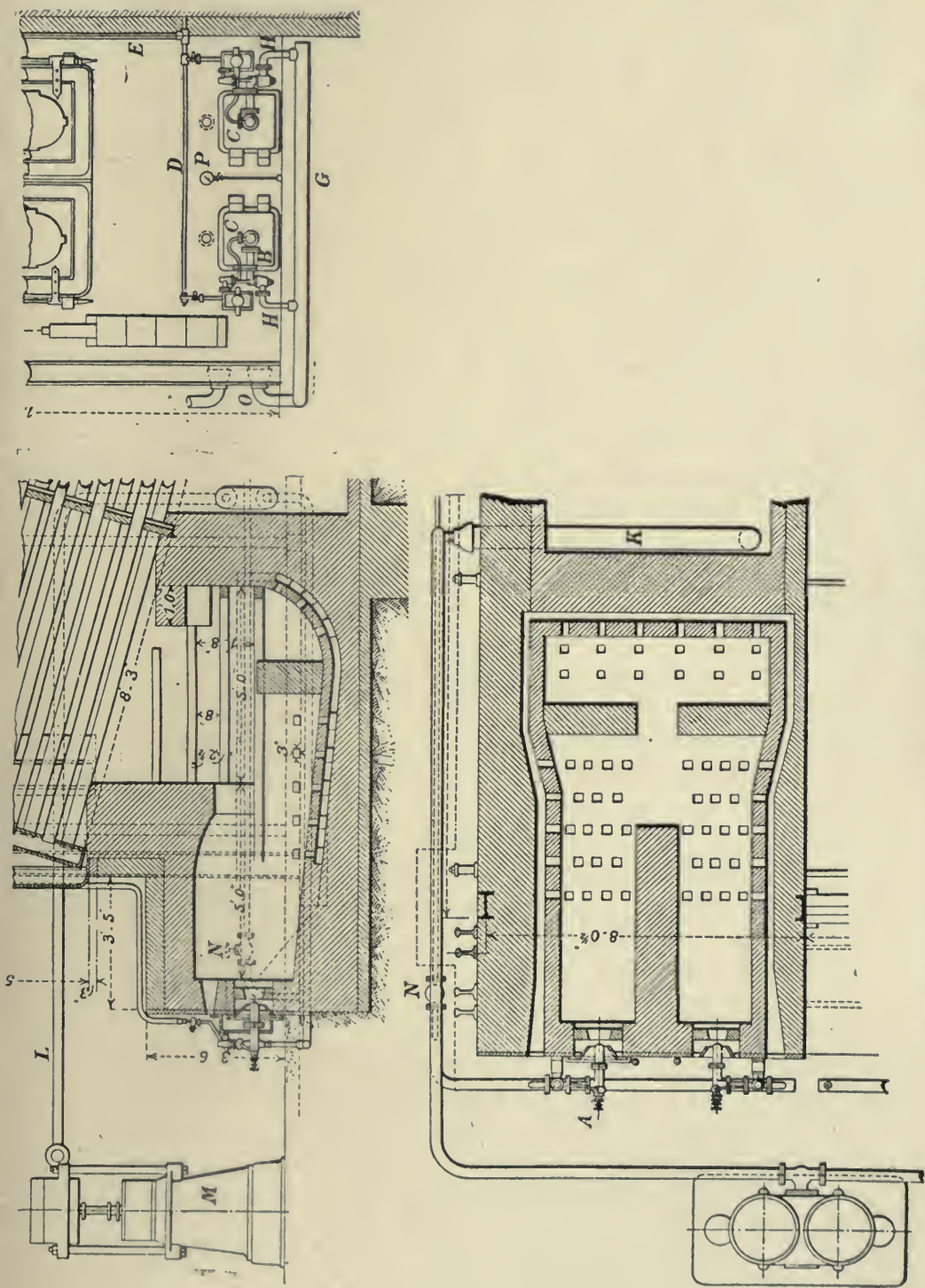

Fig. 54. BABCOCK BOILER WITH KERMODE'S OIL-BURNING SYSTEM.

per lb., the evaporation per pound of oil consumed would be from 14 to 15 lb. of water per lb. of oil consumed.

The steam-jet system will recover from 68 per cent. to 74 per cent. of the calorific value of the fuel used, or a pound of oil fowl will evaporate from 13.6 to 14.8 lb. of water.

For dealing with the by-product (tar) from the Mond Gas power plant, the Kermode system converts a hitherto useless refuse to liquid fuel, and by this means an enormous saving is effected in the fuel bill of Mond Gas plants.

The Kermode system embraces all three methods of atomization by air, by steam and by oil pressure, without other agency, the oil spraying itself by its own energy. An example of each type of sprayer will be found in the chapter on atomization.

In Fig. 54 is shown a recent Kermode furnace as arranged under a Babcock boiler, on a test of which 13.32 lb. of water is stated to have been evaporated at 100 lb. pressure from feed at 64.4°F. per lb. of oil, the efficiency being 79.65 per cent.

The burners themselves are shown at A, the air pipes at B, the oil-pipes at C, the oil-main at D and E, the air-mains at G, from which the branch-pipes A go to the burners, and the air-compressor at M, from which the air passes along the pipe to the heater K. An air by-pass valve is shown at N, and air-pipes O, O, which lead to the flue and discharge the surplus air when required. The results have quite come up to expectation, for the evaporation from and at 212°F. has proved to be 15.91 lb. of water per pound of fuel, although the oil was not of a very high calorific value.

During test mentioned the water evaporated per hour was at the rate of 1362.5 kilogrammes (3,004 lb.) per hour. The pressure of the air supplied to the burners was 0.7 lb. per square inch, with very slight variations. The temperature of the feed-water was 64.4°F., and that of the liquid fuel 69.8°F. The amount of oil consumed during the eight hours' test was 1,801 lb., and the total amount of water evaporated was 23,980 lb. The Kermode system is applied equally to land or marine work, and to fire engines and small work, and any liquid fuel is utilized, notably the tar of the Mond Gas producer.

Numerous large and small vessels of the Navy have been fitted with this system.

The Hydroleum System.

In this system great stress is laid upon the spraying of the oil through a comparatively restricted area or passage upon a

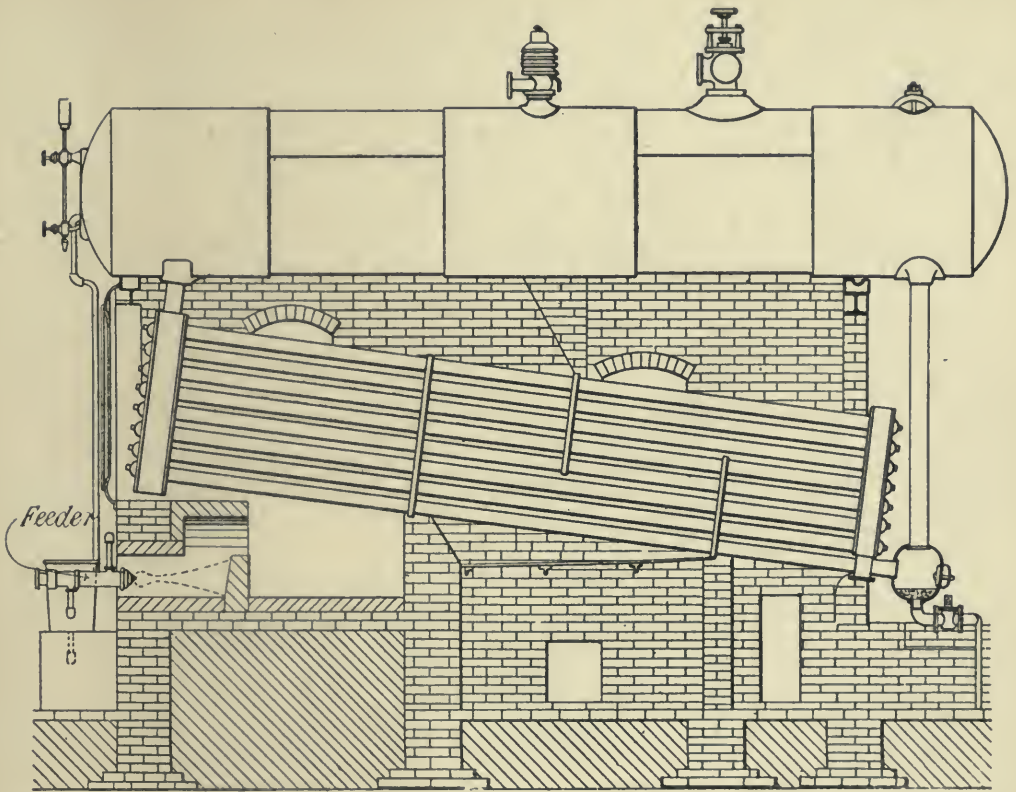

Fig. 55. WATER TUBE BOILER WITH HYDROLEUM LIQUID FUEL SYSTEM.

dash-brick, which, it is claimed, becomes highly heated and vaporizes the spray. This is shown in Fig. 55.

Tested with water gas tar at the works of Messrs. Muirhead & Co., Elmer's End, Kent, the following results were obtained :—

	Oil.	Coke.
Date	Aug. 14, 1901.	May 15, 1901.
Duration of test	2 hours	9 hours
Mean temperature of feed water	70 Fahr.	60 Fahr.
Mean pressure on boiler	90 lb.	90 lb.
Pounds of water evaporated	2,400	10,100
" " consumed	211	1,792
Pounds of water evaporated per lb. from and at 212°F.	13.47	16.73
Price of tar	19s. 0½d. per ton = .102d. per lb.	
Price of coke	21s. 8d. per ton = .116d. per lb.	

N.B.—In making the test the tar was taken as received, no deduction being made for any water it contained.

Comparing these two tests it will be seen that :—

To evaporate each pound of water with coke cost	0.0172d.
To evaporate each pound of water with water gas tar	0.0075d.
Saving by the system of oil firing	0.0097d. per lb.

The burner of this system will be found described under the head of atomizers, but the Hydroleum Company do not profess to atomize. They lay stress upon the use of a dash-brick only about 18 inches in front of the spray nozzle, an intense local heat being developed on the face of the brick. Sufficient air to burn the vaporized oil is induced through the openings provided round the spray nozzle. The sprayer is made in three sizes, having capacities of 1, 3, and 10 to 12 gallons of oil per hour, and the oil is induced to flow by the inductive action of the steam annulus. The feed tank is kept at a level of half an

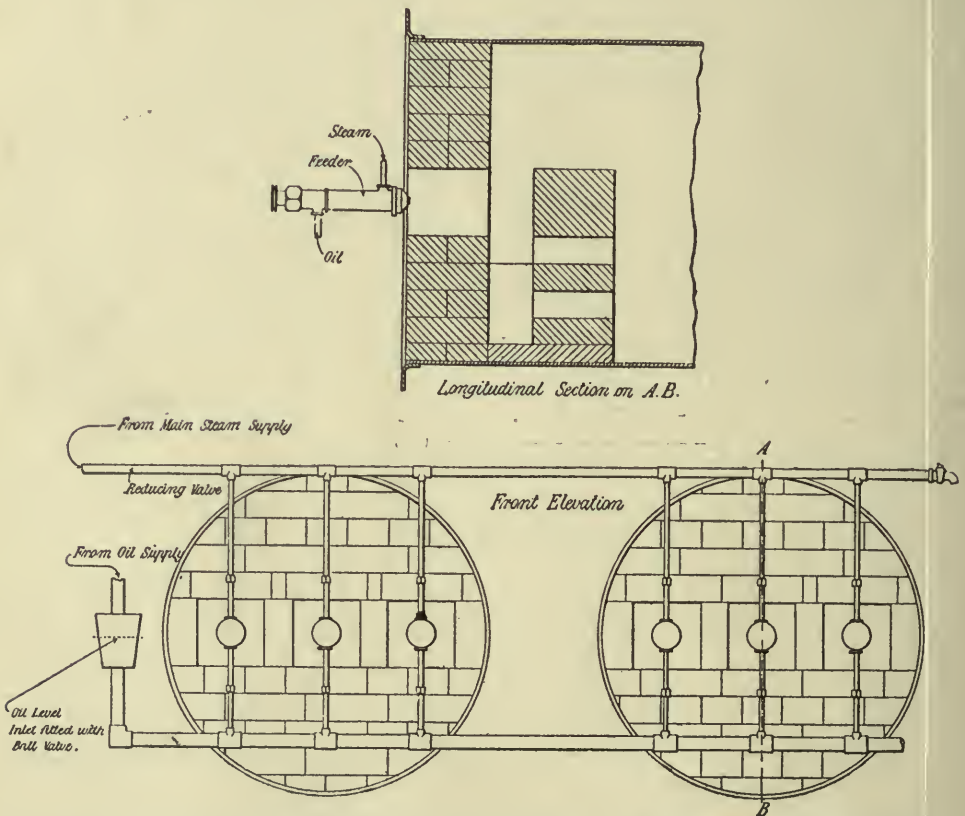

Fig. 56. HYDROLEUM LIQUID FUEL SYSTEM. MARINE BOILER DESIGN.

inch below the nozzle by means of a ball float valve. From 14.5 to 15 pounds of water are stated to be evaporated from and at 212°F. per pound of oil, the expense of steam being 5 per cent. of the evaporation.

Though not claimed as an atomizing system, the Author considers that the effects of the Hydroleum burner sufficiently resemble atomizing for this burner to be held up as an example of the success of the system.

Experience shows that for a burner capable of burning 10

gallons per hour there should be an opening for air round the atomizer of 8" \times 8", which, after deducting the cross section of the atomizer itself leaves sixty square inches of air opening for ten gallons per hour. Worked out on the basis of 15 lb. of air per lb. of oil fuel and 13 cubic feet per lb. the velocity per second of the air stream is only 13 feet. A gallon of fuel is taken as 10 lb., which is about correct for tar. The amount of fuel fed is simply regulated by the amount of steam used, and this draws in more or less air as required by the fuel, and very little regulation of the air inlets is required. A trunk casing is placed round each burner with opening downwards to reduce noise. This gives very effectual silencing. These air trunks may be all coupled to a common air main brought from outside the building. As seen by the Author, burning oil gas tar of Sp. Gr. 1.04 in a Lancashire boiler the system was smokeless and very silent. The Hydroleum atomizer will be found described in the chapter on atomizers.

CHAPTER XIV

THE COMBUSTION OF VAPORIZED LIQUIDS

The Clarkson and Capel Burner.

IN this burner system the liquid employed is preferably the cheaper and commoner qualities of lamp oil. The burner shown (Fig. 57) is one that is fitted to floating fire engines. It is capable of burning 40 gallons of oil per hour and of developing up to 200 h.p.

There is a gas ring to give the initial heat to vaporize the oil. The jets heat the coils to which the oil is fed, and the vapour passes from the coil to the rear of the long casting, which it enters through a small orifice controlled by a needle point. Air is admitted by a door at the back end and the vapour and air are thoroughly mixed in the pipe and issue round the lip of the mushroom valve, where ignition takes place and a large flaring flame of great intensity, is formed, the heat from which now vaporizes the oil in the coil, and the process is continuous. The oil is under pressure in the supply tank, the pressure being generated by an air pump. The pressure forces the oil through the system, and when, in vaporized form, this reaches the jet nozzle, it issues with a high velocity and induces a large flow of air through the valve. The needle of the jet nozzle is worked by the same controlling lever as regulates the cap of the burner. In the course of this lever, which is of compound order, is a maximum and minimum stop that can be regulated to prevent excessive opening or entire extinguishing of the flame. The hand wheel of the larger burner in Fig. 57 shows how this is effected.

In the automobile pattern (Fig. 58) the initial heating device is a spirit trough containing a coil of nickel wire. Petrol or alcohol can be employed. The burner is placed in the cylindrical base of the boiler; the case bottom is perforated for air admission and provided with a door for inspection.

A system of preliminary heating by means of paraffin consists of a series of asbestos wicks provided with an air

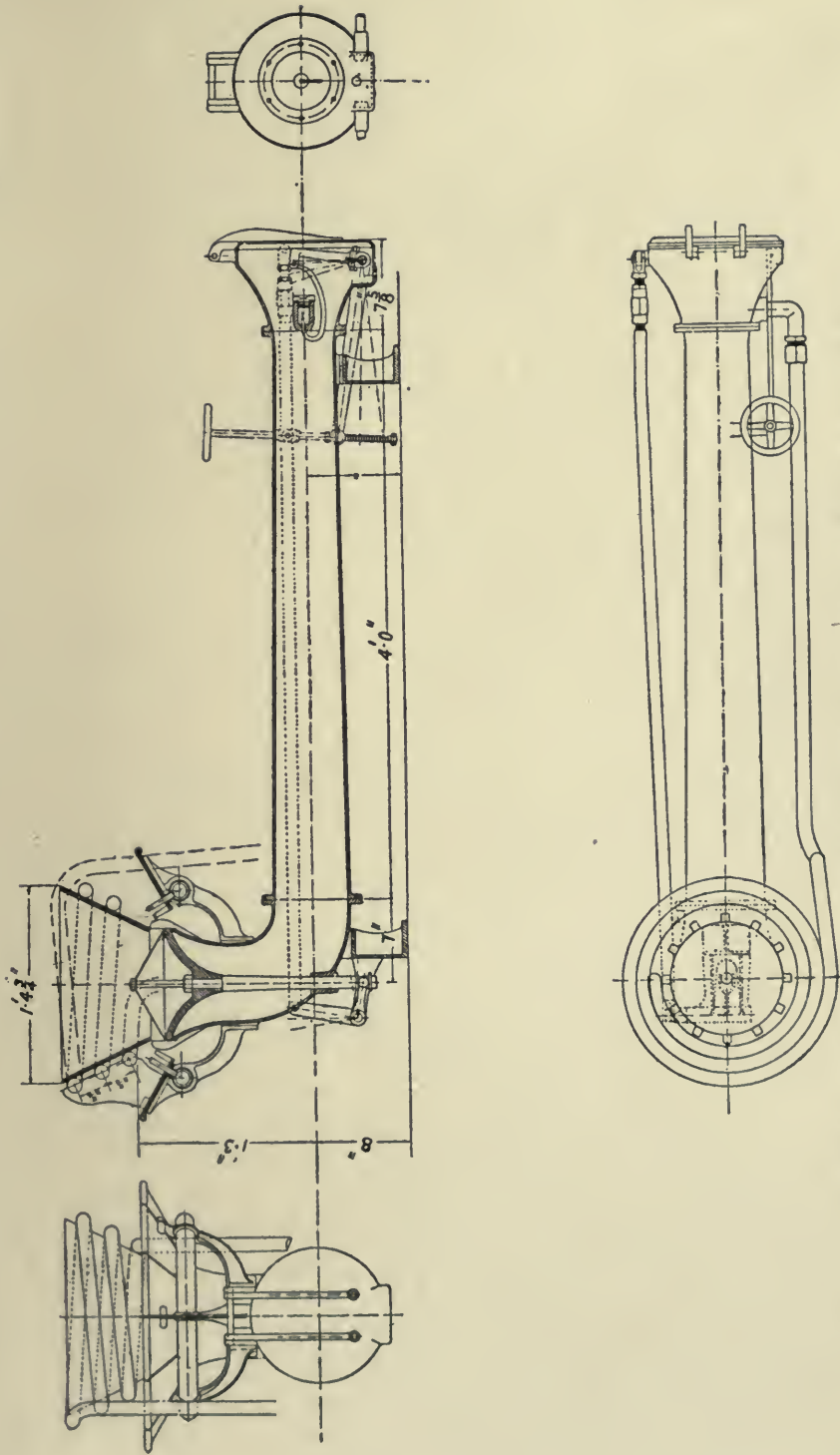

Fig. 57. CLARKSON-CAPEL VAPORIZING BURNER, 200 H.P. FOR FIRE FLOAT.

draught by a small fan and fed with a limited quantity of paraffin from a small cup, the main supply of oil being heated

in the $\frac{5}{8}$ -inch coil. After the cupful of paraffin is finished the flame of the main burner will be burning and will provide heat for further vaporization.

For use in automobiles, small steam-boats, the cheap forms of lamp oil are commercially practicable, though they would be too expensive for ordinary continuous industrial steam raising purposes. For other reasons these oils commend themselves for the purposes of fire engines and fire floats. Here the use of expensive fuel is warranted by the nature of the service, namely, the extinguishment of a fire that may be consuming valuable buildings and their contents. Even the lighter petrols are used for steam raising purposes in certain forms of steam cars, the petrol being sprayed upon a hot cast iron plate through which fine jets of air are introduced and the heat is utilized to raise steam in coil boilers of the

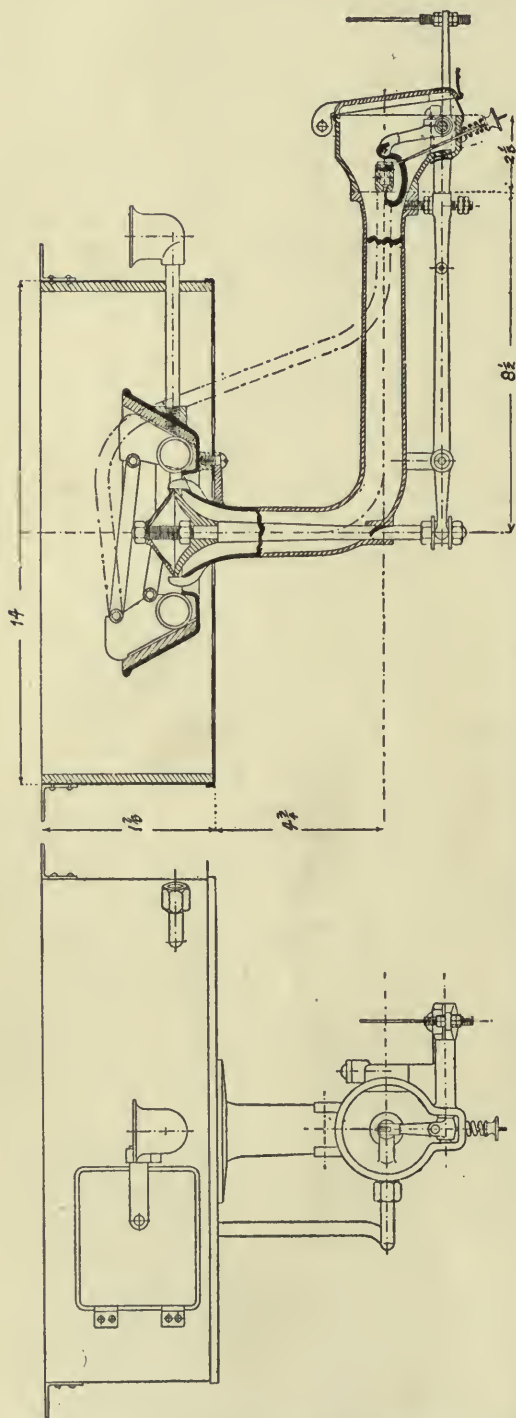

Fig. 58. CLARKSON-CAPEL VAPORIZING BURNER, AUTOMOBILE PATTERN.

flash type into which water is injected to provide the steam for instant use.

In the Clarkson system one pound of oil can be counted

upon to give an evaporation of 10 pounds of water from 80°C., to steam at 200 pounds, or an equivalent evaporation from 212° F. of nearly 11 pounds. The oil receptacle is usually worked at a pressure of 40 pounds, and the cheaper grades of Russian oil are perhaps the most suitable, such as Rocklight, Lustre, etc.

As stated elsewhere, the calorific capacity of all the petroleum products is practically identical, the lighter oils being more powerful because they contain the highest percentage of hydrogen, but the difference is immaterial. The evaporative efficiency of the small boilers of cars and canoes, is less than that of large boilers simply because it is not desirable to load up a car with too great a weight of heating surface.

In the starting device employed on automobile cars, a pad fed with a drop feed of oil is ignited by a match and gives preliminary heat to the burner.

The combustion of petrol is a special case of vaporization before combustion. Petrol has such a low flash point that it is absorbed by air passing over it, with great avidity.

Petrol engines are simply gas engines with electric ignition which use petrolized air. The petrol is fed into a vessel called the carburettor in small quantities by the action of a float, and it is taken up by a stream of air which is drawn through the vessel by the pistons of the engine. The petrol is used as supplied. Petrol being a mixture of different hydrocarbons with each its own flash point, no system of petrolizing of air can be satisfactory where the air is drawn over a mass of petrol, for the air will select first the lighter constituents and leave the heavier behind. In all cases the petrol must be put within reach of the air in small quantities at once, so that the whole portion added is carried off by the stream of air before more is added. The evaporation by the air produces a chilling effect and raises the flash point of the liquid.⁴¹ Carburettors must therefore be warmed by a hot water jacket or by the exhaust gases of the engine.

The lamp oil qualities of paraffin may be atomized by air into the space below a perforated disc of metal forming the cover of a shallow drum. The vaporized paraffin issues from the slits of the burner plate and burns with a blue Bunsen flame and this burner is used for small boilers of the flash type. The flame keeps the burner plate hot enough to vaporize the paraffin in the space below. An initial heater is necessary for starting the burner.

CHAPTER XV

COMPARISON OF AIR AND STEAM ATOMIZATION

The Ellis and Eaves System.

IN this system, the atomizing is done by steam, and heated air is supplied to the furnaces, the draught being fan induced. The air is heated in tubular heaters having two-thirds of the boiler heating surface, and placed over the boiler in the course of the gases to the fan, as shown in Fig. 59; the admission of air to the furnaces being, as in Fig. 60, round the outside of the atomizer.

Tests were also made with air as the atomizing agent. The air pressure was 20 pounds per square inch, and the results are given below. A subsequent test with air at 35 pounds pressure showed 11,108 pounds of water per hour from and at 212°F. per pound of coal and 15.49 pounds per pound of oil. This is somewhat less than with air at the more moderate pressure of 20 pounds. The atomizing air had a temperature of 80°F. only, or it might have given better results.

The difference between steam and air atomizing seems to be practically nil. For land work it remains simply to compare the amount of steam used direct with that used in compressing the air.

The analysis of the flue gases showed a mean result of 11.2 per cent. of CO₂ and 10 per cent. of oxygen in the left hand furnace and 14.1 per cent. of CO₂ and 8.4 of oxygen in the right hand furnace, the mean of both being CO₂ = 12.6, O = 9.6, CO = 0.

The tests made with this system of induced draught and oil fuel burning, of six hours' duration, were a success, but the question was raised whether the system could be worked for a lengthened period without giving trouble through deposits of soot and unconsumed oil becoming ignited in the air heater and casings, and a continuous test of 120 hours was made, careful observations being taken of the temperatures, evaporations, etc.

[Particulars of boiler, which were the same as in the previous tests—

12 ft. mean diameter by 11 ft. mean length, fitted with two Purves furnaces of 3 ft. 9 in. inside diameter.

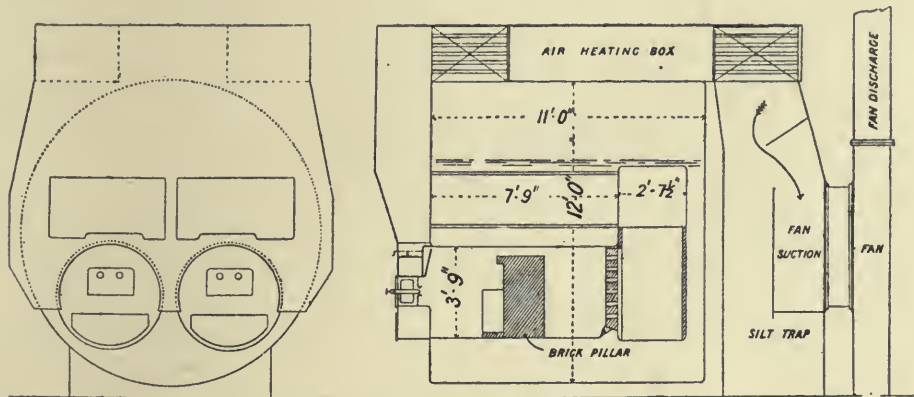

Fig. 59. ELLIS AND EAVES SYSTEM, MARINE BOILER ARRANGEMENT, FOR HEATING AIR.

148 Servé tubes, $3\frac{3}{4}$ in. outside diameter by 7 ft. 9 in. long and retarders.

Heating surface, 1,200 sq. ft. Grate surface (for coal burning) 43 sq. feet.

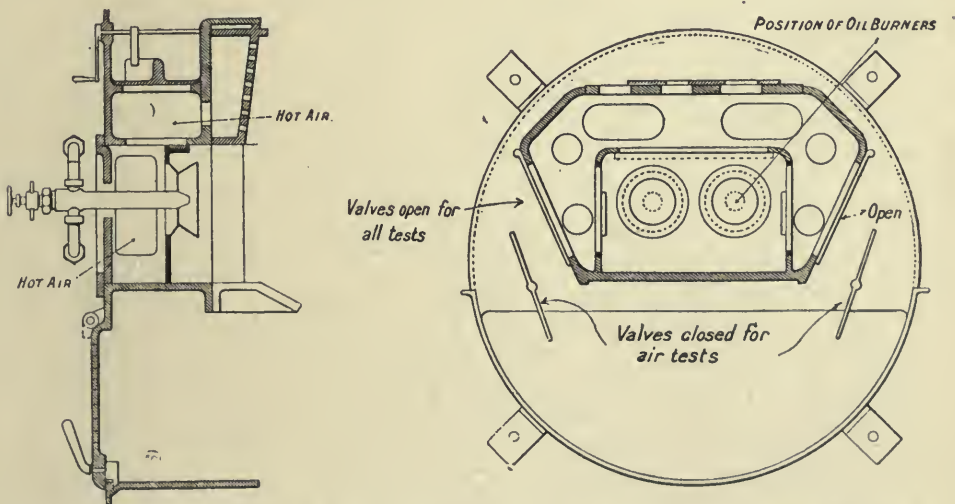

Fig. 60. ELLIS AND EAVES SYSTEM, FURNACE DOOR ARRANGEMENT.

Ratio of H.S. to G.S. 28 to 1.

Fitted with the Ellis and Eaves system of induced draught. Surface in air heating tubes, 800 sq. ft.

Diameter of Fan wheel, 7 ft. 6 in.

The boiler feed supply was taken from two tanks, each of 800 gallons and two oil supply tanks for burners, having a capacity of about 900 gallons each were provided. The oil was fed to burners at 75°F.

Steam to the burners was supplied at 70 pounds per square inch. Texas oil was used, closed flash point 185, calorific value 18400 B.Th.U. Sp. gr. 0.915.

Smoke was visible for a few seconds when changing over the oil tanks about every eight hours. Heated air was provided; the difference in right and left hand temperatures of air entering the fires being due to the fact that the right hand air heating box and air casings are protected from the weather by a wall, and also that the air entering these is at a higher temperature, due to radiation from the fan discharge.

The test was started on Monday, December 15, 1902, at eleven a.m., the boiler being cleaned before starting, and was continued night and day till eleven a.m. on Saturday, December 20, the installation working without a hitch during the whole of that time. Burners required cleaning occasionally, but this was carried out one at a time, and only occupied a few minutes. Hot air was admitted to the furnaces, the greater portion of this only being admitted round about the burners through vena-contracta nozzles.

At the end of the trial the boiler, air heater casings, etc., were opened up and examined by representatives of the Wallsend Slipway Co. and the International Mercantile Marine Co., and found to be perfectly clean and in good order, there being no indication of flaming in the casings. From the foregoing and a perusal of the following tables, the perfect combustion of the oil may be attributed to the use of heated air; no smoke is formed and there is no deposit of inflammable oil or soot on the tubes or casings to take fire.

From the table on page 227 the advantages of air heating are shown up clearly. Air which enters the heater at about 54°F. leaves it at about 284°F., having taken up 230° of temperature, all of which is absorbed from the furnace gases, which are reduced from about 760°F. to 520°F. more or less. They lose the 230° gained by the air, and this alone represents a very considerable economy, something like 33 per cent. of the otherwise waste heat passing up the chimney. The fan efficiency is also increased. Assuming that the furnace temperature is 2,800°F. the heating of the air by the waste gases would appear to represent an economy of fuel of 8 to 10 per cent., apart from the higher boiler efficiency 'due to increased temperature head.

Air heating is thus advantageous both in economy and more perfect combustion.

STEAM ATOMIZATION.

Time.	Steam Pressure.	Fan Revolutions	Vacuum at Fan Suction,	Vacuum at Furnace.	Temperature of Air entering Heater.	Heated Air entering Fires.		Escaping Gases entering Air Heater.	Escaping Gases at Fan Suction.	Feed Water Temperature.	Water Time aken to empty Tanks.		Oil. Gals.
						Left.	Right.				Tank 1. Mins.	Tank 2. Mins.	
10.0	145	305	2¼"	¾"	75°F.	235°F.	300°F.	700°F.	475°F.	60°F.	46		
10.30	135	309	2¼"	¾"	75°	235°	290°	700°	475°	60°		49	82½
11.0	140	308	2¼"	¾"	75°	232°	285°	695°	470°	55°			
11.30	135	305	2¼"	¾"	75°	230°	285°	695°	470°	58°	55		80
12.0	140	300	2¼"	¾"	75°	227°	275°	675°	455°	58°			
12.30	137	299	2¼"	¾"	75°	233°	275°	700°	460°	58°		41	81½
1.0	140	308	2¼"	¾"	75°	242°	295°	715°	485°	58°	39		
1.30	130	302	2¼"	¾"	75°	247°	305°	710°	490°	58°		40	100
2.0	150	305	2¼"	¾"	75°	248°	308°	715°	490°	58°			
2.30	145	305	2¼"	¾"	75°	248°	305°	715°	485°	58°	40		93¾
3.0	140	312	2¼"	¾"	75°	245°	295°	705°	475°	58°		42	
3.30	140	310	2¼"	¾"	75°	245°	290°	705°	485°	58°	135 gals. out of last tank.		82½
4.0	145	309	2¼"	¾"	75°	246°	295°	710°	505°	58°	Total 6,535 gals.		Total 530.

Water evap. per hour. Actual observed conditions.	10,891 lb.	Water evap. per lb. of Oil. Actual observed conditions.	13.4 lb.
Water evap. per hour. from and at 212° Fah.	13,145 lb.	Water evap. per lb. of Oil from and at 212° Fah.	16.1 lb.
Water evap. per sq. ft. H.S. Actual observed conditions.	9 lb.	Water evap. per sq. ft. H.S. from and at 212° Fah.	10.9 lb.
Theoretical total heat value of Oil in lb. of water from and at 212° Fah.	19.14 lb.	Efficiency of Boiler.	84%

The steam tests were of 6 hours' duration, those with air of four hours'.

AIR ATOMIZATION.

Time.	Steam Pressure.	Fan Revolutions per minute.	Vacuum at Fan Suction.	Vacuum at Furnace.	Temperature of Air entering Air Heater.	Heated Air entering Fires.		Escaping Gases entering Air Heater.	Escaping Gases at Fan Suction.	Feed Water Temperature.	Water Time taken to empty Tanks.		Oil. Gals.
						Left.	Right.				Tank 1. Mins.	Tank 2. Mins.	
10.30	130	297	2½"	1⅛"	74°F.	220°F.	225°F.	600°F.	360°F.	50°F.	52		
11.0	130	297	2½"	1⅛"	74°	216°	245°	630°	400°	50°		47	68.4
11.30	130	300	2½"	1⅛"	74°	225°	250°	630°	410°	50°			
12.0	130	300	2½"	1⅛"	74°	225°	250°	630°	410°	50°	45		99.28
12.30	130	298	2½"	1⅛"	74°	223°	250°	630°	410°	50°			
1.0	140	298	2½"	1⅛"	74°	223°	250°	630°	410°	50°		45	86.04
1.30	140	298	2½"	1⅛"	74°	225°	250°	630°	410°	50°			
2.0	140	298	2½"	1⅛"	74°	225°	250°	630°	410°	50°	46		83.83
2.30	135	298	2½"	1⅛"	74°	225°	250°	630°	410°	50°			
											90 gallons taken from last tank.		
											Total 4,090 gals.	Total 337.55	

Water evap. per hour Actual observed conditions.	10,225 lb.	Water evap. per lb. of Oil. Actual observed conditions.	13.24 lb.
Water evap per hour. from and at 212° Fah.	12,413 lb.	Water evap. per lb. of Oil from and at 212° Fah.	16.07 lb.
Theoretical total heat value of Oil in lb. of water from and at 212° Fah.	19.14 lb.	Efficiency of Boiler.	84%

	FIRST DAY. 11 a.m. on 15th to 11 a.m. on 16th.	SECOND DAY. 11 a.m. on 16th to 11 a.m. on 17th.	THIRD DAY. 11 a.m. on 17th to 11 a.m. on 18th.	FOURTH DAY. 11 a.m. on 18th to 11 a.m. on 19th.	FIFTH DAY. 11 a.m. on 19th to 11 a.m. on 20th.	TOTAL FOR 5 DAYS. 11 a.m. on 15th to 11 a.m. on 20th.
Average steam pressure (gauge)	138 lb.	142 lb.	143 lb.	141 lb.	143 lb.	141 lb.
Average temp. of feed water	46°F.	46°F.	46°F.	46°F.	45°F.	46°F.
Vacuum at fan suction	3½"	3½"	3½"	3½"	3½"	3½"
Vacuum at furnace door	1½"	1½"	1½"	1½"	1½"	1½"
Vacuum at ashpit door	1¾"	1¾"	1¾"	1¾"	1¾"	1¾"
Temp. of air entering airheater	46°F.	56°F.	54°F.	52°F.	48°F.	51°F.
Temp. of air entering furnace (left)	256°F.	260°F.	262°F.	260°F.	270°F.	262°F.
Temp. of air entering furnace (right)	272°F.	293°F.	280°F.	280°F.	284°F.	282°F.
Temp. of gases entering airheater	721°F.	762°F.	826°F.	684°F.	777°F.	762°F.
Temp. of gases leaving airheater	513°F.	528°F.	524°F.	512°F.	530°F.	521°F.
Fan revolutions per minute	416	403	400	410	397	399
Total quantity of water evaporated	278,000 lb.	283,900 lb.	291,500 lb.	285,900 lb.	298,100 lb.	1,437,400 lb.
Quantity of water evap. per hour	11,583 lb.	11,829 lb.	12,146 lb.	11,912 lb.	12,421 lb.	11,978 lb.
Total quantity of oil used	23,161 lb.	23,802 lb.	24,024 lb.	23,767 lb.	24,670 lb.	119,424 lb.
Quantity of oil used per hour	965 lb.	991 lb.	1,001 lb.	990 lb.	1,028 lb.	995 lb.
lb. of water evap. per lb. oil (actual)	12.003 lb.	11.927 lb.	12.133 lb.	12.029 lb.	12.083 lb.	12.036 lb.
Do. do. from and at 212°F.	14.63 lb.	14.54 lb.	14.79 lb.	14.66 lb.	14.729 lb.	14.66 lb.

CHAPTER XVI

THE STORAGE AND DISTRIBUTION OF LIQUID FUEL

IN carrying or storing oil, it is necessary to provide for its expansion, and it is also necessary to provide a safeguard against the rupture of the storage tanks unless these are below ground level. Provision must also be made for the escape of any gas or vapour generated from the oil and against danger from leakage.

The tanks used for oil storage have a diameter of from 40 to 70 feet. Some are as large as 90 feet, and the largest will hold over one million gallons, or 3,300 gallons per inch of depth. To prevent danger, should a tank fail, it ought to be surrounded by a moat capable of holding the contents of the tank. Both crude oil and the refined products are now carried in specially constructed tank steamers, some of which will carry as much as 8,500 tons of oil.

At Liverpool these steamers are discharged through an 8-inch pipe into vertical tanks of 2,000 and 3,000 tons capacity. The carrying space in the steamers is formed by riveted bulkheads across the ship, the skin of the ship itself forming sides to the tanks, the screw shaft being laid in a tunnel. Refined oil possesses such penetrative properties that the riveting of such tanks must be carefully done, and the rivet spacing is closer than in ordinary work. The tanks ought to be full of oil, and they must not be too large, a bulkhead being placed at intervals not wider than 24 feet. These bulkheads must be stiff enough to stand the unsupported pressure of the liquid upon one side only, together with such extra stress as may be caused by the movement of the vessel. The specific gravity of petroleum varies considerably, but an approximate rule to cover all cases of oil pressure is $P = 0.40 H$, where P is the pounds pressure per square inch and H is the depth in feet below the top level of the oil, which may of course be some distance up the expansion tanks.

It is not considered safe to store Texas crude oil nearer to

boilers than 500 feet, and in case of a spouting well all fires within 500 feet are extinguished.

Where oil is used freely as fuel it may be lead to the different establishments by pipes in preference to carting it in tanks. The pipes ought to be of wrought iron or steel, carefully threaded and fitted together with sound and carefully threaded sockets. Pipe joints may be made in three ways : (a) The pipes are screwed tapering and the sockets ought to be threaded similarly from each end by a tapering tap, so that a tight joint may be secured ; (b) Back nuts may be employed to reinforce the sockets by aid of an interposed fibrous ring ; (c) The pipe ends may be truly faced off exactly at right angles to the axis of the threading, a compressible, but thin, washer of soft metal or fibre being interposed between the ends of the abutting pipes. Such pipes meet together in the sockets like artesian drive pipes.

Ordinary pipes, if found to leak after being put together, should be caulked round the ends of the sockets. Before screwing together the threads ought to be painted with some cement not soluble in petroleum. Litharge and glycerine is recommended. Many of the precautions with regard to oil arise from the fact that, being lighter than water, it may be carried up and down a tidal river and spread a general conflagration. Being liquid, it will travel by gravity to long distances. Where, to avoid danger, oil is stored in buried vaults, there is danger of the accumulation of explosive vapours, and ventilation is required ; the outlet of a ventilating shaft should be well exposed and out of such danger as the throwing of a lighted match from some point above. Where ventilation does not take place freely, it might be necessary to use positive means of drawing out the air from a tank chamber or to assist the action of the ventilating trunk by a warm water pipe within it and a swivelling cowl head.

To deal with the liquid fuel locomotives of the Great Eastern Railway, there were provided a series of underground tanks of a capacity in the aggregate of 50,000 gallons, filled direct from the travelling tanks of the railway.

From these underground tanks a Tangye Special pump lifts the oil to cylindrical tanks 20 feet above rail level, and of a total capacity of 42,000 gallons.

Outlet pipes controlled by valves, operated from a gallery above, conduct the oil to cranes similar to an ordinary water crane.

A main line engine will take in 600 gallons of oil in four or five minutes.

Electric lighting is employed, with portable lamps for the cranes or filling arms.

Oil may be stored underground only, and in airtight tanks, which are caused to supply the filling arms by pumping air into the tanks above the oil, the air brake pump of the locomotive itself doing this work.

The tanks of the tender are filled through a fine gauze strainer, protected by a perforated cylinder, so that everything in the shape of an obstruction is filtered out, and the gauze also serves to prevent ignition of any possible vapour in the tank, acting to prevent this on the well known principle of the miner's safety lamp. This precaution is more necessary where crude oils are used than for the higher flash point residues.

On the Grazi and Tsaritzin Railway Mr. Urquhart, in his 1884¹ paper gave the length of line worked with petroleum as from Tsaritzin to Burnack, 291 miles, and a total of 423 miles, including the Volga-Don branch. There is a main reservoir for petroleum, at each of the four engine sheds, 66 feet diameter and 24 feet high, and about 2,050 tons capacity. The reservoir stands a good way from the line and from dwelling houses and buildings.

On a special siding are placed 10 cistern cars full of oil, the capacity of each being about 10 tons. From each car a connection is made by a flexible india-rubber pipe to one of the ten standpipes, which project one foot above the ground line. Parallel with the rails is laid a main pipe, with which the ten standpipes are connected, thus forming one general suction main. About the middle of the length of the main, which is laid underground and covered with sawdust or other non-conducting material, is a steam pump which in about one hour discharges the whole of the cars into the main reservoir. The pipes are all wrought iron, lap welded, 5 inch socketed.

At each shed there is an elevated tank (Fig. 61) 8½ feet diameter by 6 feet deep, built of ¼ in. plate, to serve as a distributing tank to the locomotives. A divided scale shows exactly how many pood;² of oil have been drawn out, the amount being corrected for temperature at intervals of 8°R. = 18°F. = 10°C., the scale ranging from 24°R. to - 24°R. = 86°F. to - 22°F., the quantity and temperature being entered in the driver's book. The heaviest refuse has a specific gravity of 0.921 at 0°C. = 32°F., so that 39 cubic feet measure one ton, or 57.4 pounds = 1 cubic foot. Lighter refuse has a specific

¹ *Proceedings of the Institution of Mechanical Engineers*, 1884.

² 1 pood = 36.114 English pounds = 40 pounds Russian. 62.0257 poods = 1 ton.

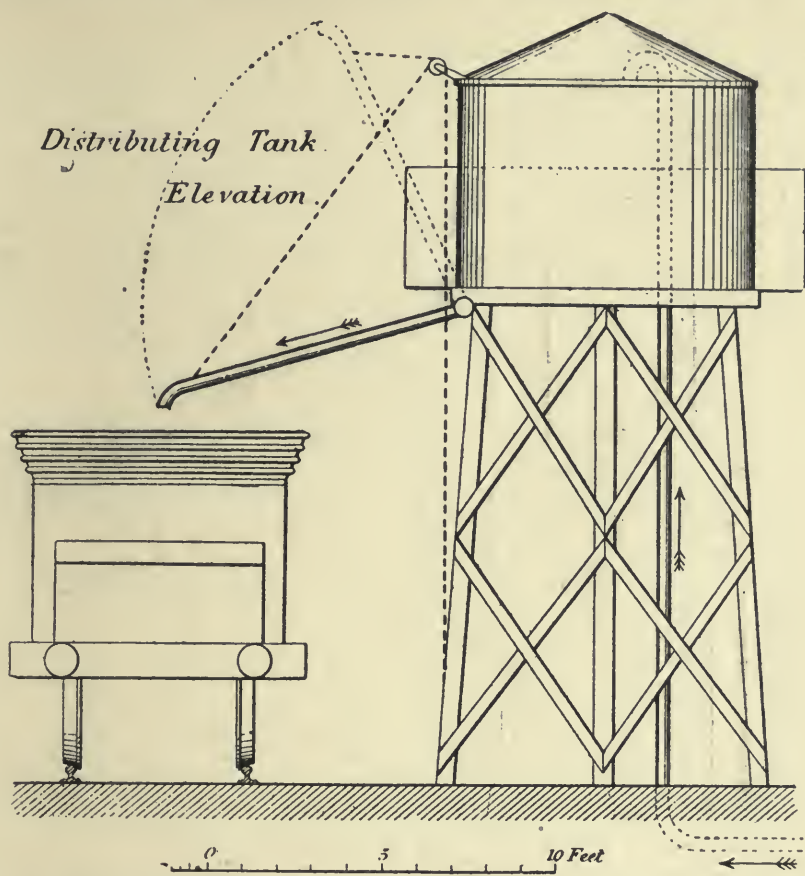

Fig. 61. DISTRIBUTING TANK FOR OIL FUEL. GRAZI AND TSARITZIN RAILWAY.

gravity of $0.889 = 40\frac{1}{2}$ cubic feet per ton, or $55\frac{1}{2}$ pounds per cubic foot.

The engineer-in-charge at each station is provided with a hydrometer and thermometer to deal with the ten different grades of liquid, each grade having its own peculiar sp. gr. and co-efficient of expansion. Table XIII gives useful information on this subject.

Oil Pumps.

Any pump which will pump water will pump oil, if not too viscid. So long as an oil is free from the more volatile hydrocarbons, it can be lifted by suction from a depth greater than is possible with water, in inverse ratio to its specific gravity. By weight a pump will throw less oil than water, but it should throw an equal volume.

For rapidly transferring large bodies of oil from a ship to a storage tank, the centrifugal pump is very convenient. There

are also numerous other rotary pumps of the positive propulsion type similar to the Roots' Blower. But viscid oil can hardly be moved by a centrifugal pump.

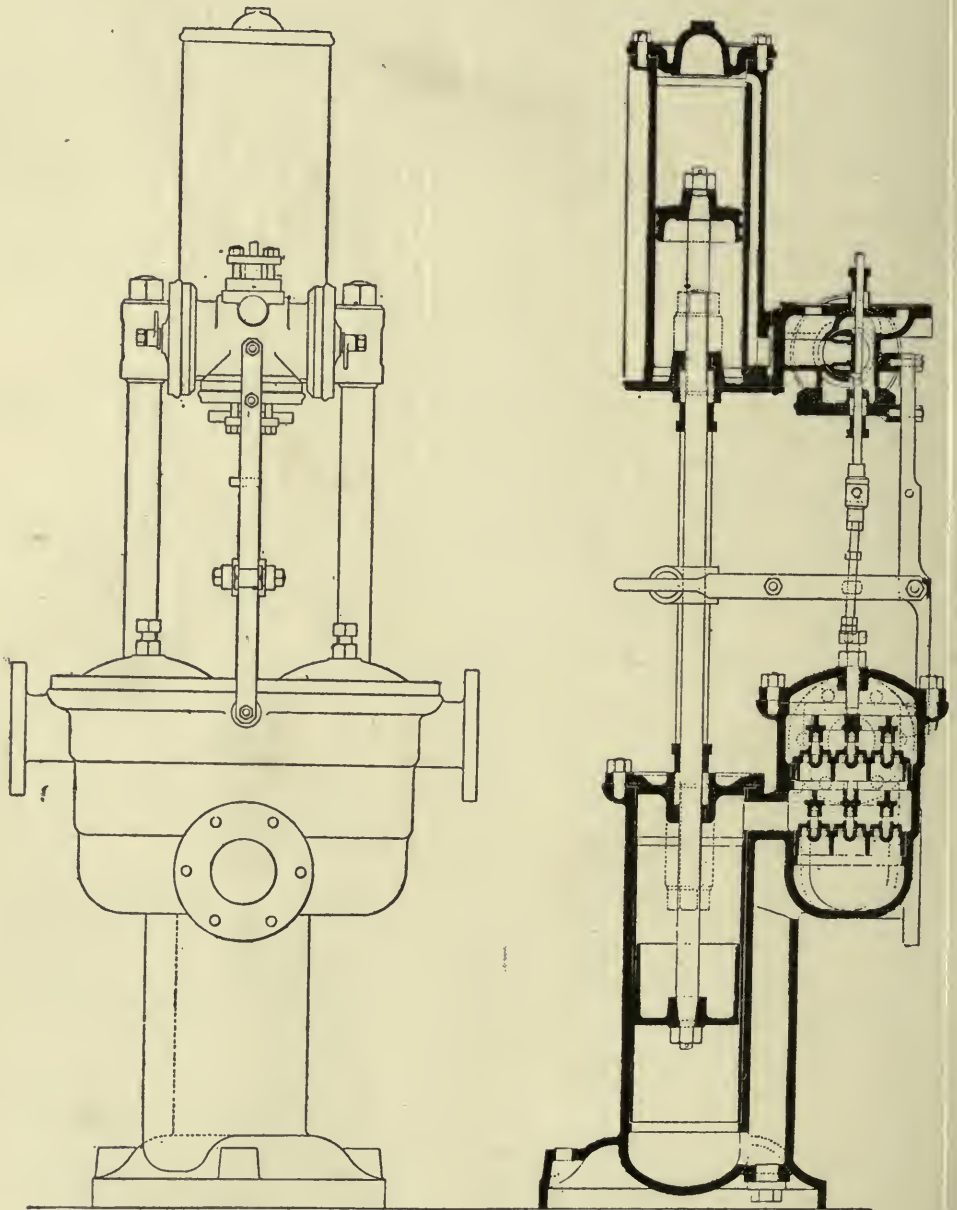

Fig. 62. WEIR'S OIL PUMP.

Valves of india-rubber must of course be avoided, and only such substances employed as will resist the solvent action of the oil. Metal valves should prove most generally durable and efficient. Simplicity and reliability are the characteristics

desired in a pump. For bunker filling especially the pump must be of ample capacity, so that a ship may not be long detained when calling for fuel in port.

An example of a bunkering pump is the Weir Patent Pump for oil pumping as shown in Fig. 62. This is of the direct double-acting type. The valve gear is positive, i.e. the steam valve can never be in such a position that the pump will not start immediately after the steam is turned on. The valve arrangements also ensure constant length of stroke and certainty of action.

The steam valve consists of a "D" slide valve with a small auxiliary valve working on the back. These are the only moving parts proper in the steam chest, so that there is little opportunity for wear and no delicate adjustments to get out of order.

The oil end as shown is fitted with Weir group valves, which provide a large area with only a small lift, thus ensuring easy working and little wear and tear. In more recent types these valves are of the Kinghorn type and the discharge branches look upward, not outward. In larger sizes the piston rods are divided, and the two are connected by a screwed crosshead.

The pump is specially economical in steam consumption, and is simple and with all its parts easily accessible. The front elevation shows that there is a separate valve chamber for each end of the pump cylinder, the valves being grouped on the valve plate round a central valve. With long pump buckets there should be no need to use rings. The bucket simply requires to be turned a good but free fit in its barrel and grooved with square edged grooves $\frac{1}{4}$ " wide \times $\frac{3}{32}$ " deep, spaced about $\frac{5}{8}$ " centres. This plan is very effectual with water, and should be perfect for oil of the consistency of fuel oil.

FLUE GAS ANALYSIS.

The analysis of flue gases is undertaken for the purpose of showing the perfection of the combustion and the excess of air employed.

Considering that about 9 per cent. more coal is consumed if the percentage of CO_2 is 8 per cent. instead of 13 per cent., the waste of coal will amount to 900 tons a year in 10,000 tons burned. Oil stands on the same level.

In practice, about 1.3 times the theoretical quantity of air is required to effect perfect combustion.

How much coal is wasted, if the percentage of carbonic acid

gas falls to a low level, may be seen at a glance from the following table—

Percentage of CO ₂ . . .	2	3	4	5	6	7	8	9	10	11	12	13	14	15
Loss of fuel in per cent. against the theoretically lowest pos- sible quantity	90	60	45	36	30	26	23	20	18	16	15	14	13	12

It is not possible to tell from the appearance of the fire in the furnace the percentage of CO₂.

As one pound of carbon requires a minimum of 11½ pounds of air for perfect combustion, it will produce 12½ pounds of total furnace gas, and of this 3½ pounds will be CO₂: that is, fully 29 per cent. by weight or nearly 21 per cent. by volume. For anthracite coal free from hydrogen the excess of air can be calculated from the percentage of CO₂ in the flue gas.

For fuels containing hydrogen, the analysis being done cold, the steam which is produced by the hydrogen is therefore not measured, this steam is less in volume than the nitrogen of the air which supplied oxygen to burn the hydrogen. The percentage of CO₂ in the flue gas thus appears smaller with the more hydrogenous fuels than it does with the less hydrogenous fuel. But in every case the actual percentage can be calculated, and, once known, subsequent records can be compared with the calculated datum line.

A fuel containing hydrogen to the extent of one per cent. demands 55.9 litres of oxygen per kilo. of coal, or 0.9 cubic foot per pound, to satisfy the hydrogen.

The following tabular numbers give the volume of oxygen per kilo. and per pound of coal for various percentages of hydrogen.

Per cent.	Litres per kilo.	Cubic ft. per lb.
1	55.9	0.9
2	112.0	1.8
3	168.0	2.7
4	223.0	3.6
5	279.0	4.5
6	336.0	5.4
7	391.0	6.3
8	446.0	7.2
9	504.0	8.1
10	559.0	9.0
11	615.0	9.9
12	672.0	10.8
13	727.0	11.7
14	782.0	12.6
15	837.0	13.5
16	892.0	14.4

In calculating the volume of dry gas from analysis, any hydrocarbon gas is calculated as though it were simply carbon vapour of a weight of 1.072 grams per litre.

	At 0°C. and 760 mm. pressure,	
		Molecular weight
1 litre of CO ₂	= 1.966 gram	= 44.
1 „ „ CO	= 1.251 „	= 28.
1 „ „ C vapour	= 1.072 „	= 12.

Each volume of CO₂ contains $\frac{3}{11}$ of its weight of carbon, or $1.966 \times \frac{3}{11} = 0.536$ grams per litre. Similarly, the proportion of carbon in carbonic oxide is $\frac{3}{7}$ of the weight, or $1.251 \times \frac{3}{7} = 0.536$ grams per litre, the weight of carbon vapour being 1.072 grams per litre.

Thus the total weight of carbon is $C = 0.536 (v + v') + 1.072 v''$ where v , v' and v'' are the volumes of CO₂, CO, and carbon vapour in litres per each cubic metre or per 1,000 volumes of flue gas.

For British units the formula becomes $C = 0.0335 (v + v') + 0.06693 v''$ where v , v' and v'' are the volumes in cubic feet per thousand feet of flue gas.

Kent's formula for the weight of dry gas per pound of carbon is—

$$W = \frac{11, \text{CO}_2 + 80 + 7 (O + N)}{3 (\text{CO}_2 + \text{CO})}$$

Having found this weight of dry gas from the analysis of the furnace gases, there must be added the proportion necessary for the steam produced. This will measure 9 by weight for each unit weight of hydrogen, and, the density of steam being 9, the relative volume may be found, or it may be taken from the above table.

By formula the total volume of gases thus becomes.

$$V = \frac{C}{0.536 (v + v') + 1.072v''} + 55.9 H + A,$$

where H is the percentage of hydrogen in the fuel, and A is the combined volume of nitrogen and excess of air.

In analysing a furnace gas there are two main methods. One is to take frequent samples rapidly in a bottle and analyse this by the Orsat apparatus: the other is to take a sample, known as a long sample, by means of a modification of the Sprengel pump, the time of filling the sample bottle being extended to any duration wished, even several hours. The

analysis of this long sample gives the average furnace performance over the whole time. Short samples may be taken and analysed throughout the period of taking the long sample.

For these analyses the Orsat apparatus may be employed as most convenient. A description of this will be found in the author's work on *Liquid Fuel and its Combustion* and in manuals on gas analysis. There are numerous instruments devised automatically to analyse flue gases so far as their contents of CO_2 is concerned. The Arndt apparatus keeps a continuous record of the density of the gases whence the percentage of CO_2 is shown by a pointer, and it may be arranged to show a continuous record. The Ados apparatus actually analyses small samples of the gas every few minutes, and records this on a paper band. The apparatus of Simmance and Abady does the same thing in a very simple manner. Descriptions of the working of these instruments can be had from the makers.

Calorimeters.

While the calorific value of a fuel may be calculated approximately by Dulong's and other similar formulæ, experiment must be resorted to for more exact determinations. For this purpose a sample of fuel must be actually burned in a very complete manner and the heat must be measured which is given off.

Essentially all calorimeters consist of a vessel in which a small sample of the fuel to be tested is burned by a stream of oxygen. The whole of the heat produced is absorbed by water contained in an enclosing case and the calorific power is calculated from the rise of temperature of the known weight of water and of the metal of the instrument. Various corrections have to be made and accurate results are only to be obtained with great care. But if a number of samples are tested under similar conditions, their comparative values may be approximately determined without going to the trouble of making corrections which will affect all samples alike.

Descriptions of calorimeters and their method of use may be found in the Author's book on *Liquid Fuel and its Combustion*, and in other works on fuel.

The following table gives the calorific power of a few oils and tars.

CALORIMETRIC VALUES BY BERTHELOT MAHLER CALORIMETER
ELEMENTARY ANALYSIS.

Character of Combustible.	Carbon.	Hydro- gen.	Oxygen.	Nitrogen.	Calorific Value.
Heavy oil from American petroleum	86·894	13·107	—	—	10,912·7
Refined American petroleum	85·491	14·216	—	0·203	11,045·7
Treble refined American petroleum	80·583	15·101	—	4·316	11,086
Crude American oil	83·012	13·389	—	3·099	11,094·1
Heavy Baku oil	86·700	12·944	—	—	11,804·6
Novorossisk petroleum, Caucasian	84·906	11·636	—	9·458	10,328
Tar from hydraulic main	89·910	4·945	5·145	—	8·9428
Tar from cooler	87·222	5·499	6·279	—	8·8310
Tar from condenser	85·183	5·599	9·218	—	8·8384

With oil fuel alone the question of draught is of comparatively small importance, for the grate and its load of fuel form the chief resistance to draught when solid fuels are used.

The draught due to a chimney arises from the difference of pressure of two columns of gas of the height between the grate surface and the chimney-top. The column inside the chimney is hot because of the furnace through which it has passed. That outside the chimney has the temperature of the outer atmosphere. At a temperature of 300°C. (572°F.) the inner column is just about double the absolute temperature of the outer column, so that the relative density is one-half.

The velocity of flow of a gas under any head is $v = \sqrt{2g h}$, where v is the velocity in feet per second, h is the head in feet, and $2g = 64·4$ or gravity $\times 2$. Gravity = 32·2.

Expressed in metres values of v and h we have $v = \sqrt{2 g h}$, where $g = 9·81$.

Assuming that at ordinary temperatures 13 cubic feet of air weigh one pound, the atmospheric pressure of 2,115 pounds per square foot represents a column 27,495 feet in height, which would flow into a vacuum at a velocity of approximately $8\sqrt{27,495} = 1,321$ feet per second.

The pressure to produce draught, however, is only measured by inches of water pressure. If a chimney has an internal absolute temperature double that of the external atmosphere, it will contain only one pound of gas for each 26 feet of a column of gas 1 foot square, or, what is the same thing, the external column is half-balanced only. Thus if H be the height of the chimney, $H \div (2 \times 13)$ will give the pressure per square foot, producing draught. Thus a chimney of 104 feet will

give an acting pressure of 4 pounds. As 1 inch of water gives a pressure of 0.036 pounds per square inch, the draught pressure of the above chimney would be—

$$\frac{4}{144 \times .036} = 0.7716 \text{ inches nearly.}$$

Having found the pressure, the air column equivalent to this must be found. Water weighs 62.4 pounds per cubic foot. Air weighs 0.077 pounds, whence the equivalent air column, in feet per inch of water column will be found.

$$\frac{62.4}{12 \times 0.077} = 67 \text{ feet.}$$

The velocity of flow is then $8 \sqrt{67 H}$ or fully $64 \sqrt{H}$ where H is the pressure in inches shown by the actual water gauge. In coal-fired furnaces the reading of the draught gauge is much greater at the chimney base than in the flues, for the friction of the flues exerts considerable resistance. The simplest form of water gauge is a bent glass tube of **U** form, one end being open to the atmosphere, the other connected by a piece of india-rubber tubing to a piece of pipe which enters the flues at the point where the draught intensity is sought.

It is convenient to remember that where the velocity of flow due to head in feet is $v = \sqrt{2 g h}$, that due to a pressure as shown in inches of water is almost exactly $z = 2g\sqrt{H}$. All these figures can only be approximate, because they will vary with the temperature. They are sufficiently accurate to base designs upon in respect of providing sufficient openings for air to burn the oil.

The following table of velocities of air for a few pressures in inches of water will be useful—

Pressure in inches of water.	Velocity of air in feet.	
	Per second.	Per minute.
0.1	20.7	1,243
0.2	29.3	1,758
0.3	35.8	2,150
0.4	41.4	2,485
0.5	46.3	2,778
0.6	50.7	3,043
0.7	54.8	3,287
0.8	58.5	3,513
0.9	62.1	3,726
1.0	65.4	3,927
2.0	92.4	5,547

An ordinary U gauge is not capable of being finely read. It possesses a capillarity which is difficult to allow for and will not serve for accurate work. A better gauge consists of a glass-fronted box in two divisions partly filled with water. A hook gauge, reading on a scale, permits very accurate measurement. Descriptions of this and other gauges may be found in the Author's larger work and in other works on solid fuels. But since with solid fuels the greater part of the draught is used in overcoming grate resistance the question is of comparatively small importance where liquid fuel alone is employed, since unencumbered furnaces and flues with a short chimney appear capable of carrying away all the gases from liquid fuel.

In coal firing, about three-fourths of the draught is swallowed up by grate and fuel friction. With oil firing alone and no grate friction there is usually ample velocity of the inflowing air. The chimney, in fact, ceases to possess so much importance, but must be large enough in area to carry off the waste gases.

The weight of a cubic foot of air at $0^{\circ}\text{C.} = 32^{\circ}\text{F.}$ being 0.08 lb., that at any other temperature will be

$$\frac{0.08 \times 273}{273 + t^{\circ}} \text{ where } t^{\circ} \text{ is expressed in degrees Centigrade}$$

$$\text{and } \frac{0.08 \times 491}{t^{\circ} + 459} \text{ where } t^{\circ} \text{ is in degrees Fahrenheit.}$$

By these formulæ may be calculated the weight of air inside and outside a chimney. The difference of the two is the pressure to produce draught per foot of chimney height.

Calling D and d the greater and less densities the equivalent height of a column for any chimney of height $= h$ ft. will be $L = h \left(\frac{D-d}{D}\right)$ and the velocity of flow per second will be

$$v = \sqrt{2gL} \text{ where } L \text{ is the equivalent column in feet.}$$

In all the foregoing the specific gravity of furnace gas is assumed equal to that of air of the same temperature, the steam balancing the carbonic acid more or less closely.

Seeing that draught is of less importance with liquid fuel, it is permissible to reduce the furnace products to a lower temperature if facilities can be had for doing this. The smaller excess of air with which perfect combustion can be secured is a factor in rendering more efficient the heating surfaces of the boiler, and reduced flue gas temperatures are a natural consequence of liquid fuel.

A chimney must be large enough to pass all the products of

a furnace at a certain given velocity of flow. The calculation of chimney area is thus simple. Assuming the velocity of flow of gas to be 30 feet per second, it is simply necessary to divide the volume of gas produced per second by 30. The result is the area in square feet of the chimney. To find the volume of gas produced per second, the fuel consumption per second is first found as follows in pounds—

$$P = \frac{W \times 2,240}{H \times 3,600} \text{ where } W \text{ is the daily consumption in tons}$$

and H the daily hours. Then $P \times 20 =$ pounds of gas $= G$. At ordinary temperatures one pound of gas measures 13 cubic feet very closely. At the chimney temperature it will measure 20 to 25 feet. Let 22 be assumed: then $G \times 22 \div 30$ will give the area of the chimney inside $= A$. The chimney will measure, if square, \sqrt{A} , on each side, or, if round, its diameter will be $D = 1.128 \sqrt{A}$.

With oil a very small draught will draw in enough air for perfect combustion, and it is usually necessary rather to check the flow of the gases through the flues, only sufficient draught being required to remove the products of combustion as formed. Chimneys of small altitude will do this, for they do not require to overcome any grate or fuel-bed resistance. In locomotives, for example, the steam blast may be considerably reduced, and on the Great Eastern Railway of England the MacAllan variable blast-pipe is enlarged from 5 inches with coal to $5\frac{3}{4}$ inches diameter with oil to the reduction of the back pressure on the pistons and economy of steam in consequence. In foreign locomotive practice it is usual to employ caps over the chimney-top in order to save the loss of heat when running down grade or standing idle. Mr. Urquhart continued to use this cap with his oil-fired engines, and though it presents an odd appearance to English eyes, the cap has advantages. Applied to stationary work it is represented ordinarily by a damper at the chimney-base, and is thus recognized as good, but it is not used in locomotive work. It affords a ready means of regulating the fires, and cannot quite be replaced by the ash-pit damper, which is heavier to work and is by no means always so tight-shutting as it should be.

A very usual remedy for a bad draught in coal-fired furnaces is a steam jet. In oil-firing this aid to draught is present in the atomizer, which really replaces the need for a certain chimney or fan effect. The area of chimneys must not be calculated from the horse-power to be developed. The actual

fuel consumption should be worked from. The fuel per horse-power hour will vary according to the load-factor and other conditions, and large stations will use less fuel per horse-power hour than will small stations with smaller load-factors. Each case must stand by itself. A very small draught will give a velocity of 30 feet per second. Ordinary rules for chimneys provide for areas that will reduce the velocity of flow to much less than the foregoing 30 feet per second, but it is doubtful if such large areas are necessary with liquid fuel, and it is certain that a chimney hitherto used for solid fuel will serve well when a change is made to liquid fuel. Experience so far is lacking on the question of chimney practice for liquid fuel work, but the subject may be approached from the standpoint above, viz., that with liquid fuel not only is the resistance of the fuel on the grate eliminated but there is added a propelling force in the atomizer which, if applied to a poor draught in a coal-burning furnace, would render such draught good and sufficient. Bearing these points in mind, the ordinary treatises on draught may be studied with advantage as regards the effect of height upon velocity of flow. But the ordinary rules otherwise have little application to liquid fuel conditions.

CHAPTER XVII

COMPRESSED AIR AND AIR COMPRESSORS

THE use of air as the atomizing agent has been delayed because steam is more readily obtained, and where the loss of fresh water in the form of steam is not a serious matter, it is claimed that steam is a cheaper agent than air, which must be compressed by steam power to begin with. But steam is not a supporter of combustion, and air is; and there is a tendency to-day to employ air where possible, and to use it hot. Air being so nearly a perfect gas, the whole work of compressing it is practically converted into heat, and the temperature of the compressed air is raised. In the compression of air to 60 pounds per square inch or more it is usual to compress in two stages, cooling both cylinders by means of a water jacket, and cooling the air between the two stages by means of a tubular receiver or a sufficient area of exposed tubes. But in fuel atomizing a pressure of 15 pounds to 20 by gauge is usually held to be ample, and generally it is not necessary to use air at the same high pressure as steam. Air is much heavier than steam, and more energetic per unit volume. But this does not apply to air which must of necessity be introduced into the furnace and is required for the proper combustion of the fuel. Air compressors are somewhat awkward machines, and, especially on shipboard, are not easily housed. For oil atomizing it is not necessary to employ a two-stage compressor. The heat of compression is not great for the first moderate stage of 15 to 30 pounds, and after the air leaves the compressor it should be heated on its way to the atomizer. This is usually effected by means of pipes in the flues of the stationary boiler or in the smoke-box of the locomotive.

The curve of isothermal compression of a perfect gas is the hyperbola, the equation to the curve being such that $Pv = \text{constant}$.

Thus two cubic feet at 40 pounds absolute pressure become one cubic foot at 80 pounds, but the temperature remains constant.

When air is compressed adiabatically, or without loss or gain of heat, its curve has the equation—

$$\frac{P}{p} = \left(\frac{V}{v}\right)^{1.403}$$

P being the pressure corresponding to the small volume v , and V the volume at small pressure p .

Assuming the volume $v = 1$ we have—

$$\frac{P}{p} = \frac{V^{1.403}}{1} \text{ or } P = p V^{1.403}$$

Thus air at pressure $p = 15$ is compressed to $P = 90$.

Then $\frac{P}{p} = 6$ and the relative volumes before and after compression are for $v = 1$.

$$\frac{V^{1.403}}{1} = \frac{P}{p} = 6$$

The log. of 6 is 0.77815

and $0.77815 \div 1.408 = 0.55266$, which is the log. of $3.57 = V$.

Thus in place of an original 6 vols. of air, only 3.57 will be needed to give a final volume of 1, owing to the increased volume due to temperature rise. For a moderate compression of 2 only we shall have $V^{1.403} = 2$. The log. of 2 is 0.30103 and $0.30103 \div 1.408 = 0.2138$, which is the log. of 1.636, this being the number of compressions necessary to give a double pressure instead of two compressions, had the temperature been kept down or $V = 1.636$.

The heat generated in *compressing* a gas from a pressure of p to a pressure of p_1 is—

$$H = \frac{53.15T_0}{\gamma - 1} \left[\left(\frac{p_1}{p}\right)^{\frac{\gamma-1}{\gamma}} - 1 \right] \quad (1)$$

where, γ , according to Rankine, is 1.408; p and p_1 are the initial and final pressures in atmospheres and $H =$ foot-pounds, T_0 being the absolute temperature whence the heat units per pound of air compressed will be $H \div 772$, and the temperature

$\frac{H}{772 \times 0.237}$; 0.237 being the specific heat of air.

The work done in compressing and *delivering* one pound of air is thus, in foot-pounds—

$$W = 53.15 T_0 \frac{1.408}{0.408} \left\{ \left(\frac{p_1}{p}\right)^{\frac{0.403}{1.408}} - 1 \right\} \quad (2)$$

whence can be found the power required for compression. The efficiency overall from motor switch-board should not be taken above 70 per cent. when designing a motor for the purpose. The overall efficiency of a first-class air compressor is said to exceed 70 per cent. with its electric motor, but ordinary compressors cannot be calculated above 50 per cent.

Since free air weighs one pound for each cubic 13 feet at ordinary temperatures, the size of compressor required for any weight of air is easily calculated from the speed and piston displacement.

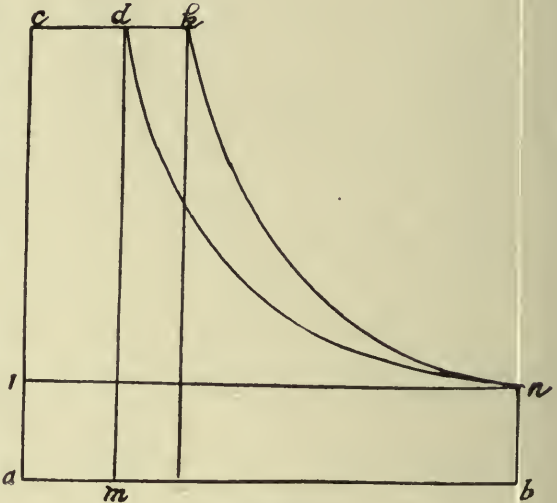

Fig. 63.

In a water-cooled compressor the index of the curve of compression of a good compressor may be safely taken at $\gamma = 1.2$ in place of 1.408, as in adiabatic compression.

The subject of air compression is one of such importance in respect of liquid fuel combustion as to justify full explanation of the peculiar action of a perfect gas.

Air is so nearly a perfect gas that there is very little internal

work done upon it when it is compressed. All the work appears as heat. In Fig. 63 this action is shown diagrammatically. A volume of air $a b$ at the pressure $b n$ of one atmosphere, if compressed to several atmospheres so slowly that it loses all the heat of compression at once, will occupy a volume $c d$ at the pressure $a c$.

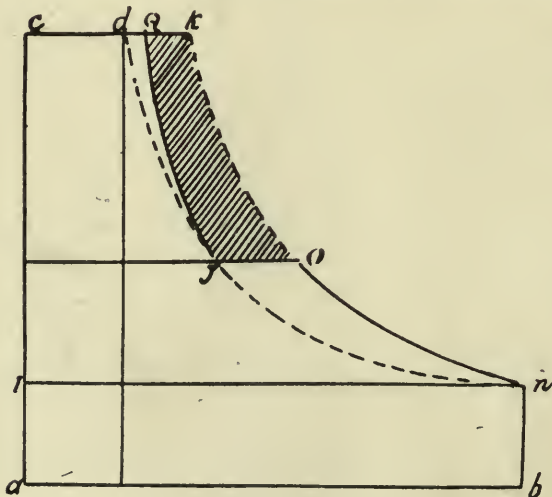

Fig. 64.

The area $a b n i$ will be exactly equal to the area $a c d m$; in other words, the product of pressure and volume is constant.

If compressed quickly, without loss of heat, the curve $n k$ will be described and the volume of the compressed air will be $c k$. The rectangle $d a$ is equal to the rectangle $a n$ for d and n are points in the isothermal curve $n d$. Consequently the rectangles $d i$ and $m n$ must be equal and $n k c i$ is equal to $m b n k d$, or, in words, the mechanical work of adiabatic compression is equal to the work done in compression and delivery.

If, in place of single-stage compression, the double-stage system be adopted, the principle of intermediate cooling can be employed. Thus, in Fig. 64 compression is first carried to the point o ; the compressed air is cooled in the receiver to the point j , and arrives at the ultimate pressure $a c$ with a volume very little greater than $c d$. The diagram is less in area than Fig. 63 by the area $j o k q$, and this represents energy economized during compression.

These same principles and arguments may be applied to the use of air in two stages in place of one. Thus, the compressed air may be made to run a pump the exhaust from which is carried to a hoisting engine or other motor.

When compressing air the heat of compression is dissipated to the atmosphere, and when the air is used again in a two-stage expansion it is reheated between the stages by absorption of heat from the atmosphere, which thus serves the part of a general equalizer, absorbing heat from compressed air and giving it out again to expanding air.

It is stated by Lieutenant Winchell that tests made on various atomizers show that each pound of water evaporated from and at 212°F . requires one cubic foot of free air compressed to 20 lb. gauge pressure = 35 lb. absolute. Assuming that 1 lb. of oil will evaporate 13 lb. of water, and that 13 cubic feet of air are equivalent to 1 lb., the figures represent 1 lb. of air to atomize 1 lb. of oil. How much power, then, will be required to atomize the fuel for 1,000 h.p., using, say, 16 lb. of steam per h.p. hour, with an evaporation, say, of 14 lb. per pound of oil? Here $1,000 \times \frac{16}{14} = 1,143$ lb. of oil per hour, or 1,143 lb. of air. This is 19 lb. of air per minute, to compress which, according to equation (2) adiabatically from a temperature of $62^{\circ}\text{F} = 522^{\circ}$ absol., will require per pound of air—

$$\left[\frac{53.15 \times 522 \times 1408}{408} \times \left\{ \left(\frac{35}{15} \right)^{0.29} - 1 \right\} \right] \div 33000$$

$$= \frac{95745 \times 0.286}{33000} = 0.8384 \text{ h.p.}$$

per pound of air compressed to 20 lb. gauge pressure per minute. At 70 per cent. efficiency, this becomes 1.2 h.p. nearly, or a

total of 22.8 h.p. for the total engine power of 1,000, which is less than $2\frac{1}{3}$ per cent. of the total power; whereas steam atomizing requires 3 to 5 per cent. of the total power of a boiler. The citation of the air per pound of evaporation is hardly a correct method, but not much is yet known of this part of the subject, and meantime one pound of air, or 13 cubic feet of free air, should be provided per pound of oil; and probably with the cooling effect allowed for, one brake horse-power will compress one pound of air to 20 pounds gauge pressure. The figures thus confirm M. Bertin's original ideas, as given below.

The above calculation is for adiabatic compression.

Per kilogram of air per minute the power expended in air compression will be nearly 50 h.p.

To spray one kilo. of oil requires 28.6 cubic feet of free air, or 812.0 litres. As it is usual to order air compressors by their capacity in cubic feet of free air, the amount of one unit weight per unit of oil works out at 13 cubic feet per h.p. hour, more or less, according to the efficiency of steam engine and boilers, or from 20 to 25 cubic feet per minute per 100 h.p. From this the size of air compressor can be calculated.

Thus an air compressor will have, say, a total useful piston stroke equal to 3 feet per revolution. At 240 revolutions per minute, this represents 720 linear feet. With 10 inch diameter pistons the capacity is thus about 390 cubic feet per minute, less, say, 10 per cent. for slip or 350 cubic feet, which should supply about 1,400 to 1,700 h.p. of burners in a fairly economical plant. An allowance of ten per cent. for slip is enough in these compressors for 80 pounds compression, and is therefore more than ample for ordinary low pressure work.

The compressor lends itself readily to electric driving. Automatic regulating devices are fitted to maintain the air pressure constant in the case of electric driving by rheostatic control actuated by the air receiver pressure.

M. Bertin, of the French Navy, states that a good compressor will not use half the steam that is used where steam atomizing is employed, for steam will compress more than its own weight of air up to its own pressure; and it can hardly be doubted that for naval and marine purposes generally the use of air for atomizing must eventually become general.

In the foregoing calculations the compression of the air has been assumed to be adiabatic. This is not strictly correct even in uncooled cylinders, and some distance from correctness in cooled cylinders, but any error is on the right side, and it is better to proportion the air compressors on an adiabatic basis, so that there may be a fair allowance of power.

As already stated, where the index of the adiabatic curve is $y = 1.4$, and that of the isothermal curve is $y = 1.0$, practical work may be done at values of $y = 1.2$. Expanding air becomes so very cold that between the compressor and the atomizer air should be heated as hot as possible, in order to counteract the chilling effect.

For compound compressors, which so far hardly come into the sphere of liquid fuel work, the power required to compress up to an absolute pressure of 2, 4 or 6 atmospheres is as follows, compared with adiabatic compression in a single-stage machine—

Pressure in Atmospheres. Absolute.	Ratio of Power. $W_2 ; W_1$.	Probable Ratio in practice.
2	.951	.975
4	.901	.950
6	.871	.935

Even in single-stage compression the actual power required in a cooled machine will probably be about midway between the figures for adiabatic and two-stage intercooled work. See column 3 above.

As explained elsewhere, the economy of cooling is doubtful ; though if there are suitable means of heating the air, it is expensive to heat it by expending power upon it.

In the following table is given the horse-power necessary to compress one pound of air to 2, 4 and 6 atmospheres pressure absolute from the ordinary temperature of $60^\circ\text{F.} = 15.5^\circ\text{C}$. The figures are for adiabatic compression of one pound per minute—

Absolute Atmospheres.	Horse Power.	Actual h.p. of driving motor.	Gauge Pressure.
2	0.645	0.860	14.7 lb.
4	1.433	1.911	44.1 ,,
6	1.972	2.629	73.5 ,,

The difference between adiabatic and isothermal compression is of no serious account up to 30 lb., or even to 45 lb. The volumetric efficiencies of good compressors at these low pressures may be safely taken at 90 per cent. of the piston displacement. The efficiency of the machine being, say, 75 per cent. overall from engine to compressor, the indicated horse-power actually required will be found by adding one-third to the figures in column 2, whence is found column 3.

Apparently, therefore, air for atomizing may be compressed by one horse-power to the extent of about 60 pounds weight per

hour. Now, one horse-power in a good steam engine will consume, say, 16 lb. of steam per hour, or, say, 20 lb. per electrical horse-power hour, so that under favourable circumstances 1 lb. of steam should compress 3 lb. of air; and air should, apparently, be the better agent to employ, quite apart from the advantage at sea of not wasting fresh water. Further experiment is, however, required to afford reliable and fuller figures before a hard and fast ruling can be even attempted. The Author's own opinion is in favour of air heated to a considerable temperature and more or less charged with moisture to assist in preventing fouling of the atomizers.

Flow of Air.

Mr. D. K. Clarke gives the velocity of air flowing from any pressure P into any other lower pressure of not more than $\frac{5}{8}$ of P as 880 feet per second.

Actual experiments upon orifices having a length greater than their diameter give about 750 feet per second.

The following results were obtained—

50 lb. gauge pressure blowing through	$\frac{3}{8}$ " nozzle to atmosphere	=775 ft.
30 " " " " "	$\frac{1}{2}$ " " " "	=725 "
45 " " " " "	$\frac{1}{2}$ " " " "	=778 "
16 " " " " "	$\frac{5}{8}$ " " " "	=725 "
25 " " " " "	$\frac{5}{8}$ " " " "	=748 "
7 " " " " "	$\frac{3}{4}$ " " " "	=898 "
25 " " " " "	$\frac{3}{4}$ " " " "	=675 "

The last two results were doubtful.

It will be safe to count upon a velocity of 750 feet in making calculations as to the weight of air which will pass an orifice. The above velocities are calculated, of course, on the air at the higher pressure. The weight of air is proportional to the absolute pressure, twice as much air escaping at 35 lb. gauge pressure as at 10 lb., that is to say at 50 lb., and 25 lb. absolute.

On the relative economy of air or steam for atomizing, Professor Williston says unquestionably that air at 2 to 5 or even 10 pounds per square inch is more economical than steam, so far as the spraying is concerned. At higher pressures there is a doubt as to economy, for the cost of compression increases rapidly with the pressure, and the atomizing capacity of the air does not increase at the same rate. Thus in the U.S. Navy tests the most economical results were found with air pressures of only one or two pounds. All atomizers will not work at this pressure. At these low pressures, however, less than two per

cent. of the steam generated would compress the air. At an air pressure of four or five pounds, four per cent. of the total steam was required to compress the air. Obviously, where atomizers will act satisfactorily, it will be advantageous to use much air at a low pressure in order that the combustion may be improved, for air must enter the furnace, and in air atomization there is not the risk of fire extinguishment that there is with steam.

CHAPTER XVIII

THE ATOMIZING OF LIQUID FUEL

SINCE liquid fuel of the heavy varieties cannot be burned except by atomizing, the burner, injector, sprayer or atomizer, as it is variously termed, is an important detail.

Its object is the pulverizing of the liquid, so that, mixed with air in the act of pulverization, and supplied with any further amount of air that may be necessary, the liquid atoms may burn like vapour.

The spray must not be so directed than an intense blow-pipe flame impinges severely upon any small area of furnace plate. It is sought to fill the furnace with a full soft voluminous flame which shall envelop its whole interior. Given a sufficiently long space in front of the burner, a spray directed straight ahead and coning out would doubtless produce a satisfactory effect, but the space between the point of the burner and that part of the cone of flame which first touched the furnace plate would be of little use as heating surface. What should be aimed at is such a burner and spray device as will produce a certain disruption and outward expanding effect, so as at once to spread the oil to a considerable extent normally to the axis of the burner as well as parallel; to give a sort of balloon effect, so that, in a locomotive boiler for example, there shall be flame well to the back of the box as well as forward under the arch. Various forms of atomizers will be found illustrated in this or earlier chapters, including—

- | | |
|-----------------------------------|---------------------------------|
| The Holden (Figs. 23, 24 and 25). | The Billow (Fig. 44). |
| The Baldwin (Fig. 34). | The Aërated Fuel Co. (Fig. 67). |
| The Urquhart (Fig. 42). | Kermode's Burners (Figs. 68, |
| The Hydroleum Co. (Fig. 71). | 69). |
| The Swensson (Fig. 73). | Orde's (Fig. 15). |
| The Guyot (Fig. 75). | Körting's (Figs. 21, 21a). |
| The Rusden and Eeles (Fig. 66). | The Höveler (Fig. 65), p. 267. |

The Holden Atomizer.

The Holden Injector (Figs. 23, 24, 25) consists of a gun-metal casing with oil, air and steam inlets. Air comes in at the back,

preferably hot, and is delivered at the point where the oil escapes to the inner nozzle. Steam comes between the oil and air, and the mixed jet escapes forward and slightly laterally by two orifices. A further air supply is directed upon the spray by a ring of several fine jets of steam. The atomized fuel is directed along the plane of the fire when the fire-bars are retained, as this gives the best action. Mr. Holden does not confine himself to the use of steam as an atomizing agent, but recognizes that air may be preferable for chemical reasons. Two burners deal with about six pounds of oil each per mile, or, say, 240 pounds her hour.

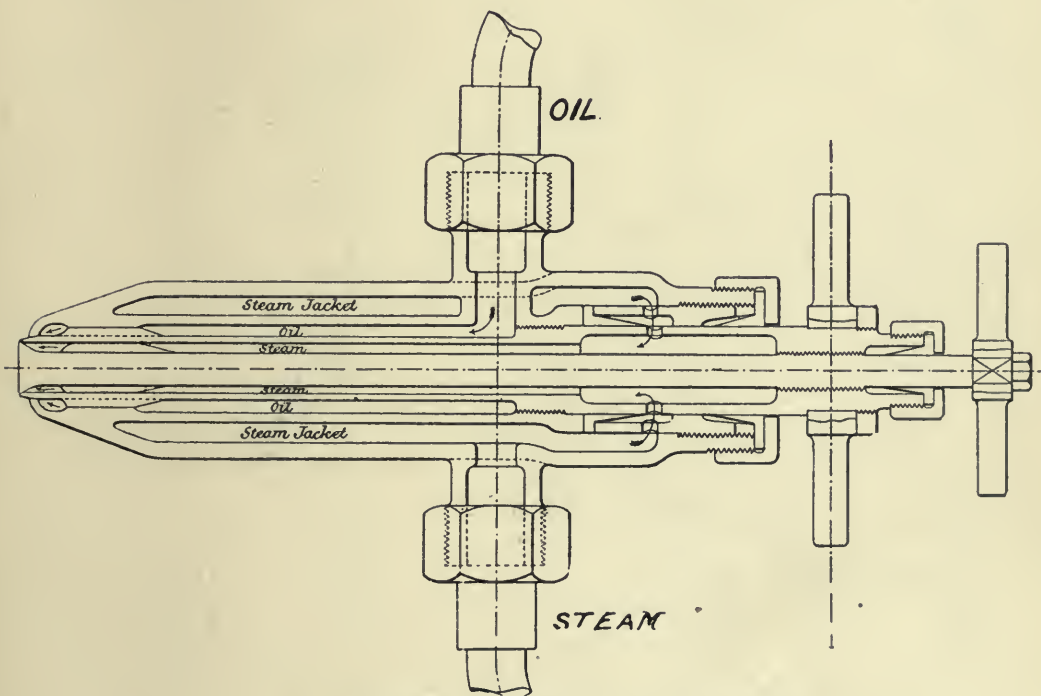

Fig. 66. ATOMIZER. RUSDEN-EELES.

Rusden and Eeles.

In this burner (Fig. 66), steam escapes by a central annular jet, and is directed outwards on a fine annular jet of oil, which is heated also by a steam jacket. This disposition gives a balloon flame. The burner is largely used in marine work.

The Urquhart.

This (Fig. 42), one of the earliest successful atomizers, employs central steam, external air, and an annular oil jet between the two, the expansion of the steam atomizing the oil into the air and mixing the two.

The Baldwin (Fig. 34).

The burner is very simple, being simply a broad thin jet of steam which is directed upon oil escaping from a parallel passage. It could not well be simpler, but it is claimed to act well, and there appears no reason to doubt this.

The Aërated Fuel Company's Burner.

This is of the central air jet type, as shown in Fig. 67.

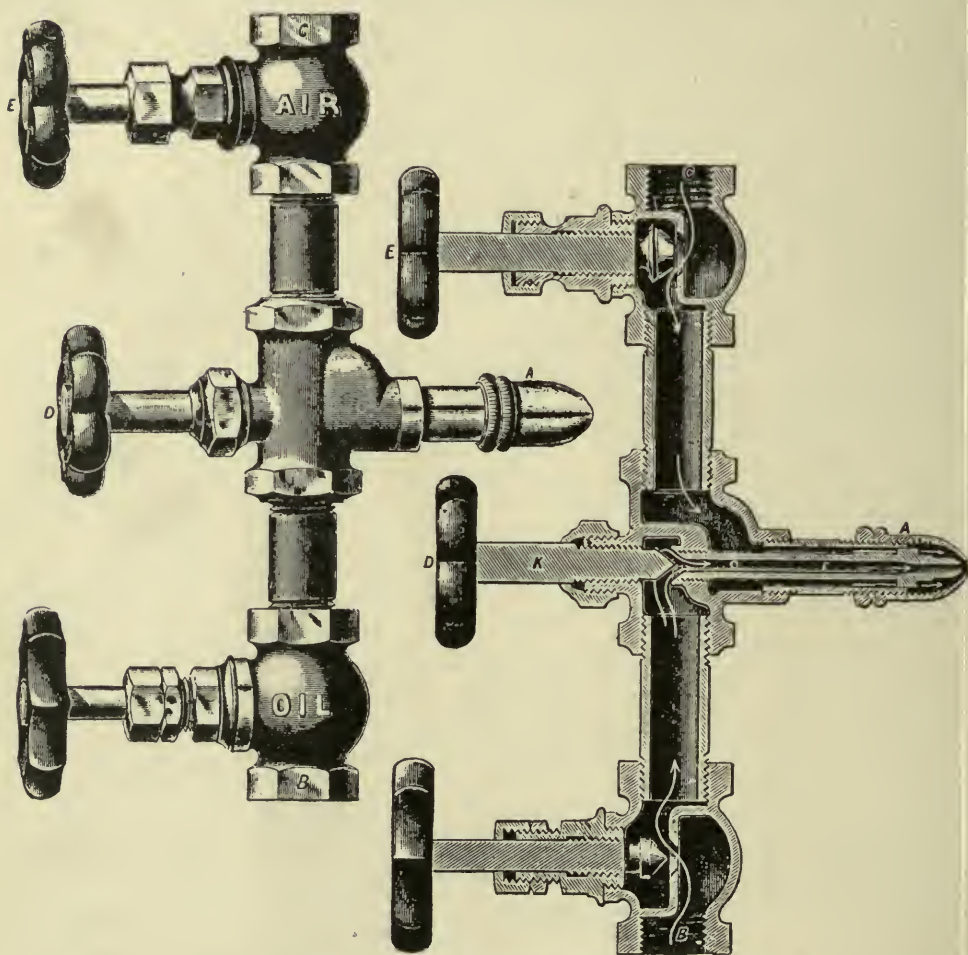

Fig. 67. ATOMIZER. AERATED FUEL SYSTEM.

The Kermode Burners.

The latest type of Kermode burner is the pressure-jet burner specially designed for naval and other vessels, and recommended for use with forced or induced draught. The burner is shown in longitudinal section and in plan respectively in Fig. 68. The oil enters through the channel A, and passes between the outer wall D and the inner cylinder B, which abuts against

the cap-nut E. The end of the cylinder B is an exact fit in D where it abuts against the nut E, and in this end of B a number of grooves are cut parallel to the centre line of the burner, while there are similar grooves in the end of the part B at right angles to the axis of the burner. These grooves are shown at H, and they are tangential to the cone end of the spindle C, which serves to contract, or enlarge, the opening through the cup-nut E. The movement of C is indicated on the graduated wheel F.

The oil fuel is pulverized by being forced through a restricted

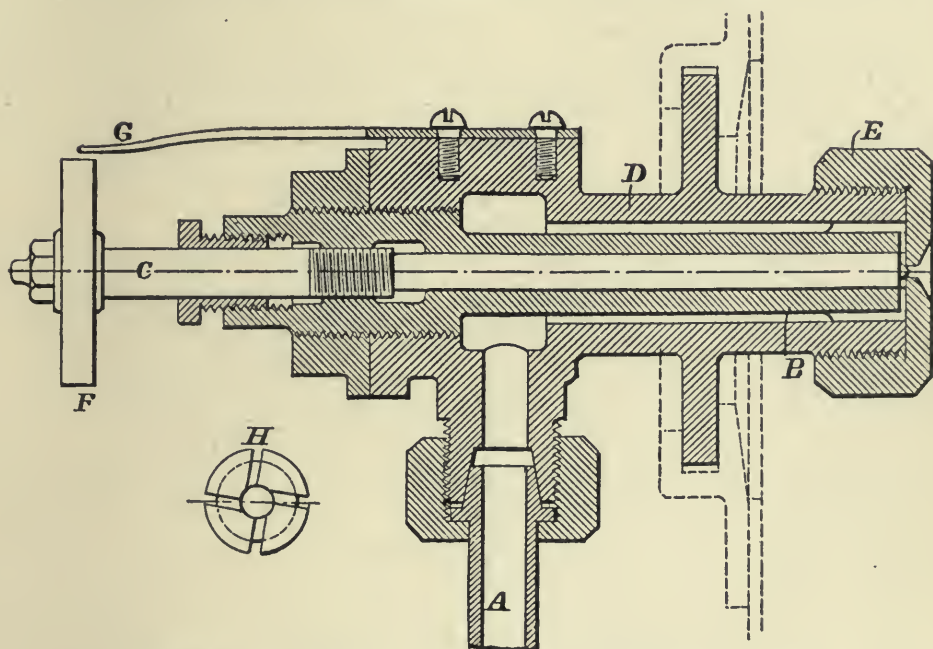

Fig. 68. ATOMIZER. KERMODE'S PRESSURE SYSTEM.

opening with a rotary motion, which is given to it by the tangential grooves in the face of the plug B, and it is distributed in the form of a cone by means of the reaction or deflection which is set up by the oil impinging on the cone end of the spindle C, the pulverization being effected by means of the pressure which is brought to bear upon the oil fuel itself by means of a force-pump. The oil is heated and filtered. The fixed pointer marked G serves to indicate the degree to which the wheel F has been rotated, to increase or diminish the opening through the nut E.

Fig. 69 shows a section of the latest Kermodé hot-air burner. In this burner the oil is partially vaporized and sprayed by hot air at a pressure of half to four pounds, the industrial furnace working with the former pressure and the naval boiler calling

for 3 to 4 lb. Oil enters at A, and is regulated by the wheel E and the valve on spindle D. Hot air enters at B and C and the long helix K gives a rotary motion to the oil and air and insures that none of the oil vapour will pass through the tube untreated. The supply of air can be regulated at two points by means of hand wheels, pinions, and racks; one pinion L moves the internal tube over the oil-delivering nozzle F, and regulates the air which enters there. The second pinion M operates the outer tube, and varies the amount of air escaping around the mixed jet at the end of the twisted spindle K. All the elements of the combustion are under complete control. The oil as it trickles from the nozzle beyond the valve is swept forward by a sharp current of air which envelops the nozzle; this current can be regulated with great exactitude. A further compressed air supply is given where combustion

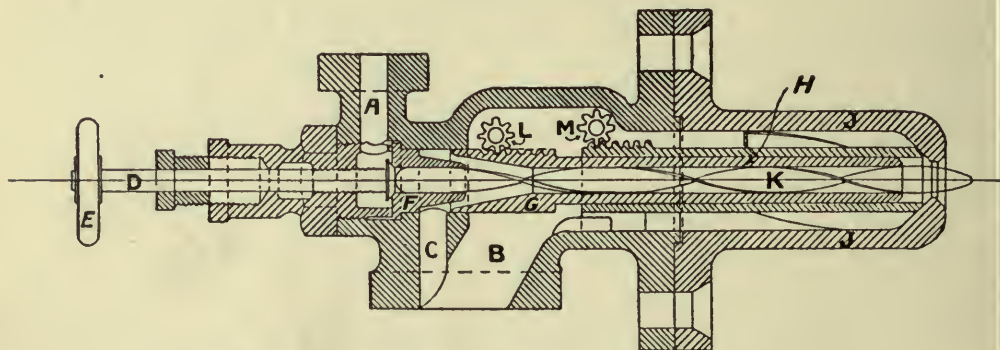

Fig. 69. ATOMIZER. KERMODES HOT AIR SYSTEM.

is about to commence, while a third supply is caused by the induction of the flame or by the draught; this latter supply comes through the fire-bars, and in special cases through a hollow furnace front, passing between the inner and outer plate, and escaping through a coned opening around the burner. No change in the arrangement of the furnace as designed for the use of coal is necessary, and to equip the furnace for burning liquid fuel it is only necessary to cover the fire-bars with broken fire-bricks to a depth of from 6 to 8 in., the greater depth being towards the bridge. The burners are arranged to hinge on the air and oil cocks which are attached to the boiler, and if it is necessary to examine the front of the burners they can be withdrawn from the furnace, the act of withdrawing shutting off the supply of air and oil, and thus preventing accident.

Fig. 70 shows the steam and induced air burner. The oil is pulverized by a jet of steam. Oil enters centrally through the branch B, and has a whirling motion imparted to it by the

stem of the oil valve G. Steam enters around the hollow cone H, passing through slots in the cylindrical portion where this fits into the hollow of the air cone, the whole oil supply is thus steam-jacketed. The air cone is F, and this is also fitted with spiral guides. The air is drawn in through these guides by the inductive action of the steam, its amount can be adjusted by

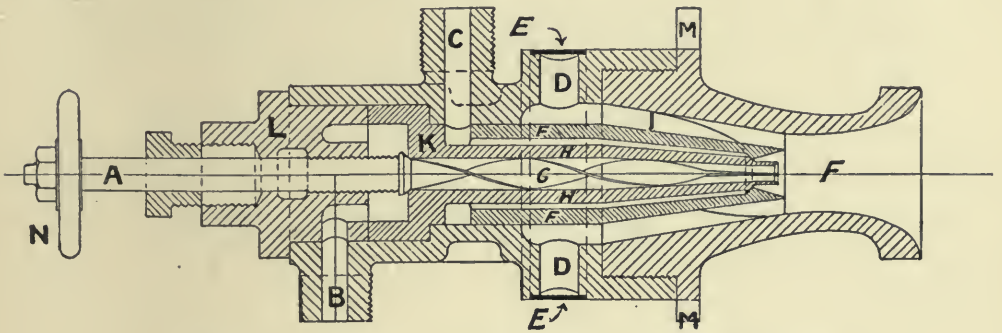

Fig. 70. ATOMIZER. KERMODE'S STEAM SYSTEM.

opening or shutting the openings D, by means of the movable perforated strap E. The front portion F is arranged to screw in or out as a whole, being turned by the spider M. In its motion it carries with it the air cone F, and thus leaves a greater or less space between this and the oil cone H, for the escape of steam. The range of adjustment is large, and the same burner may be used for different powers within wide limits.

The Hydroleum System

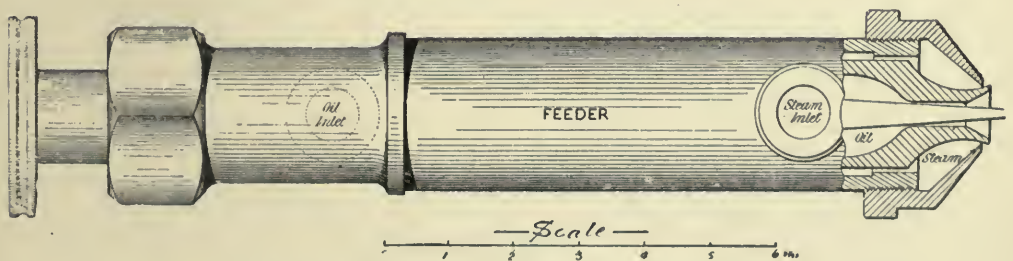

Fig. 71. ATOMIZER. HYDROLEUM SYSTEM.

Fig. 71 shows the nozzle of the Hydroleum Company's burner. Oil is centrally regulated by a needle, and issues from a mouth-piece flared out externally in such a way as to direct the atomized spray slightly outwards, the oil being in the middle. The oil mouth-piece is in advance of the steam, and an inductive action is produced which draws the oil forward when communi-

ation is opened with the reservoir. The Author has seen this burner acting well with tar as fuel.

External hand wheels regulate the position of the oil and air cones, and vary the amount of air allowed to escape round the nozzle.



Fig. 72.

In Fig. 72 this is shown developed somewhat, the steam pipe being swaged, to form a jet, and drilled to admit the oil. The flame of this burner is small, and produces intense local heat, and must in boiler work always be accompanied by plenty of suitable brickwork. This form is used in various forms in South Russia.

Of self-atomizing oil-jets the Körting (Figs. 21 and 21a) has

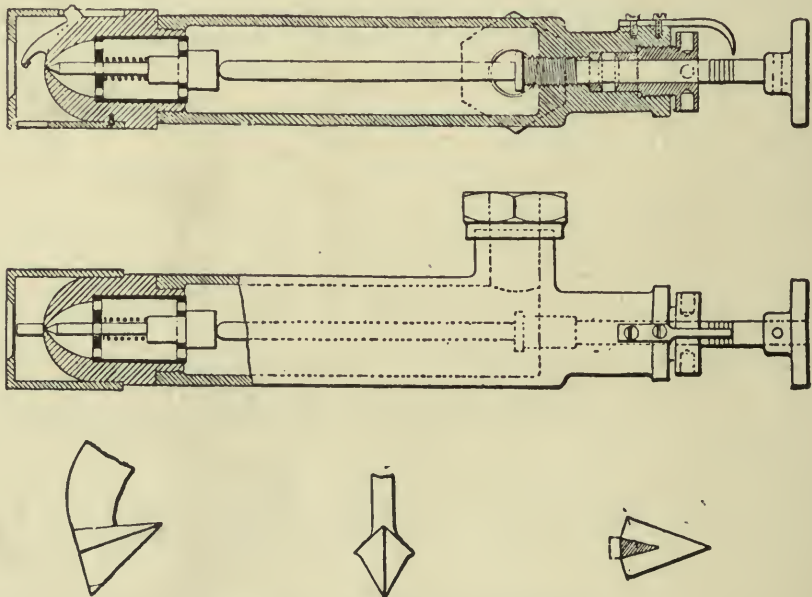

Fig. 73. SWENSSON ATOMIZER.

been considerably employed at sea, and is described under the head of the Körting System, p. 153.

Another self-spraying oil-jet is the Swensson (Fig. 73), in which the oil passes through a fine jet, and is divided into spray by striking a cutter placed a little in front of the orifice. These self-sprayers have a certain advantage of simplicity. No

bulky air pump is required, to compress air, for atomizing the oil. There is no waste of fresh water as in steam atomizing. A small oil pump will spray all the oil of a large steamship, as a simple calculation will show. With a horse-power of 5,000 there may be used 5,000 pounds of oil per hour, or, say, 10 gallons per minute, which would fill a three-inch pipe 400 inches long. Thus a three-inch oil pump with a six-inch stroke, if run at sixty-seven strokes per minute, or, say, thirty-four revolutions, would feed oil for 5,000 horse-power, and two or three smaller pumps would in practice be employed in any ship. The oil pumps are thus very insignificant in size, and this fact will popularize the self-spraying atomizers if they prove satisfactory under ordinary conditions. Of course, the oil will not spray unless heated sufficiently to be limpid and easily flowing. If too viscous it will spray in strings, and not burn as thoroughly as it should.

*The Symon-House
Burner.*

This is one of the vaporizing burners which use the paraffin or kerosine grades of oil, a cellular reservoir above the flames serving as the vaporizer through which the oil travels in a long circuitous course, passing down the pipe to a turned-up jet below, this being regulated by a needle, and surrounded by a cone which conducts air to the flame. Preliminary heating by a lamp of petrol or alcohol is necessary. This burner is used for small launch boilers, and is shown in Fig. 74.

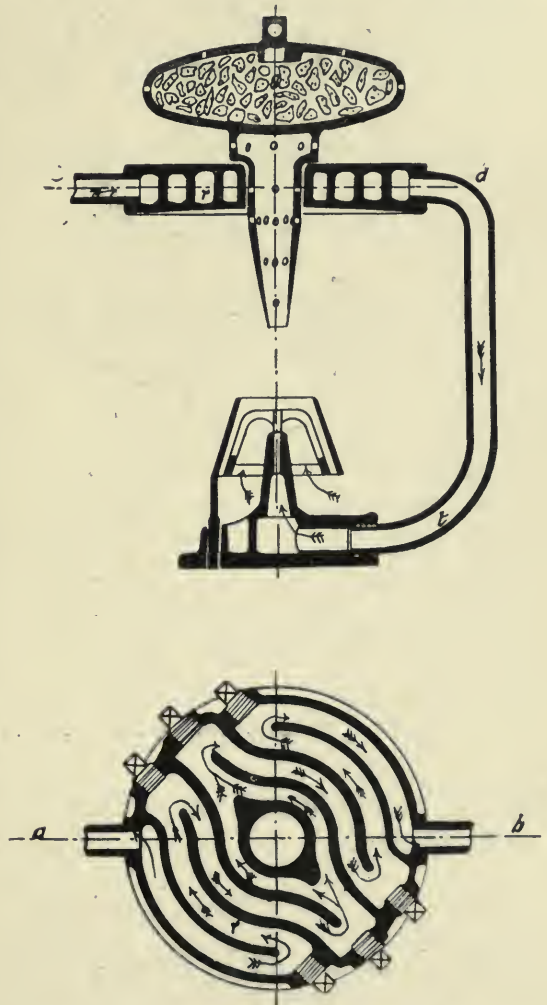

Fig. 74. SYMON-HOUSE BURNER AND VAPORIZER.

It is claimed that in small work atomizing produces too intense a heat, and that vaporized petroleum is better. Steam can be raised to 100 pounds pressure in twelve or fifteen minutes, and by means of the igniter above the vaporizer the fire will relight after several minutes if put out by a sudden jar or a gust of wind. The igniter consists of a hollow disc full of broken fire-brick.

In the French navy the Guyot burner has been much used. This is shown in Fig. 75, the oil entering centrally and being impinged upon by an annular jet of air or steam. The atomiz-

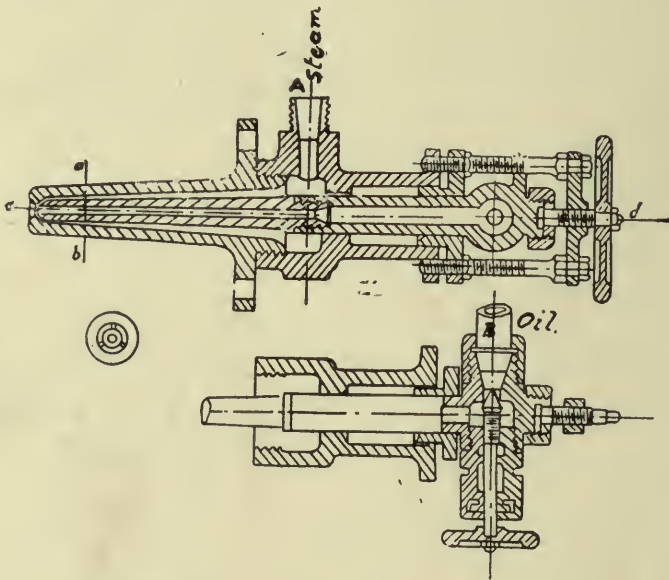

Fig. 75. GUYOT ATOMIZER.

ing nozzle should not project as in Fig. 76, but should be kept short, as in Fig. 77.

The Atomizing Agent.

Though in the early French trials of 1887 as much as 1.2 pounds of steam was used per pound of oil, the quantity was gradually reduced until, in 1893, less than half a pound of steam was used in the Godard boiler, says M. Bertin, and in 1895 M. Guyot got down to as low as 0.25, results which also have been obtained in the Italian Navy. Indeed, on a Schichau torpedo boat as low as 0.102 is claimed.

Compressed air, said M. Bertin some years ago, has some theoretical advantages, because a given weight of steam will compress up to its own pressure a weight of air superior to itself, and the pulverizing effect of a jet depends on the energy

of the jet rather than upon its volume. Probably the resistance of the machine overbalances any theoretical advantage, but at sea the loss of fresh water, where a steam atomizer is employed, must amount to about 5 per cent. of the total steam generated. M. Bertin, however, said that a good air compressor will not use half the steam necessary where this is used direct. When starting from the cold boiler, the compressed air may be raised by a small compressor driven from a storage battery, by a small petroleum engine, or by hand. Steam atomizing is open to the objection that should priming occur the fires may be extinguished, and where the steam comes over wet, from a priming boiler, it is quite common for burners to be extinguished, and the red-hot brickwork fails to ignite the oil, and it is necessary to do this by means of a flaming torch. Steam should therefore be superheated, both to render it dry and to improve its general action.

M. d'Allest found in *l'Aude* that atomizing by steam used up 15 per cent. of the total steam produced. A little later, at Cherbourg, the Torpedo-boat 22 used as little as 1.2 k., and the *Buffle* only 0.75 k., per kilo. of oil pulverized, until

finally the results as detailed above were secured, though actual facts are not easy to obtain, and tests require to be undertaken with a special boiler to supply atomizing steam. Results of 0.5 and 0.7 are frequently obtained, and have gone below 0.3.

Such a figure as this is to be considered very good indeed. To save fresh water at sea is so much to be desired that could compressed air be substituted for steam it should be. M. Bertin, formerly favourable to air as more economical, saw reasons to change his views. Air was necessary at much higher pressure than that required for forced draught. It is affirmed that 1.4 k. of steam at 6 k.

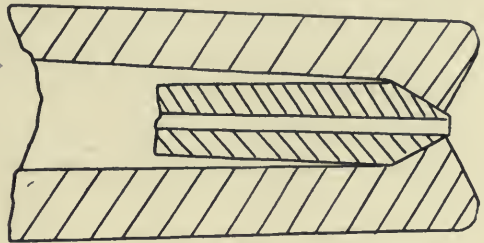

Fig. 76. NOZZLE OF GUYOT ATOMIZER.
INCORRECT FORM.

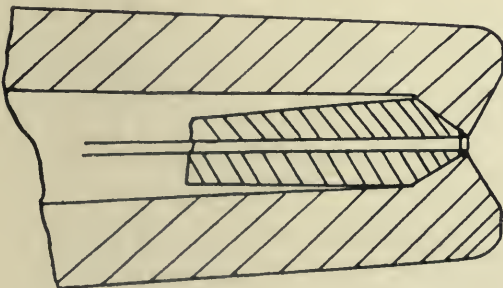

Fig. 77. NOZZLE OF GUYOT ATOMIZER.
CORRECT FORM.

pressure must be expended to compress 1 kilo. of air to 1.5 k., and more air must be expended to pulverize each unit of oil as compared with steam. Thus Torpedo-boat 60 at Cherbourg expended 0.6 k. to 0.8 k. of air in place of 0.4 k. of steam.

During a test at Indret not less than 0.5 k. of air was expended. In brief, with ordinary apparatus to obtain 2 k. of air, which is needed to do the work of 1 k. of steam used direct, one must use 3 k. of steam in the compression engine.

The difficulty is that compression is slow in an ordinary

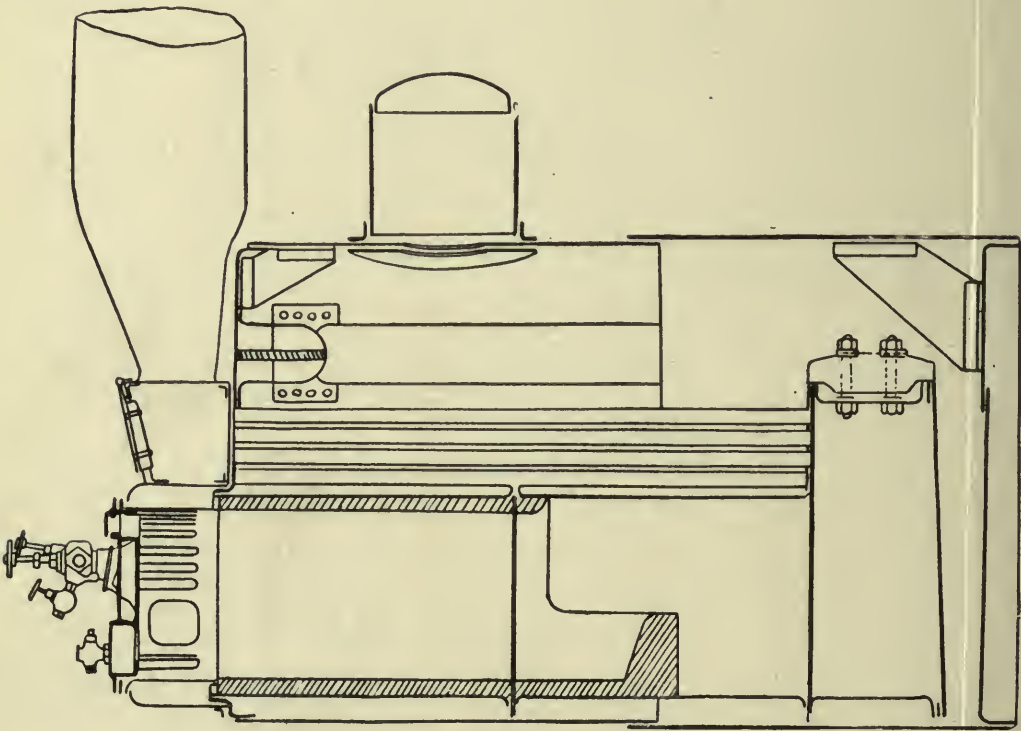

Fig. 78. BOILER OF FRENCH TORPEDO-BOAT No. 22.

machine, and steam cannot be used economically, for the air attains its highest pressure when the steam is ready to exhaust, and a heavy flywheel is necessary to help the expanded steam. M. Bertin is further impressed with the physical and chemical advantages of steam, which, he affirms, secures the Ragsine effect as utilized in the distillation of petroleum without cracking, owing to a certain solvent action of steam on petroleum, as yet little understood.

The particular form of the Guyot atomizer (Fig. 75) is that of Torpedo boat No. 22, the furnace of which is shown in Fig. 78, the boiler being of return tube type. M. Bertin finds

from French experience that though regulation of an oil atomizer is most delicately effected by means of the central needle of the feed water injector, yet a valve is a less delicate detail, and many atomizers have no central moving cone, but are regulated solely by valves.

It is necessary when atomizing that the steam should flow at a certain speed. If too rapid, the flame is extinguished; if too slow, there is incomplete pulverization, and the oil escapes in drops too large to burn well.

Hence the steam orifice must be regulated to suit the boiler pressure.

The opening for oil should not be less than 1 mm. = $\frac{1}{25}$ inch. If too large the oil flows in too great a quantity. It is essential that steam or air and oil shall be capable of regulation when at work, and that the interior of the atomizer should be readily removed while at work, so that the orifices can be cleared quickly and the whole replaced immediately.

After numerous experiments with atomizers producing both thin flat jets, and thin annular or cylindrical jets, M. d'Allest devised the atomizer of Fig. 79, for which are claimed the best results in regularity of effect and steady working. It is very simple in form, and can be rapidly dismounted for cleaning. It consists of an outer case containing an inner cone and spindle; a steam inlet at the side *N* admits steam to the casing. The whole is attached to a conical mouthpiece. Steam is regulated by a valve, and escapes round the two cones, while oil comes round the central spindle.

Air is induced through the surrounding opening *R*.

The cone can be screwed upon the nose of the case for partial adjustment of the steam, which is further regulated by a valve in the steam pipe. M. d'Allest places these vaporizers, if necessary, in couples in one furnace, connecting them to the same oil pipe to the number of three, or even four.

Each burner will dispose of from 10 to 80 kilos. = 22 to 176 pounds of oil per hour. Two burners, using each 80 kilos. of oil, will evaporate 13 kilos. of water per kilo. of oil, or say 2,080

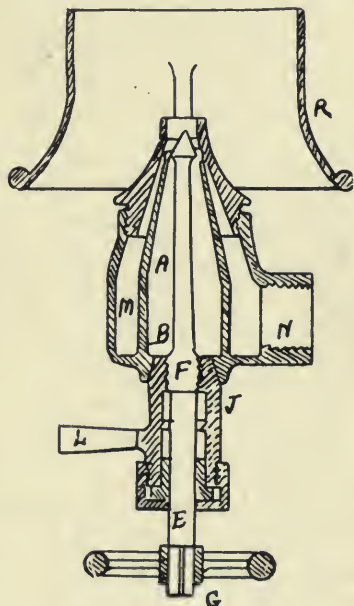

Fig. 79. D'ALLEST ATOMIZER.

litres per hour = 4,576 gallons. Allowing 30 litres per square metre of heating surface; about 6 pounds per square foot; these two burners should serve a boiler of 70 square metres of heating surface or 753 square feet.

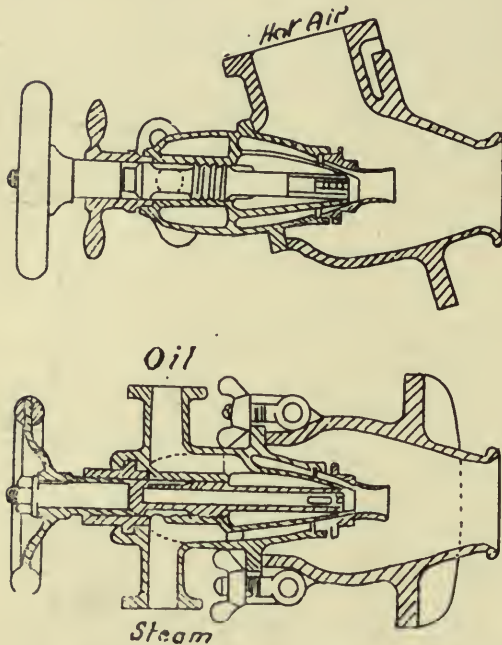

Fig. 80. D'ALLEST DOUBLE ATOMIZER.

In a torpedo boat, however, the desired evaporation exceeds this amount per square metre. With this in view, M. d'Allest has designed a double atomizer, in which oil is admitted round the central tube in an annular jet. Steam comes outside this, and hot air is induced round the whole, the heating being effected by a tube in the chimney. This apparatus (Fig. 80) will burn as much as 400 kilos. = 880 pounds of oil per hour without a trace of smoke.

It was tried in *l'Aude*, one of the ships of the Compagnie Frassinet. A weight of 120 kilos. of oil per hour = 264 pounds, produced 170 horse-power, the evaporation being 14.1 units of water per unit of oil, but the French Navy considered 12 units as the maximum that should be calculated upon.

Evardofski System.

This system applied to locomotives consists in the placing of an atomizer in each wall of the furnace two and two exactly opposite, the jets meeting centrally and promoting mixture. The grate is covered with fire-bricks, between which air enters.

Though a special pulverizer was used, it would appear that any atomizer could be arranged on this system.

The Brandt burner consisted of a circular box, with a tapered slot all round it nearly closed by the edge of a disc. Steam escaped under the disc and oil above it. The burner was set in the middle of the fire-box and gave a large hollow flame, but it had the disadvantage of being inaccessible when at work, and the flame was easily extinguished, as by the slipping of the

wheels of a locomotive, the sudden pull of the blast extinguishing the flame and chilling the box.

The Soliani burner (Fig. 81) is of simple form, resembling the scent spray.

There are numerous other forms, some complex, others crude, but to enumerate all would occupy great space, and serve no good purpose. Those illustrated will show the general trend of practice and what has been done, the chief point being apparently that the annular form of jet is preferable and conduces to best mixtures.

The difficulty with burners which vaporize has been the deposit of carbon. This will occur even with kerosene, the carbon being a pulverulent coke. The difficulty was got over by M. Serpollet by means of easily replaced burners. Heavy oils can then be burned. Too high a heat seems to be the cause of carbon deposit, the oil being "cracked" exactly as in a highly heated still. At present not much is being done by vaporizers, at least for large powers, the atomizer becoming more general.

On the question of pre-heating, the French Naval tests are in accord with others as to the advantage of this.

Long recognized as an advantage to heat to $80^{\circ}\text{C.} = 176^{\circ}\text{F.}$, it is to-day established that Mazout may well be heated to $132^{\circ}\text{C.} = 269.6^{\circ}\text{F.}$

At this temperature the fuel gives off a certain amount of vapour, which raises the pressure in the burner, helps the velocity of the jet, and ignites promptly at the nozzle, and assists the combustion of the whole. Heating the oil raises the efficiency of the combustion, cuts short the flame, and increases the effect of the heating surface.

It is not desirable to generate too much vapour at the orifice of the atomizers, or no air can gain access to the jet, and combustion cannot occur. Air admixture is, of course, necessary, and when atomizing is done with compressed air this is a mere fraction of the total air required. The air itself is best heated, especially if this can be done by recuperation of otherwise wasted heat.

The object of an atomizer is to fill the furnace with flame, and the furnace must avoid contact with the flame pending complete combustion. The accomplishment of these various ends has brought about the many forms of atomizers already described. All of them bear a strong family resemblance. In Russia

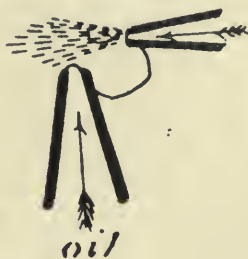

Fig. 81. SOLIANI BURNER.

there appears a tendency to employ flat jets. Hence also the various forms of furnace with their refractory linings of fire-brick, as in Fig. 82 annexed, which represents a boiler made at Cherbourg in 1893, and bears a general resemblance to the much older forms devised by Urquhart. In this boiler the atomizers are placed as shown in the side walls of the furnace.

Railway practice in America tends to the use of flat jets. On the Southern Pacific Railway a simple atomizer, which allows the oil to fall from an orifice over the front of a flat steam jet, has this jet $3\frac{1}{2}$ inches wide. The petroleum escapes at an orifice half an inch high and of the length of three inches, the steam opening being about 0.8 mm. high, or $\frac{1}{32}$ inch. The

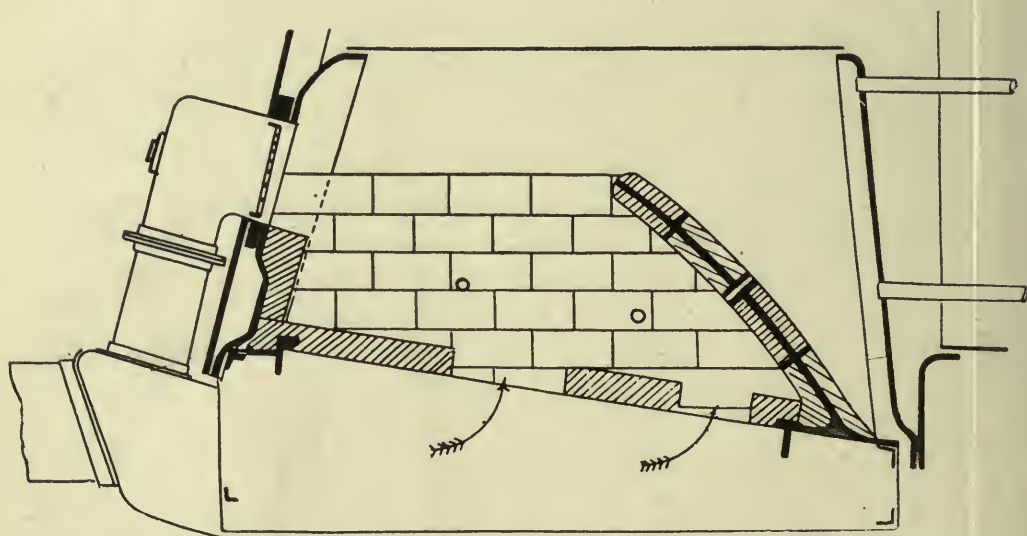

Fig. 82. LOCOMOTIVE TYPE BOILER TESTED AT CHERBOURG WITH LIQUID FUEL.

width of the jet of steam is $3\frac{1}{2}$ inches, extending $\frac{1}{4}$ inch at each end below the flow of oil, so that no oil escapes unatomized. Flat pulverizers are stated by M. Bertin to be suitable for boilers of the Belleville or Nielaussé type, in which the flames rise directly from the grate to the water-tubes. The broad flat flame probably burns over a wide area, and does not enter between the pipes so rapidly as if it were a less wide spreading jet.

Should a pulverized jet encounter a cold boiler plate at a temperature of 400° to $500^{\circ}\text{C.} = 752^{\circ}$ to 932°F. , the oil will condense on the plate and not again ignite.

In the boiler of Torpedo-boat No. 22 (Fig. 78) the furnace is fitted with an air advance chamber in which oil is atomized and meets air streams admitted radially. The furnace is

brick-lined, with a low striking bridge. In this boiler 11·6 kilo. and 10·8 kilo. of water have been evaporated per kilo. of oil with a draught of 20 to 30 mm. (1 inch mean) of water. At heavier draughts of 95 to 110 mm. water gauge (or a mean of four inches), only 9·45 k. and 8·5 k. were evaporated. A similar boiler, with the air arriving parallel with the jet, however, evaporated 13·25 k. of water, which shows the difference due to arrangements.

It may be stated finally, that, of all atomizers, the more successful are those which atomize the oil right at the nozzle or point of exit. This class appears least liable to choke with dirt or to permit of the oil becoming carbonized within the body of the atomizer.

Where atomizers are applied through the furnace door they are arranged to swing back upon a trunnion hinge so designed as to shut off the fuel supply when the atomizer is swung back.

The body part on which the atomizer branches are connected swivels in the two end pieces through packed glands and these end pieces receive the oil and steam or air pipes which supply the fuel and atomizing agent.

The tendency at the present time seems to be somewhat in the direction of doing without both air and steam as atomizing agents and relying entirely on the pumped pressure of well sieved and heated oil to effect the necessary atomization.

CHAPTER XIX

METALLURGY. THE HÖVELER PROCESS

IT is outside the intended scope of this book to deal very seriously with the metallurgical applications of liquid fuel. The author dealt with this at some length in *Liquid Fuel and Its Combustion*.

Since that book was written there has been perhaps fully as much progress in the metallurgical application as in power application.

If in a furnace, ore or metal is acted upon too close to the point of initial combustion of the oil the flame will be powerfully oxydizing and therefore inoperative for reducing work. As shown in the above book, the oil must be burned in a separate chamber, in advance of the working furnace.

This is accomplished in the "Höveler" system by placing the oil atomizer, actuated by compressed air at 15 pounds pressure, behind a small conical retort lined with refractory material. Ignition occurs as the atomized jet enters this cone, the flame tapering outwards within the cone and coming out by a circular orifice. This apparatus can be carried about on a wheeled standard or slung in a chain and placed outside any furnace it is desired to heat. The cylindrical bar of flame passes through an opening of its own diameter—a few inches—and will maintain the interior of a large rotary furnace, or of an air furnace at a high temperature. By suitable regulation the effect obtained can be oxydizing or reducing according to the amount of air admitted. By this system very high efficiency of the fuel is obtained, but as in all metallurgical processes which involves high temperature work the effluent gases must inevitably carry away heat proportionate to the temperature.

The atomizer of the Höveler system (Fig. 65) receives the oil via *a* in a central tube *h*, in which is a needle stem *f* that converts the orifice into an annulus *c*. Compressed air comes via *b* outside the conical end of this oil tube by the tube *g* and the atomized jet is discharged into a cone *i*, through which atmospheric air is induced to flow via *d*. The treble mixture issues

by a parallel opening *d* projecting through a larger opening *e*, which can be made to supply a further amount of compressed air if needed via *c*.

For a reducing flame the compressed air is supplied at only 10 pounds pressure, and in reducing ores or oxides small coal may be mixed with the stuff to be reduced, its duty being to supply carbon the more energetically to absorb the oxygen of the heated material. The use of liquid fuel in metallurgical work possesses all the advantages of convenience, cleanliness, control and time saving which appertains to its use in steam raising, and in metallurgy there is also a marked economy in the percentage of reduction and improved product. Though much dearer per ton than coal, liquid fuel gains very consider-

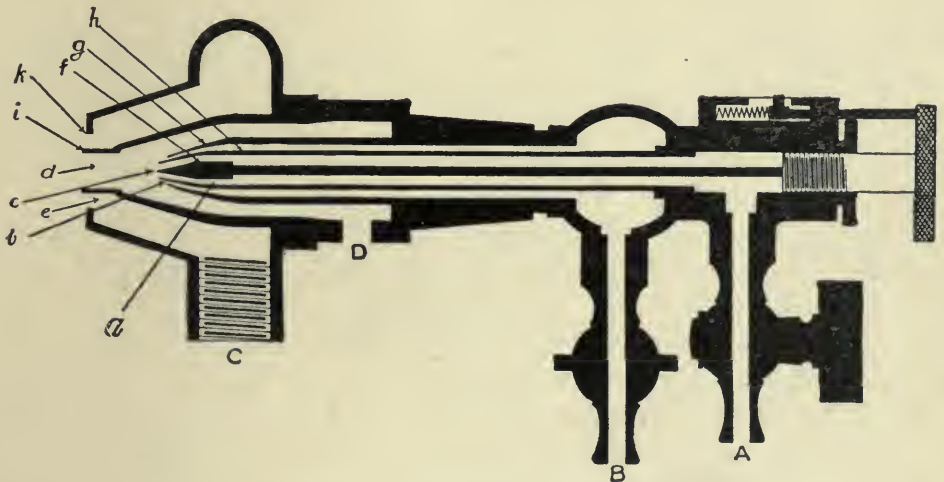

Fig. 65. HÖVELER ATOMIZER.

ably by reason of the amount of it that is *not* used, for, where a heat must be maintained to the last the coal fire is left large and active, but the oil flame is shut off at once. Oil gains by reason of superior efficiency in the application of the heat produced.

The Aërated Fuel Process.

This process of the Gilbert and Barker Co. of New York is simply a system of atomizing by compressed air, and is used in all manner of industrial arts, the flame being used direct in metal work, glass making, japanning, etc. The apparatus includes an air compressor, oil pump and receiver, storage tank and the burners and necessary pipes.

Compression is to 15 pounds per square inch, a pressure below which it is stated that the fuel is not perfectly atomized.

The oil pump is itself worked by the air, and serves to keep a full receiver of about 30 gallons capacity (25 imperial gallons). The receiver also contains compressed air which forces the oil to the burner (Fig. 67), where it meets the air coming direct from the compressor. Valves regulate the proportions and the air pressure preserves even working conditions, whether two or twenty burners are at work. It is claimed that the combustion is really gaseous, clean and smokeless. The main supply is a buried tank outside the building and away from the burners. The oil pump is automatically regulated by a float, and all apparatus is below the burners, so that no gravity flow can take place. The use of gravity is held by some to be bad practice, and this view will bear argument in its favour. Low pressure air is condemned as leading to imperfect atomization and large globules which burn imperfectly and deposit carbon and injure the fire-brick. From 60 to 120 gallons of oil are claimed to do the work of a ton of coal.

The process is held to be much superior to any steam atomizing process for metallurgical work.

Low pressure air which throws oil upon the fire-brick unconsumed, causes these to shell off and break, and smoke is made also while carbon is deposited in the furnace.

Applied to metallurgy, to forge furnaces, crucible heating, and other industrial work outside steam raising, the advantages of oil fuel are not merely absence of dirt and dust, but there is no loss of time through men waiting for fires to burn up. There are no times of good or of bad fires, no uneven heat, but a full flowing flame is maintained with an even continuous degree of heat. Then the economy of oil is largely secured by increased production and better work. Oil has the advantage over gas fuel also, which, though equally good in the furnace, cannot be produced without labour and dust and at a considerable outlay in plant and apparatus.

The calorific capacity of various gases is as per following table—

	Heat Units per thousand cubic feet.
Natural gas	1,000,000
Air gas (gas machine) 20-candle power	815,500
Public illuminating gas, average	650,000
Water gas (from bituminous coal)	377,000
Water and producer gas (mixed)	175,000
Producer gas	150,000
Blast furnace gas	100,000

Since a gallon of fuel oil (7 pounds) contains 151,000 heat

units, the following comparisons may be made. At three cents a gallon (about 1.8*d.* per English gallon), the equivalent heat units in oil would be equal to—

	Dollars per thousand cubic feet.
Natural gas	at .1987
Air gas 20-candle power	,, .1620
Public illuminating gas, average	,, .1291
Water gas (from bituminous coal)	,, .0749
Water and producer gas (mixed)	,, .0347
Producer gas	,, .0298
Blast furnace gas	,, .0200

At four cents a gallon (about 2.4*d.* per English gallon) the equivalent heat units in oil would equal—

	Dollars per thousand cubic feet.
Natural gas	at .2649
Air gas, 20-candle power	,, .2160
Public illuminating gas, average	,, .1722
Water gas (from bituminous coal)	,, .0998
Water and producer gas (mixed)	,, .0463
Producer gas	,, .0397
Blast furnace gas	,, .0265

so that when oil will pay to use it may be installed at one-tenth the cost of a gas plant and worked for a fraction of the cost in upkeep and wages.

The Springfield System uses air as low as 18 or 24 ounces pressure ; oil comes forward at forty pounds pressure. This apparently contradicts the statements above, that low pressure air is not satisfactory. Possibly an explanation is to be found in the oil pressure which, as in the Körting system, should itself do much towards atomizing the oil. Clearly the oil must possess energy of itself or borrowed from compressed air or steam.

CHAPTER XX

THE OIL ENGINE

OIL or liquid fuel engines may be divided into five classes:—(a) Those which use the lightest distillates of petroleum. They are known as petrol engines and they are strictly only a form of gas engine, for the liquid they use is only admitted to a vessel through which the engine draws its air supply. The air is thus carburetted or petrolized, no liquid molecules remaining, and ignition is electrical. It is not intended to treat further of this class.

(b) The paraffine engine which employs the commoner grades of lamp oil.

(c) Crude or heavy oil engines which are fed with heavy oils.

(d) The Diesel engine, in which the fuel is sprayed into pure air so highly compressed as to be at a red heat.

(e) The Griffin engine, which rejects incombustible bases such as asphaltum.

A brief description of the latter four types will be sufficient to show the application of liquid fuel to internal combustion engines.

Class *b*. The Hornsby engine (Fig. 83) may be taken to illustrate this class. On the back cover of the cylinder is fixed a bottle neck vaporizer, V, which is first heated by a lamp and is afterwards kept hot by the explosions within it when the engine has been set to work.

The back of the cylinder beyond the piston stroke forms, with the vaporizer, the compression space. Air drawn into the cylinder on the outstroke of the piston is compressed into the vaporizer, into which oil is forced as spray by a small pump at the moment of highest compression. The oil is vaporized by the heat of the air, and the mixture ignites and expands into the cylinder through the bottle neck. The oil pump works always at full capacity, but a by-pass allows part of it to escape back to the tank. This by-pass is controlled by the governor. About 0.55 pint of oil (of .825 sp. gr.) per B.H.P.

hour is consumed. The engine will use oil of 0.79 to 0.88 sp. gr., and even heavier or crude oil may be used.

An engine of over 100 B.H.P. was run continuously night and day for 500 hours = 21 days. At the end of the time there was practically no deposit in the vaporizer and the engine would have run a much longer period without loss of power. The oil used was the thickest Texas liquid fuel, and at the end of the run the engine was working as well as at the beginning. The particulars of the run are as below:—

Rated B.H.P.	{ 110 B.H.P. for refined oil. 100 B.H.P. for residual oil.
Total number of hours running	502½
Fuel used	Texas, costing 3 <i>d.</i> per gallon in tank wagons.
Specific gravity933
Flash point (open test)	240° F.
Total amount of fuel used	15 tons 5 cwt. 1 qr. 17 lb.
Amount used per hour	68.07
Average brake horse-power	100.8
Amount of fuel used per B.H.P. hour578 pints.
Cost of fuel per B.H.P. hour21675 <i>d.</i>
Or for 100 B.H.P.	1 <i>s.</i> 9½ <i>d.</i> per hour.
Or 4.6 B.H.P. for	1 <i>d.</i> per hour.

The method of injection at the time of ignition probably ensures as full a combustion of all the oil as is practicable, none depositing before it has had a chance to burn. This helps to prevent distillation to destruction or “cracking” which happens when oil is too highly heated. The lighter parts are driven off as vapour and heavy residuals are left and may accumulate in the vaporizers as solid carbon.

This need not occur with paraffine, which should never be made so hot that it will not condense into the same liquid again. The carbon difficulty has always attended the use of crude and heavy oils, especially when these have an asphaltic base. The base remains unconsumed, and when an engine stops and cools it becomes glued up by the asphalt. It is better not to use such oils in an engine. If such must be used it should, if possible, be the practice to run the engine for a time, before stopping, with paraffine in order to clear away any varnish-like deposit before allowing the engine to stop and cool. See class (e). But this is not necessary with ordinary crude oils, such as are used in class (c). This class (c) is merely an extension of class (b) and includes the above Hornsby engine of which the vaporizer is shown in Fig. 83; the Ruston-Proctor engine, in which a small vaporizing chamber is attached at the back of the cylinder and receives the spray of fuel forced in through a narrow orifice by which the oil is atomized. As far as

possible the oil in this class of engine should be vaporized as it enters and not allowed to fall liquid on too hot a surface, by which it may be cracked or decomposed with formation of solid carbon.

All kinds of crude oil and residual oils have been tried in the

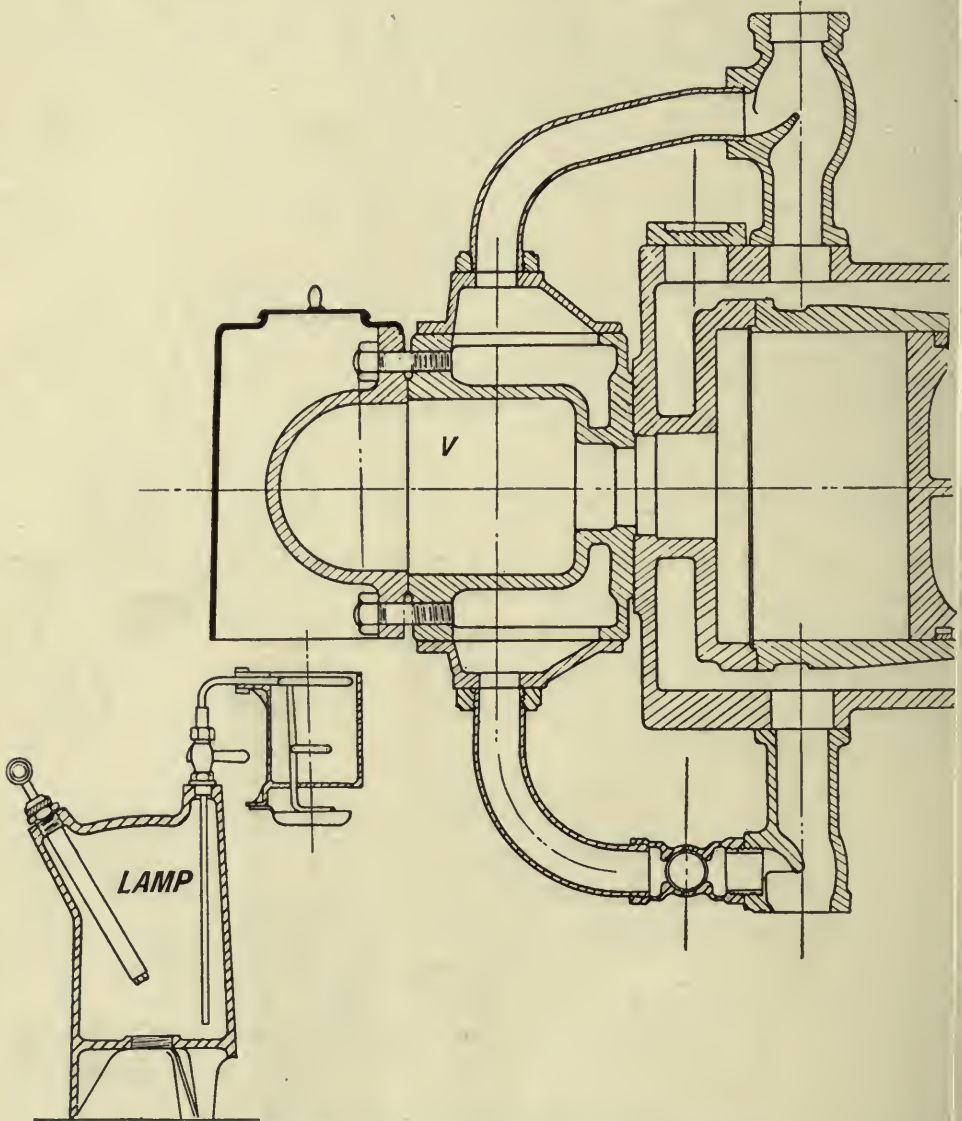

Fig. 83. HORNSBY OIL ENGINE VAPORIZER.

Ruston-Proctor engine, varying in sp. gr. from 0.86 to 0.96. A special Italian residual oil with 15 to 25 per cent. of tar was tried also, and in no case was there any gummy or sooty deposit.

In this class of engine the oil sprays by its own heavy pressure. Fuel consumptions are claimed as low as 0.45 lb. per b.h.p.

hour, but 0.5 lb. should usually be assumed. In the Ruston engine a small quantity of water is injected into the cylinder at each suction stroke. In the Hornsby engine this water injection is not used. The use of water has its advocates and the reverse. In its favour are claimed that it is a safeguard against overheating at full loads, that it prevents knocking from over-hot valves or piston, and obviates risk of cylinder scoring and seizing of pistons.

Class (d): The Diesel engine occupies this class by itself.

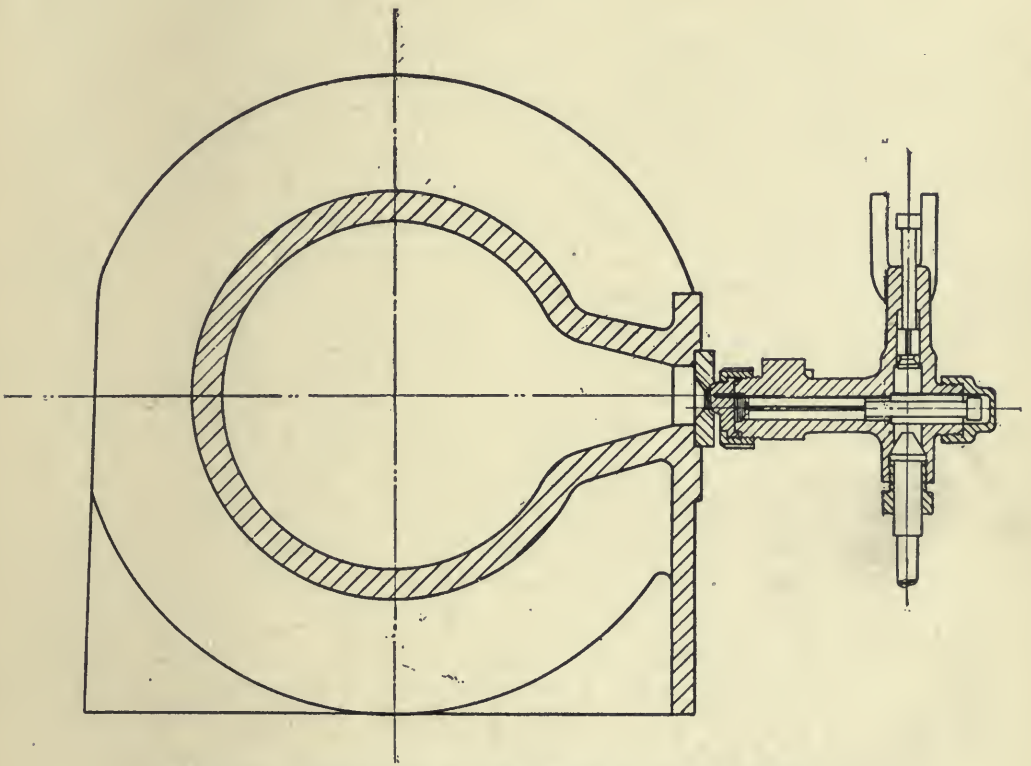

Fig. 84. ENLARGED CROSS SECTION OF VAPORIZER.

It depends for its working upon the compression of a charge of pure air to so high a pressure—some 35 atmospheres—that oil injected into this air will be ignited. Since the air charge has a pressure of about 500 pounds per sq. in., the air by which the fuel is sprayed into this charge is furnished by a pump at about 800 lb. pressure. The engine is best started by compressed air, a store of which is maintained. The storage vessels are sent out, ready charged, with the engine, and serve for starting from the first, and the air pressure is carefully maintained so to avoid the inconvenience of hand pumping a fresh store.

The thermal efficiency of the Diesel engine is given by one maker as 40.7 per cent. on the indicated horse power, and 31.0 per cent. on the brake horse power. The Author's own tests fully corroborate these figures. The best steam engines give similarly 22.0 per cent. and 20.5 per cent. with superheated steam at $300^{\circ}\text{C.} = 572^{\circ}\text{F.}$ This of course does not include the boiler. Producer gas engines give 20 to 26 per cent.

Many oil engines work on the Otto cycle, which is a four-stroke cycle, but in many Diesel engines, especially for marine work, the engine drives an air scavenging pump and the exhaust takes place by a ring of ports uncovered by the piston and the waste gases are swept out by a scavenging of air, and the engine is then run on the two-stroke cycle.

The use of liquid fuel in the Navy has naturally led up to the employment of the oil engine, and the Diesel engine, by reason of its economy, has become the accepted type. Its oil consumption at full load is about 0.44 lb. of oil per b.h.p. hour. Assuming the oil to have a thermal capacity of 19,320 B.Th.U. and the heat equivalent of one horse power to be 2,544 B.Th.U., an engine using 1 pound of oil per h.p. hour would have an efficiency of $2,544 \div 19,320 = 13.1$ per cent. The efficiency with any other rate of fuel consumption would be this last number \div fuel consumption. Thus if the fuel consumption were 0.4 lb. per h.p. hour, the efficiency would be 32.0 per cent. and this may be attained in the Diesel engine.

The position already taken by the Diesel engine in marine work is already good, but as in all four-stroke single acting engines, the weight is great for the power developed, and the tendency is to convert it into a two-stroke engine and also to make it double-acting. This of course demands an exhaust uncovered by the piston and a scavenging charge of air to sweep out the exhaust gas, but these are details which may pertain to all engines and do not apply to the question of the fuel used by them, and need not here be further considered.

Class (d), the Griffin engine, of which Fig. 85 shows a section of the vaporizer of a $9\frac{1}{2}'' \times 10\frac{1}{2}'' \times 4$ cyl. engine, occupies this class of heavy oil-using engines.

It is based on the claim that no engine can satisfactorily use an oil with a heavy base, particularly an asphaltic base. In it, therefore, is embodied an exhaust heated external vaporizer. This is first heated by an air blown flame, and serves to vaporize the first charge, and it is maintained at about $450^{\circ}\text{F.} = 232^{\circ}\text{C.}$, by the subsequent exhaust gases. The oil is distilled but not cracked; the heavier portions remain unaltered and are run out of the vaporizer by a gravity pipe. The Author has

seen such rejected portion placed on a cold iron plate, and it became a hard dry varnish at once, as it would have done inside the cold engine if allowed to get in.

The interior of the Griffin engine remains clear of all deposit of carbon or coke or asphalt. There is always found some very fine ash in petroleum, and this also is kept out of the cylinder, where its presence would produce abrasion. The oil is heated in the supply pipe to the vaporizer, as is also the air for spraying it in. This facilitates the free flow of the oil, and assists in fine atomization.

The vaporizer, Fig. 85, has an outer jacket marked $10\frac{5}{8}$ " dia. in this size, surrounding an inner annular chamber $7\frac{7}{8}$ " dia., which in turn encircles a central vaporizing chamber $5\frac{1}{4}$ " dia., into which the fuel is sprayed. The exhaust gases from the cylinder traverse the annular chamber. Their temperature is a maximum of $550^{\circ}\text{F.} = 288^{\circ}\text{C.}$, which becomes $450^{\circ}\text{F.} = 232^{\circ}\text{C.}$ in the annular chamber. Thus the fuel is vaporized, not gasified, a physical and not a chemical change. It is in fact merely a fractional distillation which leaves the undesirable refuse to be run out of the still as tar or asphalt. The vaporizer is only at atmospheric pressure ; it is never exposed to great temperature.

All the air required in the cylinder does not pass through the vaporizer. Enough passes that way to carry in the charge of oil vapour ; the remainder is admitted by a separate air valve. Incidentally this engine is started by a momentum device, the fly-wheel having a friction clutch grip on the shaft. A boy can gradually get up the fly-wheel of a 40 h.p. engine to a sufficient speed ; it is then gripped to the shaft and finds the starting energy.

Ignition is by a refractory body in a small and isolated cavity communicating with the combustion chamber. A timing valve may be supplied if required.

The oil and the compressed air by which it is sprayed into the heated vaporizer, are both heated so as to render spraying more perfect. The temperature of the vaporizer is less than that which would gasify the oil, and the tar is left behind in place of going forward to the cylinder and doing harm.

The incombustible ash sticks to the side of the vaporizer and can be removed by a wire brush when the engine is stopped.

The spray injector, which also serves as the heating blow-lamp, has an adjustable inner nozzle through which comes air at 20 lb. pressure. Oil flows in through an annular chamber round this inner nozzle, and is pulverized by the air and vaporized by the hot chamber.

The engine can be started if desirable with light oils, as petrol and electrical ignition, the heavy oil being turned on when the vaporizer has become hot. This avoids the use of the blow-lamp heater in the locality of inflammable vapours.

It should be added that for each 1,000 feet of elevation above sea level an engine ought to be about 3 per cent. larger owing to the rarefied air. For a number of engines it might be found cheaper to pump air to them at a pressure of one absolute atmosphere, so that with this compound system no increase of engine size need be made. This applies to all oil or gas engines when worked at considerable heights above sea level.

It is external to the intention of this book to afford more than an outline of the general systems of using liquid fuel in the internal combustion engine, its general mechanism, etc.

For details of the legion of different engines, their valve systems, sprays, vaporizers, the Author would refer his readers to the books of Mr. Dugald Clerk, the late Bryan Donkin and the catalogues of makers.

As the liquid fuel engine is improved, and its operation made more and more certain, so will its superior thermal efficiency bring it into wider use. There appears to be no immediate prospect of a direct oil fuel turbine engine, and all existing engines are of the reciprocating type, which steam turbine makers have endeavoured with so much success to put out of use for steam using. But the turbine runs too fast to suit the propeller and this is all in favour of the reciprocating oil engine. At present, even the Diesel engine must be run on selected fuel as regards freedom from asphalt, etc. Such oils with an asphaltic base which might be rejected to the extent of 15 per cent. by the Griffin engine would be unsuitable at sea even if their undesirable elements were rejected by the engine, for no shipowner wants to carry the excess of fuel that this implies. On land, therefore, any fuel can be used in some engines; at sea, liquid fuel must be selected, except for short journeys. The ability to burn any fuel under boilers in high temperature refractory furnaces will do much to preserve steam power against the inroads of the more highly efficient internal combustion engine. The near future will see many oil engines in marine work.

It will be noted that essentially the method of using oil in the internal combustion engine is by spraying or atomizing the oil into the air with which it is to burn, or by spraying it into a vaporizer in which it is evaporated, and whence it passes

into the cylinder as a vapour. Petrol vaporizes at ordinary atmospheric temperature. Heavy oils must have the high temperature vaporizer of the Griffin engine, or be directly ignited and burned in the highly heated chambers of other types of engine or burned in the "red hot" air of the Diesel high compression engine.

Part III
TABLES

TABLE I. *Composition of Crude Oils.*

Name.	C.	H.	O.	Sp. G.	Per deg. C. Coeff. of Expansion.	B.Th.U. Cal. Capacity.
Heavy Virginia . . .	83·5	13·3	3·2	·873	·00072	10,180
„ Ohio . . .	84·2	13·1	2·7	·887	·000748	10,399
„ Pa.	84·9	13·7	1·4	·886	·000721	10,672
Gas coal oil . . .	82	7·6	10·4	1·044	·00744?	8,916
E. Galician . . .	82·2	12·1	5·7	·870	·000813	10,005
W. Galician . . .	85·3	12·6	2·1	·885	·000775	10,231
Java	87·1	12·0	0·9	·923	·000764	10,831
Caucasian	85·3	11·6	5·1	·9405	·000696	—
Rangoon	83·8	12·7	3·5	·875	·000774	—

TABLE II. *Calorific Capacity of Liquid Fuel Oils.*

Locality.	Fuel.	Sp. G. 0°C.	C.	H.	O.	Calorific Capacity.	
						Actual Calories	Calcula- ted Cal.
Russian . . .	Pet. refuse . . .	928	87·10	11·7	1·2	—	11,018
„ . . .	Astatki	900	84·94	13·96	1·2	10,340	11,626
Caucasus . . .	Heavy crude . . .	938	86·60	12·30	1·1	11,800	11,200
American . . .	Solid residuum . . .	—	97·855	0·489	1·196	8,057	—
Scotch	B.F. Oil	920	83·64	10·59	9·458	10,328	—

TABLE III. *Coefficient of Expansion of Crude Oils.*

	Sp. G. × 1,000.	Coefficient of Expansion of Crude Oil × 1,000,000 Dr. Engler.
Pennsylvania	816	840
Canada	828	843
Alsace	829	843
Virginia	841	839
Alsace	861	858
Wallachia	862	808
E. Galicia	870	813
Rangoon	875	774
Caucasus	882	817
W. Galicia	885	775
Ohio	887	748
Baku	899	784
Hanover (Odesse)	892	772
Pechelbronn	892	792
Wallachia	901	748
Hanover (Oberg)	944	662
Hanover (Wiesse)	955	647

Heavy viscous oils 0·0007 to ·00072 between 20° and 78°C. = 68° to 172·4°F. containing paraffin and solid below 20° = 0·0075 to ·00081.

TABLE V.—THE PROPERTIES OF

Name.	Sym- bol.	Den- sity H=1	Mole- cular Weight	Lb. per cubic feet.	Cubic ft. per lb.	Grams per Litre.	Litres per Gram.	Required to burn one unit.				Nominal tem combu	
								Weight.		Volume.		Air.	
								Air.	Oxy- gen.	Air.	Oxy- gen.	F°.	C°.
Air	$\begin{Bmatrix} O_{23} \\ N_{76} \\ X_1 \end{Bmatrix}$	14.44	—	.08073	12.385	1.29318	.773	—	—	—	—	—	—
Carbon, C— Amorphous	—	—	—	—	—	—	{ to CO } { to CO ₂ }	—	—	—	—	2673.5	1485
Vapour	—	12	—	.06696	14.930	1.0727	.932	—	—	9.54	2.00	6955	3846
Carbon Dioxide	CO ₂	22	44	.12344	8.147	.967	.508	—	—	—	—	—	—
Carbonic Oxide	CO	14	28	.07817	12.80	1.2515	.800	2.484	.571	2.381	.500	3494	1923
Hydrogen	H ₂	1	2	.00559	178.83	.08961	11.16	34.785	8.000	2.39	.500	4813	(Water 2674
Oxygen	O ₂	16	32	.08926	11.203	1.4298	.699	—	—	—	—	—	—
Nitrogen	N ₂	14	28	.07845	12.763	1.25616	.796	—	—	—	—	—	—
Steam	H ₂ O	9	18	.05022	19.912	.8047	.1242	—	—	—	—	—	—
Acetylene	C ₂ H ₂	13	26	.07267	13.456	1.190	.840	13.378	3.077	11.93	2.500	6120	3400
Benzine.	C ₆ H ₆	39	78	.208	4.808	3.333	.303	13.378	3.077	35.80	7.500	5022	2790
Ethylene	C ₂ H ₄	14	28	.07814	12.797	1.2519	.799	14.903	3.428	14.30	3.000	5400	3000
Ethane	C ₂ H ₆	15	30	.08565	11.950	1.3415	.746	16.484	3.733	16.70	3.500	4354	2419
Methane	CH ₄	8	16	.04466	22.391	.7155	1.397	17.392	4.000	9.54	2.000	4036	2245
Ethyl	C ₂ H ₆ O	23	46	.12857	7.775	2.061	.287	9.074	2.037	14.30	3.000	4630	2573
Methyl	CH ₄ O	16	32	.08926	11.203	1.4208	.699	6.521	1.500	7.15	1.500	4186	2325
Cyanogen	C ₂ N ₂	26	52	.1453	6.88	2.338	.427	5.348	1.23	9.54	2.000	6099	3388
Glycerine	C ₃ H ₈ O ₃	—	92	—	—	—	—	18.148	4.174	16.70	3.500	4000	2222
Blast Furnace Gas [CO] ₂₇ N ₆₅ (CO ₂) ₆ H ₂	—	14 +	—	.079	12.65	1.2515	.800	{ .100 } { .721 }	.22 .166	.82	.164	2160	1200
Producer Gas [CO] ₂₅ (Sundry) _{1.5} [CO ₂] _{2.5} [CH ₄] ₂ , N ₆₉	—	14 +	—	.079	12.65	1.2515	.800	{ .99 } { .721 }	.21 .166	—	—	{ 3440 } { 2160 }	{ 1910 } { 1200 }
Water Gas [CO] ₇₆ , [CH ₄] ₂ , [Sundry] _{7.5} (CO ₂) ₁₀ N _{2.5}	—	8 +	—	.045	22.5	.726	1.40	3.878	.788	—	—	4850	2700
Coal Gas, H ₈ [CH ₄] ₅₇ [CO] ₁₅ N ₄ , (Sun- dry) ₁₆	—	4.7	—	.032	31.6	.516	1.975	13.89	2.81	3.16	1.23	4500	2500
Natural Gas (CH ₄) ₉₀ , N ₆ , Sundry ₄	—	8	—	.045	22.5	1.726	1.40	15.00	3.06	—	—	4200	2333

NOTE.—Gases expand by heat to the extent of $\frac{1}{273}$ of their bulk at 0°C. for each degree Centigrade, or $\frac{1}{491.4}$

The specific heat of gases varies with the temperature, being greater for higher temperatures. At the Lechatelier therefore gives a formula for specific heat $C_p = 6.5 + aT$, where T is the absolute temperature This has an important bearing on the theory of the gas engine.

GASES (KEMPE'S YEAR BOOK).

Temperature of fusion.		Heat generated by combustion of one					Heat of formation at 15°C. per Molecule.	Specific Heat.		
Oxygen.		Lb.	Cub. ft.	Gram.	Litre.	Molecule.		Water = 1.		
F°.	C°.	B.Th.U.	B.Th.U.	Cal.	Cal.	Cal.	Cal.	Liquid.	Constant.	
									Pressure	Volume.
—	—	—	—	—	—	—	—	—	.2375	.1686
7725	4292	14415.9	—	2.4533	—	29.44	2.84 ¹	.2415	—	—
8440	10226	14647	—	2.1375	—	97.65	3.34 ³			
5752	14290	20461	1370.5	11.3675	12.193	136.41	{ -38.76 ² -42.1 ³ 68.20 ⁴ 94.31 ³ 97.65 ² }	—	.285	—
—	—	—	—	—	—	—	—	—	216.9	.171
Mercur.	of C. =	10232	{ 799.3 342.5 }	{ 5.684 2.436 }	{ 7.105 3.047 }	68.2	{ 26.1 ³ 29.4 ² }	—	.245	.173
2392	7144	4383								
Vapor		52290	{ 293 347 }	{ 29.15 34.50 }	{ 2.612 3.091 }	{ 58.3 gas 69.0 liq. 70.4 solid }	—	—	3.410	.234146
2108	6727	{ at 32°F. 62100 }								
Water Liquid.										
—	—	—	—	—	—	—	—	—	.217	.15481
—	—	—	—	—	—	—	—	—	.244	.173
—	—	—	—	—	—	—	—	—	—	—
—	—	—	—	—	—	—	—	—	—	—
0340	11300	21856	1624	12.142	14.46	315.7	—58.1	{ 1.0 liq. .504 Solid }	—	—
6830	9350	{ 18094 17930 }	3764	{ 10.052 9.960 }	33.496	{ 784.1 gas 776.9 liq. }	{ -1.8 sol. -4.1 liq. -11.3 gas }		.43602	.3754
6886	9381	21927	1744	12.182	15.250	341.1	-14.6	—	.404	.332
4848	8249	22338	1912	12.410	16.641	372.3	23.3	—	—	—
4348	7971	24017	1073	13.343	9.547	213.5	18.9	—	.593	.468
2583	6690	12744	1639.1	7.080	14.54	325.7	{ 59.8 gas 69.9 liq. }	{ .60 liq. .50 gas }	.451	.320
0216	5675	9596	856.5	5.331	7.627	170.6	{ 53.3 gas 61.7 liq. }	{ .66 liq. .46 gas }	—	—
8222	10215	9086	1320.6	5.048	12.02	262.5	{ -73.9 gas -68.5 liq. }	—	—	—
8078	4488	7770	—	4.317	—	397.2	{ 161.7 liq. 165.6 sol. }	—	—	—
4500	2500	{ 1223 to 1237 }	{ 96.7 97.8 }	.700	.900	—	—	—	—	—
4500	2500	{ 1265 to 2530 }	100 to 200	{ .773 to 1.370 }	{ .9674 to 1.713 }	—	—	—	—	—
—	—	{ 4230 to 5458 }	330 to 700	{ 2.35 to 3.03 }	{ 3.00 to 6.33 }	—	—	—	—	—
—	—	21400	685	11.9	6.099	—	—	—	—	—
—	—	24444	1100	13.58	10.0	—	—	—	—	—

¹ From Graphite. ² From Amorphous Carbon. ³ From Diamond. ⁴ From Carbonic Oxide.

of their bulk at 32°F. for each degree F..

Absolute values of the molecular heat of all gases seems to converge at 6.5 for constant pressure values. Centigrade, and a is a co-efficient greater according to the complexity of the molecule. For values of a see table.

(T = Temperature Centigrade.)

TABLE IV. *Calorific Power of Crude Oil.*

	Sp. Gr.	Cal. Capacity.
W. Virginia.	·873	10190 cal.
Oil Creek, Pa.	·816	9963
Java	·923	10831
Baku	·884	11460
E. Galicia	·870	10005
W. Galicia	·885	10231
Parma	·786	10121
Schwabweiler (Alsace)	·861	10458

TABLE VI. *Temperature.*

	C°.	F°.
Red heat in daylight	577°	1070°
Iron red in dark	400°	752°
Bessemer furnace	2205°	4000°
Common fire	595°	1100°
Copper melts	1232°	2160°
Lead „	316°	600°
Tin „	215°	420°
Grey cast-iron melts	1100°	2012°
White „ „ „	1050°	1922°
Carbon vaporizes	3600°	6512°

TABLE VII. *Specific Heats of Gases.*

	Const. Vol.	Const. Pressure.
Air	·168	·2375
Oxygen	·1548	·217
Nitrogen.	·173	·244
Hydrogen	2·4146	3·410
Carbonic oxide, CO	·173	·245
Carbon dioxide, CO ₂	·171	·216
Marsh gas, CH ₄	·468	·593
Olefiant gas, C ₂ H ₄	·332	·404
Steam, H ₂ O	·370	·479
Blast furnace gas	·163	·228
Steam boiler furnace gas.	·171	·240

Cast Iron	·1298
Wrought Iron	·1138
Steel	·117
Brick	·241

TABLE VIII. *Equivalents.*

1 Cal.	3·968 B.Th.U.
1 B.Th.U.	0·252 Cal.
1°C.	$\frac{9}{5}$ °F.
1°F.	$\frac{5}{9}$ °C.
1°C.	$\frac{4}{5}$ °R.
1°R.	$\frac{5}{4}$ °C.
1 kilog.	2·204
1 pound	0·453 k.
1 B.Th.U.	772 ft. pounds (old).
”	778 ” ” (new).
1 calorie	423·55 k.m. (old).
”	426·84 ” (new).
772 ft. p. per 1°F.	1389·6 ft. p. per 1°C.
778 ” ” ”	1400·4 ” ” ”
423·55 k.m.	3063·54 ft. lb.
426·84 k.m.	3087·3 ft. lb.
1 B.Th.U.	107·78 k.m.
1 k.m.	7·231 ft. lb.
1 k. per linear m.	2 lb. per yard nearly.
1 B.Th.U. per foot ³	9 Cal. per m. ³ ”
g	32·2 ft. per sec. ²
g	9·8117 m. per sec. ²
1 B.Th.U. per ft. ²	2·713 cal. per m. ²
1 ” ” lb.	0·556 cal. per kilo.
1 kilo. per cm. ²	14·2 lb. per sq. inch.
1 lb. per sq. inch	0·0703 kilo. per cm. ²
1 metre-kilo.	7·231 ft. pounds.
1 ft. pound	0·138 metre-kilo.

TABLE IX. *Properties of Carbon Calorifically.*

	Calories per			British Thermal Units.		Temperature of Combustion.	
	Mole- cule.	Litre.	Gram.	Per Cubic Ft.	Per Pound	In Air.	
Amorphous to CO	29·44	—	2·453	—	4416	1485°	2705°
” ” CO ₂	97·65	—	8·1375	—	14647	2753°	4988°
Vapour to CO	68·20	6·096	5·864	685·25	10231	3540°	6373°
” CO ₂	136·41	12·193	11·3675	1370·50	20461	2846°	6955°
CO = 2½ lb. to CO ₂	68·20	3·046	5·684	342·50	10232	1923°	3494°
CO = 1 lb. to CO ₂	29·23	3·048	2·436	342·50	4384	1923°	3494°
Hydrogen to H ₂ O gas	58·30	2·612	29·15	293·00	52290	2513°	4554°
” H ₂ O water	69·00	3·091	34·50	347·00	62100	2974°	5385°

The important figures for practice are in black type.

TABLE X.

TENSION (f.) OF AQUEOUS VAPOUR IN MM. OF MERCURY PER DEGREE CENTIGRADE (T.)° AND GRAMS (g.) PER CUBIC METRE OF SATURATED AIR.

T°.	g.	f.	T°.	g.	f.	T°.	g.	f.
0	—	4.5	11	10.0	9.7	22	19.3	19.6
1	—	4.9	12	10.6	10.4	23	20.4	20.9
2	—	5.2	13	11.3	11.1	24	21.5	22.2
3	—	5.6	14	12.0	11.9	25	22.9	23.5
4	—	6.0	15	12.8	12.7	26	24.2	25.0
5	6.8	6.5	16	13.6	13.5	27	25.6	26.5
6	7.3	6.9	17	14.5	14.4	28	27.0	28.1
7	7.7	7.4	18	15.1	15.3	29	28.6	29.8
8	8.1	8.0	19	16.2	16.3	30	29.2	31.6
9	8.8	8.5	20	17.2	17.4	—	—	—
10	9.4	9.1	21	18.2	18.5	—	—	—

TABLE XI.

RELATIVE VALUE OF COAL AND OIL, FUEL ACCOUNT ALONE CONSIDERED.

RELATIVE VALUE OF COAL AND OIL, ALL ASCERTAINED ECONOMIES CONSIDERED.

Oil per Barrel at

Coal per Ton at

Coal per Ton at

\$0.20

\$0.74

\$0.65

0.30

1.12

0.98

0.40

1.49

1.30

0.50

1.86

1.63

0.60

2.24

1.96

0.70

2.61

2.28

0.80

2.98

2.61

0.90

3.35

2.93

1.00

3.73

3.26

1.10

4.10

3.59

1.20

4.47

3.91

1.30

4.85

4.24

1.40

5.22

4.56

1.50

5.59

4.89

1.60

5.97

5.22

1.70

6.34

5.54

1.80

6.71

5.87

1.90

7.08

6.19

2.00

7.45

6.52

1 dollar = 48 pence, approximately.

TABLE XII. *Russian and Pennsylvanian Oils.*

Crude Petroleum.	Pennsylvanian.	Russian.		
		Light.	Heavy.	Refuse.
	Per cent.	Per cent.	Per cent.	Per cent.
Carbon	84.9	86.3	86.6	87.1
Hydrogen	13.7	13.6	12.3	11.7
Oxygen	1.4	0.1	1.1	1.2
	100.00	100.00	100.00	100.00
Sp. Gr. at 32°F.	0.886	0.884	0.938	0.928
B.Th. Units	19,210	22,628	19,440	19,260
Evaporation at 8 atmospheres .	16.2	17.4	16.4	16.2

TABLE XIII. *Petroleum Refuse.**Specific Gravity and Weight per cubic foot, at various temperatures.*Water = 1.0000 specific gravity, at $17\frac{1}{2}^{\circ}$ Cent. = $63\frac{1}{2}^{\circ}$ Fahr.

Temperature.			Specific Gravity.	Weight in lb. per cubic foot.
Centigrade.	Réaumur.	Fahrenheit.		
0	0.0	32.0	0.9110	56.61
1	0.8	33.8	0.9103	56.55
2	1.6	35.6	0.9097	56.50
3	2.4	37.4	0.9091	
4	3.2	39.2	0.9085	56.42
5	4.0	41.0	0.9078	56.36
6	4.8	42.8	0.9072	
7	5.6	44.6	0.9066	56.30
8	6.4	46.4	0.9060	
9	7.2	48.2	0.9053	56.20
10	8.0	50.0	0.9047	56.14
11	8.8	51.8	0.9041	
12	9.6	53.6	0.9034	56.11
13	10.4	55.4	0.9028	56.05
14	11.2	57.2	0.9022	
15	12.0	59.0	0.9016	55.99
16	12.8	60.8	0.9009	55.92
17	13.6	62.6	0.9003	
18	14.4	64.4	0.8997	55.84
19	15.2	66.2	0.8991	
20	16.0	68.0	0.8984	55.81
21	16.8	69.8	0.8978	55.74
22	17.6	71.6	0.8972	
23	18.4	73.4	0.8965	55.68
24	19.2	75.2	0.8959	55.62
25	20.0	77.0	0.8953	
26	20.8	78.8	0.8947	55.55
27	21.6	80.6	0.8940	
28	22.4	82.4	0.8934	55.48
29	23.2	84.2	0.8928	55.43
30	24.0	86.0	0.8922	
31	24.8	87.8	0.8915	55.37
32	25.6	89.6	0.8909	55.30
33	26.4	91.4	0.8903	
34	27.2	93.2	0.8896	55.24
35	28.0	95.0	0.8890	

TABLE XIV. *Conversion Table for Degrees Baumé.*

Degrees Baumé.	Degrees Sp. Gr.	Lb. in 1 gal. (American).	Degrees Baumé.	Degrees Sp. Gr.	Lb. in 1 gal. (American).
10	1·0000	8·33	43	·8092	6·74
11	·9929	8·27	44	·8045	6·70
12	·9859	8·21	45	·8000	6·66
13	·9790	8·16	46	·7954	6·63
14	·8722	8·10	47	·7909	6·59
15	·9655	8·04	48	·7865	6·55
16	·9589	7·99	49	·7821	6·52
17	·9523	7·93	50	·7777	6·48
18	·9459	7·88	51	·7734	6·44
19	·9395	7·83	52	·7692	6·41
20	·9333	7·78	53	·7650	6·37
21	·9271	7·72	54	·7608	6·34
22	·9210	7·67	55	·7567	6·30
23	·9150	7·62	56	·7526	6·27
24	·9090	7·57	57	·7486	6·24
25	·9032	7·53	58	·7446	6·20
26	·8974	7·48	59	·7407	6·17
27	·8917	7·43	60	·7368	6·14
28	·8860	7·38	61	·7329	6·11
29	·8805	7·34	62	·7290	6·07
30	·8750	7·29	63	·7253	6·04
31	·8695	7·24	64	·7216	6·01
32	·8641	7·20	65	·7179	5·98
33	·8588	7·15	66	·7142	5·95
34	·8536	7·11	67	·7106	5·92
35	·8484	7·07	68	·7070	5·89
36	·8433	7·03	69	·7035	5·86
37	·8383	6·98	70	·7000	5·83
38	·8333	6·94	75	·6829	5·69
39	·8284	6·90	80	·6666	5·55
40	·8235	6·86	85	·6511	5·42
41	·8187	6·82	90	·6363	5·30
42	·8139	6·78	95	·6222	5·18

The Sp. Gr. $\times 10$ = weight in pounds per imperial gallon.

TABLE XV. *Of the Heat of Combustion and Air consumed by various Fuels.*

Fuel.	Oxygen per pound of fuel.	Air per pound of fuel.		Total heat per lb. of fuel.	Evapora- tion from and at 212°F.
	lb.	lb.	Cubic ft.	B.Th.U.	lb.
Hydrogen . . .	8·0	34·8	457	62,100	62·4
Carbon to CO ₂ .	2·66	11·6	152	14,647	15·0
Average Coal . .	2·45	10·7	140	14,700	15·22
Coke	2·49	10·81	142	13,548	14·02
Petroleum . . .	3·29	14·33	188	20,411	21·13

TABLE XVI. *Theoretical Flame Temperatures.*

	In Air.	
	Centigrade.	Fahrenheit.
C to CO	1485°	2705°
C to CO ₂	2753	4988
CO to CO ₂	1923	3494
Hydrogen	2513	4554
Marsh gas, CH ₄	2245	4036
Olefiant gas, C ₂ H ₄	3000	5400
Acetylene, C ₂ H ₂	3400	6120
Benzine, C ₆ H ₆	2790	5022
Producer gas	1200	2160
Coal gas	2700	4860
Petroleum	2400	4320
Naphthalene	2730	4914
Wood	2280	4104
Lignite (dry)	1200	2160
Coal (bituminous).	1500	2700

TABLE XVII. *Weight and Volume of Gases.*

	Weight.		Volume.	
	Per cubic metre in kilograms.	Per cubic foot in pounds.	Per kilogram in cubic metres.	Per pound in cubic feet.
Air	1.29318	0.08073	0.773	12.385
Nitrogen	1.25616	0.07845	0.796	12.763
Oxygen	1.4298	0.08926	0.699	11.203
Hydrogen	0.08961	0.00559	11.160	178.83
Carbonic acid, CO ₂	1.9666	0.12344	0.508	8.147
Carbonic oxide, CO	1.2515	0.07817	0.800	12.800
Carbon vapour, C	1.0727	0.06696	0.932	14.930
Aqueous vapour, H ₂ O.	0.8047	0.05022	1.242	19.912
Ethylene, C ₂ H ₄	1.2519	0.07814	0.799	12.797
Methane, CH ₄	0.7155	0.04466	1.397	22.391
Acetylene, C ₂ H ₂	1.1900	0.07428	0.840	13.456
Benzine, C ₆ H ₆	3.3333	0.208	0.303	4.808
Ethane, C ₂ H ₆	1.3415	0.08565	0.746	11.950

TABLE XX. *Theoretical Evaporative Value of Petroleum Fuel and of Coal.*

Fuel.	Specific Gravity at 32° Fahr. Water = 1.000.	Chemical Composition.				Heating Power, British Thermal Units.	Theoretical Evaporation.	
		Carbon.	Hydrogen.	Oxygen.	Sulphur.		Lb. of Water per lb. of Fuel. From and at 212° Fahr.	At 8½ atm. effective pressure.
Pennsylvanian heavy crude oil	Sp. Gr. 0.886	Per cent. 84.9	Per cent. 13.7	Per cent. 1.4	Per cent. —	Units. 20,736	lb. 21.48	lb. 17.8
Caucasian light crude oil	0.884	86.3	13.6	0.1	—	22,027	22.79	18.9
Caucasian heavy crude oil.	0.938	86.6	12.3	1.1	—	20,138	20.85	17.3
Petroleum refuse	0.928	87.1	11.7	1.2	—	19,832	20.53	17.1
Good English coal, mean of 98 samples	1.380	80.0	5.0	8.0	1.25	14,112	14.61	12.16

TABLE XXI. *Ignition Point of Gases (Mayer and Munch).*

Marsh gas, CH_4	667°C.
Ethane, C_2H_4	616
Propane, C_3H_8	547
Acetylene, C_2H_2	580
Propylene, C_3H_6	504

TABLE XXII.

Kilos per square metre $\times 2.048 =$ pounds per square foot.
 Pounds per square foot $\times 4.884 =$ kilos. per square metre.
 Kilos. per square cm. $\times 14.223 =$ pounds per square inch.
 Pounds per square inch $\times 0.703 =$ kilos. per square cm.
 Evaporation from 16°C. at 12 kilos. $\times 0.8222 =$ evaporation from and
 at 100°C. = 212°F.
 Evaporation from and at 100°C. = 212°F. $\times 1.216 =$ evaporation from
 16°C. = 61°F. at 12 kilos.
 Metres $\times 3.281 =$ feet.
 Square metres $\times 10.764 =$ square feet.
 Feet $\times 0.3048 =$ metres.
 Square feet $\times 0.9308 =$ square metres.
 Gallons $\times 4.546 =$ litres.
 Litres $\times 0.21998 =$ gallons.
 Cubic metres $\times 16.386 =$ cubic cm.
 Cubic cm. $\times 0.061027 =$ cubic inches.
 Gallons (Imp.) $\times 1.2012 =$ American gallons.
 American gallons $\times 0.83226 =$ English Imp. gallons.
 American gallons $\times 3.784 =$ litres.
 Litres $\times 0.2642 =$ American gallons.
 Inches water gauge $\times 25.4 =$ millimetres water gauge.
 Imp. gallons $\times 0.1606 =$ cubic feet.
 Cubic feet $\times 6.288 =$ gallons.
 Kilos per metre $\times 2.015 =$ pounds per yard.
 Pounds per yard $\times 0.4962 =$ kilos. per metre.
 Calories per $\text{M}^3 \times 0.1121 =$ B.Th.U. per ft^3
 B.Th.U. per $\text{ft}^3 \times 8.92 =$ cal. per M^3
 Calories per $\text{M}^2 \times 0.3686 =$ B.Th.U. per ft^2
 B.Th.U. per $\text{ft}^2 \times 2.713 =$ cal. per Metre^2 .

TABLE XXIII. *To determine Temperature by Fusion of Metals.*

Substance.	Temp. Fahr.	Substance.	Temp. Fahr.	Substance.	Temp. Fahr.
Spermaceti .	120	Lead . .	619	Silver, pure	1,851
Wax-white .	154	Zinc . .	754	Gold coin .	2,128
Sulphur . .	239	Antimony.	815	Iron, cast .	2,074
Tin	448	Aluminium	1,180	Steel . . .	2,550
Bismuth . .	512	Brass . .	1,742	Wrought iron	2,911
Copper . . .	2,003				

TABLE XXIV. *Volume and Weight of Dry Air at Different Temperatures under a Constant Atmospheric Pressure of 29.92 in. of Mercury, the Volume at 32 deg. Fahr. being 1.*

Temperature. Degrees Fahrenheit.	Volume.	Weight of a Cubic Foot in lb.	Temperature. Degrees Fahrenheit.	Volume.	Weight of a Cubic Foot in lb.
0	.935	.0864	212	1.367	.0591
12	.960	.0842	230	1.404	.0575
22	.980	.0824	250	1.444	.0559
32	1.000	.0807	275	1.495	.0540
42	1.020	.0791	300	1.546	.0522
52	1.041	.0776	325	1.597	.0506
62	1.061	.0761	350	1.648	.0490
72	1.082	.0747	375	1.689	.0477
82	1.102	.0733	400	1.750	.0461
92	1.122	.0720	450	1.852	.0436
102	1.143	.0707	500	1.954	.0413
112	1.163	.0694	550	2.056	.0385
122	1.184	.0682	600	2.150	.0376
132	1.204	.0671	650	2.260	.0357
142	1.224	.0660	700	2.362	.0338
152	1.245	.0649	750	2.465	.0328
162	1.265	.0638	800	2.566	.0315
172	1.285	.0628	850	2.668	.0303
182	1.306	.0618	900	2.770	.0292
192	1.326	.0609	950	2.871	.0281
202	1.347	.0600	1000	2.974	.0268

TABLE XXV. *Table showing Number of British Thermal Units contained in one pound of pure Water at varying temperatures and densities, and pounds per gallon.*

Temperature. Deg. Fahr.	Density or Weight of 1 Cubic Foot. Pounds.	Number of Thermal Units in 1 pound of Water.	Pounds Weight per Gallon.	Temperature. Deg. Fahr.	Density or Weight of 1 Cubic Foot. Pounds.	Number of Thermal Units in 1 pound of Water.	Pounds Weight per Gallon.
1	2	3	4	1	2	3	4
*32	62.418	32.000	10.0101	135	61.472	135.217	9.859
35	62.422	35.000	10.0102	140	61.381	140.245	9.844
†39.1	62.425	39.001	10.0112	145	61.291	145.275	9.829
40	62.425	40.001	10.0112	150	61.201	150.305	9.815
45	62.422	45.002	10.0103	155	61.096	155.339	9.799
50	62.409	50.003	10.0087	160	60.991	160.374	9.781
55	62.394	55.006	10.0063	165	60.843	165.413	9.757
60	62.372	60.009	10.0053	170	60.783	170.453	9.748
65	62.344	65.014	9.9982	175	60.665	175.497	9.728
70	62.313	70.020	9.9933	180	60.548	180.542	9.711
75	62.275	75.027	9.9871	185	60.430	185.591	9.691
80	62.232	80.036	9.980	190	60.314	190.643	9.672
85	62.182	85.045	9.972	195	60.198	195.697	9.654
90	62.133	90.055	9.964	200	60.081	200.753	9.635
95	62.074	95.067	9.955	205	59.93	205.813	9.611
100	62.022	100.080	9.947	210	59.82	210.874	9.594
105	61.960	105.095	9.937	†212	59.76	212.882	9.565
110	61.868	110.110	9.922	230	59.36	231.153	9.520
115	61.807	115.129	9.913	250	58.75	251.487	9.422
120	61.715	120.149	9.897	270	58.18	271.878	—
125	61.654	125.169	9.887	290	57.59	292.329	—
130	61.563	130.192	9.873				

* 32°F. = Freezing point of water.

† 39.1°F. = The temperature at which water is at its greatest density.

‡ 212°F. = Boiling point of water.

A British Thermal Unit (B.Th.U.) = that quantity of heat that is required to raise one pound of water through one degree Fahr. at or near 39.1°F.

TABLE XXVI. *Saturated Steam.*

Saturated Steam is dry steam at the maximum pressure and density, due to its temperature—not superheated. It is attained when all latent heat required for the steam has been taken up—this is called “Saturation Point.” A vapour not near the saturation point behaves like a gas under changes of temperature and pressure; if it is compressed

or cooled it reaches a point where it begins to condense ; it then no longer obeys the same laws as a gas.

Heat and Work required to generate 1 lb. of Saturated Steam at 212°F. from Water at 32°F.

Distribution of Heat.	Units of Heat.	Mechanical Equivalent in foot pounds.
THE SENSIBLE HEAT—		
1. To raise the temperature of the water from 32°-212°	180.9	140,740
THE LATENT HEAT—		
2. In the formation of steam	894.0	695,532
3. In expansion against the atmospheric pressure	71.7	55,783
TOTAL OF WORK	1,146.6	892,055

TABLE XXVII. *Factors of Evaporation.*

Gauge Pressure of Steam in pounds per Square Inch.

0	20	40	60	80	100	Temp. of Feed Water.	120	150	180	200
1.187	1.201	1.211	1.217	1.222	1.227	32	1.231	1.236	1.240	1.243
1.179	1.193	1.203	1.209	1.214	1.219	40	1.222	1.227	1.232	1.234
1.168	1.182	1.192	1.198	1.203	1.208	50	1.212	1.217	1.221	1.224
1.158	1.172	1.182	1.188	1.193	1.198	60	1.202	1.207	1.211	1.214
1.148	1.162	1.172	1.178	1.183	1.188	70	1.191	1.196	1.200	1.203
1.137	1.151	1.161	1.167	1.172	1.177	80	1.181	1.186	1.190	1.193
1.127	1.141	1.151	1.157	1.162	1.167	90	1.170	1.176	1.180	1.183
1.117	1.131	1.141	1.147	1.152	1.157	100	1.160	1.165	1.170	1.172
1.106	1.120	1.130	1.136	1.141	1.146	110	1.150	1.155	1.159	1.162
1.096	1.110	1.120	1.126	1.131	1.136	120	1.140	1.145	1.149	1.151
1.085	1.099	1.109	1.115	1.120	1.125	130	1.129	1.134	1.138	1.141
1.075	1.089	1.099	1.105	1.110	1.115	140	1.119	1.124	1.128	1.131
1.065	1.079	1.089	1.095	1.100	1.105	150	1.109	1.113	1.117	1.120
1.054	1.068	1.078	1.084	1.089	1.094	160	1.098	1.103	1.107	1.110
1.044	1.058	1.068	1.074	1.079	1.084	170	1.088	1.092	1.096	1.099
1.033	1.047	1.057	1.063	1.068	1.073	180	1.077	1.082	1.086	1.089
1.023	1.037	1.047	1.053	1.058	1.063	190	1.066	1.071	1.076	1.078
1.013	1.027	1.037	1.043	1.048	1.053	200	1.056	1.061	1.065	1.068
1.004	1.017	1.027	1.033	1.038	1.043	210	1.046	1.051	1.055	1.057
1.002	1.000					212				

Formula from which the above figures are calculated—

$$H = TS - TW.$$

$$F = \frac{H}{LS}$$

TS=Total amount of heat contained in one pound of steam at absolute steam pressure—column 4, Table XXVI.

TW=Total heat of water at feed water temperature—column 3, Table XXV.

H=Heat imparted to water (TW to convert into steam TS).

LS=Latent heat of steam at atmospheric pressure 965.7.

F=Factor of evaporation.

Saving effected by heating feed water.

The saving in fuel effected by heating feed water can be calculated by formula as below—

$$\text{Percentage of saving} = \frac{100 (T-t)}{H-t}$$

in which T=heat units in one pound of feed water above 0° after heating—column 3, Table XXV.

t =heat units in one pound of feed water above 0° before heating—column 3, Table XXV.

H=heat units in one pound of steam of boiler pressure above 0°—column 4, Table XXVI.

TABLE XXVIII. *Heat Balance or Distribution of the Heating Value of the Combustible.*

TOTAL HEATING VALUE OF 1 LB. OF COMBUSTIBLE B.Th.U.	
	B.Th.U. = per cent.
1. Heat absorbed by the boiler=evaporation from and at 212 degrees per lb. of combustible × 966·7.	
2. Loss due to moisture in coal=per cent. of moisture referred to combustible ÷ 100 × [(212 - t) × 966 × 0·48 (T - 212)]. (t=temperature of air in the boiler room, T=that of the flue gases).	
3. Loss due to moisture formed by the burning of hydrogen =per cent. of hydrogen to combustible ÷ by 100 × 9 × [(212 - t × 966 × 0·48) (T - 212)].	
*4. Loss due to heat carried away in the dry chimney gases =weight of gas per lb. of combustible × 0·24 × (T - t).	
† 5. Loss due to incomplete combustion of carbon = $\frac{\text{CO}}{\text{CO}_2 + \text{CO}} \times \frac{\text{per cent. C in combustible}}{100} \times 10 \cdot 150$	
6. Loss due to unconsumed hydrogen and hydrocarbons, to heating the moisture in the air, to radiation, and unaccounted for. (Some of these losses may be separately itemized if data are obtained from which they may be calculated.)	
TOTALS	100·00

* The weight of gas per lb. of carbon burned may be calculated from the gas analysis as follows—

$$\text{Dry gas per lb. carbon} = \frac{11 \text{ CO}_2 + 8 \text{ O} + 7 (\text{CO} \text{ N})}{3 (\text{CO}_2 + \text{CO})}$$

in which CO₂, CO, O, and N are the percentages by volume of the several gases. The weight of dry gas per lb. of combustible is found by multiplying the dry gas per lb. of carbon by the percentage of carbon in the combustible and dividing by 100.

Professor Jacobus recommends the use of the following formula for finding the weight of air per lb. of carbon—

$$C = \frac{7 \text{ N}}{3 (\text{CO}_2 + \text{CO})} \div 0 \cdot 77$$

† CO₂ and CO are respectively the percentage by volume of carbonic acid and carbonic oxide in the flue gases. The quantity 10·150 = number of heat units generated by burning to carbonic acid one lb. of carbon contained in carbonic oxide.

TABLE XXIX.

Showing Heat Loss in Chimney Gases according to Percentage of Carbon Dioxide and Temperature Efficiency.

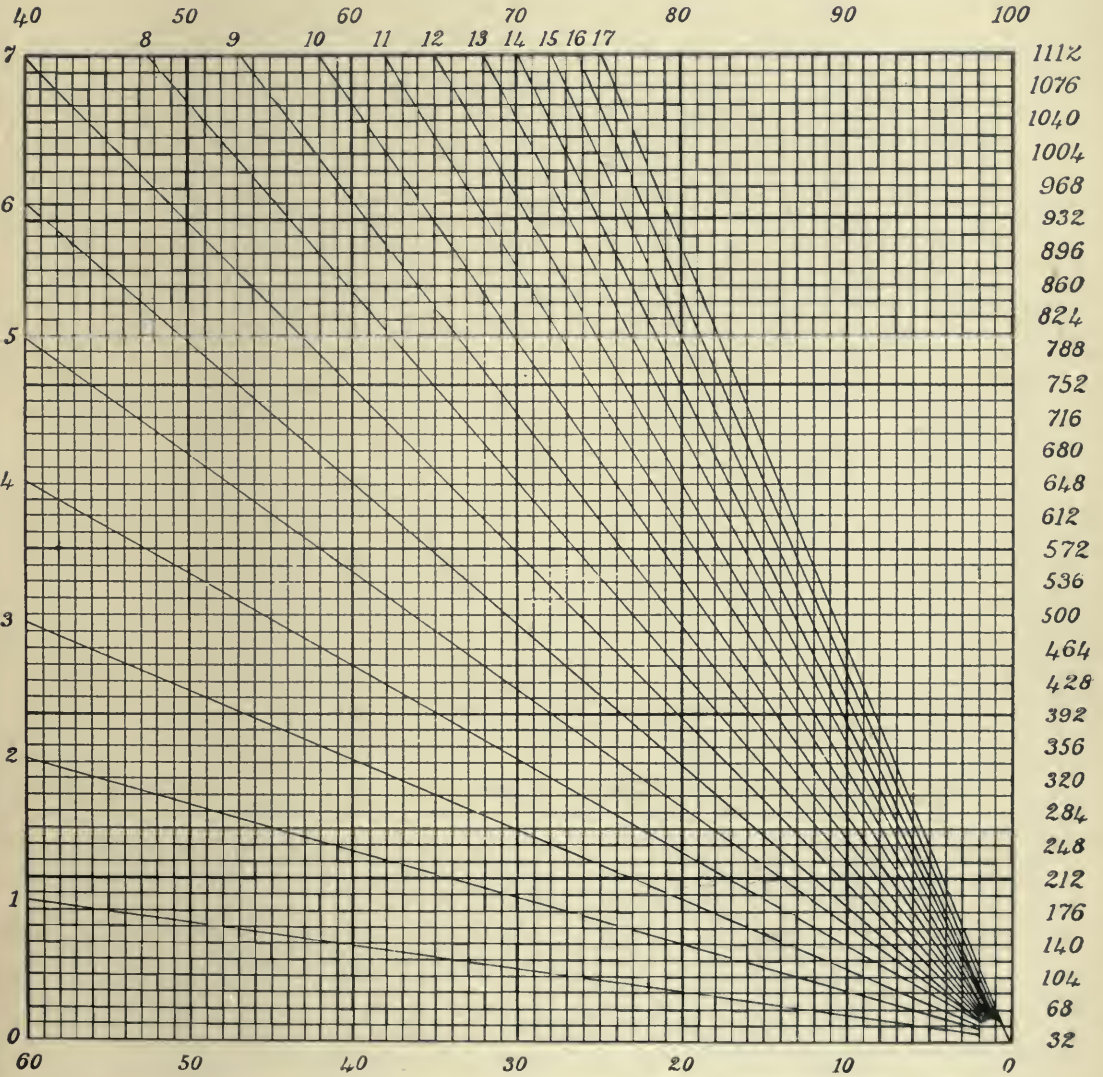

INDEX

A

- Abergele accident, 184
Acetylene, 289, 82
Adiabatic compression, 242
Admiralty flash tests, 130
Ados, Co₂ recorder, 236
Advantages of Liquid Fuel, 55
Aërated fuel system, 267
Air, atomizing by, 133, 222
— calculation of, 247
— compression, 242
— efflux, 238, 248
— for atomizing, 133, 214, 222, 247
— for combustion, 37, 40, 288, 290
— for combustion, Rankine, 114
— for combustion, Longridge, 114
— heater, 166
— heater, Ellis & Eaves, 223
— heating, 166
— lift pump, 33
— low pressure, 212, 269
— power to compress, 242
— pressure diagram, 242
— properties of, 82
— regulator, 202
— tuyere, 202
Alcohol, 282
Allest atomizer, 231
Allotropic forms of carbon, 78, 115
Alsace oil, 46, 281
American gallon, 44
American locomotive practice, 162, 178
— petroleum, 44
— petroleum production, 26
— stationary practice, 195
Amorphous carbon, 78
Analysis of Borneo oil, 208, 212
— chimney gas, 233
— coal, 112
— firebrick, 70, 71
— fireclay, 70, 71
Analysis of flame, 118
— flue gases, 233
— oil, 48
— petroleum, 48
— Texas oil, 48
Anthracite, 139, 116, 111
Anticline, 30
Apparatus, Orsat's, 233
Arch, firebrick, 67
Area of chimney, 239
Arlberg tunnel, 171
Arndt economizer, 236
Astatki, 36, 65, 208
Atmosphere, 82
Atomizers, various, 37, 250
Atomizer Aërated Fuel Co., 250
— Baldwin, 179, 250
— Bereznef, 37
— Billow, 196, 207, 250
— Circular, 36, 262
— d'Allest, 261
— elementary, 256
— flat jet type, 264
— Fvardofski, 262
— Guyot, 250
— Holden, 157, 250
— Höveler, 267
— hydroleum, 250
— Kermode's, 250
— Körting, 153, 250
— nozzles, 259
— Orde, 144
— power of, 259
— proportions, 261
— Rusden-Eeles, 134, 250
— Soliani, 263
— Southern Pacific Railway, 264
— Swensson, 250
— types of, 250
— Urquhart, 193, 250
— Wallsend, 148
— Williams, 56
Atomizing, 42, 214
— M. Bertin on, 153, 259

Atomizing agent, 214
 — necessity of, 42
 — with air, 133, 214, 222, 247
 — with steam, 133, 214, 222
 Aude, l', 259

B

Baku petroleum, 53
 Baldwin atomizer, 179
 — firebox, 180
 — oil fuel system, 179
 Ballast tanks, 129
 Barometer, 83
 Barrels of oil produced, 26
 — and gallons, 49
 Beaumont oil, 39, 50
 — tests, 56
 Bereznef atomizer, 36
 Berthelot on carbon, 79
 Berthelot-Mahler calorimeter, 91
 Berthelot on latent heat of carbon, 79
 Bertin on air compressing, 246
 — on atomizing, 153
 — on liquid fuel, 37
 — on mixed system, 37, 172
 — on ratio of oil and coal, 38
 Billow atomizer, 207
 — system, 195
 Bituminous fuel combustion, 40, 116, 112
 Blast furnace gas, 283
 — oil, 41, 47
 Blast pipe, variable, Macallan's, 170, 240
 Blocks, fireclay, 41
 Boiler, Belleville, 110
 — choice of, 24, 25
 — water, capacity of, 132
 — Cherbourg, 264, 176
 — Du Temple type, 146
 — firefloat burner, 219
 — French torpedo boat, 38
 — Godard, 258
 — Guyot, 176
 — hydroleum special, 215
 — Lancashire, 145, 167, 168
 — Lancashire, Orde's system, 145
 — locomotive, 154
 — marine, 133
 — marine type, 173
 — Solignac, 25
 — underfired tubular, 205
 — water capacity of, 24

Boiler, water tube, 169, 206
 — without grate, 169, 206, 213
 — Weir, 40, 121
 Boiling point of petroleum, 64
 Boring oil, 31
 Borneo oil, 212, 63, 208
 Brick, *see* Firebrick
 Brick arch, 67
 — linings, 67
 Bridge walls, 40
 British Thermal Unit, 294
Buffle, 259
 Bulkheads, 128
 Bunker pipes of oil supply system, 137
 Bunker pump, Weir's, 231
 — fuel oil, 231
 Burma oil, 281, 63
 Burner, Clarkson-Capel, 218
 Burners, *see* Atomizers, 250
 — Symon House, 257
 Burning of firebrick, 69
 Butane, 62

C

Calculation of temperatures, 100
 Californian petroleum, 44, 45
 Calorific formula, 90
 Calorific power of Borneo oil, 63
 — Burma oil, 63
 — carbon, 78
 — Caucasus oil, 63
 — gases, 283
 — hydrogen, 81
 — liquid fuel, 53, 99, 281, 284
 — Clavenad on, 107
 — Texas oil, 53, 63
 Calorimetry, 91, 236
 Calorie, 90
 Calorimeter, Berthelot-Mahler, 237
 Canada oil, 281
 Capacity of boilers, water, 132
 Cap damper, chimney, 240
 Carboic acid, 47
 Carbon, allotropic forms, 78, 115
 — amorphous, 78
 — as fuel, 78
 — atomic weight, 78
 — bisulphide, 79
 — calorific power of, 78
 — combustion of, 79
 — diamond, 78
 — dioxide, 79
 — gaseous, 79

- Carbon, graphitic, 78
 — heat of combustion, 78, 285
 — heat of conversion, 78, 79
 — in nature, 78
 — "liquid," 45, 79
 — monoxide, 78
 — properties of, 78, 285
 — solid, 78
 — vapour, 79
 Carbonic acid, 78
 — oxide, 78
 Carborundum, 67
 Cargo steamer, ordinary with oil fuel, 127
 Car hose, tank, 201
 Carriage of oil, 35, 228, 139
 Casing, 33
 Cast iron, 66
 Cement for oil pipes, 128
 Centigrade thermometer, 93
 Chamber, combustion, 73, 123
 Charcoal, *see* Amorphous carbon
 Chemical properties of air, 82
 — carbon, 78
 — hydrogen, 81
 — nitrogen, 84
 — oil, 62
 — oxygen, 83
 — petroleum, 62
 — Texas oil, 45
 Chemistry, Thermo-, 90
 Cherbourg, test at, 175
 — boiler, 176, 264
 Chicago Exhibition, 21
 Chimney area, 239
 — damper cap, 240
 — draught, 237
 — gases, 297
 Circular atomizers, 36, 262
 Classification of fireclay goods, 76
 Clarkson-Capel burner, 218
 — preliminary heater, 219
 — system, 218
 Clavenad on calorific capacity of fuel, 107
 Clay, *see* Fireclay
 CO₂ analysis, 233
 — in furnace gases, 233
 — recorder, Ados, 236
 — recorder, Arndt, 236
 — Simmance Abady, 236
 Coal, analysis of, 112
 — anthracite, 116, 139
 — combustion of, 108
 — long-flaming, 117
 Coal, short-flaming, 117
 — Welsh, 117
 — and oil furnace, 134
 — and oil, comparative cost, 132, 183, 286
 — production, 22
 — tar, 41
 Coefficient of expansion, oil, 129, 281
 — water, 85
 — gases, 282
 Cofferdams, 128
 Coils, heating, 140, 155
 Combustion, air for, 37, 288, 290
 — oxygen for, 288, 290
 — of anthracite, 116, 139
 — of bituminous fuel, 40, 112, 116
 — calculations, 78, 100
 — smokeless, 108
 — of carbon, 79
 — of hydrogen, 81
 — chamber, refractory, 123
 — chamber, 73
 — imperfect, 108
 — heat of, 63, 109, 288
 — of liquid fuel, 63
 — of hydrocarbon, 109
 — of vaporized liquids, 218, 257
 — principles of, 39
 — temperature of, 100
 — volume of gases, 103
 Comparative costs, oil and coal, 36, 59
 Compounds, hydrocarbon, 62, 112
 Compression, adiabatic, 242
 — of air, 242
 — compound, 242
 — diagrams, 242
 — isothermal, 242
 Conversion, metamorphic, of carbon, 78, 115
 Construction of furnace, 203
 Controlling valves, 160
 Corsicana petroleum, 51
 Cost, comparison of coal and oil, 35, 183
 — of oil, 36
 "Cracking," 52
 Cranes, oil, 230
 Creosote, 41, 46
 Cresylic acid, 47
 Crude oil, 41, 44, 281, 284
 Curves of compression of air, 244
 Curves of performance, Grazi-Tsaritzin Railway, 194

D

d'Allest's atomizer, 261
 Damper, chimney cap, 240
 Danger of oil, 36
 Density of petroleum, 49, 65, 183
 Denton, Prof., on Texas oil, 59
 — evaporative duty, 59
 — cost of oil, 59
 Deterioration by storage, 65
 Diamond, 78
 Diesel engine, 270
 Dinas firebrick, 67
 Dissociation of steam, etc., 87, 97
 — gases, 97, 102
 Dioxide of carbon, 78
 Distillation, fractional, 48
 Distribution of liquid fuel, 223
 Dowlais firebrick, 67
 Draught, 237
 Draught gauge, 239
 Dudley's formula for relative cost
 of oil and coal, 183
 Dutch Navy, 130
 Dulong's formula, 91

E

Earnshaw on Texas oil, 51
 Econometer, Arndt, 236
 Economics of liquid fuel, 35
 Efficiency of evaporation, 58
 — Texas oil, 56
 Efflux of air, 238, 248
 Elementary atomizer, 256
 Ellis & Eave's air heater, 223
 — system, 222
 Endothermism, 90, 92
 English locomotive practice, 154
 — stationary practice, 208
 Ethane, 62, 82, 202, 282, 289
 Equivalent, Joule's, 285
 — mechanical, of heat, 285
 Evaporation, factors of, 235
 — per unit of various fuels, 104
 Evaporative duty, 59, 104, 291
 — efficiency, 58
 Everhart on Texas oil, 48
 Exothermism, 38, 92
 Expansion of oil, 129, 231
 — water, 85
 Explosions, 229

F

Factors of evaporation, 235
 Factor, load, 24

Fahrenheit thermometer, 93
 Feed, oil, 161
 Firebox, American locomotive,
 163, 171
 — Baldwin, 180
 — Cherbourg boiler, 176, 264
 — Holden, 165
 — Lancashire, 167
 — locomotive, 168
 — Southern Pacific, 171
 — Urquhart, 188
 Firebricks, 67
 — aluminous, 76
 Firebrick, analysis, 70, 71
 — arch, 67
 — burning, 69
 — classification, 76
 — carborundum, 67
 — carboniferous, 96
 — Dinas, 67
 — Dowlais, 67
 — French, 67, 70
 — general particulars, 67
 — Glenboig, 67
 — manufacture, 67
 — Newcastle, 67
 — Pearson, 68
 — silica, 70
 — Stourbridge, 67
 Fireclay, analysis, 70, 71
 — blocks, 41
 — Dinas, 67
 — Dowlais, 67
 — Gartcosh, 73
 — Glenboig, 67
 — Kilmarnock, 71
 — Newcastle, 67
 — Stourbridge, 67
 Flame, 117
 — testing, 118
 — length, 38, 117
 Flannery-Boyd system of oil fuel,
 123, 136
 — oil storage, 127
 Flash point, 39, 65, 130
 Flue gas analysis, 233
 Forbin, test of, 177
 Forced draught, 240
 Fractional distillation, 48
 French firebrick, 67
 French Navy tests, 175
 Fuel, evaporative, power of, 59,
 104, 291
 — gas, 283
 — oil, 212

Fuel, oil bunker, 142
 — oil distribution, 228
 — oil production, 26
 — pumping, 231
 — pump, Weir's, 231
 — oil tanks, 229
Furieux, tests with, 175
 Furnace, Ellis & Eaves', 222
 — brickwork walls, etc., 146
 — construction, 203
 — Lancashire, 145, 165
 — firebricks, 67
 — lining, 39, 111, 146
 — locomotive, 168
 — management, 187
 — marine, 133, 173
 — oil and coal, 211
 — oil, 203
 — temperatures, 112, 81, 293
 — water tube, 213
 Fvardofski atomizer, 232
 — system, 262

G

Gallon, American, 44, 183
 — English, 182
 Gallons, per barrel, 183
 Galician oil, 53
 Ganister, 67
 Gartcosh fireclay, 73
 Gas, analysis, 233
 — blast furnace, 283
 — density, 285, 230
 — dissociation of, 97
 — expansion of, 282
 — fuel, 283
 — hydrogen, 283
 — marsh, 283
 — sp. heat, 283, 284
 — tar, 43, 47, 214
 Gases, calorific capacity of, 283
 — of combustion, volume of, 103
 — chimney, 297
 Gaseous carbon, 79
 Gauge, draught, 239
 Gear, marine furnace, 133
 General arrangement, 137
 — Körting system, 152
 General considerations, 21
 Geology, 28
 German oil, 281
 Glass, violet, 121
 Glenboig clay, 67
 Godard boiler test, 258

Graphite, 78
 Grate, boilers with, 211
 — boilers without, 210, 215, 206
 Gravity, 99
 — specific, 286, 287
 Grazi-Tsaritzin Railway, 184
 — curves of performance, 194
 — fuel tank, 231
 — locomotive, 189
 — oil distribution, 228
 — tender, 190
 Great Eastern Railway, 154
 — locomotives, 165
 — storage system, 229
 — tender, 165
 Griffin Engine, 270
 Guyot atomizer, 254
 — boiler, 176

H

Hanover oil, 50, 53
 Hard water, 88
 Howden's system, 133, 143
 Heat, 92
 — of combustion of carbon, 80, 99
 — of combustion of petroleum,
 etc., 108, 109
 — latent, of carbon, 90
 — of dissociation, 79
 — latent, 96
 — mechanical equivalents of, 98
 — of metaphoric conversions, 78
 — quantity of, 92, 97
 — specific, 94
 — thermometric, 92
 — units, 90
 Heater, Clarkson-Capel preliminary,
 218
 — Ellis & Eaves air, 223
 Heating air, 166, 223
 — coils, 223
 — oil, 263
 Holden atomizer, 157
 — system, 154
 Hornsby Engine, 282
 Hose, 201
 Hose, tank car, 201
 Höveler system, 237
 Howden's system, 133, 143
 Hydrocarbon compounds, 62, 112
 — combustion of, 109
 Hydrogen, calorific power of, 81
 — combustion of, 81
 — gas, 81

- Hydrogen properties of, 81
 — temperature of ignition, 82, 119
 Hydroleum special boiler, 215
 — atomizer, 250
 — system, 214
- I
- Ignition temperature, 82, 119, 292
 Imperfect combustion, 102
 Indret, tests at, 176
 Injector, *see* Atomizer
 Interchange of coal and oil, 134
 Iron, cast, 66
 Isothermal compression, 242
- J
- Japanese railways, 162
 Jeanne d'Arc, the, 174
 Joule, Dr., 98
- K
- Keller, tests by, 37
 Kelvin law, 26
 Kermode's atomizer, 250
 — system, 208
Khodoung, s.s., 143
 Kilmarnock fireclay, 71
 Kilns, oil fired, 74
 Kimeridge clay, 28
 Körting atomizer, 153
 — system, 152
 Koudako oil, 49
- L
- Laeisz*, F. C., s.s., 143
 Lamp oil, 43, 218
 Lancashire boiler, 145, 167
 Latent heat, 96, 113
 Latitude and barometer, 83
 Length of flame, 38, 117
 Lighting up, 187
 Lima oil, 184
 Lining furnace, 39, 111, 146
 "Liquid" carbon, 45
 — combustion, 38
 Liquid fuel, 37
 — advantages of, 55
 — at sea, 127
 — containing oxygen, 47
 — distribution, 228
 — economics of, 35
 — price of, 35, 59
- Liquid fuel, production, 26
 — — properties of, 49, 65, 183
 — system, Wallsend Slipway Co., 143, 146
 — varieties of, 43
 Load factor, 24
 Locomotive, American, 162, 178
 — boiler, 154, 178
 — Cherbourg, 264
 — firebox, 154, 163, 171
 — Fvardofski, 262
 — Great Eastern Railway, 154
 — practice, American, 162, 178
 — practice, English, 154
 — practice, Russian, 178
 — Southern Pacific, 171
 — Vladi Kavkaz Railway, 153
 — Urquhart, 184
 Low pressure air, 212, 269
 Loss by excess of air, 297
- M
- Mabery on Texas oil, 50
 Macallan variable blast pipe, 170, 240
 Management of furnace, 187, 204
 Manufacture of firebrick, 67
 Marine boiler, 173
 — type boiler, 173
 — furnace gear, 133, 173
 Marsh gas, *see* Methane
 Materials, 66
 Mazout or Mazut, *see* Astatki
 Mechanical stoking, 24
 — equivalent of heat, 98
 Metallurgy, application of liquid fuel to, 267
 Metal and refining furnace, 266
 Metamorphic conversion of carbon, 78, 115
 Methane, 22, 82
 Meyer system, 172
Milan, test on, 177
 Mixed system of coal and oil combustion, 35, 172
 Moat, round oil stores, 228
 Monoxide of carbon, 78
Murex, s.s., 127, 133
- N
- Nacogdoches oil, 48
 Naphthalene, 47
 National Fuel Oil Co.'s system, 95

Navy, British, 21, 130
 — Dutch, 130
 — French, 175
 — German, 130
 — Italian, 258
 — Russian, 65
 Newcastle fireclay, 67
 — coal, 47, 112
New York, s.s., liquid fuel for, 138
 Nitrogen, 84
 — in atmosphere, 84
 — properties of, 84
 Nozzles of atomizers, 259

O

Oil, Alsace, 53, 46
 — American, 44, 46
 — Baku, 53, 284, 36
 — Beaumont, 39
 — blast furnace, 47
 — boring, 31
 — Borneo, 63, 212, 208
 — Burma, 281, 63
 — California, 44, 54
 — Canada, 281, 46
 — Corsicana, 51
 — creosote, 46
 — crude, 183, 281, 284, 46
 — drilling, 32
 — fuel, 212, 284
 — Galicia, 53, 46
 — Gold Coast, 49
 — Hanover, 50, 53
 — Koudako, 49
 — lamp, 218, 43
 — Lima, 184
 — Nacogdoches, 48, 51
 — Pennsylvania, 46, 49, 53, 286
 — reduced, 44
 — residuum, 36, 42, 287
 — Roumanian, 46, 49
 — Russian, 46, 286
 — shale, 47
 — Sour Lake, 51
 — Texas, 45, 49
 — Wyoming, 86
 — Zante, 49
 — and coal, comparative cost, 38, 286
 — and coal furnace, 136
 — burner, *see* Atomizers
 — calorific power, 281, 284
 — carriage of, 35, 139, 228
 — cranes, 231

Oil engines, 271
 — expansion, 129, 281
 — explosions, 229
 — distribution, 228
 — feed, 161
 Oil furnaces,
 — furnace, Baldwin, 178
 — engines, 271
 — Cornish, *see* Lancashire
 — Holden, 165, 168
 — Lancashire, 168
 — locomotive, 154-178
 — water tube boiler, 169
 Oil heating, 263
 — pressure, 269
 — pipes, 229
 — pump, 231
 — pumping system, 196, 32
 — ratio to coal, 54
 — regulation, 161, 179
 — regulator, 161, 179
 — safety moat, 228
 — service pumps, 196, 231
 — steamers, recent, 129
 — storage, 127, 228
 — stratification, 30
 — tank steamer, 138
 Orde atomizer, 144
 — boiler, Lancashire, 145
 — on liquid fuel, 63
 — system, 140, 143
 — water-tube boiler, 141
 Orsat-Lunge apparatus, 236
 Oxygen, 83

P

Packman, s.s., 133
Pakin, test on, 177
 Paraffin, 221
 Paul, Dr., on liquid fuel, 62
 Pearson firebricks, 68
 Pelouze and Cahours on hydrocarbons, 64
 Pennsylvania oil, 49, 286
 Performance curves, Grazi-Tsaritzin Railway, 194
 Petroleum
 — American, 44
 — analysis of, 48
 — Baku, 53, 284
 — Borneo, 212, 63
 — Burma, 281, 63
 — boiling point, 64
 — California, 44, 54
 — combustion of, 109, 218, 257

- Petroleum, Corsicana, 51
 — drilling, 32
 — fuel, 183
 — geology, 28
 — production of, 26
 — properties of, 49, 65, 183
 — pumping, 32
 — residuum, 36, 42, 287, 291
 — Russian, 46, 286
 — storage precautions, 228
 — Texas, 45, 49
 Phillips on Texas oil, 49
 Physical properties of oil, 49, 65, 183
 Pipes, 88, 229
 — bunker, 128, 137
 — jointing, 128
 — jointing cement, 128
 — water, 88
 Pood, its equivalent, 230
 Power to compress air, 247
 Precautions in oil storage, 228
 Preliminary heating, 218
 Pressure systems, 196
 Price of oil, 35, 59
 — per barrel, 36, 54, 59
 — per gallon, 36, 44
 Principles of liquid fuel combustion, 38
 Production of coal, 22
 Propane, 62, 82
 Properties of air, 82
 — American oil, 44, 46
 — Borneo oil, 63, 208, 212
 — carbon, 78, 285
 — firebricks, 67
 — fireclay, 67
 — gases, 283
 — hydrogen, 81
 — liquid fuel, 49, 65, 183
 — nitrogen, 84
 — oxygen, 83
 — petroleum, 49
 — Russian oil, 46, 256
 — Texas oil, 45, 51
 — water, 84
 Proportions of atomizers, 261
 Propylene, 82
 Pulverizers, *see* Atomizers
 Pump, Weir's bunker, 232
 — Weir's oil, 232
 Pumping systems, 196
 Pumps, oil, 231
 Pyrometers, 94
- Q
- Quantity of heat, 92, 97
- R
- Ragosine effect of steam on oil, 260
 Ratio, oil to coal, 38
 Réaumur's thermometer, 93
 Reduced oils, 44
 Refractory combustion chamber, 73
 — linings, 39, 73, 111, 146
 Regulating gear, 161, 179
 Regulation of oil, 161, 179
 Regulator, air, 202
 — oil, Baldwin 179
 — oil, G.E. Rly., 161
 Relative cost, oil and coal, 132, 183, 268, 286, 191
 Residuum, 36, 42, 197
 Ringelmann's smoke chart, 123
 Riveting, 128
 Roumanian oil, 49
 Rules for liquid fuel ships, 127
 Rusden-Eeles atomizer, 134
 Russian locomotives, 191
 — Navy, 65
 — oil, 46
 Ruston Proctor Engine, 271
- S
- Safety moat round tanks, 228
 St. Clair Deville, 102
 Salts, solubility of, 87
 Sea water, 88
 Serpollet on vaporizing, 263
 Service, oil pumps, 231, 196
 Shale oil, 47
 — tar, 47
 Silica, 67-77
 Siloxicon 77
 Simmance Abady CO₂ recorder, 236
Sithonia, s.s., 143
 Small tube boiler, 141
 Smoke, 82, 109
 — chart, Ringelmann's, 123
 — prevention, 109
 Soft water, 88
 Soliani atomizer, 263
 Solignac boiler, 25
 Solubility in water of salts, 87
 Soot, 82
 Sour Lake oil, 51
 Southern Pacific Railway, 36, 54, 171, 264

- Specific gravity, 46, 49, 65, 164
 Specific heat, 94
 — gases, 95
 — ice, 86
 — solids, 284
 — water, 86
 Sprayer, *see* Atomizer
 Springfield system, 269
 Stationary practice, American, 195
 — English, 208
 Steam, as fuel, 15
 — atomizing, 133
 — dissociation by heat, 87, 97
 — per pound of oil, 258
 — ships, *F. C. Lacisz*, 143
 — *Murex*, 127, 133
 — *Newyork*, 139
 — *Sithonia*, 143
 — *Syrian*, 143
 — *Tanglier*, 133
 — *Trocas*, 129, 134
 Steam, superheated, 294, 143
 Steamer, cargo with oil fuel, 127
 — recent oil, 138
 — tank with oil fuel, 129
 Steel, 66
 Steel tubes, 66
 Storage of oil, 228
 — safety moat, 228
 — system, G.E. Rly., 229
 — tank, oil, 228
 Stourbridge clay, 67
 — firebricks, 67
 Subweolden, boring, 29
 Sulphur in oil, 36, 59
 Sumatra oil, 49
 Superheated steam, 294
 Supply of water, 84
 — tank, oil, 231
 — system, bunker pipes, 137, 141
Surcouf, test of, 177
 Swensson atomizer, 256
Syrian, s.s., 143
 System, Aërated Fuel Co., 267
 — Baldwin Co., 178
 — Billow, 195
 — Clarkson-Capel, 218
 — distribution, 228
 — Ellis & Eaves, 222
 — Flannery Boyd, 136
 — Fvardofski, 262
 — Guyot, 254
 — Holden's, 154
 — Höveler, 267
 System Howden's, 133 143
 — hydroleum, 214
 — Kermodé's, 208
 — Körting, 143, 152
 — Meyer, 172
 — mixed, 37, 172
 — National Fuel Co., 195
 — Orde's, 140, 143
 — Pumping, 231, 198
 — Rusden-Eeles, 134, 143
 — Springfield, 269
 — Symon House, 257
 — Urquhart, 184
 — Wallsend Slipway Co.'s, 143, 146
- T
- Tanglier*, s.s., 133
 Tank, car hose, 201
 — oil supply, 231
 — steamer, 138
 — storage, 228
 — underground, 230
 Tar, 41, 43, 47, 214, 237
 — properties of, 237
 — water gas, test of, 215
 — shale, 47
 Temperature, 92, 284, 293
 — calculation of, 100
 — flame, 112, 259
 — furnace, 112
 — of combination, 101
 — of ignition, 82, 292
 Tender, fuel, 186
 — G.E. Rly., 165
 — Grazi-Tsaritsin Railway, 186, 190
 Test of air atomizing, 226
 — Beaumont oil, 57
 — Borneo oil, 208, 211
 — *Furieux*, 175
 — marine boiler, 222-227
 — Texas oil, 56, 48
 Tests at Cherbourg, 175, 264
 — at Birkenhead, 212
 — at Indret, 176
 — Godard boiler, 258
 — Russian oil, 37
 Texas oil, 45, 51
 — analysis, 48, 51
 — calorific power of, 53
 — carriage of, 35
 — chemistry of, 48
 — costs, 59

- Texas, density of, 49
 — efficiency of, 56
 — specific gravity of, 49
 — tests of, 56
 Thermal units, 90, 294
 Thermo-chemistry, 90
 Thermometer, 93
 Thiele on Texas oil, 45, 51
 Torpedo boat, 38
 — boiler, French, 260
 Trinidad, 28
Trocas, s.s., 129, 134
 Tubular boiler, underfired, 205
 Tunnels, Railway, 171
 Tuyere, air, 202
- U
- U gauge, 239
 Underfired tubular boiler, 205
 Units of heat, 90, 97
 — thermal, 97
 — weight, 85, 98
 — work, 98
 Urquhart atomizer, 193
 — locomotive, 191
 — system, 184
 — tender, 188
 Useful figures, 87, 89, 292
- V
- Vaporization, heat of, 106, 117
 Vaporized liquids, combustion of, 218
 Vaporizer, 273, 275
 Vaporizing, 43, 216, 218, 276
 — carbon, 78, 79
 Variable blast pipe, Macallan's, 170, 240
 Varieties of liquid fuel, 43
 Velocity of efflux of air, 238, 248
 — draught, 237
 — water in pipes, 88
 Ventilation, 128
 Verein-Deutsche ingenieur, 91
 Violet rays in flame, 120
 Volatile constituents of petroleum, 36, 39, 42, 47
 Volume and weight of atmosphere gases, 293
 — gases, 289
 — petroleum, 183
 — of combustion gases, 289
- W
- Wallsend Slipway Co., 143, 146
 — Atomizer, 148
 — furnace brickwork, 146
 — latest system, 149
 Warming oil fuel, 263
 War vessels, Sir F. Flannery on, 130
 Water capacity of boilers, 24
 — compressibility, 85
 — data, 85
 — expansion by heat, 85
 — flow of, 88
 — gas tar, 215
 — gauge, 239
 — hardness, 88
 — in oil, 68
 — latent heat of, 84
 — pipes, 88
 — properties of, 84, 294
 — pure, 84, 294
 — solubility of salts in, 88
 — source of, 84
 — specific heat, 86
 — supply, 84
 — useful data, 89
 — weight, 87
 Water-tube boiler, Guyot, 176
 — Hydroleum, 215
 — Orde's system for liquid fuel, 140
 — Wealden, 29
 — Weir's, 40, 121
 — without grate, 169, 206
 Weight of air, 82, 289
 — gases, 289
 — hydrogen, 81, 289
 — firebrick,
 — oil, 58
 — oil per barrel, 58
 — oil per gallon, 58
 — oxygen, 84, 289
 — nitrogen 84, 289
 — water, 85, 294
 Weir's boiler, 121, 40
 — oil pump, 231
 Welsh coal, 117
 Williams atomizer, 56
 Work units, 98
 Wyoming oil, 46
- Z
- Zante oil, 49

TRADE



MARK.

*When soliciting quotations for Oil Well Plant
send your enquiries to :—*

DUKE & OCKENDEN,

LIMITED.

**COMPLETE DRILLING OUTFITS
AND OIL WELL SUPPLIES OF
BRITISH & AMERICAN DESIGN.**

Advice gratuitously tendered upon
the most suitable plant to suit
varied geological conditions.

**OVER 40 YEARS' EXPERIENCE
AS WELL ENGINEERS.**

126, SOUTHWARK ST., LONDON, S.E.

Cables : "DUGOUT, LONDON."

Codes : A.B.C. and LIEBER'S.

KERMODE'S LIQUID FUEL SYSTEMS FOR NAVAL SHIPS OF EVERY TYPE.

For Merchant Steamers, for Land Boilers
and for Industrial Process Furnaces.

SUPPLIED TO THE BRITISH, DUTCH, ARGENTINE,
AND CHINESE GOVERNMENTS.

British Battleships and Cruisers fitted with the Kermode System include the "Dreadnought," "Bellerophon," "Temeraire," "Superb," "Agamemnon," "Lord Nelson," "St. Vincent," "Vanguard," "Collingwood," "Neptune," "Hercules," "Colossus," "Orion," "Lion," "Princess Royal," "Indefatigable," "Invincible," "Inflexible," "Indomitable," "Defence," "Shannon," "Minotaur," "Achilles," "Cochrane," "Natal," "Warrior," &c. Ocean-going Destroyers fitted include the "Afridi," "Amazon," "Cossack," "Crusader," "Gurka," "Maori," "Mohawk," "Nubian," "Saracen," "Tartar," "Viking," "Zulu," "Swift," &c.

EFFICIENT. SMOKELESS. ECONOMICAL.

Handles Creosote, Blast Furnace Oil, Water Gas-Tar, Mond Gas-Tar,

Pure and Crude Petroleum, Residuum, or other Hydrocarbons.

Air Jet, Steam Jet, Pressure Jet Systems, and all Appliances

connected with the burning of Liquid Fuel.

HIGHEST AWARD

Naval, Shipping and Fisheries Exhibition, London, 1905.

Address: 62, DALE St., LIVERPOOL.

Telegrams:
"WARMTH."

London Address: 109, FENCHURCH ST.

Holden's System of Liquid Fuel Burning.

With the Holden Burner most efficient combustion is obtained without smoke.

Oil being fed to the Burners by gravity, no pumps, compressors, or high pressure tanks are required with the Holden System.

Oil and Coal can be burned together or separately on any type of Boiler, by the Holden System.

TAITE & CARLTON,

**63, Queen Victoria Street,
LONDON, E.C.**



WEIR OIL FUEL PUMPS

as supplied to the
British
Argentine
Brazilian
Chinese
Italian
Japanese
Spanish
United States
and other Navies.



OIL TANK PUMPS



OIL PIPE LINE PUMPS

Triple & Compound.

For all pressures up to 1000 lbs. per sq. in.



G. & J. WEIR, L^{TD}, Cathcart,
Glasgow.

From **CONSTABLE'S** List

WORKS BY W. H. BOOTH.

Superheat, Superheating, and their Control. Illustrated. Demy 8vo. 6s. net.

Liquid Fuel and its Combustion. With about 120 Illustrations and Diagrams. Imperial 8vo. 24s. net.

Steam Pipes : Their Design and Construction. Fully Illustrated. Demy 8vo. 5s. net. *Second Edition.*

Water Softening and Treatment : Condensing Plant, Feed Pumps and Heaters for Steam Users and Manufacturers. With Tables and many Illustrations. Demy 8vo. 7s. 6d. net. *Second Edition.*

Smoke Prevention. By W. H. Booth and J. B. C. Kershaw, F.I.C. Fully Illustrated. Demy 8vo. 6s. net. *Second Edition, revised.*

Liquid and Gaseous Fuels, and the part they play in Modern Power Production. By Professor VIVIAN B. LEWES, F.I.C., F.C.S., Professor of Chemistry, Royal Naval College, Greenwich. With 54 Illustrations. Extra Crown 8vo, 6s. net.

Chemical News : "The Author understands how to interest the reader, and gives a very practical account of the use of liquid and gaseous fuels . . . parts of the book which treat of the heating and illuminating power of oil lamps will help the consumer to form an estimate of the cost and efficiency of heating and cooking under different conditions."

Gas, Gasoline, and Oil Engines, including Gas Producer Plants. Fifteenth Edition, Reset and Enlarged. By GARDNER D. HISCOX, M.E., Author of "Mechanical Movements," "Compressed Air," etc. Fully Illustrated. Demy 8vo. 10s. 6d. net.

The Construction and Working of Internal Combustion Engines. By R. E. MATHOT. Being a Practical Manual for Gas Engine Designers, Repairers and Users. Translated by W. A. TOOKEY. Medium 8vo. With over 350 Illustrations. 24s. net.

Mechanical World : "A thoroughly satisfactory translation . . . there is no doubt as to the utility of the book, and we have much pleasure in specially commending it to the notice of designers of gas engines, and to students of the subject generally."

The Design and Construction of Internal Combustion Engines. A Handbook for Designers and Builders of Gas and Oil Engines. By HUGO GÜLDNER. Translated from the Second Revised Edition, with additions on American Engines, by H. DIEDERICH, Professor of Experimental Engineering, Cornell University. Illustrated. Imperial 8vo. 42s. net.

The Internal Combustion Engine. Being a Text-book on Gas, Oil, and Petrol Engines, for the Use of Students and Engineers. By H. E. WIMPERIS, M.A., Assoc.M.Inst.C.E., Assoc.M.Inst.E.E. Illustrated. Crown 8vo. 6s. net.

The D.-S. Series of Technical Dictionaries in Six Languages.

English. Spanish. German. Russian. French. Italian.

EDITED AND COMPILED BY

Messrs. DEINHARDT and SCHLOMANN.

With each word, term, or item, so far as it is possible, a diagram, formula, or symbol is given so that error or inaccuracy is almost impossible.

Internal Combustion Engines, with about 1,000 illustrations and numerous formulæ. *Cloth, 8s. net; leather, 12s. net.*

Full list of further volumes in this series will be sent on application.

LONDON: 10 ORANGE STREET W.C.

