

CRESCENT STOVES & RANGES

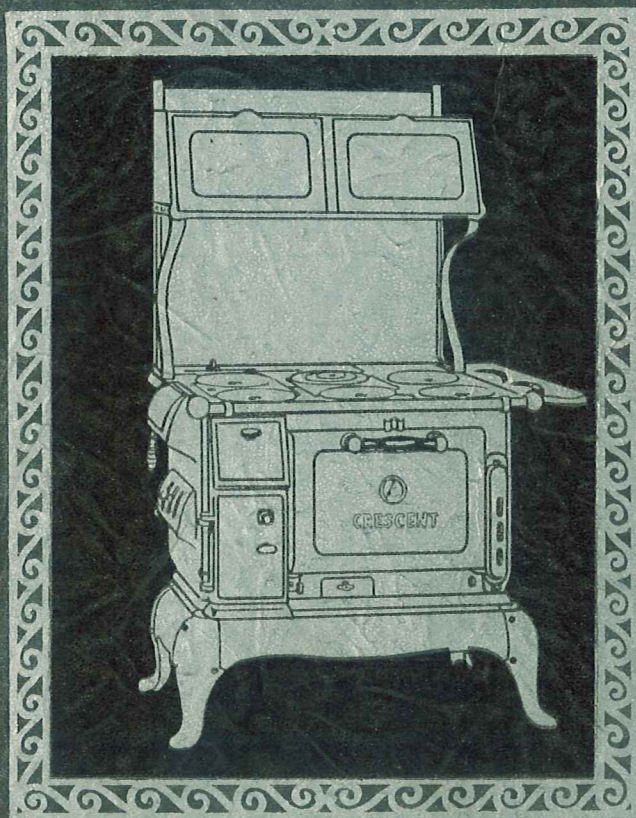

GENERAL
CATALOGUE

CRESCENT STOVE WORKS
EVANSVILLE, INDIANA

THE UNIVERSITY OF CHICAGO
LIBRARY

GERMANY
WATSON

THE UNIVERSITY OF CHICAGO
LIBRARY

GENERAL CATALOGUE

CRESCENT

STOVES *and* RANGES

... FOR COAL, WOOD AND GAS ...

CATALOGUE NO. 42



1924

CRESCENT STOVE WORKS

PARK STREET AND BELT R. R.

EVANSVILLE, INDIANA

PERMANENT SALESROOM

Fourth Floor, Furniture Building, Evansville, Indiana

...Introductory...

In the manufacture of the Crescent line of Stoves and Ranges we have followed in absolute detail the essentials demanded by the buying public, which are:

- 1 Ability to give the best results whether in cooking or heating.
- 2 Proven lowest cost of operation.
- 3 Sturdy, strong and long life under regular and severe usage.
- 4 Standard parts that make replacements quick and economical.
- 5 Beauty of design.

By observing these requirements of the public, we have made it possible for the dealer to build a bigger, better and permanent stove business in his territory and have guaranteed to ourselves the success that always follows a work well done.

To the dealer and to the buying public we dedicate this catalog of Crescent products

INDEX TO CONTENTS

Name	Pages
Combination Ranges for Coal, Wood and Gas.....	6-12
Gas Ranges.....	13-43
All Cast Ranges for Coal or Wood.....	44-85
Steel Ranges for Coal or Wood.....	86-93
Cooking Stoves for Coal or Wood.....	94-100
Cooking Stoves for Wood only.....	101-108
Heating Stoves for Coal or Wood.....	109-120
Heating Stoves for Wood only.....	121-126
Laundry Stoves.....	127-129
Repair Cuts.....	130-137
Stove Pipe, Hollow Ware, Etc.....	See Price List

OUR TERMS

Two per cent for cash in 10 days or 30 days net. If closed by Trade Acceptance 60 days will be allowed for net maturity. On Repairs and Extras, due net cash in 30 days, F. O. B. Evansville, Indiana.

All bills are payable in St. Louis, Chicago or New York par funds, without allowance for Exchange or Express Charges.

Interest will be charged on accounts past due. Invoices past due subject to sight draft with exchange.

We do not insure safe delivery of goods; our responsibility as shippers ceases on delivery in good order to the transportation company.

We will assist our customers in collecting claims for excessive breakage or damage.

The transportation companies will not entertain a claim until goods have been received by the purchaser, the freight paid on shipment, and breakage or damage noted on the EXPENSE BILL by their agent. We cannot file claim until our customer complies with this requirement and sends us the EXPENSE BILL WITH R. R. AGENT'S NOTATION, together with bill for amount of claim. This also applies to concealed breakage or damage which should be called to R. R. Agent's attention and noted on expense bill before sending us the claim.



Crescent "Pemco" Porcelain Enameled Ranges

Pemco Porcelain Enamel is used exclusively on Crescent Ranges. "Pemco" Enamels are of an entirely different composition from ordinary enamel. The ingredients of "Pemco" are the purest and best materials compounded with minute care and smelted into enamel glass by the "Pemco" process. All of our enameling is done in our own exclusive enameling plant, under our personal supervision and inspection, thereby assuring that every enameled part is sure to be perfect in every respect.

The superiority of "Pemco" Porcelain Enamel is not in any way imaginary. It is absolutely impervious to heat and dirt, and will not craze through a life-time of service. It will be a short time only until all Kitchens are equipped with porcelain enamel finished ranges. Modern science has made it possible to so reduce the cost of enameling as to make it available for range finishing and thus the Housewife of today may have a beautiful **Snowy-White, Blue or Gray Range**. They appeal strongly to the women who try to make their Kitchens more attractive and easier to work in. The drudgery of stove blackening is banished. They are as easy to clean as a china dish.

The market for enameled ranges exists among all classes of people—from the rich to those of most moderate circumstances. They will sell in your vicinity. An enameled Range in the show window or on the sample floor will attract more attention than all of the other ranges you may have. **Crescent Enameled Ranges** meet the situation; they give your sales force something special, distinctive and better to talk about. Put them on your floor, increase your business and reap a double profit from every sale.

"PEMCO" STANDS FOR "SUPREMACY" IN PORCELAIN ENAMELING.

Why We Use "Armco" Ingot Iron - - -

It is not generally known that there is as much variation in the various kinds of iron and steel as regards hardness, softness and grain texture as there is in the different varieties of woods. The public has learned the difference between pine, oak and mahogany, but it is largely ignorant of the classes of metals. Improperly made iron or steel falls into the same category as cheap lumber, giving only minimum service as compared with the better grades.

With a keen realization of this, we spent a lot of time thoroughly investigating before we determined upon the sheet metal to be used in our products. The result of our search led us to adopt ARMCO-INGOT IRON, the world's purest commercial iron.

ARMCO-INGOT IRON is not a new and untried product. It has been manufactured for more than fifteen years and in all of this time, it has held to a rigid standard of purity—99.84%—considering as impurities silicon, sulphur, phosphorus, manganese, carbon, copper and the gases, oxygen, hydrogen and nitrogen.

The name "ARMCO" on sheet iron is the same as the word "STERLING" on silver—a guarantee of purity. It is put there for your protection in buying quality products.

It is the purest sheet iron money can buy—costs more, but worth all it costs in the additional service it gives.

When quality is demanded in a product, quality materials must be used. That's why pure "ARMCO" rust resisting Ingot Iron is used in the manufacture of

CRESCENT STOVES AND RANGES

All enameled sheet metal parts for gas stoves and warming closets are made from "ARMCO" Ingot Iron Enameling Stock. Plain sheet metal parts can be furnished in lustrous blue polished steel, or a very pleasing satin finish black enamel.



CRESCENT DUAL OVEN COMBINATION RANGE

Distinctive
in Design



Excellent
Workmanship

A PRACTICAL COMBINATION RANGE
BEAUTIFUL—CONVENIENT—ECONOMICAL

THREE BIG OVENS—One for baking with coal or wood
—One for broiling and toasting
—One for baking with gas

Within easy reach above the cooking top are the gas ovens for baking and for broiling and toasting. They are both adapted for the use of **Manufactured and Natural Gas**. Oven below is for the use of coal or wood. All three ovens are operated the same as any ordinary gas or coal and wood range oven. Each oven is ready for instant use separately or all at the same time. Nothing to shift, change, take out or put back. No cold spots in oven. No complicated parts or obstructed flues. All danger has been eliminated. A **simple, Sensible Range**, serviceable all the year round.

Special attention is called to the construction of the elevated oven and broiler section. Double cast iron brackets, which support the elevated ovens are especially designed so that the elevated section extends six inches over the rear of the range. By this arrangement **The Overhang Over The Cooking Top Is Only Twelve Inches**. It also gives a more even balance to the elevated section, which, due to the rigidity of the double cast iron brackets, remains firm when opening or closing doors of oven and broiler. This design gives the entire range a very attractive appearance.

There is no other Elevated Oven Range, having a gas oven 17 inches deep with an overhang of only 12 inches.

See Opposite Page for Dimensions and Equipment



CRESCENT DUAL OVEN COMBINATION RANGE



Dimensions and

Equipment

DEPENDABLE THE YEAR ROUND

Dimensions

Coal or Wood Oven 18 x 18 x 12	Gas Oven 18 x 17 x 11	Broiling Oven 18 x 12 x 11	Height to Cooking Top 31 inches
Size of Cooking Top 24 x 44½	Cooking Top to Gas Oven 16 inches	Extreme Height 63 inches	Pipe Collar for Coal or Wood 7 inches
			Pipe Collar for Gas 4 inches

Equipment

Four eight inch cooking holes for coal or wood. Four regular center heat top burners, and one simmer burner for gas. Safety open door oven lighter. Adjustable gas cocks with porcelain handles. Enameled dirt tray, broiler pan and door panels. All cast iron parts of elevated oven on plain styles black enameled. Aluminized oven linings. Solid gas top with removable grids. ¾ inch manifold pipe. Four flame oven and broiler burners, operated by one valve. All piping is furnished with range connecting gas oven and broiler with top manifold.

Full enameled Ranges Have Polished Top on Coal and Wood Section and Enameled Top on Gas Section. Also furnished on Other Styles When Wanted.

Sliding Direct Damper in Top Plate Gives Perfect Control When Baking.

"L" Water Fronts for Pressure Boilers.

Self Lighter Furnished on Any Style When Wanted.

When Ordering Use Code Words



CRESCENT DUAL OVEN COMBINATION RANGE

White Porcelain enameled finish—Polished Top

Number	Kind of Gas	Weight	Code
28-W	Manufactured	640	Abaca
38-W	Natural	650	Aback

Key to Style Letters Page 14

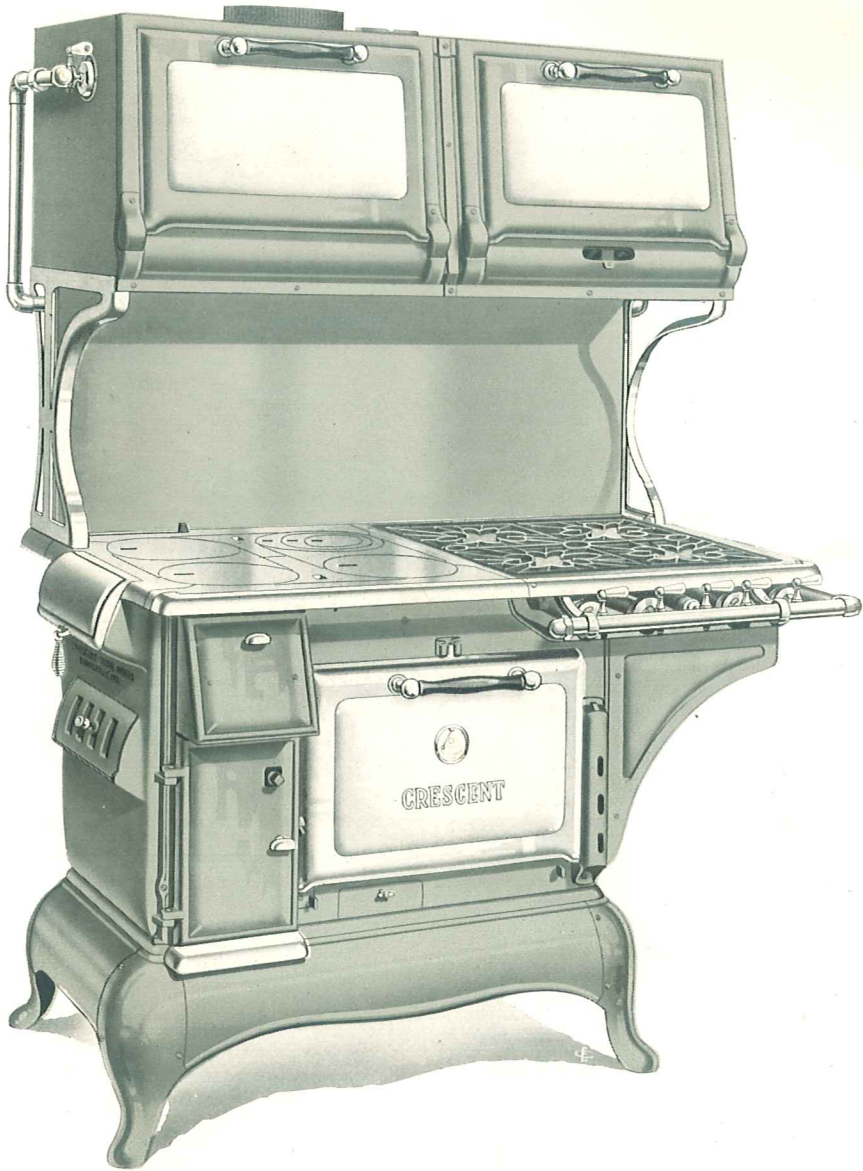

CRESCENT DUAL OVEN COMBINATION RANGE

Gray Porcelain enameled finish—Polished Top

Number	Kind of Gas	Weight	Code
28-G	Manufactured	640	Abaft
38-G	Natural	650	Abase

Description and Dimensions, Page 7



CRESCENT DUAL OVEN COMBINATION RANGE

Blue Porcelain enameled finish—Polished Top

Number	Kind of Gas	Weight	Code
28-B	Manufactured	Crated	Abash
38-B	Natural	640	Abate

When Ordering Use Code Words

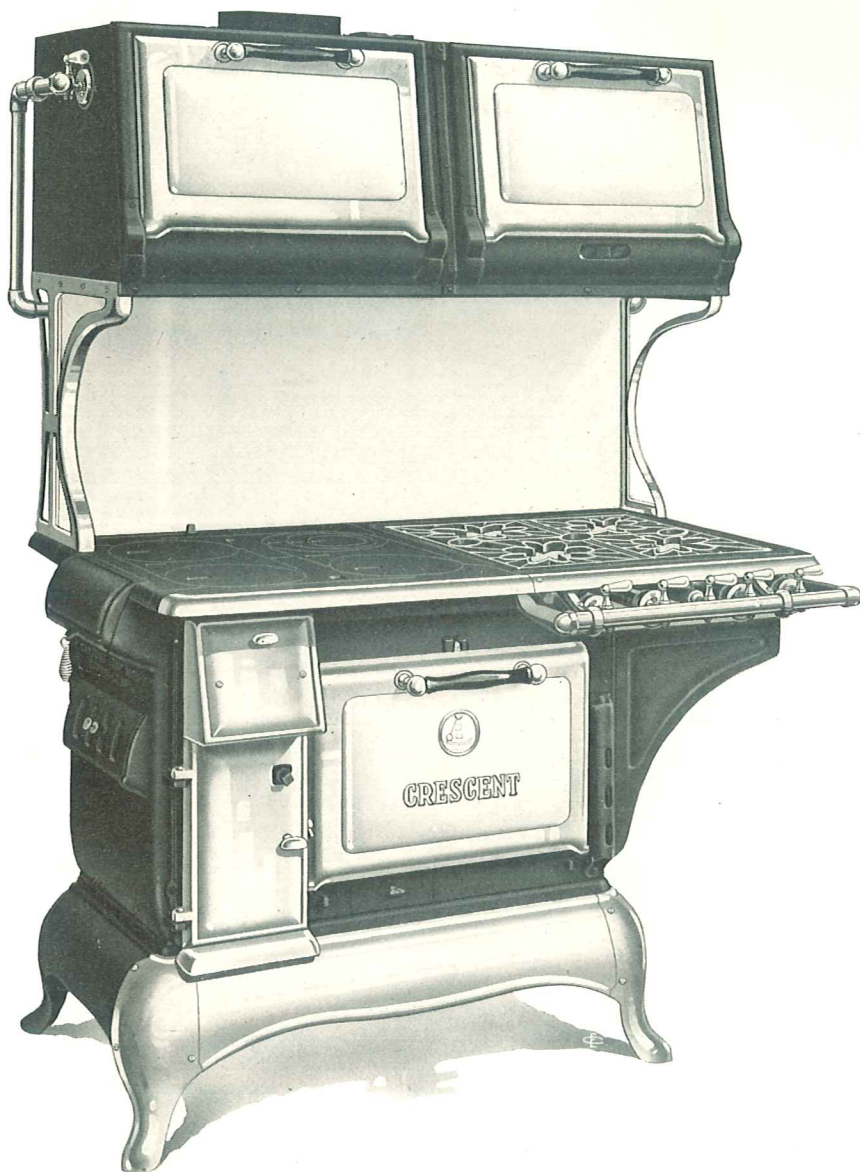

CRESCENT DUAL OVEN COMBINATION RANGE

Nickeled Trimmed, with enameled splasher

Number
28-N
38-N

Kind of Gas
Manufactured
Natural

Weight
Crated
630
640

Code
Abatis
Abator

Description and Dimensions, Page 7



CRESCENT DUAL OVEN COMBINATION RANGE

Plain finish with enameled splasher

Number	Kind of Gas	Weight Crated	Code
28-P	Manufactured	630	Abba
38-P	Natural	640	Abbacy

When Ordering Use Code Words



CRESCENT GAS RANGES

Elegantly Proportioned



Perfect in Operation

For Manufactured Gas or Natural Gas

FEATURES OF MERIT IN CRESCENT GAS RANGES

Crescent Center Heat Oven Burner—insures an equal distribution of heat and excellent for broiling. Gives three distinct heats.

Crescent Center Heat Top Burners—one piece cored casting.

Safety Open Door Oven Lighter—eliminating any possibility of explosion. Endorsed by American Museum of Safety.

Smooth Cooking Tops with removable grids—easy to clean, or a neatly designed open top grid.

Cast Iron fronts—insuring extra strength and close fitting doors.

Double wall construction—providing non-radiating air space.

Exterior parts—Wellsville Blue Polished Steel, or a very pleasing satin finish black enamel.

Enameled steel parts made entirely of "Armco" Ingot Iron.

Cast iron parts on plain ranges black enameled, satin finish.

Aluminized oven and broiler linings, electrically welded—can be easily removed for cleaning.

Non-Breakable Wire Oven Racks—two with every range.

Concealed oven and broiler door springs and hinges.

Enameled "Always Cool" wood oven and broiler door handles.

Adjustable gas cocks with porcelain handles.

Enameled dirt trays.

White enameled oven and broiler door panels.

White enameled broiler pan, with tinned rack.

Crescent Gas Ranges are distinctive in design, excellent in workmanship and material and reasonable in price. In fact, the entire Crescent line is designed, made and priced in exact accordance with the public demand.

Self-lighter can be attached to any style range desired.



STANDARD ABBREVIATIONS

For convenience and also to avoid errors in ordering, we give below the key to abbreviated style letters that are employed to different class, position of oven, finish and equipment. We recommend the use of these key letters, also code words when sending specifications.

Style Letters

- L Left Hand Oven
- R Right Hand Oven
- G Glass Panel Door
- T Thermostat
- C Canopy

Finish Letters

- P Plain
- E Enameled Splashers
- S Semi-Enameled
- W White Enameled
- G Gray Enameled
- B Blue Enameled

For Further Information See Description and Dimensions

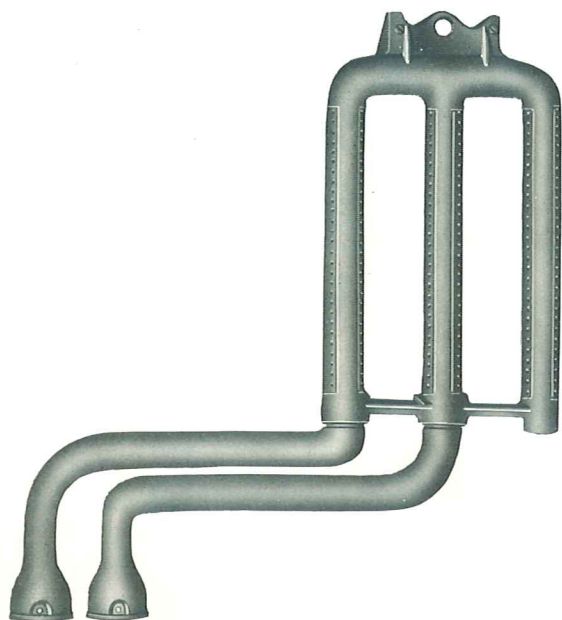

Crescent Center Heat Oven Burner

This type of burner is standard equipment on our 518 and 618 line of gas ranges only. This, without a doubt, is the best burner that has been devised for many years. It gives a uniform, evenly distributed heat, which is absolutely necessary in all gas range ovens. This burner is operated by two valves, from which can be obtained a low heat, a moderate heat, and an intense heat. It is the only type of oven burner that will give three stages of temperature without the use of an oven heat regulator.

At the right is shown the type of oven burner used on our 114, 116 and 118 line, also on the 314 and 316 line of gas ranges. This is a most efficient type of oven burner and gives the best of service. It is operated by one valve, feeding into a large mixing chamber, which assures perfect combustion of the gas before entering the oven burner.



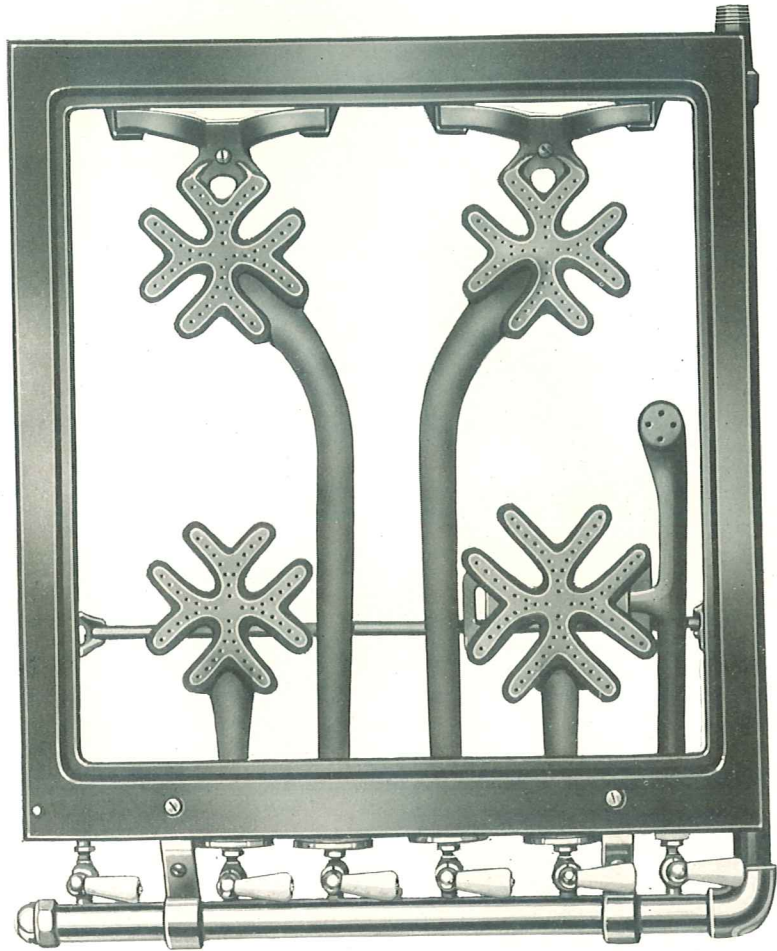

The above cut shows the location of the top burners, also the construction used in hanging the burners directly to the cooking top frame. Each burner is independent of the other, easily removed for cleaning.

We call special attention to the center heat top burners, as it is one of the most important features of our gas ranges. It is constructed to bring the heat directly under, and not to the sides of the cooking vessels, therefore, the smaller chance of waste. All CRESCENT GAS RANGES are equipped with center heat top burners.

HOW WE HAVE MET THE GROWING DEMAND FOR
OVEN HEAT REGULATION

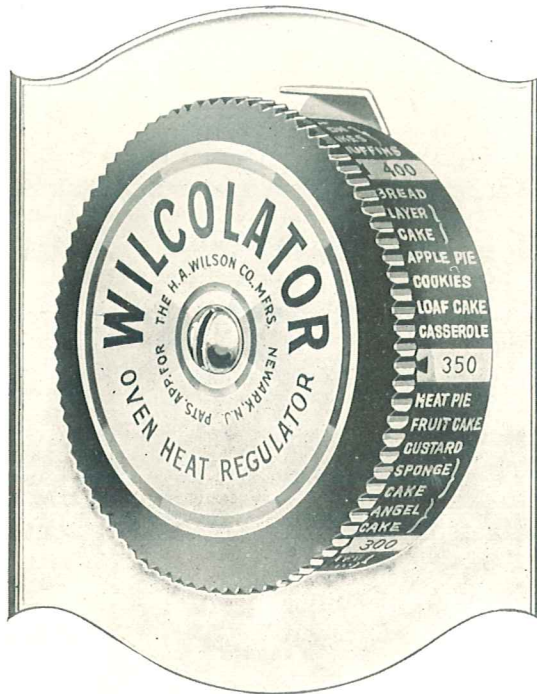

The interest in oven heat regulation has increased so rapidly that many careful observers find that it will be the outstanding feature in selling gas ranges during the future.

We want every **Crescent** dealer to know that we are prepared to stand behind him in this big forward movement.

Leading domestic science experts say that the oven heat regulator is the highest advance in scientific cooking that has been developed in years. Good Housekeeping Institute, known as an unquestioned authority in the field of kitchen science, after careful investigation, claims that, in a few years, no high-grade gas range will be sold without an oven heat regulator.

Leading gas appliance engineers also add their testimony to this belief.

It is important, therefore, that every **Crescent** dealer should know of this important development, and keep pace with it.

This great demand for oven heat regulation is not coming—**It Is Here Now!**

AND WHEN YOU OFFER CRESCENT GAS RANGES WITH THE WILCOLATOR REGULATOR YOU HAVE A TREMENDOUS SELLING ADVANTAGE.



WHY WE CHOSE THE WILCOLATOR

After careful investigation and rigid tests we chose the **Wilcolator** as the most dependable and accurate oven heat regulator obtainable.

Its accuracy and dependability were conclusively proved by our tests. Several years successful use by many housewives have added to this proof. That the **Wilcolator** will continue to completely satisfy its users is guaranteed by the fact that it is made by the best known manufacturer of thermostatic metals in the United States—the H. A. Wilson Company of Newark, N. J.

These facts determined the choice of the **Wilcolator** as a fit companion for the **Crescent Gas Range**. These facts will also help you in selling the last word in modern cooking equipment—the **New Concealed-Bolt and Hinge Type of Crescent Gas Range**, equipped with the **Wilcolator Oven Heat Regulator**.

WHAT THE WILCOLATOR WILL DO

Even the most inexperienced cook can get perfect results with the **Wilcolator** on her **Crescent Gas Range**. An easy turn of the dial and the last "guess" is taken out of cooking—the oven heat is accurately chosen and dependably maintained.

The **Wilcolator** gives the busy housewife many an hour away from the hot kitchen. While she is snatching a respite from her work, or engaged in other household duties the **Wilcolator** does her oven watching.

It is easy to use, as the cooking temperature chart is right on the dial—simply turn the dial to the food to be cooked. It is economical too, as in many cases it has cut 25% off the gas bills, and has saved many spoiled foods by its accurate control of the oven heat.

CRESCENT CABINET GAS RANGES



DIMENSIONS

AND EQUIPMENT

518 and 618 Line

Dimensions

- Baking Oven, 18" x 20" x 13".
- Broiling Oven, 18" x 20" x 9".
- Cooking Top and Shelf, 21 $\frac{1}{4}$ " x 27 $\frac{1}{2}$ ".
- Height to cooking top, 32 $\frac{1}{2}$ ".
- Height to high shelf, 47".
- Length with shelf, 49 $\frac{1}{2}$ ".
- Width of shelf, 3 $\frac{3}{4}$ ".
- Depth—including manifold and outlet, 26".

Equipment

- Three-line center heat oven burner, giving three distinct heats, operated by two valves on front manifold.
- Three center heat top burners, one giant burner, one simmer burner.
- Adjustable gas cocks with porcelain handles.
- Safety open door oven lighter.
- Three-fourths inch nickeled manifold pipe.
- Four inch flue collar.
- Cast iron front and doors.
- Double wall construction—providing non-radiating air space.
- Aluminized oven and broiler linings, electrically welded—can be easily removed for cleaning.
- Non-Breakable wire oven racks; two with every range.
- Concealed oven and broiler door hinges and springs.
- White door handles on enameled ranges.
- Enameled black "Always Cool" wood door handles on plain ranges.
- White enameled dirt tray.
- White enameled broiler pan, with tinned rack.
- Right or left oven styles.

When Ordering Use Code Words



CRESCENT CABINET GAS RANGES

SANITARY



ECONOMICAL

THE DIFFERENT STYLES AND NUMBERS OF 518 AND 618 LINE

No.	Kind of Gas	Oven	Crated Weight	Code
White Enamel Finish				
518-WL	Manufactured	18 x 20 x 13	300	Aryan
518-WR	Manufactured	18 x 20 x 13	300	Ascus
618-WL	Natural	18 x 20 x 13	310	Ash
618-WR	Natural	18 x 20 x 13	310	Ashen
Gray Enamel Finish				
518-GL	Manufactured	18 x 20 x 13	300	Aside
518-GR	Manufactured	18 x 20 x 13	300	Ashlar
618-GL	Natural	18 x 20 x 13	310	Aspect
618-GR	Natural	18 x 20 x 13	310	Asper
Blue Enamel Finish				
518-BL	Manufactured	18 x 20 x 13	300	Aspic
518-BR	Manufactured	18 x 20 x 13	300	Aspire
618-BL	Natural	18 x 20 x 13	310	Asquint
618-BR	Natural	18 x 20 x 13	310	Assay
Semi Enamel Trimmed				
518-SL	Manufactured	18 x 20 x 13	295	Asset
518-SR	Manufactured	18 x 20 x 13	295	Assign
618-SL	Natural	18 x 20 x 13	305	Assist
618-SR	Natural	18 x 20 x 13	305	Assoil
Plain, with Enameled Splashes				
518-EL	Manufactured	18 x 20 x 13	295	Assort
518-ER	Manufactured	18 x 20 x 13	295	Assure
618-EL	Natural	18 x 20 x 13	305	Aster
618-ER	Natural	18 x 20 x 13	305	Astern
Plain Style				
518-PL	Manufactured	18 x 20 x 13	295	Astir
518-PR	Manufactured	18 x 20 x 13	295	Astral
618-PL	Natural	18 x 20 x 13	305	Astray
618-PR	Natural	18 x 20 x 13	305	Astrict

The following Extras can be Furnished on any style. For Prices see Current Price List.

RUTZ-PUSH BUTTON LIGHTER.

"WILCO" OVEN HEAT REGULATOR.

GLASS DOOR—(2 PANELS).

ENAMELED FOOT RESTS.

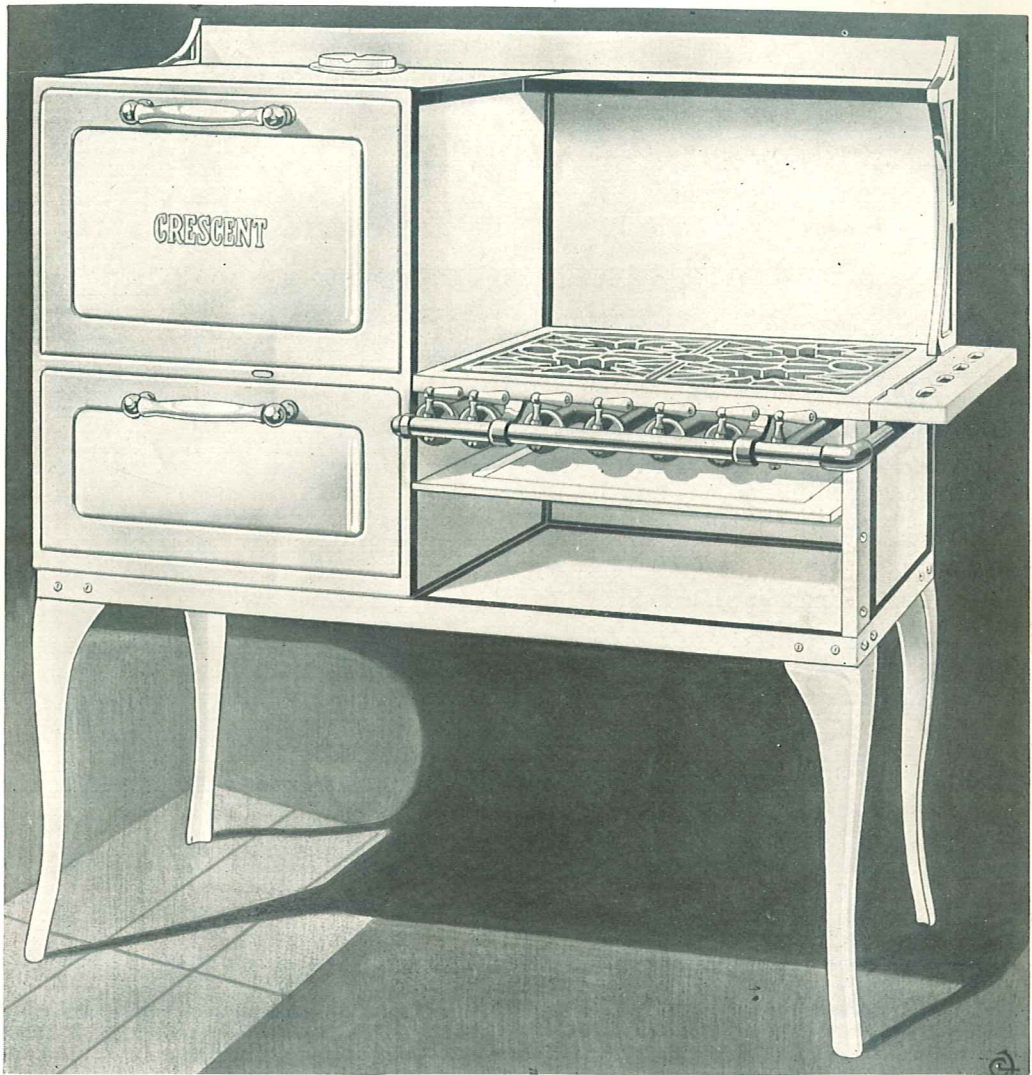

This picture illustrates the clean-cut lines built into the 518 and 618 Line of Cabinet Gas Ranges. It can be furnished in any of the styles listed on the opposite page.

"L" oven at left; "R" oven at right. Specify on which side oven is wanted.

Description and Dimensions, Pages 19 and 20

CRESCENT CABINET GAS RANGES



DIMENSIONS

EQUIPMENT

114, 214, 116, 216, 118 AND 218 LINES

Dimensions

Baking oven, 14", 16" or 18" x 20" x 13".
 Broiling oven, 14", 16" or 18" x 20" x 9".
 Cooking top and shelf, 21 $\frac{1}{4}$ " x 24".
 Height to cooking top, 32 $\frac{1}{2}$ ".
 Height to high shelf, 47".
 Length with shelf, 114 and 214, 42".
 Length with shelf, 116 and 216, 44".
 Length with shelf, 118 and 218, 46".
 Width of shelf, 3 $\frac{3}{4}$ ".
 Depth—including manifold and outlet, 26".

Equipment

Large two line oven burner.
 Three center heat top burners, one giant burner, and one simmer burner.
 Adjustable gas cocks with porcelain handles.
 Safety open door oven lighter.
 Three-fourths inch nicked manifold pipe.
 Four inch flue collar.
 Cast iron fronts and doors.
 Double wall construction—providing non-radiating air space.
 Aluminized oven and broiler linings, electrically welded—can be easily removed for cleaning.
 Non-breakable wire oven racks; two with every range.
 Concealed oven and broiler door hinges and springs.
 White door handles on enameled ranges.
 Enameled black "Always Cool" wood door handles on plain ranges.
 White enameled dirt tray.
 White enameled broiler pan with tinned rack.
 Right or left oven styles.
 The following extras can be furnished on this line. For prices see current price list.

RUTZ-PUSH BUTTON LIGHTER.
 "WILCO" OVEN HEAT REGULATOR.
 GLASS DOOR—TWO PANELS.
 ENAMELED FOOT RESTS.

When Ordering Use Code Words

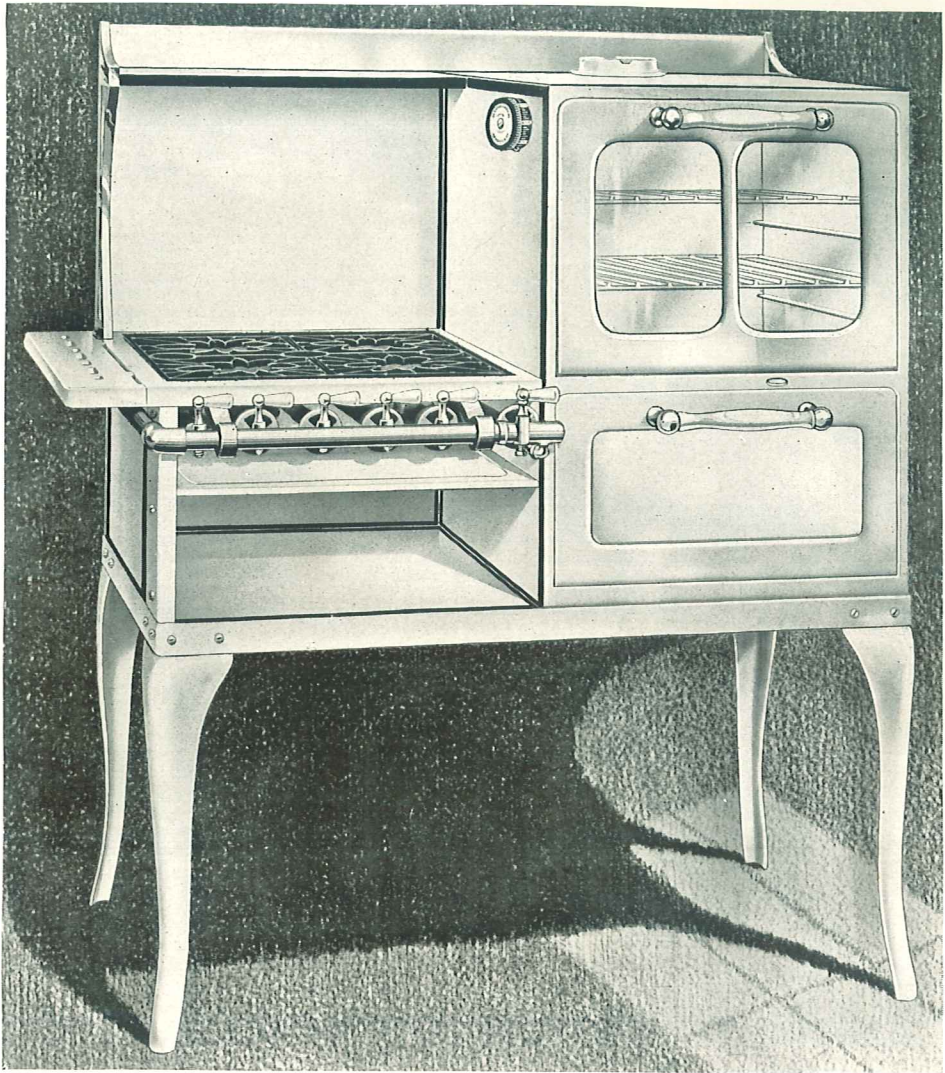

This picture illustrates one of our many styles of cabinet ranges, equipped with a "Wilco" Oven Heat Regulator (Thermostat). We invite special attention to it's convenient location, it's neatness and simplicity—the cooking chart and dial only being exposed. EVERY STYLE OF OUR 518, 618 AND 114, 214, 116, 216, 118, 218 CABINET RANGES CAN BE EQUIPPED WITH A THERMOSTAT.

GLASS DOOR—TWO PANEL—As shown can be furnished on any style of our 114, 214, 116, 216, 118 and 218 line, also on the 518 and 618 line of cabinet gas ranges.

A GLASS DOOR AND THE CONCEALED TYPE OF "WILCO" HEAT REGULATOR ADD THE FINAL TOUCH OF PERFECTION TO THE CRESCENT GAS RANGE. THEY ARE GREAT SELLING FEATURES.

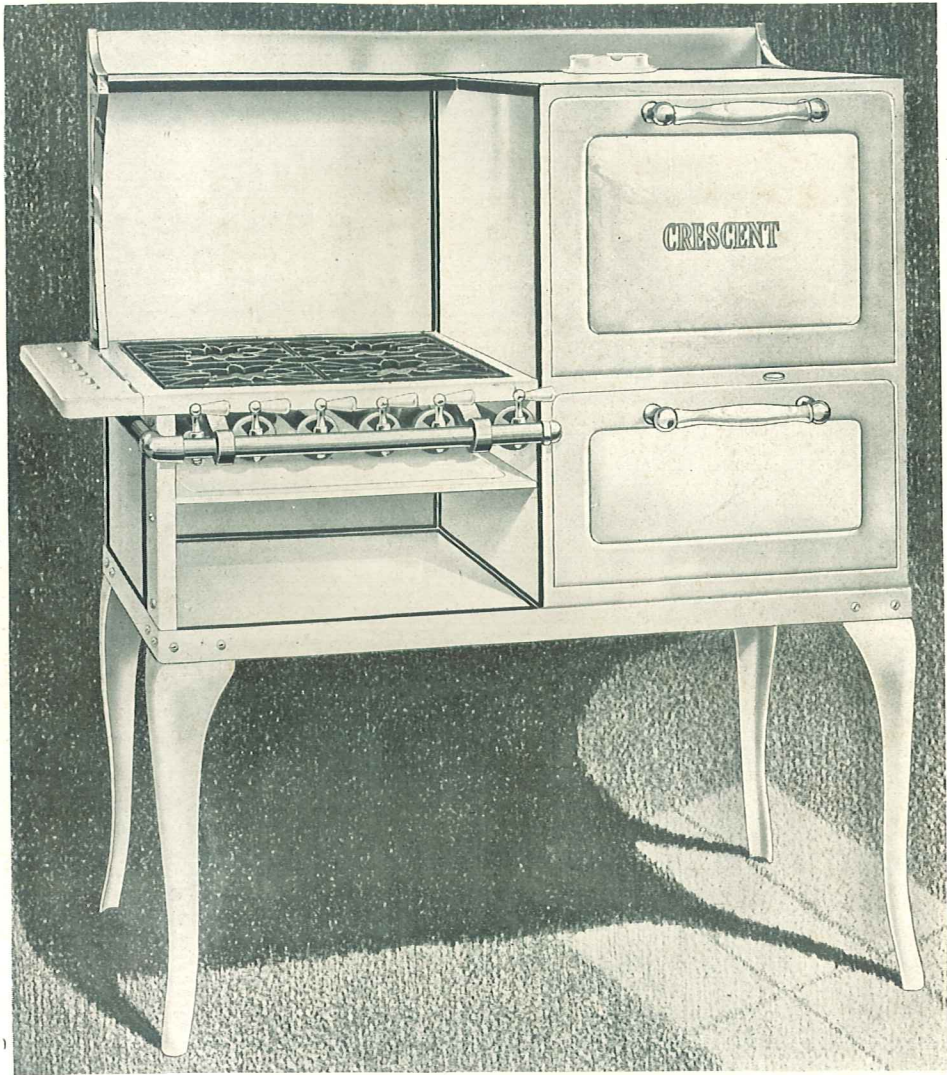

CRESCENT PORCELAIN ENAMELED GAS RANGE
White Enamel Finish

No.	Kind of Gas	Oven	Crated Weight	Code
114-WL	Manufactured	14 x 20 x 13	240	Acre
114-WR	Manufactured	14 x 20 x 13	240	Acrid
214-WL	Natural	14 x 20 x 13	250	Across
214-WR	Natural	14 x 20 x 13	250	Action
116-WL	Manufactured	16 x 20 x 13	250	Abrupt
116-WR	Manufactured	16 x 20 x 13	250	Absent
216-WL	Natural	16 x 20 x 13	260	Absorb
216-WR	Natural	16 x 20 x 13	260	Abstain
118-WL	Manufactured	18 x 20 x 13	260	Abess
118-WR	Manufactured	18 x 20 x 13	260	Abbey
218-WL	Natural	18 x 20 x 13	270	Abbot
218-WR	Natural	18 x 20 x 13	270	Abduce

“L” oven at left; “R” oven at right. Specify on which side oven is wanted.

Description and Dimensions, Page 22

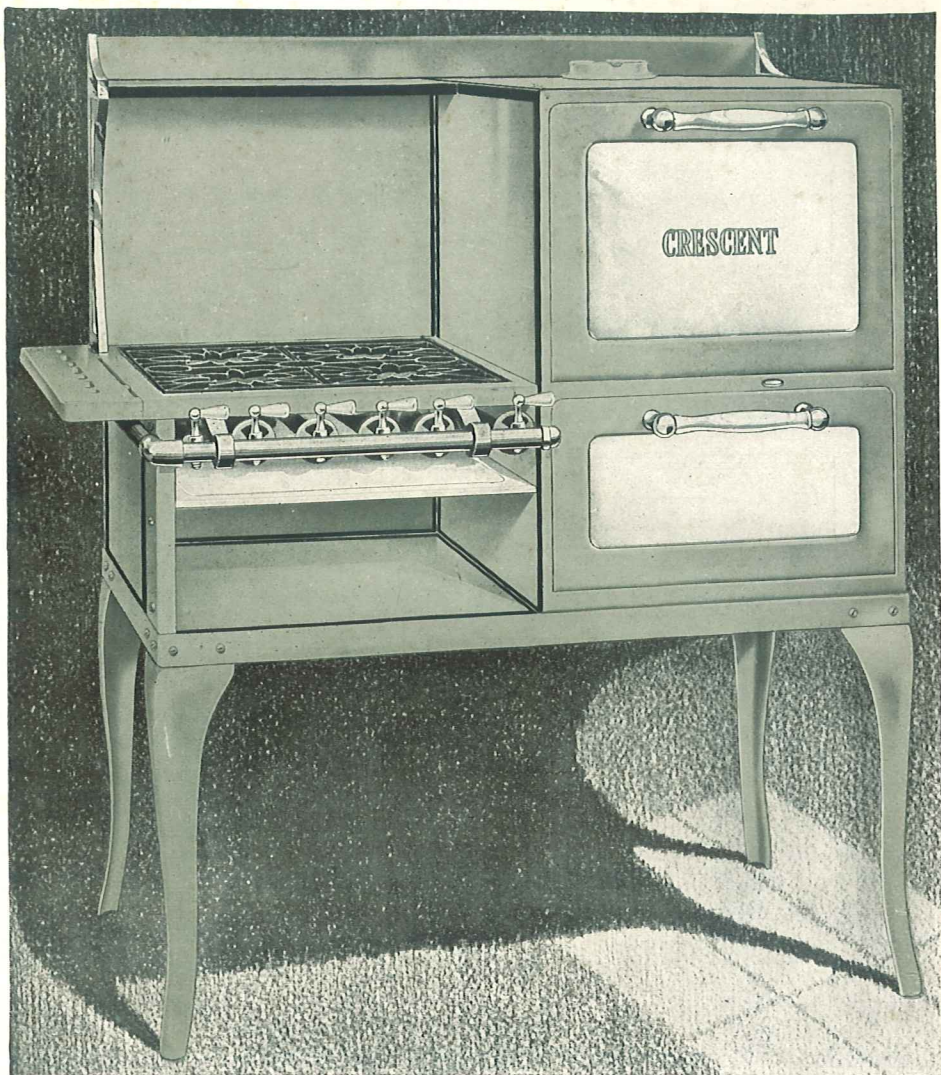

CRESCENT PORCELAIN ENAMELED GAS RANGE

Gray Enamel Finish

No.	Kind of Gas	Oven	Crated Weight	Code
114-GL	Manufactured	14 x 20 x 13	240	Active
114-GR	Manufactured	14 x 20 x 13	240	Actor
214-GL	Natural	14 x 20 x 13	250	Actress
214-GR	Natural	14 x 20 x 13	250	Actuate
116-GL	Manufactured	16 x 20 x 13	250	Abstract
116-GR	Manufactured	16 x 20 x 13	250	Abstruse
216-GL	Natural	16 x 20 x 13	260	Absurd
216-GR	Natural	16 x 20 x 13	260	Abuse
118-GL	Manufactured	18 x 20 x 13	260	Abduct
118-GR	Manufactured	18 x 20 x 13	260	Abeam
218-GL	Natural	18 x 20 x 13	270	Abear
218-GR	Natural	18 x 20 x 13	270	Abed

"R" oven at right; "L" oven at left. Specify on which side oven is wanted.

Key to Style Letters, Page 14



CRESCENT PORCELAIN ENAMELED GAS RANGE

Blue Enamel Finish

No.	Kind of Gas	Oven	Crated Weight	Code
114-BL	Manufactured	14 x 20 x 13	240	Acute
114-BR	Manufactured	14 x 20 x 13	240	Adage
214-BL	Natural	14 x 20 x 13	250	Adam
214-BR	Natural	14 x 20 x 13	250	Adapt
116-BL	Manufactured	16 x 20 x 13	250	Abyss
116-BR	Manufactured	16 x 20 x 13	250	Accept
216-BL	Natural	16 x 20 x 13	260	Access
216-BR	Natural	16 x 20 x 13	260	Accord
118-BL	Manufactured	18 x 20 x 13	260	Abel
118-BR	Manufactured	18 x 20 x 13	260	Abhor
218-BL	Natural	18 x 20 x 13	270	Abide
218-BR	Natural	18 x 20 x 13	270	Abject

"L" oven at left; "R" oven at right. Specify on which side oven is wanted.

When Ordering Use Code Words

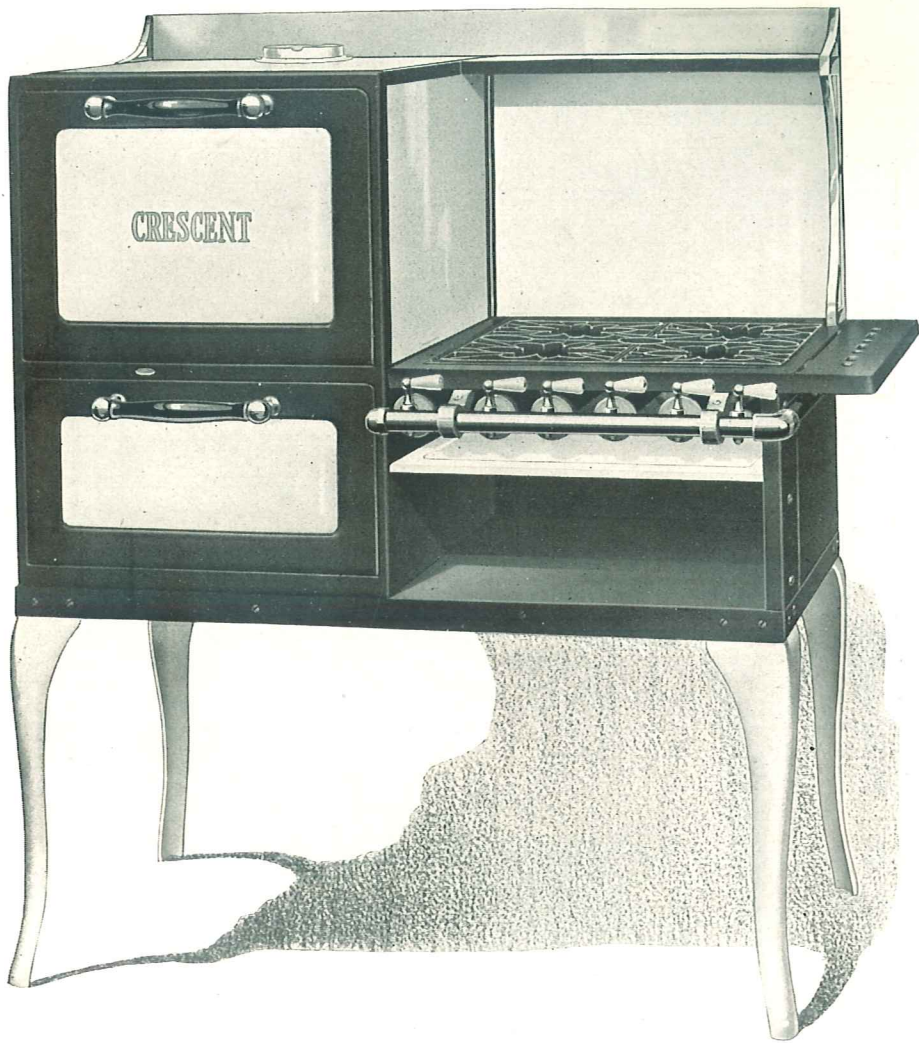

CRESCENT GAS RANGE

Semi-Enameled Trimmed

No.	Kind of Gas	Oven	Crated Weight	Code
114-SL	Manufactured	14 x 20 x 13	235	Adar
114-SR	Manufactured	14 x 20 x 13	235	Add
214-SL	Natural	14 x 20 x 13	245	Addax
214-SR	Natural	14 x 20 x 13	245	Addict
116-SL	Manufactured	16 x 20 x 13	245	Accost
116-SR	Manufactured	16 x 20 x 13	245	Accrete
216-SL	Natural	16 x 20 x 13	255	Accrue
216-SR	Natural	16 x 20 x 13	255	Accuse
118-SL	Manufactured	18 x 20 x 13	255	Abjure
118-SR	Manufactured	18 x 20 x 13	255	Ablaut
218-SL	Natural	18 x 20 x 13	265	Ablaze
218-SR	Natural	18 x 20 x 13	265	Able

“L” oven at left; “R” oven at right. Specify on which side oven is wanted.

Description and Dimensions, Page 22



CRESCENT GAS RANGE

Plain, with Enameled Splashes

No.	Kind of Gas	Oven	Crated Weight	Code
114-EL	Manufactured	14 x 20 x 13	235	Addle
114-ER	Manufactured	14 x 20 x 13	235	Address
214-EL	Natural	14 x 20 x 13	245	Adduce
214-ER	Natural	14 x 20 x 13	245	Adduct
116-EL	Manufactured	16 x 20 x 13	245	Acerb
116-ER	Manufactured	16 x 20 x 13	245	Acetic
216-EL	Natural	16 x 20 x 13	255	Achene
216-ER	Natural	16 x 20 x 13	255	Aboard
118-EL	Manufactured	18 x 20 x 13	255	Abode
118-ER	Manufactured	18 x 20 x 13	255	About
218-EL	Natural	18 x 20 x 13	265	About
218-ER	Natural	18 x 20 x 13	265	Above

"L" oven at left; "R" oven at right. Specify on which side oven is wanted.

When Ordering Use Code Words



CRESCENT GAS RANGE

Plain Style

No.	Kind of Gas	Oven	Crated Weight	Code
114-PL	Manufactured	14 x 20 x 13	235	Adeem
114-PR	Manufactured	14 x 20 x 13	235	Adhere
214-PL	Natural	14 x 20 x 13	245	Adieu
214-PR	Natural	14 x 20 x 13	245	Adios
116-PL	Manufactured	16 x 20 x 13	245	Acid
116-PR	Manufactured	16 x 20 x 13	245	Acme
216-PL	Natural	16 x 20 x 13	255	Acorn
216-PR	Natural	16 x 20 x 13	255	Acquit
118-PL	Manufactured	18 x 20 x 13	255	Abraide
118-PR	Manufactured	18 x 20 x 13	255	Abreast
218-PL	Natural	18 x 20 x 13	265	Abridge
218-PR	Natural	18 x 20 x 13	265	Abroach

“R” oven at right; “L” oven at left. Specify on which side oven is wanted.

Key to Style Letters, Page 14

CRESCENT CABINET GAS RANGES

DIMENSIONS



EQUIPMENT

714, 814, 716 AND 816 LINES

Dimensions

Baking oven, 14" and 16" x 20" x 12".

Broiling oven, 14" and 16" x 20" x 8".

Cooking top and shelf, 21 $\frac{1}{4}$ " x 23".

Height to cooking top, 33 $\frac{1}{2}$ ".

Height to high shelf, 47".

Length with shelf, 714 and 814, 40".

Length with shelf 716 and 816, 42".

Width of shelf 3".

Depth including manifold and outlet 26"

Equipment

Large two line oven burner.

Three center heat top burners, one giant burner.

Adjustable gas cocks with porcelain handles.

Safety open door oven lighter.

Three-fourths inch nicked manifold pipe.

Four inch flue collar.

Cast iron fronts and doors.

Double wall construction—providing non-radiating air space.

Aluminized oven and broiler linings, electrically welded—can be easily removed for cleaning.

Non-breakable wire oven racks; two with every range.

Concealed oven and broiler door hinges and springs.

White door handles on enameled ranges.

Enameled black "Always Cool" wood door handles on plain ranges.

All plain and splasher style ranges have black enameled broiler pans and dirt trays.

Semi-enameled and enameled styles have white enameled broiler pans and dirt trays.

Tinned broiler rack furnished with all broiler pans.

Right or left oven styles.

The following extras can be furnished on this line. For prices see current price list.

RUTZ-PUSH BUTTON LIGHTER.

ENAMELED FOOT RESTS.

When Ordering Use Code Words

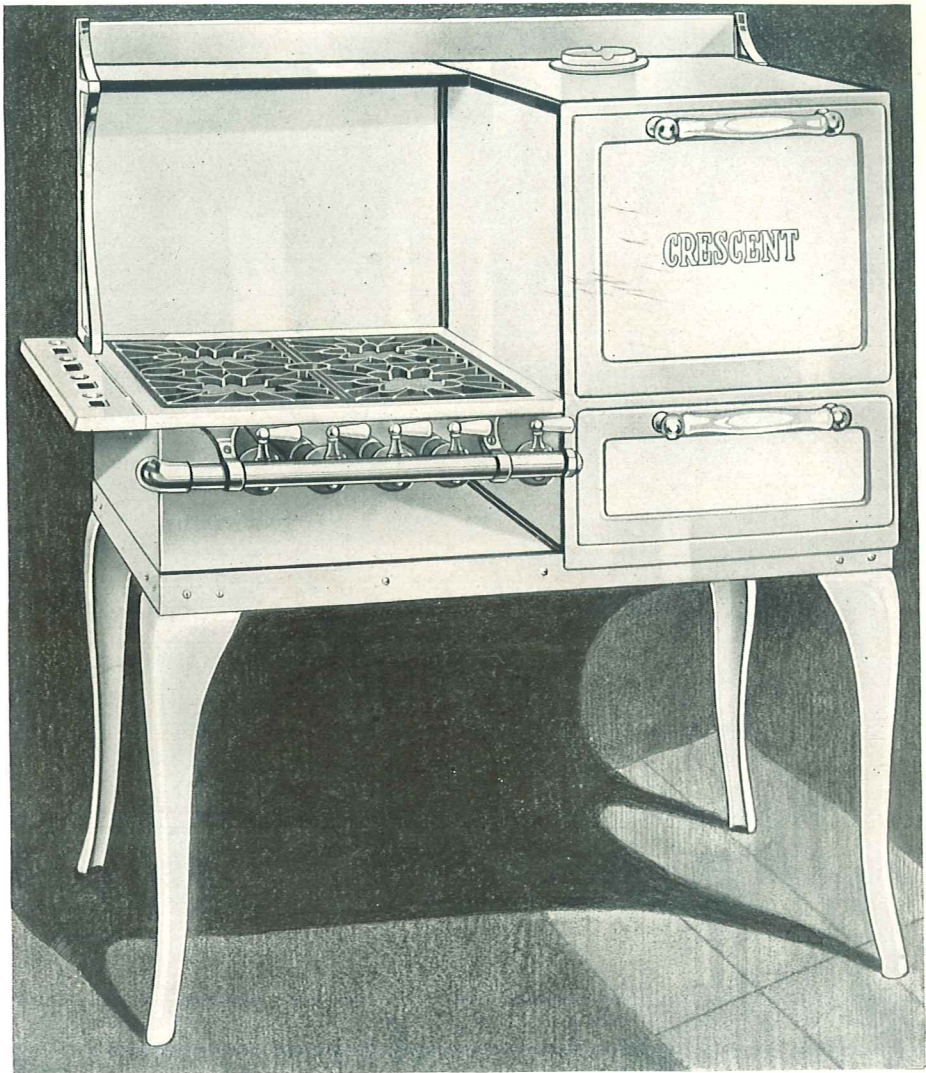

CRESCENT PORCELAIN ENAMELED GAS RANGE

White Enamel Finish

Number	Kind of Gas	Oven	Crated Weight	Code
714-WL	Manufactured	14 x 20 x 12	170	Attorn
714-WR	Manufactured	14 x 20 x 12	170	Attune
814-WL	Natural	14 x 20 x 12	180	Audit
814-WR	Natural	41 x 20 x 12	180	Auger
716-WL	Manufactured	16 x 20 x 12	175	Atilt
716-WR	Manufactured	16 x 20 x 12	175	Ation
816-WL	Natural	16 x 20 x 12	185	Ative
816-WR	Natural	16 x 20 x 12	185	Atlas

“L” oven at left; “R” oven at right. Specify on which side oven is wanted.

Description and Dimensions, Page 30

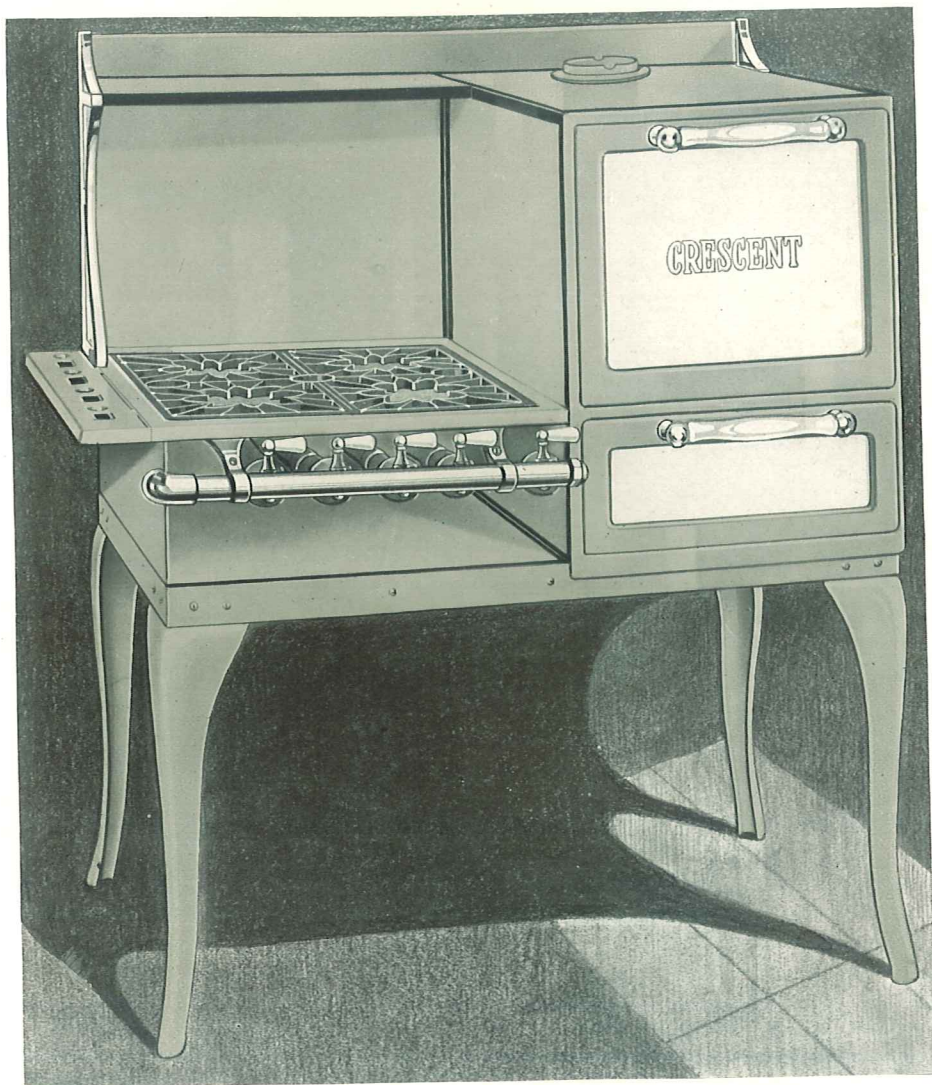

CRESCENT PORCELAIN ENAMELED GAS RANGE

Gray Enamel Finish

Number	Kind of Gas	Oven	Crated Weight	Code
714-GL	Manufactured	14 x 20 x 12	170	Aught
714-GR	Manufactured	14 x 20 x 12	170	Aulic
814-GL	Natural	14 x 20 x 12	180	Aunt
814-GR	Natural	14 x 20 x 12	180	Aura
716-GL	Manufactured	16 x 20 x 12	175	Atli
716-GR	Manufactured	16 x 20 x 12	175	Atman
816-GL	Natural	16 x 20 x 12	185	Atoll
816-GR	Natural	16 x 20 x 12	185	Atom

"R" oven at right; "L" oven at left. Specify on which side oven is wanted.

Key to Style Letters, Page 14

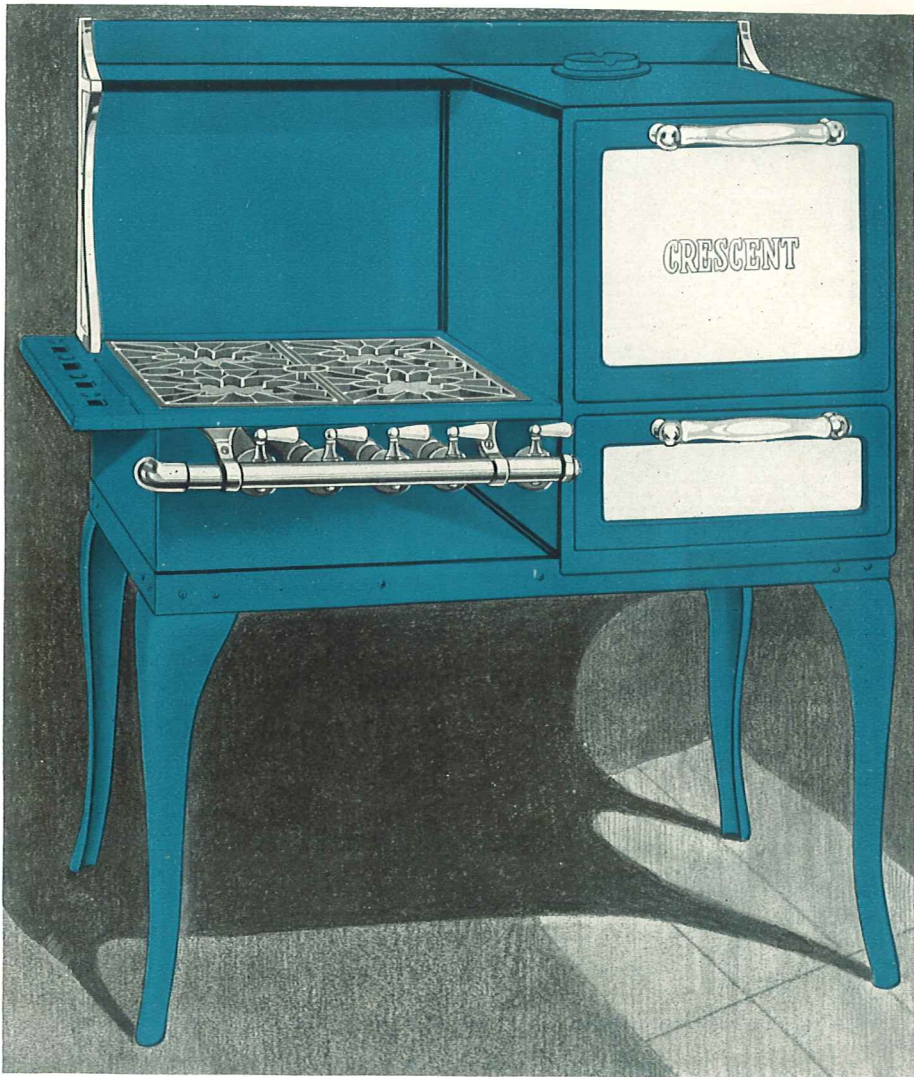

CRESCENT PORCELAIN ENAMELED GAS RANGE

Blue Enamel Finish

Number	Kind of Gas	Oven	Crated Weight	Code
714-BL	Manufactured	14 x 20 x 12	170	Auto
714-BR	Manufactured	14 x 20 x 12	170	Avail
814-BL	Natural	14 x 20 x 12	180	Avast
814-BR	Natural	14 x 20 x 12	180	Avant
716-BL	Manufactured	16 x 20 x 12	175	Atone
716-BR	Manufactured	16 x 20 x 12	175	Atony
816-BL	Natural	16 x 20 x 12	185	Atrip
816-BR	Natural	16 x 20 x 12	185	Attach

“L” oven at left; “R” oven at right. Specify on which side oven is wanted.

When Ordering Use Code Words



CRESCENT SEMI-ENAMELED GAS RANGE

Semi-Enameled Trimmed

Number	Kind of Gas	Oven	Crated Weight	Code
714-SL	Manufactured	14 x 20 x 12	165	Avens
714-SR	Manufactured	14 x 20 x 12	165	Aver
814-SL	Natural	14 x 20 x 12	175	Avid
814-SR	Natural	14 x 20 x 12	175	Aviso
716-SL	Manufactured	16 x 20 x 12	170	Attain
716-SR	Manufactured	16 x 20 x 12	170	Attar
816-SL	Natural	16 x 20 x 12	180	Attic
816-SR	Natural	16 x 20 x 12	180	Attire

"L" oven at left; "R" oven at right. Specify on which side oven is wanted.

Description and Dimensions, Page 30

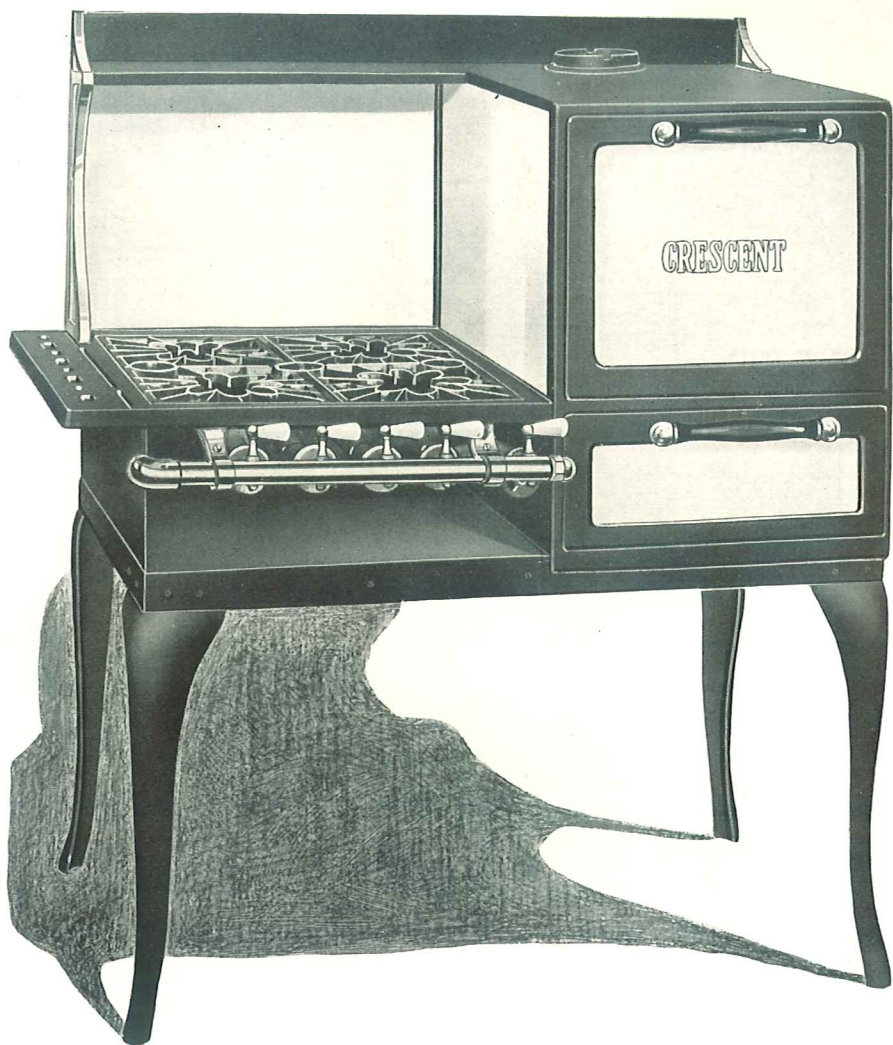

CRESCENT GAS RANGE

Plain, with Enameled Splashers

Number	Kind of Gas	Oven	Crated Weight	Code
714-EL	Manufactured	14 x 20 x 12	155	Adore
714-ER	Manufactured	14 x 20 x 12	155	Adrift
814-EL	Natural	14 x 20 x 12	165	Adroit
814-ER	Natural	14 x 20 x 12	165	Adult
716-EL	Manufactured	16 x 20 x 12	160	Adit
716-ER	Manufactured	16 x 20 x 12	160	Adjoin
816-EL	Natural	16 x 20 x 12	170	Adjust
816-ER	Natural	16 x 20 x 12	170	Admire

"L" oven at left; "R" oven at right. Specify on which side oven is wanted.

When Ordering Use Code Words

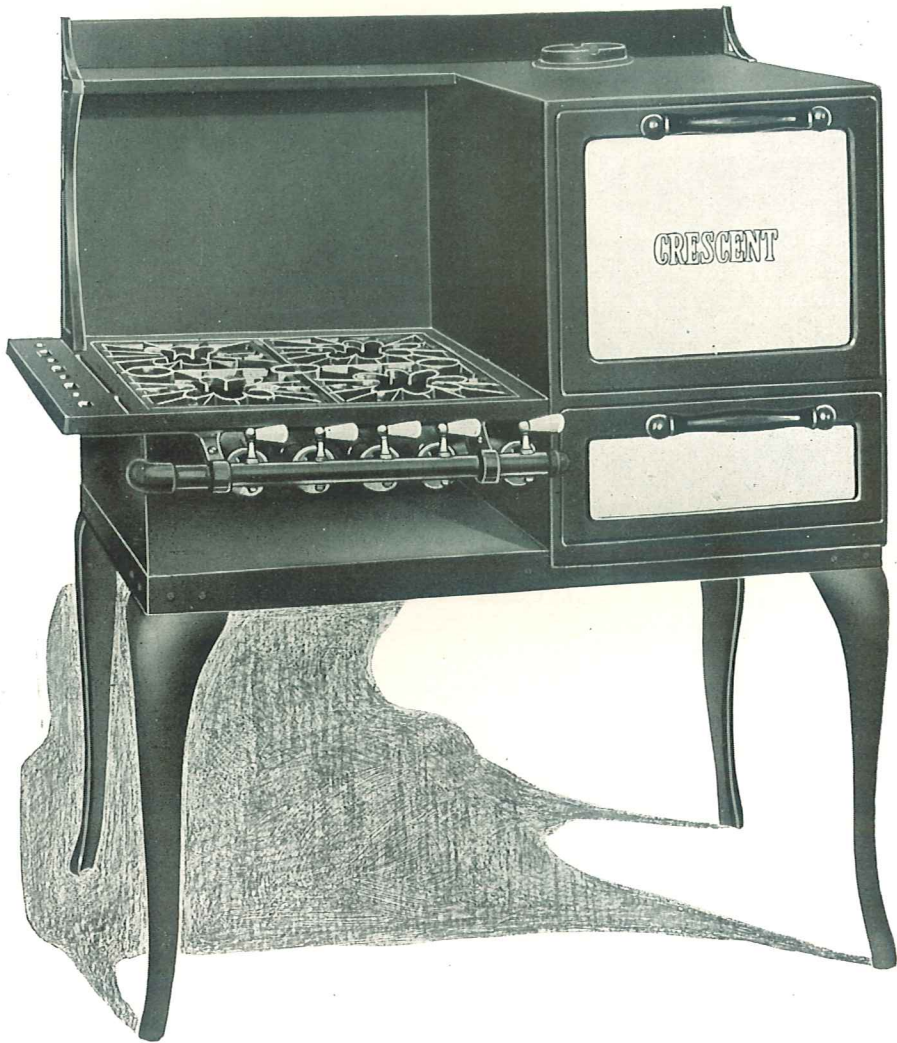

CRESCENT GAS RANGE

Plain Style

Number	Kind of Gas	Oven	Crated Weight	Code
714-PL	Manufactured	14 x 20 x 12	155	Advance
714-PR	Manufactured	14 x 20 x 12	155	Advent
814-PL	Natural	14 x 20 x 12	165	Adverb
814-PR	Natural	14 x 20 x 12	165	Adverse
716-PL	Manufactured	16 x 20 x 12	160	Admit
716-PR	Manufactured	16 x 20 x 12	160	Adnate
816-PL	Natural	16 x 20 x 12	170	Adobe
816-PR	Natural	16 x 20 x 12	170	Adopt

"R" oven at right; "L" oven at left. Specify on which side oven is wanted.

Key to Style Letters, Page 14



CRESCENT SINGLE AND DOUBLE OVEN GAS RANGES

DIMENSIONS



AND EQUIPMENT

18 and 20 SERIES

Baking Oven	Broiling Oven	Cooking Top Less Shelves	Height to Cooking Top	Floor Space
18 x 18 x 12	18 x 18 x 6	22½ x 30½	35 inches	24 x 23

Equipment

Four center heat top burners. Four flame oven burner, operated by one valve. Adjustable gas cocks with porcelain handles. Safety open door oven lighter. White enameled dirt tray, broiler pan and oven door panel. All cast iron parts black enameled. Polished blue steel body or satin finish black enameled. Asbestos lined oven and bottom. Cast iron oven runs. Two wire oven racks. Three-fourths inch manifold pipe. Four inch flue collar.

When Ordering Use Code Words



CRESCENT DOUBLE OVEN GAS RANGE

Number	Kind of Gas	Oven	Crated Weight	Code
18-B	Manufactured	18 x 18 x 12	180	Afar
20-B	Natural	18 x 18 x 12	190	Affair

Description and Dimensions, Page 37

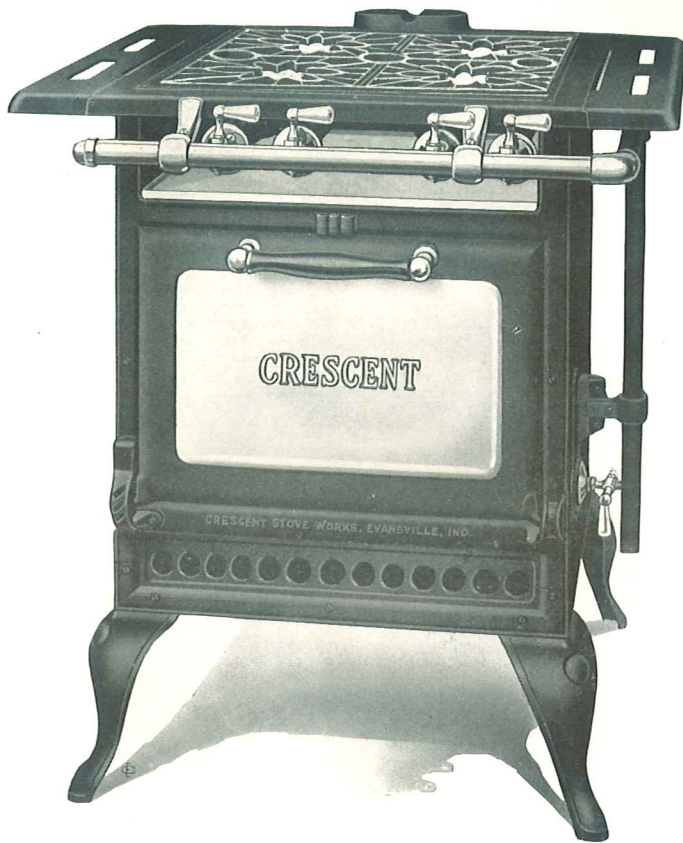

CRESCENT SINGLE OVEN GAS RANGE

Number	Kind of Gas	Oven	Crated Weight	Code
18-S	Manufactured	18 x 18 x 12	170	Affect
20-S	Natural	18 x 18 x 12	180	Affiant

Description and Dimensions, Page 37



CRESCENT GAS COOKER

For Manufactured or Natural Gas
With Enameled High Shelf

	Regular		
Number	Oven	Crated Weight	Code
26	16 x 11½ x 12	130	Avoid
	With Broiler		
36	16 x 11½ x 12	140	Awake
	Description and Dimensions		
Baking Oven	Broiling Oven	Cooking Top	Height to Cooking Top
16 x 11½ x 12	16 x 11½ x 12	28½ x 13	32 inches

Equipment

Three center heat top burners. Adjustable gas cocks with porcelain handles. White enameled door panel. Enameled dirt tray. Cast iron parts black enameled. Polished blue steel body or satin finish black enameled. Bottom asbestos lined. Five inch flue collar. Three-fourths inch manifold pipe. Removable linings. Broiler pan and rack.



CRESCENT GAS COOKER

For Manufactured or Natural Gas
With Plain High Shelf

	Regular		
Number	Oven	Crated Weight	Code
26	16 x 11½ x 12	130	Avow
	With Broiler		
36	16 x 11½ x 12	140	Await
	Description and Dimensions		
Baking Oven	Broiling Oven	Cooking Top	Height to Cooking Top
16 x 11½ x 12	16 x 11½ x 12	28½ x 13	32 inches

Equipment

Three center heat top burners. Adjustable gas cocks with porcelain handles. White enameled door panel. Enameled dirt tray. Cast iron parts black enameled. Polished blue steel body or satin finish black enameled. Bottom asbestos lined. Five inch flue collar. Three-fourths inch manifold pipe. Removable linings. Broiler pan and rack.



CRESCENT GAS COOKER

For Manufactured or Natural Gas

Regular

Number	Oven	Crated Weight	Code
26	16 x 11½ x 12	105	Affirm

With Broiler

36	16 x 11½ x 12	115	Affix
----	---------------	-----	-------

Description and Dimensions

Baking Oven	Broiling Oven	Cooking Top	Height to Cooking Top
16 x 11½ x 12	16 x 11½ x 12	28½ x 13	32 inches

Equipment

Three center heat top burners. Adjustable gas cocks with porcelain handles. White enameled door panel. Enameled dirt tray. Cast iron parts black enameled. Polished blue steel body or satin finish black enameled. Bottom asbestos lined. Five inch flue collar. Three-fourths inch manifold pipe. Removable linings. Broiler pan and rack.

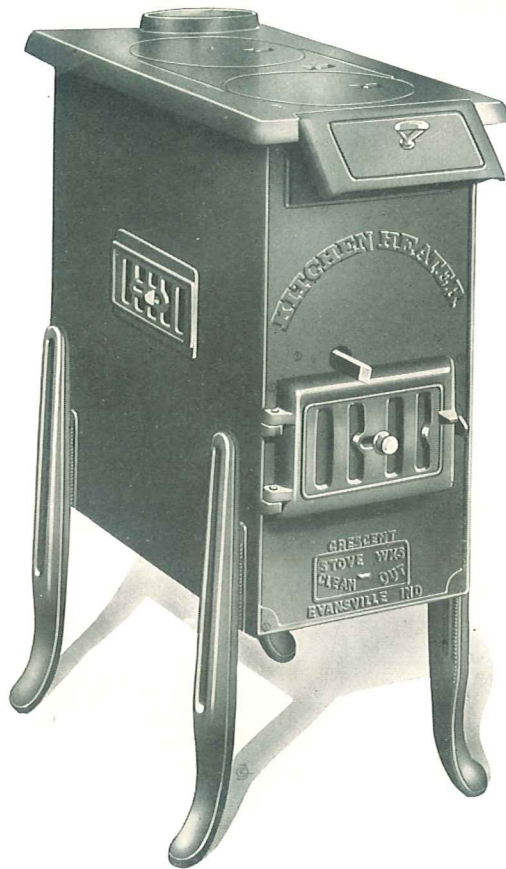

KITCHEN HEATER

For hard or soft coal, and wood

Number	Fire Box	Size of Top	Net Weight	Collar	Code
8	16½ x 8	18 x 24	115	5-inch	Aflct

Has two 8-inch covers, duplex grates, cast iron legs, which can be adjusted to any height. Polished blue steel body. Large ash pan, with bail. Sets on either side of gas range. Water back furnished when wanted.



CRESCENT CAST IRON RANGES

FOR HARD OR SOFT COAL



COKE OR WOOD

SPECIAL FEATURES AND DETAILS OF CONSTRUCTION

- White enameled oven door panels, cushion type.
- White enameled high closet door panels, cushion type.
- White enameled splasher backs on high closets.
- Sanitary high closets, pipe in rear of closet, making full space of closet available.
- Sliding direct draft dampers in all ranges, give perfect control when baking.
- Detachable encased copper contact reservoirs.
- All cast iron base strips, and cast high closet brackets.
- Perfectly balanced oven doors, with adjustable oil-tempered steel spring.
- Oven doors steel lined.
- Enameled "Always Cool" wood oven door handles.
- Easy rolling duplex grates for coal or wood.
- Heavy covers and centers, strongly ribbed.
- Double fire linings, properly ventilated.
- Sectional tops, to allow for expansion and contraction.
- Reducing ring cover on every range.
- Extra large flues and large one-piece flue box, bolted and cemented.
- Carefully ground joints and first class fittings.
- Smooth finished castings.
- Non-breakable wire oven racks.
- Highly polished nickel finish.
- "L" water fronts for pressure boilers.

BUILT THROUGHOUT OF HIGHEST GRADE MATERIALS AND ARE FULLY GUARANTEED AGAINST MECHANICAL FLAWS OR DEFECTS OF WORKMANSHIP.

THE MOST COMPLETE AND UP TO DATE LINE OF CAST RANGES EVER MADE



CRESCENT CAST IRON RANGES



DIMENSIONS

AND EQUIPMENT

118 and 120 SERIES

No.	Finish	Oven	Square Top	Reservoir Top	Covers	Height to Top	Length Wood	Pipe Collar
B-118	Blue	18 1/2 x 18 x 12 1/2	25 x 35	25 x 45 1/2	6-8 inch	33 inches	20 1/2 inches	7 inch
B-120	Blue	20 1/2 x 20 x 12 1/2	30 1/2 x 37	30 1/2 x 49 1/2	6-8 inch	33 inches	20 1/2 inches	7 inch
G-118	Gray	18 1/2 x 18 x 12 1/2	25 x 35	25 x 45 1/2	6-8 inch	33 inches	20 1/2 inches	7 inch
G-120	Gray	20 1/2 x 20 x 12 1/2	30 1/2 x 37	30 1/2 x 49 1/2	6-8 inch	33 inches	20 1/2 inches	7 inch
P-118	Plain	18 1/2 x 18 x 12 1/2	25 x 35	25 x 45 1/2	6-8 inch	33 inches	20 1/2 inches	7 inch
P-120	Plain	20 1/2 x 20 x 12 1/2	30 1/2 x 37	30 1/2 x 49 1/2	6-8 inch	33 inches	20 1/2 inches	7 inch

SHOWN ON PAGES 46 TO 55

Detachable Copper Contact Reservoir, 7 1/2 Gallon Capacity

58 SERIES

No.	Finish	Oven	Square Top	Reservoir Top	Covers	Height to Top	Length Wood	Pipe Collar
B-58	Blue	18 x 18 x 12	26 x 32	26 x 43	6-8 inch	31 inches	20 inches	7 inch
G-58	Gray	18 x 18 x 12	26 x 32	26 x 43	6-8 inch	31 inches	20 inches	7 inch
P-58	Plain	18 x 18 x 12	26 x 32	26 x 43	6-8 inch	31 inches	20 inches	7 inch

SHOWN ON PAGES 56 TO 65

Detachable Copper Contact Reservoir, 7 1/2 Gallon Capacity

48 SERIES

B-48	Blue	18 x 17 x 11	25 x 33	25 x 44	6-8 inch	30 inches	17 inches	7 inch
G-48	Gray	18 x 17 x 11	25 x 33	25 x 44	6-8 inch	30 inches	17 inches	7 inch
P-48	Plain	18 x 17 x 11	25 x 33	25 x 44	6-8 inch	30 inches	17 inches	7 inch

SHOWN ON PAGES 66 TO 77

Detachable Copper Contact Reservoir, 7 Gallon Capacity

JOVIAL CRESCENT RANGE

For Coal and Wood

68-16	Plain	16 x 16 x 11	26 1/2 x 30 1/2		4-8 & 2-7 inch	30 inches	19 1/2 inches	7 inch
68-18	Plain	18 x 18 x 11 1/2	27 x 31	27 x 41	6-8 inch	30 1/2 inches	19 1/2 inches	7 inch
68-20	Plain	20 x 20 x 11 1/2	28 x 32 1/2	28 x 43	6-8 inch	30 1/2 inches	19 1/2 inches	7 inch

SHOWN ON PAGES 78 TO 81

Detachable Copper Contact Reservoir, 7 Gallon Capacity

JOVIAL CRESCENT RANGE

For Wood Only

58-16	Plain	16 x 16 x 11	26 1/2 x 30 1/2		4-8 & 2-7 inch	30 inches	19 1/2 inches	7 inch
58-18	Plain	18 x 18 x 11 1/2	27 x 31	27 x 41	6-8 inch	30 1/2 inches	19 1/2 inches	7 inch
58-20	Plain	20 x 20 x 11 1/2	28 x 32 1/2	28 x 43	6-8 inch	30 1/2 inches	19 1/2 inches	7 inch

SHOWN ON PAGES 82 TO 85

Detachable Copper Contact Reservoir, 7 Gallon Capacity

Top Measurements do not include Pouch Feed Extension or Back Shelf



CRESCENT BLUE PORCELAIN CAST RANGE

For Coal or Wood

Polished Top

Number	Oven	Weight	Code
B-118	$18\frac{1}{2} \times 18 \times 12\frac{1}{2}$	450	Afflux
B-120	$20\frac{1}{2} \times 20 \times 12\frac{1}{2}$	500	Affray

Description and Dimensions Pages 44 and 45



CRESCENT BLUE PORCELAIN CAST RANGE

For Coal or Wood

Polished Top

Number
B-118
B-120

Oven
18½ x 18 x 12½
20½ x 20 x 12½

Net Weight
500
550

Code
Affy
Afloat

When Ordering Use Code Words

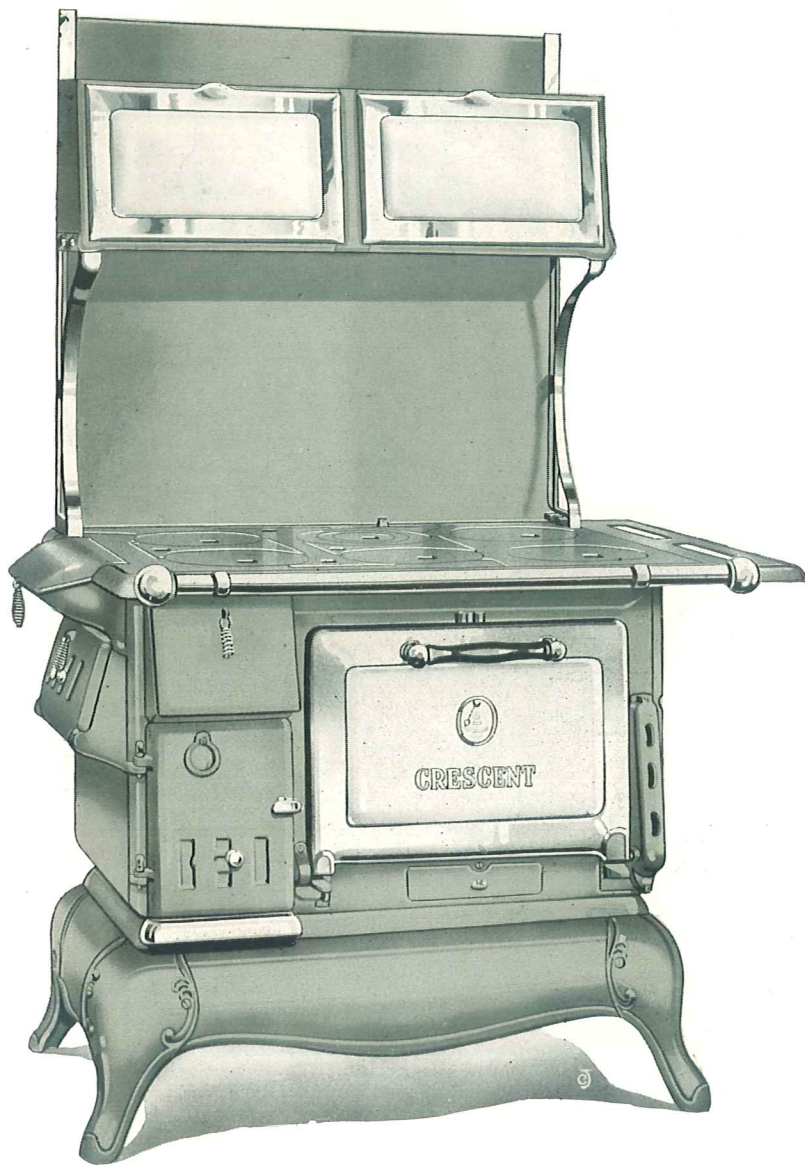

CRESCENT GRAY PORCELAIN CAST RANGE

For Coal or Wood

Polished Top

Number	Oven	Weight	Code
G-118	$18\frac{1}{2} \times 18 \times 12\frac{1}{2}$	450	Affront
G-120	$20\frac{1}{2} \times 20 \times 12\frac{1}{2}$	500	Affuse

Description and Dimensions, Pages 44 and 45

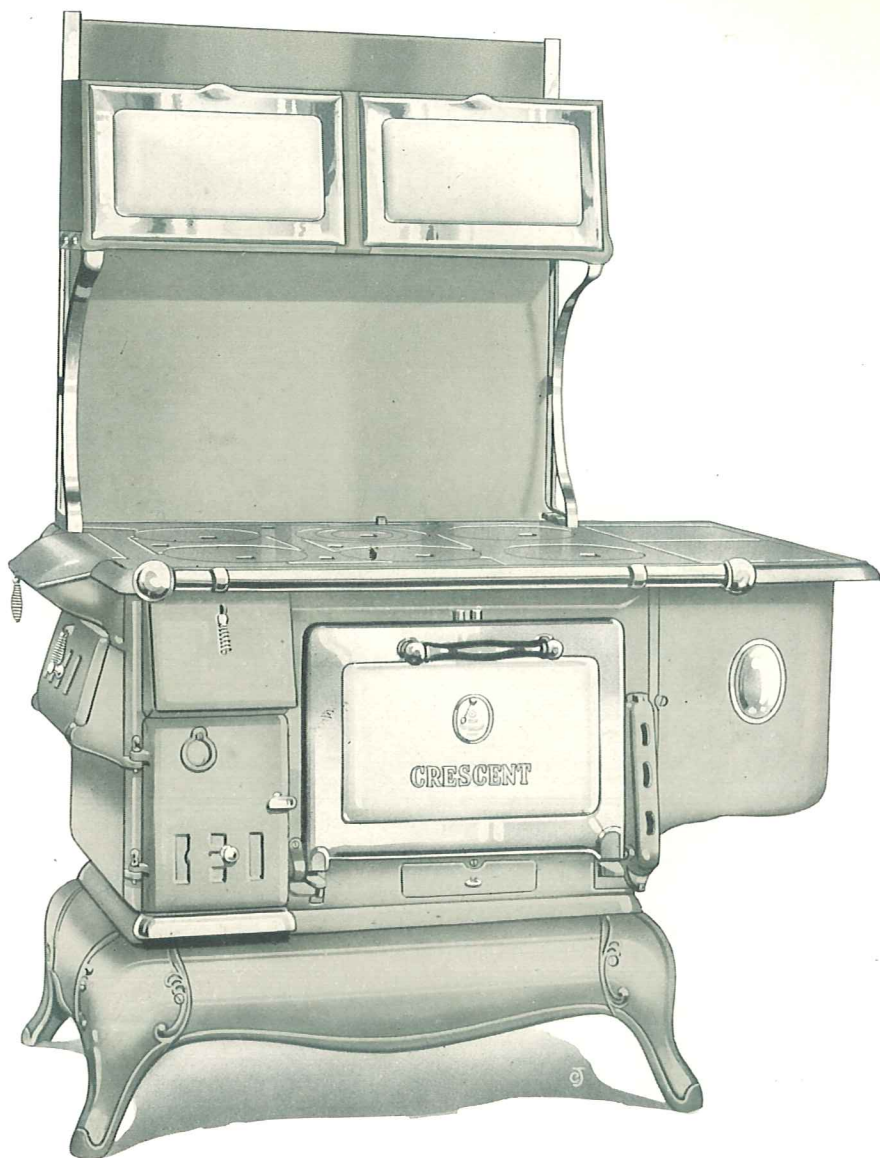

CRESCENT GRAY PORCELAIN CAST RANGE

For Coal or Wood

Polished Top

Number	Oven	Weight	Code
G-118	18½ x 18 x 12½	500	Afoot
G-120	20½ x 20 x 12½	550	Afore

When Ordering Use Code Words

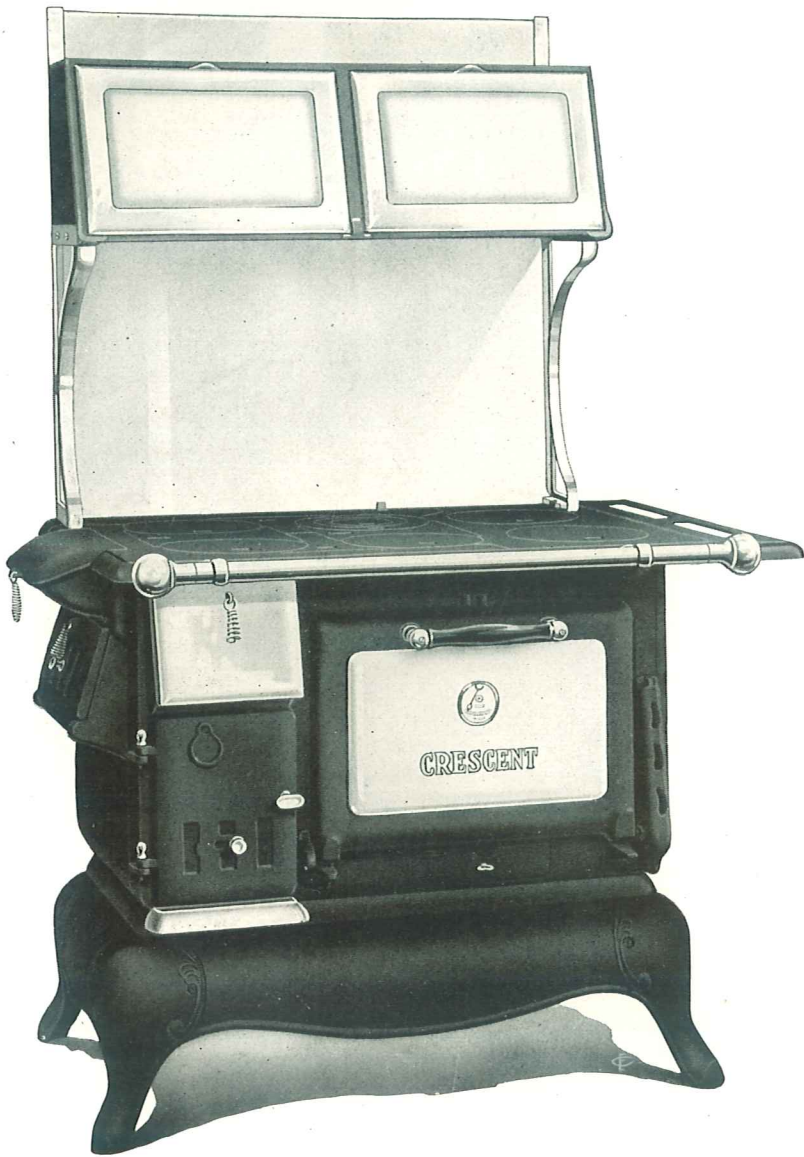

CRESCENT

Cast Range for Coal or Wood

Enamel Trimmed High Closet Style

Number
P-118
P-120

Oven
18½ x 18 x 12½
20½ x 20 x 12½

Weight
445
495

Code
Afreet
Afresh

Description and Dimensions, Pages 44 and 45

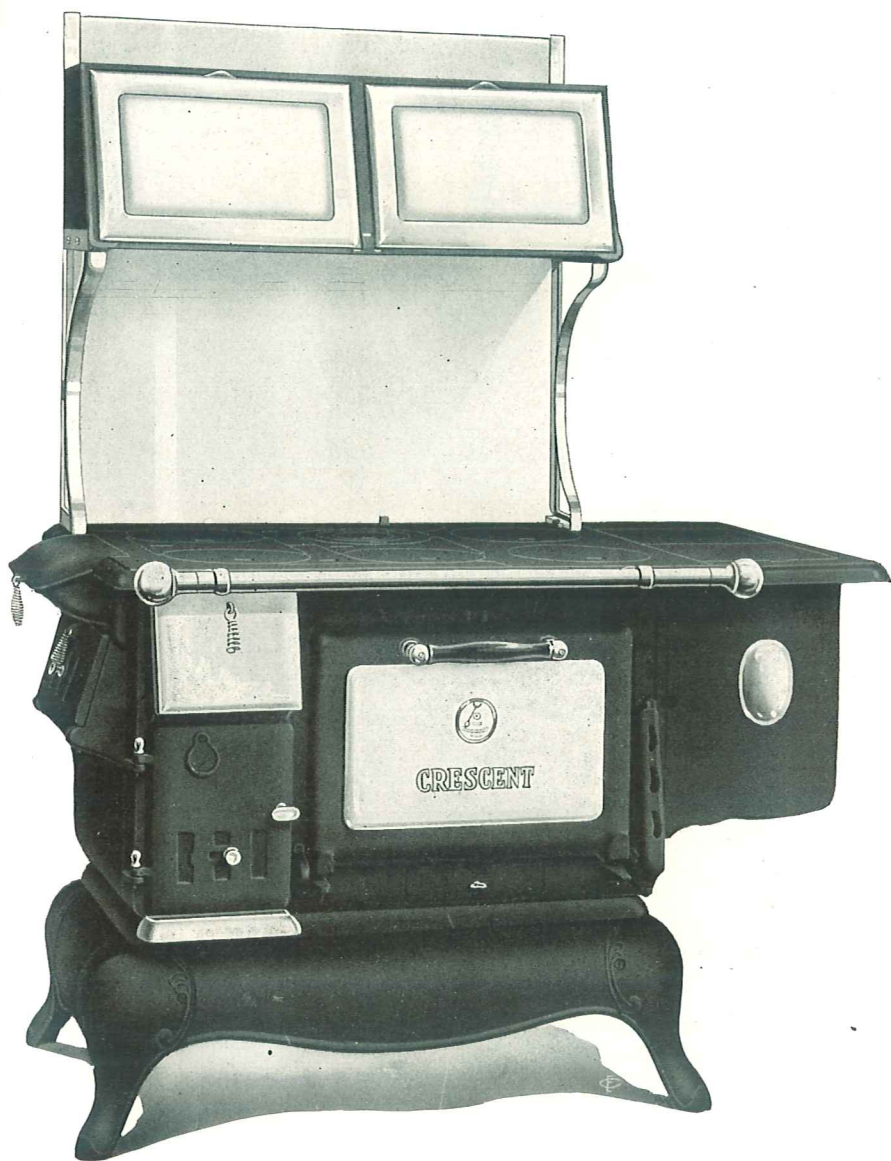

CRESCENT

Cast Range for Coal or Wood

Enamel Trimmed High Closet Style

Number
P-118
P-120

Oven
18½ x 18 x 12½
20½ x 20 x 12½

Weight
495
545

Code
Agama
Agape

When Ordering Use Code Words



CRESCENT

Cast Range for Coal or Wood

Nickel Trimmed High Closet Style

Number
P-118
P-120

Oven
18½ x 18 x 12½
20½ x 20 x 12½

Weight
445
495

[Code
Agency
Aggress

When Ordering Use Code Words

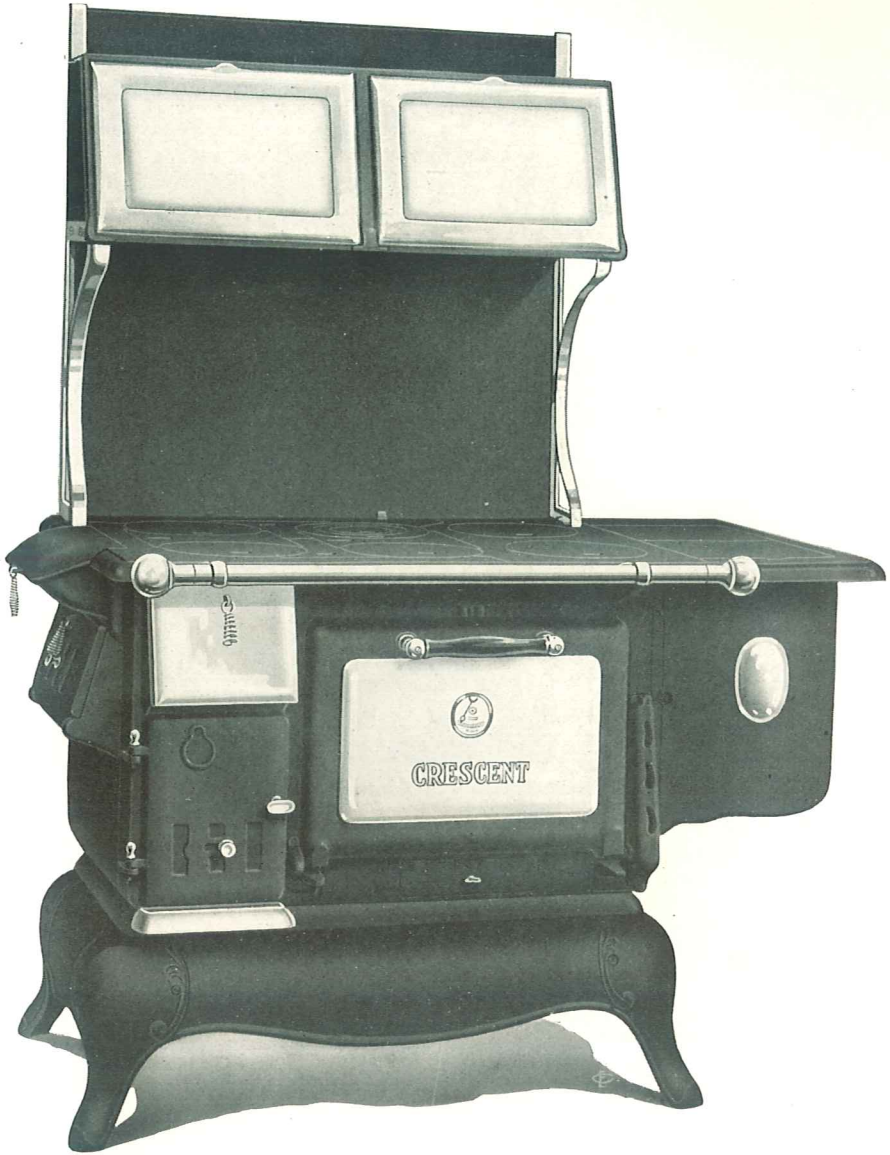

CRESCENT

Cast Range for Coal or Wood

Nickel Trimmed High Closet Style

Number	Oven	Weight	Code
P-118	18½ x 18 x 12½	495	Aghast
P-120	20½ x 20 x 12½	545	Agile

Description and Dimensions Pages 44 and 45

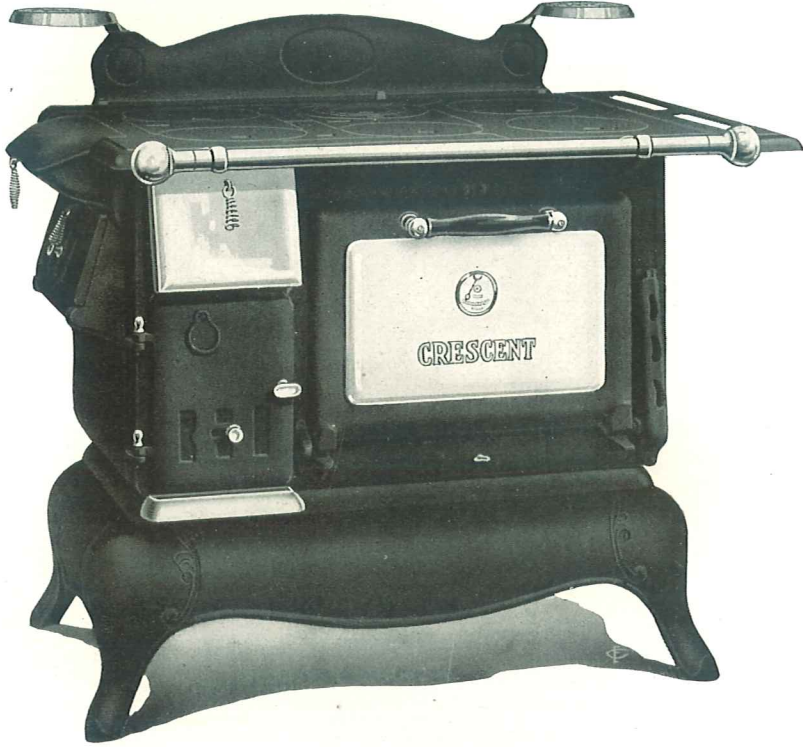

CRESCENT

Cast Range for Coal or Wood

Number	Oven	Weight	Code
P-118	18½ x 18 x 12½	380	Agitate
P-120	20½ x 20 x 12½	430	Aglow

Description and Dimensions, Pages 44 and 45



CRESCENT

Cast Range for Coal or Wood

Number	Oven	Weight	Code
P-118	18½ x 18 x 12½	430	Agnate
P-120	20½ x 20 x 12½	480	Agnus

When Ordering Use Code Words



CRESCENT BLUE PORCELAIN CAST RANGE

For Coal or Wood

Polished Top

Number
B-58

Oven
18 x 18 x 12

Weight
380

Code
Agog

Description and Dimensions, Pages 44 and 45



CRESCENT BLUE PORCELAIN CAST RANGE

For Coal or Wood

Polished Top

Number
B-58

Oven
18 x 18 x 12

Weight
420

Code
Agora

When Ordering Use Code Words

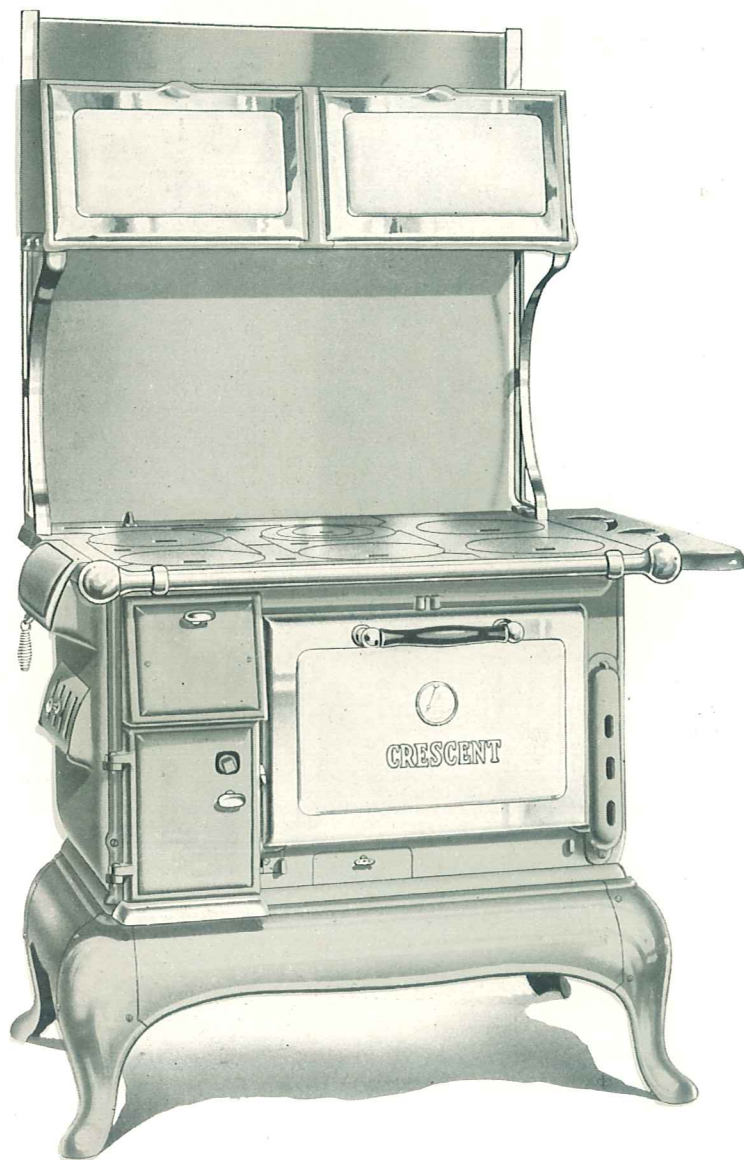

CRESCENT GRAY PORCELAIN CAST RANGE

For Coal or Wood

Polished Top

Number
G-58

Oven
18 x 18 x 12

Weight
380

Code
Agonic

Description and Dimensions, Pages 44 and 45



CRESCENT GRAY PORCELAIN CAST RANGE

For Coal or Wood

Polished Top

Number
G-58

Oven
18 x 18 x 12

Weight
420

Code
Agraffe

When Ordering Use Code Words

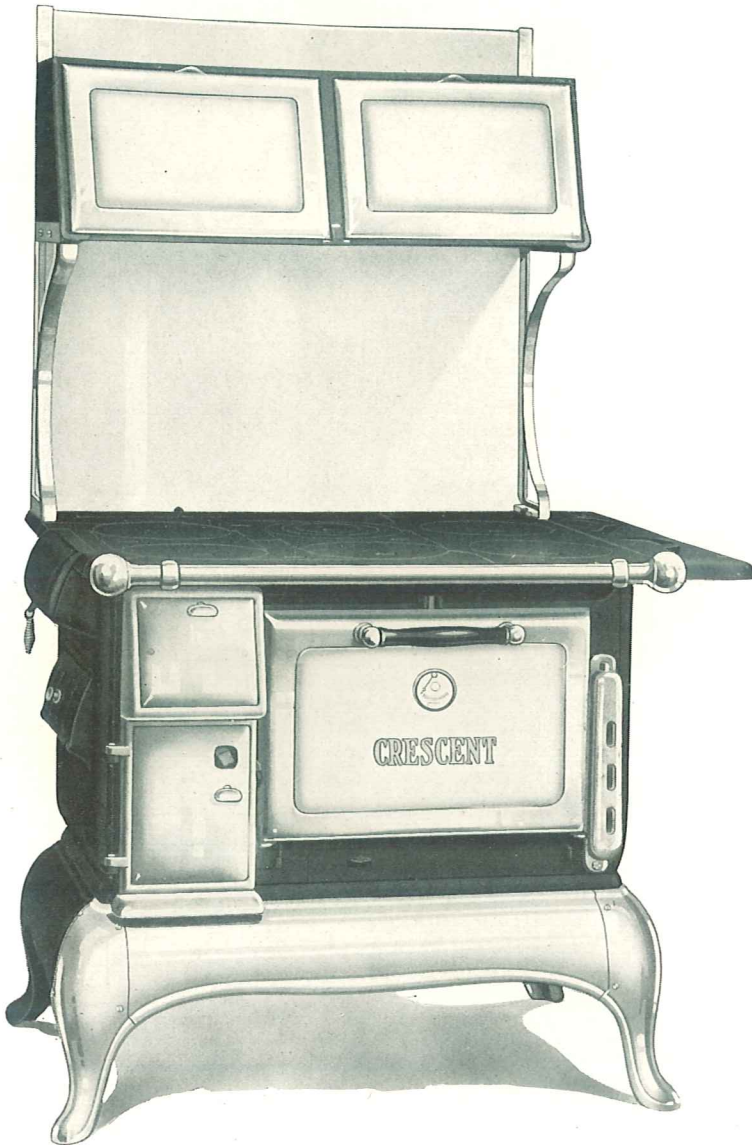

CRESCENT

Cast Range for Coal or Wood

Enamel Trimmed High Closet Style

Number
P-58

Oven
18 x 18 x 12

Weight
375

Code
Agree

Description and Dimensions Pages 44 and 45

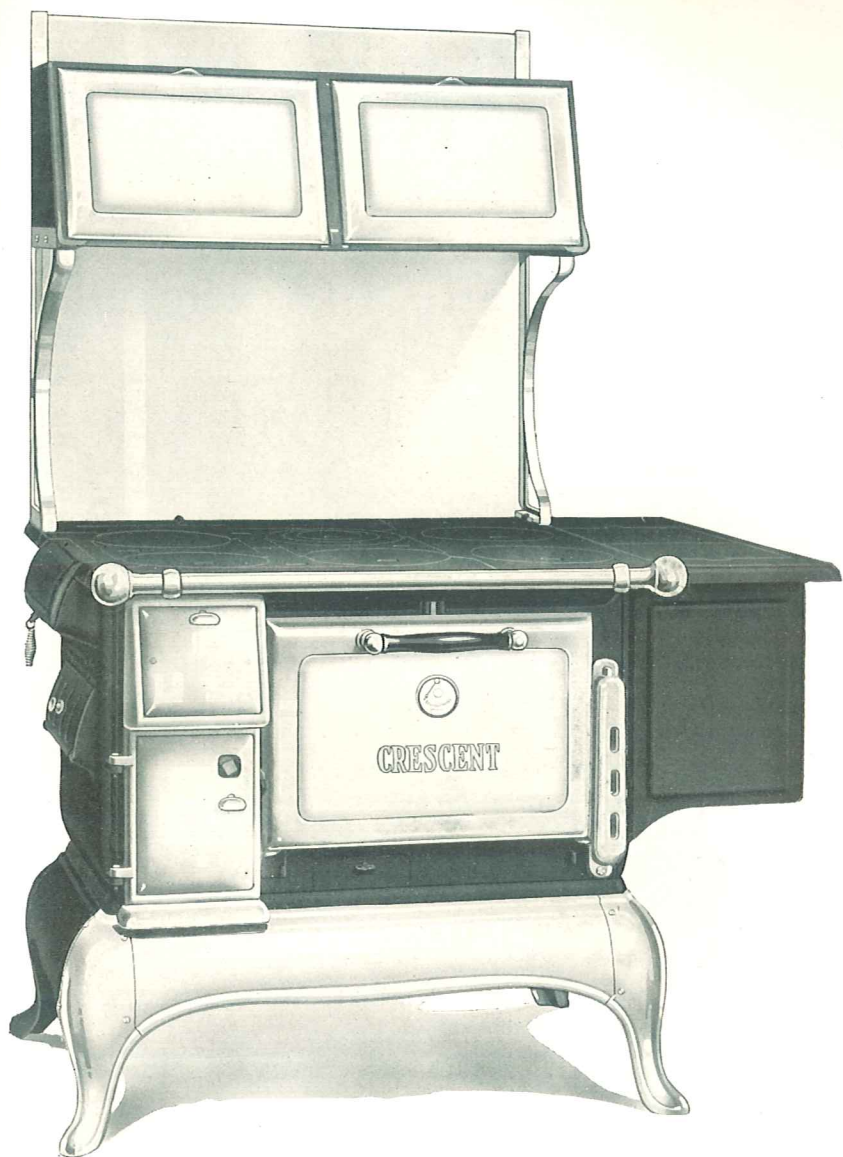

CRESCENT

Cast Range for Coal or Wood

Enamel Trimmed High Closet Style

Number
P-58

Oven
18 x 18 x 12

Weight
415

Code
Aground

When Ordering Use Code Words

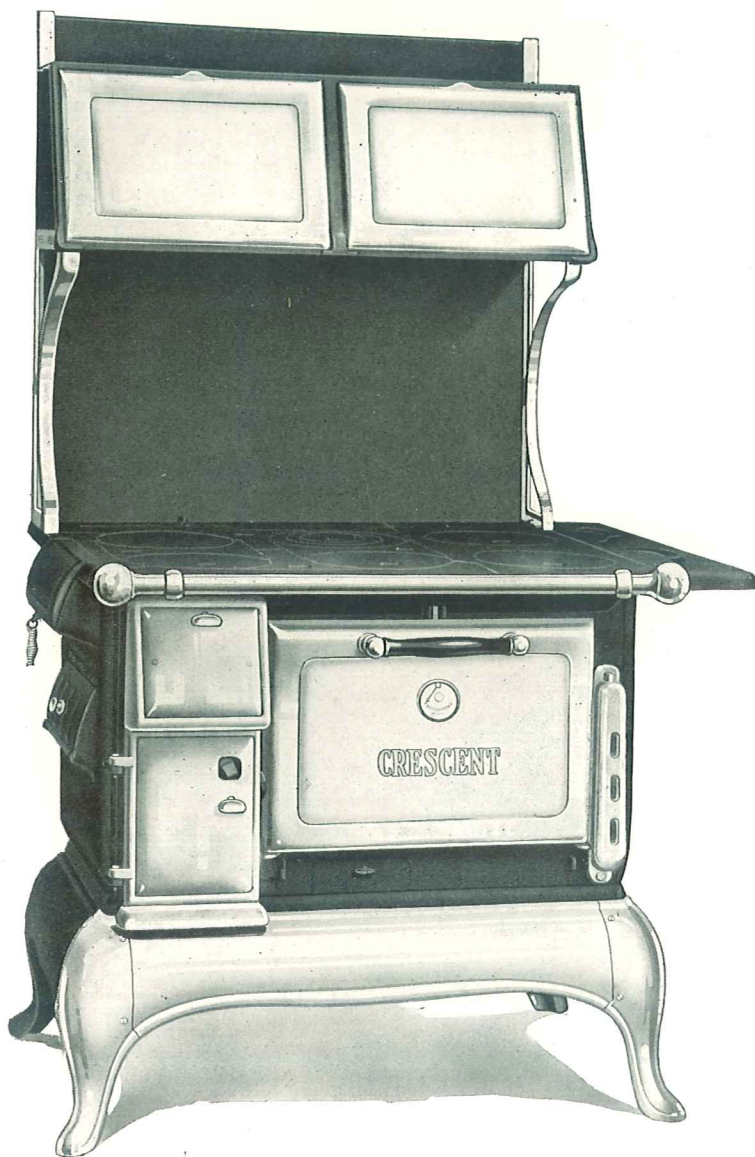

CRESCENT

Cast Range for Coal or Wood

Nickel Trimmed High Closet Style

Number
P-58

Oven
18 x 18 x 12

Weight
375

Code
Ague

When Ordering Use Code Words

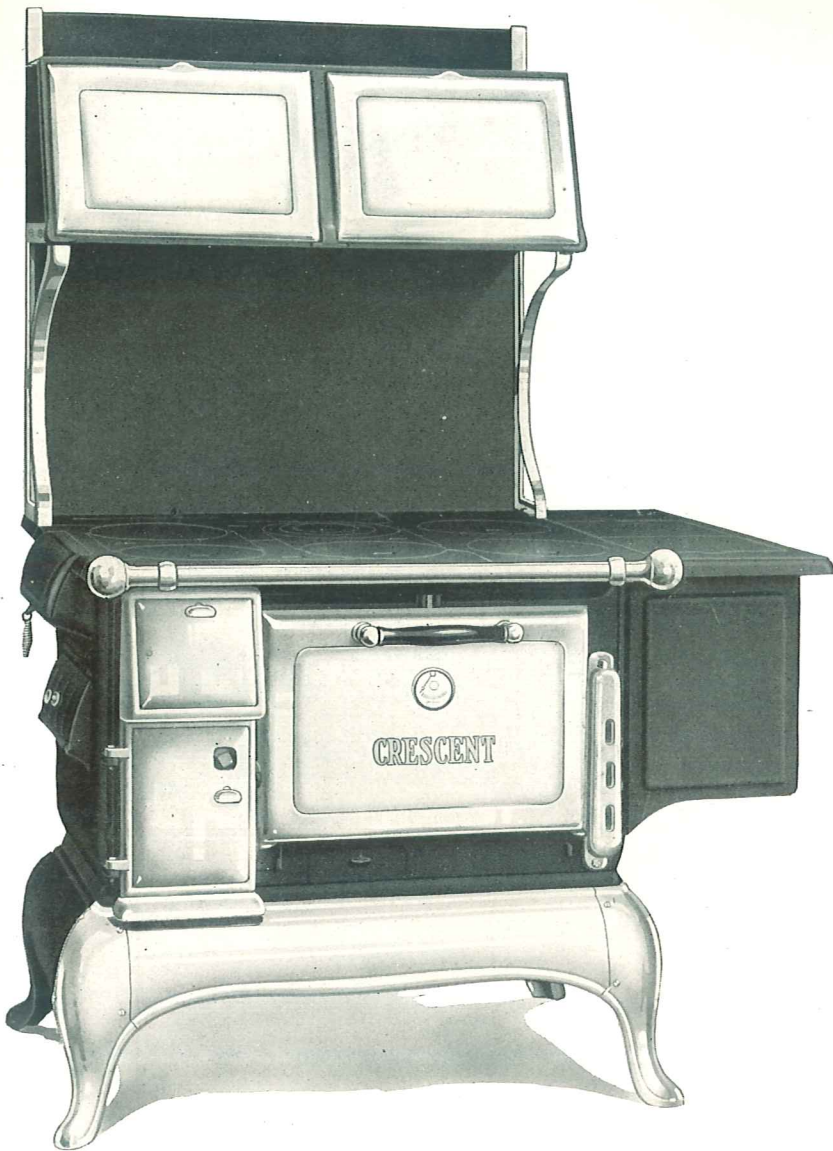

CRESCENT

Cast Range for Coal or Wood

Nickel Trimmed High Closet Style

Number
P-58

Oven
18 x 18 x 12

Weight
415

Code
Ahead

Description and Dimensions, Pages 44 and 45

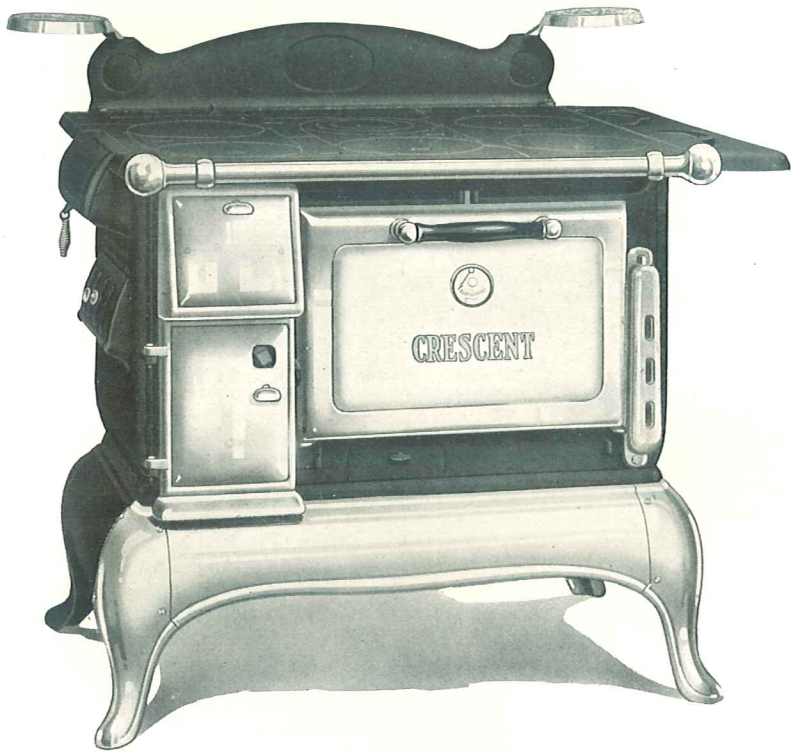

CRESCENT

Cast Range for Coal or Wood

Number	Oven	Weight	Code
P-58	18 x 18 x 12	340	Aidant

When Ordering Use Code Words

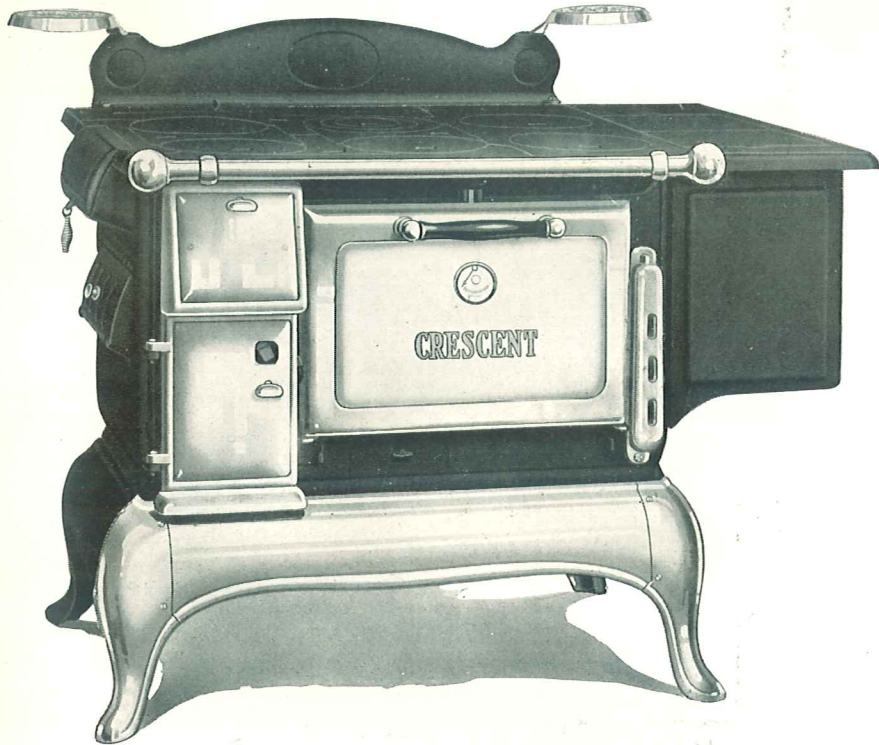

CRESCENT

Cast Range for Coal or Wood

Number
P-58

Oven
18 x 18 x 12

Weight
380

Code
Airily

Description and Dimensions, Pages 44 and 45



CRESCENT BLUE PORCELAIN CAST RANGE

For Coal or Wood

Polished Top

Number
B-48

Oven
18 x 17 x 11

Weight
355

Code
Aisle

Description and Dimensions, Pages 44 and 45



CRESCENT BLUE PORCELAIN CAST RANGE

For Coal or Wood

Polished Top

Number
B-48

Oven
18 x 17 x 11

Weight
395

Code
Akin

When Ordering Use Code Words

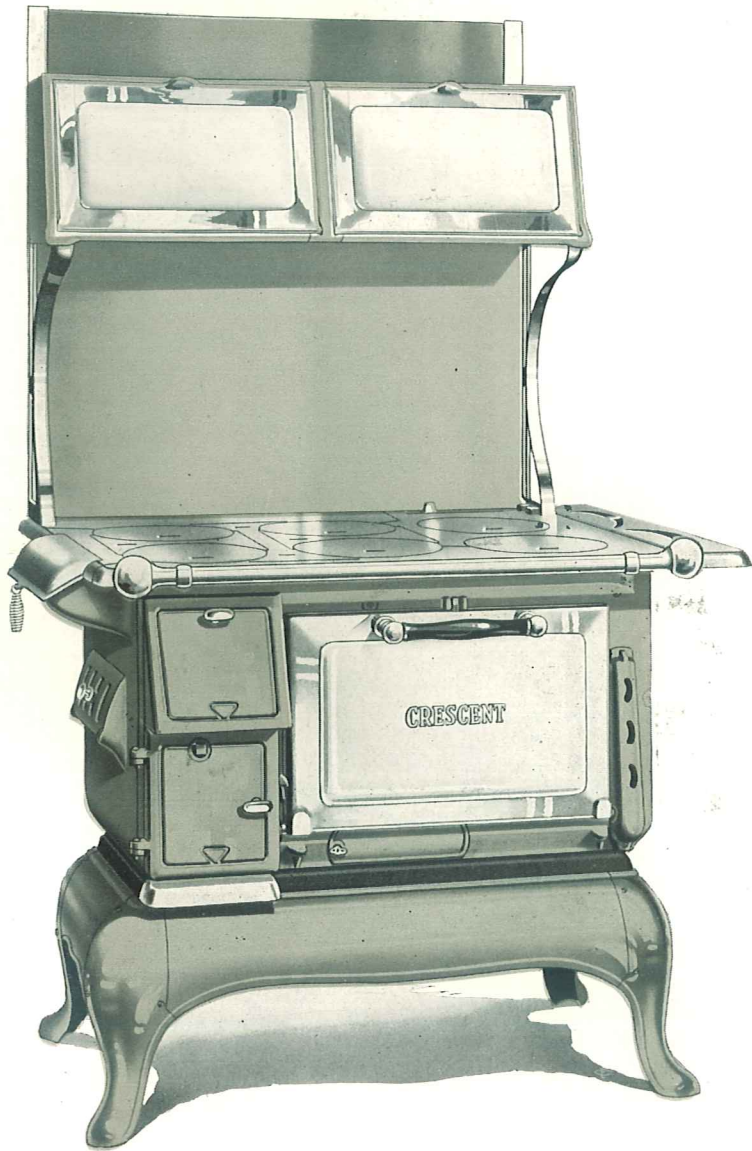

CRESCENT GRAY PORCELAIN CAST RANGE

For Coal or Wood

Polished Top

Number
G-48

Oven
18 x 17 x 11

Weight
355

Code
Ajar

Description and Dimensions, Pages 44 and 45

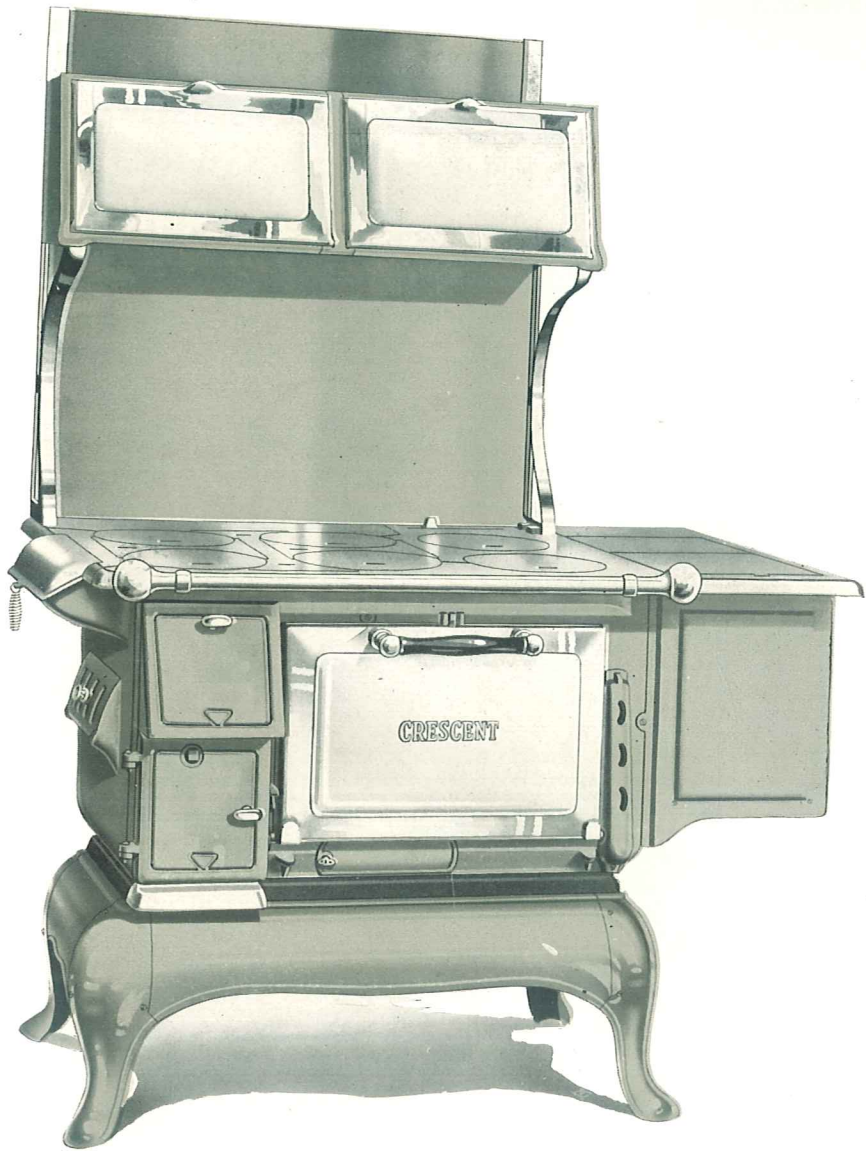

CRESCENT GRAY PORCELAIN CAST RANGE

For Coal or Wood

Polished Top

Number
G-48

Oven
18 x 17 x 11

Weight
395

Code
Alack

When Ordering Use Code Words

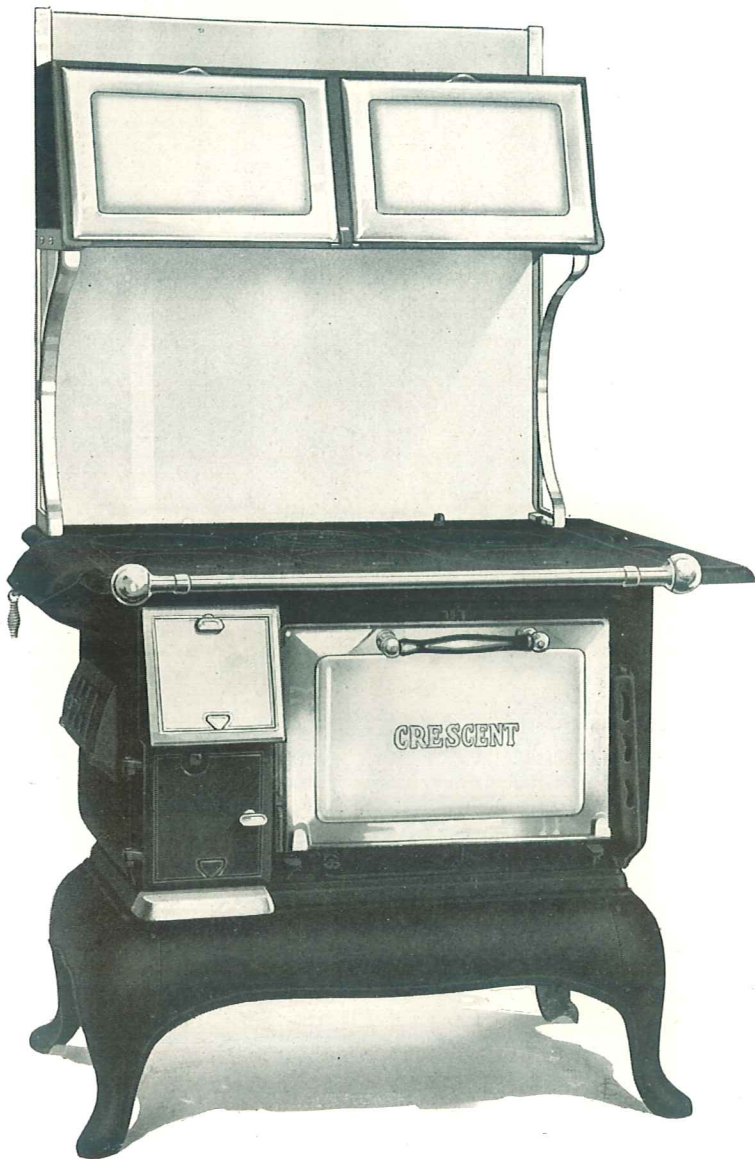

CRESCENT

Cast Range for Coal or Wood

Enamel Trimmed High Closet Style

Number
P-48

Oven
18 x 17 x 11

Weight
350

Code
Alamo

Description and Dimensions, Pages 44 and 45

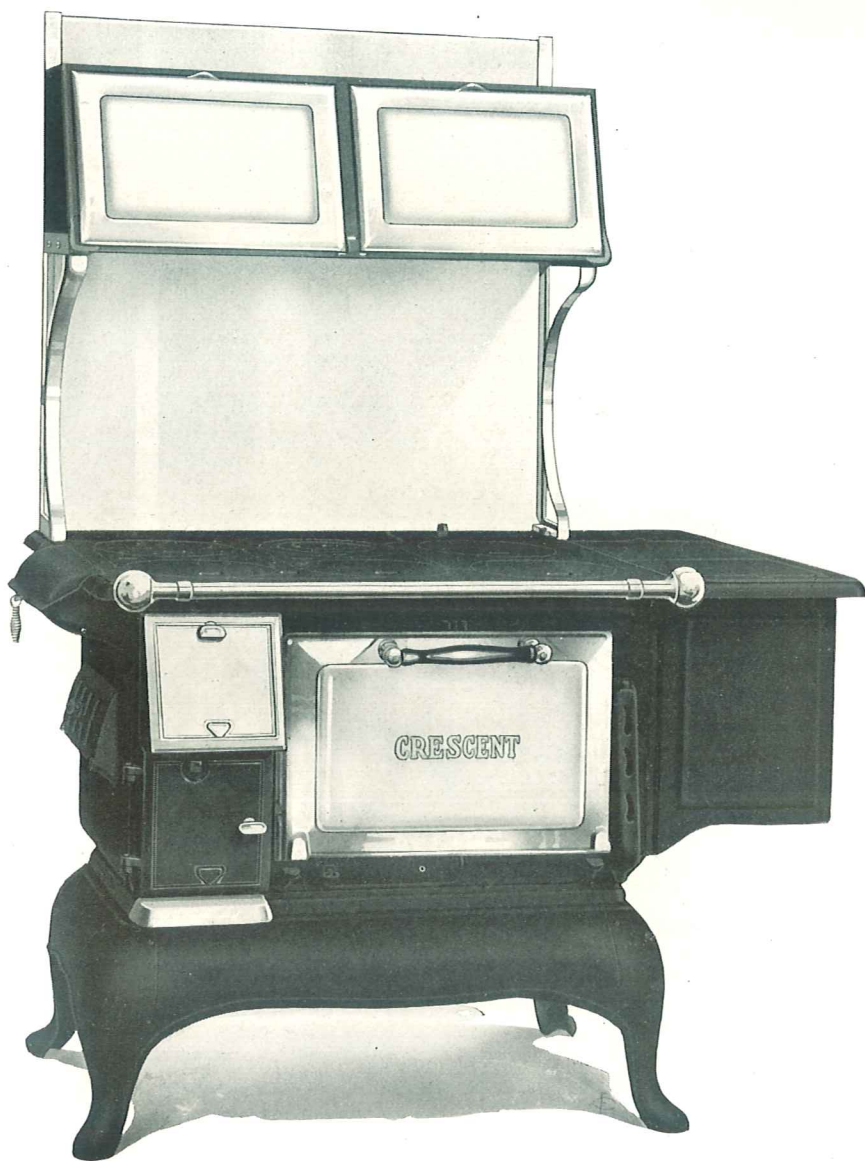

CRESCENT

Cast Range for Coal or Wood

Enamel Trimmed High Closet Style

Number
P-48

Oven
18 x 17 x 11

Weight
390

Code
Alarm

When Ordering Use Code Words

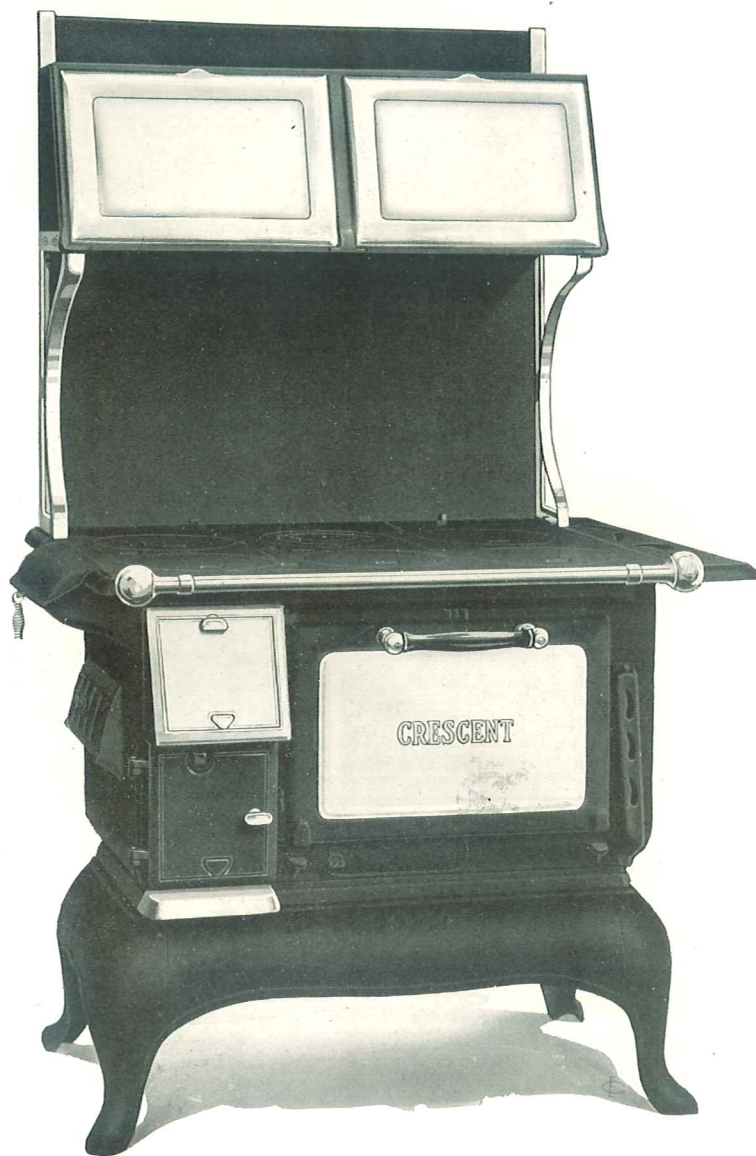

CRESCENT

Cast Range for Coal or Wood

Nickel Trimmed High Closet Style

Number
P-48

Oven
18 x 17 x 11

Weight
350

Code
Alate

Description and Dimensions, Pages 44 and 45



CRESCENT

Cast Range for Coal or Wood

Nickel Trimmed High Closet Style

Number
P-48

Oven
18 x 17 x 11

Weight
390

Code
Album

When Ordering Use Code Words

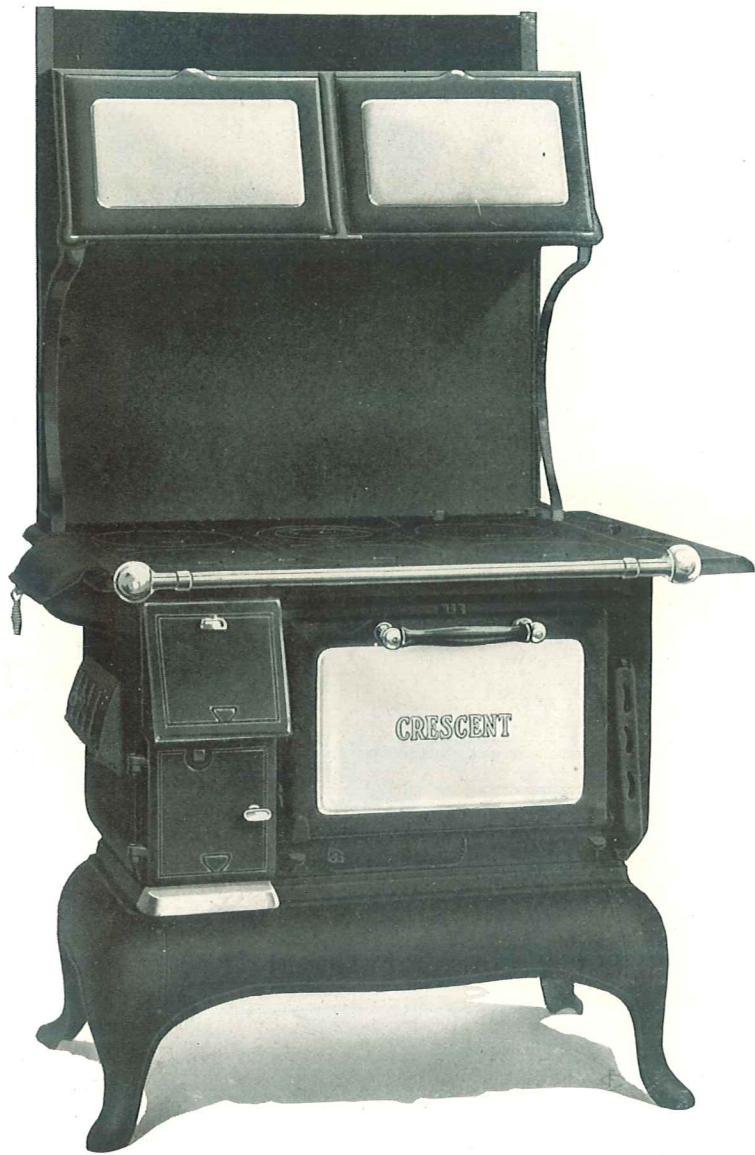

CRESCENT

Cast Range for Coal or Wood

Plain High Closet Style

Number
P-48

Oven
18 x 17 x 11

Weight
350

Code
Aldine

When Ordering Use Code Words



CRESCENT

Cast Range for Coal or Wood

Plain High Closet Style

Number
P-48

Oven
18 x 17 x 11

Weight
390

Code
Alert

Description and Dimensions, Pages 44 and 45

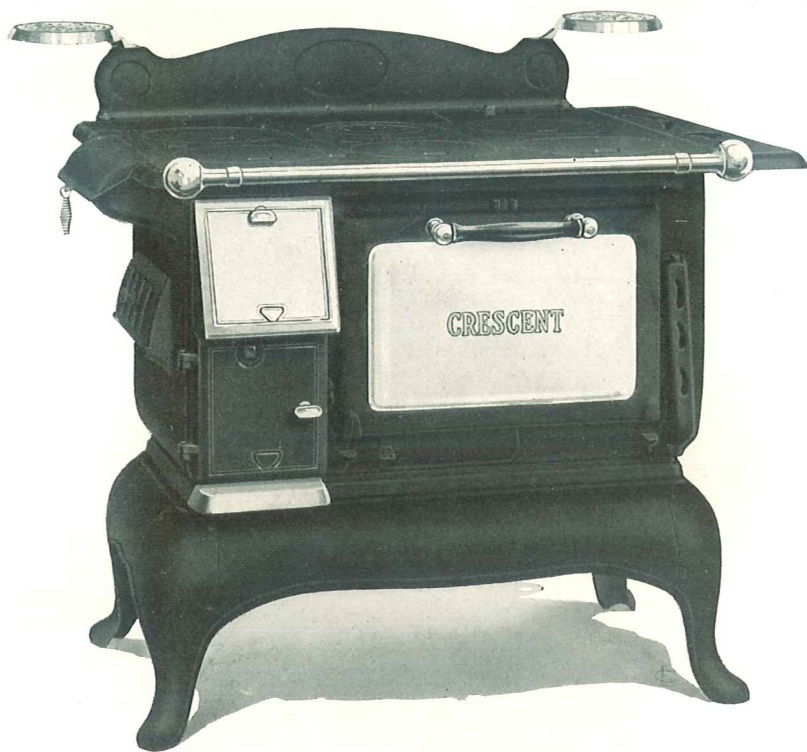

CRESCENT

Cast Range for Coal or Wood

Number
P-48

Oven
18 x 17 x 11

Weight
310

Code
Alcazar

Description and Dimensions, Pages 44 and 45

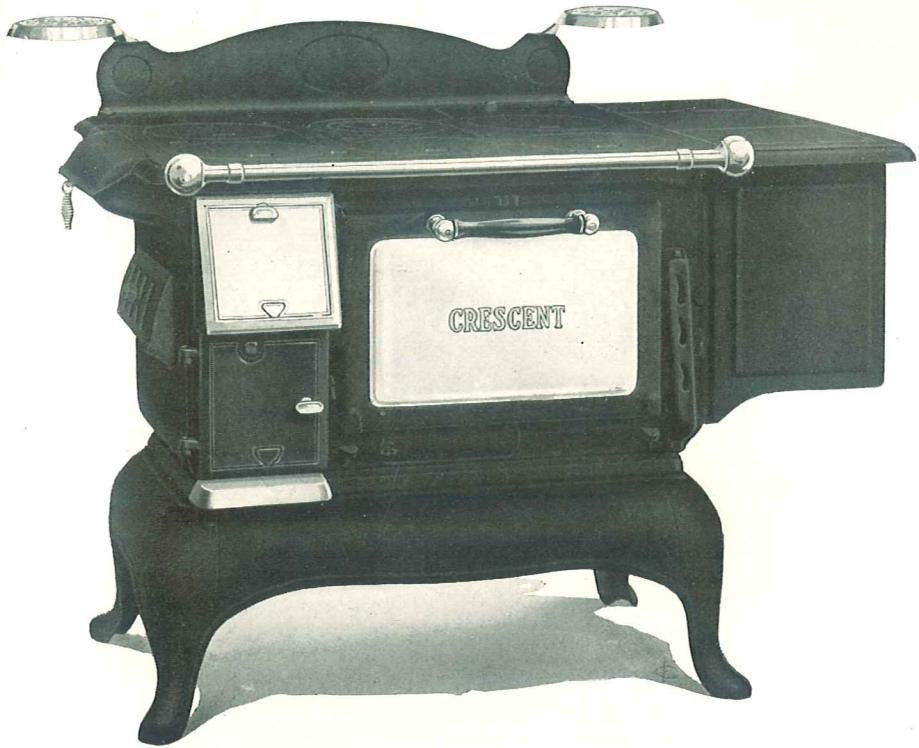

CRESCENT

Cast Range for Coal or Wood

Number	Oven	Weight	Code
P-48	18 x 17 x 11	350	Alcove

When Ordering Use Code Words

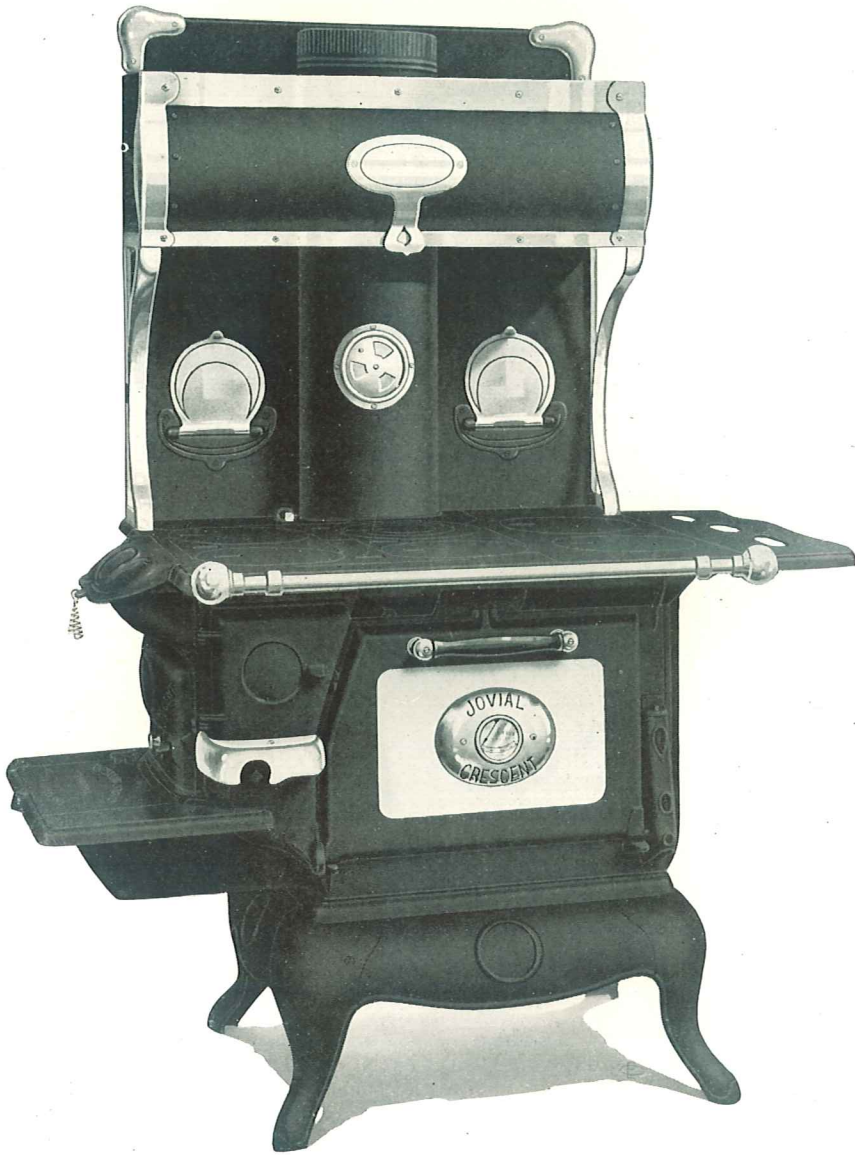

JOVIAL CRESCENT

Cast Range for Coal or Wood

Number	Oven	Weight	Code
68-16	16 x 16 x 11	335	Algate
68-18	18 x 18 x 11½	365	Algar
68-20	20 x 20 x 11½	395	Alias

Description and Dimensions, Pages 44 and 45

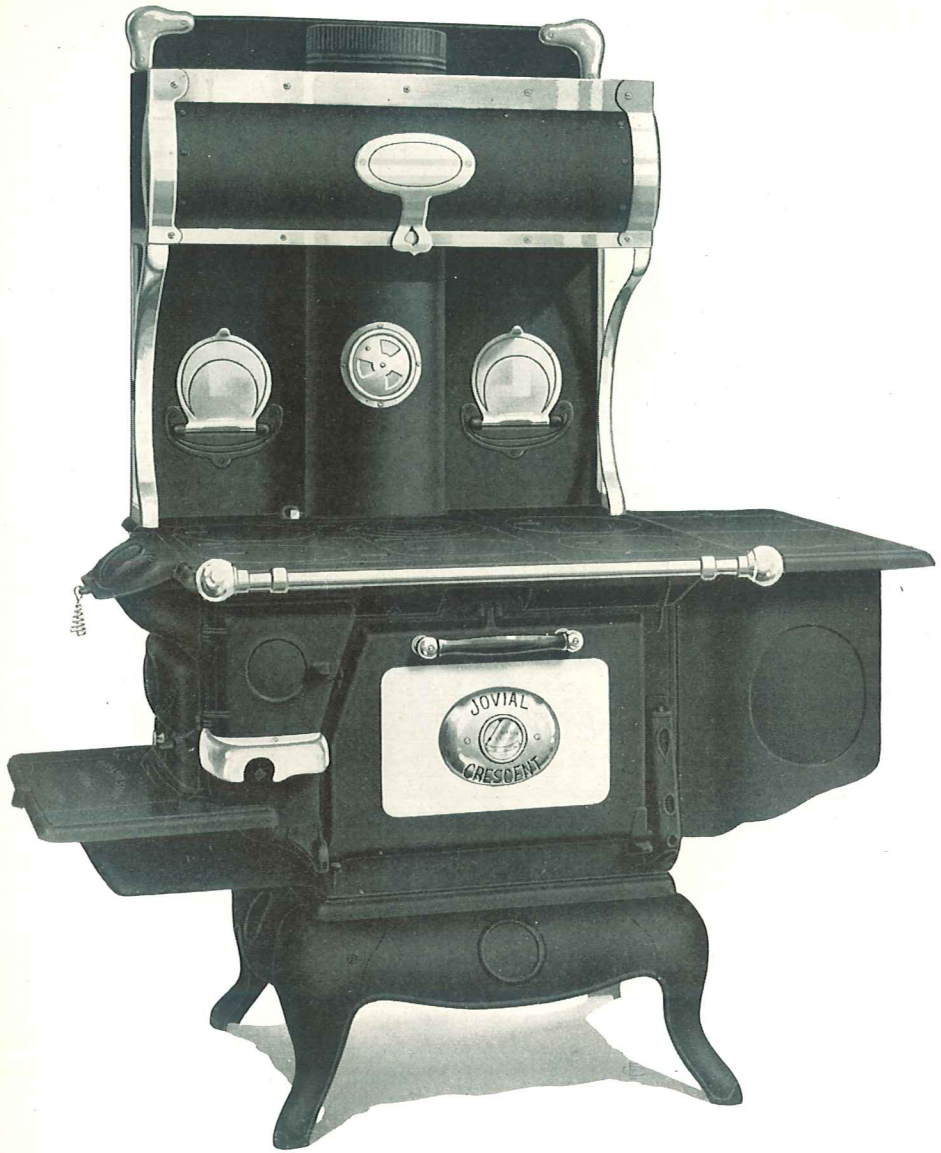

JOVIAL CRESCENT

Cast Range for Coal or Wood

Number	Oven	Weight	Code
68-18	18 x 18 x 11½	415	Alien
68-20	20 x 20 x 11½	445	Alight

When Ordering Use Code Words

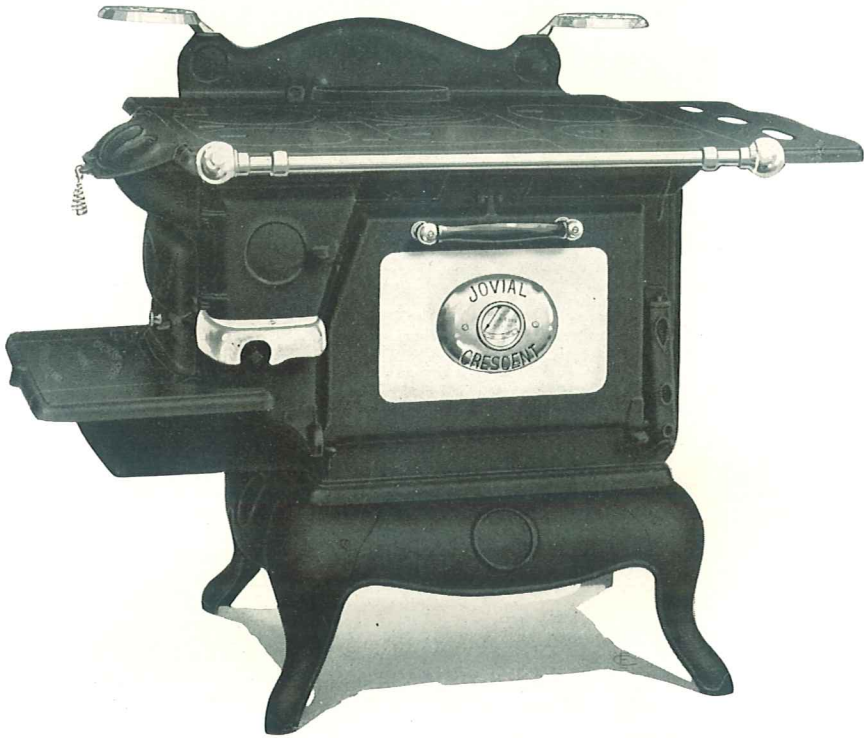

JOVIAL CRESCENT

Cast Range for Coal or Wood

Number	Oven	Weight	Code
68-16	16 x 16 x 11	295	Allay
68-18	18 x 18 x 11½	325	Allege
68-20	20 x 20 x 11½	355	Allot

Description and Dimensions, Pages 44 and 45

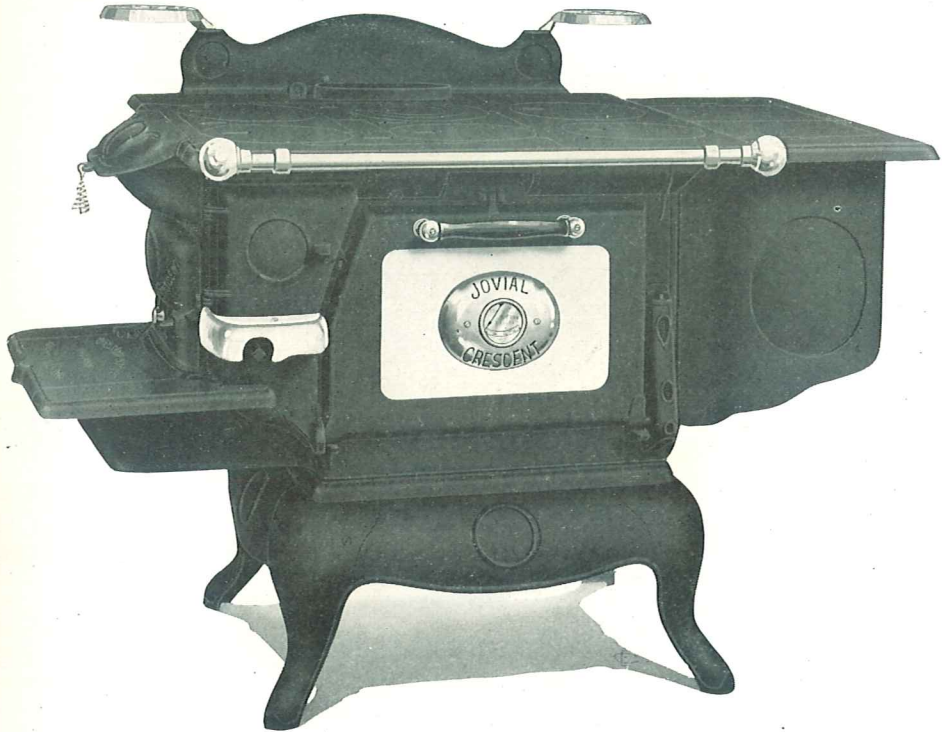

JOVIAL CRESCENT

Cast Range for Coal or Wood

Number	Oven	Weight	Code
68-18	18 x 18 x 11½	375	Allude
68-20	20 x 20 x 11½	395	Almond

When Ordering Use Code Words

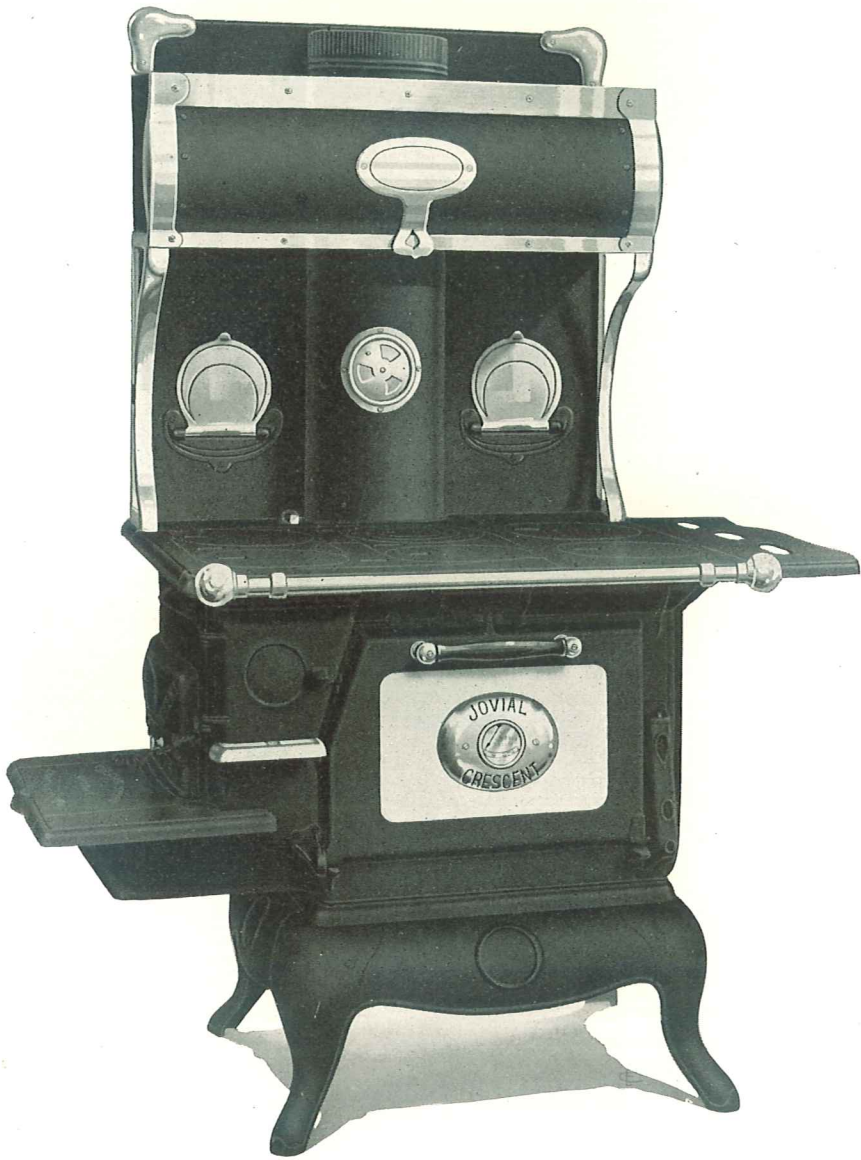

JOVIAL CRESCENT

Cast Range for Wood Only

Number	Oven	Weight	Code
58-16	16 x 16 x 11	325	Aloft
58-18	18 x 18 x 11½	350	Alone
58-20	20 x 20 x 11½	375	Alpha

Description and Dimensions, Pages 44 and 45

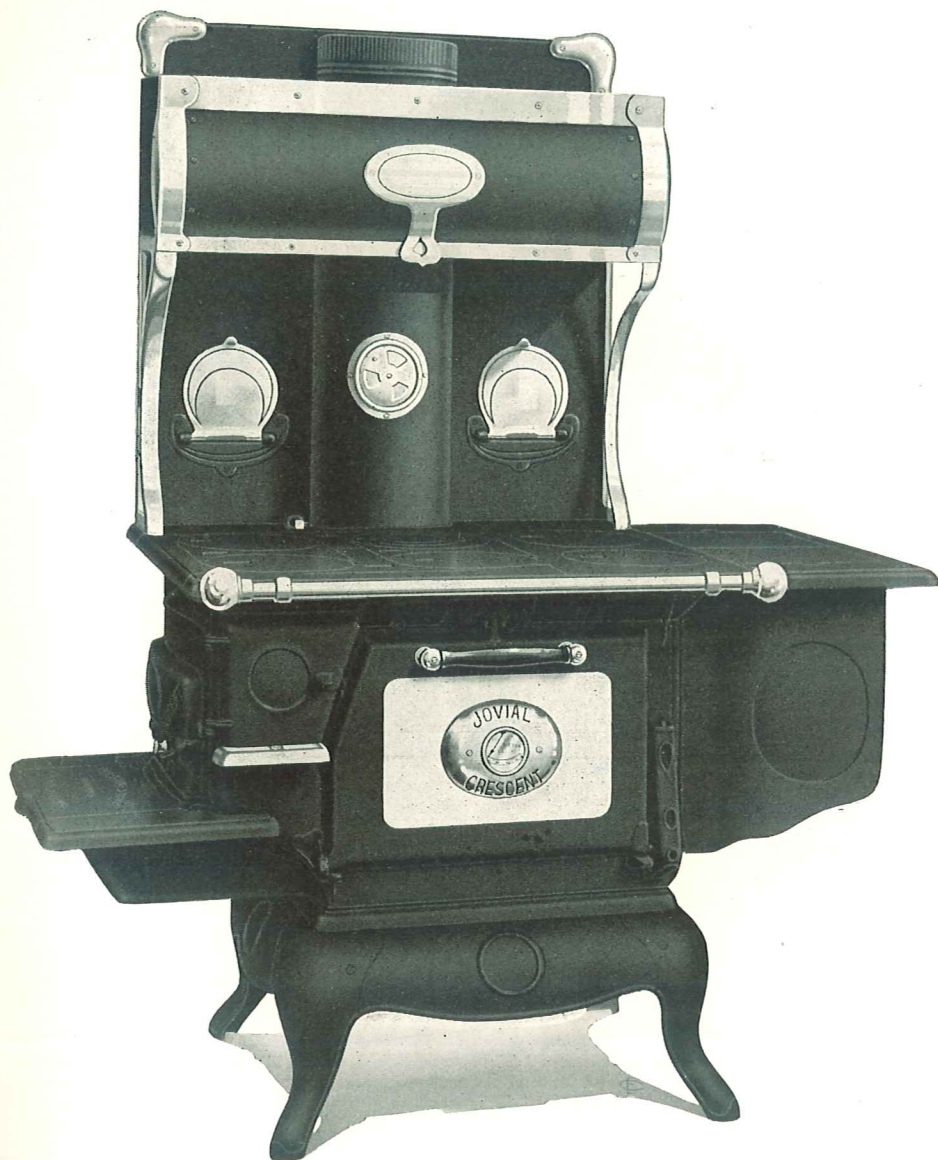

JOVIAL CRESCENT

Cast Ranges for Wood Only

Number	Oven	Weight	Code
58-18	18 x 18 x 11½	400	Alpine
58-20	20 x 20 x 11½	425	Altar

When Ordering Use Code Words

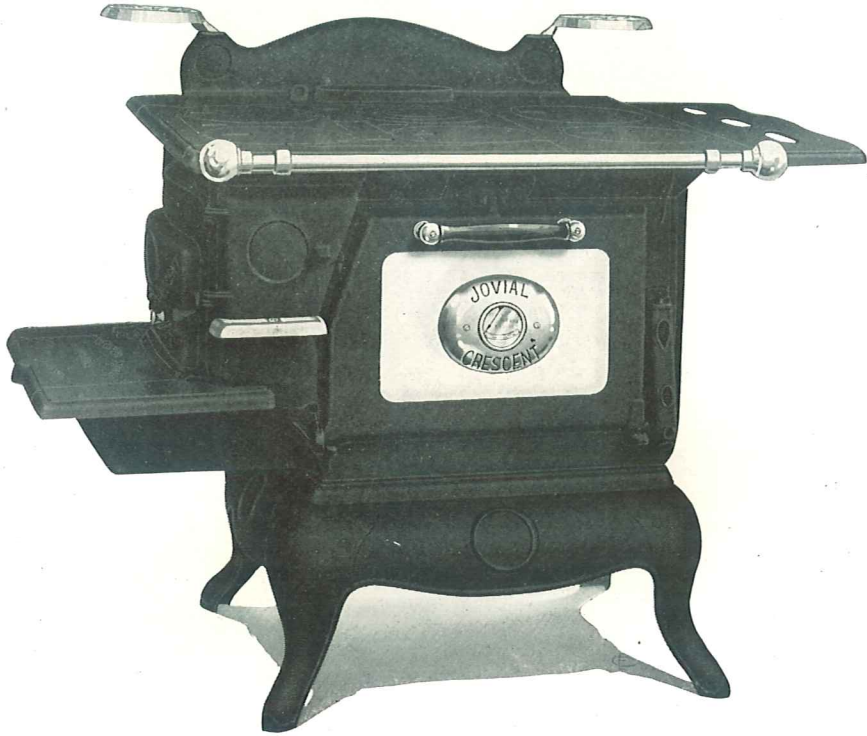

JOVIAL CRESCENT

Cast Range for Wood Only

Number	Oven	Weight	Code
58-16	16 x 16 x 11	285	Amain
58-18	18 x 18 x 11½	315	Amass
58-20	20 x 20 x 11½	340	Amaze

Description and Dimensions, Pages 44 and 45

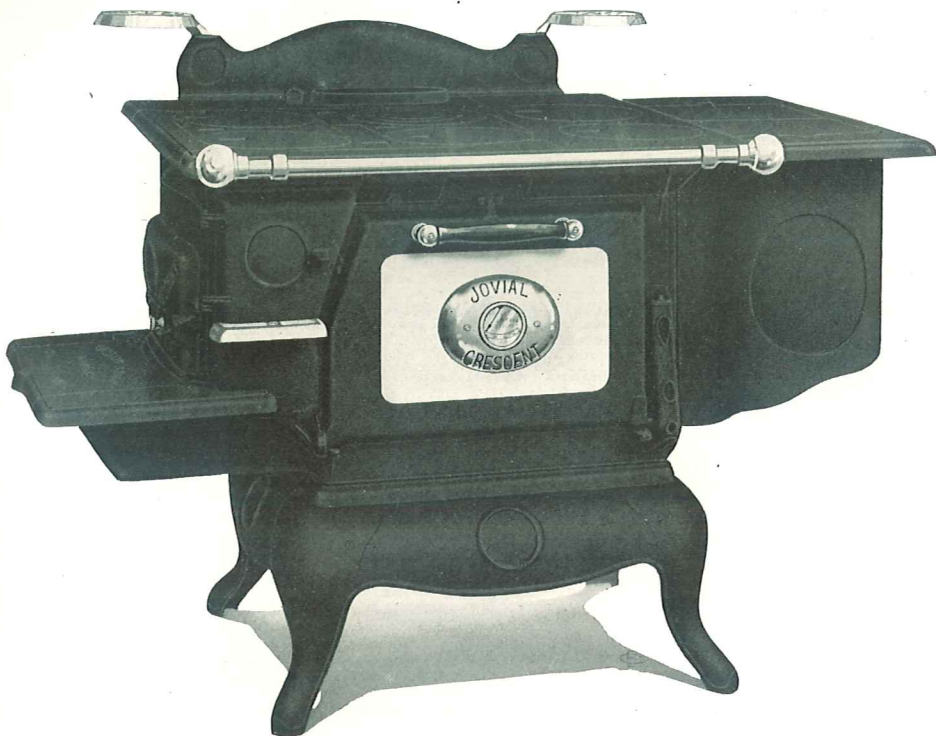

JOVIAL CRESCENT

Cast Range for Wood Only

Number	Oven	Weight	Code
58-18	18 x 18 x 11½	365	Ambage
58-20	20 x 20 x 11½	395	Amber

When Ordering Use Code Words



CRESCENT STEEL RANGES

FOR HARD OR SOFT COAL



COKE OR WOOD

POINTS OF MERIT IN CRESCENT STEEL RANGES

White Enameled Splashes on High Closets.

White Enameled Oven and high closet Door Panels—Cushion Type.

Sanitary High Closets, with pipe in back of closet making full space of closet available.

Sliding Direct Draft Dampers give perfect control when baking.

Detachable Encased Copper Contact Reservoirs.

All Cast Iron Base Strips and Cast Iron High Closet Brackets.

Perfectly balanced Oven Doors with adjustable tempered steel spring.

Oven Doors steel lined.

Enameled "Always Cool" wood oven door handles.

Duplex Grates for coal or wood.

Heavy Covers and Centers, strongly ribbed.

Sectional Tops to allow for expansion and contraction.

Reducing Ring Cover on every range.

Smooth finished castings and first-class fittings.

Non-breakable wire oven racks.

Extra-heavy highly polished nickel finish.

"L" Water Fronts for pressure boilers.

Triple Wall Construction.

Electric Welded, One Piece Bodies making every joint air-tight and perfectly smooth.

WELLSVILLE BLUE POLISHED STEEL.

Built throughout of highest grade materials and are fully guaranteed against mechanical flaws or defects of workmanship.

For Quality, Style and Finish, CRESCENT STEEL RANGES cannot be excelled.



CRESCENT STEEL RANGES

FOR HARD OR SOFT COAL



COKE OR WOOD

CRESCENT STEEL RANGES as shown in this catalogue have been made by us for many years. The enviable reputation and immense business we have on our Steel Ranges is ample proof of the universal satisfaction they have given our customers, and to the Dealers not now handling our line, we commend it to their favorable consideration.

CRESCENT STEEL RANGES are exceptionally beautiful in design, sanitary, perfect in operation and durable in construction and, due to their fire box and flue construction, are great fuel savers and quick bakers. There are many desirable features in CRESCENT STEEL RANGES. No effort has been spared to make them perfect in every respect. Upon close inspection it will be found that not the slightest detail has been overlooked.

Dimensions

Number	Oven	Square Top	Reservoir Top	Covers	Height to Top	Length of Wood	Collar
P-216	16 x 19 x 12	23 x 32	23 x 43	6-8 inch	32 inches	22 inches	7 inch
P-218	18 x 19 x 12	23 x 32	23 x 43	6-8 inch	32 inches	22 inches	7 inch

Detachable Copper Contact Reservoir, 8½ Gallon Capacity

Shown on Pages 88, 89, 90, 91, 92 and 93

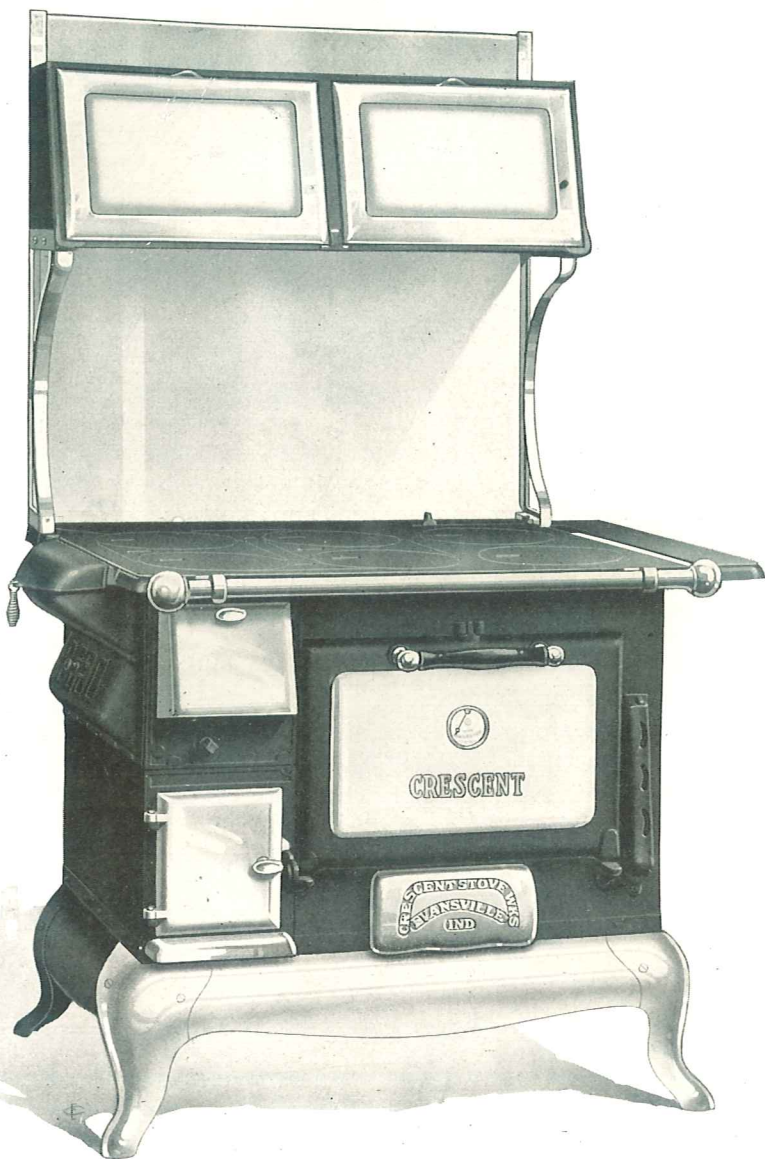

CRESCENT

Polished Steel Range. For Coal or Wood

Enamel Trimmed High Closet Style

Number	Oven	Weight	Code
P-216	16 x 19 x 12	275	Ambraid
P-218	18 x 19 x 12	285	Ambush

When Ordering Use Code Words

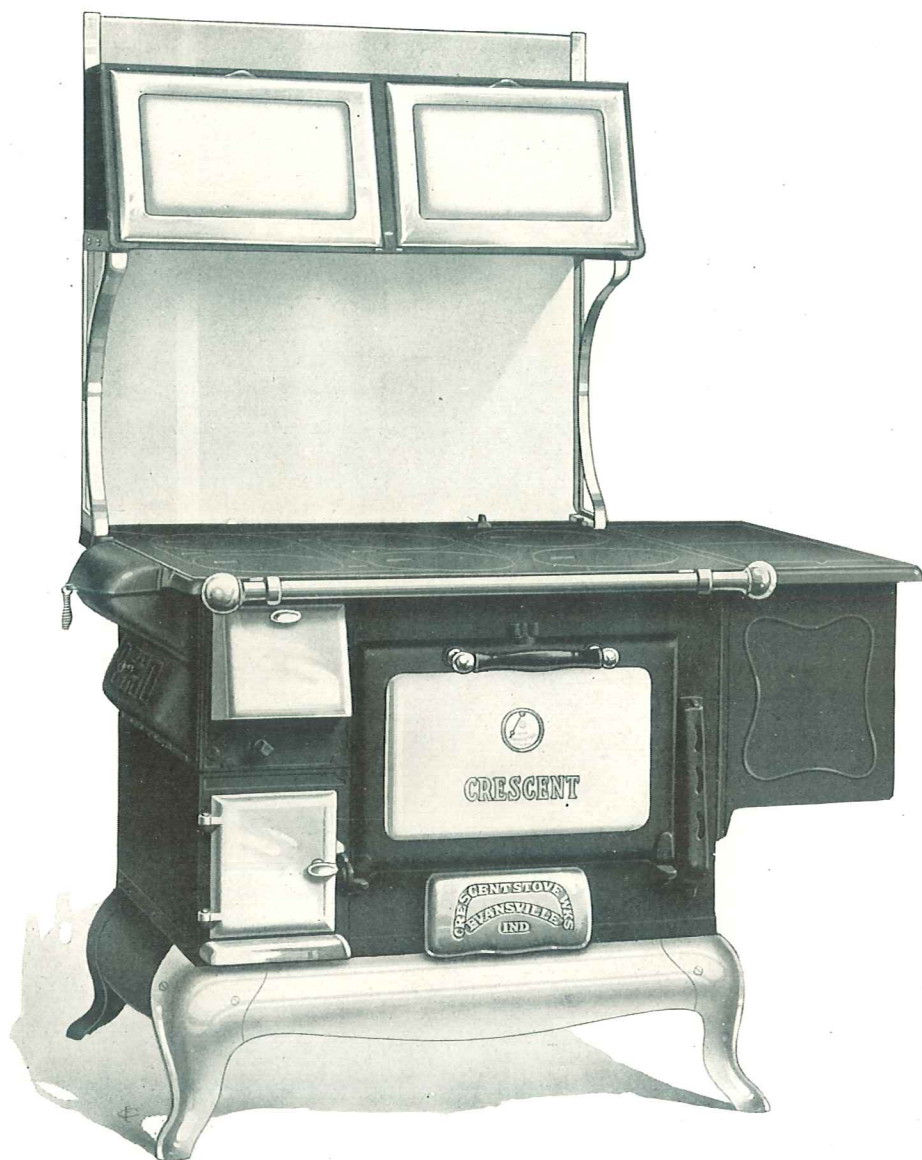

CRESCENT

Polished Steel Range. For Coal or Wood

Enamel Trimmed High Closet Style

Number

P-216

P-218

Oven

16 x 19 x 12

18 x 19 x 12

Weight

320

330

Code

Amend

Amiable

Description and Dimensions, Pages 86 and 87

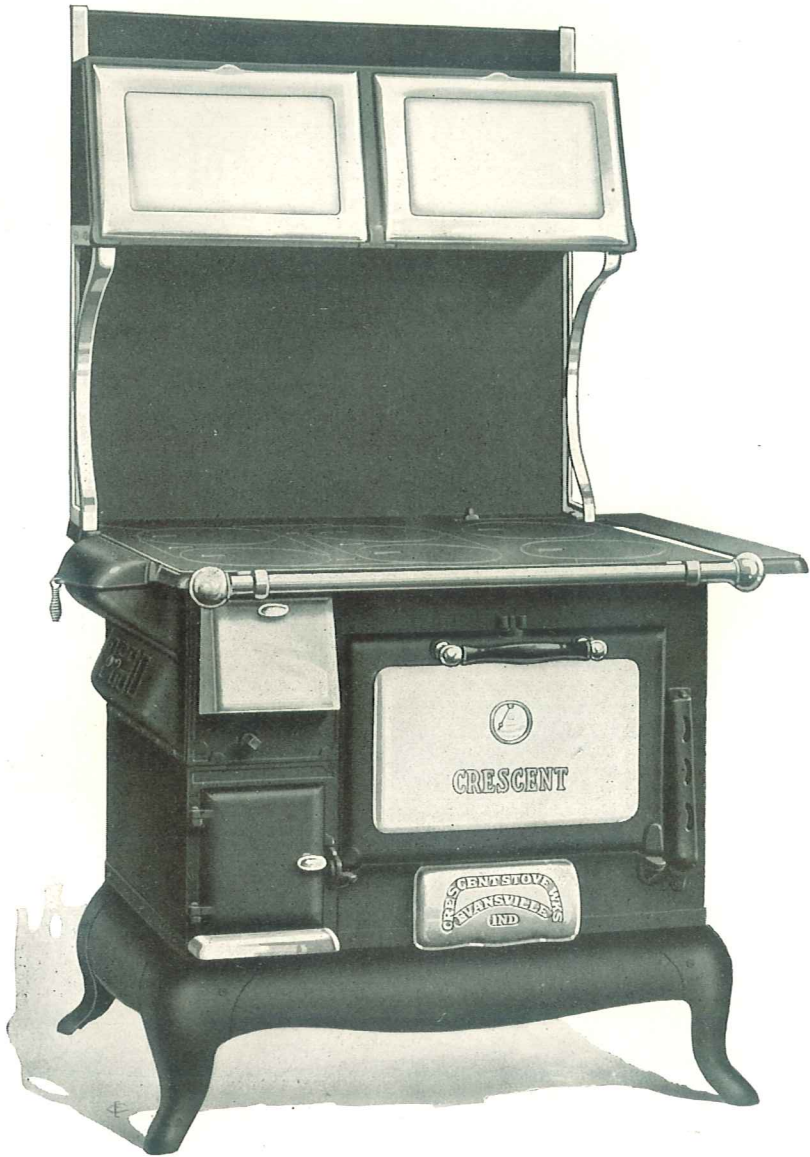

CRESCENT

Polished Steel Range. For Coal or Wood
Nickel Trimmed High Closet Style

Number	Oven	Weight	Code
P-216	16 x 19 x 12	275	Amid
P-218	18 x 19 x 12	285	Amiss

Description and Dimensions, Pages 86 and 87

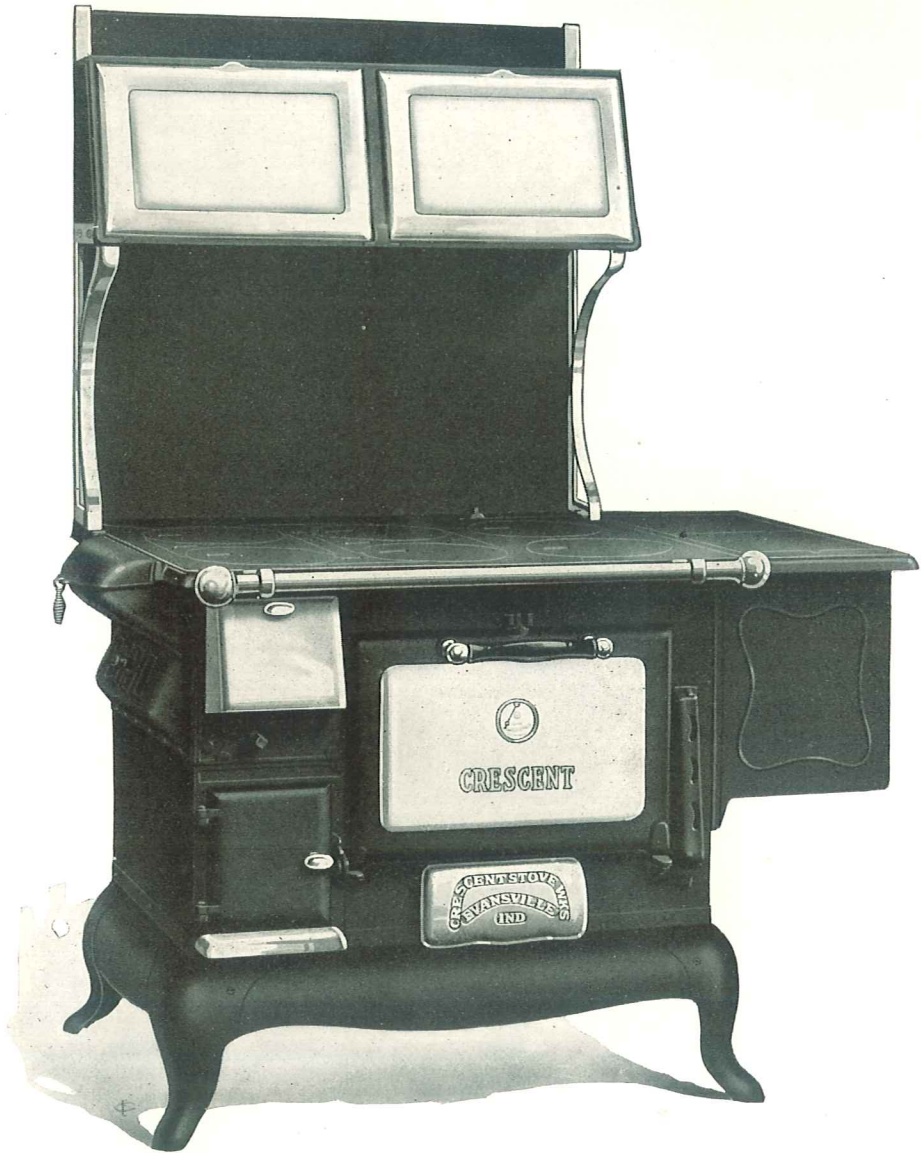

CRESCENT

Polished Steel Range. For Coal or Wood
 Nickel Trimmed High Closet Style

Number	Oven	Weight	Code
P-216	16 x 19 x 12	320	Amity
P-218	18 x 19 x 12	330	Ammon

When Ordering Use Code Words



CRESCENT

Polished Steel Range. For Coal or Wood

Plain High Closet Style

Number	Oven	Weight	Code
P-216	16 x 19 x 12	275	Amour
P-218	18 x 19 x 12	285	Amphi

Description and Dimensions, Pages 86 and 87

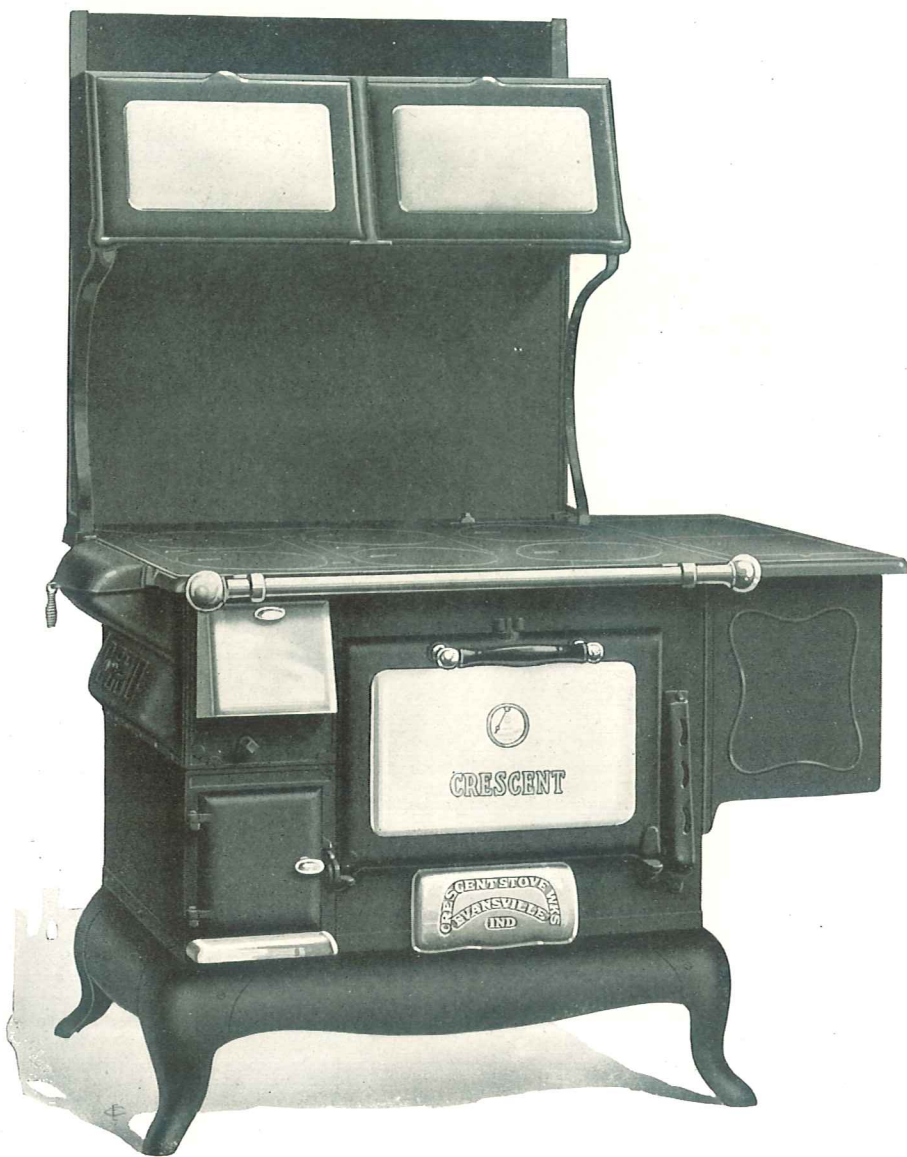

CRESCENT

Polished Steel Range. For Coal or Wood

Plain High Closet Style

Number	Oven	Weight	Code
P-216	16 x 19 x 12	320	Amos
P-218	18 x 19 x 12	330	Amulet

When Crdering Use Code Words

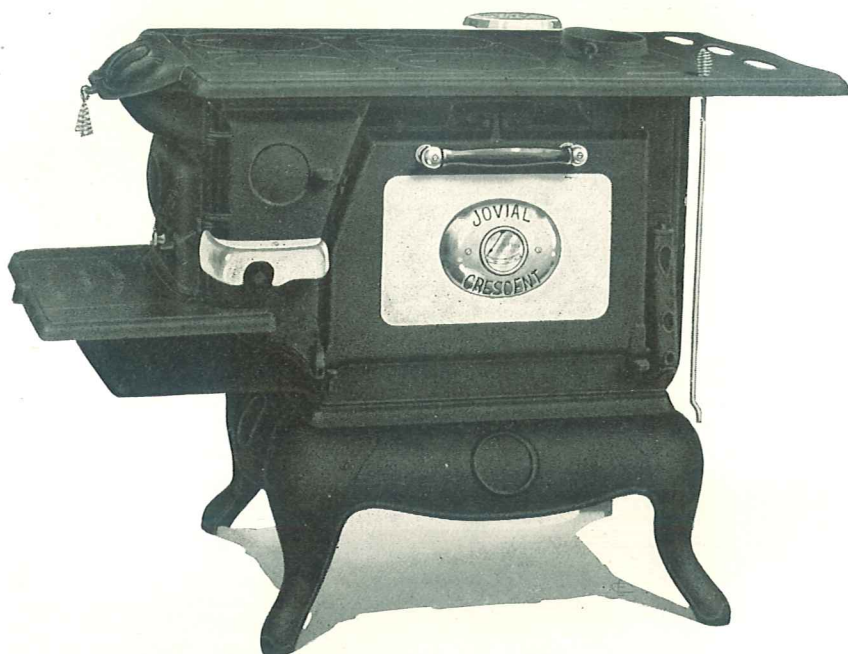

JOVIAL CRESCENT COOK

Duplex Grates for Coal or Wood

Number	Oven	Weight	Code
98-16	16 x 16 x 11	265	Astride
98-18	18 x 18 x 11½	290	Astringe
98-20	20 x 20 x 11½	310	Astro

Description and Dimensions Page 100

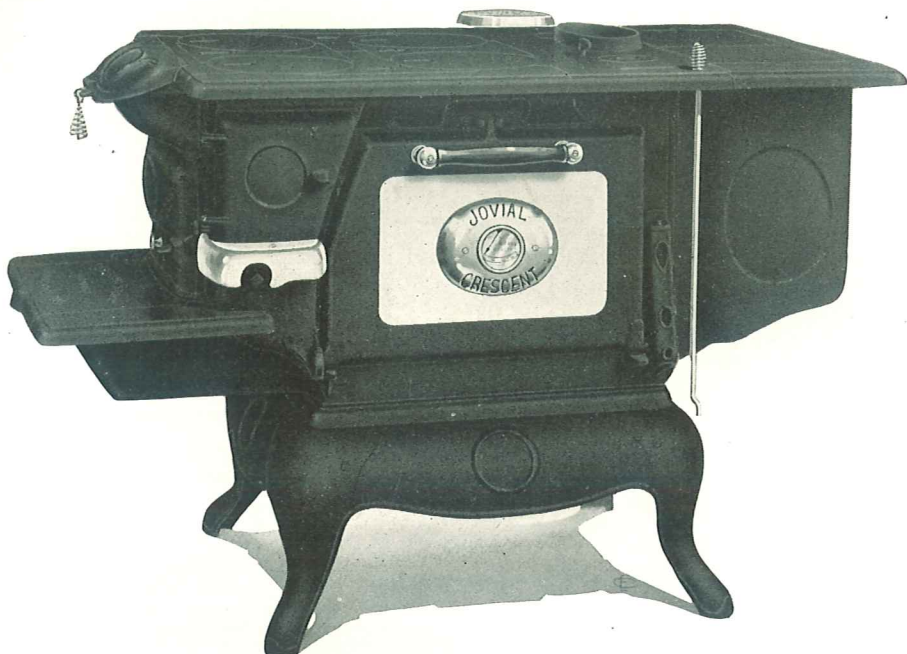

JOVIAL CRESCENT COOK

Duplex Grates for Coal or Wood

Number	Oven	Weight	Code
98-16	16 x 16 x 11	305	Astrut
98-18	18 x 18 x 11½	330	Astute
98-20	20 x 20 x 11½	350	Asur

When Ordering Use Code Words

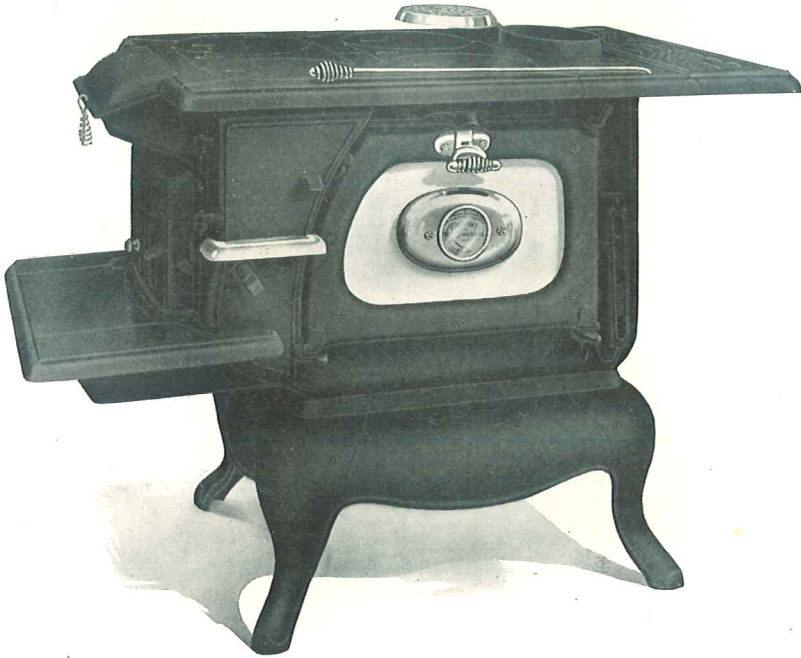

CRESCENT FALCON COOK

Duplex Grates for Coal or Wood

Number	Oven	Weight	Code
68-16	16 x 16 x 11½	250	Amole
68-18	18 x 18 x 11¼	275	Among
68-20	20 x 20 x 11½	300	Amount

Description and Dimensions, Page 100

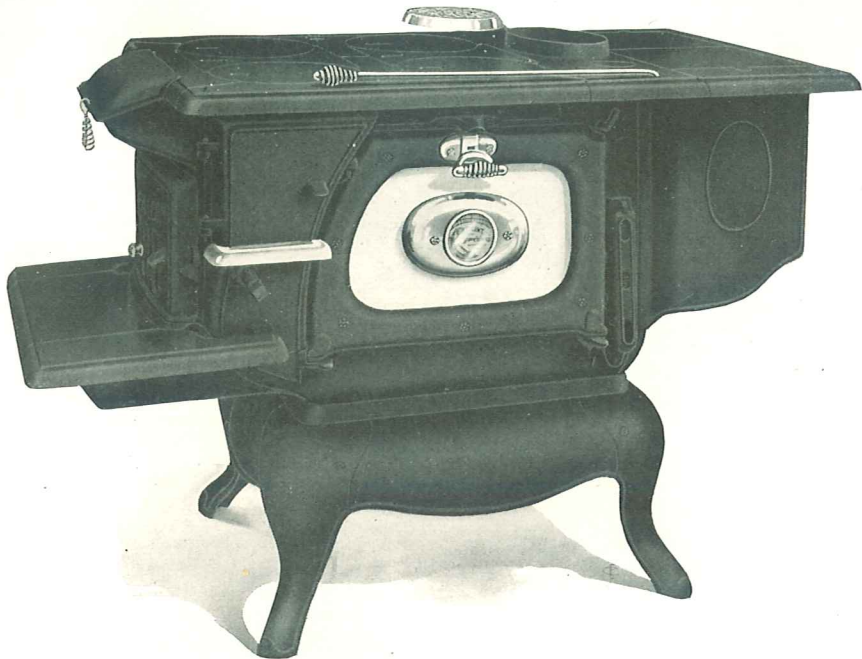

CRESCENT FALCON COOK

Duplex Grates for Coal or Wood

Number	Oven	Weight	Code
68-16	16 x 16 x 11 $\frac{1}{4}$	280	Ampere
68-18	18 x 18 x 11 $\frac{1}{4}$	305	Ample
68-20	20 x 20 x 11 $\frac{1}{2}$	330	Amuse

When Ordering Use Code Words

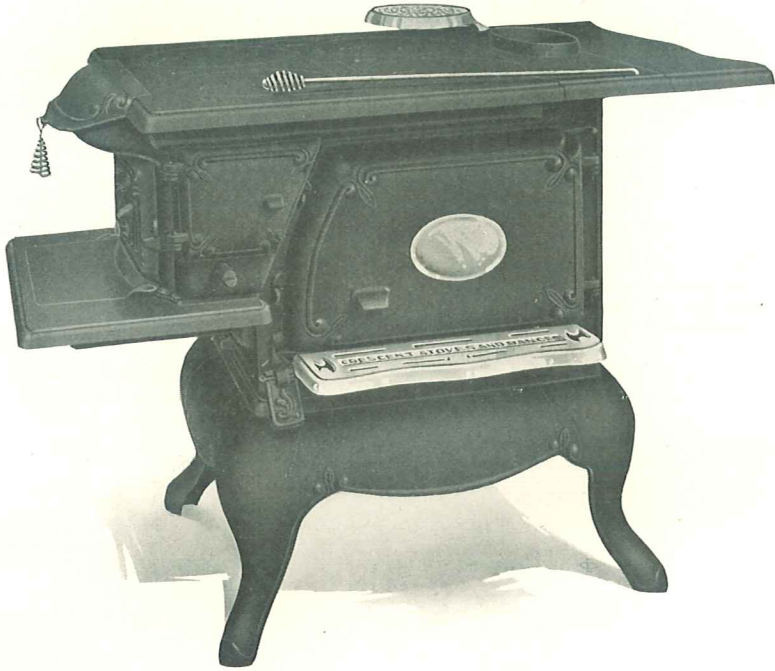

HOME CRESCENT COOK

Flat Dump Grate for Coal Only

Number	Oven	Weight	Code
8-155	14½ x 15 x 9	185	Anear
8-177	17 x 16½ x 9½	225	Anent

Description and Dimensions, Page 100

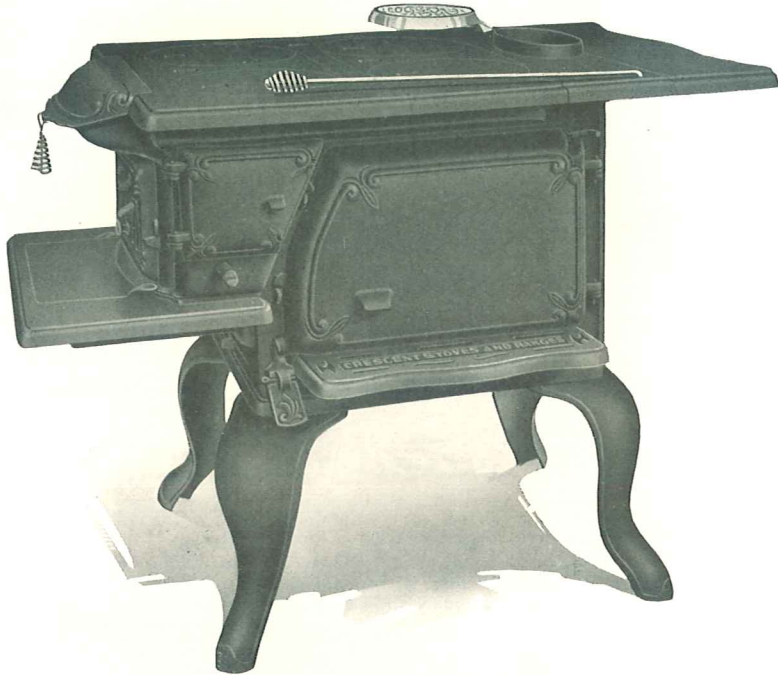

HOME CRESCENT COOK

Flat Dump Grate for Coal Only

Number	Oven	Weight	Code
8-155	14½ x 15 x 9	170	Anger
8-177	17 x 16½ x 9½	210	Angora

When Ordering Use Code Words



CRESCENT CAST COAL COOKS

DESCRIPTION



AND DIMENSIONS

JOVIAL CRESCENT COOK

No.	Oven	Square Top Less Shelf	Reservoir Top	Covers	Height to Top	Length Wood	Pipe Collar
88-16	16 x 16 x 11	23 x 28	23 x 38	4-8 inch	30 inches	19½ inches	7 inch
88-18	18 x 18 x 11½	25 x 30	25 x 41	4-8 inch	30½ inches	19½ inches	7-inch
88-20	20 x 20 x 11½	26½ x 32	26½ x 43	4-8 inch	30½ inches	19½ inches	7-inch

Detachable Copper Contact Reservoir, 7 Gallon Capacity

SHOWN ON PAGES 94 AND 95

FALCON CRESCENT COOK

68-16	16 x 16 x 11¼	24 x 28	24 x 37	4-8 inch	30 inches	19½ inches	6-inch
68-18	18 x 18 x 11¼	24 x 30	24 x 39	4-8 inch	30 inches	19½ inches	7-inch
68-20	20 x 20 x 11½	25½ x 32	25½ x 41	4-8 inch	30½ inches	19½ inches	7-inch

Detachable Copper Contact Reservoir, 5 Gallon Capacity

SHOWN ON PAGES 96 AND 97

HOME CRESCENT COOK

8-155	14½ x 15 x 9	21 x 25½		4-8 inch	27 inches	15 inches	6 inch
8-177	17 x 16½ x 9½	23 x 25½	23 x 36	4-8 inch	27½ inches	17 inches	6-inch

SHOWN ON PAGES 98 AND 99



CRESCENT CAST WOOD COOKS

DESCRIPTION



AND DIMENSIONS

JOVIAL CRESCENT COOK

No.	Oven	Square Top Less Shelf	Reservoir Top	Covers	Height to Top	Lgth Wood Pipe	Collar
98-16	16 x 16 x 11	23 x 28	23 x 38	4-8 inch	30 inches	19½ inches	7-inch
98-18	18 x 18 x 11½	25 x 30	25 x 41	4-8 inch	30½ inches	19½ inches	7-inch
98-20	20 x 20 x 11½	26½ x 32	26½ x 43	4-8 inch	30½ inches	19½ inches	7-inch

Detachable Copper Contact Reservoir, 7 Gallon Capacity

SHOWN ON PAGES 102 AND 103

FALCON CRESCENT COOK

78-16	16 x 16 x 11¼	24 x 28	24 x 37	4-8 inch	30 inches	19½ inches	6-inch
78-18	18 x 18 x 11¼	24 x 30	24 x 39	4-8 inch	30 inches	19½ inches	7-inch
78-20	20 x 20 x 11¼	25½ x 32	25½ x 41	4-8 inch	30½ inches	19½ inches	7-inch

Detachable Copper Contact Reservoir, 5 Gallon Capacity

SHOWN ON PAGES 104 AND 105

DANDY CRESCENT COOK

8-155	14½ x 15 x 9	21 x 25½		4-8 inch	27 inches	15 inches	6-inch
8-177	17 x 16½ x 9½	23 x 25½	23 x 36	4-8 inch	27½ inches	17 inches	6-inch
8-199	19 x 18½ x 10½	24 x 28½	24 x 39	4-8 inch	28½ inches	19 inches	6-inch

SHOWN ON PAGES 106 AND 107

JUNIOR CRESCENT COOK

7-A	14½ x 15 x 9	21 x 25½		4-7 inch	27 inches	15 inches	6-inch
-----	--------------	----------	--	----------	-----------	-----------	--------

SHOWN ON PAGE 108

When Ordering Use Code Words



JOVIAL CRESCENT COOK

Basket Grate for Wood Only

Number	Oven	Weight	Code
88-16	16 x 16 x 11	245	Atabal
88-18	18 x 18 x 11½	275	Ataunt
88-20	20 x 20 x 11½	305	Atavic

Description and Dimensions, Page 101

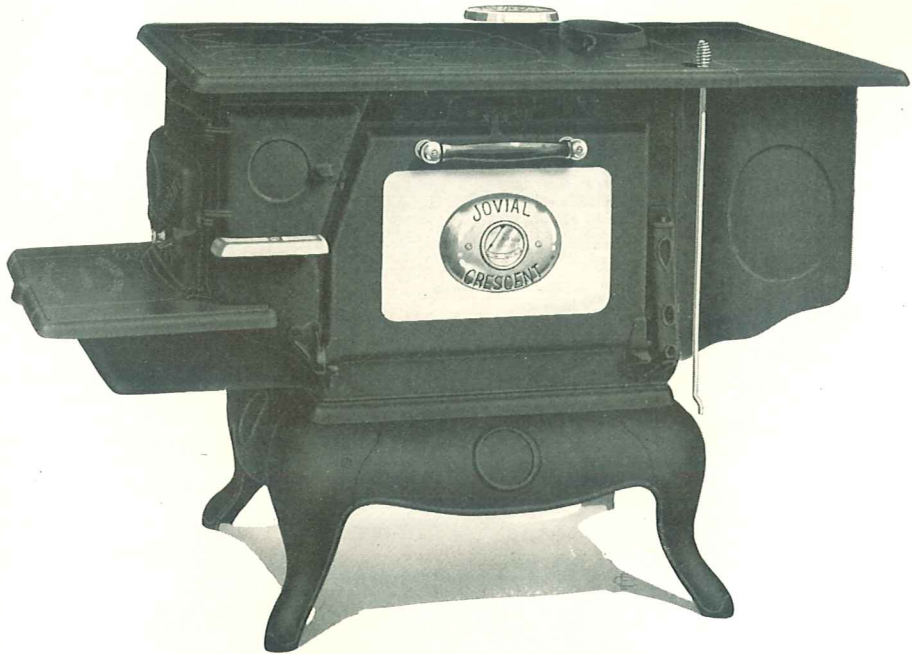

JOVIAL CRESCENT COOK

Basket Grate for Wood Only

Number	Oven	Weight	Code
88-16	16 x 16 x 11	285	Atempo
88-18	18 x 18 x 11½	315	Athena
88-20	20 x 20 x 11½	345	Athirst

When Ordering Use Code Words



CRESCENT FALCON COOK

Basket Grate for Wood Only

Number	Oven	Weight	Code
78-16	16 x 16 x 11¼	235	Anabas
78-18	18 x 18 x 11¼	260	Anadem
78-20	20 x 20 x 11½	285	Anchor

Description and Dimensions, Page 101

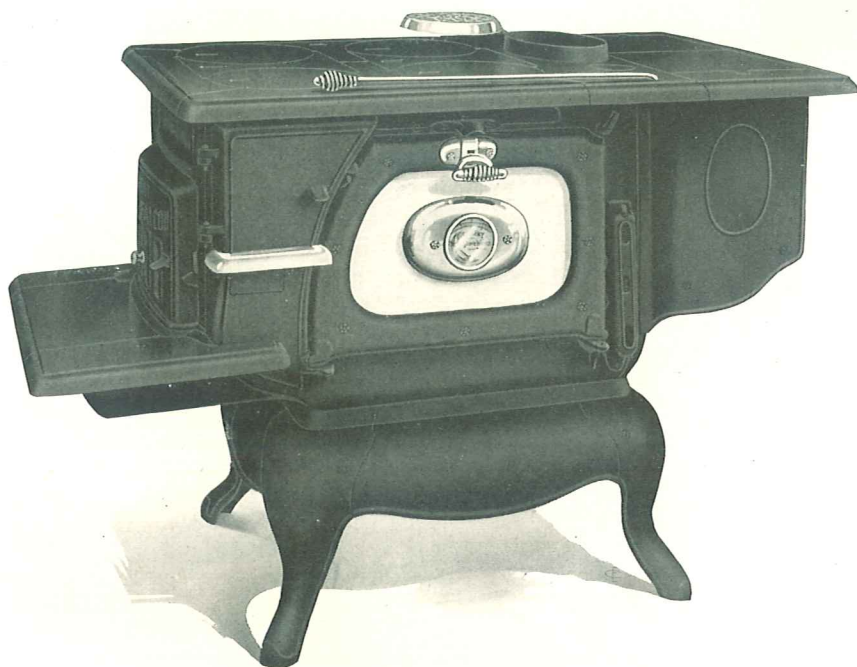

CRESCENT FALCON COOK

Basket Grate for Wood Only

Number	Oven	Weight	Code
78-16	16 x 16 x 11¼	265	Ancient
78-18	18 x 18 x 11¼	290	Ancon
78-20	20 x 20 x 11½	315	Androus

When Ordering Use Code Words

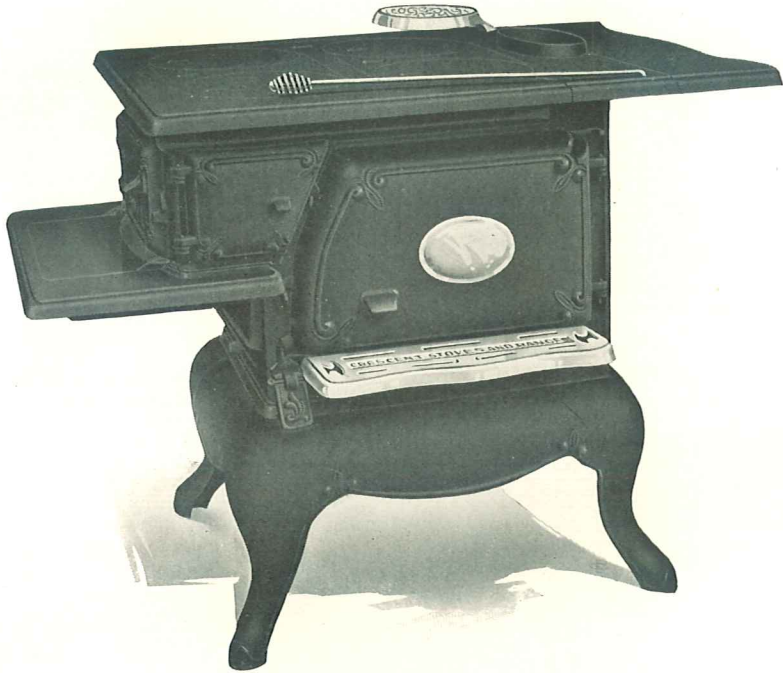

DANDY CRESCENT COOK

Basket Grate for Wood Only

Number	Oven	Weight	Code
8-155	14½ x 15 x 9	170	Aniline
8-177	17 x 16½ x 9½	200	Animus
8-199	19 x 18½ x 10½	220	Anise

Description and Dimensions, Page 101

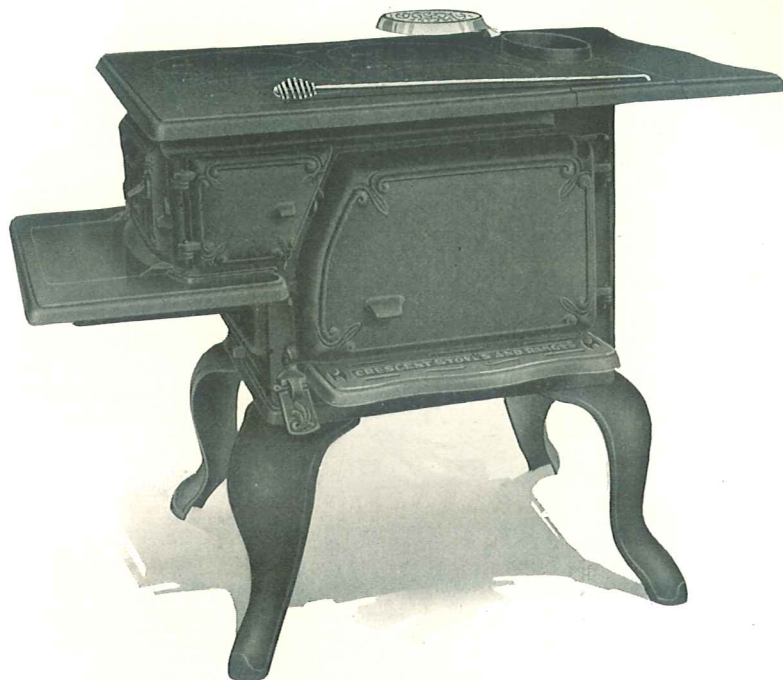

DANDY CRESCENT COOK

Basket Grate for Wood Only

Number	Oven	Weight	Code
8-155	14½ x 15 x 9	155	Anlace
8-177	17 x 16½ x 9½	185	Anneal
8-199	19 x 18½ x 10½	205	Annex

When Ordering Use Code Words



JUNIOR CRESCENT COOK

Basket Grate for Wood Only

Number	Oven	Weight	Code
7-A	14½ x 15 x 9	140	Annoy

Description and Dimensions, Page 101



THE CRESCENT RADI-HEATER

ELEGANTLY
PROPORTIONED



PERFECT
IN OPERATION

No longer need your customers be worried over the problem of adequately heating their homes, or be bothered by constantly having to tend fires or fireplaces—with only a minimum degree of comfort for all their trouble.

This is an important announcement—it is the answer to your problem of efficient and economical heating of a home. The **CRESCENT RADI-HEATER** combines the best features of modern stove construction. In the **CRESCENT RADI-HEATER** are found many unusual improvements not found in other stoves.

Your customers will appreciate the practical, clean, “easy to tend” **CRESCENT RADI-HEATER**. It throws out large volumes of pure, warm air and insures solid comfort during even the coldest weather.

POSITIVELY HOLDS FIRE 48 HOURS

TOP Large Urn Swinging Top of pleasing design. Pipe collar with draft slide. Eight inch cover lid on top.

DRUM Outside drum rests in a slot at top of fire bowl and is not bolted—this allows the fire bowl to expand and contract which eliminates all warping of the steel drum.

DOORS Large double door. Flat surfaces especially ground to absolute accuracy which guarantees a fitting that is positively air tight. Poker hole in center of door.

FINISH The finish of the **CRESCENT RADI-HEATER** is unusually beautiful. All nickel parts are copper coated before being nickel plated—this insures their luster for the life of the stove.

A Heater You Will Be Proud Of

On the following pages you will find a detailed description of the **CRESCENT RADI-HEATER**

Lovely of line, perfectly finished, attractive from top to bottom—you will give the **CRESCENT RADI-HEATER** the place of honor in your home. Wholly in keeping with your home furnishings; designed with splendid taste—it combines unusual beauty with unusual service.

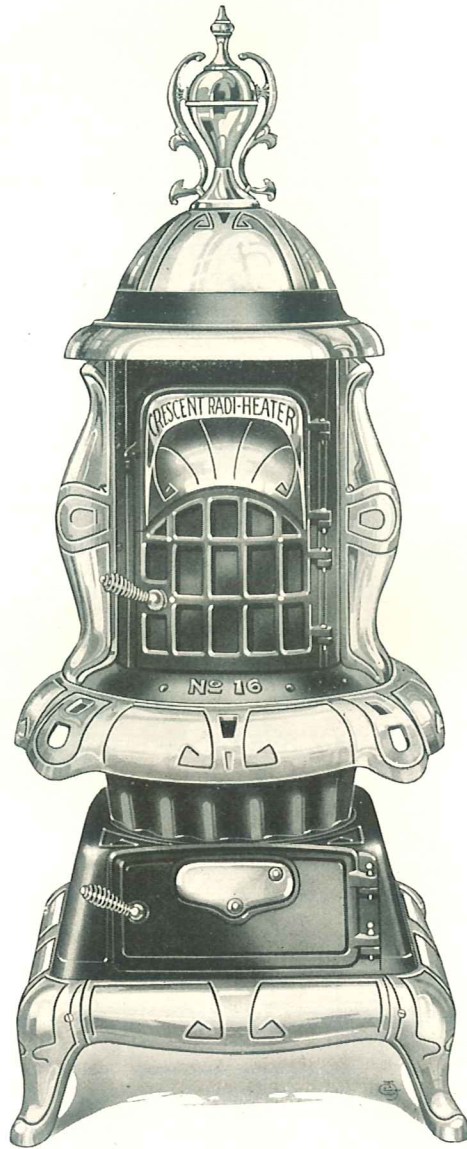

CRESCENT RADI-HEATER

Number	Fire Pot	Height	Weight	Code
16	16 in.	66 in.	360	Apollo
18	18 in.	68 in.	400	Apparel

Convenience and efficiency are combined in the Crescent Radi-Heater. Considering the splendid workmanship, high grade materials, superior construction, and beautiful finish—there is no better Heater to be had. This in addition to the big savings in coal insures the GREATEST VALUE, dollar for dollar, in the Crescent Radi-Heater.

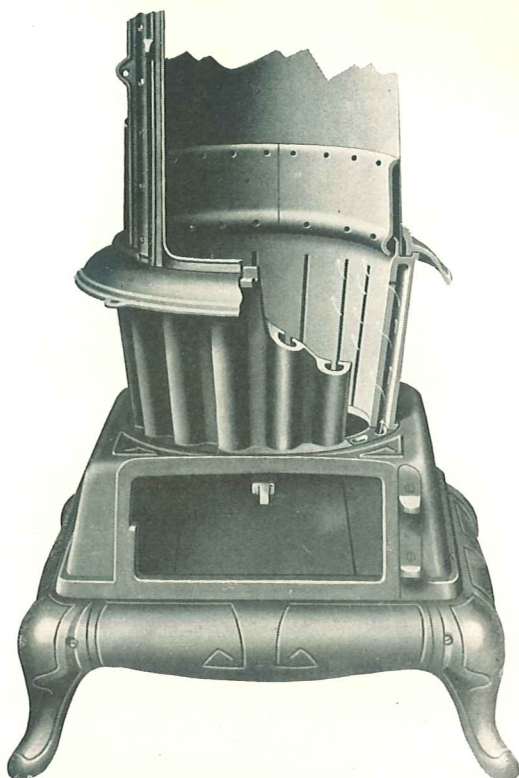

ABOVE IS A SECTIONAL VIEW SHOWING THE SOUNDNESS OF CONSTRUCTION OF THE CRESCENT RADI-HEATER

We invite special attention to the above explanation of the passage of the cold air through the slots in the fire bowl. This construction causes the cold air entering through the ash pit to flow evenly around the inside of the fire bowl, as well as in the center, causing even distribution of combustion in the fire pot.

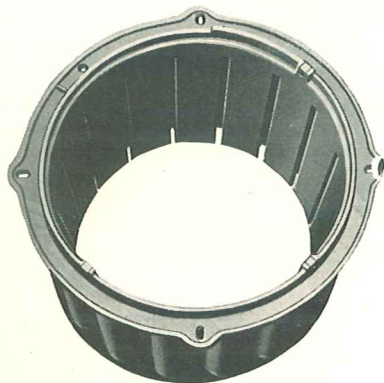

**Fire Bowl of Crescent Radi-Heater is
GUARANTEED 10 YEARS**

Such a guarantee as this has never before been offered by any stove manufacturer—but we make it readily because we know the high quality of the materials and workmanship in the Crescent Radi-Heater.

FIRE BOWL

The Twentieth Century Fire Bowl of the Crescent Radi-Heater is the most important advance in stove construction that has been made in many years. Our 10 year guarantee is the best indication of the service you will receive.



NEW CRESCENT OAK

For Hard or Soft Coal. Nickered on Base

Number	Fire Pot	Height with Urn	Weight	Collar	Code
14	14 inches	53½ inches	170	6-inch	Annul
16	16 inches	56½ inches	210	6-inch	Anode
18	18 inches	59½ inches	230	6-inch	Anoint

Hard Coal Magazine for Numbers 16 and 18. Heavy polished Oak Stove Body Steel. Double Fire Bowl Ring, Center Draw and Shaking Grate. Nickered parts hang loose. Ash Pan with each size. ELABORATELY NICKEL TRIMMED.

CAST IRON JACKETS FURNISHED ON NUMBERS 16 AND 18 WHEN WANTED.



NEW CRESCENT OAK

For Hard or Soft Coal. Plain

Number	Fire Pot	Height with Urn	Weight	Collar	Code
13	12 inches	47 inches	125	6-inch	Anon
15	14 inches	50 inches	150	6-inch	Anther
17	16 inches	55 inches	175	6-inch	Antic
19	18 inches	58 inches	215	6-inch	Antique

Hard Coal Magazine for Numbers 17 and 19. Heavy polished Oak Stove Body Steel. Double Fire Bowl Ring, Center Draw and Shaking Grate. Nickered parts hang loose. Ash Pan with each size. A HEAVY AND SUBSTANTIAL HEATER.

CAST IRON JACKET FURNISHED ON NUMBERS 17 AND 19 WHEN WANTED.



LIBERTY CRESCENT OAK

For Hard or Soft Coal. Nickered on Base

Number	Fire Pot	Height with Urn	Weight	Collar	Code
14	13 inches	48 inches	110	6-inch	Antler
16	15 inches	51 inches	140	6-inch	Anvil

Heavy polished Oak Stove Body Steel. Center Draw and Shaking Grate. Nickered parts hang loose. Large Feed Door and Ash Pit Door. Ash Pan with each size.



LIBERTY CRESCENT OAK

For Hard or Soft Coal. Plain

Number	Fire Pot	Height with Urn	Weight	Collar	Code
11	10½ inches	43½ inches	60	6-inch	Anxious
13	11½ inches	46½ inches	75	6-inch	Aorist
15	13 inches	43 inches	95	6-inch	Apache
17	15 inches	51 inches	125	6-inch	Apart

Heavy polished Oak Stove Body Steel. Center Draw and Shaking Grate. Large Feed Door and Ash Pit Door. Ash Pan with each size.

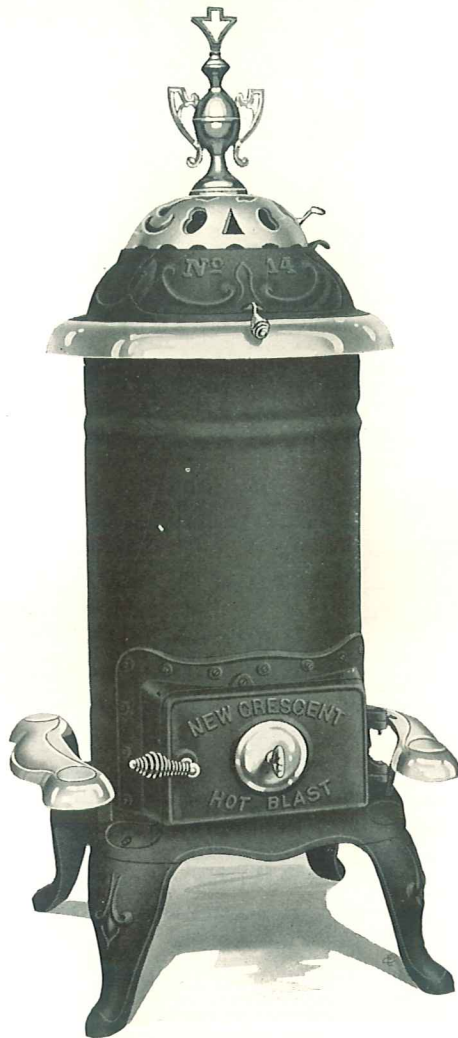

NEW CRESCENT HOT BLAST

For Hard or Soft Coal

Number	Fire Pot	Height with Urn	Weight	Collar	Code
12	12 inches	46 inches	105	6-inch	Apex
14	14 inches	48 inches	130	6-inch	Aphonic
16	16 inches	52 inches	170	6-inch	Apian
18	18 inches	55 inches	205	6-inch	Aplite

Extra heavy blue polished Steel Body. Solid Cast Linings above Fire Bowl. Shake and Draw Center Grate. Cast Bottom. Reversible Pipe Collar. Large Ash Pan. Loose Foot Rails. Large Pouch Feed Opening. Burns any grade of soft coal. Will hold fire for 36 hours or more without any attention.



VICTOR CANNON

For Hard or Soft Coal

Number	Fire Pot	Height	Weight	Collar	Code
116	14 inches	36 inches	140	6-inch	Applaud
118	16½ inches	41 inches	225	6-inch	Apply

Large Ash Pit and Feed Door. Center Draw and Shaking Grate. Fluted Fire Bowl.

DRUM FURNISHED WITH ANY SIZE

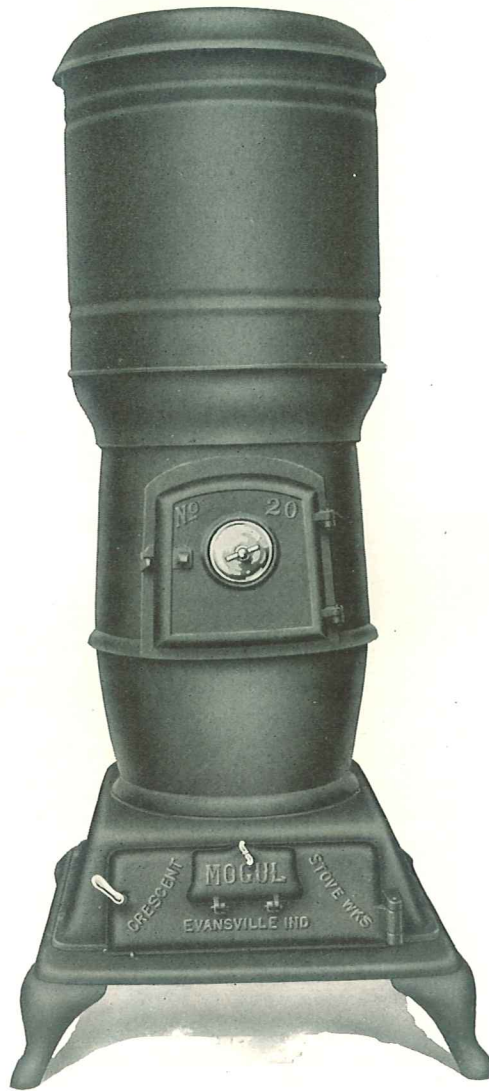

MOGUL CANNON

With Drum. For Hard or Soft Coal

Number	Fire Pot	Height	Weight	Collar	Code
20	20 inches	69 inches	500	7-inch	Appeal

Made in Six Sections, No Bolts, Can Be Easily Dismounted.



MOGUL CANNON

For Hard or Soft Coal

Number	Fire Pot	Height	Weight	Collar	Code
20	20 inches	49 inches	485	7-inch	Append

A very large, heavy and substantial Cannon Stove. Ball bearing center draw and shaking grate. Extra heavy fire bowl, large feed door. Check plate in top.



STAR CANNON
For Hard or Soft Coal

Number	Fire Pot	Height	Weight	Collar	Code
10	9¼ inches	23 inches	60	6-inch	Appoint
11	10½ inches	25 inches	65	6-inch	Apprise
12	11½ inches	27 inches	80	6-inch	Approve
13	12½ inches	30 inches	95	6-inch	Apricot

FLUTED FIRE BOWL. DUMP AND SHAKING GRATE.



TEXAS BOX STOVE

For Wood Only

Number	Height	Length Wood	Cook Holes	Weight	Collar	Code
18	20 inches	18 inches	One 7-inch	60	6-inch	Arise
22	20 inches	22 inches	One 7-inch	70	6-inch	Armor
25	22 inches	25 inches	Two 7-inch	90	6-inch	Arrica
30	23 inches	30 inches	Two 8-inch	115	6-inch	Arose
34	24 inches	34 inches	Two 8-inch	135	6-inch	Array
36	26 inches	36 inches	Two 8-inch	160	6-inch	Arrest

A heavy substantial Box Stove, full measurements, rods on outside, swing top, large ash pit and feed door. Numbers 34 and 36 have cut sides.



CRESCENT KING

For Wood Only. Nickerled

Number	Height with Urn	Length Wood	Cooking Holes	Weight	Collar	Code
118	33 inches	18 inches	One 7-inch	70	6-inch	Apron
122	35 inches	22 inches	One 7-inch	85	6-inch	Apsis
125	37 inches	25 inches	Two 7-inch	90	6-inch	Aquila

Heavy Polished Blue Steel Body, Cast Bottom, Nickerled Swing Top, Loose Nickerled Foot Rails, Bolted Legs, Large Feed Door.

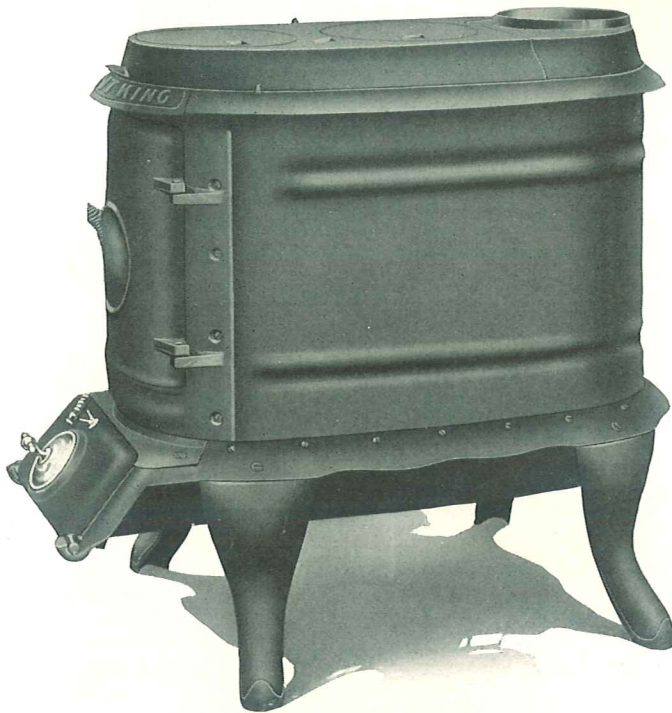

CRESCENT KING
For Wood Only. Plain

Number	Height	Length Wood	Cooking Holes	Weight	Collar	Code
118	23 inches	18 inches	One 7-inch	65	6-inch	Arabic
122	25 inches	22 inches	One 7-inch	80	6-inch	Arbiter
125	27 inches	25 inches	Two 7-inch	85	6-inch	Arbor

Heavy Polished Blue Steel Body, Cast Bottom, Swing Top, Bolted Legs, Large Feed Door.



CRESCENT QUEEN

For Wood Only. Nickerled

Number	Height with Urn	Length Wood	Cooking Holes	Weight	Collar	Code
118	31 inches	18 inches	One 7-inch	65	6-inch	Arcade
122	33 inches	22 inches	One 7-inch	75	6-inch	Archer
125	35 inches	25 inches	Two 7-inch	80	6-inch	Arctic

Heavy Polished Blue Steel Body, cast bottom, nickerled swing top, loose nickerled foot rails. Bolted legs, large wood feed opening in top.



CRESCENT QUEEN

For Wood Only. Plain

Number	Height	Length Wood	Cooking Holes	Weight	Collar	Code
118	21 inches	18 inches	One 7-inch	60	6-inch	Ardent
122	23 inches	22 inches	One 7-inch	70	6-inch	Areal
125	25 inches	25 inches	Two 7-inch	75	6-inch	Arena

Heavy Polished Blue Steel Body, Cast Bottom, Swing Top, Bolted Legs,
Large Wood Feed Opening on Top.



STAR AIRTIGHT HEATER

Blue Steel Body. Steel Lined

Number	Length Wood	Height with Urn	Shipping Weight	Collar	Code
18	16 inches	25 inches	15	6-inch	Argent
22	20 inches	31 inches	25	6-inch	Argol
26	24 inches	37 inches	30	6-inch	Argus

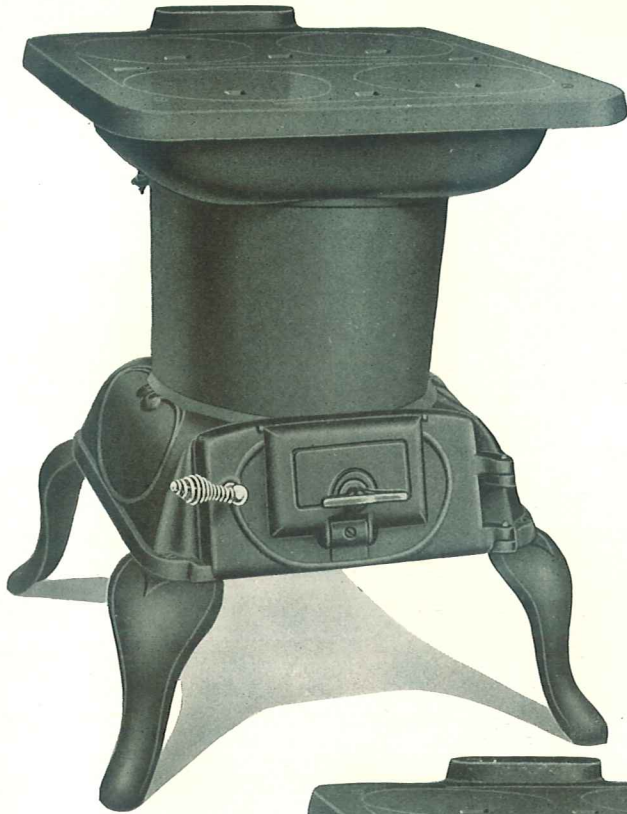

**SELECT HOT WATER
LAUNDRY**

For Hard or Soft Coal

Number—AS-18

Height—27 inches

Top—22 x 22 inches

Cooking Holes — Four 8-
inch

Net Weight—165 lbs.

Collar—6-inch

Code—Arroba

Hollow fire bowl, has wonderful water heating capacity, for use with pressure boiler. Large top, cast bottom, check plate in top. Heats all covers alike.

Recommended where a good supply of water is wanted and for all laundry purposes.

SELECT LAUNDRY

For Hard or Soft Coal

Number—S-18

Height—25 inches

Top—22 x 22 inches

Cooking Holes—Four
8-inch

Net Weight—120 lbs.

Collar—6-inch

Code—Arrow

A heavy substantial Laundry Stove, large top and fire bowl. Center draw and shaking grate, cast bottom, check plate in top. Heats all covers alike.



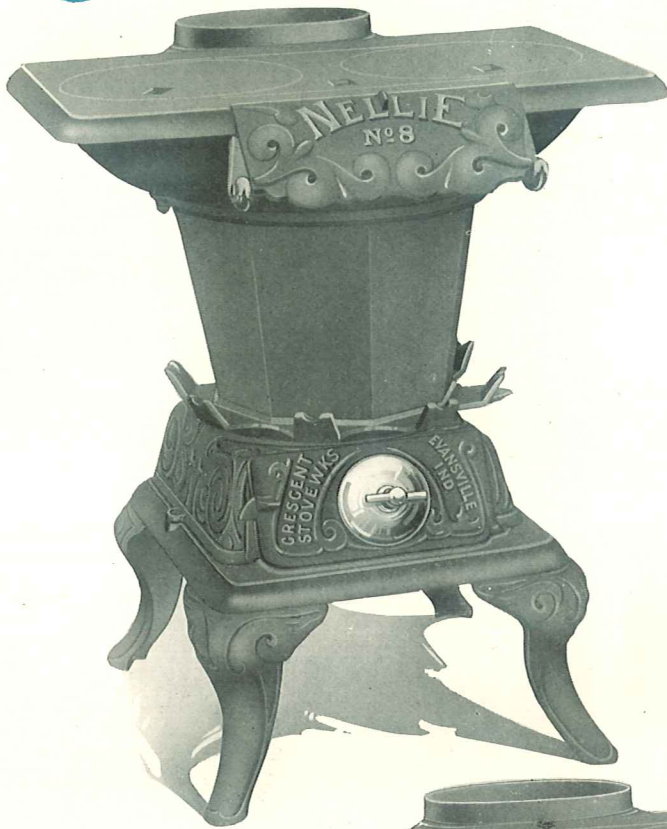

NELLIE LAUNDRY

For Hard or Soft Coal

Number—8

Height—24 inches

Top—13½ x 20 inches

Cooking Holes—Two
8-inch

Net Weight—70 lbs.

Collar—6-inch

Code—Arsenal

Irons heated by direct contact with fire bowl. Will heat eight irons. Cast Iron Bottom. Top will accommodate 8-inch wash boiler.

CLYDE LAUNDRY

For Hard or Soft Coal

Number—8

Height—28 inches

Top—13½ x 20 inches

Cooking Holes — Two 8-inch

Net Weight—65 lbs.

Collar—6-inch

Code—Artist

Cast Iron Bottom. Top will accommodate 8-inch wash boiler or eight sad irons.





CRESCENT 2-HOLE HOT WATER LAUNDRY

For Hard or Soft Coal

Number—188

Height—25 inches

Top—11½ x 21 inches

Cooking Holes—Two 8-inch

Net Weight—135 lbs.

Collar—6-inch

Code—Arval

Cast Iron Bottom. Top will accommodate 8-inch wash boiler or eight sad irons.

Steel or Cast Range (REPAIRS IN DETAIL)

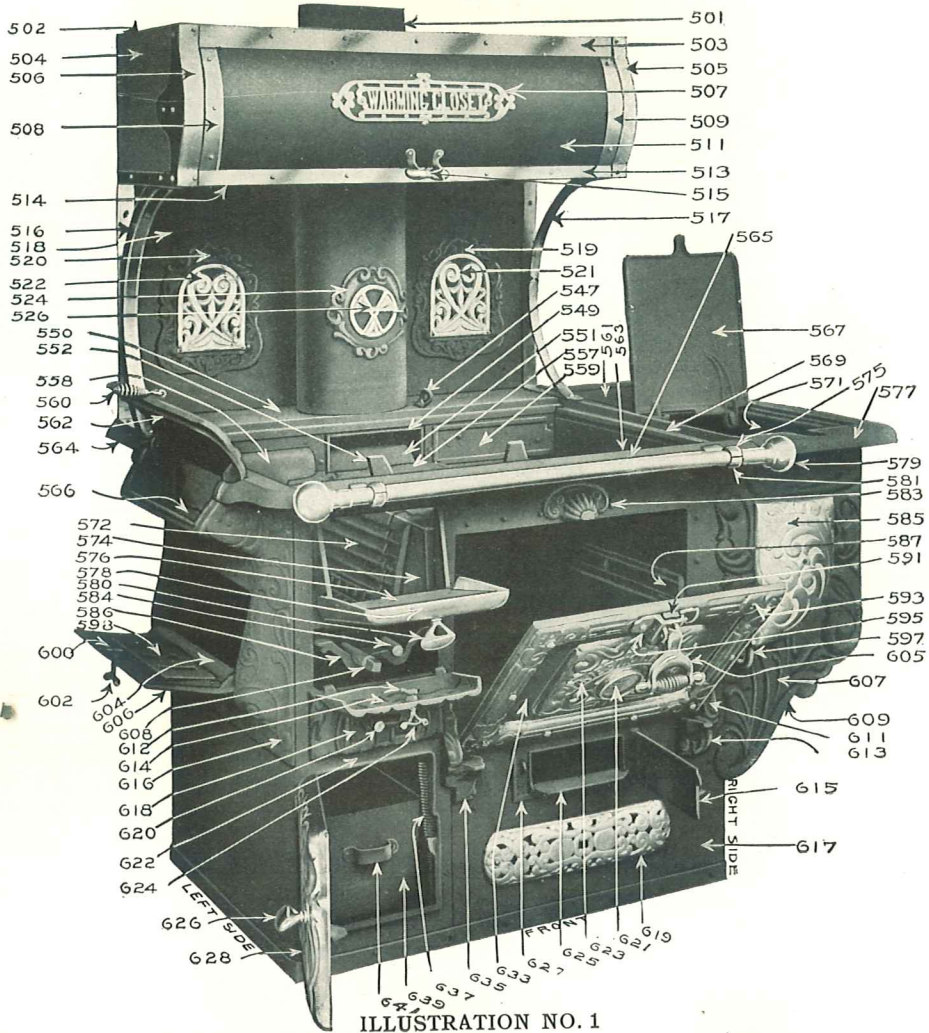

ILLUSTRATION NO. 1

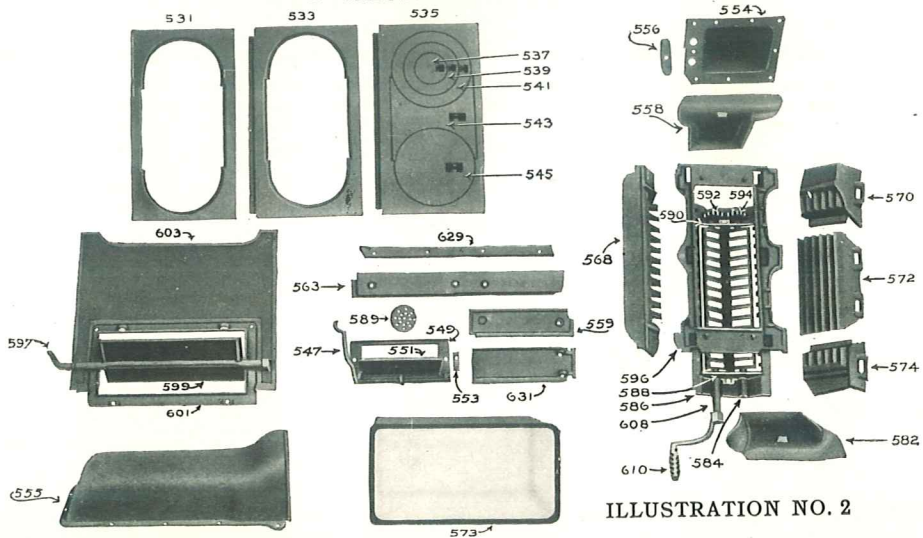

ILLUSTRATION NO. 2

Steel or Cast Range

REPAIRS IN DETAIL

Repair No.	Name of Repair	Illustration No.	Repair No.	Name of Repair	Illustration No.
501	Warming closet collar joint of pipe	1	573	Copper reservoir tank	2
502	Warming closet steel top plate*	1	574	Front section of right fire lining	1 & 2
503	Warming closet nickeled top band	1	575	Top clamp for tube towel bar	1
504	Warming closet steel left side plate	1	576	Front feed door lining	1
505	Warming closet right side corner plate	1	577	Reservoir top frame	1
506	Warming closet left side corner plate	1	578	Front feed door	1
507	Warming closet door panel	1	579	Tube towel bar	1
508	Warming closet left hinge strip	1	580	Front feed door handle	1
509	Warming closet right hinge strip	1	581	Bottom clamp for tube towel bar	1
511	Warming closet door (steel)	1	582	Front end lining	2
513	Warming closet nickeled bottom band	1	583	Oven door latch catch	1
514	Warming closet steel bottom plate*	1	584	Short shank section of duplex grate	1 & 2
515	Warming closet door handle	1	585	Reservoir panel	1
516	Warming closet left side bracket	1	586	Grate rest	1 & 2
517	Warming closet right side bracket	1	587	Right inside oven shelf rest	1
518	Warming closet steel back	1	588	Front duplex grate yoke (See also 590)	2
519	Warming closet tea pot stand frame	1	589	Inside oven ventilator	2
520	Warming closet tea pot stand frame	1	590	Rear duplex grate yoke (See also 588)	2
521	Warming closet tea pot stand (only)	1	591	Oven door main latch (only)	1
522	Warming closet tea pot stand (only)	1	592	Long shank duplex grate cog	2
524	Pipe damper frame	1	593	Oven door frame	1
526	Pipe damper slide	1	594	Short shank duplex grate cog	2
531	Key plate without flange	2	595	Oven door latch case	1
533	Key plate with flange	2	596	Lining rest	2
535	Key plate with flange	2	597	Reservoir damper handle	1 & 2
537	Center cover of sectional cover	2	598	Left side draft door slide	1
539	Middle ring of sectional cover	2	599	Reservoir main damper	2
541	Outside ring of sectional cover	2	600	Latch for turnbuckle for left side draft door	1
543	Short center	2	601	Reservoir damper frame	2
545	Cover	2	602	Turnbuckle for left side draft door	1
547	Baking damper handle	1 & 2	603	Right side of stove for reservoir attachment	2
549	Baking damper frame	1 & 2	604	Left side draft door hinge	1
550	Collar top	1	605	Oven door handle	1
551	Main baking damper	1 & 2	606	Left side draft door	1
552	Center rest	1	607	Front outside casing of reservoir	1
553	Baking damper clamp	2	608	Long shank section of duplex grate	1 & 2
554	Extension fire box	2	609	Extreme bottom of reservoir*	1
555	Smoke box	2	610	Grate crank	2
556	Extension fire box cap	2	611	Top section of right oven door hinge	1
557	Top oven plate	1	612	Latch for turnbuckle for front grate door	1
558	Rear end lining	1 & 2	613	Bottom section of right oven door hinge	1
559	Rear body protecting strip	1 & 2	614	Front grate door	1
560	Wire drop knob	1	615	Clean out door	1
561	Rear reservoir cover	1	616	Left side frame	1
562	Pouch feed door	1	617	Front of steel body	1
563	Front body protecting strip (Position indicated in No. 1)	2	618	Front grate door slide	1
564	Left side top	1	619	Front bottom panel	1
565	Front top	1	620	Slide knob for front grate door	1
566	In some ranges this casting is separate and is called "pouch feed lining", while in other ranges the left fire lining (Illustration No. 568) extends up into the pouch and the extra "pouch feed lining" is omitted	1	621	Oven thermometer	1
567	Front reservoir cover	1	622	Front frame	1
568	Left fire lining	2	623	Oven door panel	1
569	Right side top (State whether stove has reservoir or not)	1	624	Turnbuckle for front grate door	1
570	Rear section of right fire lining	2	625	Inside clean out door	1
571	Right outside casing of reservoir (When reservoir tank is removed)	1	626	Ash pit door handle	1
572	Middle section of right fire lining	1 & 2	627	Clean out door frame	1
			628	Ash pit door	1
			629	Bottom oven brace	2
			631	Bottom flue strip	2
			633	Steel lining for oven door	1
			635	Left oven door hinge	1
			637	Oven door spring	1
			639	Ash pan	1
			641	Ash pan handle	1

* Position indicated by arrow, but casting cannot be seen.

IF REPAIR IS WANTED FOR A FULL ENAMELED RANGE, STATE COLOR.

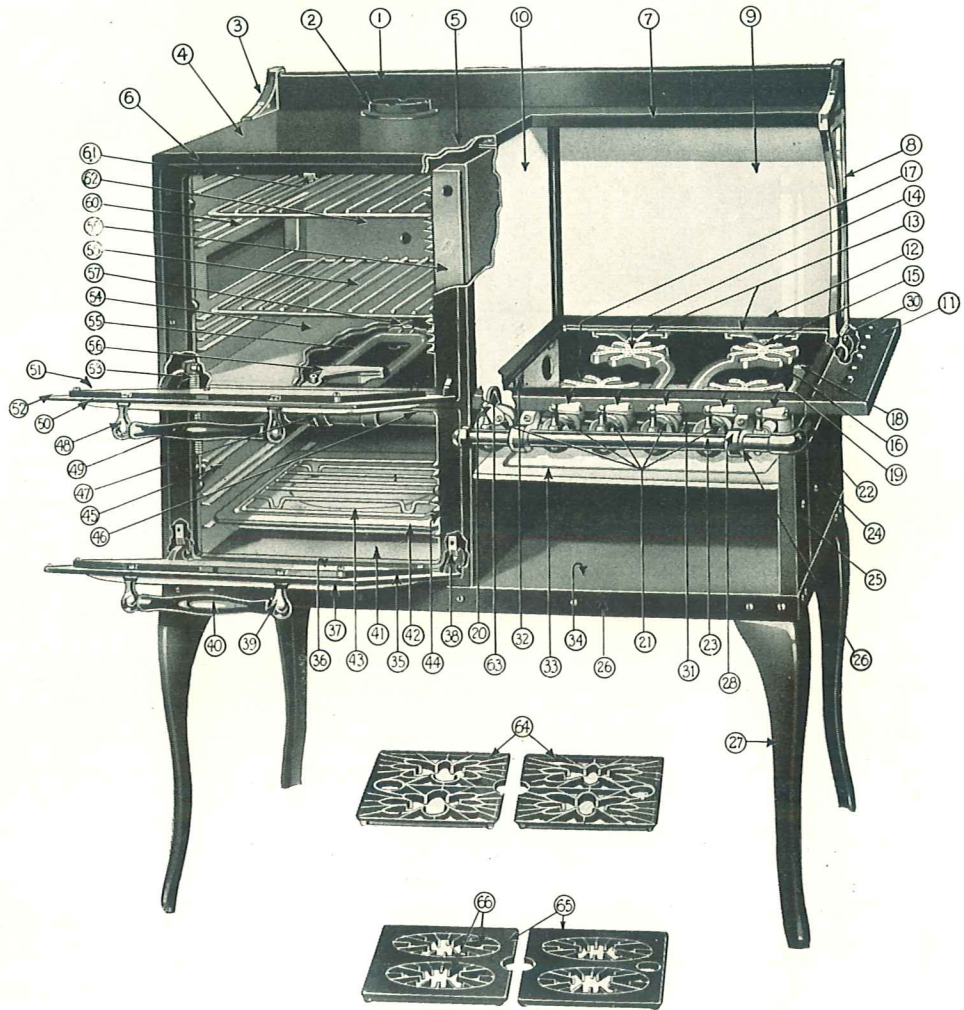

Crescent Box Cabinet Gas Range

ON YOUR ORDER FOR REPAIRS STATE WHETHER FOR "RIGHT" OR "LEFT" OVEN RANGE. ILLUSTRATION IS A "LEFT" OVEN RANGE.

Number will be found on end of range opposite oven under side shelf. ALWAYS BE SURE TO GIVE NUMBER AND INITIALS WHEN ORDERING REPAIRS.

- | | |
|---------------------------------|-------------------------------|
| 1 Back Guard | 34 Combustion Chamber Bottom |
| 2 Pipe Collar | 35 Broiler Door Frame |
| 3 Back Guard Corner | 36 Broiler Door Lining |
| 4 Oven Top | 37 Broiler Door Cushion Panel |
| 5 Top Flue Lining | 38 Broiler Door Bumper Spring |
| 6 Main Front Frame | 39 Broiler Door Handle Post |
| 7 Top Shelf | 40 Broiler Door Handle |
| 8 Shelf Bracket | 41 Broiler Bottom |
| 9 Splasher Back | 42 Broiler Pan |
| 10 Oven Splasher | 43 Broiler Rack |
| 11 Side Shelf | 44 Right Side Lining—Broiler |
| 12 Cooking Top Frame | 45 Left Side Lining—Broiler |
| 13 Rear Burner Hangers | 46 Oven Burner Goose Neck |
| 14 Long Burner—Left | 47 Oven Burner Hanger—Front |
| 15 Long Burner—Right | 48 Oven Door Handle Post |
| 16 Giant Burner | 49 Oven Door Handle |
| 17 Short Burner | 50 Oven Door Cushion Panel |
| 18 Simmer Burner | 51 Oven Door Lining |
| 19 Top Burner Valves | 52 Oven Door Frame |
| 20 Oven Burner Valve | 53 Oven Door Spring |
| 21 Mixer Covers | 54 Oven Bottom |
| 22 Manifold Pipe—Rear Extension | 55 Oven Burner |
| 23 Front Manifold Pipe | 56 Oven Burner Lighter |
| 24 Combustion Chamber End | 57 Oven Burner Hanger—Rear |
| 25 Corner Post | 58 Oven Rack |
| 26 Bottom Band | 59 Right Side Lining—Oven |
| 27 Leg | 60 Left Side Lining—Oven |
| 28 Manifold Cap—Top | 61 Oven Door Catch |
| 29 Manifold Hanger—Top | 62 Back Flue Lining |
| 30 Rear Manifold Hanger | 63 Goose Neck Collar |
| 31 Front Burner Hanger | 64 Open Key Plates |
| 32 Front Burner Hanger Lug | 65 Closed Key Plates |
| 33 Dirt Tray | 66 Open Grids for Closed Top |

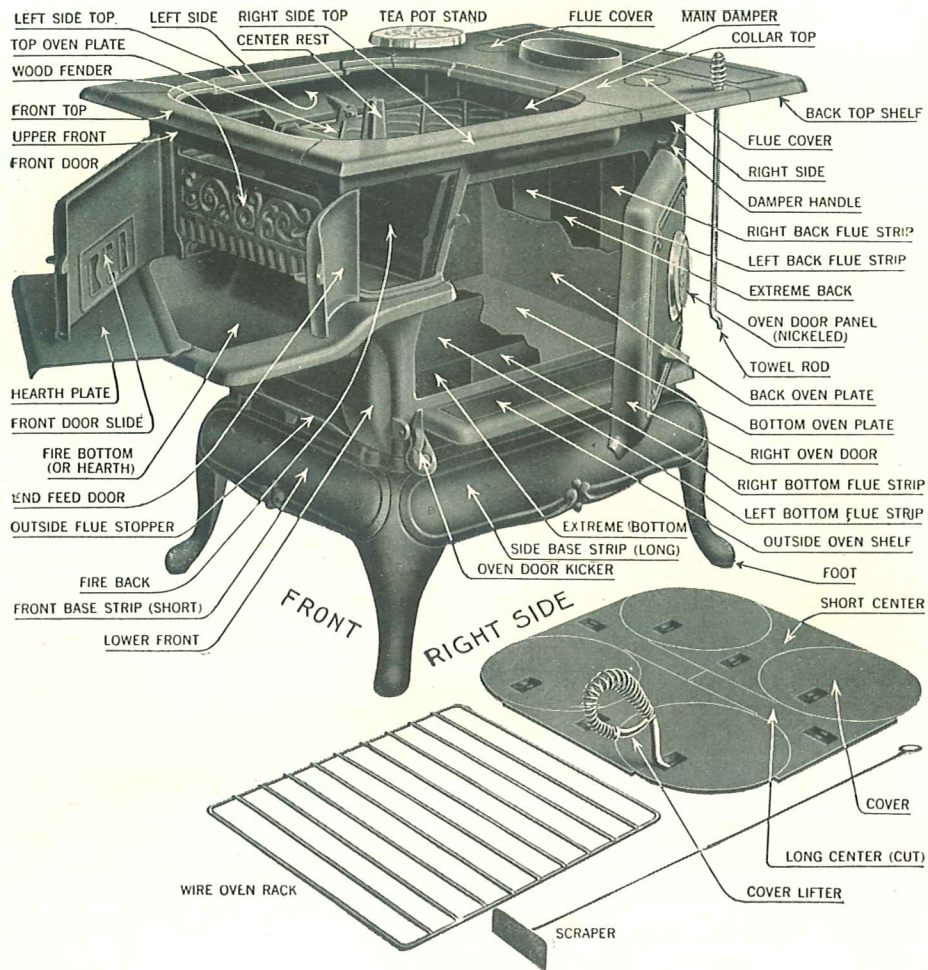

Cast Iron Bracket Reservoir

REPAIRS IN DETAIL

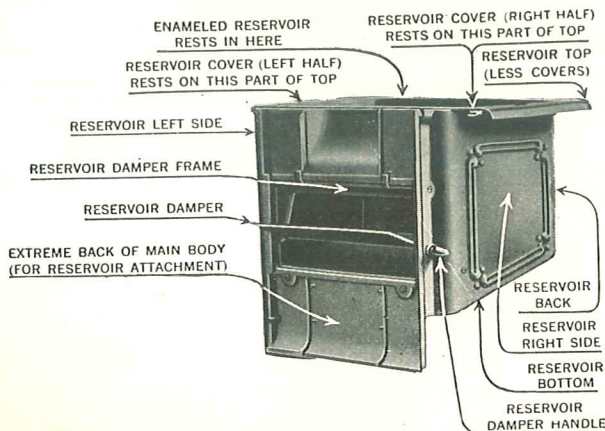

RESERVOIR EQUIPPED WITH COPPER CONTACT TANK, HAS NO DAMPER. TANK RESTS DIRECTLY AGAINST MAIN BACK OF STOVE OR RANGE.

Cast Iron Coal Cook Stove

(With Fire Bottom or Hearth)

REPAIRS IN DETAIL

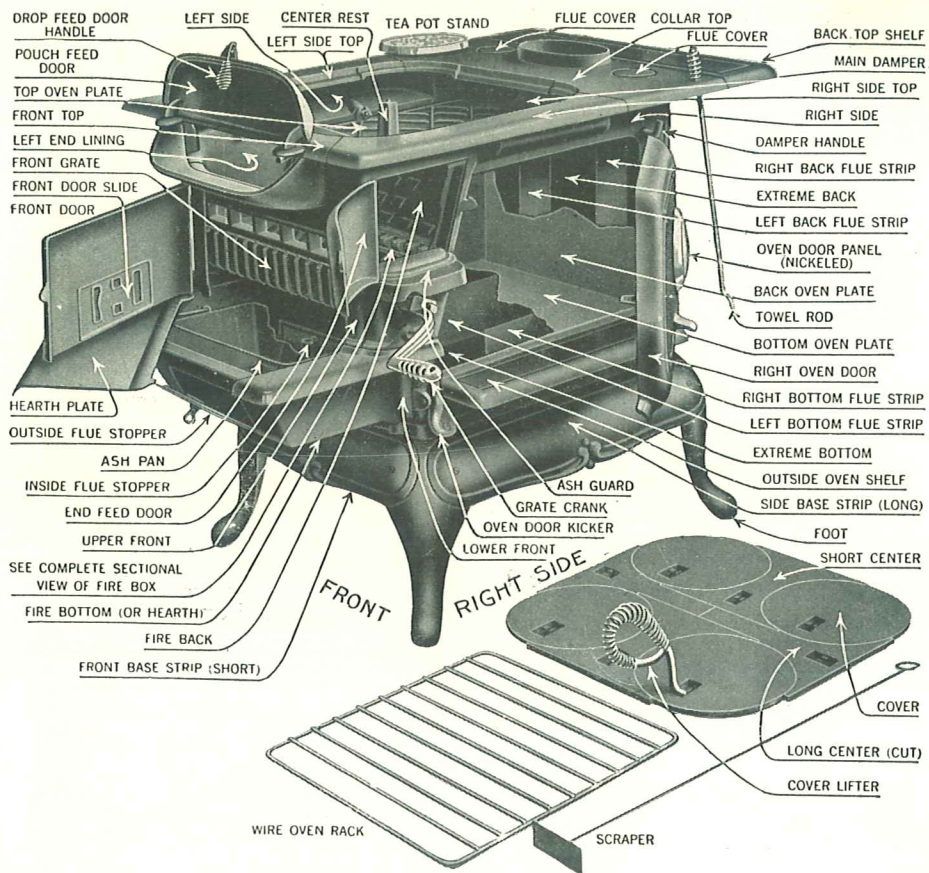

RULES FOR ORDERING REPAIRS

For Stove or Range with Fire Bottom (or Hearth)

Use the illustration on this page only for ordering repairs when your cook stove or range has a FIRE BOTTOM (or hearth).

If your stove or range hasn't a fire bottom (or hearth) then be governed according to illustrations and names of casting as shown on pages 130 and 131 of this catalogue.

HOW TO FACE A STOVE

The part of the stove which has the Fire Bottom (or hearth) is termed "FRONT", as shown on illustrations. That part of the stove to the Right is then termed "RIGHT SIDE". By following the above described rules, you will be able to designate any part of the stove or range without fear of being misunderstood.



HOW TO ORDER REPAIRS

Our customers will enable us to promptly fill their orders for repairs by clearly stating:

NAME OF THE REPAIR
(as per repair cut)

NAME OF STOVE OR RANGE

NUMBER OF STOVE OR RANGE

NAME OF STOVE OR RANGE is shown on Oven Door, Clean-out Door, Feed Door or left end of stove.

NUMBER OF STOVE OR RANGE is on cooking top near stove pipe collar or on Feed Door.

RANGE REPAIR LIST

When designating RIGHT or LEFT, take position facing the oven door, which is called the front of the range. Locate piece wanted on sectional drawing by number. Find same number on LIST OF PARTS, which gives you the correct name.

COOK STOVE REPAIR LIST

When designating RIGHT or LEFT, take position facing the Fire Bottom (or hearth) which is called the front of the stove.

ORDER BY NAME AND NUMBER AND BE SURE TO GIVE US THE FULL NAME AND NUMBER FOUND ON THE STOVE FOR WHICH REPAIRS ARE WANTED. If unable to give name and number of part needed, make a rough sketch of same.

When ordering repairs for Gas Ranges and Combination Ranges, state whether MANUFACTURED OR NATURAL GAS IS USED.

