

COAL AND ITS SCIENTIFIC USES

BY

WILLIAM A. BONE

D.Sc., Ph.D., F.R.S.

*Professor of Chemical Technology in the Imperial College of Science and Technology,
London; Formerly Liversy Professor of Coal Gas and Fuel Industries in the
University of Leeds; Honorary Member of the American Gas Institute
and of the Institution of Gas Engineers; Chairman of the British
Fuel Economy Committee (1915-17)*

WITH ILLUSTRATIONS

LONGMANS, GREEN AND CO.

39 PATERNOSTER ROW, LONDON

FOURTH AVENUE & 30TH STREET, NEW YORK

BOMBAY, CALCUTTA, AND MADRAS

1918



TO
THE MEMORY OF MY DEAR WIFE
KATE BONE

PREFACE

I HAVE endeavoured in this monograph to give in essential outline an account of the present state of science and practice in relation to Coal and its various Uses.

In consenting to undertake the task I was conscious, on the one hand, that so wide and important a subject could hardly be treated adequately by any one writer in a volume of such moderate dimensions as this present. On the other hand, I felt that, in the national interest, there was great need for some responsible scientific worker in Fuel Technology to review the various aspects of the Coal Question as it stands to-day. And as much new information had come to my knowledge as Chairman of the British Association Fuel Economy Committee in 1915-17, it was hardly possible for me not to accede to the Editor's request.

In drawing up the scheme for the book, I made it my chief objective to give the scientific public, and especially the chemical section of it, as clear and succinct an account as I could of the statistical, chemical, and technical aspects of the subject as a whole, without unnecessary detail or too much mechanical illustration. And whilst I have made no attempt to write what would be called a scientific treatise, I have consistently endeavoured throughout to give due prominence to the underlying scientific principles.

The scheme of the book has been so arranged that, beginning with a chapter on the general and statistical aspects of the Coal Question from a national standpoint, there follows a review of the present state of science regarding the origin and chemistry of coal, including its distillation, oxidation, and combustion. The latter part of the book is devoted to a consideration of the principal economic and industrial uses of coal as a fuel, to each of which one or more chapters have been assigned. The volume closes with an account of the subject of "Surface Combustion,"

which has been included in response to many requests from various friends.

I am fully aware that in reviewing so complex a subject as the Chemistry of Coal, I was entering upon controversial ground, but I trust that those whose work I have dealt with will find that I have succeeded in my desire to present an entirely impartial, although at the same time critical, account of the matter in its essential aspects.

The book has, however, been written during a period of quite exceptional stress of academic and professional duties, and amid many distractions arising therefrom; therefore, I trust that my readers will be lenient towards any omissions or defects which they may discover in the text.

My task has been considerably lightened by the kindness of many colleagues and friends who have helped me by their advice after perusing the various chapters. My special thanks are due to Mr. A. W. Flux, M.A., in reference to the statistical review in Chapter I; to Professor W. W. Watts, F.R.S., and Mr. G. W. Lamplugh, F.R.S., in regard to the geological matters touched upon in Chapter II; to Professor W. E. Dalby, F.R.S., for perusing the Chapter on "Heat Transmission in Boilers"; to Messrs. T. Pridgin Teale, F.R.S., and H. James Yates in connection with Chapter XII; to Professor J. B. Cohen, F.R.S., of Leeds, in connection with Chapter XIII; and, lastly, to my relative, Mr. T. C. Hutchinson, and my old pupil, Mr. E. Bury, M.Sc., both of the Skinningrove Iron Co., Ltd., for their guidance in respect of Chapter XIX.

I am also indebted to the courtesy of numerous engineering firms, whose coal-using plants or appliances are described or referred to in the text, for much information and the loan of appropriate diagrams and photographs. Among those I would particularly mention are: Messrs. Joseph Adamson & Co.; Clayton, Son & Co., Ltd.; R. & J. Dempster, Ltd.; Dowson and Mason Gas Plant Co., Ltd.; Frasers & Chalmers, Ltd.; Humphreys & Glasgow, Ltd.; Lymn Chemical Engineering Co., Ltd.; Merz & McLellan; Perry & Co., Ltd. (Bow); Power Gas Corporation, Ltd.; Successors to the Otto Coke Oven Co., Ltd.; Underfeed Stoker Co., Ltd.; and West's Gas Improvement Co., Ltd.

I also desire to say that, with the Editor's kind acquiescence, I have made full use of the valuable information contained in the following articles in his *Dictionary of Applied Chemistry*, namely, (1) "Coke," by Ernest Bury, M.Sc.; (2) "Coal Gas,"

by Dr. Harold G. Colman; and (3) "Water Gas," by the late Professor V. B. Lewes. And, naturally, also I have drawn a good deal from my own article on "Fuel" in the same publication.

I must also thank many authors, publishers, and other scientific or professional friends for their kindness in allowing me to reproduce diagrams, tables, and other illustrations from their memoirs or issues, all of which I have endeavoured to acknowledge duly, either in the text or in the footnotes thereto. Among these I would specially mention here are the following: Professor J. S. S. Brame; Messrs. H. R. Kempe, J. B. C. Kershaw, M. Longridge; Drs. Vernon Harcourt and R. V. Wheeler; the Editors of the *Iron and Coal Trades Review* and of the *Gas Journal*; Messrs. Edward Arnold, Benn Bros., Ltd. (publishers of the *Gas World*), and Charles Griffin & Sons; the Councils or Managers of the American Gas Institute, of the Chemical Society, of the Iron and Steel Institute, and of the Royal Institution of Great Britain.

I must, finally, express my warmest thanks to my assistant, Mr. R. J. Sarjant, B.Sc., A.R.C.S., for his indispensable help in revising the typescript, checking calculations, preparation of curves, and reading the proof sheets, as well as to Mr. Cecil Godfrey, A.R.C.S., for kindly indexing the volume. Also I desire to thank Miss B. Butler for the great care which she has bestowed upon preparing the typescript and the numerous tables illustrating the text.

The writing of the book has been a labour of love, for it is dedicated to the memory of one who was my constant companion and inspiration during eighteen supremely happy years of scientific work in Manchester, Leeds, and London, and whose personality was a delight to all who enjoyed her friendship.

WILLIAM A. BONE.

Imperial College of Science and Technology, London.
June 1918.

CONTENTS

CHAP.	PAGE
I. INTRODUCTORY—THE COAL QUESTION—ITS IMPORTANCE TO THE NATION AND THE EMPIRE	1
II. THE ORIGIN AND FORMATION OF COAL	23
III. THE CHEMICAL COMPOSITION OF COAL	35
IV. " " " " (continued)	49
V. " " " " (continued)	63
VI. " " " " (continued)	73
VII. " " " " (continued)	99
VIII. " " " " (continued)	129
IX. " " " " (continued)	149
X. THE COMBUSTION OF COAL	164
XI. THE PRINCIPLES GOVERNING COMBUSTION AND HEAT TRANSMISSION IN BOILERS	184
XII. DOMESTIC HEATING	219
XIII. THE SMOKE NUISANCE AND ITS ABATEMENT	239
XIV. GENERAL CONSIDERATIONS RELATING TO THE USE OF • GASEOUS FUELS DERIVED FROM COAL	250
XV. THE CARBONISATION INDUSTRIES	267
XVI. " " " (continued)	299
XVII. THE COMPLETE GASIFICATION OF COAL	333
XVIII. WATER GAS AND ITS APPLICATIONS	372
XIX. FUEL ECONOMY IN THE MANUFACTURE OF IRON AND • STEEL	389
XX. ECONOMY OF FUEL ATTAINABLE IN THE BLAST FURNACE BY THE USE OF DRY BLAST	422
XXI. POWER PRODUCTION FROM COAL	431
XXII. "SURFACE COMBUSTION"	445
APPENDIX	477
BIBLIOGRAPHY	481
INDEX	485

LIST OF PLATES

PLATE I.	BAUM WASHER BOX (FRONT ELEVATION)	}	Between 44 & 45
„ II.	„ „ „ (END ELEVATION)	}	
„ III.	INTERIOR OF BAUM COAL WASHING PLANT.		<i>To face page</i> 46
FIG. 21.	UNDERFEED STOKER		179
PLATE IV.	BACK VIEW OF A BATTERY OF OTTO COKE OVENS		316
„ V.	OTTO TAR-SPRAYER	}	Between 322 & 323
„ VI.	OTTO SATURATOR		
„ VII.	DOWSON 800 B.H.P. POWER PLANT FOR BITUMINOUS COAL		<i>To face page</i> 350
„ VIII.	MOND GAS CENTRAL GENERATING PLANT AT DUDLEY PORT, TIPTON		370
FIG. 62.	DEMPSTER DELLWIK WATER-GAS PLANT		376
PLATE IX.	“K AND A” WATER GAS INSTALLATION AT HUNSLET, LEEDS		380
„ X.	DUNSTON POWER STATION	} 443
„ XI.	NEWPORT WASTE HEAT POWER STATION		
FIGS. 78, 79.	PHOTOMICROGRAPHS OF SILVER GAUZE USED IN SURFACE COMBUSTION EXPERIMENTS		448
„ 84, 85.	SURFACE COMBUSTION FURNACES		458
„ 88.	SURFACE COMBUSTION 10-TUBE EXPERIMENTAL BOILER		461
„ 89.	SURFACE COMBUSTION BOILER AT SKINNINGROVE IRONWORKS		463
„ 91, 92.	“BONECOURT” SURFACE COMBUSTION BOILER		469

LIST OF TABLES

TABLE	PAGE
I. Coal Exports and Shipping Statistics for the United Kingdom during Quinquennial Periods 1855-1900	4
II. Relation of British to World's Tonnage of Shipping, 1855-1900	5
III. Number and Tonnage of Ships of 100 Tons gross and upwards built during 1900	6
IV. Output of Coals and Pig Iron in the United Kingdom (Decennial Periods 1865-1914)	7
V. Average Values of Coal exported and Sauerbeck's Index Numbers	7
VI. Estimated Coal Reserves per Head of Population in Different Countries	11
VII. World's Output of Coal for the years 1903, 1908, and 1913	12
VIII. Coal Productions of United States, Great Britain, and Germany--Quinquennial Averages 1900-14	12
IXA. Coal Productions in Great Britain--Quinquennial Averages 1870-1914	13
IXB. Average Cost of Coal at Pit-head in the United Kingdom for the year 1913	21
X. Percentage Compositions of important Classes of Coals	30
XI. Percentage Composition of Occluded Gases in different Classes of British Coals	36
XIIA. Percentage Composition of the Ashes from some typical British Coals	40
XIIB. Dr. J. T. Dunn's Analyses and Melting-point Determinations of Coal Ashes	41
XIII-XV. Results of Coal-Washing Tests	46, 47
XVI. Ultimate Compositions and Calorific Values of Solid Fuels	50
XVII. Proximate Classification of Coals according to their "Contents of Volatile Matter"	58
XVIII. Relations between observed Calorific Values of Coals and those calculated from their Ultimate Compositions	62
XIX. The Regnault-Grüner Classification of Coals (as revised by the Author)	64
XX. Wedding's Classification of Coals	69
XXI. C. A. Seyler's Classification of Coals	70
XXII. United States Geological Survey's Classification of Coals	71
XXIII. Distribution of Nitrogen appearing in the Products of Carbonisation at different Temperatures	77

TABLE	PAGE
XXIV. Professor Bedson's Experiments on the Carbonisation of different Coals at the Redhaugh Gas-works, Newcastle-on-Tyne	88
XXV. Wahl's Pyridine Extraction Experiments with French Coals	91
XXVI-} Burgess and Wheeler's Experiments on the Distillation XXVI.} of Coal in a Vacuum	102, 103
XXVIII. Gaseous Products of the Thermal Decomposition of Low Temperature Tar (D. T. Jones)	115
XXIX. Percentage Compositions of the Substances used in Hollings and Cobb's Experiments on the Thermal Changes during Carbonisation	116
XXX. Proportions of Oxygen appearing as Water and Oxides of Carbon on carbonising two Isomeric Coals at 550° C.	118
XXXI. Percentage Composition of the Coals used in Porter and Taylor's Experiments	119
XXXII. Results of Porter and Taylor's Experiments at 450° C.	123
XXXIII. St. Claire Deville's Gas-making Tests upon different Coals at the Paris Gas-works	130
XXXIV. W. B. Davidson's Carbonisation Experiments at the Birmingham Gas-works	130
XXXV. Composition of the Gas obtained during Davidson's Experiments	131
XXXVI. Difference of Products obtainable from the Low and High Temperature Distillation of a Bituminous Coal	133
XXXVII. Thermal Decomposition of Methane at 1000° C. (Bone and Coward), showing the influence of Time and Concentration	141
XXXVIII. Thermal Decomposition of Methane at 785° to 1150° C. (Bone and Coward), showing the influence of Temperature	141
XXXIX. Thermal Decompositions of Ethane, Ethylene, and Acetylene at 800° and 1000° C. (Bone and Coward)	143
XL. Thermal Decomposition of Acetylene at 800°, 1000°, and 1150° C. (Bone and Coward)	146
XLI-} Slow Oxidation of two typical Bituminous Coals	160, 161
XLIII.}	
XLIV-} Lang's Experiments on the Combustion of Carbon	167, 168
XLV.}	
XLVI. H. B. Dixon's Experiments on Combustion of Carbon	169
XLVII. Constam's Distillation Tests at 800° C.	175
XLVIII. Zürich Steam Trials with different Fuels on a hand-fired Marine Boiler (Constam and Schläpfer)	188
XLIX. American Sliding Scale for Prices of Coal according to Ash Content	189
L. Zürich Steam Trials with Ruhr and Saar Coals on a Lancashire Boiler with (1) Hand Firing, (2) Underfeed Stoking (Constam and Schläpfer)	196
I.I. Mean Specific Heats of Nitrogen, Carbon Dioxide, and Steam, between 0° and 1400° C. (Cals. per gram)	200

LIST OF TABLES

TABLE	PAGE
LII. Sensible Heat in Nitrogen, Carbon Dioxide, and Steam at different Temperatures up to 1400° C.	201
LIII. Sensible Heat lost in Boiler Flue Gases	203
LIV. Michael Longridge's Tests of the Nicolson Boiler with a Welsh Steam Coal	213
LV. Leeds Experiments on Gas Fires (1907-1909)	234
LVI. Tests on the Radiating Efficiency of a modern Gas Fire	236
LVII. H. James Yates's Tests upon Gas Fires (1913)	237
LVIII- LIX. } Cohen and Ruston's Analyses of Soot	244, 245
LX. Deposition of Tar in various Districts of Leeds	247
LXI. Cohen and Ruston's Experiments on Damage done to Vegetation by Smoke	248
LXII. Densities and Calorific Values of Various Combustible Gases	252
LXIII. Calculation of Relative Calorific Intensities of various Gas-Air Flames	265
LXIV. J. Ferguson Bell's Trials of a Derbyshire Gas Coal in Horizontal Retorts at 986-995° C.	284
LXVA. J. G. Newbigging's Tests on a Lancashire Coal in Vertical Retorts at the Droylsden Gas-works	290
LXVB. Comparison of Tars made from Vertical and Horizontal Retorts (Newbigging)	291
LXVI. Metropolitan Gas Companies' Accounts for the year 1913	298
LXVII. E. Bury's Estimate of Relative Yields of Products from a Coal containing 30 per cent. Volatile Matter	309
LXVIII. Some Laboratory Tests of Representative British Coking Coals	313
LXIX. Percentage Yields of Coke, Tar, Benzol, and Ammonium Sulphate obtainable on Coking British Coals	315
LXX. Composition of Coke Oven Gas from typical British Coals (without Benzol Recovery)	328
LXXI. Karl Wendt's Experiment with an Air-blown Gas Producer	336
LXXII. Karl Wendt's Experiments with an Air-Steam blown Gas Producer	340
LXXIII. Bone and Wheeler's Gas-Producer Trials	343
LXXIV- LXXV. } Gayley's Experiments on the Fuel Economy of Dry Blast in Iron Smelting at Pittsburg	424, 425
LXXVI. North-East Coast Power Scheme Generating Stations in the year 1915	442
LXXVII. The Combustion of Typical Gaseous Fuels	457
LXXVIII. Trials of " Surface Combustion " Boiler	462
LXXIX. Heat Balances of Surface Combustion and Coal-Fired Boilers	465
LXXX. Trial of a Surface Combustion Furnace	473

COAL AND ITS SCIENTIFIC USES

CHAPTER I

INTRODUCTORY—THE COAL QUESTION—ITS IMPORTANCE TO THE NATION AND THE EMPIRE

“ COAL in truth stands not beside, but entirely above, all other commodities. It is the material source of the energy of the country—the universal aid—the factor in everything we do. With coal almost any feat is possible or easy; without it we are thrown back into the laborious poverty of early times. . . . The progress of science, and the improvement in the arts, will tend to increase the supremacy of steam and coal ” (W. Stanley Jevons on *The Coal Question*, 1865).¹

When Jevons endeavoured, more than fifty years ago, to awaken public opinion to the vital importance of the coal question to the industrial future of the nation, this country held an unrivalled position as a producer of coal. For out of a total world's output of 130 million tons, no less than 80 million tons, or practically 60 per cent., were raised in Great Britain. The then known immense coal reserves of North America, as well as those of the States now comprising the German Empire, had scarcely been touched, chiefly because neither of these countries had as yet reached a state of industrial or economic development at all comparable with our own. And although the cost of getting bituminous coal in Pennsylvania (Pittsburg) was even then less than one-half the general price at British and German mines, the proximity of all our principal coalfields either to the sea, on the one hand, or to supplies of ironstone, on the other, combined with the natural skill and aptitude of our people in regard to mechanical invention, had combined to place us in a position of unique advantage over all other countries.

¹ A third edition of Jevons's remarkable book on *The Coal Question* (1868), revised by A. W. Flux, was published in 1906 (Macmillan & Co.).

COAL AND ITS SCIENTIFIC USES

The rise of the industrial supremacy which Great Britain enjoyed throughout the nineteenth century may be dated from the years 1730 to 1735 when the Abraham Darbys, father and son, re-discovered and revived the art of smelting iron with pit coal, which had been in abeyance since the days of Dud Dudley (1599 to 1684), who had originated it in 1621. The substitution of pit coal for wood charcoal as fuel in the blast furnace had an immediate and far-reaching effect upon the economic future of Great Britain and, through it, upon the welfare of mankind in general.

During Elizabethan times the inroads upon our forests to supply charcoal for the iron furnaces of Sussex and neighbouring counties, then the chief seat of iron smelting in England, had become so serious that Parliament found it necessary to interfere with an Act prohibiting the further extension of the industry. But with Dudley's discoveries the necessity for such restrictions disappeared, and such was the development of the iron industry in England during his lifetime, that the outputs of our 300 furnaces has been thought by some to have reached possibly 100,000 tons per annum. Unfortunately disaster overtook him, and for fifty years after his death the use of pit coal fell altogether into abeyance. So rapidly then did the industry decline that, in 1740, there remained but fifty-nine furnaces in blast, yielding an annual output of a little more than 17,000 tons, and in that year 30,000 tons of iron had to be imported to meet the national requirements. The population of England and Wales, which, according to the best estimates, had grown from 5.6 millions in 1630 to 6.25 millions in 1711, then came to a standstill, or actually declined, during the next thirty years until, in 1741, it stood no higher than 6.15 millions.

This was, however, the turning point; the next thirty years saw an increase in the population of no less than a million persons, whilst the annual output of our iron furnaces had increased at least threefold. A century after the Darbys' achievement the population had increased to 14 millions, and the annual output of iron to about 750,000 tons.

The year 1828 brought James Neilson's revolutionary invention of preheating the air before it reached the fuel in the blast furnace, which ushered in another era of expansion, and may be said to have laid the foundation of nearly all subsequent developments in the direction of fuel economy in iron smelting.

Just as the need of pumping the mines was the chief incentive to the first pioneers of the steam engine, so the development of

INTRODUCTORY

steam-power by British engineers during the eighteenth century greatly increased the commercial prospects of coal mining; for it is said that "the steam engine produced a new era in the mining and commercial interests of Britain, and, as it were, in an instant, put every coalfield which was considered as lost within the grasp of its owners. Collieries were opened in every district and such has been the astonishing effect produced by this machine, that great coal was shipping free on board in the river Forth in the year 1785 at 4s. 10d. per ton; that is, after a period of seventy years, coal had only advanced 2d. per ton, while the price of labour and all materials was doubled."¹

As the result of the new industrial life and enterprise which sprang up everywhere throughout the Kingdom from the inventions of the Darbys, Newcomen, Smeaton, James Watt and others, attention was directed to the deplorably backward state of its internal communications. Until the middle of the eighteenth century the wretched conditions of such high roads as there were in England rendered them all but useless for goods traffic. Canals there were none, although Holland, France, and even Russia had already developed efficient and extensive canal systems. But, as Jevons pointed out, "until coal supplied the purpose, there was not spirit enough in this country to undertake so formidable a work as a canal."

The first canal cut in England was in 1755 to convey coal from St. Helens to the Mersey; thereupon the Duke of Bridgewater engaged Brindley to construct his famous canal for the purpose of transporting coal from his collieries at Worsley to Manchester, the accomplishment of which is said to have saved 7s. 6d. per ton on the carriage, and to have immediately reduced the price of coal in Manchester from 7d. to 3½d. per cwt. (120 lb.). A rapid development of the canal system in England followed; thus before Brindley died in 1772, he had designed and carried out the Grand Trunk Canal, connecting the Trent and Humber with the Mersey, the Staffordshire and Worcestershire Canal, the Oxford Canal, and the Stockwith and Chesterfield Canal. By the year 1810 there had been constructed 2000 miles of canals in England alone at a cost of £50,000,000, and some of the companies owning them paid large dividends.

It was the necessity of cheapening the carriage of coal from the pits near Shildon to the wharves on the Tees at Stockton which led to the construction of the first public railway. This

¹ Bald, *Scotch Coal Trade*, p. 24, quoted by Jevons (1906 edition, p. 120).

COAL AND ITS SCIENTIFIC USES

TABLE I

Quinquennial Period.	Shipping Tonnage Entered and Cleared in the Foreign Trade at Ports in the United Kingdom.			Exports of Coal (including Coal equivalent of Coke and Manufactured Fuel, also Bankers).							
	Total Millions Tons.	Proportion of British.	Tons per Head of Population.	Total Million Tons.		Tons per Head of Population.		Total Value £ Million.		Percentage of Total Values Exported.	
				Including Bankers.	Excluding Bankers.	Including Bankers.	Excluding Bankers.	Including Bankers.	Excluding Bankers.	Including Bankers.	Excluding Bankers.
1855-9	21.7	0.59	0.77	No information as to Bankers	6.4	—	0.23	—	3.01	—	2.6
1865-9	32.3	0.68	1.06		10.5	—	0.35	—	5.16	—	2.8
1875-9	50.6	0.68	1.52	19.6	0.58	0.47	10.16	8.19	11.35	5.0	4.1
1885-9	66.5	0.73	1.82	32.9	0.90	0.71	14.41	11.35	17.09	0.3	5.0
1895-9	89.0	0.71	2.22	47.9	1.20	0.93	22.77	17.09	35.09	9.4	7.4
1905-9*	126.21	0.61	2.87	80.1	1.82	1.39	40.63	35.09	—	12.3	9.7

* In and after 1907 the figures include certain vessels calling off Plymouth and Southampton to land and embark passengers.

INTRODUCTORY

was opened between Whitton Park Colliery, Darlington, and Stockton on September 27, 1825, and the rapid extension of railways and steam locomotives which followed the success of this venture was "mainly due to the traffic and wealth occasioned by the use of coal in manufacture."¹ So much so that George Stephenson used to say, "The strength of Britain lies in her iron and coal beds; and the locomotive is destined, above all other agencies, to bring it forth. The Lord Chancellor now sits upon a bag of wool, but wool has long since ceased to be emblematical of the staple commodity of England. He ought to sit upon a bag of coals."²

And if it was to the traffic and wealth in coal that the nation mainly owed the development of its internal communications (canals and railways) during the century 1750 to 1850, it may with equal truth be said that one of the chief factors in the maintenance of the supremacy of its mercantile marine since 1850 has been its ever-increasing export trade in coal, as the figures in Tables I and II show :—

TABLE II

Year.	Total Net Tonnage of Ships on the Registers of the British Empire (Million Tons).	Ratio.
		British Empire Tonnage. Whole World's Tonnage.
1855	5.00	—
1873	7.55	0.432
1890	9.69	0.578
1900	10.75	0.486

Moreover, the overwhelming supremacy in shipbuilding which the United Kingdom and the Empire had established over all other nations by the end of the nineteenth century (as shown in Table III) is to be ascribed to cheap coal and iron, combined with (so far as the United Kingdom is concerned) favourable geographical position, climatic conditions, and free imports. And it is not too much to say that the future maintenance of our marine supremacy is intimately bound up with the cheap production of coal, iron, and steel; from this point of view the relatively increasing cost during recent years of fuel in Great Britain, as compared with America, is a matter of serious national concern.

¹ Jevons, *The Coal Question*, p. 125.

² Smiles's *Lives of the Engineers*, Vol. III., p. 357 (quoted also by Jevons, *ibid.*, p. 126).

COAL AND ITS SCIENTIFIC USES

TABLE III

NUMBER AND TONNAGE OF SHIPS OF 100 TONS GROSS AND UPWARDS BUILT DURING 1900

Country.	Sail.		Steam.		Total.		Percentage of Total.
	No.	Tonnage.	No.	Tonnage.	No.	Tonnage.	
Great Britain and Empire	41	12,826	669	1,497,001	710	1,509,837	64.42
United States	105	118,387	91	184,952	196	303,339	12.92
Germany . .	37	16,982	71	203,417	108	220,399	9.40
France . .	53	96,334	13	31,094	66	127,428	5.44
All other Countries .	88	19,442	128	163,409	216	182,851	7.82
Total .	324	263,971	972	2,079,873	1296	2,343,854	100.00

With regard to the position of the United Kingdom as a producer of coal during the past fifty years, it may be remarked that not only (as is shown in Table IV) has the average output of coal per head of population steadily increased, but also the price of it at the pithead has increased, both absolutely and relatively to that of other commodities, a condition which has applied equally to other European countries. Indeed for many years past there has been no material difference between the average pithead prices of coal in Great Britain and Germany, and it is probable that the upward tendency in both countries will continue, owing to the steadily increasing costs in operating the mines. On the other hand, coal is produced in the United States at a materially lower cost than in any European country, and the pithead price there had for some years previous to the war shown no upward tendency, but rather the reverse.

The case of iron is different, for whilst our output of pig iron per head of population had, before the war, become practically stationary, the cost of its manufacture had been kept down by improved methods and organisation, and in 1913 it was certainly much lower than it was fifty years ago. At the outbreak of the war we were not producing sufficient steel to meet our own industrial demands, and but for the help of American steel-makers we should not have been able during the war to cope with the demands for munitions. Also, the devastation of Belgium and Northern France has meant a serious reduction in European

INTRODUCTORY

steel plants outside the Central Empires. Hence many people consider that the time is ripe for increasing the output capacities of British iron and steel plants. But if, as will be shown in a later chapter, the price of coal is, and probably will always be, a serious item in the cost of manufacturing both pig iron and steel, the prospects of extending our steel industries on any sound commercial basis is largely bound up with the proper development and utilisation of our best seams of coking coals, and with the achievement of the utmost economy in fuel throughout the whole series of processes from the ore to the finished steel sections.

TABLE IV
OUTPUT OF COAL AND PIG IRON IN THE UNITED KINGDOM

Decennial Period.	Coal.			Pig Iron.	
	Million Tons per Annum.	Tons per Head of Population per Annum.	Average Pit-head Price, Shillings per Ton.	Million Tons per Annum.	Tons per Head of Population per Annum.
			<i>s. d.</i>		
1865-74	111.5	3.54	5 11	5.65	0.18
1875-84	144.5	4.21	6 10	7.25	0.21
1885-94	172.5	4.62	6 3	7.50	0.20
1895-1904	214.5	5.17	7 5	8.60	0.21
1905-14	263.0	5.80	8 7	9.65	0.21

The general movement of coal values, both absolute and relative, in Great Britain during the past seventy years may be illustrated by the following average figures from the "declared" values per ton of coal exported from the United Kingdom, as compared with Sauerbeck's index numbers for the values of commodities generally.

TABLE V

Years.	Average Value of Coal Exported.	Proportionate Numbers.	Sauerbeck's Index Numbers. (All commodities.)
	<i>s. d.</i>		
1840-4	7 3	73.9	92.2
1865-9	9 9½	100.0	100.0
1890-4	11 1	113.2	68.6
1910-14	12 7	128.5	82.8

COAL AND ITS SCIENTIFIC USES

THE WORLD'S COAL RESERVES

As, therefore, it can hardly be questioned that the chief material basis of the great industrial expansion of this country during the past century has been our abundant supplies of easily obtainable coal, and that our whole economic future is bound up with our ability to maintain abundant supplies of relatively cheap fuel, it is important that our present position as regards coal, compared with that of other nations and the world at large, should be clearly apprehended.

According to an exhaustive report upon the World's Coal

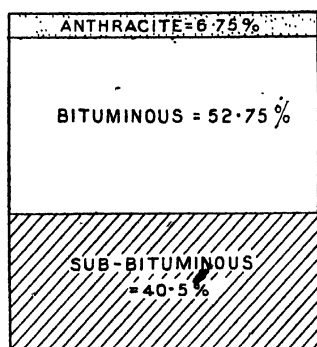

FIG. 1.—World's Estimated Reserves of Coal, 1913, 7,397,553 Million Tons.

Resources issued by the International Geological Congress in 1913, the total probable and possible reserves of coal of all kinds (including anthracites, bituminous coals, and lignites) available within 6000 feet of the earth's surface, are estimated to be 7,397,553 million metric tons; or approximately 6000 times the world's present total annual consumption. Therefore the world as a whole need have no fear of any speedy exhaustion of its coal supplies.

Of the estimated total reserves, 6.75 per cent. are anthracites (mainly located in China), 52.75 per cent. are bituminous coals, and .40.5 per cent. belong to the less valuable sub-bituminous class, which includes all the lignites and Tertiary brown coals (see Fig. 1).

INTRODUCTORY

A survey of the geographical distribution of the estimated reserves shows that no less than 69 per cent. of the total are located in America (almost wholly North America), 17·3 per cent. in Asia, 10·6 per cent. in Europe, 2·4 per cent. in Oceania, and only 0·8 per cent. in Africa (see Fig. 2). It is a significant fact that the two tropical continents of South America and Africa are practically destitute of coalfields of any economic importance. The future wealthy republics of South America must continue, as heretofore, to import coal, machinery, and heavy manufactured goods, in exchange for agricultural produce and raw materials.

Pursuing the matter a little further, we find that of the total

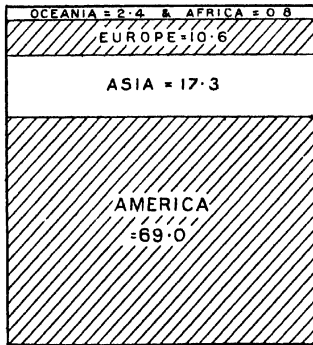

FIG. 2.—Percentages of World's Total Coal Reserves.

estimated reserves, 51·8 per cent. are located in the United States, 16·4 per cent. in Canada, 13·5 per cent. in China, 5·7 per cent. in Germany, 2·6 per cent. in Great Britain, 2·3 per cent. in Siberia, 2·2 per cent. in Australia, and only 0·8 per cent. in Russia (see Fig. 3). China's resources may have been under-estimated, otherwise the relative positions of the remaining countries are probably substantially as stated.

The fact that the available reserves of coal in Great Britain only amount to about one-fortieth, whilst those of the whole Empire do not amount to more than about one-fourth of the world's estimated total, is one which ought to be weighed by every one responsible for the economic development of our national and imperial resources, especially in view of the fact that the United States, whose competition in the immediate

COAL AND ITS SCIENTIFIC USES

future will probably be much more severely felt than ever before, possesses more than half the estimated world's coal, and that also in regard to the two prime considerations of quality and cost of production she probably compares favourably with Great Britain and the Empire.

A better criterion, however, of the position of the United Kingdom relative to that of other countries is perhaps afforded by considering the relation of coal reserves to the population in four of the principal coal-bearing countries of the world. In

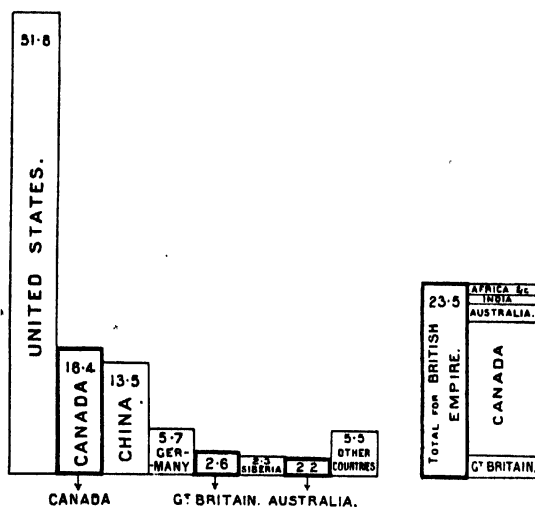

FIG. 3.—Percentages of World's Total Coal Reserves.

making such a comparison it is necessary to differentiate between the economically much more valuable anthracitic and bituminous coals of the Carboniferous Series (A and B) and the less important sub-bituminous Tertiary coals (C), that is to say the Lignites and Brown coals.

From these figures (Table VI), it will be seen that so far as classes A and B are concerned, the reserves per head of population in the United Kingdom, although only about one-fifth of those in the United States, do not compare so unfavourably with those in Germany, and are more than the average for the world as a

INTRODUCTORY

whole. Moreover, almost every variety of economically valuable coals is found in the British Coal Measures, and their quality is on the whole superior to those of European coals generally. More problematical, however, is the position of China, whose enormous reserves have been much less explored than those of other countries; but from what is already known, nearly 40 per cent. of China's reserves consist of high-class anthracites or anthracitic coals, and the remainder are practically all bituminous varieties.

TABLE VI

Country.	Population. Millions.	Estimated Total Reserves. Millions of Tons.		Estimated Reserves. Tons per Head of Population.		
		A and B	C	A and B	C	Total.
United States	105	2,000,000	1,800,000	19,000	17,000	36,000
Germany . .	65	410,000	13,400	6,300	200	6,500
United Kingdom	46	190,000	<i>nil</i>	4,000	<i>nil</i>	4,000
China . . .	400	1,000,000	600	2,500	1.5	2,500
The World .	1500	4,500,000	3,000,000	3,000	2,000	5,000

THE WORLD'S INCREASING DEMANDS FOR COAL

The world's demands for coal, which in 1863 amounted to some 130 million tons per annum only, had by 1913 increased to nearly 1250 million tons per annum. Such a tenfold increase in fifty years represents a "compound interest" rate of practically 5 per cent. per annum throughout the whole period. During the last ten years of it this rate of increase was fully maintained, as follows:—

Year.	Total Demand. Mill. Tons.
1903	800
1908	1000
1913	1250

and it is hardly likely that the rate will diminish after the conclusion of the war.

During the last decade these demands have been principally supplied by three countries, namely, the United States, Great Britain, and Germany, which between them have annually raised practically 83 per cent. of the total coal consumed in the world, as is shown in the following Table:—

COAL AND ITS SCIENTIFIC USES

TABLE VII

WORLD'S OUTPUT OF COAL: MILLIONS OF TONS

	1903	Per cent.		1908	Per cent.	1913	Per cent.			
United States	319.5	40.0	}	415.8	41.5	}	562.6	45.0		
Great Britain	230.4	28.8		261.5	26.0		287.4	23.0		
Germany . .	116.6	14.6		148.6	14.8		191.5	15.3		
							}	83.4		
								}	82.3	
									}	83.3
France . . .	34.3	4.3		36.8	3.7		40.1	3.2		
Belgium . . .	23.8	3.0		23.7	2.3		22.8	1.8		
Russia . . .	16.5	2.0		29.4	2.9		28.8	2.3		
British Possessions . . .	26.5	3.3		42.0	4.2		50.0	4.0		
All other countries . . .	32.4	4.0		43.2	4.3		66.8	5.4		
Total . . .	800.0	100.0		1000.0	100.0		1250.0	100.0		

If now the average outputs of anthracitic and bituminous coals¹ from each of the three countries in question for the three quinquennial periods since the year 1900 be examined (Table VIII), it will be found that the output of the United States has been increasing at a "compound interest" rate of 6 per cent. per annum, that of Germany at a compound rate of 4 per cent. per annum, whilst the British output has increased at a compound rate of only 2 per cent. per annum. Assuming that these relative rates of increase are maintained after the war, it may be predicted that Germany's output will overtake that of Great Britain about twenty years hence, when each country will be producing some 420 million tons per annum.

TABLE VIII

COAL PRODUCTIONS OF UNITED STATES, GREAT BRITAIN, AND GERMANY
QUINQUENNIAL AVERAGES, 1900-1914

Millions of Tons per Annum

	United States.	Great Britain.	Germany.
1900-4	288.2	226.8	112.5
1905-9	400.5	256.0	139.8
1910-14	519.2	269.9	168.7
Approximate per cent. Compound Interest Increase . . .	6.0	2.0	4.0

¹ Lignites and Brown coals have been excluded from this review because of their relative unimportance, although Germany annually raises large quantities of low-grade Brown coals for home consumption.

INTRODUCTORY

The actual outputs for each year during the whole period in question are plotted in Fig. 4.

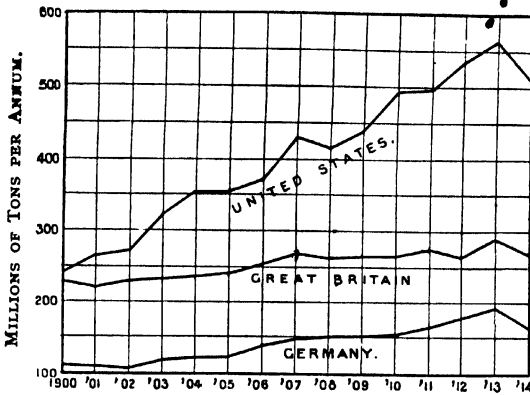

FIG. 4.—Coal Productions, in Millions of Tons, of the United States, Great Britain, and Germany—1900 to 1914.

BRITISH OUTPUTS AND EXPORTS OF COAL

How closely the continuous increases in the British outputs of coal during the forty-five years previous to the war had followed a 2 per cent. compound interest law is shown in the following table of quinquennial averages in millions of tons per annum of the total coal raised in Great Britain between the years 1870 and 1914 inclusive.

TABLE IXA
COAL PRODUCTION IN GREAT BRITAIN
QUINQUENNIAL AVERAGES,
1870-1914
Millions of Tons per Annum

Period.	Average Output.	Calculated at 2 % Compound Interest.
1870-4	121.5	121.5
1875-9	134.0	131.1
1880-4	156.0	148.1
1885-9	165.0	163.5
1890-4	180.0	180.5
1895-9	202.0	199.3
1900-4	227.0	220.1
1905-9	256.0	243.0
1910-14	270.0	268.2

COAL AND ITS SCIENTIFIC USES

These averages are shown as a curve in the next diagram (Fig. 5) which also indicates the proportion of the whole production which had been retained for home consumption. It should also be added that there has been an appreciable increase in the amount of coal consumed per annum per head of population during the period in question, namely, from about 3·5 to about 4·35 tons.

Much has been written upon the question of our coal export trade from opposite standpoints. In some quarters its rapid increase within recent years is viewed with feelings of concern, whilst other people regard a large coal export trade as a necessary condition of our maritime supremacy.

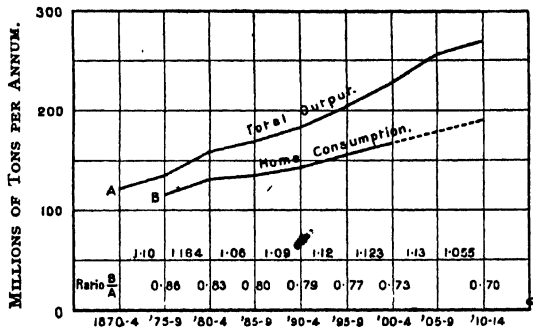

FIG. 5.—Quinquennial Averages of Coal Production in Great Britain.

During the past sixty years our coal export trade has increased something like twentyfold, as regards both the quantities and the values of coal exported. Moreover, its value relative to other values exported has, during the same period, increased fourfold, until in 1913 it constituted about 10 per cent. of our total exported values. Thus in that year, we exported 97·7 million tons (or 34 per cent. of our total output) valued at £53,000,000.

Another feature of our export trade is that whereas both the United States and Germany export considerable quantities of coal by land, their oversea exports are trifling compared with ours, so that in the year 1912 we actually transacted over 70 per cent. of the whole sea-borne coal trade of the world. Several factors have contributed to this astonishing result. One is the

INTRODUCTORY

proximity of our finest steam coal seams to our ports, notably so the South Wales coalfield, which now exports more than 60 per cent. of its total output; another is the increased demands for coal from Europe and South America; while a third factor has been the phenomenal growth of our mercantile marine, which for successful competition with foreign tonnage depends upon good outward as well as inward cargoes. For inasmuch as the inward cargoes are chiefly foodstuffs and raw materials of considerable bulk in relation to their values, while our exports (except coal) are chiefly machinery and manufactured articles, whose bulk is small in relation to their values, our shipowners are in a position to offer low freights for outward cargoes. Hence the view that maritime supremacy and a large coal export trade are interdependent.¹

PROBABLE DURATION OF BRITISH COAL RESERVES

The probable duration of British coal reserves has been investigated by two Royal Commissions. The first one, which was appointed largely in consequence of the late Professor Jevons's book in 1865, reported in 1871, and the second reported in 1905. Since that date, however, Dr. Strahan, the Director of the Geological Survey of England and Wales, has published a revised estimate in the Report of the International Geological Congress for 1913, whilst more recently still (1915) Professor H. Stanley Jevons, following up his late father's work, has published another estimate in his book on *The British Coal Trade*. These various estimates are as follows:—

ESTIMATES OF RESERVES OF BRITISH COAL WITHIN 4000 FEET OF THE SURFACE		
		Million Tons.
First Royal Commission,	1871 . .	146,480
Second Royal Commission,	1905 . .	141,635
Dr. A. Strahan,	1912 . .	178,727
Prof. H. Stanley Jevons,	1915 . .	197,000

¹ It has been estimated that the total earnings of our shipping, including vessels employed in the home trade, in the year 1913 amounted to £162,000,000. Shipbuilding in the United Kingdom employed 210,000 persons and £150,000,000 of capital; port and harbour authorities 60,000 persons and £140,000,000 of capital; whilst miscellaneous dependent activities employed 260,000 persons and £100,000,000 of capital, the total being 530,000 persons and £390,000,000 of capital (*vide* a lecture on "Foreign Trade and Investments Abroad," by Mr. Edgar Crammond, F.S.S., to the Institution of Civil Engineers, March 12, 1917, as reported in *The Times Engineering Supplement*, March 30, 1917).

COAL AND ITS SCIENTIFIC USES

In making such estimates two overruling factors have to be considered, namely:—(1) the maximum depth at which it is practicable to conduct mining operations; and (2) the minimum thickness of seams which can be profitably worked. The first of these factors is determined principally by the increase in temperature as we descend into the bowels of the earth. In Great Britain the temperature at 50 feet below the surface is constant throughout the year at 50° Fahr., and then it increases 1° Fahr. for every 60 feet lower in depth. Both of the Royal Commissions adopted 4000 feet as the maximum limit of practicable working, at which depth the temperature might be expected to be 116° Fahr. and one foot as the minimum workable thickness of seam.¹

Moreover, it should be noted that the Royal Commissions' figures represent the estimated *net* available amount of coal remaining unworked after certain allowances had been made, not only for coal which must be left underground as barriers for the support of surface buildings, but also for losses in working due to faults and other natural causes, which allowances amounted to about 20,000 million tons according to the 1905 Commission's estimate. Also, the 1905 estimate did not include the Kent coalfields and other "concealed" Measures, which were taken into account in Dr. Strahan's revised estimate. Professor H. S. Jevons, who considered that Dr. Strahan erred if anything on the safe side, gave 197,000 million tons as a maximum quantity within 4000 feet of the surface. If then 200,000 million tons be taken as an approximate outside figure, and an allowance of 15 per cent. be made for "pit wastage," the net coal which will actually be available *at the surface* would be about 170,000 million tons, or say about 580 times the amount actually raised in the year 1913.

The most important aspect of the coal question for Great Britain is not so much how long can our reserves possibly last, having regard to the probable continuation of the present upward tendency of our annual outputs, but how long can we continue to get the available coal at a cost which shall not place us as a nation at a disadvantage relative to our nearest competitors. Coal is a gift of Nature which hitherto we have for the most part squandered in all sorts of foul and wasteful ways, polluting the air of heaven with the smoke of it. Nature has also imposed

¹ The greatest depth at which coal mining operations are at present carried out in Great Britain is 3500 feet, and in Europe (Belgium) 3773 feet.

INTRODUCTORY

limits to our stores of it, which will possibly be reached sometime in the future scarcely more distant than are our own times from those of Queen Bess, and certainly not more (as it would seem) than from those of the Black Prince. Moreover, as Jevons pointed out and as subsequent experience has so far confirmed, the more economy that is practised in the use of coal, the more will its consumption increase, for as he truly said: "Economy multiplies the value and efficiency of our chief material; it indefinitely increases our wealth and means of subsistence, and leads to an extension of our population, work, and commerce, which is gratifying in the present, but must lead to an earlier end. Economical inventions are what I should look forward to as likely to continue our rate of increasing consumption. Could we keep them to ourselves, indeed, they would enable us, for a time, to neutralise the evils of dearness when coal begins to get scarce, to keep up our accustomed efficiency and push down our coal shafts as before. But the end would only thus be hastened—the exhaustion of our seams more rapidly carried out." ¹

THE PURPOSES FOR WHICH COAL IS CONSUMED IN THE UNITED KINGDOM AND THE MEANING OF FUEL ECONOMY

Although, in Great Britain, coal both is, and long will continue to be, the principal source of all artificial light, heat, and power, its proper utilisation involves a good deal more than increased efficiency in respect either of power production or of heating operations generally, important as these undoubtedly are. For, when suitably handled by the chemist, coal yields a whole series of valuable by-products which form the raw materials of important chemical industries, and the problem of "coal-economy" involves the whole question of the recovery of such by-products, and the consequent mitigation, or even abolition, of the smoke nuisance which, directly and indirectly, costs the country many millions of pounds per annum.

Thus from the tars resulting from the distillation of coal in gas works, and from the manufacture of metallurgical coke, are obtained ammonium salts, a whole series of aromatic hydrocarbons (benzene, toluene, anthracene, naphthalene, etc.) and other products, which form the basis of the manufacture of synthetic dyes and drugs, as well as that of high explosives,

¹ Third edition (1906), p. 156.

COAL AND ITS SCIENTIFIC USES

and the more general and efficient recovery of such products is essential to the establishment upon a firm basis in this country of industries manufacturing such synthetic chemicals.

With regard to ammonium salts, which are chiefly valuable as fertilisers for the production of foodstuffs, out of 432,618 tons of ammonium sulphate made in the United Kingdom in 1913, no less than 369,557 tons were derived from coal, as follows:—

TONS OF AMMONIUM SULPHATE PRODUCED FROM COAL IN			
Gas Works.	By-product Coke Oven Plants.	Gas Producers.	Iron Works.
182,180	133,816	33,605	19,956

How much more ammonium sulphate might have been produced by a more scientific handling of British coals is shown by the fact that, in the same year, nearly 500,000 tons of ammonium sulphate were produced in Germany from a much smaller output of coal, containing on the average a somewhat smaller percentage of nitrogen than is found in British coals.

The distillation of coal at comparatively low temperatures (400° to 600° C.) constitutes another important means, as yet insufficiently explored by the chemist, of realising the possibilities of coal as a source of motor spirit and fuel oils for marine purposes.

But if, as Jevons insisted, the more economy that is practised in the use of coal, the more will its consumption increase, we cannot expect to prolong the duration of our national coal reserves by the more scientific use of them. The object of any national movement in the direction of fuel economy should be to ensure our coal being utilised, in the national interest, to the best and fullest advantage by every class of consumer. True economy, it has been said, lies not so much in using sparingly as in using well.

It is impossible to give any exact figures for the amount of coal used for various purposes in this Kingdom, and although estimates have, at one time or another, been made, they cannot be regarded at best as more than very approximate. In 1903 Mr. (now Sir) George Beilby made such an estimate for the Second Royal Commission on Coal Supplies, and, assuming that the same relative proportion between the various uses of coal still hold good, a further estimate for the year 1913 may be given, as follows:—

INTRODUCTORY

ANALYSIS OF THE USES OF COAL IN THE UNITED KINGDOM

	1903.	1913.
	Mill. Tons.	Mill. Tons.
(1) Mines and Factories	71·0	80·0
(2) { Iron and Steel Industries	28·0	30·0
{ Other Metallurgical Industries	1·0	2·0
(3) Brickwork, Potteries, Glass, and Chemical Works	5·0	6·0
(4) Gas Works	15·0	18·0
(5) Railways	13·0	15·0
(6) Coasting Vessels	2·0	2·0
(7) Domestic Purposes	32·0	36·0
Total	167·0	189·0
Total for Power Purposes	52·0	80·0

According to the above estimate, four-fifths of the coal annually consumed in the Kingdom can be accounted for under three heads, namely, (1) approximately 40 per cent. is used for generating mechanical power; (2) another 20 per cent. is carbonised either in gas works or for the manufacture of metallurgical coke; (3) whilst about 20 per cent. is used for domestic purposes.

The foregoing may be compared with the following official figures for the year 1907 (Census of Production):—

	1907
	Mill. Tons
Total Coal raised	266·6
Less—	
(1) Coal Exported	66·6
(2) Bunker Coal for Foreign-going Vessels	18·6
	85·2
Total	181·4
(1) Used in operating the Mines	16·7
(2) Carbonised in Gas Works	15·4
(3) For Blast Furnace Coke, etc.	21·1
(4) Other Iron, Steel, Engineering and Shipbuilding Industries	15·8
(5) Other Manufacturing Purposes	38·7
(6) Locomotive Coal on Railways	12·9
(7) Coastwise Bunkers	2·2
(8) All Other Purposes	61·5

COAL AND ITS SCIENTIFIC USES

That up to the present we have, as a nation, been wasteful and improvident in both getting and utilising coal cannot well be disputed. Under the present individualistic conditions, a vast quantity of usable coal is left behind in the mine simply because it does not pay to bring it to the surface. The Committee appointed by the British Association in 1915 for the Investigation of Fuel Economy and the proper Utilisation of Coal, in drawing special attention to the national importance of checking this waste by finding out in what ways the less valuable grades of coal can be turned to good account, expressed the opinion that "much of the coal now left behind in the mines ought to be converted into useful forms of energy and products for public purposes, and one of the most important aspects of the fuel economy problem in Great Britain is the devising and organising of means for making it possible to raise the hitherto wasted coal at an economic advantage."¹

In regard to the realisable margins of economy in the coal actually consumed in the Kingdom, the Second Royal Commission on Coal Supplies reported in 1905 that the possible saving in our then annual coal consumption of 167 million tons amounted to between 40 and 60 million tons; and in 1916, the British Association Fuel Economy Committee expressed the view that "notwithstanding the improved apparatus which has been put into use in the best factories throughout the country during the last ten years, the average result obtained for the country as a whole still lags behind the best obtainable to-day to a great a proportion as it did in 1905."²

In July 1916 the then Prime Minister (Mr. Asquith) appointed a Sub-Committee of the Reconstruction Committee, under the chairmanship of Lord Haldane, to consider the Conservation of our Coal Supplies.³ And in February 1917, the Committee of the Privy Council for Scientific and Industrial Research, on the recommendation of their Advisory Council, who had conferred on the matter both with Lord Haldane's Committee and with the British Association Committee, decided to establish a permanent Fuel Research Board to organise and carry out investigations into fuel problems. This step may be welcomed as a sign that the Government has at length realised its responsibilities to the nation in regard to the coal question.

¹ *British Association Reports*, 1916 (Newcastle-on-Tyne), p. 192.

² *Ibid.*, p. 193.

³ The Report of Lord Haldane's Sub-Committee (now known as the Coal Conservation Committee of the Ministry of Reconstruction) will shortly be published (1918).

INTRODUCTORY

THE COST OF GETTING COAL IN THE UNITED KINGDOM AND PIT-HEAD PRICES

In connection with this all-important question a very informing paper, entitled "The Economics of Coal Production," was read before the London Section of the Society of Chemical Industry on December 4, 1917, by Professor Henry Louis of Newcastle-on-Tyne, from which the following details have been taken.

It is first of all pointed out that the cost of coal at the pit-mouth is made up of five items, namely:—(1) the value of it in its unsevered condition in the seam, which is covered by the term "royalty"; (2) the wages paid to the men engaged in its extraction; (3) the costs of various materials necessarily employed in connection with the working of a mine; (4) the cost of administration and other incidental expenses; and (5) the profit to the colliery proprietor, including the interest upon the capital employed.

According to official figures, the average cost of coal at the pit-head in the United Kingdom for the year 1913 was 10s. 1½*d.*, and Professor Louis has calculated that this cost would on the average be distributed as follows:—

TABLE IXB

	Per Cent.	s. <i>d.</i>
1. Royalty	5.35	0 6.5
2. Wages	62.55	6 4
3. Materials	16.45	1 8
4. Administration	7.00	0 8.5
5. Interest and Profit	8.65	0 10.5
	100.00	10 1.5

It would thus appear that labour is by far the principal item in the total cost of coal production. The item of wages may be subdivided into three parts, namely, those paid to (a) hewers, who actually get the coal and receive practically half of them; (b) other underground workers, who receive rather more than 30 per cent.; and (c) surface workers, who receive nearly one-ninth of them. It is a regrettable, and perhaps also a significant, fact that the average amount of coal produced per worker em-

COAL AND ITS SCIENTIFIC USES

ployed at the mines of Great Britain has been steadily decreasing during the past thirty years, as the following figures show :—

Decade.	Average Annual Output per Worker. Tons.
1883-92	320
1893-1902	295
1903-12	280

These figures, as Professor Louis remarks, " may be to some little extent accounted for by the fact that the thicker and more easily worked seams are gradually becoming exhausted, and the production from the thinner seams is gradually forming an increasing proportion of the total, but the diminution in efficiency due to this cause should be far more than counter-balanced by the increased use of underground machinery, especially of coal cutters and face conveyors, which greatly multiply the working capacity of the hewer."¹ And he considers that an increase in the output per man employed is imperative in the interests of the nation at large.

Between the pit-head and the consumer there intervenes the railway or steamship company and the various merchants or middlemen. Professor Louis estimates that the average distance travelled by coal which comes into London by rail is something like 130 miles, and that the average freight is somewhere about 9s. per ton. The average cost of bringing coal from the collieries in Durham by sea to the London market (including discharging at the wharves) in 1913 is put at 5s. 7d. per ton, and the average price of sea-borne coal in barges in the Thames at 21s. per ton. There is no doubt room for some economies here, for not only might the cost of transit by rail be cheapened, but it is unquestionable that the whole system of distribution at present in vogue might with advantage be simplified and cheapened.

The effect of the war upon the annual outputs and pit-head prices of coal in Great Britain is shown from the following official figures for the three years 1914-16 inclusive :—

Year.	Total Output- Million Tons.	Average Price at Pit-head. s. d.
1914	265·6 .	9 11·8
1915	253·2 .	12 5·6
1916	256·3 .	15 7·25

¹ *Journ. Soc. Chem. Industry*, 36, 23, 1209.

CHAPTER II

THE ORIGIN AND FORMATION OF COAL

To understand the nature and composition of coal, as well as the different classes and varieties of it met with in our coal-fields, we must consider the kind of materials from which it originated, as well as the conditions under which these materials were, in the fulness of geological time, gradually transformed into the coal seams as we now know them. Our knowledge of these matters, of course, necessarily suffers from the recognised imperfections in the geological record, and, therefore, the scientific imagination has often to fill in gaps where precise information or definition is wanting. Therefore, while we are tolerably certain of the vegetable origin of coal, any view or theory concerning the factors and conditions operative at the various successive stages in the subsequent long transformation process is necessarily somewhat speculative and subject to reservation. Certain well-attested features which stand out prominently in the record may, however, be regarded as more or less common ground.

Although many classes and varieties of coal occur in Nature, all of them represent some stage or product of the primary decomposition and subsequent transformation, under the combined influence of slowly increasing pressure, and possibly also of temperature, of the vegetable *débris* of primæval forests and swamps. This process has gone on in several of the great geological periods, and, so far as its early stages are concerned, is being repeated to-day under somewhat different conditions in our modern peat bogs and deltas, where enormous masses of water-logged vegetable *débris* are decomposing under bacterial influence.

A consideration of the geographical distribution of the world's principal coalfields shows that all the important fields adjacent to the North Atlantic and Arctic areas (which include nearly all the fields of North-West Europe and in the eastern part of North

COAL AND ITS SCIENTIFIC USES

America) originated in what geologists call the Carboniferous Period of the Primary Era; while what may be termed the "Indian Ocean" group of coalfields (which include those of China, India, Australia, and South Africa) originated in the somewhat later Permo-Carboniferous Period. Mesozoic coals are found in the interiors of North America and Asia (intra-continental group); while Tertiary coals are chiefly found in what may be termed the Pacific borderland (west of North America, Japan, and New Zealand), as well as in regions bordering on the Gulf of Mexico and the Mediterranean.

The great coalfields of the Carboniferous System originated in a new monster vegetation flourishing in a rich virgin soil, with an equable if not subtropical climate, and large areas of shallow sea, to which great quantities of sediment were borne from rivers. Vegetable tissue has in all ages, then as now, been built up by the action of chlorophyll under the influence of sunlight, stimulated by minute quantities of mineral salts drawn in by the roots, upon atmospheric carbon dioxide and moisture, which action sets up a complex series of chemical changes, with the intermediate formation of sugars and starches, ultimately resulting in the production of celluloses and ligno-celluloses, as the basis of all woody tissue.

Celluloses, which form the structural basis of the vegetable world, comprise a class of carbohydrates of the general formula $nC_6H_{10}O_5$ (C = 44.4, H = 6.2, and O = 49.4 per cent.). Taking $C_6H_{10}O_5$ as the simple "constituent group" of cellulose, in which there are grounds for believing that four out of the five oxygen atoms react as OH groups, it is probable that the celluloses are aggregates of such constituent groups in a special molecular configuration of cyclic character. The process of "lignification" in the plant cell is, according to Cross and Bevan, characterised by the formation of groups of the general form—

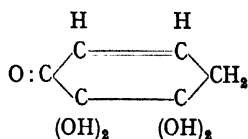

Ligno-celluloses may be regarded as built up primarily of (1) a *lignone* portion, consisting of a reactive "keto R. hexene group" and a "furfurose" (*i. e.* furfural-yielding) complex; and (2) a *cellulose* portion, which, however, is not homogeneous but re-

THE ORIGIN AND FORMATION OF COAL

solvable into a more resistant and a less resistant group, as follows:—

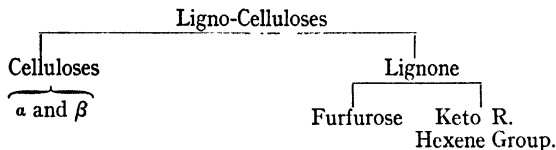

In general, and for statistical purposes, it may be considered that the process of "lignification" is essentially a dehydration of cellulose—

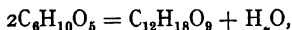

and that, under normal conditions of growth, the ligno-celluloses are further progressively dehydrated.

Schultze and Schuppe have investigated the composition of wood tissue, and the latter expresses it as an aggregate of cellulose and a lignone complex $C_{19}H_{18}O_8$, thus—

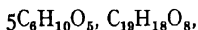

from which it would appear that whilst wood tissue is similarly constituted to a typical ligno-cellulose, it contains a higher proportion of lignone and a lower proportion of cellulose.¹

The percentage composition of these various substances may be summarised as follows:—

		C.	H.	O.
<i>Celluloses</i>	$C_6H_{10}O_5$	44·40	6·20	49·40
<i>Ligno-celluloses</i>	$C_{12}H_{18}O_9$	47·05	5·88	47·05
<i>Wood tissue</i>	$5C_6H_{10}O_5, C_{19}H_{18}O_8$	49·66	5·74	44·60
<i>Wood</i>		49·0–50·4	6·0–6·25	45·0

The vegetable forms which flourished in the Carboniferous Period were of simpler structure, but of much greater size than those which are predominant to-day—gigantic ferns, club mosses, horsetails, and forms intermediate between ferns and cycads—and it is demonstrable that in certain cases (*e. g.* the Moira seam near Loughborough in Leicestershire) entire beds of coal have been formed from the spores of such plants.

Much controversy has waged round the question whether or not coal formation has occurred upon the actual site of the original vegetable growth, and in certain cases the question can

See Cross and Bevan's *Cellulose*, 1916 edition.

COAL AND ITS SCIENTIFIC USES

be answered affirmatively. The necessary conditions in such a case would be a dense forest growth in swampy areas (estuarine or in great inland swamps), together with such oscillations in level as are known to have occurred during the Carboniferous Period. The rotting vegetable *débris* would, during a period of subsidence, be overlaid with layers of water-deposited sands and clays, which on re-elevation, would provide a suitable soil for renewed vegetable growth. Proof of such conditions is afforded by the occurrence of "under-clays" or fire-clays with fossil roots (*stigmaria*) below the coal seams in certain areas (*e. g.* the Yorkshire coalfield). Other coalfields, however, undoubtedly owe their origin to enormous masses of vegetable *débris* brought down from higher levels and deposited either in deltas or in land-locked seas or lakes. Such fields show no fossil roots in the understrata, and in some cases fossil remains of aqueous and marine life are found immediately above and below the coal seams.

Imagine then such vegetable *débris*—whether in the actual site of growth or after transportation by river to some other place—decaying under shallow water or other covering sufficient to protect it from direct atmospheric action. Bacterial action (aërobic fungi and anaërobic organisms, the relative influences of which depend on the varying water level in the bog and the formation of ulmic acid) would set in, much as in existing peat bogs, with evolution of enormous quantities of marsh gas (methane) and carbon dioxide. Thus M. Renault, from an extensive study of peat formation, represents the transformation from cellulose to a bituminous coal by the equation—

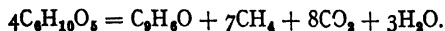

A substance of the formula C_9H_8O would contain C = 83.1, H = 4.6, O = 12.3, which approximates to the composition of an average bituminous coal.

Such primæval swamp forests would, with gradual fall in level, become submerged to a greater extent, and be covered with water-borne *débris* and mineral matter, which, on subsequent re-elevation, would be ready for a fresh vegetable growth. Repetitions of the process—*i. e.* submersions alternating with re-elevations or filling up—would produce several distinct deposits of decomposed vegetable matter separated by mineral matter of sedimentary origin, which would ultimately give rise to the various separate seams of coal found in our modern coalfields.

THE ORIGIN AND FORMATION OF COAL

Finally, such successive deposits would, in the course of geological time, become buried as a whole under newer mineral strata, whose accumulation would "blanket" the incipient coal measures, causing a gradual increase in both temperature and pressure. Moreover, it is known that, during the later stages of the Carboniferous Period, the "blanketed" strata were subjected to intense disturbances, the effect of which would be to cause the present distribution and local destruction by denudation of the measures. These causes, operating successively, would sufficiently account for the transformation of the original decaying woody tissue into bituminous coal and anthracite. Moreover, such changes would necessarily involve both great shrinkage in bulk and loss of weight in the original vegetable *débris*; thus it has been demonstrated that the existing coalfields represent about 20 to 28 per cent. only of the original weight and one-tenth only of the bulk, of the original woody tissue from which they were formed.

As might be expected from its origin and mode of formation, coal is by no means uniform in character or composition. Differences in respect both of the character of the original organic *débris*, and of the physical conditions under which it was deposited and subsequently transformed in the coalfields, have contributed to produce the innumerable grades and varieties of coal, ranging from highly bituminous gas coals to anthracites, such as are found in British coalfields. Indeed coal is a generic term which includes a great many characteristic individual types and intermediate gradations, and it is the business of the chemist to define these and to discover how each may be utilised to the best advantage.

BRITISH COALFIELDS

The succession of strata in the Carboniferous System, and the occurrence of the Coal Measures therein, is so well represented by their development in Great Britain that it will suffice for the purpose of this general review if, for the present, we confine our attention to the predominating features of our own coalfields. A glance at a geological map of Great Britain will show that practically all the areas in which the Carboniferous System comes to the surface lie, in England, between two parallel lines, the one drawn through Hull and Portland and the other through Berwick and Pembroke, and in Scotland between similar parallels, the one drawn through Dunbar and Stranraer and the other through

COAL AND ITS SCIENTIFIC USES

Perth and Dumbarton. In all the areas to the north and north-west of the said two strips of country (*i. e.* the Scottish Highlands and the Borderland, Cumberland (except the north-west part) and Westmoreland, Central Wales, and also Devon and Cornwall) the surface strata are nearly all of pre-Carboniferous origin, and in such areas no Coal Measures are found. On the other hand, in the great area to the south-east of the Hull to Portland line, the Carboniferous strata are now overlain by later Mesozoic and Tertiary strata, and it is probable that coal-bearing measures lie deep underground in parts at least of this area.

The rocks of the Carboniferous System fall into three main divisions, namely:—(1) the *Carboniferous or Mountain Limestone*, undoubtedly of marine origin, resting on the Old Red Sandstone (Devonian) or older rocks, and attaining to a maximum thickness of 2000 feet in South-West England, in South Wales, and in Derbyshire. The upper portion of this Formation consists of shales and sandstones (*e. g.* the Yoredale Rocks in the borderland between Yorkshire and Lancashire). The thickness of the limestone beds diminishes and that of the shales increases northwards, until in Scotland they develop into a sequence of coal-bearing strata known as the Edge Coal series; (2) the *Millstone Grit*—a series of coarse sandstones and shales containing towards the north a few thin coal seams; and (3) the *Coal Measures* proper, which consist of alternations of shales and sandstones together with the main coal seams, and in some localities nodular deposits of clay ironstone (ferrous carbonate), making altogether a thickness of many thousands of feet (12,000 to 14,000 at their maximum development). These measures naturally fall into three groups, namely (*a*) the *Lower*, (*b*) the *Middle*, and (*c*) the *Upper Measures*, all of which contain workable coal seams. The more valuable seams are as a rule in the *Middle Measures*. The uppermost strata consist of clays, marls, and sandstones similar in character to those of the Permian System which usually lie immediately above the Carboniferous Series.

It is probable that nearly the whole of Great Britain south of the Scottish Highlands (with the exception of Cumberland and Westmoreland, Central Wales and its eastward extension, and Cornwall), was in Carboniferous times laid down with continuous sheets of vegetable *débris*, which were subsequently transformed into coal seams, and that the discontinuities now observable in the coal areas were caused by post-Carboniferous disturbances, and subsequent denudations. Thus, for example, there is little

THE ORIGIN AND FORMATION OF COAL

doubt but that the now separate coalfields of Lancashire and Yorkshire were originally laid down as one sheet of coal measures, the continuity of which was subsequently broken by the elevation of the Pennines followed by extensive denudations.

In the actual coalfields, the coal occurs in a number of more or less regular layers or seams separated by bands of mineral matter; these seams vary in thickness from a few inches to several feet and may often be followed continuously for a considerable distance without material change in character, as for example, in the celebrated "Barnsley Seam" of the Yorkshire coalfield. Sometimes, however, the continuity of the seams in a coalfield is repeatedly interrupted by faults, as for instance, in the North Staffordshire and Lancashire coalfields, both of which are much faulted. The thickest seam in this country was the celebrated Ten-Yard Seam in the South Staffordshire coalfield, which in the neighbourhood of Dudley formed one almost continuous mass of from 30 to 40 feet in thickness, but further north it splits up into eight seams, which, with the intervening shales and sandstones, attain a total thickness of 400 feet in the northern end of the field (Cannock Chase).

The coalfields of Great Britain may be grouped geographically into three principal areas, each having distinctive features, namely: (a) *Southern* (South Wales, Forest of Dean, Bristol, and Kent); (b) *Central* (Lancashire and North Wales; Yorkshire, Derbyshire, and Nottinghamshire; Leicestershire; Staffordshire, and Warwickshire); and (c) *Northern* (Scotland, Northumberland and Durham, and Cumberland). This grouping is that adopted by Dr. Walcot Gibson in his well-known book on *The Geology of Coal Mining*, to which the reader is referred for more detailed information than it is possible to give in this chapter. The more important fields are as follows:—

(1) *South Wales* (Monmouth, Glamorgan, Carmarthen, and Pembrokeshire), covering an area of about 850 square miles, of which 150 are under the sea, with seams from 1 to 12 feet (average 2.5 to 3.0 feet) thick, and yielding all classes of coal, namely, bituminous (31 per cent.) steam coals (47 per cent.), and anthracites (22 per cent.).—The Carboniferous strata lie in an elongated basin which is almost completely surrounded by older formations, and complicated towards the south by an anticlinal fold running east and west. The basin is much faulted, and the rivers have cut a series of deep valleys along which the coal seams crop out. Speaking generally, and for corresponding depths below the

COAL AND ITS SCIENTIFIC USES

surface, there is a gradual transition in the character of the coal from the coking varieties in the east and south-east, through the first-class steam coals of the centre, to the semi-anthracites and anthracites in the west and north-west. The supposition that the anthracitisation has been due to the seams having been subjected to an increasing earth pressure has been questioned by Strahan and Pollard (*Memoirs of the Geological Survey*, 1908) who, from the fact that the ash content of the anthracites is invariably much lower than that of the bituminous seams which are their continuation, suggest that the difference between the two classes of coal may be due to some original disparity in the vegetable *débris* from which they have been derived. In the eastern and south-eastern sections of the field, the upper and middle parts of the measures are chiefly worked, yielding good coking and bituminous coals; in the central sections, the middle parts of the measures (the Pennant Series) predominate, whilst in the extreme west the seams occur in lower parts of the measures only. The percentage composition of the more important classes of coals usually falls within the following limits:—

TABLE X

Class.	C.	H.	O. and N.	S.	Ash.	Volatiles
Anthracites	91.0-93.0	3.0-3.7	1.9-3.5	0.7-1.0	0.7-1.7	5.0-6.0
Steam . .	85.0-90.0	4.0-4.7	3.5-4.5	0.7-1.5	2.0-3.3	7.0-20.0
Bituminous (coking) .	80.0-95.0	5.0-5.5	—	—	—	20.0-25.0

(2) *Forest of Dean*.—A small field (34 square miles) forming a complete basin between the Wye and Severn valleys, and containing thirty-one seams, of which only sixteen exceed 1 foot in thickness. The total thickness of the measures is 2765 feet, and they are completely girdled by older formations. The coals resemble in character those found in the eastern section of the South Wales field; the upper and middle parts of the measures yield excellent gas and house coals, whilst the lower parts, which, however, are difficult to work, owing to accumulations of water therein, contain good steam coals.

(3) *Bristol* (Somerset and Gloucester).—The coalfields of this region form a number of basins of varying areas (total = 2385 square miles), the edges and outlines of which are masked by newer rocks, so that there are five or six detached "exposed"

THE ORIGIN AND FORMATION OF COAL

fields and a considerable intervening area of "concealed" coal-fields. They may be divided into three groups, namely: (a) *Southern*, with twelve workable seams, having a total thickness of 23 feet, (b) *Central*, with thirty-five seams, of average total thickness of 65 feet, and (c) *Northern*, with seven seams, having an average total thickness of 10 feet. The measures are divided into upper and lower portions by a sandstone bed, some 2000 to 2500 feet in thickness, known as the Pennant Rock, which, although it contains locally some thin coal seams, is practically unproductive. The upper parts of the measures (the Radstock and Farringdon Series) yield bituminous house and gas coals; the lower part (Kingswood and Vobster Series) yield both house and coking coals. The combined annual outputs of the various fields is comparatively small, and is almost all consumed locally.

(4) *Kent*.—This field, which was first actually proved by an experimental boring at Shakespeare's Cliff, Dover, begun in 1886, in which Coal Measures were encountered at a depth of 1100 feet below the surface, is generally considered to be a westward prolongation of one of the basins of the N. French and Belgian coalfields (Liège, Calais, etc.). The coals are similar to those of the Somerset field and are all bituminous in character.

(5) *Staffordshire*, divided into (a) North Staffordshire (100 square miles), and (b) South Staffordshire (150 square miles).—In the *North Staffordshire*, or *Potteries*, area the Carboniferous sequence (i. e. of upper, middle, and lower coal-bearing measures underlaid by the Millstone Grit and Carboniferous Limestone) is complete although much broken by faults. With the exception, however, of two seams, which have been worked along the eastern boundary in the lower portions of the measures, all the principal workable seams (fourteen in number) occur in the middle portions of the measures and most of them average 6 feet in thickness. They yield good coking as well as gas, house, and furnace coals. Some of the seams are worked in conjunction with the Black Band ironstone found in the Coal Measures in this area.

The *South Staffordshire* area is divided by a fault into a northern and a southern section. The northern section contains some fourteen workable seams in the middle portions of the measures; towards the south the measures thin out considerably in respect of total thickness, and a number of the individual seams are found to have converged, finally forming the once famous Dudley Ten-Yard Seam. Neither Millstone Grit nor Carboniferous Limestone occur below the coal-bearing measures. The coals

COAL AND ITS SCIENTIFIC USES

obtained include both gas, house, and furnace varieties; but neither "steam" nor "hard coking" coals are found. In places the coals have been damaged by igneous intrusions such as that of Rowley Regis.

* (6) *Warwickshire*.—This coalfield comprises an area of about 60 square miles in the North and North-East of Warwickshire, between Tamworth, Nuneaton, and Coventry, in which the sequence of the Carboniferous rocks is the same as that found in South Staffordshire (*q.v.*). The total thickness of the productive measures is greatest in the north, where also the individual seams are most numerous; towards the south the measures get thinner and some of the separate seams converge to form much thicker ones, as in South Staffordshire. The coals are generally "oxidised" and, therefore, non-coking, with a high percentage of "volatiles."

(7) *Leicestershire*.—The "exposed" coalfield in North-West Leicestershire covers an area of about 30 square miles, beyond and around which, however, the Coal Measures continue for another 54 square miles as a "concealed" field under later Triassic rocks. Unlike the coal-bearing measures in South Staffordshire and Warwickshire, those of Leicestershire are underlaid by Millstone Grit and Carboniferous Limestone. The coals are free-burning and similar in type to those of Warwickshire.

(8) *Yorkshire, Derbyshire, and Nottinghamshire*.—This, perhaps the largest of all our British coalfields, comprises an area of 808 square miles of "exposed" and 1328 square miles of "concealed" measures. The "exposed" measures stretch in an unbroken line for a distance of 65 miles from Leeds in the north to Nottingham in the south, the breadth being about 23 miles at its maximum towards the north, and about 10 miles at its minimum near the southern end. Throughout the area the sequence of the Carboniferous Formation is complete, the coal-bearing measures being underlaid by the Millstone Grit and the Carboniferous Limestone, and they have nowhere been affected by igneous intrusions. The upper measures have been proved in boring operations under the New Red Sandstones, but they are everywhere unproductive of coal. The chief workable seams nearly all belong to the middle parts, although one or two important seams occur in the lower parts of the measures. The coals are highly bituminous, with from 25 to 45 per cent. of "volatiles," and, although varied in character, are nearly all of high-grade quality. Some of the best English house and gas coals, as well as good coking and steam coals are derived from the different

THE ORIGIN AND FORMATION OF COAL

seams in this field. Speaking generally, most of the seams found north of Sheffield have marked coking properties, although none of the coals yields so good or hard a metallurgical coke as do the famous Durham coking coals. South of Sheffield the coking properties of the coals diminish, but their gas-making qualities improve. In the southern part of the field (Notts) the seams have apparently been "oxidised," and although the coals obtained from them yield a large amount of gas, they are non-coking. The celebrated Barnsley Bed yields a hard "steam" coal which is a good locomotive and marine boiler fuel, whilst the well-known Silkstone Beds are unsurpassed for their gas and house coals.

(9) *Lancashire*.—An irregular area, much faulted and broken by an E.-W. anticline, extending from Burnley in the north to Ashton-on-Lyne on the south (with a long tongue projecting southwards through Stockport to Macclesfield), and from Oldham in the east to St. Helens in the west. The total "exposed" area is about 500 square miles. The principal seams in the southern and central areas of the field are all found in the middle parts of the measures, the upper parts nowhere containing workable seams. The seams in the lower part of the measures become important in the northern districts in the neighbourhood of Accrington and Burnley. The coals got from the seams in the middle parts of the measures belong almost exclusively to the "gas-coal" class and generally contain from 30 to 35 per cent. of "volatiles." Several of these seams, notably the Yard Mine, Arley, and Trencherbone, yield a fairly good coking coal. The famous "Mountain Mine" seams occurring in the lower parts of the measures (Burnley and Accrington) yield coals containing from 26 to 27 per cent. of "volatiles," which produce a coke almost, if not quite, equal to the best Durham coke.

(10) *North Wales* (Flintshire and Denbighshire).—This field (area = 103 square miles) is similar in character to the Lancashire field. All the workable seams, however, are in the middle parts of the measures. The coals are similar in character to those occurring in the southern and central portions of the field; they contain from 33 to 35 per cent. of "volatiles," and yield a fair quality of coke.

(11) *Durham and Northumberland*. In the great Northern region of which Durham and Northumberland form an important part, there is a development of coal seams (more strongly marked the farther north) in Lower Carboniferous Rocks, the equivalent

COAL AND ITS SCIENTIFIC USES

of the Carboniferous Limestone, a feature which is absent in the Midland and Southern fields. The total area of the Durham and Northumberland field is about 800 square miles. In the Limestone Series there are a few workable seams which increase in number and thickness from south to north, but in the main part of the field the coal occurs chiefly in the middle parts of the measure. The southern and western districts of Durham produce, perhaps, the finest coking coals in the world, containing from 22 to 28 per cent. of "volatiles," and comparatively small amounts of sulphur or ash. The central district (Sunderland to Newcastle) produces fine qualities of gas and house coals. The Northumberland seams are for the most part "oxidised"; they contain a rather large amount of moisture and are non-coking. They are largely used for steam coals, and they are excellent as "gas-producer" coals.

(12) *Cumberland or Whitehaven Coalfield.*—The area of this field is 150 square miles, and the character of the coals is in general similar to those obtained from the northern districts of Durham.

(13) *Scotland.*—The Scottish coalfields extend from Fifeshire on the east, across a belt between the Forth and Clyde, thence westwards into Lanarkshire and Ayrshire, with an isolated small area in Midlothian. The upper parts of the measures are well developed throughout the area; the middle measures attain a thickness of from 800 to 1500 feet. Below the latter is the "edge-coal" group in the Carboniferous Limestone Series, highly inclined at its outcrop (Fifeshire, Midlothian), and containing bands of cannel. Generally speaking, the coals are bituminous, with a high percentage of "volatiles." The best coking varieties are found in the neighbourhood of Glasgow, and the coking seams stretch as far eastward as the Firth of Forth. The Ayrshire coals are chiefly non-coking, and are excellent as "gas-producer" coals. In Fifeshire the seams in the Carboniferous Limestone in the neighbourhood of Dunfermline yield first-class steam and house coals. The Scottish coalfields have been subjected to igneous intrusions to an extent rarely met with in England, and, consequently, some of the bituminous seams have been locally converted into steam coals and anthracitic varieties.

CHAPTER III

THE CHEMICAL COMPOSITION OF COAL

A. INTRODUCTION—OCCLUDED GAS—MOISTURE—ASH—COAL WASHING —SALTS IN COAL

FROM what is known of their origin and mode of formation it may in general be anticipated that all coals, whatever their geological age, will contain (1) various combustible organic compounds, complex in structure and of high molecular weight, representing the degradation or transformation products of the ligno-celluloses, resinous matters, and proteids in the vegetable *débris* from which they were originally derived; and (2) variable amounts of mineral matter, which give rise to the "ash" remaining when the coal is burnt, and which represent partly the small amount of mineral matter in the original vegetation, or the soil in which it grew, and partly also other associated mineral matters either deposited contemporaneously with the coalfield or subsequently introduced by infiltrations.

The various organic bodies, which together form what is sometimes termed the "coal substance," are all compounded chiefly of the elements carbon, hydrogen, oxygen, nitrogen, and sulphur, the relative proportions of which may be determined with considerable accuracy by the usual methods employed for the analysis of organic compounds generally. But the ascertainment of the nature of the various complexes which make up the coal substance, and still more so of the relative proportions in which they are present in any particular coal, is a problem beset with such difficulties that its solution has hitherto proved well-nigh beyond achievement by any present known method of chemical attack.

OCCLUDED GAS

It has been long recognised that coals, like most other non-vitreous solids, have the power of "occluding" gases, and as during the process of their formation from the original vegetable *débris* vast quantities of gases were evolved, it is to be expected

COAL AND ITS SCIENTIFIC USES

that coal as it occurs in the seam will contain "occluded" gases. Any gas so occluded in freshly-won coal, which as a rule does not exceed 5 c.cs. per gram, may be withdrawn by continuous exhaustion of the finely divided coal either at the ordinary temperature or at 100° C. The composition of such gas varies considerably, but carbon dioxide, methane, or nitrogen are usually found therein. It has been suggested that two active processes are simultaneously set up as soon as the coal is removed from the seam, namely (1) an exudation of methane and other saturated hydrocarbons, and (2) an absorption of air causing oxidations within the coal substance. These processes, operating independently but concurrently, would, it is claimed, account for the observed variation in the composition of the gas withdrawn from samples of coal of different origin.¹

The subject has been investigated at different times by E. von Meyer in Germany, by W. J. Thomas, Bedson, McConnell, Trobridge, and R. V. Wheeler in England, and by S. W. Parr in America. The following typical figures are taken from the result of an extensive investigation by W. J. Thomas in 1875 upon the gases occluded in British coal:—²

TABLE XI

Coal.	c.cs. of Gas per Gram.	Percentage Composition of Gas.			
		CO ₂ .	CH ₄ .	N ₂ .	O ₂ .
Bituminous . . .	0·559	36·42	0·00	62·78	0·80
" . . .	0·551	5·44	63·76	29·75	1·05
Semi-bituminous . . .	0·736	12·34	72·51	14·51	0·64
Steam	2·501	13·21	81·64	4·66	0·49
" . . .	1·474	18·90	67·47	12·61	1·02
" . . .	5·555	2·65	93·13	4·25	—

The following analyses by P. P. Bedson and R. V. Wheeler indicate, as might be supposed, that ethane, as well as methane, is occluded in coal dusts, a circumstance to which attention has also been drawn in the Report of the Austrian Fire Damp Commission. R. V. Wheeler has found measurable quantities of carbon monoxide also in the occluded gases.

¹ S. W. Parr and Perry Barker, "Occluded Gases in Coal," *University of Illinois Bulletin*, No. 32 (1909).

² *Journ. Chem. Soc.* XIII. (1875), p. 793.

THE CHEMICAL COMPOSITION OF COAL

	Durham Coal Hutton Seam (Bedson).	Lancashire Coal Lower Mountain Mine (R. V. Wheeler).
Total gas in c.cs. per gram	1·6	1·375
CO ₂ , (H ₂ S and NH ₃)	4·35	1·00
CO	—	2·10
C ₂ H ₄	—	0·40
C ₂ H ₆	6·65	8·10
CH ₄	71·15	80·35
O ₂	2·80	0·40
N ₂	15·05	7·65
	<hr style="width: 100%; border: 0; border-top: 1px solid black; margin: 5px 0;"/> 100·0	<hr style="width: 100%; border: 0; border-top: 1px solid black; margin: 5px 0;"/> 100·00

MOISTURE IN COAL

Coal, when freshly mined, often contains much water ("pit water"). Most of it is lost, more or less rapidly according to the hygrometric conditions of the atmosphere and other circumstances, by a natural process of "air drying." The remainder is completely lost when the finely divided coal is maintained for a short time at 105° C. It is, however, to be borne in mind that the amount of water present in a coal at any moment is liable to variation, according to "atmospheric" conditions, and the circumstances of its storage. Thus a coal which has undergone a considerable amount of "air drying" in dry summer weather will slowly re-absorb moisture if exposed to a damp atmosphere. Hence the moisture content of a stored coal tends to increase in *damp* and to decrease in *dry* weather, and does not remain quite constant for long together.

Such variations led the chemists who were responsible for organising the chemical work in connection with the investigation of Canadian Coals, recently carried out under the auspices of the Dominion Department of Mines, to adopt, as a standard of air drying which should be independent of variations in atmospheric conditions, the plan of always drying a crushed sample of coal until its weight became constant in a current of air which had been drawn at the laboratory temperature through a solution of calcium chloride of sp. gr. 1·30. Since the vapour pressure of such a solution is approximately 0·58 that of pure water, and is not materially affected by small changes of temperature in the neighbourhood of the usual laboratory tempera-

COAL AND ITS SCIENTIFIC USES

ture, the method would produce a result corresponding to "air drying" at such temperature in an atmosphere of 58 per cent. humidity.¹ But inasmuch as all bituminous coals are liable, some more than others, to absorb oxygen slowly on exposure to air, it would perhaps be preferable to carry out such a process in a "current of nitrogen or other inert gas, where considerable accuracy is required.

"Messrs. Porter and Ralston,² of the U.S. Bureau of Mines, have recently published a paper on "Some Properties of Water in Coal," in which it is suggested that a discrimination should be made between what they term "free" water and "inherent" or "combined" water in coals. They also infer that the inherent water has a sub-normal vapour pressure, indicating the presence of variable proportions of colloidal matter in coals. This, however, is a subject which requires further investigation, especially in regard to lignitic coals, before any definite conclusions can be formed.

MINERAL MATTER (ASH) IN COAL

A *dry* coal always contains a variable amount of mineral matter associated with the coal substance itself and which gives rise to the ash when the coal is burnt. This mineral matter varies greatly in amount, colour, composition, and fusibility, and if either unduly large in amount or highly pyritic in character may affect detrimentally the commercial value of a coal.

A distinction must be drawn between the heavier mineral matter ("dirt"), such as pyrites (sp. gr. 5.0), shale (sp. gr. 2.5), and gypsum (sp. gr. 2.3), often irregularly mixed with freshly mined small coal (sp. gr. 1.2 to 1.3), and from which a separation can be effected either by hand picking or by mechanical washing (*q. v.*) and what is sometimes termed true or "fixed" ash of the coal, which is disseminated more or less uniformly throughout its entire mass and cannot be so removed. The heavier "dirt" represents either sedimentary mineral matter (*e. g.* shale) which was deposited contemporaneously with the coalfield, and which forms the "partings" between the various seams, or mineral matter (*e. g.* FeS_2) which may have been introduced by infiltrations of various solutions after the coal was laid.

The "fixed ash" of a coal varies considerably both in amount

¹ *Reports on an Investigation of the Coals of Canada*, Vol. II. (1912), p. 131.

² *Technical Paper 113*, U.S. Bureau of Mines.

THE CHEMICAL COMPOSITION OF COAL

and composition according to the locality of the seam from whence it is derived. Also, variations may sometimes occur both in the amount and character of the "ash content" along a particular seam. Such differences are usually gradual so long as they relate to the same "horizon" or axis of the seam, but they may be abrupt in a vertical direction in the seam, especially when the successive layers of the coal in it show marked differences in texture (e. g. the Barnsley Seam, South Yorkshire Coalfield). The investigation of the variations in the ash content of a particular coal seam, both along its main axis and also in directions vertical thereto at different selected places, may, therefore, be a very important matter in regard to the chemical survey of the seam.

No rule concerning the fixed mineral matter can be stated. It rarely amounts to less than 2 per cent. of the weight of the coal, and it may occasionally exceed 20 per cent. In a really first-class coal it should not be more than 7 or 8 per cent., and beyond a 12 per cent. content its presence may involve serious loss or inconvenience to the consumer. In the United States within recent years the practice has become prevalent of fixing a "standard ash content" when a contract for the supply of coal is made. The seller is then entitled to receive a premium of 1 per cent. per ton for each whole per cent. that the average ash in the consignment supplied is less than the stipulated standard percentage. An increase of 2 per cent. in the ash content over the standard figure is allowed without altering the contract price, but any excess beyond this 2 per cent. margin involves a deduction from the contract price amounting usually to 2 cents per ton for each 1 per cent. by which the ash content exceeds the penalty limit. (See also Chapter XI.)

A distinction must, however, be drawn between the "fixed" mineral matter as it actually occurs in the coal and the "ash" which remains when the coal is burnt, for these are not necessarily or usually the same, owing to chemical interactions during combustion between the mineral constituents, the air, and the coal substance itself.

The colour of the ash from a coal varies from a pure white (or cream) to a dark chocolate colour according to its ferruginous character, and its fusibility varies with its chemical composition over a wide range. A remarkably pure white ash which the author once found to an extent of 33.9 per cent. in an Australian bituminous coal contained—

$\text{SiO}_2 = 53.4$, $\text{Al}_2\text{O}_3 = 44.0$, $\text{CaO} = 2.0$, alkalis etc. = 0.5 per cent.

COAL AND ITS SCIENTIFIC USES

together with only the merest trace of iron oxide. Needless to say such a material would be infusible at the highest temperature ordinarily attained in a boiler or reverberatory furnace, and its presence, even in moderately large amount, would not interfere with the "free burning" qualities of the coal substance.

The following table will give some idea of the great variations found in the composition of the ashes of some typical English coals:—

TABLE XIII

Colour of Ash.	Northumberland Steam Coal.	Durham Hard Coking Coal.	Barnsley Hard Coal, South Yorkshire.	Lancashire Coals.				
	Grey.	Buff red.	Cream.	Wigan 4 Ft. Seam.	Arley.	Trenchbone.	Wigan 6 Ft. Seam.	Florida.
SiO ₂	40·6	44·5	48·0	31·40	26·40	39·40	33·80	30·00
Al ₂ O ₃	38·9	39·0	35·0	21·15	28·00	28·49	21·75	19·15
Fe ₂ O ₄	6·75	12·3	2·5	22·85	32·42	22·85	29·30	22·14
MnO	—	—	—	0·55	<i>nil</i>	0·40	<i>nil</i>	0·65
CaO	5·27	} traces	9·25	16·25	7·00	4·30	3·00	11·10
MgO	tracc		—	0·10	2·88	1·08	3·25	3·65
SO ₂	5·20	2·1	} 5·25	7·00	2·74	3·26	8·58	13·29
P ₂ O ₅ and Alkali	—	0·7		0·11	0·28	0·17	0·32	—

The relation of the fusibility of the ash of a coal to its chemical composition is a very important, though somewhat complex, question, concerning which the present state of our knowledge is not sufficiently definite to warrant the laying down of any precise rules. Inasmuch, however, as the simplest coal ash consists primarily of alumina and silica, to which, as the composition increases in complexity, are added chiefly lime and oxides of iron in varying proportions, the question of its fusibility is related to that of the fusibility of aluminosilicates (*e. g.* blast furnace slags) in general. The fusion points of mixtures of two constituents such as silica and alumina will vary regularly with the relative proportions of each, and there is a certain "eutectic" mixture of lowest melting-point. Similarly successive additions of lime C to a given mixture AB of silica and alumina will progressively lower its melting-point until a certain limiting propor-

THE CHEMICAL COMPOSITION OF COAL

tion ABC of lowest melting-point is reached, after which further additions of C will gradually raise the melting-point above this minimum temperature. Similar effects would again be produced by adding a fourth constituent D (Fe_3O_4) to a particular mixture ABC of alumina, silica, and lime. Hence the fusibility of the ash from a particular coal is commonly observed to increase up to a certain point sometimes with its ferruginous character, sometimes, however, with its lime content, and, speaking generally, with the content of some "most variable" constituent.

The question has been investigated by Dr. J. T. Dunn of Newcastle-on-Tyne, who has published the results of his analyses and fusion-point determinations of a series of nineteen different coals¹ (chiefly Northumberland = N, Durham = D, and West of Scotland = S), from which the following are selected as typical examples:—

TABLE XIIb

DR. J. T. DUNN'S ANALYSES AND MELTING-POINT DETERMINATIONS

No. of Sample	3	5	7	8	10	12	14	16	17	18
Origin	N.	D.	D.	N.	S.	S.	D.	N.	D.	Spitzbergen.
SiO_2	36.90	40.40	42.10	42.70	41.20	49.30	47.10	51.10	51.80	51.15
Al_2O_3	25.82	29.34	30.67	35.05	33.45	35.40	37.39	35.93	38.25	44.70
Fe_2O_3	25.00	15.21	21.70	8.79	17.14	7.29	11.14	4.86	5.64	1.25
MnO	0.30	0.30	0.30	trace	0.40	0.30	0.40	trace	trace	trace
CaO	3.71	4.61	0.99	5.84	3.70	2.96	0.82	2.78	0.45	1.15
MgO	2.10	1.96	0.76	1.30	1.78	1.34	0.65	0.80	0.74	0.36
Alkali	4.79	7.23	2.55	2.09	0.83	1.90	1.38	3.32	1.71	1.20
TiO_2	1.38	0.95	0.92	1.16	1.41	1.51	1.12	1.21	1.41	1.15
Melting-point C.	1150°	1230°	1340°	1380°	1390°	1460°	1460°	1480°	1500°	—

From Dr. Dunn's work it would appear that the melting-point of a coal ash may vary between as low as 1000° and 1500° C. (or even higher), according to its chemical composition, and that, although at present no general law can be formulated, the melting-point as a rule rises as the relative total *molecular* proportion of basic oxides to silica diminishes. It may be noted

¹ *Journ. Soc. Chem. Ind.*, 1918, **37**, p. 17T.

COAL AND ITS SCIENTIFIC USES

that the composition of the infusible Spitzbergen ash (No. 18) is nearly the same as that of the Australian example already quoted.

The coking properties of a coal are undoubtedly influenced to some extent by the composition of its ash, as also is the rapidity of combustion of the coal substance. Then, again, a highly ferruginous ash, such as is yielded by a pyritic coal, forms a fusible ferrous silicate which is a prolific source of "clinkering" trouble in furnaces and the like. For a given class of "steam" or "furnace" coals, the less ferruginous the ash the better; the same consideration would apply to the selection of a "gas-producer" coal from a number of otherwise suitable varieties. The formation of a fusible ferrous silicate from the ash constituents in the furnace of a locomotive boiler under high draught conditions is usually responsible for the formation of "swallow nests" in the front openings of the boiler tubes which so seriously impair the steaming capacity of the boiler.

COAL WASHING¹

The practice of washing small coal to free it from "dirt," which was introduced into this country from the Continent in connection with the by-product coking industry, is one of growing importance. It depends on the same principles and involves similar mechanical appliances as does ore concentration, in ordinary mining operations, with, however, the difference that whereas in ore concentration the valuable concentrate is heavier and much less bulky than the impurities which are rejected, in coal washing it is the lighter and more bulky material which is saved whilst the heavier impurities are rejected; for coal is one of the lightest of commercially important "minerals."

All coal-washing processes depend on the principle that if a mixture of coal and "dirt" be subjected to the action of moving water, accompanied by some sufficiently rapid "jerking" action, the heavier "dirt" will sink more rapidly than the lighter coal which will be carried forward by the flow. By suitably regulating the flow of water and the mechanical agitation in relation to the amount and grade of the material put through the apparatus in a given time, and by arranging for the re-washing

¹ For further information on this subject the reader is referred to the *Reports of the U.S. Geological Survey* (1905), Vol. III., and of the *Investigations of the Coals of Canada*, by J. B. Porter and R. J. Durley (1912), Vol. I., to which the author desires to acknowledge his indebtedness.

THE CHEMICAL COMPOSITION OF COAL

of the coal and dirt, respectively, resulting from the first operation, an almost complete separation of the two on a commercial scale can be ultimately effected.

The coal as it comes from the mine is usually passed first of all over a belt where any large lumps of shale or shaley coal are picked out by hand. Then it is screened to separate the lump coal from the smaller grades, for in most cases it is only the latter that are treated in the washing. Sometimes, however, the whole of the mine output is crushed to a limited extent, in order to detach more completely the worthless mineral matter from the coal, after which the crushed material is screened into suitably graded sizes before it goes to the washery.

In the best practice the coal to be washed is screened into a number of different sizes (*e. g.* nuts = $\frac{3}{4}$ inch to 1 inch, beans = $\frac{1}{2}$ inch to $\frac{3}{4}$ inch, peas = $\frac{1}{4}$ inch to $\frac{1}{2}$ inch, and fines = 0 to $\frac{1}{4}$ inch mesh), and each size is separately washed. The "fines" should preferably be removed, otherwise a troublesome slurry may be formed in the washery. It may here be pointed out that if coal as won from the mine be screened into a number of different sizes, the smaller grades, and especially the fines, are usually found to contain a greater proportion of mineral matter than the larger sizes. A big lump of coal usually contains a minimum proportion of ash, having regard to the average ash content of the seam whence it came. This is due to the circumstance that, in general, the friability of a coal increases with a growing mineral content. It has also been found in "washery" practice, that whereas small masses of mineral impurities may be easily separated from pieces of coal up to (say) from three to six times their own size, it is much more difficult to effect a satisfactory separation if the "size ratio" is much greater than about six; and in general, the greater the difference between the specific gravities of the coal and the associated mineral matter, the greater the "size ratio" which can be allowed for effective washing.

The chief types of appliances employed in coal-washeries are (1) *trough washers*, in which the graded coal is fed continuously into the upper end of a narrow inclined trough up which a set of scrapers are slowly moved on an endless chain arrangement against a regulated downward flow of water. The material is thus kept in a continual state of movement against the descending stream of water. The heavier refuse is carried upwards and finally discharged at the top, whilst the lighter coal, being carried

COAL AND ITS SCIENTIFIC USES

downwards by the water, is discharged at the bottom; (2) *fig washers*, in which the coal is continuously fed on to a sieve immersed in a trough of upward flowing water. Either the sieve is given a rapid "jerky" motion, or the sieve being fixed, a rapid pulsating motion is imparted to the water flowing through it. In either case a stratification of the lighter coal and the heavier mineral matter is effected gravitationally, and the separated coal is continuously pushed out at the top of the apparatus by the new material which is being fed into it.

The different washing schemes in vogue may be divided into two main classes, namely (1) those in which the coal is sized and graded before it goes to the "washery"; and (2) those in which, after all lump coal above (say) 3 inches has been removed, the main bulk of the coal is subjected to a preliminary washing, then screened into sizes, the smaller of which are subsequently re-washed.

The following scheme (Fig. 6) relating to a plant erected some years ago at the Monopol Colliery near Dortmund, may be cited as an example of the first of the above-mentioned classes. The coal as it came from the mine was screened into three sizes, namely (1) cobbles, (2) intermediates, and (3) smalls. The two first-named sizes were loaded direct into trucks for immediate despatch to the buyer, but the "smalls" were again screened and then washed in accordance with the plan shown in the diagram.

The performance of a British Baum Washery at a colliery in the North of England may be described as representative of one of the best modern systems of coal-washing. The special feature of this particular plant is that all coal below 2 inches square is washed in a Baum Washer Box (Plates I and II), which is divided into two sections or compartments, E and M, each containing a fixed sieve bed, that, K (Plate I), of the first compartment, where all the larger and heavier dirt is removed, being set at a slight upward inclination in the direction of the overflow, whilst that, R, of the second compartment, where the lighter dirt is removed, is fixed horizontally. The necessary pulsating motion is imparted to the water in the two compartments by means of compressed air at about 2 lb. per square inch pressure, which is admitted intermittently at T, *well below the level of the sieves*, through a special regulating valve provided with a sleeve piston which is moved up and down by means of an eccentric. The result is a short and energetic upward movement of the water in the washing compartment, followed by a



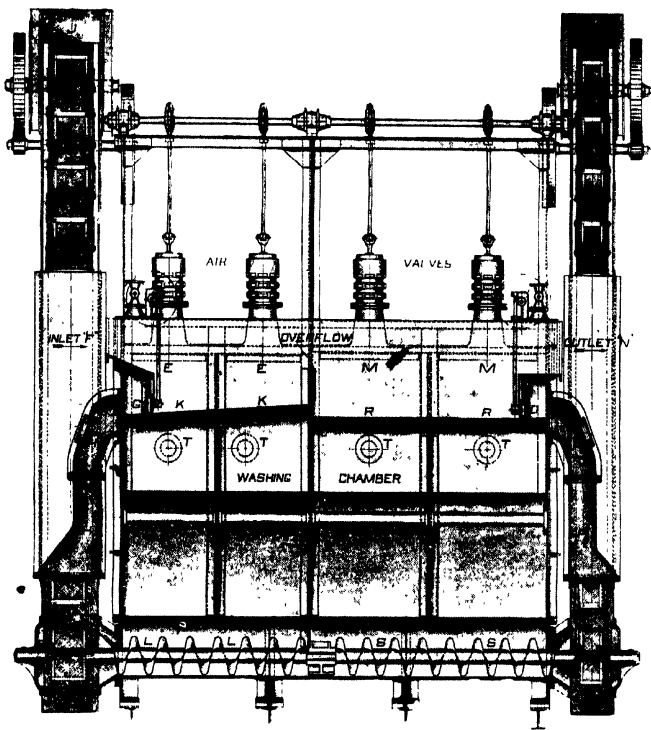

PLATE I -Bum Washer Box (Front Elevation)

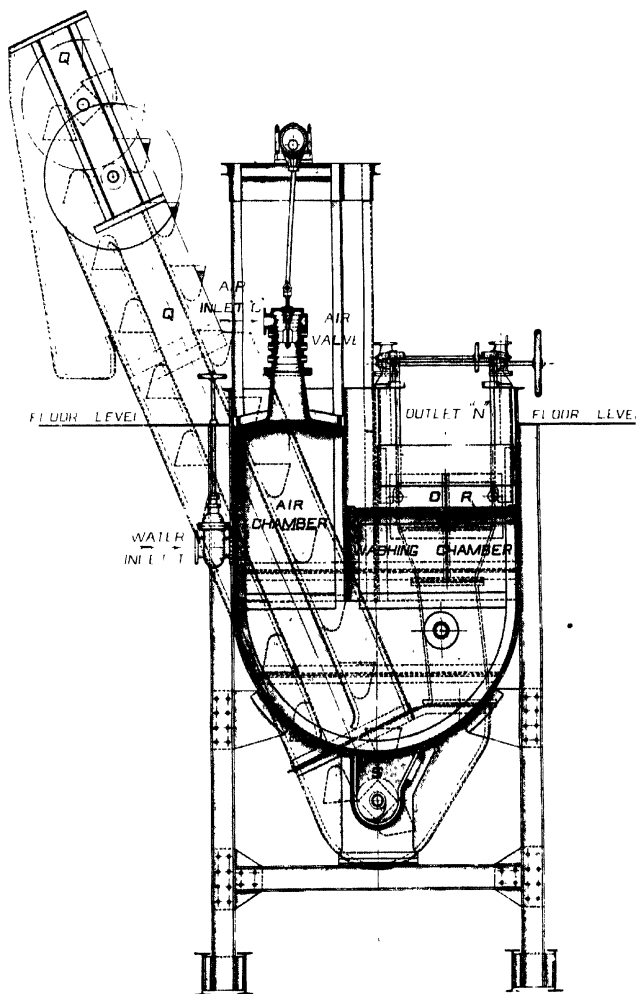

PLATE 11 — Baum Washer Box (End Elevation).

THE CHEMICAL COMPOSITION OF COAL

gentle downward movement, which allows ample time for the materials on the washer bed to segregate in accordance with their respective specific gravities, the heavier dirt going to the bottom and the lighter coal remaining on the top. The washed coal is then separated into three sizes, namely, (1) *nuts* (2 inches

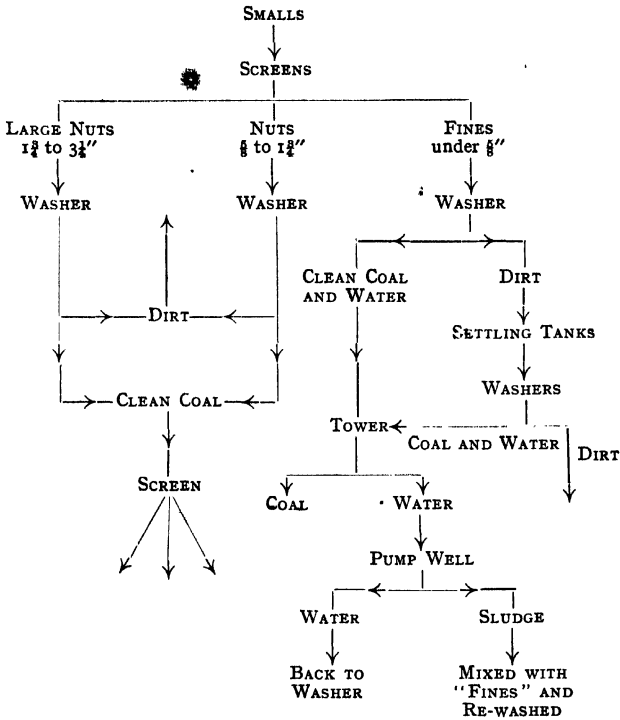

FIG. 6.

to $\frac{3}{4}$ inch); (2) *peas* ($\frac{3}{4}$ inch to $\frac{3}{8}$ inch); and (3) *finer* (below $\frac{3}{8}$ inch). The "finer" are subsequently re-washed and drained on a special Slurry Refiner, which ultimately delivers the fine-washed coal in a comparatively dry condition.

The water drained from the "finer" is sent forward to an elevated Settling Tank consisting of a circular inverted cone carried on columns. The tank is placed at a sufficiently high

COAL AND ITS SCIENTIFIC USES

level to enable the clarified water to be returned to the Washery at the required head for working same, also to force the slurry settling in the bottom of the tank on to the Slurry Refiner where the slurry is drained along with the " fines."

The plant in question (Plate III) deals each hour with 100 tons of coal, containing 22.5 per cent. of mineral matter, and reduces the latter to between 6.5 and 7.0 per cent. with a loss of less than 2 per cent. of the coal substance itself, the net expenditure of water amounting to no more than 15 gallons per ton of coal washed.

The following figures, taken from a Report by F. C. Lincoln of the University of Illinois, may be cited as showing the marked improvement effected in a low-grade coal by washing it in suitably screened sizes :—¹

TABLE XIII

	Raw Coal.	Coal as Screened and Washed.				
		1½" to 3½"	1" to 2½"	¾" to 1½"	¾" to 1"	0 to ¾"
% Ash	20.81	8.53	8.31	8.96	9.6	12.65
% Sulphur	3.84	3.11	2.98	3.12	3.0	3.13
Calorific Value						
B.Th.U.s. per lb. . .	11,166	13,125	13,185	12,095	12,935	12,445

In conclusion, the following summarised results of a trial with a Canadian coal from the Emery Seam of the Dominion Coal Co., conducted by Dr. J. B. Porter on the experimental washing plant in the Mining Department of the McGill University, Montreal,² will give a still better idea of the possibilities of coal-washing in relation to low-grade coals. The coal, already crushed to pass a 3-inch screen, was further reduced to a 1-inch in a " Comet " breaker, after which it was passed through a revolving screen of three sections perforated with ¾, ½ and ¼ inch round holes respectively. The resulting grades of ¾ inch and upwards were finally washed in two sizes, namely, ¾ to ½ inch, and ½ to 1 inch, respectively, in a jig washer, whilst the fines (0 to ½ inch) were separately treated in another type of washer. The original coal, as delivered from the mine, contained (when dry) 11.1 per

¹ *University of Illinois Bulletin*, No. 69 (1914).

² *Investigation of the Coals of Canada*, by J. B. Porter and R. J. Durley, Vol. I. (1912), pp. 198 to 200.



THE CHEMICAL COMPOSITION OF COAL

cent. of ash, 2.5 per cent. of sulphur, and had a calorific value of 13,122 B.Th.U.s. per lb.

RESULT OF WASHING TEST

TABLE XIV

	Sizes between 1" and $\frac{1}{2}$ ".		Sizes between $\frac{1}{2}$ " and $\frac{1}{4}$ ".		Sizes below $\frac{1}{4}$ ".
	Quantity lb.	% Ash.	Quantity lb.	% Ash.	lb.
Original Coal . . .	3170	10.2	1757	9.1	1214
Washed Coal . . .	2790	5.6	506	5.4	973
Refuse	372	46.7	182	46.7	113
Slimes	—	—	17	19.1	105

TABLE XV

	lb.	Calorific Value B.Th.U.s. per lb.	% Ash.	% Sulphur.
Original Coal	6141	13,122	11.1	2.5
Washed Coal	5434	13,878	5.8	2.1
Refuse	635	—	47.5	—
Other Products	73	—	—	—

- Decrease in Ash due to Washing = 47.8 per cent.
- " " Sulphur " " " = 16.0 " "
- Increase " Boiler Evaporation " " = 5.8 " "
- Decrease " Clinkers in Boiler Furnace = 52.2 " "

SALT IN COALS

Some coals, besides containing insoluble mineral matter, are impregnated with minute quantities of soluble salts, principally the chlorides of sodium, potassium, and magnesium, and are thus called "salty coals." The presence of such salts in coking coals is very detrimental to the brickwork of the coke-oven walls at high temperatures, for it is commonly agreed that "salty" coals produce a far more rapid corrosion of the refractory oven walls than those which are comparatively free from "salty" constituents. It may here be pointed out also that soluble salts may be introduced into a coal, originally comparatively free from them, during any "washing" process preparatory to charging the coal into the ovens, unless care is taken to avoid using water containing an undue proportion of such soluble salts. Hence the

COAL AND ITS SCIENTIFIC USES

importance, in the case of coals used for the manufacture of hard metallurgical coke, to determine the amounts of soluble salts (especially chlorides) which they contain, and also to examine from time to time the water used in the washery.

• A "salty" coal recently examined in the author's laboratories at the Imperial College of Science and Technology, London, in connection with an investigation by Messrs. W. C. Hancock and W. E. King into the effects of such coals upon the refractory linings of coke ovens at high temperatures, was found to contain as much as 0.648 per cent. of soluble mineral salts, of which the chlorine content was 19.6 per cent. (*i. e.* equal to 32.3 per cent. NaCl). The disintegrating action of such a coal upon the oven linings was very marked, especially when charged into the oven in a wet condition. Apparently moisture in the slack coal had assisted matters by acting as a carrier of soluble salts of the alkali metals from the coal to the hot firebrick linings, and the salts so transferred had caused a marked disintegration therein, especially towards the end of the coking period when the temperature in the oven was at its highest. The alkalis so deposited in the pores of the firebrick produced a fusible vitreous coating or glaze upon the surface in contact with the coal, which glaze subsequently became broken up under the combined influence of the rapid temperature changes in the oven and the abrasive action of the coke and coal during the discharging and re-charging operations.

As a typical example of the transfer of alkalis from a "salty" coal to firebrick at high temperatures and the influence of moisture thereon, the following results of laboratory experiments may be quoted in which a standard firebrick test-piece weighing 5 grams, was exposed to the action of three successive charges, each of 10 grams, of a particular salty coal, A or B, for altogether $3 \times 9 = 27$ hours at 1000° C. The coal had been previously ground until it passed a $\frac{1}{4}$ inch linear mesh, and it was used "dry" or "moist" in alternate experiments.

Total Alkalis in the Original Test-piece = 1.66 per cent.

	Coal A.		Coal B.	
	Dry	Moist	Dry	Moist
Total percentage alkalis found in test-piece after the experiment.	2.49	2.70	2.74	3.91

CHAPTER IV

THE CHEMICAL COMPOSITION OF COAL (*contd.*)

B. THE COAL SUBSTANCE—ITS ULTIMATE ANALYSIS AND YIELD OF "VOLATILE MATTER"—CALORIFIC VALUES OF COALS

FOR the purposes of the comparison and classification of coals it is usual to disregard the variable proportions of mineral matter, as well as of mechanically held water which they may contain, and to fix attention upon the character and composition of the "coal substance" itself.

The coal substance, although always compounded of the same elements carbon, hydrogen, oxygen, nitrogen, and sulphur, is in reality a very complex material, about which it must be confessed chemists are still in a state of considerable ignorance. In this chapter we shall confine our attention to the elementary ultimate composition of the coal substance, its "proximate" analysis by carbonisation tests at definite temperatures, and the calorific values of coals.

It will have been understood, from what has been said in the preceding chapter on the origin of coal, that inasmuch as coal-fields have been formed from vegetable *débris* in nearly all the great geological epochs, the present-day coals represent widely different intermediate stages in the wood-to-anthracite series, anthracite being regarded for the moment as the end product thereof, although, as will be explained later, it may not be and is not necessarily so.

Such a series would include (1) *Peat*, which may be regarded as the initial stage in the transformation process and, geologically speaking, of very recent origin (quaternary); (2) the "sub-bituminous" *Brown Coals* and *Lignites*, which are nearly all of Tertiary or Cretaceous origin, and therefore intermediate between peat and the true coals; (3) the great class of "*Bituminous Coals*," which mainly date back to Carboniferous or Permo-Carboniferous times; and (4) the *Anthracitic Coals* and *Anthracites*, which belong to the oldest classes.

It must further be recognised that, whilst there is little doubt

COAL AND ITS SCIENTIFIC USES

but that the transformation process from wood to coal has been much the same in all geological periods, there may have been considerable variations in the original vegetable *débris* transformed, which variations would also help to explain some of the marked differences observed in present-day coals. Thus, for instance, some authorities have suggested that the difference between the anthracites and bituminous coals of the Carboniferous period may be ascribed to some difference in the character of the vegetable *débris* from which they originated. Bearing such qualifications in mind, and considering for the moment the wood-to-anthracite series as successive stages in a process which has tended to the same end product, it will be seen, from the following figures for the ultimate composition of the principal dry "ashless" raw fuels comprised in the series, that the net result has been a progressive concentration in the carbon content and a corresponding diminution in the relative proportion of oxygen in the organic matter, a circumstance which is also marked by a steady increase in the calorific value of the product as the series is ascended.

TABLE XVI

	Carbon Per cent.	Hydrogen Per cent.	Oxygen Per cent.	Nitrogen Per cent.	Calorific Value K.C.Us. per kg.
Wood	50.0	6.0	43.5	0.5	4000-4300
Peat	50-64	4.5-6.8	28-48	0.75-3.0	5000-6000
Brown Coals and Lignites	60-75	5.0	20-35	0.75-1.75	6000-7000
Bituminous Coals .	75-90	4.5-5.5	5-15	0.75-1.75	8000-9000
Anthracites . . .	90-95	2.5	3.0	0.5-1.0	8000-9000

ULTIMATE ANALYSIS

The ultimate analysis of a coal consists in determining the percentages of elementary carbon, hydrogen, nitrogen, and sulphur in a properly prepared *dry* sample; the difference between the sum of these percentages, *plus* the percentage of ash, and 100 is usually returned as oxygen, meaning of course oxygen in the coal substance itself, apart from that in the associated mineral matter.¹ The oxygen figure so deduced is, therefore,

¹ It is assumed that the percentages of other elements (such as arsenic, phosphorus, etc.) are so small as not to affect the calculation.

THE CHEMICAL COMPOSITION OF COAL

subject to whatever balance of error there may be in the estimation of the total of the other constituents, which error may be appreciable, especially where the percentage of *ash* differs materially from the original mineral content of the coal. Indeed, such disparity between "ash" and "mineral content" is always a possible source of error in coal analysis.

With regard to the difficulty of calculating the oxygen content of a coal, the following opinion, published by the Coal Analysis Committee of the American Chemical Society in 1899 (*Journ. Amer. Chem. Soc.*, 21, p. 1129) may be quoted:—

"The method to be used in calculating the oxygen of the coal presents, perhaps, the question of greatest difficulty. If we could be sure that all the sulphur is present in the form of pyrites, and that this is converted into ferric oxide in the ash, the oxygen should be found by subtracting from 100 the sum of carbon, hydrogen, nitrogen, ash, and five-eighths of the sulphur. This probably is the safest rule which can be given for general use, and especially for coals high in sulphur. The operator should, however, satisfy himself as to whether the ash is practically free from sulphates, and, if possible, whether the sulphur is mainly in the form of pyrites. If necessary, the rule should be modified, in particular cases, accordingly."

CARBON AND HYDROGEN

The percentages of these two elements are always determined by burning a weighed quantity (0.25 to 0.50 gram) of the *dry* coal in a current of dry oxygen in a hard glass tube, the products being passed (in the tube) over moderately heated lead chromate, which retains oxides of sulphur produced by the oxidation of iron pyrites or organic sulphur compounds in the coal. The water and carbon dioxide produced by the combustion of the coal, are caught up by suitable absorbents (*e. g.* dehydrated calcium chloride for water, and a 1 : 1 aqueous solution of caustic potash for carbon dioxide) and weighed. The procedure is essentially the same as that generally adopted for the determination of carbon and hydrogen in organic compounds and needs no further description. To any one thoroughly experienced in the analysis of organic substances the method in itself presents no difficulties, and the amounts of carbon dioxide and water produced can certainly be estimated with

COAL AND ITS SCIENTIFIC USES

considerable accuracy. Where inexperienced persons sometimes fail is either (1) through lack of the particular manipulative skill and judgment required, which is only acquired after considerable practice, or (2) because they neglect some obvious precaution.

For instance, it is essential (1) that the oxygen used should be dried before entering the heated tube *over the same drying agent as is afterwards used to absorb the H_2O produced during combustion*; (2) that before the tubes or bulbs containing the absorbents for water and carbon dioxide respectively are finally weighed, they shall have been allowed to cool in a dry chamber to the temperature of the balance room, which should be recorded, and a proper correction applied if its temperature has changed materially during the experiment.

Also, in carrying out the combustion of a coal containing a highly ferruginous and fusible ash, it is inadvisable to heat the coal to more than about $800^{\circ}C$. or otherwise minute particles of carbon are liable to be "protected" from the action of the oxygen by the semi-fused ash, and so escape combustion.

The residual "ash" may be weighed as a check on the ordinary ash determination; in the case of a ferruginous ash it is, however, liable to give a slightly higher result than that obtained by the ordinary method, because of the usually more complete oxidation of the iron in the combustion tubes than in the muffle furnace.

It is the author's general experience in regard to the "combustion analysis" of organic compounds generally (1) that whilst there is a tendency for the *carbon* to come out somewhat lower than its true value, this error does not on the average exceed half of 1 per cent. of the true value; and (2) that the *hydrogen* on the average comes out very near to (if anything slightly higher than) the true value.

SPECIAL SOURCES OF ERROR IN THE ESTIMATION OF CARBON AND HYDROGEN IN COALS

It has frequently been pointed out that the association of calcium (or magnesium) carbonate with the coal substance will, by reason of its decomposition ($CaCO_3 = CaO + CO_2$) at red heat, cause the experimental determination of carbon by the combustion method to give a too high result, whereas the associa-

THE CHEMICAL COMPOSITION OF COAL

tion of hydrated minerals, such as gypsum ($\text{CaSO}_4 \cdot 2\text{H}_2\text{O}$), would similarly cause the hydrogen to come out too high. In order to illustrate the magnitude of the errors so introduced, the following calculations have been made:—

(A) The influence of the presence of 1 per cent. of calcium carbonate in a dry coal containing 80 per cent. of carbon, and

(B) The influence of the presence of 1 per cent. of gypsum in a dry coal containing 5 per cent. of hydrogen.

(A) *Dry Coal containing 80 per cent. Carbon and 1 per cent. CaCO_3 .*

By combustion of 1 gram coal:—

0.8000 gram C	would yield	.	2.9333	grams CO_2
0.0100 „ CaCO_3	„ „ „	.	0.0044	„ „

Total = 2.9377

Thus the total carbon dioxide obtained on analysis would exceed that actually found by combustion of the carbon by 44 parts in 29,333 or (say) by 0.15 per cent. only of the true “carbon” figure. So that the percentage of carbon calculated from the total carbon dioxide obtained in the analysis would be 80.12 instead of 80.00, which is about *half* the usual average “experimental error” in the carbon determination.

(B) *Dry Coal containing 5 per cent. Hydrogen and 1 per cent. Gypsum.*

By combustion of 1 gram coal:—

0.0500 gram hydrogen	would yield	0.4500	gram H_2O
0.0100 „ $\text{CaSO}_4 \cdot 2\text{H}_2\text{O}$	„ „ „	1.0021	„ „

Total = 0.4521

Thus the total water obtained on analysis would exceed that actually found by combustion of the hydrogen by 21 parts in 4500 or (say) by about 0.5 per cent. of the true “hydrogen” figure. So that the percentage of hydrogen calculated from the total water obtained in the analysis would be 5.025 instead of 5.00, which is also well within the usual experimental error.

COAL AND ITS SCIENTIFIC USES

NITROGEN

The accurate estimation of this element in coal is very important. It probably exists in at least two forms, namely (1) as compounds (possibly of an "imino" type) which decompose between (say) 300° and 900° C. giving rise to ammonia, and which are the source of the ammonia obtained when the coal is carbonised in coke ovens or in gas-works retorts; and (2) in much more stable (possibly "nitride") types of compounds which on thermal decomposition do not yield ammonia.

The fact that the whole of the nitrogen in coal can be extracted as ammonia by heating it to redness in a current of steam is now well known to chemists, and is the basis of the Mond "Ammonia Recovery" Gasification Process. Dr. Ludwig Mond in his Presidential Address to the Society of Chemical Industry in 1889 on this subject mentioned that it had been customary in his laboratory to estimate the nitrogen in coke simply "by burning it in a current of steam" which converted the whole of it into ammonia.

Total Nitrogen.—This may be, and usually is, estimated by the following modification of the well-known Kjeldahl method, which the author has found to work very well:—

Weigh out 1 gram of the coal, pulverised so that it will pass through fine muslin, into a Jena glass flask specially designed so that the whole of the subsequent operations can be carried out in it. Then add 15 c.c.s. of fuming sulphuric acid and about 1 gram of mercury. Heat gently for 2 or 3 hours, at the end of which all black particles should have disappeared. Allow the contents of the flask to cool, then carefully add a little cold water and a few drops of phenolphthalein solution. Next, run in very carefully (with external cooling) sufficient of a strong solution of caustic potash to make the liquid strongly alkaline. Then add 15 c.c.s. of a solution of sodium sulphide (containing 40 grams per litre) to precipitate the mercury compound as HgS. Add a small piece of zinc to prevent bumping, and distil for 20 to 30 minutes into 20 c.c.s. of decinormal sulphuric acid. From the amount of acid neutralised by the NH_3 evolved the nitrogen in the coal may be calculated (1 c.c. of decinormal acid neutralised = 0.0014 gram of nitrogen in the coal). Two such estimations should always be made simultaneously and the mean result taken. Moreover, a *blank* experiment should also be made in order to correct for any ammonia evolved from the

THE CHEMICAL COMPOSITION OF COAL

materials other than the coal used in the experiment. In laboratories where such nitrogen determinations are made daily, it is sufficient if a blank experiment be made once a week.

SULPHUR

Sulphur is always a deleterious element in coal from every point of view. It is present chiefly in three forms, namely (1) as iron pyrites (FeS_2); (2) as gypsum ($\text{CaSO}_4 \cdot 2\text{H}_2\text{O}$); and (3) in the form of organic compounds in the coal substance itself. On carbonising a coal in gas retorts or coking ovens, between a quarter and a third of the sulphur is expelled with the gases, chiefly as H_2S , CS_2 , and thiophene, the remainder being retained by the coke.

(a) *Sulphur in the Coal*.—The method employed in the author's laboratory consists essentially in igniting a weighed amount of the finely divided coal or coke (2 to 3 grams) with three times its weight of a mixture of 2 parts of light magnesium oxide (MgO) and 1 part of pure anhydrous sodium carbonate (Na_2CO_3) in a porcelain dish or large crucible for $1\frac{1}{2}$ hours in a muffle furnace.¹ Afterwards the charge is washed out into a beaker, excess of hydrochloric acid plus bromine water is added; the excess of bromine is then boiled off and, after vigorous stirring, the liquid is filtered. The sulphate in the filtrate is then precipitated with a slight excess of barium nitrate and finally ignited and weighed as BaSO_4 in the usual manner. Determinations are usually made in triplicate, and a blank experiment is always simultaneously performed in order to determine the "correction" to be applied on account of any traces of sulphate in the materials employed or the fixation of sulphur dioxide by them from the furnace gases.

(b) *In the Ash*.—In general the ash is fused in a platinum crucible with excess of an intimate mixture of NaCO_3 and K_2CO_3 plus KNO_3 to ensure the conversion of all sulphur compounds into soluble sulphates. The fused mass is subsequently extracted with excess of hot dilute hydrochloric acid and the extracted sulphates are then determined in the usual way. The exact procedure in such an analysis necessarily varies with the composition of the ash (which should always have been qualitatively ascertained beforehand), and must be left to the discretion of the operator.

¹ In laboratories provided with a suitable supply of electricity, the use of an electrically heated muffle is recommended for the fusion process.

COAL AND ITS SCIENTIFIC USES

ESTIMATION OF THE YIELDS OF VOLATILE COMBUSTIBLE MATTER BY COALS

For commercial purposes coals are classified according to their suitability or otherwise for certain specific economic ends, *e. g.* steam raising, furnace firing, gas making, the manufacture of a dense metallurgical coke, low temperature distillation and the like. The usefulness of any given coal for a particular purpose depends largely upon its yield of combustible "volatile" matter expelled when it is carbonised under certain specified conditions and upon the character of the resulting carbonaceous residue. Various coals show marked differences in behaviour when so carbonised, and from a properly conducted laboratory test (sometimes called a "proximate analysis") on such lines much valuable general information may be gained respecting the economic value of a given coal.

When so treated some coals swell up and, after passing through a marked state of intumescence, yield a strongly coherent residue (coke). These are usually designated "caking" coals. Others, again, exhibit no sign of intumescence and yield an incoherent carbonaceous residue; such are called "non-caking" coals, and they are usually *either* rich in oxygen and burn with a long smoky flame, *or* rich in carbon and burn with a short smokeless flame. Between these two extremes there are many intermediate types possessing more or less caking properties. Owing, however, to the fact that the yield of "volatile matter" from a given coal varies within wide limits according to the conditions, of which temperature is the most important, under which it is carbonised, it is necessary to prescribe certain "standard" conditions for such tests, which conditions must be strictly observed throughout if the results are to be of any comparative value. The following two standard tests may be cited by way of illustration.

(a) *The American Test.*—In 1899 the American Chemical Society recommended the following method for the determination of "Volatile Combustible Matter," which has since been accorded international recognition.

"Place, 1 gram of fresh, undried, powdered coal in a platinum crucible, weighing 20 to 30 grams, and having a tightly fitting cover. Heat over the full flame of a Bunsen burner for 7 minutes. The crucible should be supported on a platinum triangle with the bottom 6 to 8 c.ms. above the top of the burner. The flame should be fully 20 c.ms. high when burning free, and

THE CHEMICAL COMPOSITION OF COAL

the determination should be made in a place free from draughts. The upper surface of the cover should burn clear but the under surface should remain covered with carbon. To find the Volatile Combustible Matter, subtract the percentage of moisture from the loss found here" (*Journ. Amer. Chem. Soc.*, 1899, 21, p. 1122).

Practically the same test was adopted by the Canadian Coal Survey chemists, except that it was carried out on the *dry* instead of the *undried* coal, as in the American procedure. It has always seemed to the author that a test carried out under such conditions, and on so small a quantity of coal, in a *platinum* crucible, is open to criticism, both on account of the well-known intense "catalytic" influence of hot platinum upon such thermal decompositions, and also because of temperature conditions. Also, it does not enable a sufficiently reliable judgment to be formed about the "coking" properties of the coal. Accordingly, after investigating the matter some years ago for himself, the author ceased to employ the method in his laboratory, preferring the following, which, if carried out under "standard" conditions, has proved to be quite reliable within the limits required for commercial purposes.

(b) *The Crucible Test.*—Twenty grams of the dried coal are weighed out (to the nearest centigram) into a No. 3 Morgan Fireclay crucible, which has been just previously heated to redness in a muffle and then allowed to cool in a chamber containing an efficient drying agent. The crucible and its contents (lid on) are then put into a muffle furnace, the temperature of which has been raised to 900° C. and kept constant at such degree by proper regulation of the gas supply. The charge of coal is thus "carbonised," the resultant inflammable volatile matters escape from the crucible, either through the hole in the lid or round the edge of it, and are ignited as they issue therefrom and mix with air in the muffle. Heating is continued for 10 minutes after the evolution of inflammable gases has entirely ceased. The crucible containing the carbonaceous residue is then withdrawn and set to cool in the "drying" chamber, after which it is quickly re-weighed. A subsequent examination of the carbonaceous residue enables a good idea to be formed of the "coking" properties of the coal, and as a *comparative test* of the properties of different coals it is most valuable. The test should always, however, be carried out simultaneously in *duplicate* if not in triplicate charges. How nearly the results from two or

COAL AND ITS SCIENTIFIC USES

more such charges are found to agree may be illustrated by the following examples taken at random from laboratory records:—

(1)	35·3	34·9	35·5	.	.	Mean = 35·2	}	Per cent.
(2)	32·5	30·5	32·8	.	.	Mean = 31·9		
(3)	24·8	23·4	—	.	.	Mean = 24·1		
(4)	16·9	17·6	—	.	.	Mean = 17·25		
(5)	13·4	13·8	—	.	.	Mean = 13·6		
(6)	9·8	10·2	—	.	.	Mean = 10·0		

If the experimental results are referred to the "dry ashless" coal, they enable a useful *proximate* classification of coals for commercial purposes to be made on similar lines to that of Regnault-Grüner's table (*q. v.*) somewhat as follows:—

TABLE XVII

	% Volatile at 900° C.
1. Anthracites	Below 8 } Non-caking.
2. Anthracitic Coals	8 to 15 } Non-caking.
3. Semi-bituminous Steam Coals	15 to 20 } Feebly caking.
4. Hard Coking Coals	20 to 30 } Yield a dense metallurgical coke. ¹
5. Gas Coals—Strong Coke	30 to 35 } Strongly caking.
6. Gas Coals—Porous Coke	35 to 40 } Weakly caking.
7. Non-caking—Long Flame Furnace Coals	Above 40 } Non-caking.

According to the author's experience it rarely happens, in regard to English coals, that the *caking* properties are not in substantial agreement with such a classification. Some exceptions are, however, to be met with among the South Wales coking coals, which contain less than 20 per cent. of volatile matter, and among Scottish non-caking varieties.

Further useful information can be obtained about a coal by comparing the percentages of volatile matter expelled from it at different selected temperatures (say 500°, 700°, and 900° C.) when heated in the crucible. The chief requisite for properly carrying out such a series of tests is a muffle type of furnace so designed that a temperature may be maintained fairly constantly at the selected degrees for a sufficient period to enable the "carbonisation" to be completed at each degree of heat.

¹ N.B.—The best Durham Coking Coals all fall within this class.

THE CHEMICAL COMPOSITION OF COAL

Thus, for example, it was found that the following percentages of volatile matter (referred to the dry ashless coal) were expelled from a lignitic coal at the temperatures named :—

Temperature	500°	700°	900°
Per cent. Volatile Matter	31.0	38.0	43.7

results which closely agreed with those actually realised when the same coal was afterwards carbonised on a large scale (*e. g.* at 500° C. the loss of "volatile" on a large scale was found to be 31.3 per cent. on the dry coal).

As a typical example of how results yielded by the Crucible Method compare with those obtained by the American Method (*a*), the case of a Durham Coking Coal tested in the author's laboratory by both methods may be quoted. By the American Test it yielded 23.4 per cent. of volatile combustible matter; by the Crucible Test it yielded 26.1 per cent. at 900° C. and 21.7 per cent. at 600° C. Thus the American Test gave a result corresponding to some temperature apparently about mid-way between 600° and 900° C.

CALORIFIC VALUE

The calorific value, or total amount of heat obtainable by the combustion of a given coal, is expressed by the number of parts by weight of water which may be heated through 1° on the thermometric scale, in the neighbourhood of the normal temperature (15° C. or 60° Fahr.), by the complete combustion of unit weight of the coal under conditions such that the whole of the heat of combustion is transferred without loss to the water, and that the products leave the system at atmospheric temperature and pressure. The metric unit of heat adopted for technical purposes (the K.C.U.) is the quantity of heat required to raise 1 kilogram of water through 1° C. in the neighbourhood of 15° C., whilst the British Thermal Unit (B.Th.U.) is the amount of heat required to raise 1 lb. of water through 1° Fahr. in the neighbourhood of 60° Fahr. Thus it follows that :—

$$1 \text{ K.C.U.} = 3.9683 \text{ (or approx. 4) B.Th.U.}$$

$$1 \text{ B.Th.U.} = 0.252 \text{ (or approx. } \frac{1}{4} \text{) K.C.U.}$$

The calorific value of a coal may, therefore, be defined *either* (1) as the number of kilograms of water which may be heated through 1° C. in the neighbourhood of 15° C. by the complete

COAL AND ITS SCIENTIFIC USES

combustion of 1 kilogram of it; or (2) as the number of pounds of water which may be heated through 1° Fahr. in the neighbourhood of 60° Fahr. by the complete combustion of 1 lb. of it, in either case the conditions being such that the coal is taken *dry* (i. e. dried at 105° C. until its weight has become constant), that the whole of the heat is transferred without loss to the water, and that the products leave the system at the atmospheric temperature and pressure. It may be shown by calculation that a calorific value of x K.C.Us. per kilogram is equivalent to $1.8 x$ B.Th.Us. per lb. or conversely, that x B.Th.Us. per lb. are equivalent to $0.5555 x$ K.C.Us. per kilogram.

Seeing that every coal contains hydrogen, a distinction is sometimes drawn between its *gross* and *net* calorific values, the former implying that the products of combustion have *all* been cooled down to atmospheric temperature (15° C. or 60° Fahr.), the latter, however, that the heat liberated by the condensation of the steam produced on combustion, and by the subsequent cooling of the water down to 15° C. (or 60° Fahr.) has not been included. The difference between the two values will amount to 622 K.C.Us. per kilogram, or 1119.6 B.Th.Us. per lb. of steam produced by the combustion of the fuel. For scientific purposes the *gross* calorific value is invariably employed, but it is usual to use the *net* value in calculations relating to steam boiler trials, furnace operations and the like.

The determination of the calorific value of a coal may be best carried out by burning a known weight of it in compressed oxygen in some form of bomb calorimeter, that known as the Berthelot-Mahler apparatus being well adapted for the purpose. In the hands of an experienced worker, the method is more accurate than any yet devised, provided that all the proper "corrections" (e. g. for "radiation" and for the formation of nitric acid) are properly determined and applied in each experiment. The details of the experimental procedure are now so well known, and have been so often set forth both in laboratory manuals and technical publications, that there is perhaps no need for their reproduction here. The "water equivalent" of the bomb and its accessories is best determined by burning a known weight of compressed naphthalene in it. A comparison between the value so obtained and that calculated from the known weights and specific heats of its separate parts serves as a good test of the proper heat insulation of the bomb in the calorimeter, which is apt at times to become defective. In the author's laboratory

THE CHEMICAL COMPOSITION OF COAL

it is customary to make such a comparison frequently, as a precaution against possible error which might otherwise escape detection. With ordinary care duplicate determinations on the same coal sample should give results agreeing within 50 K.C.U.s., and when special precautions are taken within 25 K.C.U.s. or about 8000 K.C.U.s. per kilogram.

It must always be remembered, however, that the bomb method gives the heat of combustion under "constant volume" and not under "constant pressure" conditions, but as the combustion of a bituminous or anthracite coal in oxygen is attended by very little change in chemical volume (*e. g.* $C_9H_8O + 10O_2 = 9CO_2 + 3H_2O$) the difference between the two values is perhaps negligible in practice. Strictly speaking, however, the necessary small correction ought to be applied to the "bomb" results in deducing the true "constant pressure" value.

The following formula is sometimes used by engineers for calculating the calorific value of a coal from its chemical composition:—

$$Q = \frac{1}{100} (8080 C + 34,460 (H - \frac{1}{8} O) + 2250 S)$$

where C, H, O, and S = the percentage of carbon, hydrogen, oxygen, and sulphur, respectively in the dry coal. Although such a procedure can hardly be defended from a theoretical point of view, yet in cases where the *oxygen content of the coal is low* it is remarkable how nearly such "calculated" values often agree with those actually found by the bomb calorimeter.

Thus, in a Report by the Government Laboratory upon the calorific values of some forty-five South Wales Coals investigated for the Geological Survey (*vide Memoir upon the Coals of South Wales*, by Drs. A. Strahan and W. Pollard, 2nd Ed., 1915, p. 2), the values calculated by means of the above formula came out within 0.5 per cent. of those actually found experimentally in no less than twenty-eight cases, whilst only in one case was the difference between the two figures greater than 2 per cent. Of the forty-five coals in question, only six contained more than 6 per cent. of oxygen, and in no case did the oxygen content exceed 9 per cent.

That there is often a fairly close agreement between the results calculated by means of the above formula and those actually found by the bomb calorimeter in cases where the oxygen content of the coal is low also agrees with the author's experience. When, however, the oxygen content exceeds, say, about 7.5 per cent. the

COAL AND ITS SCIENTIFIC USES

two results do not usually show more than a rough agreement, and with high oxygen content, such as is met with in "oxidised" or lignitic coals, there is usually a marked disagreement.

This may be illustrated by the following tabulated results (Table XVIII) for a series of seventeen different coals, whose oxygen contents range from 2.5 up to 26.0 per cent., taken from one of the author's laboratory note-books. It will be noted that there usually is a much closer agreement between the "found" and "calculated" values in the case of the nine coals whose oxygen contents were all less than 5 per cent. than in the other eight cases in which the oxygen contents were all greater than 7.5 per cent.

TABLE XVIII

	Ultimate Composition. Percentages.				Calorific Values. K.C.U.s. Per Kilogram.	
	C.	H.	S.	O.	Found.	Calcd.
1. Ekenberg Peat Briquette	58.35	5.42	0.5	26.0	5987	5463
2. Malay Lignitic L. . . .	68.40	5.75	0.4	17.8	6538	6751
3. Notts Slack B. . . .	65.35	5.00	0.45	12.0	6320	6497
4. Japanese F. Coal . . .	71.60	5.80	0.14	11.2	7165	7394
5. Lancashire B. . . .	78.45	5.46	1.38	10.7	7718	7721
6. Yorkshire B. . . .	73.10	5.52	1.20	8.7	7192	7457
7. Yorks B. . . .	77.18	6.37	1.10	8.5	7990	8087
8. Durham B. . . .	79.0	5.3	1.0	7.5	8027	7908
9. Durham B.C. . . .	83.6	5.0	1.0	3.0	8206	8373
10. E ^o Indian S.B. . . .	77.15	4.5	2.5	4.0	7690	7665
11. Scotch A. . . .	87.3	4.05	0.1	4.0	8270	8279
12. S. Wales B. . . .	79.3	4.4	0.4	3.0	7761	7795
13. S. Wales A. . . .	85.4	3.65	1.2	3.2	8050	8046
14. S. Wales A. . . .	89.4	3.42	1.15	2.6	8360	8316
15. S. Wales A. . . .	87.5	3.30	0.7	3.5	8135	8070
16. S. Wales A. . . .	86.41	3.48	0.57	4.0	8104	8010
17. S. Wales A. . . .	90.4	3.34	0.9	2.5	8390	8357

- L = Lignitic.
- B = Bituminous.
- B.C. = Bituminous—Hard Coking.
- S.B. = Semi-bituminous.
- A. = Anthracite or Anthracitic.
- F. = a Resinous ("Fatty") coal.

CHAPTER V

THE CHEMICAL COMPOSITION OF COAL (*contd.*)

C. CLASSIFICATION OF COALS

COALS may be classified from the point of view either of their geological characteristics or of their suitability for various commercial purposes; some systems attempt to combine as far as possible both these objects. None of the existing systems can be regarded as entirely satisfactory from a chemical point of view, and indeed it must be confessed that, owing largely to our ignorance of the nature and proportionate distribution of the principal constituents of the coal substance, a sufficient basis for a scientific "chemical" classification of coals does not at present exist. Hence the importance of further research by chemists into the nature of coal.

Any complete classification of coal must include the following three principal groups—each of which may be recognised by certain characteristic group features:—

A. Sub-bituminous or Lignitic (Non-caking—Carbon usually below 75 per cent.).

B. Bituminous Coals (Caking or Non-caking—Carbon usually 75 to 90 per cent.).

C. Anthracites or Anthracitic Coals (Non-caking, rich in Carbon, low in Hydrogen).

THE REGNAULT-GRÜNER CLASSIFICATION

The earliest classification of coals is due to Regnault, who was the first chemist to make accurate ultimate analyses of them. He found that the principal commercial types of coal could be defined, within fairly narrow limits, by their ultimate compositions, and especially by their carbon and oxygen contents. The French metallurgist Grüner extended the Regnault system, which for commercial purposes is still a useful one, although cases of coals which do not altogether fall into line with it are occasionally met with. It is set forth in a slightly modified and modernised form in Table XIX the numbers in which all refer to the "dry ashless" coal substance.

COAL AND ITS SCIENTIFIC USES

TABLE XIX
THE REGNAULT-GRÜNER CLASSIFICATION OF COALS (AS REVISED BY THE AUTHOR)

Genus.	Class.	Chief Uses.	Percentage Composition.			% Volatiles at 900° C.	% Fixed Carbon.	Character of Carbonaceous Residue.
			C.	H.	O + N + S.			
A. Lignites	Non-caking	—	60 to 75	about 5.0	20 35	above 45	below 55	Non-coherent
	[1] Non-caking Long Flame	Reverbatory Furnaces	75 80	4.5 to 5.5	15 20	40 to 45	55 to 60	Non-coherent
B. Bituminous	[2] Caking Long Flame	Gas-making	80 85	about 5.6	10 15	32 to 40	60 68	Very Porous Coke
	[3] Hard Coking	Coke Manufacture	84 89	5.0 to 5.6	5.5 11.0	26 to 32	68 74	Dense Coke
	[4] Hard Coking Short Flame	Coke Manufacture and Steam Raising	88 90	4.5 to 5.5	5.5 6.5	18 to 26	74 82	Very Dense Coke
	Non-caking Short Flame	Steam Raising	90 92	4.0 to 4.5	4.0 5.5	15 to 20	80 85	Weakly Caking or Non-coherent
C. Anthracitic and Anthracites	[1] Anthracitic Non-caking	Steam Raising				8 to 15	85 92	Pulverulent
	[2] Anthracites Non-caking	Domestic and Central Heating; Malting Kilns	92 to 94	3.0 to 4.0	3.0 4.5	below 8	above 92	

All the numerical data in the above table refer to the dry ashless coal.

THE CHEMICAL COMPOSITION OF COAL

Considering now the various classes included in this table more in detail, we have in their natural order :—

A

LIGNITIC OR SUB-BITUMINOUS COALS (Lignites and Brown Coals).—A large class of principally Tertiary coals which are widely distributed over the Central European plain, the Southern States of North America (Texas, Arkansas, and Louisiana), and of Cretaceous coals occurring also in the United States over a large area, between latitudes 49° and 43° N. and longitudes 100° to 107° W. (North Dakota, Montana and Wyoming), as well as in Canada. Large deposits are also found in Australia and the Malay Peninsula. They may be sub-divided according to their external characters and geological ages into (1) Woody or Fibrous Brown Coals, which retain a distinct ligneous structure; (2) Earthy Brown Coals, which are devoid of organic structure and readily crumble under pressure; (3) Common Lignites, of a dark brown colour and a slaty cleavage (*e. g.* Bovey coal); and (4) Bituminous Lignites, which are black in colour and have a conchoidal fracture.

One of the characteristic features of the lignites is the large amount of water (up to 50 per cent.) which they contain, and it has been proposed to use this fact as a basis of distinction between them and the lowest grades of bituminous coals. It was suggested in the *Bulletin* No. 218 of the United States Geological Survey (1903) that all coals containing 10 per cent. or more of water should be classed as lignites, but although the latter almost invariably contain a higher percentage of water than 10, later investigations by the Survey have shown that some unquestionably bituminous coals found in the Mississippi Valley likewise contain more than 10 per cent. of moisture. Hence the suggested distinction would not appear to be universally valid. Lignites readily lose part of their water content on air-drying, and in so doing they generally disintegrate, in some cases crumbling to powder, in others with well-marked laminar cracks.

Until quite recently, except in Germany and Austria-Hungary where 87.1 and 27.4 million tons respectively were raised for home consumption in 1913, lignites have not been considered as of great economic value, but the problem of utilising their immense deposits of lignites is an important one for Australia, Canada, Malaya, and other parts of the Empire.

COAL AND ITS SCIENTIFIC USES

Lignites, when dried, are readily reduced to powder in a disintegrator, and with addition of a suitable binder, may be again consolidated into serviceable briquettes under pressure. The ash content usually varies between 5 and 15 per cent., but may run considerably higher, whilst the nitrogen content usually lies between 0·5 and 1·5 per cent. They burn with a very long smoky flame, and are generally quite devoid of caking properties, and do not yield a coherent coke. On low temperature distillation they yield a variety of valuable decomposition products, including petrols, kerosene, fuel and lubricating oils, solid paraffins, pitch, ammonium sulphate, the nature and uses of which have for some time past been the subject of close investigation in the author's laboratory. There are undoubted commercial possibilities in the world's lignite resources which will well repay the attention of fuel chemists.

In Germany and Austria lignites have been largely used for firing boilers, for the heating of evaporating pans, and also in the case of some of the better qualities, to a limited extent for metallurgical purposes.

B

BITUMINOUS COALS.—This term is applied to a whole series of "flaming" coals of Carboniferous or Mesozoic origin. The Regnault-Grüner Classification sub-divides them into four classes, which, however, may be considered really as three, namely:—

(1) *Super-bituminous Coals*, yield at 900° more than 40 per cent. of volatile matter and a non-coherent carbonaceous residue. They burn with a very long and highly luminous "smoky" flame, and for that reason are chiefly valued for the firing of reverberatory furnaces and the like. They are also used to some extent as house coals, because of their "free burning" qualities. They are not, however, good for steam raising, and their non-caking character renders them quite useless for coke manufacture.

(2) *Gas Coals*, which at 900° C. yield between 32 and 40 per cent. of volatile matter and a porous coke of moderate strength. They comprise all the best gas-coals. They burn with a long luminous flame, and on distillation pass through a stage of intumescence, during which gas is freely expelled.

(3) *Hard Coking Coals*, which at 900° C. yield between 20 and 32 per cent. of volatile matter and a very dense and hard coke. They are chiefly valued for the manufacture of metallurgical

THE CHEMICAL COMPOSITION OF COAL

coke, but they are not suitable for steam raising, because on burning in the boiler furnace they form dense masses of coke which can only be completely consumed by an excessive air supply.

BC

SEMI-BITUMINOUS.—A class of steam coals yielding as a rule from 15 to 20 per cent. of volatile matter at 900° C. which includes all the best Welsh "Admiralty" steam coals. They are usually only feebly caking, and burn well in a good draught with a short smokeless flame.

C

(1) **ANTHRACITIC.**—Hard steam coals yield at 900° C. between 8 and 15 per cent. of volatile matter. They are non-caking and burn with a short non-luminous flame.

(2) **ANTHRACITES.**—Coals yielding less than 8 per cent. of volatiles at 900° C. are usually classed together as anthracites. In Great Britain they are found for the most part in the west and north-west border of the South Wales coalfield (West Glamorgan, Breconshire, Carmarthenshire, and Pembrokeshire) over an area of 137,000 acres, and to a small extent in certain localities in Scotland (Ayrshire, Linlithgow, and Fife), where the bituminous seams have been subjected to intrusion of molten igneous material subsequent to the formation of the original coalfield. Nearly 80 per cent. of the world's reserves of anthracites are said to be located in China, and there are extensive fields also in Russia and the United States (Pennsylvania).

Anthracites are usually distinguished by their very low ash content and comparative freedom from sulphur, and, owing to their cleanliness and smokeless combustion, they are chiefly used for domestic heating in specially constructed closed stoves, for central heating furnaces, for drying malt, curing rubber, and for other special purposes where a smokeless fuel of great purity is required. The total quantity of anthracite raised in Great Britain in the year 1913 was 5,194,620 tons, of which 4,833,159 tons came from South Wales; nearly 3 million tons were exported chiefly to France, Italy, Germany, Sweden, and Holland. The advantages of using anthracite for domestic heating are more appreciated on the Continent, where closed slow combustion stoves are largely used, than in England, where the open fire-place is the rule.

Until quite recently it has generally been believed that anthra-

COAL AND ITS SCIENTIFIC USES

cites represent the final stage in the transformation of the original mother-substance of coal, through the intermediate stages represented by lignites and bituminous coals. In support of this view may be cited the fact that anthracites are found in areas which are known to have been subjected to great earth movements after the coalfields were originally laid. But the fact that in the South Wales coalfield, where the character of the seams gradually changes from bituminous to anthracitic along a line running roughly south-east to north-west, the ash content diminishes as the "anthracitisation" increases is considered by some to be difficult to reconcile with the theory that the anthracite has been formed by the expulsion of volatile matter from what were originally bituminous seams. It has, therefore, been suggested that in this particular area the anthracite has been formed from a different type of original vegetable *débris*. In this connection attention may be called to the remarkable fact that whereas, in the case of the bituminous coals, the caking properties, as well as the strength and density of the coke produced therefrom at high temperatures, progressively increase with diminishing yields of volatiles at 900° C. until they attain a maximum at from 20 to 25 per cent. thereof, these properties disappear almost abruptly as soon as the yield of volatiles falls much below 20 per cent. The semi-bituminous steam coals, yielding from 15 to 20 per cent. of volatiles at 900° C. are all either non-caking or only feebly so, in marked contrast with the hard coking coals yielding a little more than 20 per cent. of volatiles. Again, non-caking coals are either (1) anthracites, anthracitic, or semi-bituminous, which are rich in carbon, with a very low oxygen content, or (2) those either with a high oxygen content (exceeding 15 per cent.) or derived from seams which apparently at some period subsequent to the formation of the coalfield had become "oxidised" by exposure to atmospheric influences, *e. g.* Warwickshire and Leicestershire seams.

SELECTION OF COALS

In selecting a coal for any particular purpose, the following points may usefully be borne in mind:—

- (1) The best *gas-coals* are those in which the O : H ratio is approximately 2.0. They usually yield 32 to 38 per cent. of volatiles at 900° (reckoned on the dry ashless coal), and a fairly porous coke.

THE CHEMICAL COMPOSITION OF COAL

- (2) The best *coking coals* usually yield between 20 and 30 per cent. of volatiles at 900° C. They are strongly caking, and have a ferruginous ash.
- (3) The best *steam-coals* are found among those which yield between 10 and 20 per cent. of volatiles at 900° C.; they are non-caking, or only feebly so, and they should have a non-ferruginous ash.
- (4) For gas generation, where the whole of the coal is to be gasified in a "producer" under the influence of a mixed steam-air blast for the making of "Producer Gas," it is best to select, whenever available, either a non-caking or feebly-caking coal with, if possible, an infusible non-ferruginous ash. Strongly caking coals are to be avoided.
- (5) The coals freest from sulphur, arsenic, and with the *purest and lowest ash contents* are the anthracites.

WEDDING'S CLASSIFICATION

Wedding, an eminent German authority, has proposed to divide coals into six principal groups, according to the percentage of volatile matter yielded by the dry ashless fuel as follows:—¹

TABLE XX

Class.	Percentage Yield of Volatiles.
1. Lean Anthracitic Coals	5.0 to 10.0*
2. Sintering Coals (old) poor in gas	10.0 to 15.5
3. Caking Coals (old) poor in gas	15.5 to 33.3
4. Caking Coals (recent) rich in gas	33.3 to 40.0
5. Sintering Coals (recent) rich in gas	40.0 to 44.4
6. Sand Coals (recent) rich in gas	44.4 to 50.0

In drawing up this classification Wedding had chiefly in mind the caking properties of coals, which increase uniformly in the directions 1 to 3 and 6 to 4 of the table, and attaining a maximum about mid-way in Classes 3 and 4. Apparently he was of opinion that in general the percentage of volatiles yielded by a coal diminishes with its geological age, a view which many chemists have held, but which the author regards as questionable and misleading. Certainly the coals included in the first four classes of the table are all of Carboniferous (or Permo-Carboniferous)

¹ *Grundriss der Eisenhüttenkunde*, p. 46.

COAL AND ITS SCIENTIFIC USES

origin, and an attempt to discriminate between their respective geological ages on the grounds of chemical properties or behaviour alone is of doubtful validity. Wedding indeed qualified this view by the further statement that the properties of the seams in a grown coalfield are subject to considerable variations according to the thickness of the overlying strata.

The weak point about such a classification is that it does not discriminate sufficiently between the valuable semi-bituminous (volatiles = 15 to 20) and hard coking (volatiles = 20 to 33) classes, otherwise it is quite a useful scheme for metallurgists and has the advantage of not depending on the exact ultimate analysis of the coal.

C. A. SEYLER'S CLASSIFICATION

Mr. C. A. Seyler, as the result of a special study of the coals of South Wales, which comprise numerous varieties ranging from bituminous through semi-bituminous and anthracitic coals up to anthracites, has put forward a chemical classification based upon the percentages of carbon and hydrogen in the pure coal substance (see Table XXI).¹ He divides coals into five principal genera, according to their hydrogen contents; each genus is then sub-divided into a number of species according to the percentage of carbon. The classification thus really depends on two factors, namely, in the first place upon the hydrogen content, and in the second, upon a C : H ratio.

Drs. A. Strahan and W. Pollard, of the Geological Survey of England and Wales, in their recent *Memoir upon the Coals of South Wales*² adopted Seyler's general plan and nomenclature as one of the best so far available for the purpose of scientific classification, and defined the observed limits for the five principal genera as follows :—

TABLE XXI

Genus.	Percentage H.	Ratio.
1. Anthracitic	under 4·0	over 22
2. Carbonaceous	4·0 to 4·5	20·3 to 23·35
3. Semi-bituminous	4·5 to 5·0	16·6 to 20·4
4. Bituminous	5·0 to 5·8	14·6 to 18·2
5. Per-bituminous	over 5·8	12·9 to 14·7

¹ *Proc. S. Wales Inst. Engineering*, XXI., p. 483, and XXII., p. 112.

² First edition 1907; second edition 1915.

THE CHEMICAL COMPOSITION OF COAL

Also the United States Geological Survey, independently of Mr. Seyler's previous work, and after considering several other possible schemes, finally adopted the following classification which is also based upon the C : H ratio in the pure coal substance.¹

TABLE XXII

Group.	Description.	Ratio C : H.
A.	Graphite	
B. } C. }	Anthracite	{ ? to 30 ?30 to 26
D.	Semi-anthracitic	?26 to 23
E.	Semi-bituminous	?23 to 20
F. } G. } H. } I. }	Bituminous	{ 20 to 17 17 to 14·4 14·4 to 12·5 12·5 to 11·2
J.	Lignitic	11·2 to 9·3 ?
K.	Peat	?9·3 to ?
L.	Wood	7·2

Whilst there thus seems to be a considerable weight of geological opinion in favour of adopting the C : H ratio for the pure coal substance as the most satisfactory basis of classification at present available for their purposes, chemists will hardly rest satisfied with any such empirical scheme. Sixty years ago (1857) W. Stein in his well-known *Chemische und Chemisch-technische Untersuchungen der Steinkohlen Sachsens* pointed out the uncertainty of conclusions concerning the properties of coals based merely upon the percentages of carbon and hydrogen, respectively, which they contain. Again, in 1898, W. Carrick Anderson and Roberts, in reporting the results of their investigation upon some typical Scottish coals of the Lanarkshire and Stirlingshire coal-fields, remarked that the outstanding feature was the close approximation in elementary chemical composition of coals drawn from localities geographically far apart and from strata of different geological age, quoting as an example the close similarity between the ultimate composition of the famous Lanarkshire splint coal and those of the soft coals both above and below it.² The author's own investigations upon typical English coals have brought to light some interesting examples of coals possessing

¹ *Report on the Coal Testing Plant of the U.S. Geol. Survey*, Vol. I., 1906, pp. 156-73.

² *Journ. Soc. Chem. Ind.*, 1898, p. 1013.

COAL AND ITS SCIENTIFIC USES

quite different properties whose elementary compositions are very similar.

Certainly no present-day chemist who is familiar with the innumerable cases of isomerism among the compounds of carbon would for a moment accept any view which implied that such isomerism is not to be met with in coals. Coal is, of course, not a single homogeneous substance, but a heterogeneous mixture, in varying proportions, of several different types of substances of great molecular complexity which probably individually exist in many isomeric forms. And no classification can be regarded as satisfactory from a chemical standpoint, however useful it may be in other respects, which does not in some way or other take into account the nature and proportionate distribution of the principal constituents in the coal substance. Unfortunately, owing to our scanty knowledge of such matters, sufficient data for such a classification are not yet forthcoming.

CHAPTER VI

THE CHEMICAL COMPOSITION OF COAL (*contd.*)

D. THE CONSTITUENTS OF THE COAL SUBSTANCE AND THE ACTION OF VARIOUS REAGENTS AND SOLVENTS THEREON

I. GENERAL

If, as has been explained in the preceding chapters, the coal substance may be regarded from a chemical standpoint as essentially a mixture in variable proportions of the degradation or transformation products of the ligno-celluloses, proteids, and resinous matters comprising the original vegetable *débris*, it is all-important to know not only how far chemists have succeeded in detecting, or discriminating between, these several products in the coal substance, but also how each class of products is likely to affect the properties and uses of the coal, and especially how each class behaves when the coal is subjected to destructive distillation. For, viewed even from the lowest plane of immediate practical utility, our chemical knowledge of coal must be considered deficient until we are able, not only to give a rational analysis of any particular coal, but also to predict the influence of each type of constituent upon the behaviour of the coal at all temperatures, and upon the yields of the various products obtainable when it is distilled at any given temperature. And although it cannot be said that we have as yet reached such a point, it is well to know what should be the immediate goal of our endeavours, and what progress is being made in its direction.

Among the parent substances in the organic *débris* from which coals have originated, we are chiefly concerned with the following three principal classes:—

- (a) *Celluloses*, i. e. ligno-celluloses, essentially carbohydrates $n(C_{12}H_{18}O_6)$ of a cyclic type.
- (b) *Resinic*, i. e. gums, resins, and waxes, all of which are compounded of carbon, hydrogen, and oxygen, but may belong to many different chemical types.
- (c) *Nitrogenous*, i. e. proteid bodies, or compounds of carbon, hydrogen, oxygen, nitrogen, and sulphur.

COAL AND ITS SCIENTIFIC USES

These bodies have, during the formation of coal, been subjected first of all to the disintegrating influence of decay, as in modern peat bogs, followed by the combined action, continued through long geological ages, of great pressure and a slowly rising temperature, which latter, however, has certainly not exceeded 300° C. and may have been considerably less. In such circumstances the relatively unstable cellulosic and proteid constituents would certainly undergo such profound changes as would mask, if they did not entirely obliterate, their original characters, whilst it might be expected that the more stable resinous constituents would be affected to a considerably less degree.

There is some evidence also that small quantities of hydrocarbons are present in coals, whether associated with the resinic constituents or independently of them is not yet quite certain, but they are neither so prominent nor invariable as the three principal types which may now be considered more in detail.

(a) *Cellulosic (or Humic) Derivatives*

Renault in his well-known researches upon peat found that fungi and anaerobic bacteria play the most important part in the preliminary breakdown of the vegetable fibre into ulmic or humic compounds of the average composition:—

Carbon	=	65·30
Hydrogen	=	3·85
Oxygen	=	30·85

Mulder, Einof, Proust, and Braçannot have identified such bodies as the chief "cellulosic" constituents of peat, whilst Herz has found similar substances, which he called carbo-humic and carbo-ulmic acids, in lignites, and to which he assigned the following average composition:—

	Carbon.	Hydrogen.	Oxygen.
Carbo-ulmic acid . . .	62·36	4·77	32·87
Carbo-humic ,, . . .	64·59	5·15	30·26

In 1897 H. von Feilitzen and B. Tollens,¹ reporting the results of their chemical researches upon peat and its formation, stated that the cellulose content of a peat bog examined by them

¹ *Ber. deut. Chem. Ges.*, 1897, **30**, pp. 2571 to 2584.

THE CHEMICAL COMPOSITION OF COAL

rapidly diminished with the depth, as the following figures show:—

	Mean Percentage of Cellulose.
<i>Sphagnum cuspidatum</i> at surface	21·1
Peat { at 20 to 100 c.m. below surface	15·20
„ 100 „ 200 „ „ „	6·87

Similarly they also found that the quantity of pentosans $C_5H_8O_4$ present in the dry peat rapidly diminishes, and at the same time the total carbon content increases in almost like proportion, with the depth, as follows—

Depth below Surface in c.ms.	Percentages in the Dry Peat.	
	Pentosans.	Total Carbon.
20 to 100	12·75	51·08
100 „ 200	9·75	53·52
200 „ 300	5·87	58·66

These observations indicate how quickly the original cellulose, or other carbohydrate constituents of vegetable tissue, may be transformed into other products under the influence of decay organisms in a peat bog; and therefore, whilst in some lignites the original woody structure is well preserved, it is not to be expected that the original cellulose or ligno-cellulose is present in coals except in a greatly altered condition. The well-known fact, however, that both dry woody tissue and the coal substance show an early elimination of water when moderately heated in absence of air strongly suggests a “cellulosic” type of constituent as predominant in coal. Moreover, in 1901 S. Stein¹ obtained black products resembling coal in both outward appearance and elementary composition (C = 81·3 and H = 3·8 per cent.) by heating wood with water in sealed tubes to 290° C. for five hours, whilst more recently Bergius, by heating cellulose under pressure to a temperature of 340° C. has produced an “artificial coal” of the composition:—

	Per cent.
Carbon	84·0
Hydrogen	5·0
Oxygen	11·0

Chem. Centralblatt, 1901, ii. 950 and *J. C. S. Abstracts*, 1902, ii. p. 87.

COAL AND ITS SCIENTIFIC USES

(b) Nitrogenous Constituents

Vegetable proteid matter is even more susceptible than cellulosic bodies to the influence of decay organisms, and therefore, whilst the nitrogenous constituents of present-day coals may be regarded as having probably originated from proteids, they can only have survived in very greatly altered forms.

The elementary composition of proteids varies between the following limits:—

	Per cent.
Carbon . . .	50.0 to 55.0
Hydrogen . . .	6.9 „ 7.3
Nitrogen . . .	15.0 „ 19.0
Oxygen . . .	19.0 „ 24.0
Sulphur . . .	0.3 „ 2.4

Now since the nitrogen of coal usually varies between 0.75 and 1.75 per cent. with an average of, say, 1.25 per cent., it would seem unlikely that the amount of proteid degradation products contained in them exceeds on the average 10 per cent. of the total coal substance, and the proportion may be even less.

If a coal be heated out of contact with air, the evolution of ammonia is first observed, according to Carrick Anderson and Roberts, at 333° C. in the case of a gas coal, and at 480° in the case of anthracitic types. Later on, M. G. Christie in an investigation upon the nitrogenous contents of peat, gas coals, and anthracites, proved that whilst the evolution of ammonia begins at about 350° C. in the case of a gas coal, and at 450° in the case of anthracites, the principal evolution occurs between 500° and 700°, after which it almost ceases.¹ Only a small portion, usually not exceeding one-fifth, of the total nitrogen is ever evolved as ammonia in this way, the greater part of it remains firmly held in the residual coke. O. Simmersbach² has recently studied in great detail the distribution of the nitrogen between coke, tar, ammonia, hydrogen cyanide, and free nitrogen at various temperatures of carbonisation from a Silesian coal containing 1.396 per cent. nitrogen and 6.63 per cent. ash.

¹ *Inaug. Diss. Aachen*, 1908.

² *Stahl und Eisen*, 1914, 84, 1153 and 1209.

THE CHEMICAL COMPOSITION OF COAL

TABLE XXIII

Carbonisation Temperature C.°	Percentage of the Nitrogen appearing in				
	Coke.	Gas.	NH ₃ .	Tar.	HCN.
600	71.69	18.13	7.81	2.12	0.25
700	65.43	12.13	18.13	3.65	0.66
800	63.65	10.73	21.28	3.47	0.87
900	58.40	12.14	24.12	4.15	1.19
1000	49.98	21.53	23.15	4.11	1.23
1100	41.39	30.51	23.09	3.70	1.31
1200	26.43	45.10	22.84	4.21	1.42

It will thus be seen that the maximum formation of ammonia occurs at 900°, whilst upwards of 50 per cent. of the nitrogen remains in the coke up to 1000° and more than 25 per cent. at 1200°.

The distribution of its nitrogen when coal is distilled on a large scale may be illustrated by the following table of average results obtained (1) in testing some eighty Scottish coals (N = 0.915 up to 1.873 per cent.) at the Provan Gas Works in Glasgow, under conditions prevailing in a modern gas-retort, and (2) in coking a Durham coal (N = 1.57 per cent.) in Otto-Hilgenstock ovens at Blyden-on-Tyne.¹ It will be observed that the principal effect of the higher temperature in the coke oven as compared with the gas-works retort was to drive more nitrogen (as N₂) out of the residual coke, although it also caused a perceptible, though not material, lowering of the yields of ammonia and other basic nitrogen products.

		Gas-works.	Coke Ovens.	
Percentage of the Original Nitrogen	}	remaining in the coke . . .	58.3	43.31
		appearing as bases in the tar . . .	3.9	2.98
		recovered as ammonia . . .	17.1	15.16
		" " cyano-compounds	1.2	1.43
		appearing as N ₂ in the gas . . .	19.5	37.12
		<u>100.0</u>	<u>100.00</u>	

It thus appears that in large-scale distillation operations not more than 20 per cent. of the original nitrogen is recovered as ammonia and that upwards of 40 per cent. of it remains in the

¹ A. Short, *Journ. Soc. Chem. Ind.*, 1907, p. 581.

COAL AND ITS SCIENTIFIC USES

coke, even though the contents of the carbonising chamber have been raised to between 1000° and 1100° C.

So firmly is the residual nitrogen combined in the coke that, according to M. G. Christie's researches (*loc. cit.*), it is only very slowly expelled from it (as free nitrogen) as the temperature is gradually raised from 900° to 1900° C., and he considers it to be present in the original coal in an extraordinary stable "nitride" form as distinguished from the much less stable "imino" nitrogen existing as organic compounds which decompose below 900° C. yielding ammonia. Harger,¹ who has drawn attention to the very different results obtained in the estimation of nitrogen in coal by the Dumas and Kjeldahl methods respectively, also discriminates between what may be termed the "ammonia-yielding" nitrogen, which he suggests exists in a side chain in the parent molecule, and the "fixed nitrogen" which is stable at red heat, and which he thinks is probably present in some ring formation.² It therefore seems necessary to recognise the presence of at least two types of nitrogenous constituents of widely different stabilities in coal, each of which behaves according to its own nature on distillation. And the existence of so stable a type as that which Christie has designated the "nitride" constituent is in itself proof of the profound changes which the original proteid matter must have undergone in the process of coal formation.

It has been shown by the researches of Carrick Anderson and others that the nitrogenous constituents of coal are without influence upon its caking properties; the proteid origin of these compounds also accounts for the occurrence of "organic" sulphur in coal.

(c) *The Resinic Constituents*

The occurrence of fossil gums and resins has been frequently observed in peats, lignites, and other Tertiary coals. Mulder isolated from Friesland peats a number of resins similar to those which he had observed in lignites from districts as far apart as Saxony, Moravia, and New Zealand. Carrick Anderson and Henderson³ in a report upon some Japanese coals noted the frequent occurrence in them of pieces of clear bright resin of the size of peas or beans, an observation which the author

¹. *Journ. Soc. Chem. Ind.*, 1914, p. 389.

² *Ibid.*

³ *Ibid.*, 1902, p. 241.

THE CHEMICAL COMPOSITION OF COAL

can confirm from his own experience with certain Manchurian coals.

With regard to British coals, as long ago as 1838 James F. W. Johnston¹ isolated round masses of resin, seldom larger than a pea, from the coals of the Middleton Collieries near Leeds, and reported having observed thin layers of resinous materials between those of the coal. Analyses of the isolated resin masses were made, showing the following mean composition:—

Carbon	=	86.2
Hydrogen	=	8.0
Oxygen	=	5.8
		100.0

Mallet² also has published the following analyses of a fossil resin which was found in "small drops or tears of round or ovoid forms varying from the size of a pea to that of a hazel nut" in the coal measures in the neighbourhood of Wigan. It contained no nitrogen:—

	(1)	(2)
Carbon . . .	76.74	77.15
Hydrogen . . .	8.86	9.05
Oxygen . . .	10.72	10.12
Ash . . .	3.68	3.68
	100.00	100.00

Recently an American investigator, White, of the United States Geological Survey, has drawn attention to the evidence of the widespread occurrence of resinous constituents in coals of all ages, and has given the following particulars of the composition of a resin cast from a Montana coal:—³

	As Taken. %	Ash-free. %
Carbon . . .	72.69	76.40
Hydrogen . . .	8.85	9.30
Oxygen . . .	13.61	14.30
Ash . . .	4.85	—
	100.00	100.00

¹ *Phil. Mag.* (iii.), 12, p. 261.

² *Ibid.* (iv.), 4, p. 261.

³ *U.S. Geol. Survey Paper* 85 E., pp. 65 to 83.

COAL AND ITS SCIENTIFIC USES

It is probable, as White has remarked, that the carboniferous floras were at least as richly productive of resinous substances as those of later periods, and inasmuch as the chemical stabilities of such resins, when exposed to the action of decay organisms, are presumably much greater than those of either celluloses or proteids, it seems reasonable to suppose that they have undergone less alteration during the long transformation process, although it is probable that various "condensation" changes have occurred. It is therefore to be anticipated that the resinous constituents of coal will exhibit much less divergence from their parent types than do the degradation products of either the celluloses or proteids.

On the other hand, chemical investigation seems to show that the resinic constituents may be expelled or decomposed by heat fairly readily at comparatively low temperatures. Thus Carrick Anderson and Henderson found that the resinic constituents of certain non-caking Scottish coals could be driven off by heating them to between 300° and 315° C. in a current of carbon dioxide. The mixture of resins, with possibly other bodies, so eliminated had an elementary composition (C = 80.7, H = 9.5, and O = 9.8 per cent.) not unlike that of ordinary resin. Also it was found that the coking properties of caking coals were greatly impaired by such removal of resinic bodies.

The later researches of R. V. Wheeler and other workers indicate that the resinic constituents rapidly decompose between 400° and 700° C. yielding chiefly paraffin hydrocarbons but little hydrogen, within which temperature range also the cellulose derivatives certainly lose water (water of constitution) if they do not further decompose. Moreover, it is probably the rapid decomposition of the resinic constituents at comparatively low temperatures which is responsible for the long luminous flames and black smoke produced when raw bituminous coals are burnt in furnaces.

It may here be remarked that the term "resin" includes a large number of complex substances, of widely different chemical types, which are difficult to classify on any scientific plan. They are all (or nearly so) of vegetable origin, and are regarded by physiologists as waste products of plant metabolism, in which case those derived from plants of the same genus or order might be expected to have a similar chemical constitution. They are chiefly obtained either by the spontaneous evaporation of oleo-resinous juice exuded from the trunks of trees, or by the extrac-

THE CHEMICAL COMPOSITION OF COAL

tion of other parts of plants by means of such solvents as alcohol or ether, or they are found as "minerals" (*e. g.* amber) which have undoubtedly been produced by extinct vegetation.

They are all more or less amber-like, translucent and amorphous solids, or semi-solids, which soften at temperatures much below their melting points, which are rather indefinite. They exhibit in a marked degree the phenomenon of superfusion, and whilst insoluble in water, they are generally soluble in alcohol, ether and chloroform, from which solutions they may be precipitated in a colloidal form by the addition of any electrolyte such as aqueous hydrochloric acid. In this way they may be obtained as a white precipitate which slowly turns brown, owing to internal molecular rearrangements. The latter are independent of the influence of either oxygen or light.

In their natural condition resins are not chemically homogeneous, but are mixtures of allied substances. As a rule they contain (*a*) a *resinol acid*, which apparently contains both OH and COOH groups; (*b*) a saponifiable *resine* ester, and (*c*) a non-saponifiable *resene*, which is inert towards alkalis. They are termed resinol-resins, *resine*-resins, or *resene*-resins, according as constituent *a*, *b*, or *c* predominates. They also usually contain a carbonyl CO group. Another class of resins, known as *resino-tannols*, contain one or more of the constituents *a*, *b*, *c*, together with a tannic acid complex, and are fermentable. A recent authority, commenting upon the difficulty of defining or classifying resins, has remarked:¹ "So widely do the various resins that have been studied differ from one another chemically, that it seems likely that as a class they will ultimately disappear, being taken to fill in groups here and there in the structure of organic chemistry."

The mere knowledge that coals contain "resinic constituents" does not, therefore, carry us very far. No one has been able to define their real chemical nature; nor is it yet possible to say whether or not they differ in different types of coal, and if so, then to what extent. Before such questions can be satisfactorily answered much further chemical research is needed.

¹ Prof. A. Senier in his article upon "Resins" in Thorpe's *Dict. of Applied Chemistry*, Vol. IV., p. 559. The reader is also referred to A. Tschirch's *Die Harze und die Harzebehälter*, Leipzig, 1900.

COAL AND ITS SCIENTIFIC USES

II. METHODS OF CHEMICAL INVESTIGATION

The methods hitherto employed by chemists in investigating the nature of the coal substance may be summarised under three principal heads, namely:—

- (i) Chemical attack by means of various reagents which oxidise, decompose, or otherwise alter the coal substance.
- (ii) The action of solvents which are supposed to extract fractionally certain constituents without radically altering them.
- (iii) The action of heat, *i. e.* distillation either of the original coal or of certain extracted constituents thereof at definite temperatures and the examination of the various products so obtained.

The general character of the results yielded by the first two of these methods will be discussed in this chapter, leaving the third method to be dealt with separately later on.

(i) *Chemical Attack by Reagents.*—The reagents chiefly employed have been sulphuric and nitric acids, caustic alkalis, bromine, ozone and oxygen. Coal being a heterogeneous mixture of complex substances, all of which are amorphous, and most of them in forms which are imperfectly soluble in any known reagent, the chemist has naturally endeavoured to transform some of them by known chemical treatment into simpler and more easily definable products, capable of separation, purification, and recognition by ordinary analytical methods. Such attempts, however, have been largely abortive, because although such transformation products can be obtained, the yields are either so small, or the products themselves are in such an advanced stage of decomposition, that they afford but little reliable evidence as to the nature of the original coal constituents. And, again, where higher yields or less degraded products have been obtained, they have usually consisted of inseparable mixtures or solutions of amorphous or colloidal bodies which almost preclude further analysis. Incidentally, however, a good deal of valuable general information has accrued as the result of such experiments.

In 1891-2 Friswell¹ pointed out that by treating coals with dilute nitric acid some portions thereof may be converted into lustrous black and brittle substances, insoluble in water but

¹ *Proc. Chem. Soc.*, 1891-2, p. 9.

THE CHEMICAL COMPOSITION OF COAL

soluble in ammonia and alkalis, generally forming dark solutions. The acidification of such solutions causes the precipitation of bulky flocculent substances which are insoluble in solutions of acids and mineral salts but soluble to some extent in pure water. Carrick Anderson and Roberts¹ subsequently applied this method to a series of Scotch coals, finding that the resulting "coal acids," as they designated them, were of a fairly definite composition within the following limits:—

	Per cent.
Carbon	= 58.0 to 63.5
Hydrogen	= 2.75 „ 3.3
Oxygen	= 28.0 „ 32.5
Nitrogen	= 3.3 „ 4.8
Sulphur	= 0.3 „ 0.7

These compounds could be obtained from both caking and non-caking coals. This action of nitric acid was exothermic and involved a gain in weight amounting to between 10 and 23 per cent. of the weight of the coal taken.² The fact that a preliminary expulsion of the resinous constituent by heating the coal to 300° C. in a current of carbon dioxide did not materially affect the action of dilute nitric acid, or the character of the resulting oxidation products, proved that those "coal acids" are derived from the cellulosic or proteid constituent, or more probably from both, and that the constant presence of sulphur therein is a *prima facie* proof of the existence of "organic" sulphur in coals.

Fremy has shown that a mixture of monohydrated sulphuric and nitric acids will dissolve lignites as well as bituminous coals, giving rise to acidic oxidation products which he termed "ulmic" acids. Also Boudouard³ has stated that in his experiments atmospheric oxidation at 100° produced "humic" acids which, after extraction by means of potassium hydroxide solution and subsequent reprecipitation and purification, gave analytical results corresponding to one or other of the formulæ $C_{18}H_{14}O_6$, $C_{18}H_{18}O_9$, or $C_{18}H_{14}O_{11}$. He also observed that the invariable effect of such atmospheric oxidation is to destroy completely the coking properties of a coal, and to increase the proportion of "volatiles" expelled from it on carbonisation.

¹ *Journ. Soc. Chem. Ind.*, 1898, p. 1013.

² *Proc. Glasgow Phil. Soc.*, 29, pp. 72 to 96.

³ *Compt. rend.*, 1908, 147, 986, and *Bull. de la Soc. Chim.*, 5 (Series 4), 378 (1909).

COAL AND ITS SCIENTIFIC USES

In 1912 Donath and Bräunlich,¹ having previously investigated the action of dilute nitric acid upon coals, extended their work to a study of the products obtained by repeated fusions of the coal substance with alkaline hydroxide (*e. g.* KOH) at 250° and subsequent extraction with water. Brown coal, charcoal, and carbonised organic materials generally were found to give dark brown solutions, whilst those given by bituminous coals, coke, and graphite were colourless. Brown coals were almost completely converted into humic acids which could be separated into two fractions, one of which (1) was completely soluble in concentrated alkali, whilst the other (2) required the alkali to be very dilute. After precipitation from their respective alkaline solutions by acid a further difference was found between the two fractions in that (1) was completely soluble, and (2) insoluble in a 10 per cent. solution of ammonium carbonate. Fraction (1) contained, besides oxalic acid, a crystalline substance which gave a red coloration with ferric chloride, and a fatty acid. It was also found that a mixture of equal volumes of concentrated nitric and sulphuric acid reacts violently with brown coals and wood, but only slowly with true coals.

Similar results to the above have been obtained in the author's laboratory by the potash fusion method, but it is extraordinarily difficult to separate any pure substance from the resulting complex mixture of acid products. In one experiment, however, a small quantity of a crystalline acid, melting at 149°, and possessing other similar properties to those of adipic acid, $\text{C}_6\text{H}_4(\text{CH}_2)_4\text{CO}_2\text{H}$ was obtained. A mixture of this acid with an equal quantity of pure synthetic adipic acid melted also sharply at 149°, so that the identity of the two was thus satisfactorily established.

With regard to the action of halogens, it has long been known that bituminous coals react with bromine in the coal, as though they contain "unsaturated" or cyclic groups. In this connection it is interesting to note that in 1901 Fischer of Göttingen found that coals which are most liable to rapid oxidation and spontaneous ignition are also those which absorb bromine most readily,² a subject which will be again referred to in Chapter IX when the spontaneous oxidation of coal is considered. A research is in progress in the author's laboratory upon the absorption of bromine by coals, the result of which has shown that the halogen acts upon bituminous coals in the cold possibly by

¹ *Chem. Zeit.*, 1912, 86, p. 373.

² *Gas World*, April 13, 1901.

THE CHEMICAL COMPOSITION OF COAL

“substitution” as well as by “addition” and “adsorption.” The action, which falls off rather rapidly after twenty-four hours, continues for a very long time, and hydrogen bromide is evolved. Nübling and Wänner also have recently published a paper¹ in which it is stated that the portion of coal extracted by pyridine does not react with bromine. Cross and Bevan² have shown that Wigan coal is attacked by chlorine with the production of a chlorinated derivative similar to that previously obtained by them from lignified tissue, also that the coal is so profoundly changed by the action of potassium chlorate and dilute hydrochloric acid as to become entirely soluble in alkalis. By precipitation and further separation by means of suitable organic solvents (alcohol or acetone) a series of complex chlorinated acidic oxidation products was obtained.

The most recent work which must be noticed in this review is that of F. Fischer and Gluud, who have found that by suspending coal in water through which a stream of ozone is passed, it gradually dissolves, forming a dark brown solution of a substance which has the smell of caramel and a pronounced acid taste. It is slightly soluble in alcohol, sparingly so in ether, and almost insoluble in light petroleum. The investigation of the matter is being pursued further by them.³

The action of oxygen upon coals will be fully considered in Chapter IX hereof.

(ii) *The Action of Solvents.*—This method of attacking the coal question is, whenever applicable, undoubtedly preferable to either of the other two, inasmuch as it enables substances to be extracted with the minimal alteration to the coal substance. The difficulty is to find solvents that will differentiate sufficiently between the main constituents of the coal and extract a large proportion of some one of them, without at the same time having some depolymerising or other similar action upon the whole structure.

Smythe's Work.—One of the first workers to employ the method systematically was J. A. Smythe, who investigated at Göttingen the solvent action of benzene, chloroform, ethyl alcohol, ethyl ether, light petroleum, and acetone, in the order named, upon a brown coal from Brühl near Cologne. Of these ethyl ether and petroleum ether were found to have very little effect upon the coal, whilst benzene, chloroform, and alcohol all extracted

¹ *Journ. Gasbeleuchtung*, 1915, 58, p. 515

² *Phil. Mag.* 5 Sec. XIII., p. 328.

³ *Ber. deut. Chem. Ges.*, 1916, 49, 1472.

COAL AND ITS SCIENTIFIC USES

quantities of resinous bodies varying between 1·8 to 3·0 per cent. of the whole coal substance.

From the chloroform extract (1·8 per cent.) which was deep brown in colour, there was precipitated by the addition of petroleum ether to its solution, a brown amorphous resin, melting at 94° with slight decomposition, and having a composition (C = 76·45, H = 9·91, O = 13·64 per cent.) approximating to the formula $C_{15}H_{24}O_2$.

The dark brown benzene extract (3 per cent.) could be further divided into two portions, the one soluble and the other insoluble in ether. From the portion soluble in ether boiling acetone extracted a pale yellow amorphous resin melting at 78° to 80°. The portion insoluble in ether on distillation under a pressure of 8 m.m. came over between 300° and 350° C., condensing to an amber-coloured liquid which set to a light yellow waxy solid. After purifying this by treatment with a mixture of benzene and petroleum ether, it was finally obtained as a perfectly white crystalline solid melting at 81° to 82°, having a composition agreeing with the formula $C_{13}H_{26}O$. The whole scheme for the fractionation and purification of the original benzene extract was as follows:—

BENZENE EXTRACT (3 per cent.)	{	(a) SOLUBLE IN ETHER	=	BROWN AMORPHOUS POWDER	{	PORTION SOLUBLE IN ACETONE
				= m.p. 135° to 140° $C_{14}H_{18}O_2$	{	Pale Yellow Solid, m.p. 78° to 80° C = 79·23, H = 12·83, O = 7·97
		(b) INSOLUBLE IN ETHER	=	AMORPHOUS POWDER	{	DISTILLED UNDER 8 m.m. PRESSURE
				= m.p. 80° to 83° C = 77·75, H = 11·77, O = 18·48 per cent.	{	White Crystalline Solid $C_{13}H_{26}O$, m.p. 81° to 82° C = 79·18, H = 13·04, O = 7·78

The most notable feature of these results is the close resemblance between the chemical composition and physical properties of the end products obtained by the purification of the two fractions *a* and *b*; they are both resins melting at 80° and having a composition conformable with the formula $C_{13}H_{26}O$.

The Action of Pyridine.—In 1899 P. P. Bedson, in a paper before the North of England Institute of Mining Engineers, drew attention to the fact that pyridine has a remarkable solvent action upon bituminous coals, and subsequently, at his suggestion, P. Baker examined its action upon four different coals,

THE CHEMICAL COMPOSITION OF COAL

namely (1) a South Wales Anthracite, which was practically unaffected by it; (2) a Durham Gas Coal (Hutton Seam) from which 20.4 per cent. was extracted; (3) a Durham Coking Coal (Brockwell Seam), which yielded 11.5 per cent.; and (4) a New Zealand Brown Coal, which yielded 5.65 per cent. Carrick Anderson was also informed of the method, and used it in his researches upon the coals of Bengal and Japan in 1902.¹ The details of Bedson's own work were ultimately embodied in a paper read before the Newcastle-on-Tyne Section of the Society of Chemical Industry in 1908,² since which time the method has been extensively employed by other investigators, who have considerably added to our knowledge of its significance.

As originally introduced by Bedson, the method consisted essentially in submitting a weighed amount of the finely divided coal to the action of pyridine in a Soxhlet extraction apparatus for several hours. From the pyridine solution so obtained, after removing the greater portion of the solvent by distillation under reduced pressure, the dissolved matter was precipitated by dilute hydrochloric acid, filtered off, and subsequently washed, dried and weighed. The portion of the coal undissolved by the pyridine was also washed to free it from any of the retained solvent, and finally dried and weighed. This treatment was afterwards modified by him in the following particulars:—(1) the coal was ground so as to pass through a sieve of 30 meshes to the linear inch, (2) 5 grams of it were mixed well with sufficient sand to make a column rising to the top of the syphon tube of a Soxhlet apparatus, the mixture of coal and sand resting in the apparatus upon a layer of broken clay pipe-stems and a pad of absorbent wool, (3) the extraction of the coal was allowed to proceed for several hours until it was judged to be complete by the absence of colour in the pyridine flowing through the syphon tube of the Soxhlet apparatus, and (4) the solution was finally brought into an evaporating basin and the pyridine evaporated off in a good current of air; the dried residue was then broken up and heated on the water bath until the odour of pyridine had disappeared.

The pyridine solutions so obtained from coals are dark brown in colour with, sometimes, a green fluorescence, and the proportion of the coal substance extracted ranges from practically zero in the case of anthracites up to between 35 and 40 per cent. in the case of a good gas coal. The extract remaining after the

¹ *Journ. Soc. Chem. Ind.*, 1902, p. 241.

² *Ibid.*, 1908, p. 147.

COAL AND ITS SCIENTIFIC USES

solvent has been driven off is a chocolate brown amorphous solid, which on ignition decomposes with intumescence, yielding a large proportion of "volatiles" and a swollen residue of coke.

Bedson published the following particulars (Table XXIV) of results obtained with six different gas coals procured from the Redhaugh Gas Works, Newcastle-on-Tyne, with which the actual working results as regards yields of gas and coke had been definitely established at the works.

TABLE XXIV

PROFESSOR P. P. BEDSON'S EXPERIMENTS WITH COALS FROM REDHAUGH GAS WORKS

Coal.	Yield of Gas Cub. Ft. per Ton.	Illuminating Power of Gas Candles.	Yield of Coke Cwt per Ton.	% Ashes in Coke.	Percentages on Coal.		Percentages on Dry Ashless Coal.	
					Volatile.	Pyridine Extract.	Volatile.	Pyridine Extract.
A.	11,381	16.63	13.55	8.53	34.10	32.36	35.69	33.86
B.	11,392	16.50	13.51	8.92	33.28	33.59	34.60	34.93
C.	11,646	16.40	13.73	8.50	31.91	24.58	34.78	26.80
D.	11,108	16.00	14.25	7.80	31.70	22.81	33.47	24.08
E.	10,913	16.39	13.36	10.80	33.65	29.97	36.39	32.42
F.	10,730	15.76	13.29	15.12	28.87	22.53	33.48	24.43

The Manager of the Redhaugh Gas Works (Mr. Thomas Hardie) described A and B as "good" gas coals, C and D as "medium," whilst E and F he regarded as being "bad" ones, but from Bedson's experiments there was apparently no correlation between the amounts of pyridine extracts obtained from them and either their gas-making qualities or their yields of volatiles. As the result, however, of investigation upon these and other coals, including typical Durham coking varieties, Bedson was able to say that "the extracts in each case were found to be rich in volatile constituents, and in the coking assay gave highly intumescent cokes, whereas the residues left after extraction were almost devoid of coking properties. In the case of the coking coal from the Brockwell Seam, the portion insoluble in pyridine had not completely lost the coking power, but yielded a coke much less bulky than that left by the original coal." Also that, in an examination of the different parts of the Busty Seam coal from Birley, Co. Durham, the "bright coal" contained considerably more matter extractable by pyridine than the associated "dant" or "mother of coal," for whereas the "bright

THE CHEMICAL COMPOSITION OF COAL

coal" yielded 19.38 per cent. of extract, the "dant" behaved similarly to anthracite and yielded only a fraction of a per cent.

R. V. Wheeler and his co-workers¹ have further examined the method which, if supplemented by a subsequent chloroform extraction of the original pyridine extract, they consider may be used for the complete separation of the cellulosic and resinic constituents of coal. The method of extraction employed by them was as follows:—

The coal, ground to pass through a sieve of 94 meshes to the linear centimetre, was extracted in separate portions of 10 grams (each contained in a filter paper thimble) in a Soxhlet apparatus. The flask of each extraction apparatus contained about 200 c.cs. of pure pyridine which was kept gently boiling on an electrically heated sand bath, overheating being carefully guarded against. Each 10 grams portion was treated for a week continuously, the pasty mess in the thimble well stirred, and then further extracted for a week with fresh pyridine.

When extraction was complete, the solution was filtered and the pyridine distilled at 60° under reduced pressure, a fine stream of air being allowed to bubble through the liquid to ensure rapid evaporation. When most of the pyridine had been removed in this way, the mass remaining in the distillation flask was washed out on to a clock-glass by a fine jet of warm pyridine. Removal as far as possible of the last traces of pyridine was effected by heating the clock-glass at a temperature of 80° in a current of dry air, and, after being ground to a fine powder, the chocolate-coloured solid was finally kept in a vacuous desiccator over strong sulphuric acid to complete the removal of pyridine. The residue of the coal, insoluble in pyridine, was washed with ether, and then heated in a similar manner to the dried extract.

To obtain the chloroform extract, 10 grams of the dried pyridine extract were treated in an extraction thimble in a Soxhlet apparatus with 200 c.cs. of pure chloroform for two weeks on a water bath, and the chloroform then distilled off in a partial vacuum. The chloroform extract and the residue were freed from chloroform in a manner similar to that employed by freeing the pyridine extract and residue from pyridine.

The results obtained by Wheeler and Clark on subjecting a typical bituminous coal to the aforesaid double extraction, by

¹ Burgess and Wheeler, *Journ. Chem. Soc.*, 1911, 99, p. 649. Clark and Wheeler, *ibid.*, 1913, 103, p. 1704.

COAL AND ITS SCIENTIFIC USES

which means they claim to have made "a complete, or nearly complete, separation between the resinous constituents and the degradation products of the celluloses of which coal is conglomerated," are shown in the following diagram:—

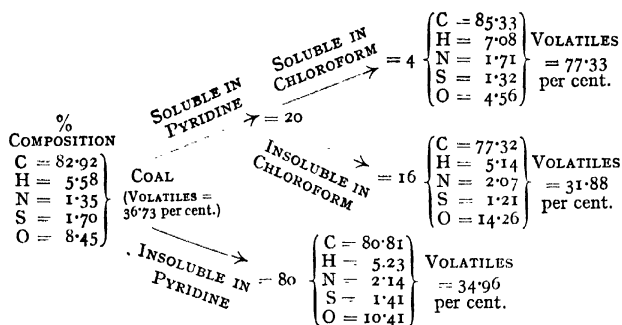

In view of the claim made by the authors in question, it is to be regretted that they did not investigate, and define more closely, the physical properties of their final products, and as they stand, the above results are open to three criticisms, namely:—(1) that the sum total of nitrogen in their products is nearly double that in the original coal treated, showing that some of the solvents had been retained by the various fractions, despite the pains taken to remove it, (2) that a product containing as much as 1.71 per cent. of nitrogen and 1.32 per cent. of sulphur, as did the portion soluble in both pyridine and chloroform, cannot be regarded as a reasonably pure "resinous" body, and (3) that inasmuch as the total oxygen in the various fractions is about 1.27 times that in the original coal, there had apparently been some absorption of oxygen during the extraction processes, no precaution having been taken to exclude air.

From his own experience of the action of solvents upon coals, the writer is inclined to think (1) that the method described by Wheeler does not effect quite so clear and complete a separation of the resinic and cellulosic constituents as he supposed, (2) that in applying it he did not sufficiently take into account the nitrogenous constituents of the coal, and (3) that the non-exclusion of oxygen in his experiments may have appreciably affected his results.

Wahl,¹ who examined the action of pyridine upon a number

¹ *Compt. rend.*, 1912, 154, p. 1094.

THE CHEMICAL COMPOSITION OF COAL

of continental coals, mixed the dried powdered sample with an inert salt (NaCl , or K_2SO_4) soluble in water but insoluble in pyridine, and extracted the mixture in a Soxhlet apparatus in the usual manner. He subsequently concentrated the filtered pyridine solution in a vacuum, poured the residual liquid into concentrated hydrochloric acid, and after collecting and washing the pyridine extract in a filter, he finally dried it. His results (Table XXV) confirmed Bedson's observations that there is no relation between the weights of extractable matter and of "volatiles" yielded by the coal on ignition. In the cases of coals which yielded a large proportion of extract, the coking power was not lost, but the coke from the residue was much more compact than that obtained from the original coal. On the other hand, it was stated that the coke obtained from the extracts was extremely "puffy" (boursoufflé), and that on mixing the extract with the residue the original coking properties were reproduced.

TABLE XXV

			Percentages on Dry Ashless Coal.		Percentages of Volatiles in Insoluble Residue.
			Extract.	Volatiles.	
Bethune	Fosse	II	29.3	35.09	31.48
Frankenholtz	Couche	X	19.7	40.83	35.80
"	"	XI	19.0	43.88	39.04
"	"	XII	18.0	41.44	38.08
Lens	Fosse	III	25.9	35.97	32.24
"	"	VII	trace	13.96	14.32
"	"	VIII	0.45	21.76	22.75
Spanish Lignite		22.9	46.49	40.68
Boghead		6.45	55.21	54.38

The following comparative figures for the elementary compositions of the original sample, and of the corresponding pyridine extract and residue, in the case of the Bethune coal indicate a surprisingly small difference between them:—

	C.	H.	N.	S.	O.
Original Coal	85.95	5.55	1.18	0.76	6.56
Extract	85.55	6.09	1.41	0.53	6.42
Residue	84.66	5.23	—	—	—

Subsequently to the foregoing researches, Harger¹ has found

¹ *Journ. Soc. Chem. Ind.*, 1914, p. 389.

COAL AND ITS SCIENTIFIC USES

that not only the speed, but also the practical limit, of the solvent action attained when the coal is extracted in a Soxhlet apparatus, is greatly exceeded when the operation is carried out in a sealed glass tube at 160° to 180° C. under pressure. Thus a Lancashire "Arley" coal which yielded only 22.5 per cent. of soluble extract by the Soxhlet method after 14 days, gave as much as 40.5 per cent. in a sealed tube after 24 hours, and, moreover, a greater quantity of extract was obtained in the sealed tube in 24 hours than after months in the Soxhlet apparatus. From these facts, as well as from the circumstances that (as he states) chemical analyses of the soluble and insoluble portions from the same bituminous coal show but little difference between their ultimate composition (*vide* also Wahl), and that all the fractions contain more nitrogen than does the original coal (*vide* Wheeler), he agreed that the action of pyridine upon coal is not a case of ordinary solution, but that it is essentially a depolymerising one, a conclusion which seems to be supported by the work of other investigators.

From researches recently carried out in the author's laboratory, the details of which it is hoped will be published shortly, it would appear that in order to obtain any reliable comparative results with a series of coals by the Soxhlet extraction method, attention must be paid to the purity of the pyridine, and especially to its being anhydrous. Commercial pyridine contains picolines and lutidines, which may be oxidised by means of nitric or chromic acids to the corresponding carboxylic acids and so removed. It also has a strong affinity for water forming hydrates, principally $C_5H_5N \cdot 3H_2O$, b.p. 95°. Now we have found that the presence of these hydrates diminishes and retards the action of pyridine upon coal, so that it is necessary in comparative experiments not only to use purified anhydrous pyridine, and to dry the coal before its extraction, but also to exclude any subsequent entry of water vapour into the apparatus. Moreover, we have discovered that if, during the extraction process, the contents of the apparatus are exposed to an atmosphere containing oxygen, the latter is absorbed, and not only is the extraction thereby retarded, but various oxidations occur which affect the coal substance to a degree which varies with the character of the coal affected, some coals being much more susceptible than others to such change. Hence, in order to get really comparable figures with different coals, we have found it necessary to carry out the Soxhlet extraction in an inert atmosphere of nitrogen, and in

THE CHEMICAL COMPOSITION OF COAL

subsequently concentrating or treating the resulting solution to avoid as much as possible any contact with air. The unrestricted access of air in both Bedson and Wheeler's experiments may, we think, have appreciably affected their results.

Various general observations made during the course of the researches referred to in the previous paragraph indicate that, besides any ordinary solvent action which pyridine may have upon the resinic constituents, which is probably fairly rapid, it also at the same time slowly attacks and resolves into simpler molecular aggregates the complex structure of the coal substance as a whole. Or, to suggest an analogy which in the circumstances seems permissible, if the coal substance be regarded as a structure built of bricks and mortar, with various other materials incorporated therewith, the action of pyridine may perhaps be likened to that of an agent which gradually loosens the brickwork, at the same time removing preferentially (but not exclusively) the mortar as the structure is unbuilt.

It has also been discovered in the author's laboratory that the resinic constituents may be removed from a bituminous coal and obtained in a purified state, free from nitrogen and sulphur compounds, by subjecting it to the action of a boiling mixture of equal parts of amyl alcohol and pyridine under suitable conditions with exclusion of air. Details of the method will shortly be published elsewhere, but by boiling 1 kilogram of a Yorkshire coal with 2 litres of the mixture of amyl alcohol and pyridine for two days, and subsequently purifying the crude resinous extract, a pure non-nitrogenous resene substance has been isolated. It melted at 42° C. and had the following elementary composition:—

C = 81.92 H = 9.50 O = 8.58 per cent.

A further development of this method promises well to become a general one for the isolation and separation of the resinic constituents from coals, uncontaminated with the cellulosic or proteid degradation products, and it is hoped that it may facilitate the detailed study of the chemical nature of the resinic constituents in coals from different fields and seams.

The Action of other "Basic" Solvents.—Among other organic bases which are known to have a similar "solvent" action upon the coal to pyridine should be mentioned aniline (b.p. 184°) and quinoline (b.p. 238°), both of which have been investigated in

COAL AND ITS SCIENTIFIC USE

this connection by Vignon.¹ In the case of aniline he boiled 100 grams of the powdered coal with 500 grams of the solvent in a litre flask for 4 hours at 180°. The liquid was then filtered under reduced pressure, and the extract was precipitated by the gradual addition of sufficient hydrochloric acid to the cold filtrate. Vignon found that the degree of solvent action varies considerably according to the nature of the coal, being greatest with a rich gas coal, and that the method offers a ready means of distinguishing between "fat" and "lean" coals in this connection, as the following figures indicate:—

	Percentages of the Dry Ashless Coal. Extracted.
(1) Rich Gas Coal (<i>grasse à gaz</i>)	26·8
(2) Medium Coal (<i>demi-grasse</i>)	7·2
(3) Lean Coal (<i>maigre</i>)	1·8

Analyses of one of the coals, and of the "extract" obtained from it, gave the following figures, showing that the extract, like those obtained by Bedson, Wheeler and others by the action of pyridine upon coals, contains notable quantities of both nitrogen and sulphur.

	C.	H.	N.	S.	Ash.	Coke.
Original Coal	81·5	4·9	1·7	1·1	3·1	72·05 per cent.
Extract	83·50	5·6	1·37	1·05	0·46	69·69 „ „

The "coke" yielded by the "extract" was swollen and agglomerated, whilst that from the insoluble residue was powdery.

The solvent action of quinoline at its boiling point (238°) upon coals was found to be almost three times as great as that of pyridine (b.p. 114·5°), and nearly twice as great as that of aniline (b.p. 184°) under similar conditions (see below), from which it would appear as though the action of these "basic" solvents is primarily a question of temperature, which again suggests an "unbuilding" of the coal structure.

Solvent.	B.P.	Percentage extracted from Rich Gas Coal.
Pyridine	114·5°	17·3
Aniline	184°	26·8
Quinoline	238°	47·3

The Action of Phenol.—Two American investigators, Parr and

¹ *Compt. rend.*, 1914, 158, p. 1421.

THE CHEMICAL COMPOSITION OF COAL

Hadley,¹ have recently found that considerable proportions of the coal substance may be extracted by heating it with phenol at 100° for 20 hours in an atmosphere of carbon dioxide. As much as 35 to 40 per cent. was extracted from coals having "high volatile contents," and between 20 to 30 per cent. from those whose "volatile contents" were low. In all cases the insoluble "residues" were non-caking, the "extracts" contained the "coking" constituents and gave the larger yield of "volatile" than the original coal, and both the "residues" and the "extracts" absorbed oxygen at the ordinary temperature.

The Work of F. Fischer and W. Gluud upon the Extraction of Coals by Benzene under High Pressure.—If, as seems probable, while such agents as pyridine, aniline, quinoline, and phenol may extract much more from coal than do more neutral solvents, their action involves some radical changes, or unbuilding of the coal substance itself, and therefore does not discriminate between its various constituents as sharply as an extraction method ought to do, chemists will be compelled to devise means for accelerating and improving the action of such other solvents as benzene, toluene, alcohol and chloroform, which presumably extract the more soluble constituents in the form in which they actually exist in the coal substance without causing any fundamental chemical change in it.

With this end in view, F. Fischer and W. Gluud of the Kaiser Wilhelm Institute for Coal Investigations in Berlin have recently studied the action of benzene upon coals at temperatures and pressures approximating to the critical constants of the solvents (about 288° C. and 50 atmospheres), with most interesting results.

The extractions were carried out in a steel bomb (62 c.m. long and 12 c.m. internal diameter with walls 2 c.m. thick) capable of withstanding a pressure of 200 atmospheres. Each charge of coal (1 to 2 kilos, broken to the size of hazel nuts) was suspended in a wire gauze basket within the bomb, so as to prevent any contact with the walls thereof, and extracted with from 3 to 3½ litres of benzene, heat being applied to the bomb externally by means of a powerful triple burner surrounded by a sheet-iron cylinder to concentrate the heat as far as possible. The temperature was raised to 275° C., corresponding to a pressure of about 55 atmospheres, and maintained at that degree for an hour, after which the heat was cut off

¹ *Journ. Soc. Chem. Ind.*, 1915, p. 213.

COAL AND ITS SCIENTIFIC USES

and the bomb allowed to cool slowly. Each sample of coal was repeatedly extracted in this manner. Finally the resulting benzene solutions, which had a strong green fluorescence in reflected light, and a dark port-wine colour when viewed in thin layers by transmitted light, were distilled on the water bath (under pressure of 200 m.m. at the finish) and the residual extract weighed.

The following particulars of an experiment with an Osterfield bituminous coal, which on repeated extraction at atmospheric pressure by means of boiling benzene (80° C.) in a reflux apparatus had yielded only 0·1 per cent. of its weight to the solvent, will indicate how extraordinarily effective was the change to a temperature of 275° and a pressure of 55 atmospheres in promoting the solvent action:—

Quantity of Coal taken = 1300 grams.	Solvent used = 3·5 litres.
Weight of } 1st Extrn. 2nd Extrn. 3rd Extrn. 4th Extrn. 5th Extrn.	
Extract } 40 grams. 22 grams. 11·5 grams. 8 grams. 5·5 grams.	
Total extract = 87 grams. = 6·7 per cent. of the Coal taken.	

There was no liberation of gas on opening the cooled bomb after each extraction, from which the investigators concluded that the temperature had not been high enough during the experiment to cause even incipient decomposition of the coal, which, according to Wheeler, begins at 270° C. The residual extracted coal had not materially altered in appearance, although it had lost some of its lustre and internal cohesion. The viscosity of the successive extracts increased as the process was continued, and on pouring the united extracts, mixed with sufficient benzene to make them flow easily, into 500 c.c. of petroleum ether, 45 grams of a brown powder separated out. On heating this powder it softened at 140° and melted at about 150°. From this description of its properties it was presumably resinic in character, though this surmise needs to be confirmed by further investigation. From the portion remaining in solution in the petroleum ether there was recovered on evaporation about 12 grams of a viscous reddish yellow fatty oil.

In another experiment, in which 1 kilo of a Weban Brown Coal was subjected to three successive extractions in the bomb with 3 litres of benzene at a temperature of 260° and a pressure of 60 atmospheres, no less than 251 grams of "extract" was obtained, although the fact that a considerable amount of gas, smelling strongly of sulphuretted hydrogen, was liberated on opening the bomb suggests that incipient chemical

THE CHEMICAL COMPOSITION OF COAL

decomposition had occurred during the extraction process. In a third experiment, 1820 grams of a Wehofen Cannel Coal, on being subjected to a similar triple extraction with 3.5 litres of benzene, yielded altogether 3 per cent. of its weight of extract against only 1.1 per cent. when extracted with the boiling solvent at atmospheric pressure in a reflux apparatus.

As the result of this investigation the method of extraction with benzene and other similar solvents has undoubtedly acquired a greater scientific, and possibly even technical, importance than it had attained hitherto, although it is too soon yet to say how far it will advance the solution of the problem of the chemical constitution of coal. Much will depend upon whether or not further investigation will warrant the underlying assumption that the employment of temperatures as high as 250° to 260° C. with what are usually regarded as "neutral" solvents does not involve any material alteration of the coal substance, a point of cardinal importance in connection with the interpretation of all such work.¹

The Work of Pictet, Ramseyer and Kaiser.—The only other recent work that throws much light on this aspect of the subject is that of Pictet, Ramseyer and Kaiser,² who, after studying the nature of the tars obtained by the distillation of bituminous coals under reduced pressure ("vacuum tars"), applied themselves to determine whether or not the constituent of such tars (chiefly cyclic hydroaromatic hydrocarbons C_nH_{2n} , ranging from C_9H_{18} to $C_{13}H_{26}$ inclusive, and a crystalline $C_{30}H_{60}$) exist as such in the original coal.

They accordingly proceeded to extract 5½ tons (say 5500 kilos) of Montrambert coal with boiling benzene in reflux apparatuses for 4 days, and on subsequently concentrating the resulting solution by distillation to 20 litres and adding 100 litres of light petroleum thereto, 2.7 kilos of an amorphous brown powder was precipitated, whilst the remaining solution yielded on evaporation of the solvent 10.6 kilos of a liquid resembling "vacuum tar." Subsequent fractional distillation of it gave the following hydrocarbons:—

Dihydrotoluene C_7H_{10} , *Dihydrometaxylene* C_8H_{12} , *Dihydromesitylene* C_9H_{14} , also $C_{11}H_{18}$, $C_{14}H_{18}$, $C_{13}H_{12}$ (? solid), *Dihydrofluorene*, C_8H_{10} , C_9H_{12} , $C_{10}H_{14}$, $C_{11}H_{16}$, $C_{12}H_{18}$, $C_{13}H_{20}$, and

¹ Since this paragraph was written, Dr. Wheeler has informed the author that he has recently found evidences of decomposition in certain coals at temperatures even as low as 180° C.

² See also the *Gas World*, Jan. 13, 1917.

COAL AND ITS SCIENTIFIC USES

$C_{30}H_{60}$. Of these the $C_{11}H_{22}$, $C_{12}H_{24}$, $C_{18}H_{36}$, and $C_{30}H_{60}$ were identified with those found in vacuum tar, which in their turn were the same as those found by Mabery in Canadian petroleum. Hence the French investigators concluded that such hydrocarbons actually exist in coal, which they regard as a solid hydrocarbonaceous material impregnated with a liquid chemically very nearly resembling petroleum. It must, however, be remembered that, whilst the products obtained by the Frenchmen resemble those got by Fischer and Gluud, their yields were many times smaller, namely about 0.25 per cent. of the coal substance as against up to 6-7 per cent. in the German experiments. Moreover, whilst doubtless there are grounds for believing that the coal substance may be in some cases impregnated with petroleum hydrocarbons, it is hardly safe to base a general conclusion respecting the nature of coal upon the finding of only 0.25 per cent. of them in a particular sample.

THE CHEMICAL COMPOSITION OF COAL

decomposition had occurred during the extraction process. In a third experiment, 1820 grams of a Wehofen Cannel Coal, on being subjected to a similar triple extraction with 3.5 litres of benzene, yielded altogether 3 per cent. of its weight of extract against only 1.1 per cent. when extracted with the boiling solvent at atmospheric pressure in a reflux apparatus.

As the result of this investigation the method of extraction with benzene and other similar solvents has undoubtedly acquired a greater scientific, and possibly even technical, importance than it had attained hitherto, although it is too soon yet to say how far it will advance the solution of the problem of the chemical constitution of coal. Much will depend upon whether or not further investigation will warrant the underlying assumption that the employment of temperatures as high as 250° to 260° C. with what are usually regarded as "neutral" solvents does not involve any material alteration of the coal substance, a point of cardinal importance in connection with the interpretation of all such work.¹

The Work of Pictet, Ramseyer and Kaiser.—The only other recent work that throws much light on this aspect of the subject is that of Pictet, Ramseyer and Kaiser,² who, after studying the nature of the tars obtained by the distillation of bituminous coals under reduced pressure ("vacuum tars"), applied themselves to determine whether or not the constituent of such tars (chiefly cyclic hydroaromatic hydrocarbons C_nH_{2n} , ranging from C_9H_{18} to $C_{13}H_{26}$ inclusive, and a crystalline $C_{30}H_{60}$) exist as such in the original coal.

They accordingly proceeded to extract 5½ tons (say 5500 kilos) of Montrambert coal with boiling benzene in reflux apparatuses for 4 days, and on subsequently concentrating the resulting solution by distillation to 20 litres and adding 100 litres of light petroleum thereto, 2.7 kilos of an amorphous brown powder was precipitated, whilst the remaining solution yielded on evaporation of the solvent 10.6 kilos of a liquid resembling "vacuum tar." Subsequent fractional distillation of it gave the following hydrocarbons:—

Dihydrotoluene C_7H_{10} , *Dihydrometaxylene* C_8H_{12} , *Dihydromesitylene* C_9H_{14} , also $C_{11}H_{18}$, $C_{14}H_{22}$, $C_{13}H_{20}$ (? solid), *Dihydrofluorene*, C_8H_{10} , C_9H_{12} , $C_{10}H_{14}$, $C_{11}H_{16}$, $C_{12}H_{18}$, $C_{13}H_{20}$, and

¹ Since this paragraph was written, Dr. Wheeler has informed the author that he has recently found evidences of decomposition in certain coals at temperatures even as low as 180° C.

² See also the *Gas World*, Jan. 13, 1917.

COAL AND ITS SCIENTIFIC USES

benzene (C_6H_6), carbon monoxide (CO), carbon dioxide (CO_2), and nitrogen (N_2). But the mere obtaining of such products, and the known variations (both qualitative and quantitative) in them, according to the nature of the coal carbonised and also to the temperature and other conditions to which it is subjected, although of great economic importance, do not help us very far in unravelling the chemistry of the coal substance, because they represent, not the primary products of its initial decomposition by heat, but the end result of a complex series of secondary decompositions and interactions of the primary products. It is, therefore, chiefly upon the study of the decomposition of the coal substance at low temperatures that we must base any conclusion as to its nature.

Owing to the fact that the low temperature distillation of coal (at from, say, 400° to 600° C.) has the effect of decomposing the smoke-producing part of the coal substance and yielding (1) in the case of suitable classes of caking coals, a porous "semi-coke" which is smokeless in its combustion, (2) certain quantities of "fuel oils" and "motor spirit," and (3) a comparatively small proportion of rich gas, containing chiefly methane, ethane, together with ethylenic hydrocarbons, C_nH_{2n} , hydrogen (5 to 15 per cent.), and oxides of carbon, high expectations of its future commercial possibilities have been raised in some quarters. But the matter is still so much in the early stages of its technical development that the author wishes it to be understood that he is now concerned solely with its scientific aspects without in any way committing himself to any view or opinion about its commercial prospects.

Among recent researches upon the thermal decomposition of coal, those of M. J. Burgess and R. V. Wheeler¹ are perhaps of first importance inasmuch as they deal in great detail with the volumes and composition of the gases evolved when typical coals are maintained at progressively increasing temperatures up to 1100° C.

In their experiments 200 grams of a powdered South Yorks. (Altofts) Silkstone bituminous coal were maintained in a vacuum (20 m.m.) successively at temperatures of 100° , 200° , 300° , 350° , 400° , and 450° C. for a sufficient time to allow of equilibrium being established in the system at each successive stage in the heating operations. The various gases and condensable products

¹ *Journ. Chem. Soc.*, 1910, **97**, 1917; 1911, **99**, 649; 1914, **105**, 131; *vide* also A. H. Clark and R. V. Wheeler, *ibid.* 1913, **103**, 1704.

THE CHEMICAL COMPOSITION OF COAL

evolved between each successive temperature stage were separately collected for subsequent examination. The apparatus was arranged as shown in Figs. 7a and 7b,¹ and each experiment extended over 4 to 8 weeks continuously.

The principal facts established during the experiments, the results of which are summarised in Table XXVI, were (1) that

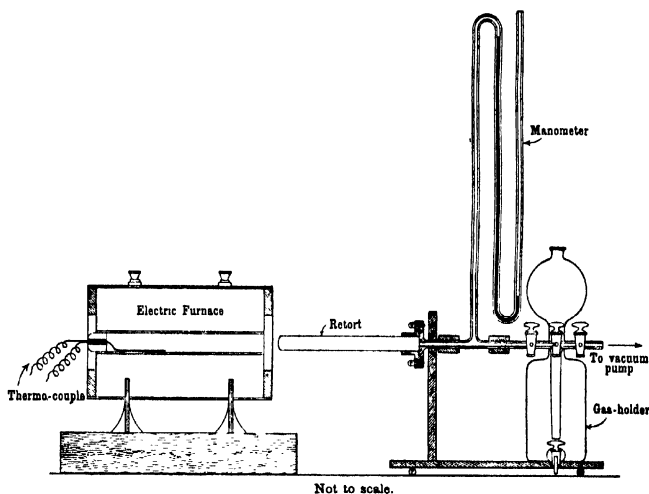

FIG. 7a.—Distillation Apparatus used by Burgess and Wheeler.



FIG. 7b.—Platinum Retort used by Burgess and Wheeler.

“occluded” or “condensed” gases, mainly the higher paraffin hydrocarbons, continue to be evolved in small quantities up to 150° or even 200° C., (2) that at about 200° there is a copious evolution of water (“water of constitution”) which continues right up to, and probably beyond, 450°, (3) that between 270° and 300° sulphuretted hydrogen is freely evolved, which circumstance the authors in question ascribed to the decomposition of organic sulphur compounds; this evolution practically ceases at 300°.

¹ Reproduced from drawings kindly lent to the author by Dr. R. V. Wheeler.

COAL AND ITS SCIENTIFIC USES

TABLE XXVI
SUMMARY OF BURGESS AND WHEELER'S EXPERIMENTS ON THE DISTILLATION OF COAL IN A VACUUM

Temperature Interval.	Up to 100°.	100° to 200°.	200° to 300°.	300° to 350°.	350° to 400°.
Volume of Gases evolved in c.c.s. at N.T.P. per 100 grams of Coal	34.0	65.5	58.5	985	4000
Percentage Composition of the Gases $\left. \begin{array}{l} \text{H}_2\text{S} \\ \text{CO}_2 \\ \text{CO} \\ \text{C}_2\text{H}_4 \\ \text{C}_2\text{H}_2 \\ \text{C}_2\text{H}_6 \\ \text{C}_3\text{H}_6 \\ \text{C}_3\text{H}_8 \\ \text{H}_2 \\ \text{O}_2 \end{array} \right\}$	6.7 1.4 0.85 1.30 84.55 1.90 1.05	8.85 2.66 0.85 2.90 81.00 2.75 0.70	35.35 10.50 1.05 18.85 18.85 13.35	1.70 20.95 3.40 1.90 17.90 37.22 15.35	0.70 2.85 3.40 2.35 6.15 46.55 36.90
	Paraffins included Higher Members than C_3H_8	Paraffins included C_6H_{10}	$\text{C}_4\text{H}_8 = 0.55$	$\text{C}_2\text{H}_2 = 0.15$	$\text{C}_3\text{H}_8 = \text{trace}$
Remarks	Evolution of H_2S almost ceased at 300° Critical Decomposition Temperature reached at 350°		Evolution of Water began at 200°, and of Oils at 310°		

THE CHEMICAL COMPOSITION OF COAL

and, simultaneously, olefines higher than ethylene make their appearance, until, at 350° or thereabouts, they either fall off or disappear, (4) that liquids other than water begin to distil over as a reddish-brown oil at 310°, but inasmuch as its appearance is unaccompanied by any marked evolution of gas the authors regard it as being "liquated" out of the coal conglomerate rather than as a decomposition product of the coal substance (*vide* Pictet, Ramseyer and Kaiser, p. 97), (5) that a critical decomposition point is reached at about 350°, which is marked by a rapid increase in the gas evolution and the appearance of much viscous oil, (6) that the gaseous hydrocarbons evolved up to 450° consist of methane, ethane, propane, butane, and even pentane, as well as of ethylene and higher olefines, and (7) that neither benzene nor its homologues could be detected in the condensable liquid products, and the authors regard their formation at such low temperatures as extremely doubtful.

The foregoing experiments, having established a temperature of *circa* 350° C. as the point at which the decomposition of the coal substance begins, led the authors in question to investigate in detail (1) the ratio of gas evolution, (2) the total volume of gas and its composition, and (3) the amounts of tar yielded by the following four representative British coals at various constant temperatures between 450° and 1000° C.

TABLE XXVII

Coal.	A.	B.	C.	D.
Character and Origin	Bituminous Altofts (S. Yorks) Silkstone	Anthracitic Pontyberen	Bituminous Abertilly S. Wales	Semi-bituminous Penrhycyber S. Wales
Per cent. Ash Content	5.51	3.9	7.65	3.5
Percentage Composition of the Dry Ashless Coal				
C .	80.50	92.66	85.72	90.72
H .	5.45	3.14	4.93	4.23
N .	1.42	0.99	1.09	2.99
S .	2.93	1.01	0.92	0.81
O .	9.70	2.20	7.34	1.25

An intimate mixture of 2 grams of the dried sample, pulverised so as to pass a sieve of 240 meshes to the linear inch, with 3 grams of fine white sand, which had been previously ignited, were heated in a small tubular platinum retort (21.5 c.m. long and 1.7 c.m.

COAL AND ITS SCIENTIFIC USES

internal diameter), the open end of which was silver-soldered into a gun-metal collar through which connection was made with (1) a weighed platinum "tar scrubber" packed with ignited asbestos, and (2) a graduated glass gas-holder (capacity = 2 litres), a mercurial pressure gauge being inserted in the system between (1) and (2). The retort was heated electrically in a platinum-wound resistance furnace (the temperature of which was measured by a platinum and platinum-rhodium thermojunction) for a period of

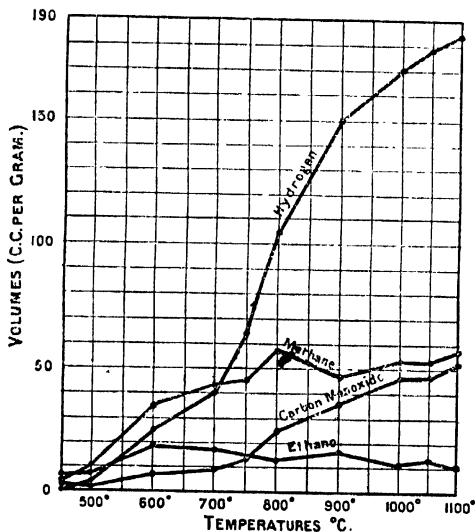

FIG. 8.—Gaseous Products of Distillation of Coal A at Different Temperatures.

time (2 hours) sufficient for the decomposition to be completed at the particular temperature selected. It was ascertained that the coal attained the temperature of the furnace within about 2 minutes after the commencement of each experiment.

As the main interest of the experiments centres on the volumes of each of the principal gaseous products obtained at the various experimental temperatures, it will be sufficient for our purpose to reproduce from the original paper the following curves (Figs. 8, 9, and 10) setting forth these data for the aforesaid coals A, B, and D.¹ The reader is referred to the memoir for other details.

¹ The author is indebted to Dr. R. V. Wheeler and the Council of the Chemical Society for their kind permission to reproduce these curves.

THE CHEMICAL COMPOSITION OF COAL

The principal facts established by this part of the investigation were (1) that with all coals, whether bituminous, semi-bituminous, or anthracitic, there is a well-defined temperature between 700° and 800°, which corresponds with a marked and rapid increase in the quantity of hydrogen evolved; (2) that with bituminous coals such increase in the quantity of hydrogen evolved falls off at temperatures above 900°, but with anthracitic coals it is maintained up to 1100°; (3) that the evolution of hydrocarbons

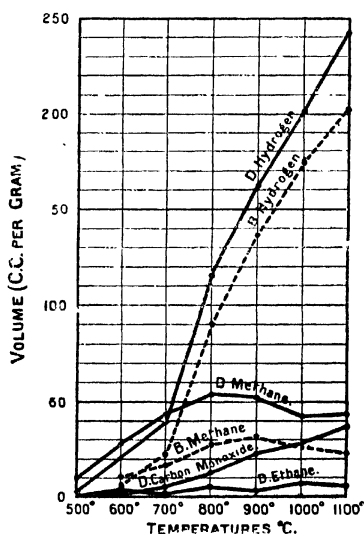

FIG. 9.—Gaseous Products of Distillation of Coals B and D at Different Temperatures.

of the paraffin series ceases almost entirely at temperatures above 700°; (4) that ethane, propane, butane, and probably higher members of the paraffin series form a large percentage of the gases evolved at temperatures below 450°; and (5) that the *rate* at which carbon monoxide is evolved is uniform throughout a distillation at any one temperature, and is maintained right up to the end, whilst the rates in the case of the other gases fall off, moreover, this CO-rate increases with the temperature.

From the above facts Burgess and Wheeler argued (1) that coal contains two types of compounds of different degrees of ease of decomposition; the one, the least stable, yielding the paraffin

COAL AND ITS SCIENTIFIC USES

hydrocarbons and no hydrogen; the other decomposing with greater difficulty and yielding hydrogen alone (or possibly hydrogen and the oxides of carbon) as its decomposition products; (2) that very probably the difference between one coal and another is determined mainly by the proportions in which these two types of compounds exist, anthracite, for example, containing but little of the more unstable constituents; (3) that the true "coal substance," apart from the traces of sulphur compounds that mask its

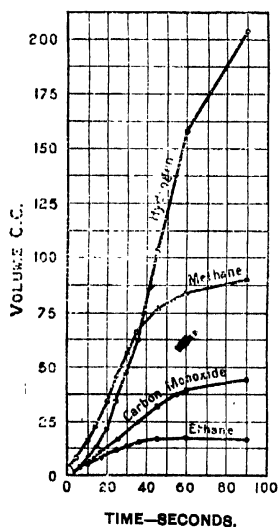

FIG. 10.—Distillation of Coal A *in vacuo* at 950° C.

character, is compounded of the two types which behave so differently under the action of heat; and (4) that the presence of carbon monoxide in the gases is most probably due to the elimination of water from hydroxy-compounds, and the subsequent reaction of the steam thus formed with the carbon. In a later paper, in conjunction with A. H. Clark and C. B. Platt, Wheeler explains that in using the terms "hydrogen-yielding" and "paraffin-yielding" constituents, he does not mean that hydrogen in the one case, or paraffin in the other, is the *sole*, but that it is only the *predominant* decomposition product in each case. He also expressed his belief that the "hydrogen-yielding" is the cellulosic, and the "paraffin-yielding" the resinic constituent of coal.

THE CHEMICAL COMPOSITION OF COAL

The main facts observed by Wheeler and his co-workers in this connection were confirmed by the independent work of Vignon on French coals.¹ This investigator distilled various samples of coal at successive temperatures of 400°, 600°, 850°, 1000°, and 1200°, showing (1) that unsaturated hydrocarbons almost all pass over below 600° and disappear entirely at higher temperatures; (2) that methane and other paraffins form from 60 to 80 per cent. of the whole gas up to 800°, after which they decrease rapidly with further rise in temperature; (3) that between 800° and 1000° hydrogen predominates, but in turn diminishes above 1000°; and (4) that very high temperatures promote the formation of carbon monoxide.

It would, therefore, appear that there is no room for any serious difference of opinion upon questions of fact in this connection, and that in particular Wheeler's principal discovery of a temperature somewhere between 700° and 800° at which the evolution of hydrogen rapidly increases has been substantially confirmed. When, however, it comes to the interpretation of the facts, agreement with his conclusions is by no means unanimous, and in particular two well-known American investigators (H. C. Porter and G. B. Taylor)² have expressed strong dissent from his view that the aforesaid rapid increase in the evolution of hydrogen between 700° and 800° really marks "a well-defined decomposition point" or a "critical period" at which, after the decomposition of a less stable "paraffin-yielding" resinic constituent has been practically completed, that of a more stable "hydrogen-yielding" cellulosic constituent begins. Indeed the fact that "water of constitution," as Wheeler himself states, begins to be copiously evolved from a bituminous coal at as low a temperature as 200°, and continues up to and beyond 450° suggests the early decomposition of "cellulosic" rather than that of "resinic" constituents.

Moreover, it has always appeared to the writer that, in interpreting his experiments, Wheeler has overlooked the probable behaviour of the nitrogenous constituents, which do indeed form as important a part of the coal substance as, say, the resinic constituents, and ought not therefore to be ignored. For if, as both Carrick Anderson and M. G. Christie (*loc. cit.*) have independently shown, the "ammonia-yielding" nitrogenous constituents of coal begin to decompose between 330° and 480°,

¹ *Compt. rend.*, 1912, 155, p. 1514.

² *Proc. Amer. Gas Institute*, 1914, IX, i., pp. 234-288.

COAL AND ITS SCIENTIFIC USES

and rapidly do so at from 500° to 700°, then it is certain that Burgess and Wheeler's results must have been materially influenced by this factor, as indeed the following figures from the amounts of ammonia in these gases prove:—

COAL A						
Temperature . . .	450°	500°	600°	700°	800°	900°
Total Gases in c.c.s.						
per gram. Coal . .	12.0	29.9	99.0	124.0	218.0	268.0
Percentage NH ₃ . .	4.7	1.35	1.40	1.60	1.00	1.0

COAL C					
Temperature . . .	500°	600°	700°	800°	900°
Total Gases in c.c.s.					
per gram Coal . . .	33.5	83.0	135.0	208.0	254.0
Percentage NH ₃ . .	2.00	0.70	1.10	0.85	<i>nil</i>

The American investigators referred to (*q. v.*) have suggested that the marked increase in the production of hydrogen at 750° or thereabouts, in Burgess and Wheeler's experiments, may have been due to the secondary decomposition of volatile matters (tar and gases), and unquestionably the employment by Burgess and Wheeler of a tubular *platinum* retort for heating the coal in the particular series of experiments referred to would greatly influence all secondary changes of a catalytic character, and it therefore affords their critics a valid ground of objection. Also Vignon's experiments, in which an *iron* tube was used, though less open to question, are not entirely immune from such criticism.

In this connection it should be remembered that, according to the researches of Bone and Coward, whilst methane is a very stable hydrocarbon at 800°, and is only slowly resolved into its elements between that temperature and 1200°, both ethane and ethylene decompose fairly rapidly at 700° and are most unstable at all temperatures above 800°. Also, that methane is always a prominent decomposition product of the other two, being formed by the "hydrogenation" of unsaturated residues such as :CH₂ and :CH, which are undoubtedly produced momentarily and play an important rôle in hydrocarbon decomposition at high temperatures. Hydrogen would certainly be produced at 700° to 800° by the secondary decomposition of the vapours of low temperature tars, but some of it would probably also disappear at that temperature on account of the "hydrogenations" referred to. And whilst it is difficult to arrive at any precise or final conclusion

THE CHEMICAL COMPOSITION OF COAL

in weighing up the *pros* and *cons* of the case, the writer is on the whole inclined to think that, whereas Burgess and Wheeler's experiments would probably not be affected materially by the secondary decomposition of methane until well above 800°, those between 600° and 900° were to some extent influenced by other secondary hydrocarbon decompositions and interactions, but probably not sufficiently to throw doubt upon their principal conclusion that there exists a temperature point between 700° and 800° at which some "hydrogen-yielding" constituent (or perhaps, to put it better, "complex") in the coal substance begins to decompose rapidly.

In conjunction with D. T. Jones, Wheeler has recently studied the condensable tars formed by the distillation of coals¹ under pressures of from 5 to 40 m.m. at temperatures up to 430° C. Two bituminous coals were selected, one from Scotland and the other from Co. Durham, of the following composition:—

	Proximate Analyses of Dry Coal.		Ultimate Analyses of the Dry Ashless Coal.				
	Volatiles.	Ash.	C.	H.	N.	S.	O.
Scottish Coal	26·36.	3·28	86·92	4·98	1·75	0·79	5·56 per cent.
Durham Coal	30·81.	4·10	86·88	5·41	1·75	1·25	4·71 „ „

The tars obtained, amounting to about 6·5 per cent. of the weight of the coal, yielded on distillation up to 300° (1) about half its weight of soft pitch, sp. gr. 1·128 $\frac{15}{8}$ °, entirely soluble in chloroform and free from carbon, and (2) a mixture of oils, boiling below 300°, of the following composition:—

- (a) Between 40 and 45 per cent. of "ethylenic" unsaturated hydrocarbons, for the most part richer in carbon than the mono-olefines.
- (b) About 40 per cent. of naphthenes (C_nH_{2n}), and liquid paraffins (C_nH_{2n+2}), the former greatly predominating.
- (c) Between 12 and 15 per cent. of phenolic bodies, chiefly cresols and xylenols.
- (d) About 7 per cent. of aromatic compounds, chiefly homologues of naphthalene (? *dimethylnaphthalene*) but not naphthalene itself. Benzene, anthracene, and solid aromatic hydrocarbons were absent, nor was there any evidence of the presence of toluene nor homologues of benzene in more than minute quantities.
- (e) Traces of pyridine bases.

¹ *Journ. Chem. Soc.*, 1914, **105**, 141, 2562; 1915, **107**, 1318; 1916, **109**, 708.

COAL AND ITS SCIENTIFIC USES

In a later series of experiments Jones and Wheeler studied separately the behaviour on distillation of the three fractions into which the coal substance may be divided by successive extraction by means of pyridine and chloroform, namely (a) the portion insoluble in pyridine ("cellulosic"), (b) that soluble in pyridine but insoluble in chloroform, (c) that soluble in both pyridine and chloroform ("resinic"). The coal selected for this purpose was the Durham coal used in the previous series of experiments (*q. v.*), and the results of the further treatment of it were briefly as follows:—

- (i) 150 grams of *Fraction (a)* yielded, at temperatures between 390° and 450° *in vacuo*, chiefly phenolic products, and an oil containing C = 86.04 and H = 11.35 (*i. e.* C + H = 97.39) per cent. The contents of the flask showed no tendency to cake during the distillation (*i. e.* up to 450°), and the residual non-volatile material remaining in the flask after the experiment was a fine powder.
- (ii) 150 grams of *Fraction (b)* similarly yielded oils, of which 40 per cent. were phenolic and the remainder "of a resinous nature." The non-volatile residue was of the same powdery character as in (i).
- (iii) 65 grams of *Fraction (c)* softened at 90°, and melted at 102°. Gases began to be evolved at 170°. On continuing the distillation up to 400°, considerable quantities of paraffin wax distilled over at 250°, and large volumes of gases were evolved at 320°. The condensable products consisted of a viscous resin-like substance, which on re-distillation yielded an oil containing olefinic hydrocarbons, and an oil, boiling between 180° and 250° at atmospheric pressure, containing C = 87.31, H = 10.00 (C + H = 97.31) per cent. No phenols were produced, and the 23 grams of residue left in the distillation flask were a hard compact pitch, containing C = 87.96, H = 5.67 (C + H = 93.63) per cent. completely soluble in pyridine.

The most important points which Jones and Wheeler claim to have established with regard to such low temperature tars are:—
(1) the absence of benzene and its homologues, but the presence of homologues of naphthalene in them; the latter point, if confirmed, would be of considerable interest as bearing on the

THE CHEMICAL COMPOSITION OF COAL

chemical structure of coal; (2) the predominance in them of "ethylenic" unsaturated hydrocarbons and naphthenes; (3) the formation of phenolic bodies exclusively for what are presumably the "cellulosic" constituents of the coal; and (4) the striking contrast between the compact pitchy residue yielded by the supposed "resinic" constituent and the non-coherent powder left behind by the other constituent, which again clearly demonstrates the predominant influence of the resinic bodies in determining the coking power of coal.

Before passing on to the description of the work of other investigators it will be convenient if we now record the latest views of Jones and Wheeler, as summarised at the end of their third paper on the Constitution of Coal¹ in the following paragraphs:—

- (1) Coal is considered to have been formed from decayed vegetable matter by the action of pressure and temperature. The temperature cannot have approached 300°.
- (2) The coal conglomerate can be resolved by means of solvents into cellulosic and resinic portions.
- (3) The cellulosic derivatives contain compounds, the molecules of which possess the furan structure, and yield phenols when destructively distilled. There are also compounds present, the molecules of which have structures resembling that of the carbon molecule, but it is unlikely that "free carbon" is present in coal. The cellulosic derivatives are probably few in type.
- (4) The resinic derivatives contain compounds in which alkyl, naphthene and unsaturated hydroaromatic radicals are attached to larger and more complex groupings. It is doubtful whether aromatic groupings are present. Under the influence of pressure the bulk of the resinic derivatives have become highly polymerised. The oxygenated resinic derivatives are chiefly oxides, probably cyclic oxides; esters, lactones, anhydrides, acids, and ketones are absent or present only in small quantity.
- (5) Hydrocarbons are present in the resinic portions of coal; saturated hydrocarbons (paraffin) are, however, present in small quantity only.
- (6) The main distinction between low temperature distillates

¹ *Journ. Chem. Soc.*, 1916, 100, 707.

COAL AND ITS SCIENTIFIC USES

from coal and petroleum is the absence of phenols in the latter. This is held to be corroborative evidence of the non-cellulosic origin of petroleum.

The foregoing statements, embodying as they do the considered opinions of two chemists whose researches have enriched our knowledge by many new and important facts, must necessarily command attention if they do not altogether compel assent. There will be no difficulty in accepting conclusions (1), (2), and (3), although with regard to (2), as well as to the conception of the constitution of the coal substance, embodied in the paragraphs as a whole, most chemists will view with surprise the omission of any reference whatsoever to the presence of nitrogenous constituents. Paragraphs (3) and (4), however, bristle with controversial points, and suggest ideas which do not seem to have been as yet sufficiently substantiated. Also there is some inconsistency between Jones and Wheeler's conclusion that the phenolic products, present to an extent of 12 to 15 per cent. in the tars obtained by them on distilling coals up to 430° in a vacuum, are derived from the cellulosic constituents of coal [paragraphs (3) and (4)] and the equally definite previous assertions by Burgess and Wheeler that these "hydrogen-yielding" cellulosic constituents only decompose freely above a critical temperature defined as being between 750° and 800°. Indeed, as will be seen later, strong exception has been taken to Wheeler's interpretation as a whole of the thermal decomposition of coal by two American investigators, H. C. Porter and G. B. Taylor (*q. v.*).

We must next consider, as supplementing the work of Jones and Wheeler, the exhaustive investigations by Pictet and Bouvier upon the composition of the 60 kilos of "vacuum tar" obtained by them on distilling 1½ tons of Montrambert coal at 450° under a pressure of 15 to 20 m.m.¹ They stated that the tar contained neither phenols (*vide*, however, Jones and Wheeler, and a later statement by Pictet, Kaiser and Labouchère) nor aromatic hydrocarbons, but yielded both on decomposition at red heat. The presence of alcohols and unsaturated hydrocarbons was proved, but not in sufficient quantity to admit of identification. After freeing the crude tar from such alcohols by treatment with sodium, and from unsaturated hydrocarbons by shaking it up with anhydrous liquid sulphur dioxide, which

¹ *Compt. rend.*, 1913, 157, p. 1436; 1915, 160, p. 629, and *Ber.*, 1915, 48, p. 926.

THE CHEMICAL COMPOSITION OF COAL

dissolves and removes them, the residual "saturated" hydrocarbons were resolved by fractional distillation at atmospheric pressure into the following constituents, all of which were of the naphthene (C_nH_{2n}) type of hydrocarbons:—

Formula.	B.P. at 730 m.m.	Density.	N_D .
C_9H_{18}	135–137°	0.7590 ^{20°}	1.4212 ^{20°}
$C_{10}H_{20}$	160–161°	0.7680 ^{20°}	1.4272 ^{20°}
$C_{10}H_{20}$	172–174°	0.7765 ^{22°}	1.4196 ^{22°}
$C_{11}H_{22}$	189–191°	0.7838 ^{22°}	1.4234 ^{22°}
$C_{12}H_{24}$	211–213°	0.7862 ^{21°}	1.4293 ^{21°}
$C_{13}H_{26}$	227–229°	0.7953 ^{20°}	1.4379 ^{20°}

The authors in question pointed out that the physical constants of their hydrocarbons are nearly the same as those previously found by Mabery from the saturated hydrocarbons of similar constitution isolated from Galician and Californian petroleum. They identified the hydrocarbon C_9H_{18} as 1:3:5 trimethylcyclohexane (hexahydromesitylene), since with nitric acid it yielded dinitromesitylene.

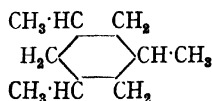

On continuing the distillation of the oil under 15 m.m. pressure, they obtained a fraction which solidified into colourless needles melting at 62–63°, and having a density of 0.9128 at 25°. It had a formula $C_{30}H_{60}$ and seemed to be identical with the melene obtained in 1849 by Brodie from the products of the dry distillation of beeswax.

With regard to the composition of the 2 per cent. of hydroxy-compounds contained in this "vacuum tar," Pictet in conjunction with Kaiser and Labouchère subsequently proved the presence of hexahydro-*p*-cresol, $C_7H_{14}O$ (b.p. 170–175° C.), as well as a series of homologous phenolic bodies, including $C_8H_{16}O$ (b.p. 185–190°), $C_9H_{18}O$ (b.p. 198–200°), $C_{10}H_{20}O$ (b.p. 213–215°), and $C_{11}H_{22}O$ (b.p. 226–228°), which they believe probably occur as such in coal, because similar substances have been extracted from coal by benzene. The tar also contained 0.2 per cent. of bases, among which were a primary aromatic amine C_7H_9N (possibly a mixture of toluidines), and a number of secondary

COAL AND ITS SCIENTIFIC USES

bases C_8H_7N (b.p. 225°), C_9H_9N (b.p. $247-250^\circ$), $C_{10}H_{11}N$ (b.p. $250-260^\circ$), $C_{11}H_{13}N$ (b.p. $260-265^\circ$), and $C_{12}H_{15}N$ (b.p. $270-280^\circ$), which had the odour of quinolines and yielded picrates only slightly soluble in alcohol.¹

D. T. Jones has recently advanced the practical study of the thermal decomposition of such cyclic saturated hydrocarbons by heating *cyclohexane* (C_6H_{12}), *methylcyclohexane* (C_7H_{14}), and di- and tetra-hydronaphthalenes ($C_{10}H_{10}$ and $C_{10}H_{12}$) in contact with porous porcelain, the temperature of which was slowly raised until the decomposition point was attained in each case.² This in the case of the two first-named hydrocarbons was between 490° and 510° , and for dihydronaphthalene it was at 390° . The principal facts established were:—

Cyclohexane at 500° yielded benzene, which formed 20 per cent. of the liquid products, and a gas containing:— C_6H_6 and Olefines = 26.1 , $C_2H_2 = 0.2$, $C_2H_4 = 8.5$, $C_2H_6 = 21.9$, $CH_4 = 3.0$, and $H_2 = 40.3$ per cent.

Methylcyclohexane at 530° yielded liquids and a gas containing:— C_6H_6 and Olefines = 12.8 , $C_2H_2 =$ trace, $C_2H_4 = 10.6$, $C_2H_6 = 12.0$, $CH_4 = 22.5$, and $H_2 = 42.1$ per cent.

1:4 *Dihydronaphthalene* at 420° yielded naphthalene, and a gas containing:— $CH_4 = 14.6$, and $H_2 = 85.4$ per cent.

1:2:3:4 *Tetrahydronaphthalene* at 530° yielded naphthalene, and a gas containing:— C_6H_6 and Olefines = 3.3 , $C_2H_4 = 3.5$, $C_2H_6 = 4.0$, $CH_4 = 9.0$, and $H_2 = 80.2$ per cent.

In a later paper³ Jones has detailed the results of his investigation of the thermal decomposition of the low temperature tars previously obtained from coals by Wheeler and himself (*loc. cit.*). The method adopted was to decompose small quantities of the tar at successive temperature increments of 50° beginning at 550° C. (the lowest temperature at which the decomposition became rapid enough for convenient study) by distilling a small quantity of the vapour over heated porous porcelain in a stream of carbon dioxide, which was used to sweep the vapour and gaseous products forward. The following tabulated compositions of the gaseous products obtained at the various temperatures are of considerable interest, especially in connection with Burgess and Wheeler's results and conclusions, the rapid increase in the production of hydrogen between 750°

¹ *Compt. rend.*, 1917, **165**, p. 113.

² *Journ. Chem. Soc.*, 1915, **107**, p. 1582.

³ *Journ. Soc. Chem. Ind.*, 1917, p. 3.

THE CHEMICAL COMPOSITION OF COAL

and 800° (Burgess and Wheeler's critical temperature) being most significant.

TABLE XXVIII

Temp. ° C.	Higher Olefines.	C ₂ H ₂ .	C ₂ H ₄ .	C ₂ H ₆ .	CH ₄ .	H ₂ .
550°	21·7	0·7	10·4	18·2	19·6	29·4
600°	12·5	1·3	7·4	11·3	33·9	33·6
650°	11·4	0·9	9·3	12·0	39·0	27·4
700°	8·2	1·3	16·1	2·4	43·8	28·2
750°	0·7	1·2	7·6	1·2	56·1	33·2
800°	1·0	1·3	4·0	—	33·0	60·7

Jones, after discussing this formation of hydrogen (and especially at 750° to 800°) from the tars, summed up his results and conclusions as follows:—(1) that ordinary coal tar is formed from coal at high temperatures chiefly as the result of the decomposition of a tar previously formed at low temperatures; (2) that the mechanism of the process consists essentially in the decomposition of the naphthenes, paraffins, and unsaturated hydrocarbons present in the low temperature tar to form olefines of varying carbon content which condense at higher temperatures to aromatic substances; (3) that the higher (gaseous) olefines are at a maximum at 550° C. . . . their disappearance at 750° C. synchronises with the appearance of naphthalene, and immediately precedes a rapid increase in the evolution of hydrogen; (4) that hydrogen is formed at middle temperatures as the result of the decomposition of naphthenes; the increase at higher temperatures must probably be attributed to the union of aromatic molecules and to intra-molecular ring closing; (5) that phenols are primary products of coal distillation (*cf.*, however, Pictet and Bouvier *loc. cit.*); (6) that benzene and its homologues are chiefly formed as the result of olefine condensation. To some extent they are secondary products of coal distillation, having been formed by the thermal dehydrogenation of the corresponding naphthenes; and (7) that acetylene plays an insignificant part in coal tar formation.

A valuable study of the thermal changes which accompany the carbonisation of coals and allied substances as the temperature in the heated zone is raised has recently been carried out by Hollings and Cobb at the University of Leeds.¹ Their experi-

¹ *Journ. Chem. Soc.*, 1915, 107, p. 1106.

COAL AND ITS SCIENTIFIC USES

mental method consisted in heating side by side, under the same conditions, a coal which underwent carbonisation and a coke which could be regarded as chemically and thermally inert, and noting, by means of a differential arrangement of thermocouples devised by the late Roberts-Austen for the examination of metallic alloys, the extent to which the temperature of the coal differed (+ or -) from that of the coke in various stages of the carbonisation.

The materials examined included the following :—

TABLE XXIX

	Percentage.		Ash-free Substance				
	Vola- tiles. ¹	Ash.	C.	H.	N.	S.	O.
Anthracite (S. Wales)	5.97	2.12	89.20	4.31	1.25	1.34	3.91
Bituminous Coal	37.30	3.77	80.39	5.88	1.39	1.71	10.63
Cannel	45.27	4.80	80.79	5.46	1.94	1.21	10.60
Lignite	65.00	5.20	63.00	6.26	0.50	1.66	28.58
Dehydrated Cellulose	65.20	1.13	58.11	4.11	—	1.10	36.68
Cotton Wool	—	—	44.4	6.2	—	—	49.4

Cellulose (but not dehydrated cellulose, lignite nor coals) showed a strong exothermic reaction between 300° and 400° C. which the authors in question suppose was connected with the expulsion of hydroxyl groups at 345° and the consequent condensation of the residue. In the case of dehydrated cellulose and lignite this evolution of heat was spread over a wide range (280° to 420°), and in the case of coals no signs of exothermic reactions were observed below 400°. Between 400° and 600° the thermal phenomena varied a good deal with the nature of the coal, but all coals displayed marked exothermicity in passing through the interval 600° to 800°, during which methane also was freely evolved. Above 800°, when hydrogen became the chief gaseous product, the carbonisation process appears to be either thermally neutral or slightly endothermic. In general, at low temperatures the thermal phenomena were most marked with cellulose and coals of a high oxygen content, whilst at high temperatures they were most marked with anthracite and coals of low oxygen content.

A study of the curves published in the paper leaves the impression that they do not admit of more than a very general

¹ As determined in platinum crucible by the American Method (*q. v.*).

THE CHEMICAL COMPOSITION OF COAL

interpretation, and that a more thorough exploration of the subject is needed before any definite conclusion regarding the differences between the thermal behaviour of various coals can be drawn from the observations made by such a method. This remark applies especially to the range of 400° to 600°, where most of the primary "low temperature" changes in the coal substance presumably occur other than the elimination of water, which Wheeler and others have shown to commence at 200° and to continue beyond 450°. The fact that Hollings and Cobb's curves do not, except in the case of cellulose itself, bring out this feature very strongly shows at once the extreme complexity of the problem and the limitations of such a method as they employed, which of course only indicates the direction (+ or -) in which the balance of the heat changes is moving at any particular range of temperature.

In this connection it may be noted that Rau and Lambris, who investigated the mode of formation of water in the destructive distillation of various fuels, found that the amount actually recovered by condensation was greater by as much as 50 to 100 per cent. with slow than with rapid heating. Thus, with a high-grade gas coal the water condensed varied from 4.8 up to 7.3 per cent. according as the temperature of coal was raised to 1000° in a few minutes or in 36 hours. As a rule, the lower the oxygen content of a coal, not only the less is the water produced from it, but also the higher the temperature at which it is produced. With cellulose the principal water formation was found to occur between 240° and 350° C., which agrees fairly well with Hollings and Cobb's observations that there is a decomposition point at 345° at which the heat evolution was "very sudden" as though it was due "to chemical action at a definite temperature." With bituminous coals the principal water formation occurred between 400° and 650° C., which, it may be remarked, is well below Burgess and Wheeler's supposed critical temperature of 750°. It is therefore certain that water is a primary decomposition product of the coal substance, and that its principal formation occurs below 600°, if not below 500°. Moreover, the amount of it produced below 600° is so large in proportion to the oxygen content of the coal that it seems difficult to ascribe it to the decomposition of any other than the principal oxygen constituents of the coal, namely, the cellulosic constituents, a conclusion which again seems to be inconsistent with Wheeler's arguments respecting the thermal decomposition of coal.

COAL AND ITS SCIENTIFIC USES

It may here be observed that hitherto too little attention has been paid by chemists to the variations in the relative proportions of oxygen appearing as water on the one hand, and as oxides of carbon on the other, among the products of the low temperature distillation of different coals. Experiments recently made in the writer's laboratory have shown that these relative proportions may vary considerably, even in the case of coals having almost the same oxygen content. Thus, for example, in a series of experiments in which 15 grams of two different (dried) coals, one a Barnsley Hard Coal, and the other a Durham Coking Coal, but with nearly the same oxygen contents, were separately distilled at 550°, the relative proportions of the oxygen eliminated as water and as oxides of carbon differed very considerably, as the following figures show:—

TABLE XXX

Coal.	Barnsley Hard Steam Coal (Maltby Colliery).	Durham Coking Coal (Langley Park Colliery).
Percentage Composition of the Dry Coal Substance		
C.	84.67	85.02
H.	5.13	4.83
N.	1.54	1.11
S.	0.72	1.30
O.	7.94	7.74
Grams expelled at 550° C.		
CO ₂	0.0297	0.0198
CO	0.0900	0.0498
H ₂ O	0.52	0.17
Weight Ratio		
O as H ₂ O O as CO and CO ₂	6.3	3.5

These experiments, which are regarded as merely preliminary ones, are being extended with a view to a complete exploration of the subject as a possible basis of discrimination between different types and classes of coal.

In 1914, H. C. Porter and G. B. Taylor of Pittsburg published an important memoir embodying the results of their investigations upon the mode of decomposition of certain American coals at temperatures up to 450°, which had led them to conclusions very different from those of Burgess and Wheeler, whose interpretations they freely criticised.¹

¹ *Proc. Amer. Gas. Institute*, 1914, IX. I, pp. 234 to 288.

THE CHEMICAL COMPOSITION OF COAL

interpretation, and that a more thorough exploration of the subject is needed before any definite conclusion regarding the differences between the thermal behaviour of various coals can be drawn from the observations made by such a method. This remark applies especially to the range of 400° to 600°, where most of the primary "low temperature" changes in the coal substance presumably occur other than the elimination of water, which Wheeler and others have shown to commence at 200° and to continue beyond 450°. The fact that Hollings and Cobb's curves do not, except in the case of cellulose itself, bring out this feature very strongly shows at once the extreme complexity of the problem and the limitations of such a method as they employed, which of course only indicates the direction (+ or -) in which the balance of the heat changes is moving at any particular range of temperature.

In this connection it may be noted that Rau and Lambris, who investigated the mode of formation of water in the destructive distillation of various fuels, found that the amount actually recovered by condensation was greater by as much as 50 to 100 per cent. with slow than with rapid heating. Thus, with a high-grade gas coal the water condensed varied from 4.8 up to 7.3 per cent. according as the temperature of coal was raised to 1000° in a few minutes or in 36 hours. As a rule, the lower the oxygen content of a coal, not only the less is the water produced from it, but also the higher the temperature at which it is produced. With cellulose the principal water formation was found to occur between 240° and 350° C., which agrees fairly well with Hollings and Cobb's observations that there is a decomposition point at 345° at which the heat evolution was "very sudden" as though it was due "to chemical action at a definite temperature." With bituminous coals the principal water formation occurred between 400° and 650° C., which, it may be remarked, is well below Burgess and Wheeler's supposed critical temperature of 750°. It is therefore certain that water is a primary decomposition product of the coal substance, and that its principal formation occurs below 600°, if not below 500°. Moreover, the amount of it produced below 600° is so large in proportion to the oxygen content of the coal that it seems difficult to ascribe it to the decomposition of any other than the principal oxygen constituents of the coal, namely, the cellulosic constituents, a conclusion which again seems to be inconsistent with Wheeler's arguments respecting the thermal decomposition of coal.

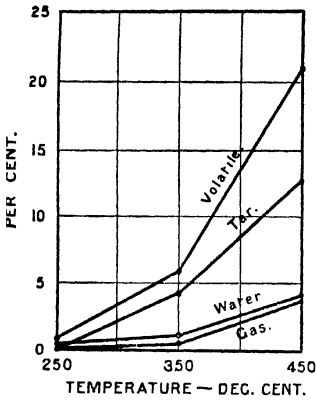

FIG. 11.—Percentage yields of tar, water, gas, and total volatile by heating Pittsburgh coal *in vacuo* at low temperatures.

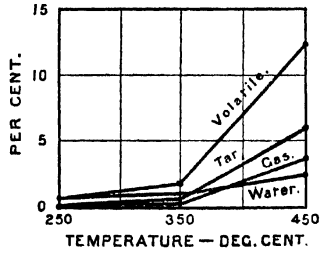

FIG. 12.—Percentage yields of tar, water, gas, and total volatile by heating New River (West Virginia) coal *in vacuo* at low temperatures.

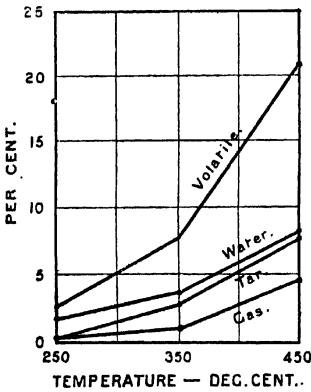

FIG. 13.—Percentage yields of tar, water, gas, and total volatile by heating Franklin Co. (Illinois) coal *in vacuo* at low temperatures.

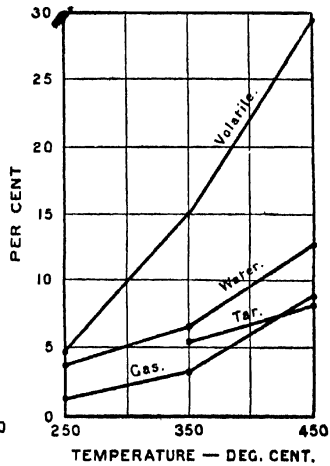

FIG. 14.—Percentage yields of tar, water, gas, and total volatile by heating Wyoming sub-bituminous coal *in vacuo* at low temperatures.

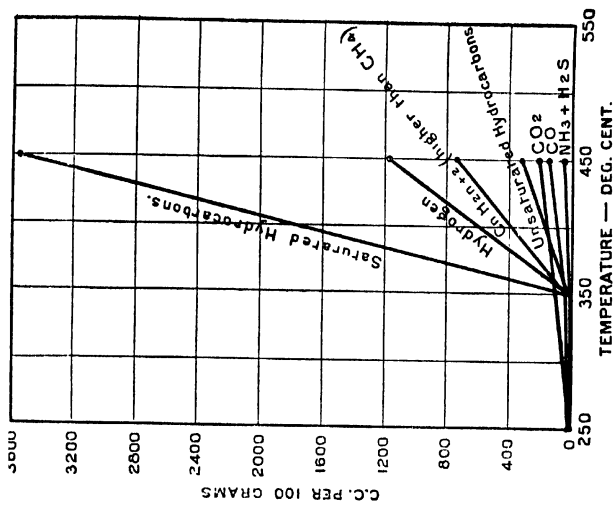

FIG. 16.—Quantities of various gases obtained from New River (West Virginia) coal *in vacuo* at low temperatures.

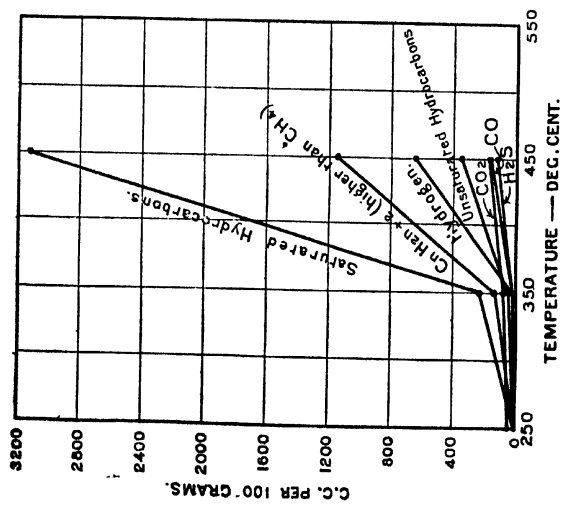

FIG. 15.—Quantities of various gases obtained from Pittsburgh coal *in vacuo* at low temperatures.

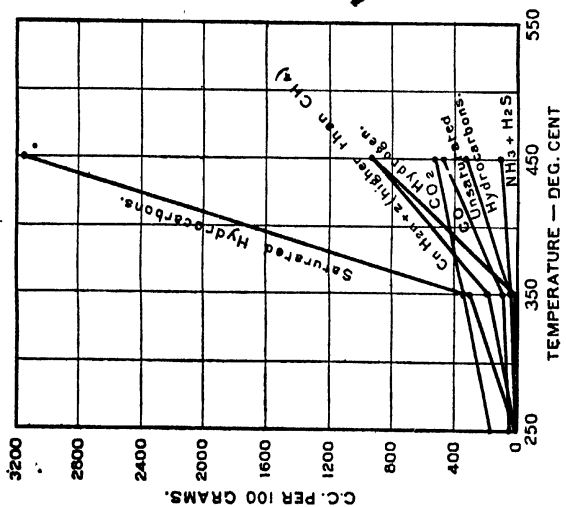

Fig. 17.—Quantities of various gases obtained from Franklin Co. (Illinois) coal *in vacuo* at low temperatures.

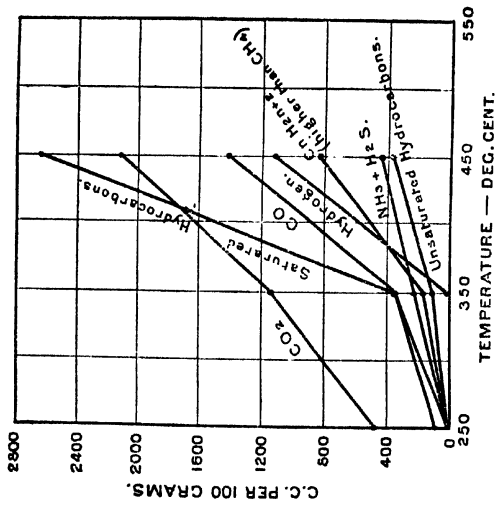

Fig. 18.—Quantities of various gases obtained from Wyoming sub-bituminous coal *in vacuo* at low temperatures.

THE CHEMICAL COMPOSITION OF COAL

TABLE XXXII

ILLUSTRATING RESULTS OF PORTER AND TAYLOR'S EXPERIMENTS AT 450°

Coal.	New River.	Pittsburg.	Illinois.	Wyoming.	
Duration of Heating—Hours	9·0	8·5	9·5	10·0	
Percentages by Weight produced by Decomposition	Water ¹	2·3	4·30	8·29	12·64
	Tars	6·08	12·76	7·73	8·17
	Gas	3·80	4·01	4·80	8·66
Total Volatile	12·18	21·07	20·82	29·47	
Gases produced in c.c.s. per 100 grams Coal	H ₂ S and NH ₃	48·0	138·0	104·0	432·0
	CO ₂	223·0	174·0	533·0	2128·0
	CO	130·0	187·0	483·0	1426·0
	C _n H _{2n}	334·0	352·0	320·0	394·0
	C _n H _{2n+2}	3551·0	3100·0	3158·0	2647·0
H ₂	1168·0	653·0	935·0	1129·0	
Total Gas	5498	4694	5621	8194	
Average Value of <i>n</i> in C _n H _{2n+2}	1·21	1·37	1·30	1·31	
Approximate ² Weight Ratio	O as H ₂ O		O as CO + CO ₂		
	5·0	10·0	6·9	2·8	

From the large proportions of total volatile matter expelled at 450° (*i. e.* from 55 to about 70 per cent.) it is evident that a very considerable amount of decomposition of the coal substance had taken place up to that point. Indeed, if the volumes of the oxides of carbon evolved be taken as at N.T.P., we get the following figures for the proportions of the oxygen in the original coal which had been eliminated as steam and oxides of carbon:—

		New River.	Pittsburg.	Illinois.	Wyoming.	
Per 100 Coal heated	{	Total Oxygen	3·4	5·03	9·67	14·81
		O evolved as H ₂ O	2·04	3·80	7·37	11·24
		O evolved as CO ₂ & CO	0·41	0·38	1·07	4·06
		Proportion so evolved	<u>0·72</u>	<u>0·81</u>	<u>0·87</u>	<u>1·03</u>

¹ This is the water actually produced by decomposition of the coals, and does not include the moisture in the "air-dried" sample heated.

² In calculating these ratios, the volume of CO and CO₂ given in the memoir has been taken as at N.T.P.

COAL AND ITS SCIENTIFIC USES

It is clear, therefore, that from 70 per cent. up to the whole of the oxygen containing constituents of the coal had undergone decomposition in the experiments, a fact which seems difficult to reconcile with Burgess and Wheeler's views. The large proportions of olefines and paraffins in the total gases evolved from the three bituminous coals is remarkable, as also is the fact that the ratio of the hydrocarbon to the hydrogen in these cases was at the least 3.3, and at the most as high even as 5.3, which observations substantially agree with those of Burgess and Wheeler.

The American investigators remark, in reference to Wheeler's views, that "coal does not seem to contain a substance which remains unaltered or nearly so below 750° C. and rapidly produces hydrogen above that temperature. It seems rather to contain a substance—in fact gas coal is probably largely made up of substances—which yielded the complex paraffin hydrocarbon at low temperatures and a large amount of hydrogen at high temperatures from the decomposition residue. There is no well-marked 'critical' point in the decomposition of coal. There is, however, a well-marked critical point between 1300° and 1450° F. (704° and 788° C.) in the secondary decomposition of the volatile matter—tar and gases."

The principal results of their own experiments may be summarised as follows:—

- (1) More than two-thirds of the organic substance of coal is decomposable below 500° C., but there is a variation among different kinds of coal in their ease of decomposition. In the case of American coals, those of the Appalachian field, because of their greater maturity, are less easily and rapidly broken down than the younger coals of the Middle Western and Western fields.
- (2) The first decomposition occurring in any type of coal as the temperature is raised is the breaking down of certain oxygen-bearing substances related to cellulose, from which chiefly water of decomposition, CO₂ and CO are produced.
- (3) Other decompositions, producing paraffin hydrocarbons both liquid and gaseous, begin at an early stage. Whether or not such decompositions become the predominating type below 500° depends on the character of the coal, and, as a general rule, the higher the oxygen

THE CHEMICAL COMPOSITION OF COAL

in the coal, the less will be the proportion of hydrocarbons and tar in the volatile matter. In the case of a sub-bituminous coal the "water-CO₂" yielding reaction predominates up to 450°.

- (4) Secondary decompositions of the primary volatile products occur quickly and easily at temperatures of 1350° F. (= 732° C.) and above. The liquid hydrocarbons in the tar undergo such decomposition more easily than the gaseous products and yield below 1350° F. methane, hydrogen, ethylene, hydrocarbons, and carbon.

At the conclusion of their memoir Porter and Taylor advanced the following hypothesis for the constitution of coal, which differs fundamentally from that of Burgess and Wheeler in supposing that the cellulosic derivatives decompose more easily than the resinic constituents; like Burgess and Wheeler, however, they have ignored the nitrogenous constituents of the coal substance.

"All kinds of coal consist of cellulosic degradation products more or less altered by the processes of ageing, together with derivatives of resinous substances, vegetable waxes, etc., in different proportions, more or less altered. They all undergo decomposition by a moderate degree of heat, some, however, decomposing more rapidly than others at the lower temperature. The less altered cellulosic derivatives decompose more easily than the more altered derivatives and also more easily than the resinous derivatives. The cellulosic derivatives decompose so as to yield H₂O, CO₂, CO, and hydrocarbons, giving less of the first three products the more matured and altered they are. The resinous derivatives, on the other hand, decompose on moderate heating so as to yield principally the paraffin hydrocarbons, with probably hydrogen as a direct decomposition product. The more mature bituminous coals, having good coking properties, contain a large percentage of resinous derivatives, and their cellulosic constituents have been highly altered. The younger bituminous or sub-bituminous coals are constituted of cellulosic derivatives much less altered than those in the older coals. They undergo a large amount of decomposition below their fusion point and possibly for that reason many of them do not coke."

They also predict from their experiments that the products of low temperature carbonisation on an industrial scale of a coal of the Pittsburg type at from 427° to 482° C. (800° to 900° F.)

COAL AND ITS SCIENTIFIC USES

will consist of a rich gas amounting to 0.6 to 0.7 cub. ft. per lb. of coal, and a larger yield of oil or tar, comprising 10 to 12 per cent. of the coal; also, that this tar will, they say, consist chiefly of paraffin hydrocarbons (? what of naphthenes, *cf.* Jones and Wheeler, and also Pictet and Bouvier), and will be almost, or possibly entirely, devoid of benzene and naphthalene derivatives or of free carbon. That the gas will contain 6 to 7 per cent. of unsaturated hydrocarbons and 20 to 25 per cent. of ethane and its higher homologues, and will consequently have a high calorific and illuminating value.

From experiments carried out in the writer's laboratory upon typical British coals at the somewhat higher temperature of 550° C. it seems probable that they will yield from 5 to 8 per cent. of their weight of water, from 8 to 10 per cent. of oils, and some 3000 cub. ft. per ton of crude gas containing:— $H_2S = 0.5$ to 2.0 , $CO_2 = 2.0$ to 5.0 , $CO = 4.0$ to 18.0 , $C_nH_{2n} = 3.5$ to 5.0 , $C_nH_{2n+2} = 55.0$ to 75.0 , and $H_2 = 5.0$ to 15.0 per cent.

Summing up now the present state of our knowledge with regard to the primary action of heat upon coal, it would appear:—

- (1) That whilst the view originally advanced by Wheeler and his co-workers in respect of the relative stabilities of the cellulosic and resinic compounds requires to be modified in the light of later investigations, we nevertheless owe to them the discovery of a series of important facts which none of their critics have seriously impugned and which have been substantially confirmed by other workers. The primary decomposition of the coal substance, as they themselves proved, begins at 200° C. (or thereabouts) with an elimination of water and oxides of carbon, and continues up to and probably beyond 450°. At 350°, or thereabouts, a point is reached at which the evolution of gases (principally hydrocarbons of the C_nH_{2n+2} and C_nH_{2n} series) becomes pronounced. Hydrogen forms a small proportion of the gases evolved until the temperature rises to between 700° and 800° C. (Wheeler's "critical" temperature), when it suddenly increases in volume and becomes the predominant gaseous product.
- (2) That it is still undecided whether the large increase in the evolution of hydrogen which undoubtedly occurs between

THE CHEMICAL COMPOSITION OF COAL

700° and 800° can be wholly attributed to the secondary decomposition of tar vapours and gaseous hydrocarbons. In part it certainly can be, from the known behaviour of these bodies, but it is still possible that it may in part arise also by the decomposition of a condensed "cellulosic" complex from which hydroxyl groups have been previously eliminated at lower temperatures. Further investigation will be needed before this point can be finally cleared up.

- (3) That it is unanimously agreed that, as Wheeler discovered, aromatic hydrocarbons of the benzene series are not found, except in quite negligible quantities, among the condensable low temperature products, which apparently consist mainly of cyclic hydroaromatic products, together with smaller proportions of the higher olefines and some paraffins.
- (4) That the question of how far the formation of aromatic hydrocarbons of the benzene series at higher temperatures can be accounted for by the dehydrogenation of the hydroaromatic rings, or how far it may be necessary to invoke (as D. T. Jones suggests) the aid of olefine condensations in such connection, is one which future investigations must decide. It seems generally agreed, however, that acetylene plays but an insignificant rôle in coal tar formation.
- (5) Another moot point is whether phenolic bodies are primarily produced at low temperatures; here the available evidence is not altogether satisfactory, for whilst Jones and Wheeler have asserted that they occur to an extent of between 12 and 15 per cent. in the tars produced from British bituminous coals up to 430°, Pictet and his collaborator found less than 2 per cent. of them in the "vacuum tars" obtained by distilling a French bituminous coal at 450° under a pressure of 15 to 20 m.m. Also, the independent confirmation of Jones and Wheeler's observation of the occurrence of homologues of naphthalene in low temperature tars will be awaited with interest.
- (6) The systematic exploration of the character of the resinic constituents of coals will afford abundant opportunities for chemical research, and finally, the elucidation of the nature and modes of decomposition of the "ammonia-yielding" nitrogenous constituents, so consistently

COAL AND ITS SCIENTIFIC USES

ignored by the chemists whose researches have been reviewed in this chapter, is an aspect of the main problem which greatly needs attention.

That differences should have arisen between competent investigators, both in regard to observations of fact, as well as in interpreting such facts as command unanimous assent, will cause no surprise when the great complexity of the coal substance and its behaviour are considered. Indeed, as in most other branches of scientific work, it has been through the conflict of opinion based upon honest and disinterested research that the truth has at length emerged. And from the stricken field all who have worthily contended may retire with equal honours.

CHAPTER VIII

THE CHEMICAL COMPOSITION OF COAL (*contd.*)

F. SOME SECONDARY DECOMPOSITIONS AND INTERACTIONS OF THE PRIMARY DISTILLATION PRODUCTS IN HIGH TEMPERATURE CARBONISATION

Theories as to the Formation of Aromatic Compounds

ALTHOUGH certain aspects of the secondary decompositions and interactions of the primary distillation products have been incidentally touched upon in the preceding chapter, the subject is sufficiently important to warrant separate and fuller treatment. It is, however, so many-sided and complicated that the present review of it must therefore necessarily be restricted to a few of its principal features. Moreover, although high temperature carbonisation is now a highly developed branch of chemical industry, it is not proposed in this chapter to deal with either purely technical problems or the mechanical details of large scale plant and operations. What we would rather essay to do is to indicate the trend of recent discoveries and investigations in regard to some of the basic principles underlying all industrial high temperature practice.

With regard to the manufacture of coal gas, M. St. Claire Deville has published the following table embodying the results of gas-making tests upon five typical bituminous coals carried out on the testing plant of the Paris Gas Works. Judging from the results, the carbonising temperature probably did not much exceed 900° C.

COAL AND ITS SCIENTIFIC USES

TABLE XXXIII

M. ST. CLAIRE DEVILLE'S EXPERIMENTS UPON COALS AT THE PARIS GAS WORKS

Coal.	1.	2.	3.	4.	5.
100 parts of the Coal Substance contain	C. 88.38 H. 5.06 N. 1.00 O. 5.56	86.97 5.37 1.00 6.66	85.89 5.40 1.00 7.71	83.37 5.53 1.00 10.10	81.66 5.64 1.00 11.70
Moisture in Air-dried Coal .	2.17	2.70	3.31	4.35	6.17
Weight yields per 100 of the Coal Substance	Gas 13.70 Tar 3.40 Liquor 4.58 Coke 73.18	15.08 4.65 5.22 68.41	15.81 5.08 6.80 66.20	16.95 5.48 8.62 62.66	17.00 5.59 9.86 60.73
Percentage Composition of the Gas	CO ₂ 1.47 CO 6.68 C _n H _m 3.27 CH ₄ 34.37 H ₂ 54.21	1.58 7.19 4.01 34.43 52.79	1.72 8.21 4.94 35.03 50.10	2.70 9.85 5.58 36.42 45.45	3.13 11.93 5.54 37.14 45.26
Specific Gravity of the Gas .	0.352	0.376	0.399	0.441	0.482

The following table shows the results of experiments carried out by Dr. W. B. Davidson with a typical British gas coal on the experimental carbonisation plant at the Birmingham Gas Works, in which 6 cwt. charges were carbonised in 6 hours, the temperature of the retort being successively raised in each trial.¹

TABLE XXXIV

DR. W. B. DAVIDSON'S EXPERIMENTS AT THE BIRMINGHAM GAS WORKS

Temp. °C.	Per cent. Coke.	Galls. Tar.	Cub. ft. per ton Gas.	Net Calorific Value Gas. B.Th.U. per cub. ft.	H ₂ S in Crude Gas.	% Composition of Gas.					
						After Purification.					
						CO ₂ .	CO.	C _n H _m .	CH ₄ .	H ₂ .	N ₂ + O ₂
888	62.5	12.7	9,480	591	1.64	2.71	8.05	4.78	34.1	40.2	9.68
928	61.9	12.4	10,550	572	1.58	2.80	9.40	5.20	33.7	43.3	5.10
968	61.8	12.1	10,960	558	1.77	3.00	10.10	4.00	34.5	42.7	5.20
1013	61.1	11.6	11,390	545	1.83	2.95	10.08	3.96	31.4	41.5	9.26

The foregoing tables, however, only show the average composition of the gas obtained on carbonising the coal at the tem-

¹ *Trans. Inst. of Gas Engineers*, 1910, p. 269.

THE CHEMICAL COMPOSITION OF COAL

peratures named. As the carbonisation proceeds, and the heat penetrates more and more into the decomposing charge, its temperature is gradually raised, and the stream of gases and vapours evolved not only slackens, but it has to traverse, at a progressively slower rate, a region of increasing temperature in the retorts. Hence the quality of the gas naturally falls off rather rapidly after the first hour or so of the carbonisation period; the percentages of methane, ethylene, and benzene, or in other words of the hydrocarbons generally, diminish whilst that of the hydrogen progressively increases. This is shown in the following table, which gives the composition of the gas evolved at different times during the carbonisation period for a retort charged with a Derbyshire coal which was being carbonised at about 950° C.

TABLE XXXV

		Hours after Commencement.				
		0·5.	1·5.	2·5.	3·5.	5·0.
Percentage Composition of the Crude Gas	H ₂ S	3·8	3·1	2·8	2·1	1·2
	CO ₂	3·0	2·8	2·6	2·3	1·7
	CO	4·4	5·0	4·9	4·5	3·8
	C _m H _n	8·6	5·2	3·6	2·4	<i>nil</i>
	CH ₄	49·7	42·0	39·4	37·5	26·3
	H ₂	29·8	37·5	42·2	46·2	60·8
N ₂	0·7	4·4	4·5	5·0	6·2	

The composition of a purified "coal gas," as distributed from the works to consumers, will usually vary between the following limits :—¹

	Per cent.
Carbon dioxide	0·0 to 3·0
Carbon monoxide	5·0 ,, 10·0
Ethylenic Hydrocarbons	2·0 ,, 4·0
Benzene Hydrocarbons	0·5 ,, 1·0
Methane	30·0 ,, 35·0
Hydrogen	40·0 ,, 55·0
Nitrogen	5·0 ,, 10·0

In the manufacture of hard metallurgical coke, as carried out in the newer types of by-product ovens, the temperatures attained by the charge (1100–1200° C.) are rather higher than those usually prevailing in gas-works retorts, which circumstance

¹ These figures refer to a "straight" coal gas without admixture of water gas which has not been "stripped" of its benzene hydrocarbons.

COAL AND ITS SCIENTIFIC USES

is reflected in a somewhat lower average quality of gas. A good coking coal containing 30 per cent. of volatile matter will yield, besides practically the theoretical amount of coke, from 3·5 to 4·5 per cent. of its weight of tar, from 2·5 to 3·0 gallons of crude "benzol" (containing benzene and its homologues), ammonia corresponding to from 20 to 30 lb. of the sulphate, and from 10,000 to 12,000 cub. ft. of gas containing (after removal of H₂S) :—

	Per cent.
Carbon dioxide	2·0 to 4·0
Carbon monoxide.	5·0 „ 10·0
Ethylenic Hydrocarbons	2·0 „ 3·0
Methane	25·0 „ 33·0
Hydrogen	45·0 „ 55·0
Nitrogen	5·0 „ 15·0

The high temperature tars obtained in the manufacture of towns gas, or from coke-oven installations, are all "aromatic" in character, containing benzene, toluene, xylenes, pyridine bases, phenol and cresols, anthracene, naphthalene, and also a so-called "free-carbon" which, however, always contains some hydrogen and is possibly composed of very dense and complex hydrocarbons which are insoluble in the tar. The specific gravities of these tars vary between 1·07 and 1·25, thinner and lighter tars being obtained when the coal is distilled in the newer "vertical" rather than in the older "horizontal" gas retorts, whilst coke-oven tars are as a rule intermediate between the two. When fractionally distilled in a laboratory test they are, in the first instance, usually divided into :—

	B.P. ° C.
(1) Water and Light Oils.	up to 170°
(2) Middle Oils	170 „ 230°
(3) Heavy Oils	230 „ 270°
(4) Anthracene Oil	above 270°
(5) Residual Pitch	above 360°

The composition of a representative coke-oven tar may be judged from the following particulars of the results of a distillation trial in which over 1000 tons of a North of England Coke-oven Tar were fractionated during a five weeks' run of the plant, each ton of tar yielding :—¹

¹ These results are reproduced, by the kind permission of the publishers, from p. 146 of the late Mr. G. Stanley Cooper's book on *By-Product Coking* (Benn Bros., Ltd., London, 1917) to which the reader is referred for further particulars about Tar Distillation.

THE CHEMICAL COMPOSITION OF COAL

- | | | Containing | | | | | | |
|--|--|--|-----------------------------------|----------------------------------|---|------------------------------|-------------------------|----------------------------|
| (1) <i>Water</i> | = 6.5 galls. | 3 per cent. NH_3 | | | | | | |
| (2) <i>Crude Naphtha</i>
(Sp. Gr. 0.936) | = 2.8 galls. | <table style="border-left: 1px solid black; border-right: 1px solid black; padding-left: 5px;"> <tr><td>17 per cent. benzene</td></tr> <tr><td>17.5 per cent. toluene</td></tr> <tr><td>12.5 per cent. solvent naphtha (xylene)</td></tr> <tr><td>2.5 per cent. pyridine bases</td></tr> <tr><td>3.0 per cent. tar acids</td></tr> <tr><td>25.0 per cent. naphthalene</td></tr> </table> | 17 per cent. benzene | 17.5 per cent. toluene | 12.5 per cent. solvent naphtha (xylene) | 2.5 per cent. pyridine bases | 3.0 per cent. tar acids | 25.0 per cent. naphthalene |
| 17 per cent. benzene | | | | | | | | |
| 17.5 per cent. toluene | | | | | | | | |
| 12.5 per cent. solvent naphtha (xylene) | | | | | | | | |
| 2.5 per cent. pyridine bases | | | | | | | | |
| 3.0 per cent. tar acids | | | | | | | | |
| 25.0 per cent. naphthalene | | | | | | | | |
| (3) <i>Light Oil</i>
(Sp. Gr. 1.011) | = 23.6 galls. | <table style="border-left: 1px solid black; border-right: 1px solid black; padding-left: 5px;"> <tr><td>15.6 per cent. phenol and cresols</td></tr> <tr><td>35.0 per cent. naphthalene</td></tr> </table> | 15.6 per cent. phenol and cresols | 35.0 per cent. naphthalene | | | | |
| 15.6 per cent. phenol and cresols | | | | | | | | |
| 35.0 per cent. naphthalene | | | | | | | | |
| (4) <i>Creosote Oil</i>
(Sp. Gr. 1.049) | = 41.1 galls. | <table style="border-left: 1px solid black; border-right: 1px solid black; padding-left: 5px;"> <tr><td>8.4 per cent. phenol and cresols</td></tr> <tr><td>28.0 per cent. crude naphthalene</td></tr> </table> | 8.4 per cent. phenol and cresols | 28.0 per cent. crude naphthalene | | | | |
| 8.4 per cent. phenol and cresols | | | | | | | | |
| 28.0 per cent. crude naphthalene | | | | | | | | |
| (5) <i>Anthracene Oil</i>
(Sp. Gr. 1.090) | = 17.3 galls. | } 20 per cent. crude anthracene | | | | | | |
| (6) <i>Pitch</i> | = 11 cwt., having a twisting point of 55° C. | | | | | | | |

The chief differences, therefore, between the products obtained by the distillation of a bituminous coal at low and high temperatures, respectively, may be summarised as follows :—

TABLE XXXVI

	Low Temperature Distillation. 450° to 550° C.	High Temperature Distillation. 900° to 1100° C.
<i>Gas.</i>	2000 to 3500 cub. ft. per ton consisting chiefly of methane, ethane, and other paraffins, together with olefines and less than 15 per cent. of hydrogen.	9000 to 12,000 cub. ft. per ton, consisting chiefly of methane (25 to 35 per cent.) and hydrogen (45 to 55 per cent.). No paraffins higher than methane.
<i>Tars.</i>	7 to 10 per cent., consisting chiefly of paraffins and naphthenes (hydro-aromatic hydrocarbons), but no benzenoid derivatives, together with a soft pitch containing no free carbon.	4 to 7 per cent., consisting chiefly of aromatic (benzene) hydrocarbons, pyridine bases, phenols, naphthalene, anthracene, etc., together with a hard pitch containing free carbon.
<i>Ammonia (as sulphate).</i>	5 to 7 lb. per ton.	20 to 30 lb. per ton.
<i>Residue.</i>	A "semi-coke" containing up to 15 per cent. of "volatiles."	A hard coke consisting principally of carbon and ash.

COAL AND ITS SCIENTIFIC USES

If the characteristic high temperature aromatic coal distillation products are regarded as having resulted from the secondary decompositions and interactions of such primary products as methane, ethane, propane . . . ethylene, propylene . . . hexahydrobenzenes . . . during which hydrogen is continuously eliminated, as shown both by its increasing prominence in the gaseous products at high temperatures, as well as by the highly complex hydrocarbons, or carbon, produced, it is of interest to enquire how far chemical science can define the conditions and mechanism of such changes. This naturally brings us to the discussion of the formerly much-controverted question of the thermal decompositions of the simpler hydrocarbons, and the physical conditions which favour them.

It has been well known for nearly a century that under the influence of dull red heat some of the simpler hydrocarbons undergo profound changes, but it was not until after 1863-9, mainly as the result of the pioneering researches of Berthelot,¹ that the subject became ripe for systematic development in either its experimental or theoretical aspects.

As the result of an extensive series of rapidly executed experiments, Berthelot, who in 1859 had re-discovered the hydrocarbon acetylene, the remarkable properties of which he was the first to explore, put forward his well-known general theory concerning the ways in which the denser aromatic hydrocarbons may be produced at red heat from even the simplest paraffins and olefines. He assigned to acetylene a rôle of unique importance as the "pivot" of the whole system. Indeed he described this hydrocarbon as "*le produit ultime des décompositions pyrogenées . . . generateur fondamental des carbures pyrogenées*" in that it exhibits in an exceptional degree the power of polymerising and of condensing either with hydrogen or aromatic hydrocarbons at high temperatures.

Berthelot based his theory upon the assumption that no hydrocarbon (not even acetylene) is ever directly resolved into its elements by heat, but that its primary decomposition always involves either a polymerisation (*e. g.* acetylene to benzene), or a coalition of two or more molecules to form a denser one with elimination of hydrogen. Thus in the case of the simplest hydrocarbons, he assumed the following alternative primary

¹ *Ann. Chem. Phys.*, 1863 (iii.), 67, 53; 1866 (iv.), 9, 413, 455; 1867 (iv.), 12, 5, 122; 1869 (iv.), 16, 143, 148, 153, 162.

THE CHEMICAL COMPOSITION OF COAL

changes of which (b) was considered as the more frequent and probable :—

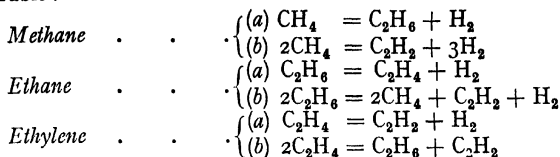

The acetylene produced in what were regarded as the more probable changes (b) would, it was further supposed, rapidly polymerise to benzene, which in turn would coalesce with more acetylene forming styrolene, naphthalene, anthracene, etc., according to the following scheme :—

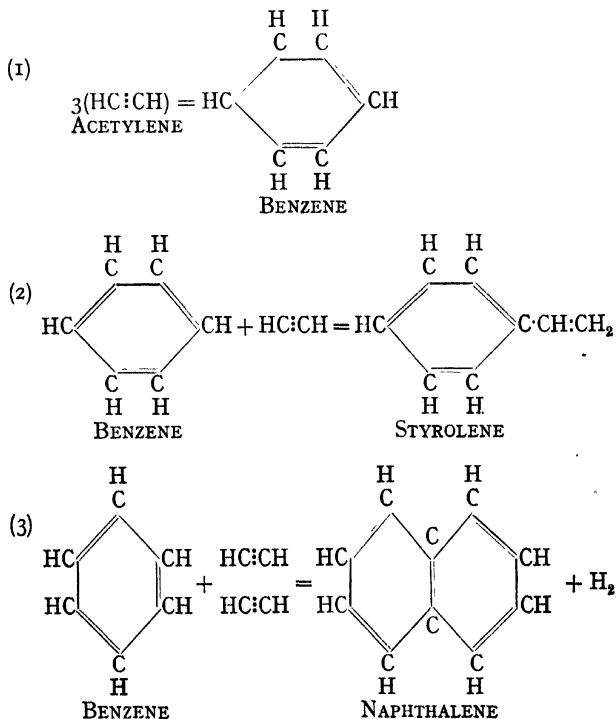

COAL AND ITS SCIENTIFIC USES

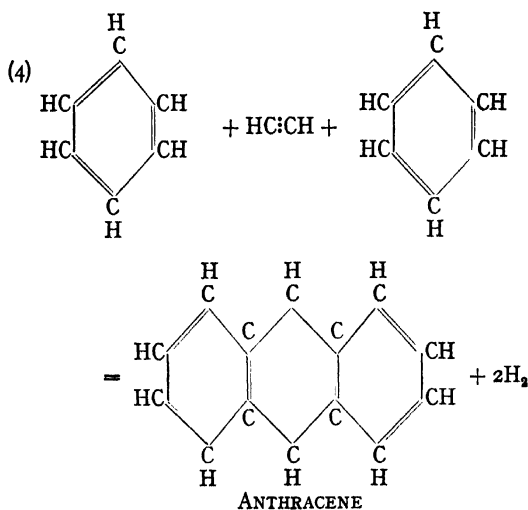

Following the same line of reasoning, Berthelot supposed that it is by the further mutual coalition of such dense hydrocarbon molecules, with the elimination of hydrogen at each stage, and in no other way, that carbon is at length obtained as the final product of the decomposition of an extremely complex molecular aggregation.

Moreover, in elaborating this idea, he convinced himself that the successive changes involved in the decomposition of any particular hydrocarbons are usually either all individually reversible, or may be so grouped as to form a series of reversible cycles, and that therefore at any given temperature there would finally be established a complex state of dynamic equilibrium between hydrogen, methane, ethane, ethylene, acetylene, benzene, styrolene, diphenyl, naphthalene, anthracene . . . and carbon.¹

¹ Berthelot's views are summarised in the following passage from one of his memoirs (*Ann. Chim. Phys.*, 1866 (iv.), 8, 471): ". . . que la décomposition immédiate d'un carbure d'hydrogène ne répond pas à sa résolution en éléments, mais à sa transformation en polymères, ou en carbures plus condensés avec perte d'hydrogène. Cette transformation ne s'effectue point d'ailleurs à une température absolument fixe et comparable à celle d'ébullition d'un liquide; mais elle s'opère pendant un vaste intervalle de température compris entre le rouge sombre et le rouge blanc; durant cet intervalle le carbure est décomposé en proportion d'autant plus forte et avec une vitesse d'autant plus grande que la température est plus élevée. . . . Entre

THE CHEMICAL COMPOSITION OF COAL

Such a theory, it must be admitted, is a singularly attractive one. It would explain how, at the temperatures prevailing in gas retorts, even the simplest of hydrocarbons can be transformed, through a whole series of successive condensations and intermediate products, into the most complex, and the assumption of the attainment at each temperature of a state of mobile equilibrium in such a system of reversible interactions fits in well with the modern thermodynamical conception of chemical changes in general. In no case, however, was the actual attainment of such a complex state of equilibrium in this "hydrogen-hydrocarbon-carbon" system ever proved by any quantitative measurement; it was considered sufficient to obtain qualitative evidence of the reversibilities of some of the principal individual reactions concerned, and then to deduce the general theory by the application of first principles.

The theory, emanating as it did from so distinguished an investigator as Berthelot, naturally commanded a good deal of support, and it was revived in a modified form by the late Vivian B. Lewes in connection with his well-known views respecting the luminosity of hydrocarbon flames.¹

It should, however, be noted that whilst Lewes agreed with Berthelot in regarding acetylene as a principal and primary product of the decomposition of both methane and ethylene, and as responsible for the formation of aromatic hydrocarbons, he differed from Berthelot in considering it capable of direct decomposition into its elements at high temperatures with explosive effect (due to its endothermic character). Indeed Lewes's theory of the luminosity of hydrocarbon flames was based upon the belief that in the inner zone of a coal-gas flame the hydrocarbons are, under the influence of radiant heat from the outer envelope, largely converted into acetylene, which at the still higher temperatures of the luminous region is resolved into its elements, the liberated carbon particles being raised to a much higher temperature than that of the surrounding flame, consequent upon the sudden disengagement of the energy originally locked up within the acetylene molecules.

Lewes represented the primary decomposition of methane and

chaque genre de réaction et la réaction réciproque il s'établit fréquemment une sorte d'équilibre mobile, variable avec la température et les corps qui se trouvent en présence, équilibre analogue à celui qui se produit lors la dissociation des composés binaires."

¹ *Journ. Chem. Soc.*, 1892, **69**, 322; *Proc. Roy. Soc.*, 1894, **55**, 90; 1895, **57**, 394 and 450.

COAL AND ITS SCIENTIFIC USES

ethylene by the following equations which are either identical with, or similar to, those postulated by Berthelot :—

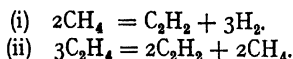

Such then is the "acetylene" theory of the pyrogenetic formation of aromatic hydrocarbons, both in its original and in its modified form. And it must be admitted that independent experiments made even by its opponents have proved that not only does acetylene polymerise to benzene at 500° to 700° , as postulated by Berthelot, but that it also decomposes explosively into its elements at still higher temperatures (above 800°) as Lewes always maintained. Nevertheless it seems to the writer that the theory must now be abandoned on the grounds principally (1) that in fact acetylene is not necessarily a prime or principal product of the decomposition of methane, ethylene, ethane, etc., as both Berthelot and Lewes have asserted; (2) that acetylene is never present anywhere in a gas retort in amounts sufficient to warrant its being regarded as even the principal, much less the only, progenitor of the aromatic hydrocarbons, as Berthelot stipulated; and (3) that the formation of aromatic hydrocarbons can be satisfactorily accounted for in other and more probable ways.

Before, however, considering the modes in which the simpler hydrocarbons decompose at high temperatures, attention may be drawn to certain facts which have been established concerning the behaviour of some of the higher paraffins than methane and ethane. In 1873 T. E. Thorpe and J. Young,¹ as the result of an investigation on the combined action of heat and pressure on the paraffins, concluded that the primary decomposition gives rise to an olefine and a lower paraffin without loss of hydrogen somewhat as follows :—

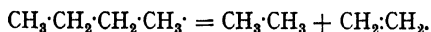

Moreover, in 1886, H. E. Armstrong and A. K. Miller,² during an exhaustive investigation of the products obtained in the manufacture of "oil gas" from petroleum, found considerable quantities of ethylene and normal olefines of the type $(\text{C}_n\text{H}_{2n+1})\text{CH}:\text{CH}_2$, up to and including *n*-heptylene, as well as of benzenoid hydrocarbons. They also drew particular attention to the almost entire absence of acetylene or its homologues, and suggested the possibility of the direct formation of aromatic hydrocarbons

¹ *Proc. Roy. Soc.*, **21**, p. 184.

² *Journ. Chem. Soc.*, **49**, p. 74.

THE CHEMICAL COMPOSITION OF COAL

from the corresponding paraffins (say benzene from hexane) without the interaction of acetylene.

Finally, in 1896, F. Haber¹ published a paper on the decomposition of the higher hydrocarbons, in which he vigorously assailed the theories of both Berthelot and Lewes, and proved conclusively that in the case of *n*-hexane, which was selected as being the paraffin most nearly related to benzene, the primary decomposition at temperatures between 600° and 800° C. involves the elimination of methane and the formation of the next lower olefine, amylene, without any appearance of acetylene whatsoever, a behaviour which he regarded as typical of all the higher paraffins, thus :—

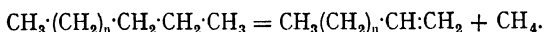

In the aromatic series, however, he recognised a marked disposition to form more complex molecules with the elimination of hydrogen, *e. g.* diphenyl from benzene, thus :—

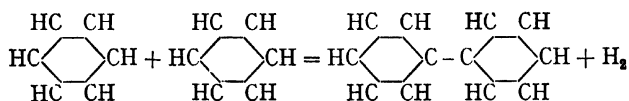

It is interesting to note, in passing, that whilst Haber thus rejected *in toto* the Berthelot-Lewes theories as untenable, he nevertheless accepted the then prevailing notion, which subsequent research has disproved, of the inherent superior stability of acetylene over that of all other hydrocarbons at high temperatures. For he stated that, whilst it polymerises readily at 600°, and at 800° yields large quantities of hydrogen, it is at still higher temperatures “*in starker Verdünnung jedem anderen Kohlenwasserstoff an Beständigkeit überlegen.*”

It, therefore, may be said that nothing has been discovered regarding the behaviour of the higher paraffins at 600° to 800° which warrants the acceptance of the idea that acetylene is either the prime or principal progenitor of aromatic hydrocarbons in such pyrogenetic decompositions. Not only so, but it is now apparent, both from the identification by Pictet and Bouvier of a whole series of “hexahydrobenzene” hydrocarbons in low temperature coal-tars (see p. 112 hereof), as well as from the recent researches of D. T. Jones upon the decomposition of such hydrocarbons by heat (p. 114), that another and far more

¹ *Ber.*, 29, p. 2191.

COAL AND ITS SCIENTIFIC USES

probable source of aromatic hydrocarbons in high temperature tars has been discovered, and that there is therefore no need for the chemist to invoke any longer the aid of acetylene in this connection.

The work of W. A. Bone and H. F. Coward¹ upon the behaviour of the simpler hydrocarbons at temperatures between 500° and 1200° C., which has already been referred to in the preceding chapter, may now be more fully considered in its bearings upon the secondary interaction occurring in the gas retort. Their experiments were carried out in such a manner that the pure dry gases (methane, ethane, ethylene, and acetylene), usually undiluted, but sometimes diluted either with nitrogen as an inert gas or with hydrogen as a "hydrogenising" agent, were either shut up for a definite interval of time in, or caused to flow through, a jacketed tube of Berlin porcelain heated to the desired temperature, suitable arrangements being installed for the condensation of any aromatic hydrocarbons which might be produced, as well as for the collection of representative samples of the gaseous products. In some of the experiments at temperatures below 800° the apparatus was so arranged that the gases were continuously circulated by means of an automatic Sprengel pump round a closed circuit (which included the heated tube and the condensing and gas-sampling arrangements, as well as a pressure gauge) until a state of constant pressure was finally attained, the whole process being kept under close observation from start to finish and the influence of time as well as of pressure and temperature investigated. Also, by making comparative experiments at a given temperature and pressure with the reaction tube alternately packed or unpacked with suitably sized fragments of porous porcelain or lime, the influence of surface upon the decomposition, which in the case of methane in particular is all-important, could be established.

Experiments upon methane showed not only that it is by far the most stable of all the hydrocarbons examined, but also that it is always a principal product of the decomposition of the other three, especially at temperatures above 800°. Moreover, its decomposition at temperatures between 800° and 1200° is, unlike that of the other hydrocarbons, entirely a "surface" effect, and involves the direct formation of hydrogen and carbon, the latter being deposited upon the walls or packing of the tube in a peculiarly

¹ *Journ. Chem. Soc.* 1908, p. 1197; also *Trans. Inst. Gas Engineers*, 1908, p. 178.

THE CHEMICAL COMPOSITION OF COAL

hard and lustrous metallic form “(methane-carbon”) quite different from the dull soft variety yielded by acetylene under similar conditions.

The rate of decomposition of methane at temperatures below 700° was inappreciable, except when the reaction tube was packed so as to expose a very large surface to the gas, and even at 785° with an unpacked tube, the gaseous products at the end of an hour contained no less than 91·6 per cent. of unchanged methane, the remainder being wholly hydrogen without even a trace of acetylene.

The following experiments, with an unpacked reaction tube at 985° to 1015° (average temperature, say, about 1000°), demonstrated the influence of time and methane-concentration upon the decomposition :—

TABLE XXXVII

Temperature C°.	985°.	985°.	1000°.	985°.	1015°.	
Duration of Heating—mins.	1.	5.	15.	30.	60.	
Gaseous Products	$\left\{ \begin{array}{l} \text{C}_2\text{H}_2 \dots\dots\dots \\ \text{C}_n\text{H}_m \dots\dots\dots \\ \text{CH}_4 \dots\dots\dots \\ \text{H}_2 \dots\dots\dots \end{array} \right.$	$\left\{ \begin{array}{l} 0\cdot5 \\ 0\cdot3 \\ 90\cdot4 \\ 8\cdot8 \end{array} \right.$	$\left\{ \begin{array}{l} 0\cdot5 \\ 0\cdot5 \\ 75\cdot4 \\ 23\cdot6 \end{array} \right.$	$\left\{ \begin{array}{l} \text{nil} \\ 1\cdot3 \\ 65\cdot25 \\ 33\cdot3 \end{array} \right.$	$\left\{ \begin{array}{l} \text{nil} \\ 0\cdot35 \\ 62\cdot85 \\ 36\cdot8 \end{array} \right.$	$\left\{ \begin{array}{l} \text{nil} \\ \text{nil} \\ 48\cdot2 \\ 51\cdot2 \end{array} \right.$
Remarks.	The appearance of a slight mist in the condensing-room indicated the presence of aromatic hydrocarbons.			No indication of any aromatic hydrocarbon vapours.		

The influence of temperature may be seen from the following comparative experiments, also with an unpacked reaction tube :—

TABLE XXXVIII

Temperature C°.	785°.	1015°.	1150°.	
Composition of Gases after one hour	$\left\{ \begin{array}{l} \text{C}_2\text{H}_2 \dots\dots\dots \\ \text{CH}_4 \dots\dots\dots \\ \text{H}_2 \dots\dots\dots \end{array} \right.$	$\left\{ \begin{array}{l} \text{nil} \\ 91\cdot6 \\ 8\cdot4 \end{array} \right.$	$\left\{ \begin{array}{l} \text{nil} \\ 48\cdot2 \\ 51\cdot8 \end{array} \right.$	$\left\{ \begin{array}{l} \text{nil} \\ 9\cdot15 \\ 90\cdot85 \end{array} \right.$
Percentages of the original Methane decomposed	4·4	35·0	83·3	

COAL AND ITS SCIENTIFIC USES

The all-important influence of surface was strikingly demonstrated by two comparative experiments at 1015° to 1030°, the one with the reaction tube unpacked, in which 35 per cent. of the original methane was decomposed in an hour; and the other with a packing of fragments of quicklime, in which no less than 96 per cent. of the hydrocarbon disappeared within 25 minutes, whilst at the end of an hour, when final equilibrium had been established in the system, only about 1 per cent. of it remained.

Another characteristic feature of the methane-decomposition is the fact that whenever a highly concentrated gas was admitted into the heated reaction tube, the observed rate of decomposition was, during the first few minutes, always proportional to some high power of the concentration, but that afterwards it rapidly approached, and finally attained, a value corresponding to a simple reaction of the first order. The facts as a whole seemed to be consistent with the view that, whenever highly condensed layers of methane are decomposing in contact with a surface at 800° or above, conditions may be produced under which the formation of acetylene and even benzene in minute quantities becomes possible, owing to the abnormally high surface concentration; but that with the disappearance of such conditions, the normal monomolecular decomposition of the gas directly into its elements, which is always dominant under all conditions, exclusively prevails, after which neither acetylene nor benzene is formed at all. Certainly the experimental results taken as a whole were inconsistent with the supposition that acetylene is a primary decomposition product, even in those experiments in which its formation could just be detected, the main change always being in accordance with the equation :—

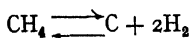

The experiments therefore showed :—(1) that the secondary decompositions of methane occurring at temperatures above 800° C. in either a gas retort or a coke oven are practically, if not entirely, confined to the gas which actually comes in contact with heated surfaces such as are presented by the walls of the retort or by the hot charge of carbonised fuel; (2) that such decompositions are much slower than those of the higher paraffins or olefines, owing to the greater stability of methane; and (3) that whilst the peculiarly hard and lustrous form of the carbon deposited from the gas as it slowly decomposes at temperatures between 800°

THE CHEMICAL COMPOSITION OF COAL

and 1200° may influence the properties of the resulting coke, the yields of benzene or aromatic hydrocarbons are hardly likely to be affected in any measurable degree by methane-decompositions.

In the case of the other three hydrocarbons investigated it soon became clear that we no longer had to do with a mere surface effect, as was the case with methane, but with one which is produced throughout the whole body of the gas by heat radiated from the walls of the hot enclosure. Decomposition was always very rapid in all three cases at temperatures above 800°, as the following will show:—

TABLE XXXIX

COMPOSITION OF THE GASEOUS PRODUCTS.							
Hydrocarbon.	Ethane.		Ethylene.		Acetylene.		
Temperature C°.	800°.	1000°.	800°.	1000°.	800°.	1000°.	
Time (mins.).	15.	5.	15.	5.	15.	5.	
Percentage Composition of the Gaseous Products	C ₂ H ₆ . . .	0·5	0·55	3·85	0·35	1·35	<i>nil</i>
	C ₂ H ₄ . . .	0·75	1·80	9·65	1·65	<i>nil</i>	<i>nil</i>
	C ₂ H ₂ . . .	<i>nil</i>	1·15	1·30	<i>nil</i>	<i>nil</i>	<i>nil</i>
	CH ₄ . . .	64·65	41·95	64·45	48·35	37·65	43·0
	H ₂ . . .	34·10	54·55	20·75	49·65	61·00	57·0

It is not, therefore, surprising that the gas evolved from retorts and ovens, in which coal is being carbonised at temperatures of 800° and upwards, should contain, as does towns gas, comparatively little ethylene, still less ethane, and practically no acetylene, although its methane content may be as high as 35 per cent. And if, as has been shown, the gas generated below 500° in the low temperature distillation of coal is comparatively rich in olefines, ethane, and other paraffins, it is clear that these must in turn largely undergo secondary decomposition at higher temperatures (above 800°) yielding, as the above results show, large quantities of both methane and hydrogen, as well as of other products.

It is, therefore, important to be able to picture the probable behaviour of these gases in the carbonising chamber (*a*) between 500° and 800° and (*b*) above 800°. In the cases of ethane and ethylene the experimental facts accord well with the supposition that the primary effect of heat is to cause an elimination of

COAL AND ITS SCIENTIFIC USES

hydrogen together with a simultaneous loosening or dissolution (according to temperature) of the bond between the carbon atoms, giving rise (in the event of dissolution) to residues such as :CH_2 and :CH . These residues, which can only have a very fugitive separate existence, may subsequently either (a) form $\text{H}_2\text{C:CH}_2$ or HC:CH , as the result of encounters with other similar residues; or (b) break down directly into carbon and hydrogen; or (c) be directly hydrogenised to methane in an atmosphere of hydrogen. All these possibilities may be realised simultaneously in the decomposing gaseous medium in proportions dependent upon the pressure, temperature, and amount of hydrogen present. Moreover, (d) "condensations" of nascent molecules such as $\text{H}_2\text{C:CH}_2$ or HC:CH , in process of formation during the primary dehydrogenation, are also possible, especially where they are present in great concentration, so that aromatic nuclei might conceivably arise immediately after the primary dehydrogenation. The scheme for ethane and ethylene may be represented as follows:—

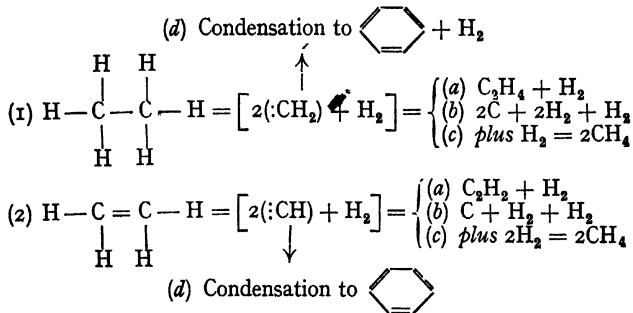

In the case of acetylene, the main primary change may either be one of polymerisation or of dissolution, according to the temperature, and if the latter, it may be supposed that residues :CH are first formed, and subsequently either (a) recombine with others, (b) break down into carbon and hydrogen, or (c) are hydrogenised to methane, according to circumstances, as follows:—

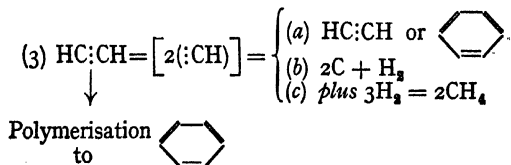

THE CHEMICAL COMPOSITION OF COAL

With regard to the possible secondary changes (*a*), (*b*) and (*c*) in such systems, it may be supposed that, in general, the proportion of (*b*) would increase with the temperature, whilst that of (*a*) would be influenced in the opposite sense. The occurrence of (*c*), which would obviously depend on the amount of hydrogen in the system at any given moment, is doubtless favoured by a temperature range of 800° to 1000°. Condensations or polymerisations (*d*) in the system are essentially what may be termed "low medium" temperature effects, a range of 500° to 700° being certainly a favourable one, as experiments with acetylene have proved. Moreover, at temperatures above 800°, the secondary slow decomposition of methane produced in all cases by the primary "hydrogenation" (*c*) must be reckoned with as an after-effect, the importance of which increases with the temperature.

Whilst reference must be made to the original memoir for details of the behaviour of the individual hydrocarbons at various temperatures between 500° and 1200°, the following observations will indicate sufficiently well for our present purpose the general tendencies displayed by each.

Although acetylene probably does not play any considerable part in the secondary interactions in a gas retort, yet from a study of its behaviour a good deal of information can be gleaned about the ways in which the principal types of secondary changes are influenced by temperature. The susceptibility of acetylene to polymerise between, say, 500° and 700° is easily demonstrated, and it is even more marked at the higher than at the lower temperature, as the following figures from "circulation" experiments indicate:—

Temperature C°.	Percentages of the Acetylene		
	Polymerised.	Hydrogenated to CH ₄ .	Resolved into C and H.
480-500°	48	13	39
650°	60	10	30

At all temperatures above 700° the tendency to polymerise rapidly diminishes, whilst the direct resolution into carbon and hydrogen increases, until at 800° the undiluted gas undergoes the characteristic luminous decomposition first observed and described by V. B. Lewes. About 75 per cent. of the gas was decomposed at 800° during this instantaneous "flash" decomposition. The remaining 25 per cent. afterwards underwent quiet decomposition,

COAL AND ITS SCIENTIFIC USES

during a period of over 15 minutes, under conditions which strongly favoured the hydrogenation of the :CH residues to methane, the final gas containing no less than 43.0 per cent. of methane and 57.0 per cent. of hydrogen.

The following experiments, in which a large quantity of acetylene was rapidly drawn through the heated tube in such a way that the decomposition at each temperature was uninfluenced by the "flashing" phenomena referred to, will indicate the influence of increasing temperatures above 800° upon the various types of interactions described.

TABLE XL

Temperature $^\circ\text{C}$.	800° .	1000° .	1150° .
Percentage of Acetylene polymerised.	19.	7.5.	5.0.
Composition of the Gases issuing from the Tube			
C_2H_2	1.35	1.55	<i>nil</i>
C_2H_4	0.45	2.60	<i>nil</i>
C_2H_6	0.50	<i>nil</i>	<i>nil</i>
CH_4	34.20	36.00	23.45
H_2	63.50	59.85	76.55

The behaviour of undiluted ethylene within the range of 500° to 700° is very interesting and complex. The :CH residues, formed by the primary decomposition, at first rapidly coalesced, forming acetylene, but as hydrogen accumulated in the system the tendency for them to be hydrogenised to methane became progressively more marked. Aromatic hydrocarbons were continuously produced, either by the secondary polymerisation of acetylene or by coalescence of :CH residues. Only a very small proportion of the carbon in the gas was liberated in the free state (thus at 570° only 0.75 per cent. of it). At 800° , the tendency to form aromatic hydrocarbons was very much less, and the separation of carbon larger, than at the lower range. The predominant effect was the hydrogenation of the :CH residues to methane. So marked is the last-named tendency that methane was found to constitute as much as 67.7 per cent. of the final gaseous products at 800° just when the last remains of the original ethylene were disappearing. At 1000° , not more than about 4 per cent. of the original gas was converted into condensable aromatic hydrocarbons during the initial rapid decomposition. The hydrogenation of :CH residues to methane was still a dominant feature of the

THE CHEMICAL COMPOSITION OF COAL

phenomena, although the tendency of free carbon to be liberated increased. From the behaviour of ethylene at temperatures below 800° it seems not unlikely that, as D. T. Jones has suggested, the olefinic hydrocarbons, which are formed in considerable quantities in low temperature carbonisation, may at the higher temperature prevailing in gas-works retorts be responsible for a good deal of "aromatic" formation, but the matter is one which certainly deserves further investigation in this connection.

In the case of ethane, experiments at 675° C. showed primarily a strong tendency for the coalescence of $:\text{CH}_2$ residues forming ethylene, which latter in a diluted condition decomposed *via* $:\text{CH}$ residues yielding, eventually, a mixture of carbon, hydrogen, and methane, with some intermediate formation of acetylene. There was only a very small yield of aromatic hydrocarbons (equivalent to not more than 4 per cent. of the original gas) nearly all in the form of almost pure naphthalene (no benzene). Thus the behaviour of ethane at such low temperatures is in strong contrast to that of either ethylene or acetylene in respect of "aromatic" formations. At 800° , whilst the primary $:\text{CH}_2$ residues still showed a marked tendency to coalesce to ethylene, their hydrogenation to methane now became the predominant feature and remained so until after a temperature of 1000° had been passed. The amount of "aromatics" formed during a brief heating to the latter temperature was only about 4 per cent. of the total ethane changed.

Apart from having introduced the new conception that the thermal decomposition of these hydrocarbons involves the *primary* formation, by dehydrogenation, of the unsaturated residues $:\text{CH}_2$ and $:\text{CH}$, which during a fugitive but really independent existence are free to interact with the surrounding gaseous medium after their kind, it may be claimed that the researches in question have established the following facts, which have an important bearing upon the secondary chemical phenomena in high temperature carbonisation, namely:—

- (1) That the most favourable temperature range for "aromatic" formations from such residues as $:\text{CH}_2$ or $:\text{CH}$ (namely, 500° to 800°) lies well below that which is most favourable to the hydrogenation of such residues to methane (namely, 800° to 1000°).
- (2) That within the aforesaid most favourable range, ethylene is, by reason of the rapid production of $:\text{CH}$ residues during

COAL AND ITS SCIENTIFIC USES

its primary decomposition, eminently capable of generating aromatic nuclei, although in a less marked degree than in the case of acetylene. On the other hand, ethane, which primarily produces :CH_2 residues only, does not form aromatic nuclei nearly so readily as does ethylene.

- (3) That methane, whose stability exceeds that of all other hydrocarbons at high temperatures, is practically unaltered by any degree of heat up to about 800°C . Between 800° and 1000° it slowly decomposes directly into its elements, but only in contact with hot surfaces. Above 1000° its decomposition, whilst still retaining a surface effect entirely, is more rapid. The carbon deposited upon surfaces from such decomposing methane is a peculiarly hard and lustrous metallic form, which in coking operations may have an important influence upon the strength and other properties of the resulting coke. A slight formation of aromatic nuclei from decomposing methane can usually be detected whenever the conditions favour the formation of highly condensed layers of the gas in contact with the hot surfaces, but not otherwise.

With regard to the formation of benzene hydrocarbons in gas retorts and coke ovens, if the old "acetylene" theory in its original form must now be discarded, there still remain two potent causes, namely: (1) the thermal "dehydrogenation" of naphthenes of the hydrobenzene type, and (2) the condensation of olefines or, more probably, of the "unsaturated residues" produced therefrom, and both causes probably operate simultaneously. The most favourable temperatures for such changes undoubtedly lie between 500° and 800°C ., and if the factor of time, as well as of stability, is taken into account, we shall probably not be far wrong in assuming a somewhat narrower range of (say) 650° to 750°C . as that which would in practice give the best yields of benzene and its homologues.

CHAPTER IX

THE CHEMICAL COMPOSITION OF COAL (*contd.*)

G. THE ACTION OF OXYGEN AT LOW TEMPERATURES UPON COAL. THE WEATHERING AND SPONTANEOUS HEATING AND IGNITION OF COAL

It has long been known that bituminous coals are not only liable to spontaneous heating and combustion, but also that they deteriorate on storage, both as regards calorific power and coking properties. All these circumstances are due to the fact that all coals, some much more so than others, absorb and slowly combine with oxygen on exposure to the air even at ordinary temperatures. This atmospheric oxidation or weathering of coals is an action which goes on slowly and continuously whenever they are stored or handled with free access of air. It continues with increasing rapidity as the temperature rises, and always generates heat which, if allowed to accumulate, may ultimately give rise to spontaneous ignition. And even when precautions are taken to prevent such accumulations, and therefore any sensible heating of the mass of coal, the oxidation nevertheless goes on all the same, and causes an appreciable diminution in the heating value of the coal. For, as two American investigators have well put it, "any heating of coal in the pile represents just so much heat that will not be available later under the boiler."¹

The subject is, therefore, one of considerable economic importance, touching as it does not only the safety of coal mines, *i. e.* the occurrence of what are termed "gob fires" in the mines, due to underground conditions which are peculiarly favourable to a cumulative heating effect, but also the storage of coal in bulk, and especially its oversea transport in ships.

It may here be stated that, although theoretically all coals are liable to the spontaneous oxidation, anthracites and anthra-

¹ S. W. Parr and W. F. Wheeler in "The Weathering of Coal," *University of Illinois Bulletin*, No. 38 (1909).

COAL AND ITS SCIENTIFIC USES

citic coals are so little affected that they may be considered as practically immune from appreciable deterioration on weathering. Hence they may be regarded as almost ideal solid fuels for storage or oversea transport. Most bituminous coals are, however, so appreciably affected that they always deteriorate on storage.

Until past the middle of last century the liability of coals to spontaneous heating was generally attributed primarily to the presence of iron pyrites therein, on the mistaken supposition that the coal substance is relatively inactive towards atmospheric oxygen at ordinary temperatures. It was thought that the heat generated by the oxidation of the supposedly much more susceptible pyrites would, in favourable circumstances, be sufficient to raise the temperature of the coal substance to such a degree as would enable it in turn to combine readily with oxygen, and so to induce an outbreak of spontaneous combustion in the mass as a whole. According to this theory, the susceptibility of a coal to such spontaneous heating would, *ceteris paribus*, be determined primarily by its pyritic content.

In discussing the matter, however, it should be remembered that iron pyrites is polymorphic, and that the cubical form of it is more stable in air than the rhombic variety (marcasite); also, that the fineness of division of the pyrites would be a factor, and that its oxidation requires the co-operation of water, as follows:—

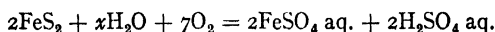

Such a change would liberate heat amounting to 262·5 K.C.U.s. per gram molecule of the pyrites oxidised, apart from that generated by any further oxidation of the ferrous sulphate primarily formed. Taking the average specific heat of a bituminous coal as 0·35, and assuming a pyritic content of 2 per cent., then the heat liberated by the oxidation of its pyrites would, if wholly accumulated in the coal mass, be sufficient to raise its temperature by (taking a metric ton as the basis of calculation) as nearly as possible 125° C.

Such a calculated figure, assuming as it does that the whole of the pyrites is oxidised rapidly enough to prevent any dissipation of the heat evolved, gives a greatly exaggerated estimate of the rise in temperature which would be likely to occur in any circumstances.

THE CHEMICAL COMPOSITION OF COAL

If, as will be shown later, the atmospheric oxidation of a bituminous coal does not become autogenous, *i. e.* self-propellent, until its temperature reaches 200°C. , and seeing that its ignition point usually lies above 350° , it would *prima facie* hardly appear likely that the "pyritic" theory is by itself sufficient to account for the spontaneous firing of coal.

All competent scientific opinion now regards the influence of pyrites as either a negligible, or at the most a quite subordinate, factor in initiating or developing the phenomenon, and attributes it rather to the liability of the coal substance itself to slow oxidation at low temperatures.

The first important researches on the subject were those of E. Richter, published during the years 1868-70.¹ He showed that, at the laboratory temperature of 15° to 21°C. , "perfectly dry coal, as well as air-dried coal, is able to absorb oxygen without exhaling carbon dioxide, both from dry and from air saturated with water vapour." On keeping a certain dried coal at 70° to 80°C. for 14 days its calorific power diminished by 3 per cent., and the coking properties also deteriorated. Moreover, until its temperature rose beyond 170° to 190° , there was no appreciable loss, but rather a gain in weight. And inasmuch as the coals examined did not contain more than 0.31 to 0.42 per cent. of pyrites, and that a mixture of fine quartz sand with the same proportion of pyrites did not absorb any oxygen in *dry* air, and only a very small amount in *moist* air, Richter concluded that pyrites has little or no effect upon the spontaneous oxidation of coal, which he attributed to an action upon the coal substance itself.

In 1879 Henri Fayol, who thoroughly investigated the conditions under which coals from the collieries in the Commeny district of Northern France absorb oxygen, or spontaneously ignite when exposed to air at temperatures beginning at 25° and rising to 200° , or even 400°C. , was unable to detect that their pyritic contents had any appreciable influence upon the process. He found, however, as might be anticipated, that the finer the state of division of a coal the more rapidly does it combine with oxygen and catch fire; he gave the following

¹ *Dingler's Polytechnisches Journal*, Vols. 190, 193, p. 51, and 195, p. 315. English translation published in *extenso* in the *Report of the New South Wales Commission on Coal Cargoes*, No. 1, 1897; *vide* also paper by R. Threlfall, *Journ. Soc. Chem. Ind.*, 1909, 28, p. 759.

COAL AND ITS SCIENTIFIC USES

approximate temperatures for the relative inflammabilities of powdered coals in hot air :—

	Relative Inflammabilities in Hot Air (Fayol).
Lignites	150°
Gas coal	200°
Hard coking coal	250°
Anthracites	above 300°

In 1898 Carrick Anderson, in the course of his investigation upon Scottish coals (*loc. cit.*), found that, at temperatures below 160°, atmospheric oxidation makes rapid progress during the first 12 to 24 hours, but afterwards falls off considerably. Nevertheless a slow increase in weight continues for a long time, the period required for completing the oxidation varying greatly with different coals.

In 1901, Fischer¹ of Göttingen, after bringing forward new evidence confirmatory of the views already expressed by Richter and Fayol concerning the relative insignificance of the part played by pyrites in the weathering of coals, attributed the main cause to the presence in the coal substance of "unsaturated" compounds capable of combining additively with either bromine or oxygen at low temperatures. Hence he concluded that coals which have the greatest affinity for bromine are also most liable to spontaneous firing, and as a practical test he recommended shaking 1 gram of the finely powdered coal with 20 c.cs. of $\frac{N}{2}$ bromine solution for 5 minutes. If then any free bromine remains, the coal (he said) may safely be stored in bulk. He also showed that the absorption of oxygen which is exothermic and accompanied by a gain in weight is accelerated by a rise in temperature.

Among British investigators whose independent experiments have led them to reject the pyritic theory in its original form may be mentioned V. B. Lewes, R. Threlfall, R. V. Wheeler, J. S. Haldane, and the writer. Lewes,² however, thought that pyrites may play a subsidiary rôle because of its swelling up on oxidation which conceivably might contribute to the disintegration of the coal and so indirectly assist the action of oxygen upon the coal substance. He also assigned the following approximate

¹ *Gas World*, April 13, 1901.

² *Journ. Gas Lighting*, 55, p. 145, 1906, 04, p. 33.

THE CHEMICAL COMPOSITION OF COAL

ignition temperatures which are, it will be observed, decidedly higher than the figures given for the relative inflammabilities of coal dusts in hot air :—

	Approximate Ignition Temperature ° C. (V. B. Lewes).
Cannels	370°
Lignites	450°
Welsh Steam Coals	470°

R. Threlfall's work was mainly connected with the investigation of the New South Wales Royal Commissions between 1896 and 1908 upon the Spontaneous Heating of Coal, particularly during shipment, the result of which he subsequently reviewed in perhaps the most notable memoir on this aspect of the subject which has yet appeared.¹

From the extensive data and experiments collected or carried out for these Commissions, as well as from general principles established by previous scientific researches, notably those of Richter and Fayol, which were highly commended, it would appear (said Threlfall) that liability to spontaneous fires in ships' cargoes may be expected to increase (1) *pari passu* with the tonnage of the cargo and the temperature at which it is loaded, (2) with the fineness of division of the coal, and (3) with only *slight* ventilation during the voyage. Also, it was stated that the Commission had failed to find a single undoubted case of a spontaneous fire in a coal cargo having originated in any other place than under the hatchways, from which it follows that the presence of a heap of dust under the hatchways should in any circumstances be specially avoided as a highly dangerous condition.

In 1909 Boudouard,² in experiments upon the atmospheric oxidation of coal at 100°, reported the formation under such conditions of "humic acids" from the cellulosic constituents in the coal substance, and that the coking properties had completely disappeared.

In 1909 P. Mahler³ proved that when air is passed over dry coal free from occluded gases, at as low a temperature as 25° to 30°, water, carbon monoxide, and carbon dioxide are formed, less carbon monoxide being formed if the coal contains moisture. He also reported the finding of from 0.002 to 0.004 per cent.

¹ *Journ. Soc. Chem. Ind.*, 1909, **28**, p. 759.

² *Bull. de la Soc. Chem.*, 1909, **5**, 365.

³ *Compt. rend.*, 1910, **150**, 1521, **181**, 645.

COAL AND ITS SCIENTIFIC USES

of carbon monoxide in the air of coal mines. The production of carbon monoxide during the slow oxidation of coal at such low temperatures is entirely what chemists would have anticipated from the work of H. B. Baker, and the more recent researches of R. V. Wheeler, upon the combustion of carbon, to which further reference will be made in another chapter. It has also frequently been observed, not only by R. V. Wheeler, but independently also by the writer, in researches upon the slow oxidation of coal.

Among the most informing of recent investigations from the point of view of the storage of coal on land are those of S. W. Parr and his collaborators of the University of Illinois,¹ who experimented upon a series of Illinois coals which are characterised by both high moisture (12 to 15 per cent.) and sulphur (1 to 6 per cent.) contents. The experiments were directed mainly to the ascertainment of the influence of temperature, fineness of division, moisture, and pyrites, upon the liability to spontaneous combustion. The procedure consisted in maintaining 25 lb. to 35 lb. lots of suitably screened coal in a special container at a constant temperature (40°, 60°, 80°, and 115° C.) within an insulated oven, with free air circulation, in such a manner that the rate of the temperature-rise of the coal above that of its environment could be accurately followed until it attained a steady maximum, which always happened within the 72 hours period over which each experiment extended.

Altogether some fifteen series of experiments were made upon charges whose fineness of division, pyritic, and moisture contents were varied in accordance with a carefully laid plan, and each charge was tested successively at the four temperatures above named. The principal conclusions arrived at were:—(1) that the oxidation of coal is continuous over a wide range of temperatures beginning, in the case of freshly mined coal, at the ordinary temperature; (2) that at low temperatures the initial oxidation, which is unattended by any evolution of carbon dioxide, is due to the presence in the coal substance of certain "unsaturated" compounds having a marked avidity at ordinary temperatures for oxygen with which they unite forming compounds of the humic acid type (*vide* Boudouard); (3) that although this slow oxidation is exothermic, it does not, with free air circulation, cause any material self-heating of the coal about its environment until a temperature of 60° to 80° C.,

¹ *University of Illinois Bulletin*, Nos. 17 of 1908 and 46 of 1911.

THE CHEMICAL COMPOSITION OF COAL

dependent upon the size of the coal and other conditions, is reached; (4) that this self-heating at any temperature is more rapid, and the final steady maximum in relation to the air circulation is greater, the finer the state of division of the coal; (5) that the presence of moisture increases the chemical reactivity of the coal-air system at any temperature; (6) that at a temperature of about 120° in oxygen and 135° in air the constituents of the coal begin to oxidise more freely with evolution of carbon dioxide and water, a state of things which must always be regarded as highly dangerous; (7) that the point at which the oxidation becomes autogenous (*i. e.* self-propellent) lies somewhere below 140° and 160° in oxygen and 200° to 270° in air, and that as soon as this point is reached the temperature will rapidly rise to the ignition point of the coal, which usually lies above 350°.

With regard to the influence of pyrites, it was found that the amount of "pyritic oxidation" under given conditions is always proportioned to the pyritic content of the coal, so that an increase on the latter will (it was thought) hasten "the rise in temperature up to the critical point at which the absorption of oxygen by the coal itself is rapid enough to increase the temperature up to the point of self ignition." Hence it was concluded, "that the presence of pyrites is a much more important factor in the spontaneous ignition of coal than has heretofore been ascribed to it, and its influence upon the spontaneous combustion of coal cannot be discarded in the off-hand way that has been so common with some of the previous investigations, merely because of the fact that some coals containing no pyrites at all would ignite spontaneously."

These important statements seem to be based principally upon the result of three series of experiments with the environment at 80° in which, although no condition varied except the pyritic content of the coal, ignition occurred in the cases of the two dust coals of higher pyritic contents, as follows:—

	Series No.	2	4	6
Percentage Pyrites in <i>Wet</i> Coal		1·65	3·0	5·0
Temperature of Environment		80°	80°	80°
Rise in Temperature of the Coal.	{	Size of Coal.		
	0	50°	to ignition	to ignition
	0 to ½ in.	36°	57°	43°
	½ in. to ¼ in.	21°	11°	18°

COAL AND ITS SCIENTIFIC USES

The following preventive, or precautionary, measures were suggested in connection with the storage of coal in bulk, namely:—(a) the avoidance of any external source of heat which would in any way contribute towards increasing the temperature of the mass; (b) the elimination of coal dust; (c) dryness in storage; (d) the artificial cooling of the heap by any suitable means which will keep down its temperature without increasing the access of oxygen; or (e) the submerging of the coal under water.

In the year 1913 a Departmental Committee was appointed by the Home Office to consider the question of the Spontaneous Firing of Coal in relation to the safety of mines. Various scientific investigators, including R. V. Wheeler, Professor P. P. Bedson and the author, gave evidence as to their views and experience. Dr. Wheeler put forward an interesting new suggestion, namely, that the greater the amount of combined oxygen in the coal substance the more readily will it "self-heat," and the lower is the temperature at which "self-ignition" occurs. The Committee issued their First Report in 1916, which should be consulted for details of the evidence submitted.

The subject has been investigated by the staff of the Doncaster Coal Owners Research Laboratory, under the direction of J. S. Haldane.¹ These further experiments, whilst usefully confirming much of the results of previous work, do not appear to the writer to have added materially to our knowledge of essential facts, although in relation to the particular problem of the safety of mines the inferences which may be drawn from them may be important. In reviewing these experiments, Haldane rightly states that "the conditions underground are often peculiarly favourable to a cumulative heating effect, for, owing to the ventilation, it is very apt to happen that a continuous slow current of air passes horizontally along a layer of broken coal. The heat is thus carried on, and the temperature rises higher and higher along the course of the air current, until at a certain distance a dangerous temperature is reached. Ordinary gob fires seem to be always produced in this way."

With regard to the influence of pyrites, Haldane speaks with some uncertainty, for whilst admitting "that in the Barnsley and many other seams it is not pyrites to any appreciable extent, but other substances in the coal that oxidise," he goes on to say that "in some other kinds of coal the oxidation of pyrites was

¹ *Inst. Mining Engineers*, Part IV., Vol. 53, p. 194 (1917).

THE CHEMICAL COMPOSITION OF COAL

found to play a considerable part in the heat production, and probably a predominating part in certain cases," and he suggests that the difference may depend on whether the pyrites is present in "lumps" (cubical crystals), as in the Barnsley coal, or in some "more impure and disseminated condition." Further on, however, he says that whereas "he was formerly inclined to attribute to pyrites the main part in the spontaneous heating of coal . . . it is now clear that in the heating of coal another type of oxidation is usually involved." He then says how the Doncaster workers had been puzzled to find that "in the oxidation of coal at low temperatures oxygen disappears but hardly any carbon dioxide is formed," but this fact was surely well known before to chemists (*vide* S. W. Parr in particular), and need cause no surprise to any one familiar with the phenomena of surface combustion generally. Indeed, to the writer it seems that, judging by Haldane's account of them, the Doncaster experiments have in their chemical aspects been anticipated in several important points by previous work.

As practical precautions against the outbreak of gob fires in mines, Haldane recommends:—(1) that the liability of the coal in the seam to spontaneous heating should always be tested; (2) that if found very liable, the method of working should be such as to reduce to a minimum the occurrence of crushing; (3) that in order to avoid as far as possible percolation of air through goaves containing coal, the ventilating pressure should be kept as low as possible, which means roomy roadways in the mines and the keeping of the goaves as air-tight as possible. The control of such conditions is, he says, more complex when a seam is not flat, or where faults are met with, "since the convection currents due to difference of temperature must tend to cause air-currents in the goaf, and coal may have to be left near a fault." He concluded with the what may seem at first sight a rather obvious statement, but which nevertheless needs to be reinforced whenever conditions in mines are under discussion, that gob fires would be entirely avoided if it were possible to remove the whole of the coal, good or bad, including slack.

In connection with a further development of the Doncaster experiments upon the soft coals of the Barnsley seam (S. Yorks), Messrs. Graham and Hills have recently reported that the portion of the coal (15 per cent.) which is soluble in pyridine does not absorb oxygen at 90° C., and "cannot therefore be responsible for the spontaneous combustion of coal," a conclusion which is

COAL AND ITS SCIENTIFIC USES

not only very remarkable, but also considerably at variance with the opinion of other investigators. Dr. R. V. Wheeler has, however, stated that this fact had already been established by himself and C. B. Platt at the Home Office Experimental Station in 1913 and communicated to the Spontaneous Combustion Committee in 1913.

From experiments which have been in progress in the author's laboratory at the Imperial College of Science and Technology since the appointment of the British Association Fuel Economy Committee in 1915, it would appear, however, that the phenomenon of coal oxidation at low temperatures is too complicated to warrant the deduction of any such conclusion as the foregoing in regard to coals generally from observations on one kind of coal only.

The experiments in question (the full details of which will be published later) have so far been principally confined to the absorption of oxygen between 45° and 120° C. by two typical bituminous coals, namely (1) a Durham "coking" coal A., and (2) a Barnsley "hard steam" coal B., which were selected as having nearly the same percentage compositions notwithstanding the considerable differences in their properties, as follows :—

	C.	H.	N.	S.	O.	Ash.
A. Durham Coking Coal	83.73	4.76	1.09	1.28	7.52	1.62
B. Barnsley Hard Steam Coal	82.33	4.99	1.50	0.70	7.72	2.76

At temperatures below 80°, the absorption of oxygen was in each case comparatively slow, even when the coal was exposed to the gas under high pressures, and the absorption was unattended by the production of more than relatively very small proportions of oxides of carbon. In the neighbourhood of 80°, however, the action became decidedly quicker, and at above 100° it was marked by a regular and simultaneous production of the two oxides of carbon and steam, all of which evidently resulted from the decomposition of some unstable "oxygenated" body (or bodies) primarily formed by the absorption of the oxygen.

In illustration of this aspect of the phenomenon, the results of two strictly comparative experiments may be given, in each of which oxygen, dried over calcium chloride, was continuously circulated at an average pressure of about 0.9 atmospheres in an enclosed system over a weighed quantity of one or other of the coals previously dried *in vacuo* over sulphuric acid and

THE CHEMICAL COMPOSITION OF COAL

ground so as to pass a 90-mesh sieve. Throughout each experiment, which extended continuously night and day over a period of from three to four weeks, the coal was exposed to the action of the oxygen at a constant temperature of 107° to 109° C.

From the accompanying tabulated results and curves (Tables XII, XLII, XLIII, and Figs. 19 and 20, the latter showing the relative rates at which the oxygen was absorbed and also those at which CO and CO₂ respectively were produced during each

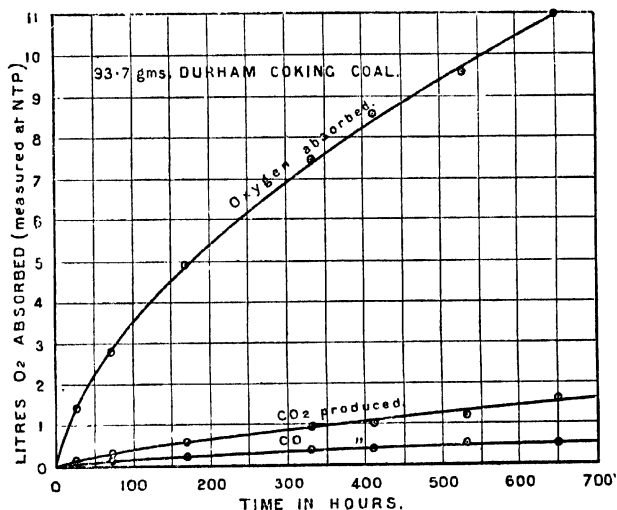

FIG. 19.—Absorption of Oxygen by Durham Coking Coal (A).

experiment), it is apparent (1) that, especially at the initial stages, the oxygen was much more quickly absorbed by the Barnsley than by the Durham coal, although the absorption was not nearly complete even after 400 hours in the one case and 648 hours in the other; (2) that both of the two oxides of carbon were continuously and simultaneously produced throughout each experiment, and (after the first 100 hours or so) in nearly the same relative proportions; and (3) that from 30 to 35 per cent. of the absorbed oxygen was evolved as steam. It should also be stated that the coking properties of each coal were completely destroyed by the treatment to which it had been subjected.

COAL AND ITS SCIENTIFIC USES

TABLE XLI
TABLE OF RESULTS

Coal.	A.	B.
Quantity of Dry Coal used in grams	93.7	86.9
Temperature of Coal ° C.	107° to 109°	107° to 109°
Duration of Experiment—hours	648	481
Total Oxygen absorbed in litres at N.T.P.	11.00	10.20
Percentage of $\left. \begin{array}{l} \text{Total Oxygen} \\ \text{absorbed} \end{array} \right\} \begin{array}{l} \text{in the Coal} \\ \text{as CO}_2 \\ \text{CO} \\ \text{H}_2\text{O} \end{array}$ appearing	$\left. \begin{array}{l} 45.65 \\ 17.11 \\ 2.70 \\ 34.51 \end{array} \right\}$	$\left. \begin{array}{l} 56.20 \\ 10.45 \\ 2.82 \\ 30.54 \end{array} \right\}$
Percentage of Oxygen in the "Oxygenated" Coal	13.08	16.97

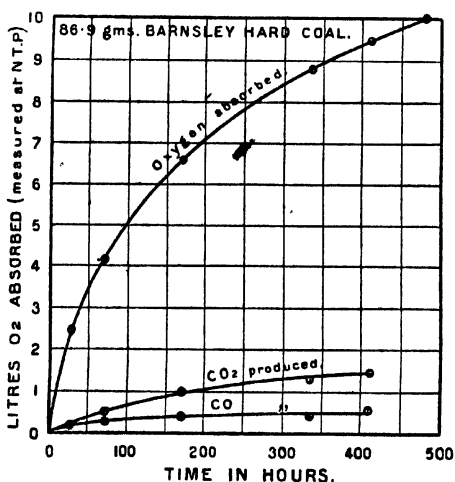

FIG. 20.—Absorption of Oxygen by Barnsley Hard Coal (B).

On calculating from the experimental results the total amounts (in c.cs. per gram) of oxygen which had reacted with unit weight of the dry coal in each case both during, and up to the end of, each successive period of 100 hours, we find that during the whole of the first 200 hours the oxidation of Coal B. was decidedly more rapid than that of Coal A. Afterwards, however, the rate for B. became somewhat the slower of the two, although the

THE CHEMICAL COMPOSITION OF COAL

total amount of oxidation from the beginning up to any particular time always remained greater for B. than for A. throughout the whole experiment, thus :—

TABLE XLII

Amount of Oxidation in c.cs. O ₂ at 0° and 760 m.ms. per gram of Dry Coal.				
Time Interval in Hours.	Coal A.		Coal B.	
	During Interval.	Up to end of Interval.	During Interval.	Up to end of Interval.
0 to 100	37.4	37.4	57.5	57.5
100 ,, 200	20.5	57.9	23.7	81.2
200 ,, 300	16.1	84.0	15.8	96.0
300 ,, 400	13.4	97.4	12.3	108.3
400 ,, 500	12.6	110.0	7.1	115.1

Another interesting feature of the results with Coal A. was that not only did the volumetric ratio of the CO₂ to the CO produced remain fairly constant throughout each experiment, especially after the first 100 hours, but also that the proportion of the total reacting oxygen which had appeared as oxides of carbon at any particular time did not change very materially (see below).

TABLE XLIII

COAL A.

Time Hours.	Total Volume in Litres at 0° and 760 m.m. produced of		Ratio CO ₂ /CO.	Proportion of absorbed O ₂ appearing as CO ₂ and CO.
	CO ₂ .	CO.		
100	0.40	0.18	2.22	0.140
200	0.65	0.26	2.50	0.143
300	0.87	0.34	2.55	0.152
400	1.06	0.40	2.65	0.154
COAL B.				
100	0.66	0.34	1.94	0.145
200	1.04	0.44	2.36	0.178
300	1.25	0.50	2.50	0.177
400	1.38	0.50	2.76	0.172

COAL AND ITS SCIENTIFIC USES

These circumstances certainly suggest that, except perhaps during the early stages of the oxidation, both these gases were mainly produced by the secondary thermal decomposition of a particular unstable "oxygenated" complex primarily produced by the oxidation of some constituent of the coal, the nature of which is being further investigated. These features were not, however, nearly so marked in the case of Coal B., whose oxidation is perhaps a more complex matter than in the case of Coal A.

From the scientific standpoint the subject of the spontaneous firing of coal involves a number of points which have not yet been sufficiently considered. Several of the investigators whose researches have been reviewed have obviously not paid sufficient attention to previous work on the purely scientific aspects of the mechanism of combustion, as for example, H. B. Baker's work, and still more recently, that of R. V. Wheeler, on the combustion of carbon.

Again, it is curious to find how some workers have, until quite recently, failed to recognise, what Richter's and Fayol's researches had plainly taught, that however helpful the *role* of pyrites may be, the main and predominating cause of the spontaneous combustion of coal must be sought for in the oxidation of the coal substance itself.

Finally, none of the workers who have treated the scientific aspects of the subject seem to have sufficiently realised that the whole process from first to last is essentially one of "surface combustion" which, as the writer's researches have shown, is subject to special conditions which do not apply in homogeneous gaseous combustion. It is abundantly evident that the oxygen is first of all "absorbed" by the coal substance, possibly in some "activated" form, then incorporated in some way (it may only be loosely, or, on the other hand, it may be, as S. W. Parr suggested, in some definite form), and as the temperature rises, it finally is expelled in gaseous products (H_2O and oxides of carbon). And between its initial absorption and its final expulsion a whole series of complex phenomena may be involved, which have hitherto received little attention. The subject needs more investigation from a fundamental standpoint, and in particular the following points seem to demand some experimental revision or confirmation:—

(1) If, as is clear, the old "pyritic" theory in its original form is no longer tenable, what subsidiary part (if any) does pyrites play? This question ought not to be left in the hazy

THE CHEMICAL COMPOSITION OF COAL

condition into which it has been thrown by the recent rather ambiguous statements of S. W. Parr and J. S. Haldane.

(2) What constituents of the coal substance (cellulosic, resinic, or nitrogenous) are most liable to spontaneous oxidation at low temperatures?

(3) Is there any "activation" of the oxygen initially absorbed by the coal which quickens its chemical action, and, if so, by what factor is it determined and governed?

(4) What is the lowest temperatures at which gaseous products (CO , CO_2 and H_2O) are freely evolved from the surface of coal undergoing such oxidation?

(5) What is in each case the lowest temperature (with varying types of coal) at which the action of oxygen become autogenous?

(6) Does the oxygen naturally present in the coal substance itself play any part at all in the phenomenon up to, say, the temperature at which the action becomes autogenous?

CHAPTER X

THE COMBUSTION OF COAL

THE combustion in a furnace of a bituminous coal is by no means so simple or direct a process as was formerly believed. Indeed the cumulative evidence afforded by a long series of chemical investigations during the past thirty years has proved that combustion in general is, from a molecular standpoint, a highly complex transaction, usually involving several stages, and in many cases also the interaction of steam, in addition to that of oxygen, and the combustible substances.

Assuming, for the sake of convenience, that the composition of the combustible matter of an average bituminous coal approximates to the empirical formula C_9H_8O ($C = 83.1$, $H = 4.6$, and $O = 12.3$ per cent.), such an equation as,

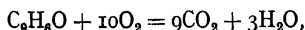

enables us to say very little more about its combustion than that, supposing it were possible in practice to completely burn it to carbon dioxide and steam in just the theoretical quantity of air, one kilogram of it would require 8.22 cub. metres of air measured at $0^\circ C.$ and 760 m.m. (equivalent to 131.7 cub. ft. per pound), and that the cold gaseous products would contain 18.87 per cent. of carbon dioxide. The equation would tell us nothing whatever about the mechanism of the combustion, which, when closely investigated, would be found to be an extraordinarily complicated phenomenon. So much misconception is still prevalent about the matter, and so much depends on a true understanding of it, that it is worth while at the outset to consider it in some detail from a fundamental standpoint, before proceeding to discuss the practical bearing of the principles involved.

When a fresh charge of raw coal is introduced into the furnace of, say, a boiler, it first of all undergoes a destructive distillation, whereby a number of combustible gases, tarry vapours and steam are expelled. The gaseous products chiefly consist of hydrocarbons (methane with smaller proportions of ethylene, benzene,

THE COMBUSTION OF COAL

and probably also ethane), hydrogen, and carbon monoxide, whilst the tarry vapours are mingled with a certain proportion of finely divided carbon (soot). The "volatile" combustible constituents thus evolved from the upper portion of the fuel bed will amount in all to between 15 and 25 per cent. of the weight of the ash-free coal charged, and the oxygen needed for this combustion must be furnished by what is sometimes termed a "secondary" air supply which is usually introduced through adjustable openings in the doors of the furnace, or (may be) also at the fire-bridge, in such a manner that it mixes with the combustible gases and vapours at or near the top of the fuel bed. The ensuing combustion causes the well-known development of smoky flames in the furnace after each addition of fuel.

The combustion of the residual coke (carbon) takes place in the lower layers of the fire by means of the "primary" air supply drawn in through the fire-bars, the evidence of which may be seen by looking at the incandescent mass of fuel in the furnace towards the end of the interval between two successive chargings of the coal.

Accepting this as an approximately true view of the outward and visible sequence of events in the furnace, it is at once evident that we have to deal with at least two distinct cases of combustion, namely (1) that of solid carbon in the lower layers of the fire, and (2) that of the combustible "volatiles" (gases and vapours) in or above the upper layers.

THE COMBUSTION OF SOLID CARBON

Although the combustion of solid carbon has been studied by chemists for upwards of a century, there is still no general agreement among them as to what is the immediate product of the action of oxygen upon it.

In view of the fact that a diamond burns when strongly heated in oxygen forming carbon dioxide *without any visible flame*, it was formerly almost universally believed that such is the initial interaction, the monoxide subsequently resulting only when the primary product comes in contact with an excess of incandescent carbon, thus:—

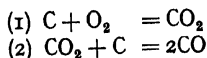

The correctness of this view, which is still very prevalent in technical literature, was challenged in 1872 by the late Sir Lowthian

COAL AND ITS SCIENTIFIC USES

Bell who, as the result of his classical investigations upon the chemical phenomena of iron smelting, advanced some very ingenious, if not altogether conclusive, arguments in support of his opinion that "carbon monoxide and not carbon dioxide is the chief, if not the exclusive, and immediate action of the hot blast on the fuel" (*i. e.* on the coke) in the blast furnace.

In the year 1887 C. J. Baker made experiments to ascertain the nature of the gases produced by heating carbon which had previously absorbed oxygen at low temperatures. He found that whereas *moist* oxygen which had been absorbed at -12° C. was evolved as carbon dioxide at 100° , the effect of *thoroughly drying* the materials by means of phosphoric anhydride was to cause the gas to be retained until a temperature of 450° was reached, when it was evolved chiefly as carbon monoxide. Hence he concluded that carbon is burned directly to the monoxide by absorbed oxygen.

A year later, H. B. Baker,¹ following upon the discovery of H. B. Dixon that a mixture of perfectly dry carbon monoxide and oxygen cannot be exploded in a eudiometer by an ordinary electric spark, whereas the presence of even a trace of moisture is sufficient to determine an explosion, found that when highly purified carbon is strongly heated in a closed vessel in *well-dried* oxygen, there is no sign of the glow or scintillation which is always produced in similar circumstances when *undried* oxygen is employed, and that the resulting gases always consist of both the monoxide and the dioxide, even when there remained a considerable excess of unused oxygen. In a further series of experiments he proved that although pure carbon dioxide, thoroughly dried over phosphoric anhydride, is not reduced by charcoal at bright red heat (provided always that the presence of moisture is rigidly excluded), the monoxide is chiefly produced when the same charcoal is similarly heated in dry oxygen, as the following analyses of the resultant gases showed:—

		Charcoal heated to redness in Oxygen dried over Phosphoric Anhydride for—			
		1 Week.		2 Weeks.	
Percentage Composition of Resulting Gases	}	CO ₂	5.0	1.7	2.2
		CO	40.0	39.5	27.8
		O ₂	55.0	58.1	70.5
		Ratio CO/CO ₂	8.0	16 to 18	

¹ *Phil. Trans.*, 1888, 170, A., 571.

THE COMBUSTION OF COAL

Baker, therefore, concluded (1) that moisture facilitates the oxidation of carbon, and (2) that "carbon burns first to carbon monoxide."

This new evidence was at the time accepted as conclusive by most British chemists, but when in 1891 Mendeljeff in his well-known *Principles of Chemistry* (English Ed. Vol. I. p. 388) adopted the older view that "the first product of the combustion of charcoal is always carbonic anhydride and not carbonic oxide,"¹ the controversy was reopened. The Russian chemist seems to have based his opinion upon the results of a series of experiments published by Lang in the year 1888² in which oxygen (*undried*) was passed at different regulated velocities through a glass tube packed with purified gas carbon maintained in a furnace at 500° C., at which temperature Lang asserted that carbon does not reduce its dioxide. From the following results it will be seen that the proportion of carbon monoxide found in the exit gases diminished with the stream velocity, until in one experiment with a very slow stream it entirely disappeared. Lang ascribed the formation of the monoxide in the experiments with the faster gas streams to the occurrence of local heating which, he argued, was sufficient to effect some reduction of the dioxide.

TABLE XLIV
LANG'S FIRST SERIES OF EXPERIMENTS

Time required to collect 100 c.cs. of Gases.	Percentage Composition of the Resulting Gases.		
Minutes.	CO ₂ .	CO.	N ₂ .
2	89.4	8.4	2.2
4	90.0	7.8	2.2
10	90.4	7.2	2.4
20	91.4	6.1	2.5
25	92.5	5.3	2.8
60	94.3	3.0	2.7
240	96.2	nil	3.8

In a second series, Lang passed a mixture (*undried*) containing

¹ It may be noted that this statement is repeated on p. 423 of the third English edition published in 1905, and on p. 421 of the same edition it is also stated that carbonic oxide "is formed whenever the combustion of organic substances takes place in the presence of a large excess of incandescent carbon; the air first burns the carbon into carbonic anhydride, but this in penetrating through the red-hot charcoal is transformed into carbonic oxide, CO₂ + C = 2CO.

² *Zeit. Phys. Chem.* (1888), p. 161.

COAL AND ITS SCIENTIFIC USES

77.7 per cent. of oxygen, 18.5 per cent. of carbon monoxide, and 3.8 per cent. of nitrogen at different velocities over purified carbon at 500° C. with the object of ascertaining (1) whether with a slow stream, and in the absence of local heating, the oxygen could be directly transformed into its own volume of carbon dioxide without increasing the proportion of monoxide in the flowing gases, and if so, then (2) what would be the effect of increasing the velocity of the gases until the local heating was sufficient to make the carbon glow. The results observed in three groups from experiments are shown below:—

TABLE XLV
LANG'S SECOND SERIES OF EXPERIMENTS
Temperature = 500° C.

	Time required to collect 100 c.c.s. of Gases.	Percentage Composition of the Resulting Gases.			Observations.
	Minutes.	CO ₂ .	CO.	N ₂ .	
Group 1.	120	78.0	18.3	3.7	<i>No local heating.</i> No change in CO content; O ₂ replaced by CO ₂ .
	150	77.9	18.4	3.7	
Group 2.	1	71.2	24.7	4.1	<i>No visible flame.</i> Increase in CO due to reduction of CO ₂ by C.
	1	70.8	25.0	4.2	
	20 secs.	39.6	56.4	4.0	
Group 3.	10 secs.	86.4	9.5	3.8	<i>Carbon glowed.</i> Flame of CO visible.
	5 "	88.4	8.0	3.6	

Assuming that carbon does not appreciably reduce its dioxide at 500° C., Lang claimed to have proved that in the burning of carbon the formation of the dioxide precedes that of the monoxide ("durch das Zusammentreffen des Sauerstoffs mit der Kohle entsteht zuerst Kohlendioxyd").

H. B. Dixon subsequently repeated and criticised Lang's principal experiments,¹ finding that some monoxide, as well as the dioxide, is always produced when oxygen is passed over purified coke at 500° C. no matter how slow the gas stream may be, although it was impossible to say that no local heating occurred in the experiment.

¹ *Trans. Chem. Soc.* (1899), **75**, p. 630.

THE COMBUSTION OF COAL

TABLE XLVI

H. B. DIXON'S EXPERIMENTS ON THE ACTION OF OXYGEN UPON COKE
AT 500° C.

No.	100 c.cs. of Gas collected in	Percentage Composition of the Product.			
	Minutes.	CO ₂ .	CO.	O ₂ .	N ₂ .
1	3·5	80·83	16·7	—	2·99
2	23	87·52	9·48	0·25	2·74
3	120	96·38	1·42	0·26	1·93
4	240	96·52	0·41	0·21	2·17

He, therefore, considered that his experiments threw doubt on the validity of Lang's conclusions, and that whereas Baker's work had greatly added to the weight of evidence in favour of the view that carbon burns in the first instance to carbonic oxide, it must be admitted that a decisive proof is still required.

Whilst such experiments left the main issue still undecided, so far as *solid* carbon is concerned, H. B. Dixon was able, during his researches upon gaseous explosions, to obtain conclusive evidence as to the primary formation of the monoxide when *gaseous* carbon (as in the form of cyanogen C₂N₂) is burned, inasmuch as he showed not only that the rate at which a wave of detonation passes through a mixture C₂N₂ + O₂ is greatly in excess of the corresponding rate for a mixture C₂N₂ + 2O₂, but that in the latter case half of the oxygen is absolutely inert in the wave, and only combines slowly with the carbon monoxide (the initial oxidation product) as the gases cool down in the rear of the wave.

In view of the fact that the molecular heat of combustion of cyanogen, when burnt completely to carbon dioxide, is 259·6 K.C.Us., whereas if burnt to the monoxide it would only be 123 K.C.Us., it might be expected that the rate of explosion for the mixture C₂N₂ + 2O₂ would be much higher than that for C₂N₂ + O₂ if gaseous carbon is primarily burnt to carbon dioxide in the wave. The exact opposite is, however, the case, as the following figures show:—

Mixture.	Rate of Detonation Metres per Second.	
(1) C ₂ N ₂ + O ₂	2728	}
(2) C ₂ N ₂ + O ₂ + O ₂	2321	
(3) C ₂ N ₂ + O ₂ + N ₂	2398	

Note that in (3) the N₂ retards the wave somewhat less than does the second O₂ in (2).

COAL AND ITS SCIENTIFIC USES

These facts, together with the observations of Smithells and Ingle that the interconal gases of an ordinary aërated cyanogen flame contain CO and CO₂ in the volumetric ratio 2 : 1,¹ leave no room for doubt but that the combustion of the *gaseous* carbon in cyanogen occurs in two well-defined stages involving the successive formation of CO and CO₂, namely :—

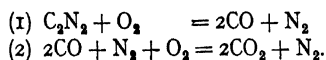

But the interaction of oxygen and a gas is a simple molecular transaction compared with the complex conditions prevailing when oxygen is brought in contact with a solid. For whereas the one case involves the simultaneous collision of a limited number (often only two) of molecules, in the other is an interaction between a highly condensed layer of gases at the surface and in the interstices of a porous solid of great molecular complexity. Moreover, the combustion of solid carbon is further complicated by the fact that, at or near the temperature when the oxidation just begins, the reversible change $2\text{CO} \rightleftharpoons \text{C} + \text{CO}_2$ also comes into play, and at somewhat higher temperatures carbon monoxide itself burns, if there be a sufficient supply of oxygen.

Within recent years the subject has been thoroughly re-investigated by Rhead and Wheeler over a range of temperature extending from 100° up to 900° C.² A preliminary series of experiments, in which either air, or oxygen, was circulated over highly purified wood-charcoal maintained at various selected constant temperatures between 250° and 500° C., failed to afford any conclusive evidence of the *exclusive* primary formation of either the monoxide or the dioxide, and led to the conclusion that both are produced *simultaneously*.

Further investigation over a much wider range of temperature afforded strong presumptive evidence in favour of the view that neither the one nor the other of the two oxides is initially formed, but that both are *simultaneously* produced as the result of the decomposition of an unstable "physicochemical complex," C_xO_y, which (according to this theory) must be regarded as the immediate and initial product of the action of oxygen upon carbon.

It may at once be admitted that not only does this new view of the matter reconcile a good many well-established facts which

¹ *Trans. Chem. Soc.*, 1892, **61**, p. 216.

² *Ibid.*, 1912, **101**, 846; and 1913, **108**, 461.

THE COMBUSTION OF COAL

otherwise would appear conflicting, but also that it accords well with the results of recent investigations upon the interactions of gases and hot surfaces in general. And whilst it would perhaps be premature to accept it as a final explanation, in the sense of its having been completely proven, it may be adopted for our present purpose as being the best available working hypothesis.

Such a simultaneous production of both oxides of carbon by the decomposition of a complex C_xO_y , when oxygen impinges upon the incandescent coke in the undermost layer of a furnace, would probably be accompanied by a rapid attainment and adjustment of a mobile equilibrium in the reversible system,

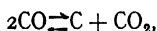

in consonance with the temperature in each successive layer as the mixed gases ascend through the fire. Also, and especially in such regions where the atmosphere in the spaces between the porous coke masses contains free oxygen, some combustion of carbon monoxide may occur, in which case the aforesaid equilibrium must be continuously adjusting itself, both to variation in the relative concentrations of the two oxides of carbon, as well as to the temperature changes. Consequently, the lower region of the fire must be the seat of a complex play of chemical forces which, however, may be regarded as always subject to the laws governing the attainment of mobile equilibrium in the reversible system formed by carbon and its two oxides.

THE REVERSIBLE SYSTEM $2CO \rightleftharpoons C + CO_2$

The investigation of the effects of temperature and pressure upon equilibrium in this system was also carried out very thoroughly by Rhead and Wheeler,¹ whose work in this connection must be acknowledged as having surpassed in point of carefulness and accuracy that of any previous investigators.

According to Le Chatelier's extension of Van't Hoff's well-known principle of mobile equilibrium in such a system, any change in the factors of equilibrium (*e. g.* active masses, pressure and temperature) from outside must be followed by a reverse change within the system. Thus, for example, (1) inasmuch as any change in the direction $2CO \rightarrow CO_2 + C$ is accompanied by a decrease in volume, an increase in pressure at any given temperature will cause a decrease in the "equilibrium" proportions of carbon

¹ *Trans. Chem. Soc.*, 1910, **97**, 2178; and 1911, **99**, 1141.

COAL AND ITS SCIENTIFIC USES

monoxide, and *vice versa*; also (2) inasmuch as any change in the said direction must be exothermic, an increase in temperature at any given pressure will cause an increase in the "equilibrium" proportion of carbon monoxide.

The law governing equilibrium in such a reversible system may be expressed by the following general formula:—

$$500 \int L \frac{dT}{T^2} + (N' - N) \log_e P + \log_e \frac{c_1^{n_1} c_1'^{n_1'}}{c_2^{n_2} c_2'^{n_2'}} \dots = K.$$

where

L = the total heat of the reaction at the absolute temperature T,
P = the pressure in atmospheres,

N and N' = the number of gaseous molecules in the left and right hand side respectively of the equation,

n_1, n_1' and n_2, n_2' = the number of molecules of the different gases participating in the reaction,

c_1, c_1' and c_2, c_2' = the corresponding concentration (active masses).

Thus, in the particular case of $2\text{CO} \rightleftharpoons \text{C} + \text{CO}_2$ under discussion, assuming L to be constant and equal to 39 K.C.Us. at all temperatures, and P to be 1 atmosphere, the equation becomes,

$$\frac{19500}{T} + \log \frac{c_1^2}{c_2} = K,$$

where c_1 and c_2 represent the concentration of the CO and CO_2 respectively.

According to Rhead and Wheeler's results, the value of K progressively increases from 19.85 at 800° C. (1073° A.) to 20.17 at 1100° C. (1373° A.), which circumstance may be ascribed to some decrease with temperature of the value of L, consequent upon a corresponding change in the specific heats of the two sides of the system. Or if constants be introduced into the equation to allow for this, it may be written in the form:—

$$\frac{1}{2} \frac{38055 + 2.02 T - 0.0031 T^2}{T} + \log_e P + \log_e \frac{c_1^2}{c_2} = 18.75,$$

from which the relative concentrations c_1 and c_2 corresponding to any particular absolute temperature or pressure, P, may be calculated.

According to Rhead and Wheeler's experiments, the velocity at which carbon dioxide is reduced by carbon at temperatures

THE COMBUSTION OF COAL

above red heat is always many times (*e. g.* at 850° C. 166 times) faster than that at which CO is dissociated at the same temperature. The condition of equilibrium, when P (*i. e.* the combined partial pressure of the CO and CO₂) = 1 atmosphere, was found experimentally to vary with the temperature as follows:—

Temperature ° C.	Relative Percentages of CO ₂ CO.	
850 . . .	6·23 . . .	93·77
900 . . .	2·22 . . .	97·78
950 . . .	1·32 . . .	98·68
1000 . . .	0·59 . . .	99·41
1050 . . .	0·37 . . .	99·63
1100 . . .	0·15 . . .	99·85
1200 . . .	0·06 . . .	99·94

whilst the variations with pressure at 1000° C. was found to be as follows:—

Pressure Atmos.	Relative Percentages of CO ₂ CO.	
3·78 . . .	3·17 . . .	96·83
2·67 . . .	2·18 . . .	97·82
1·14 . . .	1·17 . . .	98·83
0·66 . . .	0·65 . . .	99·35

and at 1100° C. :—

Pressure Atmos.	Relative Percentages of CO ₂ CO.	
3·65 . . .	0·92 . . .	99·08
2·25 . . .	0·60 . . .	99·40
1·33 . . .	0·35 . . .	99·65

Supposing, for the moment, that the time required for the attainment of equilibrium in the system $2\text{CO} \rightleftharpoons \text{C} + \text{CO}_2$, at such temperatures (say 1000° C. and upwards) as prevail in the lower layer of a furnace fire, is comparable with the time during which the upward flowing gases are actually in contact with the incandescent carbon, the *net* immediate result of the combustion will, for all practical purposes, be CO and not CO₂. And inasmuch as the rate at which CO is dissociated into C and CO₂ at lower temperatures (say 850° to 1000°) is many times less than that at which the reverse change occurs, the carbon monoxide formed in the first instance will practically all survive as such unless and until it meets and is burnt by a secondary oxygen supply. That this is

COAL AND ITS SCIENTIFIC USES

so in practice will be seen when Karl Wendt's experiments upon the action of air upon carbon in gas-producers are discussed in a later chapter (*vide* Chapter XVII).

We are, therefore, justified in concluding that in the lower layers of the furnace, where the incoming "primary" air meets the incandescent coke formed by the distillation of the raw coal in the upper layers, there probably results very rapidly a mixture of CO and CO₂ in nearly the equilibrium proportions corresponding to the prevailing temperature, and to the partial pressures of these gases, and that at 1200° and upwards CO will constitute nearly 99 per cent. of the total oxides of carbon present.¹ Also, that this large proportion of CO will survive as the products ascend the fuel bed, until the further oxygen supply required for its combustion is met with.

It thus would appear that the fuel bed in most types of coal-fired furnaces acts primarily as a "gas-producer," and, judging from the results of practical tests recently carried out by American investigators upon a 6-in. fuel bed, the atmospheric oxygen drawn in through the grate is all used up within the lower 4 in. of the fire. The zone of highest temperature (1200° to 1500° C. according to the "draught") was found to be usually about 3 in. to 5 in. above the grate, and the composition of the gases in it was practically independent of the rate at which the air was drawn or forced through the fuel bed, an increase in the draught merely increasing the rate at which the carbon of the coke was gasified and raising the maximum temperature of the bed.

To obtain the best results with an ordinary bituminous coal it is usually not necessary to operate with a thicker fuel bed than 6 in., nor is it desirable to consume *within* such a bed more than about half the oxygen required for the *complete* combustion of the total coal substance. The hot gases issuing from the top of the bed will usually contain, say, between 20 and 40 per cent. of combustible constituents (carbon monoxide, hydrogen, methane and other hydrocarbons) but practically no oxygen; to burn completely these combustible gases and vapours it is necessary to introduce *over* the fuel bed an additional air supply (the "secondary" air), preferably in thin streams of high

¹ It is not suggested that an absolute state of equilibrium in the system $2\text{CO} \rightleftharpoons \text{C} + \text{CO}_2$ is ever actually attained in practice, but only that it is so nearly approached as to warrant the views here expressed. Thus, for example, it has been proved that at 1300° C. a contact of 4 seconds of the gases with the incandescent carbon is sufficient to establish very nearly an equilibrium in the system.

THE COMBUSTION OF COAL

velocity, and this "secondary" air supply may advantageously be preheated.

DISTILLATION OF THE COAL IN THE UPPER LAYERS OF THE FIRE

The mean temperature in the upper region of the fire during the distillation of each successive charge of raw coal is difficult to estimate, but it may reasonably be supposed to be at some point intermediate between 600° and 1000° C.

The following table, compiled from the results of distillation tests at 800° C. upon a series of typical British coals carried out in 1909 under the direction of the late Professor E. J. Constam, at the Zürich Prüfungsanstalt für Brennstoffe,¹ will give an approximate idea of the proportionate yields of coke, gas, tar, water, etc., obtained at that temperature, and the heat balance of the process.

TABLE XLVII
RESULTS OF DISTILLATION TESTS AT 800° C. (CONSTAM)

	100 Parts Dry Ash-free Coal yielded.				Heat Balance Expressed as Percentages of Net Cal. Value of the Coal.		
	Coke.	Gas.	Tar and Pitch.	Water.	Coke.	Gas.	Tar and Pitch.
Notts { Bright . .	59·7	21·2	9·3	9·5	61·3	22·7	10·0
{ Best Hard . .	63·2	19·9	10·6	5·8	64·1	20·2	11·3
Lancs, Trencherbone	63·1	21·2	12·0	3·2	61·7	22·8	12·4
Durham { Hutton . .	69·2	17·9	9·7	3·0	65·3	22·1	9·7
{ Low Main . .	65·7	17·6	11·7	4·8	63·7	20·6	11·7
Yorks, Barnsley . .	70·0	14·6	8·5	6·6	70·4	18·3	8·9
S. Wales, Nixon's Navigation . .	80·9	11·5	4·5	2·8	76·7	16·9	4·3

Taking then the case of a steam coal of the Barnsley type, yielding on distillation in the upper part of the fire (say) 70 per cent. of its energy as coke, 20 per cent. as gas, and the remaining 10 per cent. as other volatile matter (tar and pitch), and assuming that in the lower part of the fire the carbon in the coke is converted by the primary air supply into CO₂ and CO in the ratio 10 : 90, then it may be shown that, of the total energy of the coal, only

¹ Constam and Kolbe, *Journ. für Gasbeleuchtung*, Nr. 36, 4 Sept., 1909.

COAL AND ITS SCIENTIFIC USES

38.5 per cent. would be liberated in the lower part of the fire, the liberation of the remaining 61.5 per cent. being dependent upon the combustion of gaseous and volatile matter by the "secondary" air supply in or above the upper layers of the fire. Hence the great importance of so regulating and distributing this secondary supply as to ensure maximum efficiency of combustion of the gases and vapours in the furnace.

THE COMBUSTION OF HYDROCARBONS

Without attempting to discuss in any detail the question of the mechanism of gaseous combustion, it may at this juncture be well to refer to one or two features which recent investigations have shown must be taken into account. There is not much in the combustion of either hydrogen or of carbon monoxide which calls for special comment in this connection, except perhaps (1) that the ignition temperature of moist carbon monoxide in air (644° to 658° C.) is somewhat higher than that of hydrogen (580° to 590° C.), and (2) that for flames of a given size carbon monoxide radiates 2.4 times more energy per unit of volume of gas burnt than does hydrogen, a circumstance which would partly explain the generally reputed superiority of carbon monoxide to hydrogen as a "furnace gas."

In the case of hydrocarbons, however, it is necessary to lay stress on the fact that their combustion is a complex process involving a series of well-defined stages. For, according to the author's researches,¹ the slow combustion of a hydrocarbon such as methane, at temperatures below the ignition point, may be regarded as involving successive entries of oxygen atoms into the molecule forming "hydroxyl" groups, the complexes thus formed either undergoing further similar oxidation or decomposing into more stable molecules, according to circumstances. Thus methane is oxidised at temperatures between 400° and 500° as follows:—

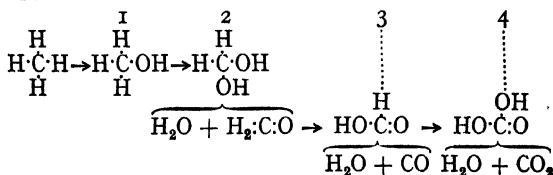

¹ Details of these researches were published in a number of papers in *The Journal of the Chemical Society* during the years 1902-6 inclusive.

THE COMBUSTION OF COAL

The initial stage involves the formation of *methyl alcohol* (stage 1), which is then further oxidised to an unstable dihydroxy compound, which immediately breaks up into steam and formaldehyde (stage 2). The latter is subsequently oxidised *via formic acid* (stage 3), which may partly break up into CO and H₂O, to the highly unstable *carbonic acid* (stage 4), which at once breaks up into CO₂ and H₂O. According to this view steam and oxides of carbon are never the *immediate*, but always the *remoter*, products of the successive oxidation stages.

At temperatures above the ignition point, as in ordinary flames, the formaldehyde produced by decomposition at stage 2 is itself so rapidly resolved by heat into carbon monoxide and hydrogen that in all probability the final stages of the process are concerned only with the independent oxidations of these gases, thus:—

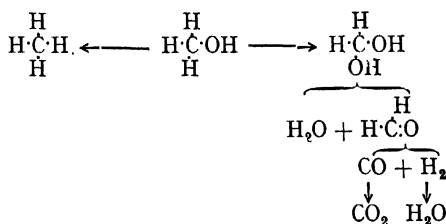

The complete combustion of such gases as carbon monoxide, hydrogen, methane, ethylene, which are generated within the fuel bed, presents no great difficulties, provided that the secondary air supply be both sufficient (but not excessive) in quantity and is properly distributed. The flooding of the furnace with an excessive supply of cold air is, however, to be avoided, inasmuch as it is calculated to dilute and cool down the interacting gases to a point which either stops or greatly retards combustion; and in hand-fired furnaces, where the fuel is thrown in at intervals through the open door, it is a prolific cause of loss "by incomplete combustion," the unburnt gases being carried up the chimney to the accompaniment of black smoke. Such losses may, however, be largely prevented by good furnace design combined with mechanical stoking arrangements, whereby the fuel is introduced continuously and the air supply can be so regulated as to maintain as nearly as possible constant conditions in the space immediately above the fuel bed.

COAL AND ITS SCIENTIFIC USES

BLACK SMOKE AND ITS PREVENTION

The combustion of the heavier hydrocarbons which constitute the tarry vapours produced by the distillation of the coal is a much more difficult matter, inasmuch as their more complex molecular constitution renders them not only more resistant to oxygen attack, but also prone, under the roasting influence of heat, to form still denser molecular aggregates by a series of internal condensations. Without doubt the production of the mixture of soot and dense hydrocarbons which constitute black smoke is largely due to this circumstance. The best way of counteracting it is to ensure a uniform supply and distribution of "preheated" air, so as to keep the interacting gaseous medium well above the ignition point of the tarry vapours it contains, and to ensure that all parts of it are sufficiently, though not excessively, supplied with the necessary oxygen for the maintenance of vigorous combustion. Also, devices which will cause the burning mixture to impinge on incandescent firebrick surfaces in the furnace (see "Surface Combustion"), thereby accelerating combustion, will undoubtedly minimise, even if it does not altogether prevent, smoke production.

It is obvious that, so long as a coal is "free-burning," the smaller the amount of volatile matter it contains the less will be its liability to cause smoke, and, inasmuch as smoke production is always a sign of incomplete combustion, the more efficiently can it be burnt. Hence arises the good reputation of the celebrated semi-bituminous Welsh "steam coals," containing from 10 to 15 per cent. of volatile matter, which burn almost smokelessly. As, however, such smokeless coals are only available in certain favoured localities, it has been frequently suggested that, as a good means of preventing smoke, suitable bituminous coals might be submitted to a preliminary process of expelling or decomposing their smoke-producing constituents by low temperature distillation in a separate apparatus before being burnt in boiler furnaces and the like. And if such a process could be carried out economically so as to yield "semi-coke" of sufficient strength, the problem of boiler firing with solid fuel would be much simplified. Even then, however, the achievement of really efficient combustion would still depend upon the proper regulation and distribution of both primary and secondary air supplies, and the maintenance of uniform conditions in the furnace. And for this purpose, both

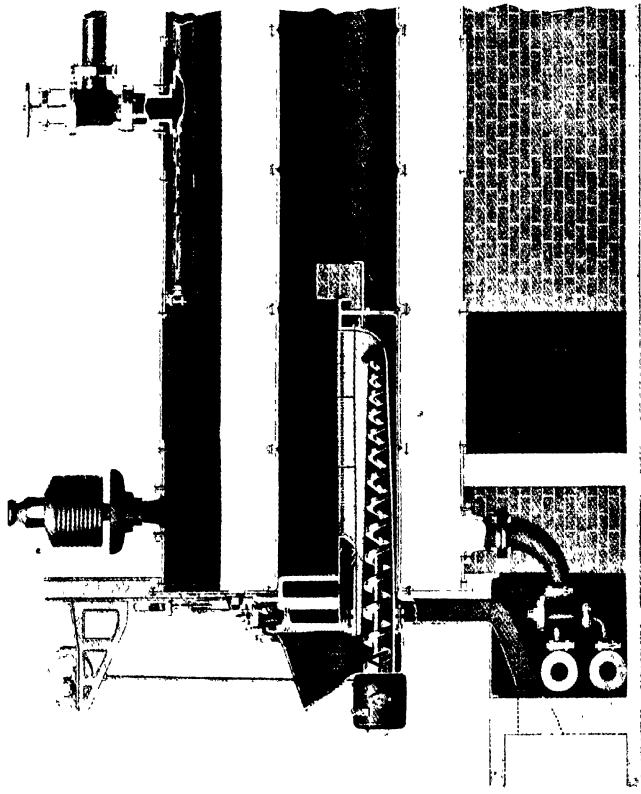

FIG. 21.—Underfeed Stoker (Longitudinal Section).

THE COMBUSTION OF COAL.

a good draught and effective means of regulating it, are absolutely essential as a prime condition of success.

In hand-fired boiler furnaces, and especially when "forcing" tactics are not necessary, a good plan is to charge the raw coal on to the dead plate just within the door in order that it may there undergo a short preliminary "low temperature" distillation before it is distributed over and burnt in the grate. The heavier volatile matter so expelled, if properly admixed with air admitted above the grate, will be carried forward and burnt over the incandescent fuel bed, and when near the fire-bridge the gases will encounter a further supply of air. Also, the proper spreading of the fuel on the fire should be attended to; a good plan is to fire alternately to the back and front, or to the right and left side of the grate.

In the case of large boiler installations, however, there can be no question of the superiority over the ordinary hand-firing of a well-designed mechanical stoking arrangement with a moving chain grate, for not only do such devices ensure a continuous feed of the fuel, but they also allow of a much better control and uniform distribution of the air supplies, and keep the fuel bed in regular movement, all of which contribute to the maintenance of uniformity of conditions and high temperatures in the furnace.

"Underfeed" Stoking.—Mention may here be made of the system of "underfeed" stoking for boiler furnaces invented some years ago by E. W. Jones, of Portland, Oregon, U.S.A., whereby coal, instead of being thrown on to the top of the fire in the usual manner, is thrust upwards into it from below, by means of a special mechanical arrangement, in such a way that the preliminary distillation of the raw fuel takes place in the lowest regions of the fire, and the products resulting therefrom mix with streams of hot air and are completely burnt as they rise through the hottest regions of the fire.

The principle of such underfeed stoking, as applied to the flue of a Lancashire boiler, is illustrated in Figs. 21 and 22. The raw fuel is mechanically fed from a hopper, or other suitable receptacle, into a horizontal trough, A, along which it is pushed by means of a screw or worm conveyer. The neck, B, of this trough, in which the fuel is first ignited, expands upwards until it opens out on to the sloping terraced grate, CC, of the furnace, through the bars of which the air needed for combustion is admitted. Also, there is an air opening or twyer, DD, where the top of the neck opens out on to the grate. The air needed for

COAL AND ITS SCIENTIFIC USES

combustion is introduced through the passage, EE, below the grate, and is thus to some extent preheated before it reaches the fuel. Distillation of the raw fuel commences in the neck of the feeding trough just a little below the level where the fuel is ignited in the streams of air which enter through the openings, DD, and it continues as the reacting mass is slowly pushed upwards on to the grate where eventually the carbonised residue is completely

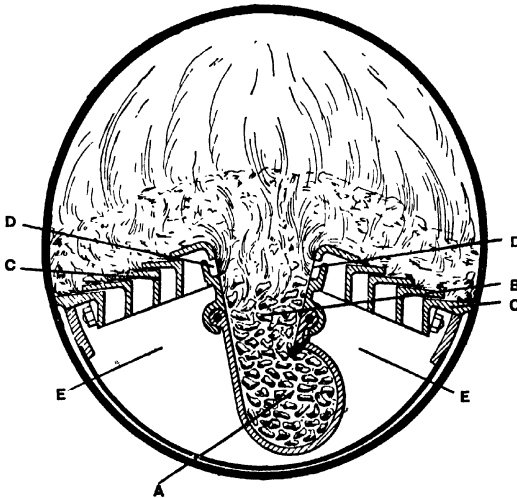

FIG. 22.—Diagram of Underfeed Stoker (Cross Section).

burnt by the air supplies which enter between the bars of the sloping grate.

It will thus be seen, not only that the fire always presents an incandescent highly radiating surface to the flue plate, but also that the raw fuel is partially carbonised in the lower regions of the fire in such a manner that its smoke-producing constituents are largely decomposed and burnt in contact with the incandescent coke as they rise admixed with hot air through the middle and upper regions of the fire. This is certainly a more scientific method of burning raw coal in a boiler furnace than that usually adopted.

THE FIRING OF FURNACES WITH COAL DUST

Within recent years various attempts have been made to devise systems for burning finely pulverised coal in boiler and other

THE COMBUSTION OF COAL

furnaces. It is, of course, well known that a mixture of finely divided coal dust and air is explosive, and there can be no doubt but that in burning coal the excess of air actually required will diminish with the fineness of division of the fuel and the intimacy of its admixture with air. The rapidity and efficiency of the combustion will increase the more nearly the system approaches the homogeneity of a properly proportioned gas-air mixture.

So far as boilers are concerned, some details of one successful device will be given in the next chapter. With regard to other types of furnaces, a system of burning powdered fuel was proposed by Crampton¹ in which the coal was pulverised until it passed through a 30-mesh sieve and was fed into the furnace by an injector, air being supplied in measured quantities by means of a fan so that intense heat was generated.

In recent years the system seems to have made marked progress in America and has been applied to cement kilns and reverberatory furnaces for metallurgical purposes. In 1906 the attention of the metallurgical world was again drawn to the possibilities of utilising pulverised coal in reverberatory furnaces by S. S. Sorensen, who showed, as the result of large scale trials, that the efficiency, as measured by the ratio of the ore to the fuel consumed, is considerably increased by the substitution of coal dust for ordinary grate firing. A further development was made by Shelby at Cananea, Mexico, in 1908, but both of these pioneers experienced troubles owing to the accumulation of ash in the flues and to interruptions in the coal-dust feed.

The next step forward is to be credited to technologists in the cement industry, whose experience brought out the necessity for drying the fuel and reducing it to an impalpable powder before burning it in their kilns. As the result of recent progress the difficulties referred to are now reported to have been overcome.

It is also stated in American journals that, with the adoption of improved charging methods, which are said to obviate fettling, the modern coal-dust-fired reverberatory furnaces are likely to compare favourably with the blast furnace in the copper industry. The coal is dried and reduced to a sufficiently fine state of division that it may be easily suspended and carried forward in the air blast as a practically homogeneous mixture. The air blast (which constitutes the "primary" air supply only) is operated at a pressure of from 8 oz. to 16 oz. per square inch.

A notable development of the earlier work of Sorensen and

¹ *Journ. Iron and Steel Inst.*, 1873, p. 91.

COAL AND ITS SCIENTIFIC USES

Shelby has been made by the Canadian Copper Co. who, in 1911 started operations with a reverberatory furnace, smelting roasted copper ore, 112½ ft. long by 19¾ ft. wide, with a slanting roof 9 ft. in height at the front end of the furnace, and 8 ft. at the flue end. The dried coal dust was fed from bins by automatic screw conveyers, the speed of which could be regulated. These screws carried the dust forward and dropped it into the burners about 2 in. from the point at which the nozzles entered the furnace. There were five such burners at the front end of the furnace each 5 in. in diameter, set 2 ft. above the slag line. The "primary" air supply was supplied as a low-pressure blast into which the pulverised fuel was fed and carried forward in a state of very fine division. The "secondary" air supply was sucked into the furnace through suitable openings in the end walls between the coal burners.

The coal as used contained:—

	Per cent.
Moisture	= 4·3
" Volatiles "	= 34·7
" Fixed Carbon "	= 55·4
Ash	= 9·45

and had a calorific value of 13,500 B.Th.U.s. per lb.

The combustion in the furnace is reported to have been very satisfactory; the flue gases contained:—

CO ₂ and SO ₂	= 12·3 per cent.
SO ₃	= 1·14 " "
CO	absent.

The average temperature of these products on leaving the furnace was 922° C. and 17 per cent. of the available heat was utilised in the furnace. The ratio ore : fuel obtained was 7·0 as compared with the usual 4·0 in grate-fired reverberatory furnaces.

A further development from the foregoing investigation was subsequently made by the technical staff of the Anaconda Co. (Washoe Reduction Works) who, as the result of their experience, have recently laid down the following conditions as essential for obtaining the best results:—

- (1) That the coal should be dried so that its moisture content is less than 1 per cent. before it is pulverised.
- (2) That it should be pulverised until 85 per cent. of it passes

THE COMBUSTION OF COAL

through a 200 mesh and 95 per cent. of it through a 100 mesh.

- (3) That the furnace shall be specially designed both as regards shape and proportions, and be suitably equipped with burners and feeding arrangements so that the relative deliveries of coal dust and air can be well controlled.
- (4) Special provision should be made for the periodic removal of the ash deposited in the flues at the far end of the furnace.

In the year 1916 trials were made of applying coal-dust firing to locomotive boilers and open-hearth steel furnaces, and it is evident that in America considerable developments of the system are likely to take place in the near future.

The reader is referred to the following papers for further information on the subject of these developments:—

- (1) "Use of Pulverised Coal in Metallurgical Furnaces," by James Lord in *Proc. Eng. Soc. of West Penn.*, October, 1913.
- (2) "Pulverised Coal as a Fuel," Anon. in *Eng. and Mining Journ.*, May 16, 1914.
- (3) "Coal Dust Fired Reverberatories at Washoe Reduction Works," by Louis V. Bender; also another paper on the same subject by D. H. Browne, of the Canadian Copper Co., in *Trans. Amer. Inst. Min. Eng.*, January 1, 1915.
- (4) Discussion of Papers on "Coal Dust Fired Reverberatories," in *Trans. Amer. Inst. Min. Eng.*, May, 1915.
- (5) "Anaconda Coal Pulverising Plant," by E. P. Matthewson, in *Eng. and Mining Journ.*, July 10, 1915.
- (6) "Pulverized Coal for Copper Smelting," by N. L. Warford, in *Min. and Eng. World*, November 6, 1915.
- (7) "Contribution to Symposium on Utilisation of Fuels in Metallurgy," by E. P. Matthewson, in *Inter. Engin. Congress*, 1915.
- (8) Kuzell (Pan American Scientific Congress, Washington), *Eng. and Mining Journ.*, 101, No. 7, 303, February, 1916.
- (9) "Developments in Smelting Practice of Anaconda Copper Mining Co.," *Eng. and Mining Journ.*, 102, No. 15, 635, 777, October 7, 1916.
- (10) *Engineering*, January 5, 1917 (E. Muhlfield, Amer. Soc. Mech. Eng., and J. W. Fuller, Amer. Iron and Steel Inst.).
- (11) W. L. Robinson (Seventh American Convention of Railway Fuel Association), *Eng. and Mining Journ.*, 100, No. 1, 19.

CHAPTER XI

THE PRINCIPLES GOVERNING COMBUSTION AND HEAT TRANSMISSION IN BOILERS

ALTHOUGH complete data are wanting for an exact estimate of the total coal annually consumed in the United Kingdom for steam-raising purposes, in the opinion of many competent judges it probably was not less than 40 per cent. of the total home consumption of 200 million tons in the year 1913. Moreover, according to figures deduced from the Report issued in 1912 of the Census of Production of the United Kingdom for 1907, it would appear that of the total nominal horse-power capacity (approximately 10 million H.P.) of engines in the United Kingdom in that year, at least 90 per cent. was contributed by steam installations, and there is no reason for supposing that this proportion has subsequently diminished in any material degree.

Such figures as the above will sufficiently indicate the present-day importance of the steam-boiler in relation to the general problem of fuel economy, and accordingly in this chapter the writer will endeavour to review briefly some of the factors which govern the efficiency of combustion and heat transmission in boiler installations.

It should, however, be understood at the outset, that the discussion of the purely mechanical aspects of boiler design and construction,¹ except incidentally and in so far as they may either serve to illustrate the application of general principles or embody the results of recent scientific investigations, is foreign to the purpose of the chapter, and therefore will not be entered into.

Taking the calorific value of a good steam coal as 13,000 B.Th.Us. per lb., and the thermal equivalent of one horse-power hour as 2564 B.Th.Us., it follows that were it possible by any means to transform the available energy of coal into mechanical

¹ For such particulars the reader is referred to the book on *Steam Boilers* written by Mr. W. Inchley, Lecturer in Engineering at University College, Nottingham (Edward Arnold London, 1912). He is also recommended to study Professor W. E. Dalby's *Steam Power*.

COMBUSTION AND HEAT TRANSMISSION

power without loss of any kind, a horse-power hour would be generated by the expenditure of no more than about one-fifth of a pound of coal. But even in the very best modern practice, whether of the largest steam turbines or of the most efficient gas-engine plants, it has not yet been found possible to obtain in regular running a horse-power hour from a smaller consumption than about one pound of coal, or say about five times the theoretical figure.

So far as steam installations are concerned, such a result was actually achieved in 1915 during the trial of the new 35,000 H.P. Parsons turbo-alternator at the Fisk Street Power Station in Chicago. Working with steam at 200 lb. gauge pressure and 200° Fahr. superheat, with a vacuum of 29 in., a shaft horse-power hour was developed for a steam consumption equivalent to 9600 B.Th.U.s., which (assuming a boiler efficiency of 75 per cent.) would be equivalent to a consumption of 1 lb. of coal of *net* calorific value 12,800 B.Th.U.s. per lb.

It may, however, be doubted whether in even the largest and most modern of British power stations the coal consumption averages throughout the year less than 2 lb. per horse-power hour generated, whilst for the country as a whole it has been estimated at as much as 5 lb.

Inasmuch, however, as a steam-power plant comprises both boiler and engine, it is necessary, in apportioning the losses, to discriminate between the two parts. And, inasmuch as the average efficiency of the best types of land boilers may be assumed to be about 75 per cent., the losses upon a good modern steam plant, consuming on the average no more than 2.0 lb. of coal per shaft horse-power hour generated, would be distributed somewhat as follows:—

	Per cent.	
Boiler	25	} Total = 90 per cent.
Engine, etc.	65	

If, however, the average coal consumption could be reduced to that actually realised during the Chicago trial of 1915, the losses would be:—

	Per cent.	
Boiler	25	} Total = 80 per cent.
Engine, etc.	55	

How the 25 per cent. lost at the boiler is made up may be judged from the following typical heat-balance of a trial of a marine

COAL AND ITS SCIENTIFIC USES

boiler fired with a good steam coal of *net* calorific value 13,800 B.Th.Us. per lb., containing 16·1 per cent. of volatile matter :—

	Per cent.	
<i>Heat transmitted to Steam</i>	75·0	
<i>Heat lost</i> { in burnt gases	18·2	} Total Chimney Losses 21·0
{ in unburnt gases	2·8	
{ by radiation and in ashes	4·0	
	100·0	

But whilst a total loss of no more than 25 per cent. may be considered as a criterion of good practice with a coal-fired boiler, it must be admitted that this figure is more often than not exceeded in every-day working, especially in cases where no attempt is made to establish some sort of scientific control in the boiler house. And judging from cases that have come under the writer's observation, losses amounting to as much as 35 or even 40 per cent. are by no means uncommon in cases where careless management prevails.

The principal causes of waste in boiler practice, some of which will be discussed in detail later on, may be classified as follows :—

- (a) bad selection of coal;
- (b) the use of an unsuitable "hard" water, which causes "scaling" in the boiler;
- (c) imperfect combustion of the fuel, due either to faulty stoking or to defects in the air-supply caused either by bad furnace design or by inadequate chimney draught;
- (d) excessive air-supply, as indicated by a low percentage of CO₂ in the chimney gases;
- (e) bad heat transmission, as indicated by an unduly high temperature of the products of combustion on leaving the boiler, which may be due either to faulty boiler design, or to scaling troubles, or to too low a velocity of the burnt gases through the boiler flues;
- (f) undue losses by "radiation," due to imperfect lagging of the boiler, or by "conduction" into the setting.

(a) Selection of Fuel.

According to the investigations of the late Professor E. J. Constan of the Zürich Prüfungsanstalt für Brennstoffe, the best steam-raising coals are those yielding between 16 and 23 per cent.

COMBUSTION AND HEAT TRANSMISSION

of "volatiles" at 900° C. referred to the "dry ashless" fuel. With coals yielding a higher percentage of such "volatiles," there is always a liability to an excessive loss on account of incomplete combustion, especially if the design of the furnace is faulty; and in the case of those yielding a lower percentage, an unnecessarily large excess of air must usually be supplied in order to maintain combustion at a rate sufficient to ensure rapid evaporation in the boiler, which means an excessive loss of sensible heat in the chimney gases.

These two points are well illustrated by a series of steam trials conducted by Professor Constam in conjunction with P. Schläpfer¹ in which fuels of different types and origin were burnt in the furnace of a hand-fired marine boiler. Each trial extended over eight hours, and the conditions were regulated so that as nearly as possible the same mean rate of evaporation was maintained throughout the whole series. The results which are tabulated in Table XLVIII may be commended to the reader's careful study, not only as bearing out the conclusion already referred to, but also as showing the general features of the combustion in such a hand-fired boiler evaporating water at the quite moderate rate of about 4.2 lb. per square foot of heating surface per hour. It may be pointed out that in Trials V and VI the heat losses by radiation, etc., are decidedly higher than in Nos. I to IV inclusive, a circumstance which seems unaccountable except on the supposition that the chimney losses were underestimated in Nos. IV and V.

In selecting a steam coal, not only should the calorific power and the percentage of volatile matter yielded when it is carbonised at 900° C. be taken into consideration, but also its free-burning properties, and the amount and character of its ash content. A large ash content is to be avoided, not only because it involves greater labour in stoking and cleaning the fire, but also, and especially if it be of a fusible character, because it may entail considerable loss of "unburnt carbon" at the grate and become a prolific source of "clinkering" troubles. These faults are accentuated when the boiler is worked under high draught.

It would be a good thing if the custom were to be established in Great Britain of basing contracts for steam coal on an agreed calorific standard, together with an agreed ash content. In the United States it is customary for the contract price of coal to be regulated with reference to certain stipulated figures for both

¹ *Zeit. des Vereines deut. Ingenieure*, 1909, p. 1857.

COAL AND ITS SCIENTIFIC USES

TABLE XLVIII

ZÜRICH STEAM TRIALS WITH DIFFERENT FUELS ON A HAND-FIRED MARINE BOILER

Trial No.	I.	II.	III.	IV.	V.	VI.
Description of Fuel.	Gas Coke.	Ruhr Coal.	Rhenish Coal.	Saar Coal I.	Saar Coal II.	Saar Coal III.
% Moisture in Fuel	5.28	2.07	3.93	1.73	3.88	5.42
% Ash in Fuel	9.05	6.21	9.24	7.57	11.84	7.44
C.	96.96	90.49	90.03	85.89	82.56	78.72
H.	0.72	4.19	4.13	5.39	5.26	5.40
S.	0.99	0.93	1.15	1.04	0.96	1.32
O. and N.	1.33	4.39	4.69	7.68	11.22	14.55
Volatiles	2.0	16.5	19.1	36.7	38.0	45.1
Heats of Combustion of Dry Fuel K.C.U.s. per kg. { Gross Net	8018 7979	8540 8313	8565 8342	8514 8223	8199 7915	7817 7525
Rate of Combustion of Fuel. Kg. Fuel per Hour	136	117	124	135.4	152.5	162.5
Steam Gauge Pressure. Kg./cm. ²	5.04	5.24	5.17	5.18	5.10	5.18
Lbs./sq. in.	71.7	74.5	73.5	73.7	72.5	73.7
Rate of Evaporation per Hour. (i) Kg. Water at 0° C.— Steam at 100° C.	1026	1057	1036	1066	1035	1039
(ii) Lbs. Water " from and at " 100° C.	2681	2764	2708	2787	2706	2716
. Ditto { per sq. m. } of Heating Surface { per sq. ft. }	17.1 4.15	17.6 4.27	17.3 4.20	17.8 4.32	17.2 4.18	17.3 4.20
% Composition of Chimney Gases { CO ₂ CO H ₂ CH ₄ O ₂ N ₂	9.63 0.17 — 0.04 11.05 79.11	10.57 0.21 — 0.11 8.72 80.34	10.30 0.61 — 0.03 9.06 80.00	10.42 1.70 — 0.70 7.56 79.79	10.40 0.65 0.18 0.11 8.55 80.11	10.42 2.22 0.60 0.10 7.47 79.19
Temperature of Chimney Gases ° C.	302°	303°	276°	297°	280°	306°
Air used for Combustion. Ratio Theoretical Air	2.11	1.72	1.76	1.58	1.69	1.57
% Heat utilised	71.0	75.1	73.7	67.4	65.3	62.5
% Heat Losses { in Burnt Gases in Unburnt Gases in Ashes by Radiation, etc.	21.6 1.4 4.1 1.9	18.1 2.8 3.0 1.0	16.2 3.8 3.4 2.9	15.9 11.0 2.9 2.8	15.8 5.7 3.8 9.4	15.7 13.8 2.4 5.6

COMBUSTION AND HEAT TRANSMISSION

calorific value and ash content. Variations within 2 per cent. on either side of the particular fixed calorific standard do not affect the contract price, but variations exceeding these limits involve a proportionate increase or decrease in the price. And, with regard to ash content, anything which does not exceed the agreed standard by more than two whole units per cent. does not affect the contract price, but if this neutral 2 per cent. margin is exceeded, then each successive unit per cent. by which it is so exceeded involves a steadily-increasing deduction in the price, according to a pre-determined sliding scale, of which the following may be quoted as an example :—

TABLE XLIX

	As Agreed.	No Change in Price up to.	Cents. per Ton to be deducted for the Higher Ash Content.				
			2.	4.	7.	12.	18.
Percentage Ash Contents {	5.0	7.0	7 to 8	8 to 9	9 to 10	10 to 11	11 to 12
	6.0	8.0	8 to 9	9 to 10	10 to 11	11 to 12	12 to 13
	7.0	9.0	9 to 10	10 to 11	11 to 12	12 to 13	13 to 14

(b) *Avoidance of an Unsoftened "Hard" Feed Water.*

The formation of "scale" of low heat conductivity on the tubes of a boiler is a prolific cause of heat losses and other serious derangements, especially in districts where the available supplies of water are naturally "hard." Hard waters are those which are more or less charged with "scale forming" mineral impurities such as calcium, magnesium, or ferrous bicarbonates, calcium sulphate, silica, or with salts such as the chloride, sulphate, or nitrate of magnesium which aid scale formation, especially at high boiler pressures and in the presence of iron salts, by secondary interactions such as the following :—

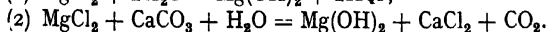
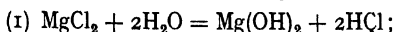

With regard to the commoner "scale forming" mineral constituents of natural waters, it may be said that whilst the "soft scale" deposited in feed water heaters and the like, where the temperature is below 100° C. is almost always composed of the carbonates of calcium and magnesium, the cementing material of the "hard scale" deposited on the boiler tubes is frequently

COAL AND ITS SCIENTIFIC USES

calcium sulphate, which is a particularly objectionable compound from this point of view. It must also be remembered that at high boiler temperatures the soluble calcium bicarbonate, $\text{CaH}_2(\text{CO}_3)_2$, or even the insoluble calcium carbonate formed by its decomposition, is liable to react with soluble magnesium sulphate producing insoluble calcium sulphate and magnesium carbonate with evolution of carbon dioxide.

Heat losses due to scale formation can be greatly diminished, if not practically eliminated, either (1) by softening the boiler feed water by some suitable chemical treatment, or (2) by maintaining in suspension the mineral impurities which would otherwise form the scale. And in all cases where the use of "hard" water cannot be avoided, one or other of these methods should be adopted in the interests of fuel economy. With regard to (2), additions to the feed water of vegetable extracts containing tannic acid or the like, or of graphite, are effectual in preventing its mineral constituents from forming an adherent scale on the boiler tubes.

Considerations of space preclude any attempt to describe the various systems of water-softening employed in this country, but inasmuch as it has been held by many competent judges that feed waters which have been softened either with caustic soda, or soda ash, and which therefore contain soluble sodium salts are particularly liable to cause "priming" (*i. e.* "foaming") in boilers, it is perhaps necessary to say that, whatever degree of truth there may be in such assertions, other factors, such as water area and steam space, pertaining to boiler design, are also involved.

(c) *Causes of Imperfect Combustion of the Fuel.*

The principal causes of incomplete combustion in a boiler furnace, apart from bad selection of fuel and careless stoking, are (1) faults in furnace design, causing the secondary air-supply to be either insufficient or wrongly directed, and (2) inadequate chimney draught, and of these (2) is usually the more frequent and serious.

For the complete combustion of 1 lb. of a bituminous coal containing:—

C = 86.0, H = 5.5, S = 1.0, N = 1.5, O = 5.0, and Ash = 7.0 per cent.

there would theoretically be required 135.2 cub. ft. of dry air

COMBUSTION AND HEAT TRANSMISSION

measured at 0°C . and 760 m.m. barometric pressure (= 142.6 cub. ft. at 15°C . and 760 m.m.) and the cooled products would contain 18.27 per cent. of carbon dioxide. But in actual practice it is never possible to burn coal perfectly on the grate of a boiler furnace with only this theoretical quantity of air, owing to the fact that with relatively large masses of a solid fuel, and with intervening fairly wide air-passages, the air-supply is never so intimately or homogeneously in contact with the combustible matter as it is in the case of an explosive mixture of gas and air

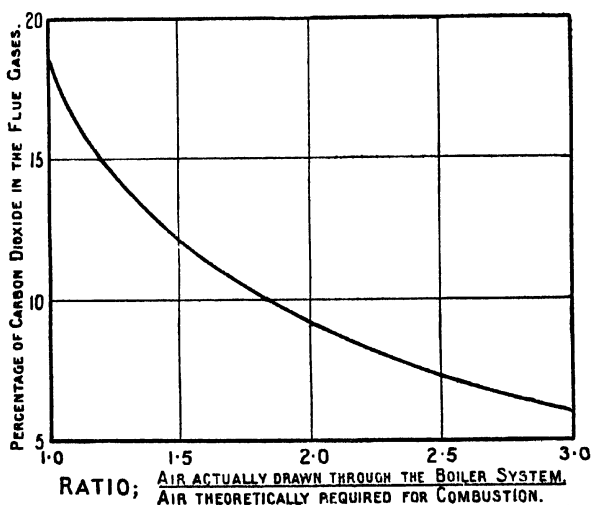

FIG. 23.—Curve showing the Relation between the Percentage of Carbon Dioxide in the Flue Gases and the Volume of Air drawn through the Boiler System.

in the cylinder of a gas engine at the moment of ignition. It would be considered exceedingly good boiler practice to burn completely a coal such as the one in question in no more than 1.5 times the theoretical quantity of air, in which case the cooled products would contain :—

$$\text{CO}_2 = 12.08, \text{O}_2 = 7.16, \text{N}_2 = 80.76 \text{ per cent.}$$

If, however, twice the theoretical quantity of air were drawn through the furnace, the chimney gases would contain :—

$$\text{CO}_2 = 8.99, \text{O}_2 = 10.66, \text{N}_2 = 80.35 \text{ per cent.}$$

COAL AND ITS SCIENTIFIC USES

If the ultimate chemical composition of a coal is exactly known, a curve may be drawn showing the relationship between the percentage of carbon dioxide in the chimney gases and the quantity of air (in terms of that theoretically required) drawn through the boiler system. Such a curve is shown in Fig. 23 for the particular coal in question.

It cannot be too often insisted upon that an adequate and easily regulated draught is a *sine qua non* of efficient combustion in a boiler, and inasmuch as land boilers usually rely entirely upon chimney draught, the proper design and dimensioning of the chimney and connecting flues in relation to the number and total capacity of the separate units in a boiler installation is a matter of prime importance.

It must also be borne in mind that a chimney is more than a mere duct for products of combustion; its function is to create a sufficient suction at the furnace to draw in the air needed to burn the fuel, and to discharge the products of combustion into the atmosphere at a sufficient height to render them reasonably inoffensive.

The force or intensity of the draught produced by a chimney is caused by the difference in the weight of the column of heated air in the chimney and that of a similar column of the external atmosphere, the heights of both columns being equal to the vertical distance between the fire grate of the boiler and the top of the chimney. In practice, however, part of the force of the draught is expended in overcoming the frictional resistance opposed by the chimney and its connecting flues to the flowing gases.

Certain empirical formulæ are usually employed by engineers for calculating both the draught and the maximum quantity of air which a given chimney will draw through the system per hour, thus for example :—

If d = the draught in inches of water,

h = vertical height of the chimney in feet above the fire grate,

t = atmospheric temperature in Fahr. degrees,

T = temperature of the chimney gases in Fahr. degrees,

E = effective area of the chimney, which for circular chimneys
= $A - 0.6 \sqrt{A}$ (Kent's formula), where A = least
internal area,

Q = maximum quantity of air in lbs. per hour which the
chimney will draw through the system,

COMBUSTION AND HEAT TRANSMISSION

then :—

$$d = h \left(\frac{7.6}{t + 460} - \frac{7.9}{T + 460} \right)^{1/2} \dots (1)$$

and $Q = 1000dE\sqrt{h} \dots (2)$

For the purposes of boiler calculations it may be taken that a cubic foot of dry air at 15° C. and 760 m.m. barometric pressure weighs 535 gr. or 0.0764 lb., and if it be also assumed that for the efficient combustion of 1 lb. of an average bituminous coal in the furnace at least 1.5 times the theoretical quantity of air, namely 1.5 × 136 = 204 cub. ft., will be drawn through the system, the maximum "coal-burning" capacity of a chimney of given height, area, and water-gauge draught may be calculated by means of the foregoing formula.

This "coal-burning capacity" is, however, again limited by the area of the grate, for it is obvious that the total area of the effective air-passages through the grate might be too small to allow of the maximum chimney capacity being actually attained. Also, the number of boilers connected with a given chimney, and the length of the connecting flues, introduce another limitation which must be taken into account. Hence the following empirical formula is sometimes employed for calculating the smallest internal chimney area A (square feet) required for a chimney of given height H feet to burn W pounds of coal per hour on a grate area G square feet, assuming that the horizontal distance between the fire-grate and the base of the chimney does not exceed 150 ft.,

$$A = \frac{G \times W \times C}{\sqrt{H}} \dots (3)^a$$

where C is a constant dependent upon the number of boilers connected with the chimney (C = 0.100 for 1 boiler, and 0.085 for 2 to 6 boilers).

But such formulæ as these do not, and indeed cannot, take into account another variable factor, namely, the character of the coal burnt and the thickness of the fire. For it is obvious that a thick fire, or one composed of a slack coal, will require a greater draught than a more normal one. Also, a caking coal or an anthracite would require a greater draught than a free-burning steam coal.

¹ From H. R. Kempe's *Engineers' Year Book*, to which the reader is referred for much valuable information regarding chimney designs.

^a From Inchley's *Steam Boilers* (Ed. Arnold) and Hutton's *Steam Boiler Construction* (Crosby, Lockwood & Son).

COAL AND ITS SCIENTIFIC USES

Thus, according to W. S. Hutton (*loc. cit.*), the total draught required to burn different kinds of coal varies as follows :—

Steam Coal	.	.	.	0·4 to 0·7 inches w.g.
Slack	.	.	.	0·6 to 1·1 " "
Semi-anthracite	.	.	.	0·9 to 1·2 " "
Anthracite	.	.	.	1·2 to 1·4 " "
Anthracite Slack	.	.	.	1·3 to 1·8 " "

Provided that the draught be adequate, it may be assumed that a chimney 150 ft. in height and of a sufficient area will burn up to 25 lb. per square foot of grate area per hour in a Lancashire boiler.

Next in importance to the adequacy of the draught to meet the maximum requirements of a boiler installation is the easy regulation of it at each separate unit, especially where hand-firing is adopted. In such a case it is obvious that the amount of secondary air required will be greater immediately *after* a charge of fresh fuel has been introduced, when the volatile combustible matter is being expelled from the coal at a great rate, than towards the end of the interval between two successive charges, and hence the importance of good control of the draught both by a damper in the flue leading to the chimney and by openings in the furnace door. Also, any variation in the load on the boiler will affect the amount of fuel burnt and therefore the draught required.

When a forced or induced draught is fitted to a boiler, it is, of course, possible to increase the rate of combustion of the coal on the grate, and so to obtain better results, provided always, however, (1) that a high furnace temperature is maintained, which implies that the furnace shall be of large capacity and well lined with fire-brick; (2) that the heating surface in the boiler itself is adapted to the higher rate of heat transmission (*q.v.*); and (3) that, if necessary, the heating surface shall be extended so as to cool down the burnt products sufficiently before they are discharged into the chimney, and this may often best be done by installing devices for either (1) heating the feed water, or (2) pre-heating the secondary air-supply to the boiler furnace, or (3) superheating the steam. One of the advantages of forced or induced draught is its easy regulation, but with induced draught losses may occur through in-leakages of air into the system. Provided that all the precautions referred to are taken, forced

COMBUSTION AND HEAT TRANSMISSION

or induced draught may be expected to lead to increased efficiency and greater elasticity under varying loads, but these advantages may be entirely nullified or even outweighed if the boiler itself is badly designed.

In the case of a large boiler installation, the adoption of mechanical stoking will nearly always pay, not merely as a labour-saving device, but as improving the conditions of combustion in the furnace and thereby increasing the heat efficiency of the system, and especially when low-grade coals are used. Such improved conditions are to be ascribed mainly to the fact that with mechanical stoking the coal is fed on to the fire continuously in small quantities instead of in large amounts at comparatively long intervals, as in hand-firing. Also greater uniformity in the draught is attained, and the inrush of cold air, which always occurs when the furnace doors are periodically opened in hand-stoking, is avoided.

There seems to be a concensus of opinion amongst competent judges that, from the point of view of heat economy, the advantages of mechanical stoking over hand-firing are greater the lower the grade of the fuel employed. Indeed, mechanical stoking tends to diminish the natural difference between a low-grade and a high-grade fuel in a degree which increases with the extent of such difference.

This last point is well illustrated by the results of a second series of comparative trials carried out by the late Professor E. J. Constam and P. Schlöpfer (*loc. cit.*) in which a Lancashire boiler was fired, alternately by hand and by a mechanical "under-feed" arrangement, with a series of four German (Ruhr and Saar) coals of descending grades. It will be seen from the accompanying Table L, in which their results are set out in detail, that the effect of the "underfeed" stoking in each case was to increase both the rate at which fuel was burnt on the grate and the amount of steam raised per unit weight of coal consumed, as compared with the same coal when hand-fired. With regard, however, to the "efficiency" figures (*i. e.* the percentage of the heat utilised) the advantage gained by the mechanical stoking was not nearly so great with the two highest grades of coal (Ruhr I and II) as it was in the case of the other two, and that the advantage was by far the greatest with the lowest grade of all the coals. An examination of the various heat losses shows that whereas the *burnt* gases always carried off decidedly less heat when the boiler was hand-fired than they did when the

COAL AND ITS SCIENTIFIC USES

TABLE L
ZÜRICH STEAM TRIALS WITH RUHR AND SAAR COALS ON A LANCASHIRE BOILER WITH (1) HAND-FIRING AND (2) UNDERFEED STOKING

Length of Boiler = 7.49 metre = 24.38 ft. } Ratio $\frac{\text{Heating Surface}}{\text{Grate Area}} = \left\{ \begin{array}{l} (1) \ 39.4 \\ (2) \ 34.2 \end{array} \right.$
Diameter " = 2.00 metre = 6.56 ft.

Description of Coal.	Ruhr I.		Ruhr II.		Ruhr II.		Saar.	
	(1)	(2)	(1)	(2)	(1)	(2)	(1)	(2)
Carbon	81.80		80.55		79.70		70.80	
Hydrogen	3.80		4.35		4.83		4.80	
Sulphur	1.00		0.97		0.76		1.10	
Nitrogen	1.40		1.50		1.60		1.20	
Oxygen	2.50		3.68		5.85		10.30	
Ash	8.30		6.45		4.02		7.35	
Water	1.20		2.50		3.24		4.45	
Net Caloric Value of Coal in K.C.Us. per Kilog.	7587		7600		7600		6695	
Coal Burnt per Hour. Kg.	167.9	211.1	187.0	192.9	180.6	199.4	232.5	243.1
Evaporation per Hour Kg. Water at 0° C./Steam at 100° C.	1379.4	1745.5	1441.5	1588.6	1373.4	1652.4	1310	1635
Water at 0° C./Steam at 100° C. per Kilog. Coal. Steam Gauge Pressure Atmos.	8.24	8.27	7.71	8.24	7.60	8.30	5.64	6.73
	10.79	10.95	10.66	10.71	11.00	10.70	10.90	10.73
% Composition of Chimney Gases								
CO ₂	11.42	9.70	11.30	9.06	9.93	10.34	11.83	10.21
CO	0.55	0.04	1.01	0.05	1.14	0.02	3.45	0.03
H ₂	0.24	0.25	0.76	0.28	0.72	0.32	1.17	0.27
O ₂	8.47	10.66	7.01	10.24	10.38	10.07	4.12	10.60
N ₂	79.31	79.32	79.92	80.35	77.82	79.25	79.04	78.86
Temperature of Chimney Gases ° C.	334°	341°	330°	328°	338°	331°	325°	347°
% Heat Utilised	68.8	69.8	65.3	68.3	63.8	69.5	54.1	63.4
% Heat Lost								
in Burnt Gases	16.6	21.1	15.5	21.6	17.6	20.6	12.9	20.3
in Unburnt Gases	3.6	1.5	7.5	1.8	8.6	1.6	17.2	1.5
in Smoke	2.1	1.0	2.5	1.5	4.6	1.3	5.3	2.5
in Ashes	3.4	2.7	4.1	2.2	2.8	1.5	1.7	1.6
by Radiation, etc.	5.5	3.9	5.1	4.6	2.6	5.5	8.8	10.7

COMBUSTION AND HEAT TRANSMISSION

mechanical arrangement was used, this advantage was always far outweighed by the correspondingly greater combined losses in the unburnt gases, smoke, and ashes incidental to hand-firing.

(d) *Chimney Losses*

From the boiler there passes up the chimney a complex mixture of (1) *burnt* products of combustion *plus* excess of air, that is to say, carbon dioxide, steam, oxygen, and nitrogen; (2) small amounts of *unburnt* gases, mainly carbon monoxide, hydrogen, with perhaps traces of methane; (3) combustible soot (carbon *plus* tarry matter); (4) traces of ammonium compounds; and (5) a small proportion of finely-divided mineral matter (ashes) carried forward from the furnace by the draught. All these constituents are hot, and therefore carry away with them their "sensible heat," whilst the heat of combustion of those enumerated under (2) and (3) represents also a loss of chemical energy which might have been developed in the boiler furnace had the combustion there been more complete.

It must, however, be remembered that some part of what are usually termed "chimney losses" does not really represent a dead loss to the system, inasmuch as the expenditure of a certain proportion of the energy of combustion is necessary to create the chimney draught. For without the rapid movement of air and burnt gases thus created and maintained no combustion of the fuel would take place, nor would there be any heat transmission in the boiler. And it is obvious that if by any means the burnt gases were all cooled down to atmospheric temperature before leaving the boiler system, some mechanical device would have to be substituted for the natural chimney draught. Hence some part of the "waste heat" of a chimney is an unavoidable expenditure of energy, and therefore is not, strictly speaking, a loss. It may, however, be safely said that the heat carried away up the chimney is always greatly in excess of that which is needed to move the gases through the system, namely about 2 or 3 per cent. of the total heat of combustion of the fuel.

A glance at the tabulated results of Professor Constam's boiler trials (Tables XLVIII and L) will show that as a rule by far the most serious chimney loss is that represented by the sensible heat of the burnt gases *plus* the excess of air passing up it. It is only in exceptional cases, and with very bad stoking, that the loss due to *unburnt* gases, or even smoke, assumes large proportions, whilst that due to the presence of finely divided mineral

COAL AND ITS SCIENTIFIC USES

matter or ammonium salts in the chimney gases may be regarded as insignificant.

In order to estimate the proportion which these various losses, both separately and in their sum total, bear to the heat of combustion of the coal, it is necessary to have exact chemical analyses both of the coal burnt and of the chimney gases, and to know the average temperature and specific heat of the latter. Determination must also be made of the calorific value of the fuel burnt and of the temperature and hygrometric condition of the air drawn into the furnace. For it must be remembered that it is never possible in practice to burn coal "dried at 100° C." in *dry* air; the coal will usually contain between 2 and 5 per cent. of moisture, and the air drawn into the system will contain anything up to 2 per cent. of moisture. Thus, for example, if 1 lb. of a coal containing 3 per cent. of moisture and 4.5 per cent. of "disposable hydrogen" be burnt with 1.5 times the theoretical quantity of air of 60 per cent. saturation at 60° Fahr. then the amounts of steam in the burnt gases will be somewhat as follows:—

From 3.0 per cent. of moisture in coal	= 0.030 lb.
" 4.50 " " " hydrogen " "	= 0.405 "
In 215 cub. ft. of air of 60 per cent. saturation at 60° Fahr.	= 0.100 "
Total	<u>0.535 "</u>

In this connection the importance of a proper chemical control of a large boiler installation may be emphasised. In far too many cases matters are left solely in the hands of engineers who are certainly not usually well qualified to carry out or supervise chemical analyses or operations. If only it became the custom of all large manufacturing firms to engage the services of a properly trained "fuel chemist" to supervise all coal contracts and to establish a scientific control over fuel consumptions generally, a vast saving in their annual coal bills would be effected. And groups of small manufacturers might secure similar advantages by co-operation.

Sensible Heat of Burnt Gases.—Provided that the data mentioned in the preceding paragraphs are precisely known, it is a comparatively easy matter to calculate (1) the amounts of carbon dioxide, steam, oxygen and nitrogen passing up the chimney per unit weight of coal (of known calorific value) burnt, and (2) the total "sensible heat" represented by the mean increase

COMBUSTION AND HEAT TRANSMISSION

in the kinetic energy of the said gases between the atmospheric temperature t° and the chimney temperature T° . For this purpose a knowledge of the mean heat capacities of carbon dioxide, steam, and the diatomic gases nitrogen and oxygen, under constant pressures between, say, 15°C . and temperatures up to 600°C . is necessary.

According to Holborn and Henning,¹ whose work on the subject is generally accepted as providing the best available

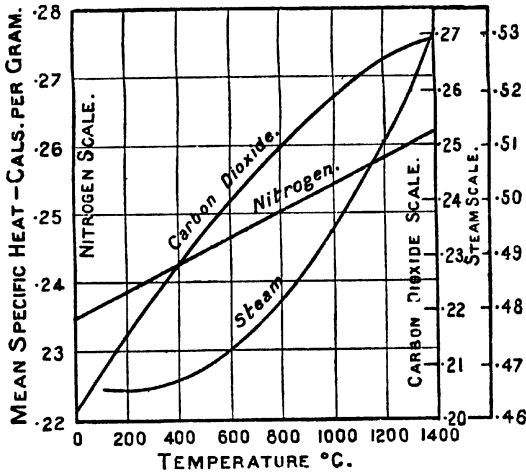

FIG. 24.—Mean Specific Heats of Nitrogen, Carbon Dioxide and Steam (Holborn and Henning).

data, the mean specific heats at constant pressure in calories per gram of carbon dioxide, steam, and nitrogen between 0° and 1400°C . (steam 100° to 1400°C .) may be represented as a function of temperature, as follows, where $t = ^\circ\text{C}$.

MEAN SPECIFIC HEATS AT CONSTANT PRESSURE IN CALORIES PER GRAM.

	Range $^\circ\text{C}$.
Carbon dioxide $C_p = 0.2010 + 0.04742t - 0.0718t^2$	0 to 1400°
Steam $C_p = 0.4669 - 0.04168t + 0.0744t^2$	100 to 1400°
Nitrogen $C_p = 0.2350 + 0.0419t$	0 to 1400°

The values of the mean specific heats in calories per gram

¹ *Ann. de Phys.* (4), 18 (1905), 7139, and 23 (1907), 809.

COAL AND ITS SCIENTIFIC USES

obtained from these equations are shown in the following table (Table LI) and graphically in Fig. 24.

TABLE LI
MEAN SPECIFIC HEATS OF NITROGEN, CARBON DIOXIDE AND STEAM
[CAL. PER GRAM]

t° C.	Nitrogen.	Carbon Dioxide.	Steam.
Range =	0 - t°	0 - t°	100° - t°
0	0·2350	0·2010	—
100	·2369	·2080	0·4658
200	·2388	·2151	·4653
300	·2406	·2220	·4658
400	·2426	·2278	·4672
500	·2445	·2335	·4690
600	·2464	·2390	·4726
700	·2483	·2442	·4767
800	·2502	·2491	·4817
900	·2521	·2535	·4877
1000	·2540	·2572	·4941
1100	·2558	·2610	·5020
1200	·2578	·2641	·5101
1300	·2596	·2670	·5193
1400	·2616	·2692	·5296

For the purposes of boiler calculations, however, it is more convenient to transpose the above figures so that the mean heat capacities of the various gases in question at constant pressure shall be expressed in terms of either B.Th.U.s. per cub. ft. at 0° and 760 m.m. or of B.Th.U.s. per lb., thus :—

MEAN HEAT CAPACITIES AT CONSTANT PRESSURE IN B.Th.U.s.
PER CUB. FT. AT 0° AND 760 M.M.

	Range ° C.
<i>Carbon dioxide</i> = 0·04466 + 0·0 ₈ 165t - 0·0 ₈ 4t ²	0 to 1400°
<i>Steam</i> . . = 0·031816 - 0·0 ₈ 1144t + 0·0 ₈ 3t ²	100 to 1400°
<i>Nitrogen</i> . . = 0·03304 + 0·0 ₈ 2671t . . .	0 to 1400°

From these data the following table (Table LII) has been drawn up showing the calculated total sensible heat in B.Th.U.s. per cub. ft. measured at 0° C. and 760 m.m. of carbon dioxide and nitrogen, respectively, for various temperature ranges between a base line of 0° and each 100° up to 1400° C. Also similar values for both 1 cub. ft. and 1 lb. of steam between 100° and 1400° C. are included.

COMBUSTION AND HEAT TRANSMISSION

TABLE LII
SENSIBLE HEAT IN NITROGEN, CARBON DIOXIDE AND STEAM
 [B.Th.U.s.]

Temperature T° C.	Nitrogen.	Carbon Dioxide.	Steam.	
	B.Th.U.s. per cub. ft. at 0° C. and 760 m.m.		B.Th.U.s. per cub. ft. of Saturated Steam at 100° and 760 m.m.	B.Th.U.s. per lb.
Range =	0° - T°		100° - T°	
100	3.33	4.59	—	—
200	6.71	9.51	3.12	83.45
300	10.13	14.37	6.24	167.1
400	13.63	20.10	9.38	251.4
500	17.17	25.77	12.55	336.4
600	20.76	31.65	15.81	423.7
700	24.40	37.74	19.14	512.9
800	28.11	43.98	22.55	604.6
900	31.88	50.35	26.11	699.6
1000	35.67	56.77	29.75	797.4
1100	39.53	63.36	33.59	900.3
1200	43.46	69.96	37.56	1006.3
1300	47.40	76.61	41.73	1117.8
1400	51.42	83.32	46.07	1234.8
0 - 15	0.50	0.67		

(1) The density values employed in drawing up Table LII have been calculated by dividing the molecular volume in litres (22.4 litres) by the molecular weight of the gas in grams.

(2) The corresponding figures for the sensible heat per cub. ft. measured between 15° and t° may be obtained in the case of nitrogen by subtracting 0.50 B.Th.U. per cub. ft., and in the case of carbon dioxide 0.67 B.Th.U. from the figures given in the table.

(3) The values for the sensible heat for other diatomic gases (oxygen and carbon monoxide) may be assumed, for the purposes of fuel calculations, to be the same as those for nitrogen.

From such calculated values, the following curves (Fig. 25) have been plotted showing the total sensible heat in B.Th.U.s. between 0° and any temperature in the Centigrade scale up to 1400° for a cub. ft. measured at 0° C. and 760 m.m. of each gas and for 1 lb. of steam.

It may be considered good boiler practice if with an average steam coal, containing, say,

$$C = 80.0, H = 5.5, S = 1.0, N = 1.5, O = 5.0,$$

$$\text{and ash} = 7.0 \text{ per cent.},$$

COAL AND ITS SCIENTIFIC USES

substantially complete combustion can be attained by drawing no more than 1.5 times the theoretical quantity of air (*i. e.* $1.5 \times 135.2 = 202.8$ cub. ft. at 0° and 760 m.m.) through the system, and at the same time keeping the temperature of the burnt gases down to 300° C. If the hygrometric conditions of the air drawn in at the furnace be 60 per cent. "saturation" at 15° C., and the coal as charged into the furnace contains 2 per cent. of moisture,

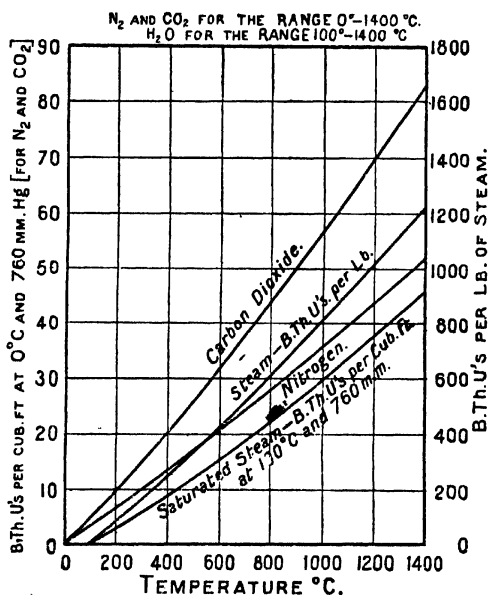

FIG. 25.—Sensible Heat of Nitrogen, Carbon Dioxide and Steam (B.Th.Us.).

then heat carried off by the chimney gases at 300° C. per lb. of *dry* coal burnt, will be as follows:—

	B.Th.Us.	
In 23.93 cub. ft. CO ₂	= 328	}
„ 160.62 „ „ N ₂	= 1547	
„ 14.19 „ „ O ₂	= 137	
„ 1.523 lb. Steam	= 364	
Total . . .	2376	measured at 0° C. and 760 m.m.

COMBUSTION AND HEAT TRANSMISSION

This total would be 17.0 per cent. of the calorific value of the coal burnt, which is assumed to be 14,000 B.Th.U.s. per lb.

How prejudicial are the effects of higher chimney temperatures and larger excesses of air upon the sensible heat losses, and therefore upon the efficiency of the boiler, may be judged from the following table and curves (Table LIII and Fig. 26) which show the calculated losses in B.Th.U.s. per lb. of the dry coal in question with varying excesses of dry air and chimney temperatures up to 500° C.

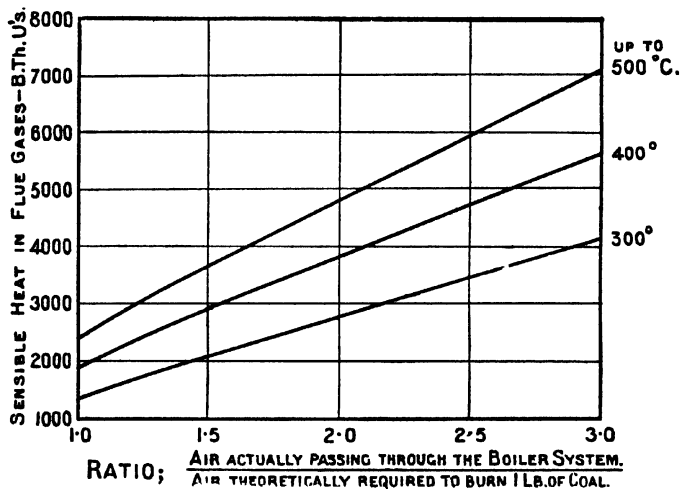

FIG. 26.—Sensible Heat in Flue Gases—Effect of Air Dilution.

TABLE LIII

SENSIBLE HEAT LOST IN FLUE GASES
B.TH.US. PER POUND OF COAL BURNT FOR THE TEMPERATURE
RANGE 15° — T° C.

Ratio $\frac{\text{Air drawn through the System}}{\text{Air theoretically required}}$	Temperature of Flue Gases T° C.		
	300°	400°	500°
1.0	1358	1870	2382
1.5	2127	2917	3712
2.0	2779	3807	4839
2.5	3135	4697	5971
3.0	4079	5578	7092

COAL AND ITS SCIENTIFIC USES

The following calculations published by Messrs. W. H. Booth and J. B. C. Kershaw of the percentage losses in respect of sensible heat carried up the chimney by the burnt products of combustion of a good steam coal of calorific value 13,500 B.Th.U.s. per lb. with a chimney temperature of 600° Fahr. (say 315° C.), according to their CO₂ contents,¹ may be cited as emphasising the needs of a careful control of the air supply as a means of minimising such losses.

Percentage CO ₂ in Chimney Gases.	Percentage Chimney Losses due to Sensible Heat of Burnt Products <i>plus</i> Excess Air at 315° C.
12·0	17·1
10·0	20·2
8·0	24·0
6·0	32·8
5·0	40·0

As the mere observation of the temperature of the chimney gases, without a simultaneous determination of their CO₂ content, may be very misleading, the two determinations should always be made together. Indeed the installation of recording instruments for these purposes in the flue leading from the boiler to the chimney may be recommended as one of the best aids to the achievement of the utmost economy in boiler practice, especially if the indications of the CO₂ recorder are occasionally checked by a complete chemical analysis in the laboratory of a representative sample of the chimney gases taken continuously over a period of not less than thirty minutes.

(e) Heat Transmission in Boilers

The factors governing the transmission of heat across the boiler surfaces from the fire and the hot products on the one side to the water on the other have so important a bearing upon both the design and general efficiency of a particular installation that it is deplorable how often they are neglected by those responsible for the management of large plants. The scientific aspects of the question formed the subject of a very able and comprehensive Report presented by Professor W. E. Dalby to the Institution of Mechanical Engineers in the year 1909,² which, together with the discussion thereon, is commended to the reader as embodying the best knowledge then available.

¹ *Smoke Prevention and Fuel Economy*, 2nd Ed., 1911, Appendix II, p. 221.

² *Proc. Inst. Mech. Eng.*, 1909, pp. 921 to 1071.

COMBUSTION AND HEAT TRANSMISSION

The transmission of heat from the fire to the boundaries of the furnace takes place, to quote Professor Dalby, "in two fundamentally different ways:—(1) by direct radiation from the incandescent fuel and the flame and the hot gases, and (2) by the agency of the matter in the path of the flow—that is, the hot gases, the metal boundary, and the water on the other side of the boundary. In the first case, transmission is effected by the vibration of the ether in the same way that the heat of the sun is transmitted to the earth across space and is instantaneous . . . (and) may be regarded as uninfluenced by the presence of the furnace gases, although actually the quantity is modified by their presence to a certain extent. In the second case, the matter in the path of the flow transmits the heat (*a*) by convection, and (*b*) by conduction."¹

Hence in general three modes of transmission, all acting simultaneously, must be considered, namely (1) by radiation, (2) by convection, and (3) by conduction. And whereas it is impossible to devise any experiment in which one particular mode may, so to speak, be isolated and studied apart from the other two, yet it is very desirable that in forming a mental picture of the operation as a whole the influence of each mode should be separately considered and its relative importance weighed.

Radiation.—The outstanding importance of this factor has until recently been largely overlooked or under-rated by engineers. It should always be remembered (1) that the heat radiated from an incandescent black body, as represented by a glowing mass of coke in a boiler furnace, is proportional to the *fourth* power of its absolute temperature (Stefan's Law); (2) that the flames produced by burning gases radiate an appreciable proportion of the energy developed by the combustion, as for instance, a non-luminous Bunsen flame, which radiates some 15 per cent. of the energy developed therein; (3) that the energy thus "radiated" is transmitted practically instantaneously and without sensible loss to the metal boundary between the furnace and the water; and (4) that the "radiated" energy absorbed by the said boundary is then "conducted" by it, as sensible heat, to the water on the other side. The limiting factors in the process are *either* (1) the conducting capacity of the metal septum, or (2) the existence of a dead water film on the other side of it (see the following paragraphs). If the evolution of steam and the water circulation on the other side is sufficiently intensive, the limiting influence

¹ *Proc. Inst. Mech. Eng.*, 1909, p. 923.

COAL AND ITS SCIENTIFIC USES

of (2) may disappear, in which case the conducting capacity of the metal septum would be fully operative.

The total energy, expressed in ergs, radiated per square centimetre per second from an incandescent black body is given by the following equation (where T is its absolute temperature in degrees Centigrade):—

$$E = 5.32 \times 10^{-5} T^4 \text{ ergs per cm}^2 \text{ per sec.}^1$$

Converting this into the equivalent B.Th.U.s. radiated per sq. ft. per hour, and introducing the influence of a further condition, namely that of the temperature T_2 of the absorbing surface (the metal boundary), the expression becomes:—

$$E = 16 \times 10^{-10} (T_1^4 - T_2^4) \text{ B.Th.U.s. per sq. ft. per hour,}$$

where T_1 and T_2 represent in degrees Fahrenheit the absolute temperature of the source of radiation (the fire) and of the absorbing surface (metal boundary) respectively.

By means of this formula Professor Dalby (*loc. cit.*) has calculated that the *upper limiting* value of the heat which may possibly be transmitted by radiation from a source (assumed to fill the firebox) at a temperature of 3000° Fahr. to a boundary surface at 800° Fahr. may be as high as 179,600 B.Th.U.s. per sq. ft. per hour, or equivalent to the evaporation of 134 lb. of water "from and at" 212° Fahr.

Although so high a result is probably never actually attained in practice, however nearly it may be approached, the formula indicates how supremely important the radiation from incandescent surfaces in a boiler furnace may be, and how efficient a heating surface (metal boundary) exposed to them may become, as for example in the Boncourt Surface Combustion Boiler (*q.v.*).

Transmission by Convection and Conduction.—It has long been recognised that the transmission of the sensible heat of the hot gases during their passages through the tubes or flues of a boiler to the water on the other side of the metal plate, is limited by the existence at the boundary surface of a "dead" film, generally assumed to be about $\frac{1}{8}$ in. only in thickness, of relatively cool gas, in which convection currents apparently do not take place and which, owing to its low conductivity, offers a high resistance to the passage of heat (other than "radiant heat") through it. There is also a similar "dead" film of water on the other side of the plate, which offers a like but considerably smaller resistance.

¹ Poynting's *Heat* (1904), p. 250, as quoted in Dalby's Report (*loc. cit.*).

COMBUSTION AND HEAT TRANSMISSION

Hence it is that, unless special means can be found whereby these films are destroyed or their retarding influence rendered negligible, the full conducting capacity of the metal composing the boiler tube can never be fully realised in practice. This doubtless explains the experience of the early locomotive engine builders, and which long puzzled them, that the substitution of copper for iron tubes in a boiler did not appreciably increase the rate of heat transmission as measured by the evaporation, notwithstanding the fact that the thermal conductivity of copper is about five times greater than that of iron.

How greatly the "dead" gas film referred to retards the heat transmission was well illustrated by some experiments published by J. G. Hudson in 1890¹ from which he concluded (1) that of the total "temperature head" between the hot flue gases and the water in a boiler, no less than 98 per cent. is lost in forcing the heat through the "dead" gas film into the plate, the remaining 2 per cent. only being the "effective head" between the plate and the water; and (2) that the hot side of the plate is never more than 36° Fahr. hotter than the water side. These conclusions were substantially confirmed in 1893 by Sir John Durston, who, however, put the difference referred to in (2) at 68° Fahr. for water at 212° Fahr. when the plate is perfectly clean.² Professor Dalby (*loc. cit.*) thinks that of the total "temperature head" about 97 per cent. is required to overcome the resistance of the gas film, 1 per cent. to overcome that of the plate, and 2 per cent. to overcome that of the water film.

In considering the retarding influence of films of gas, oil, or water on the tube plate, to the passage of heat, the following table of conductivities, expressed in calories which pass per second through a plate of the substance 1 c.m. square and 1 c.m. thick when the opposite faces of it are kept at temperatures differing by 1° C., may be useful:—

Air	0.000055
Carbon dioxide	0.000031
Water	0.00143
Oil	Between $\frac{1}{4}$ and $\frac{1}{3}$ that of water.
Scale	2 to 5 times that of water (according to density)
Iron	0.20
Copper	0.90

} approximately.

¹ *The Engineer*, 1890, 70, p. 523.

² *Trans. Inst. Nav. Arch.*, 34, p. 130.

COAL AND ITS SCIENTIFIC USES

As to the influence of oil and scale, experiments carried out by W. J. Hirsch in 1890¹ led him to conclude (1) that any fatty deposit on the internal surface of a boiler greatly impedes the transmission of heat, and (2) that a deposit of vegetable oil is more dangerous than one of mineral in causing the plate to overheat, whilst L. P. Breckenridge² found in 1899 that the formation of a scale $\frac{1}{32}$ to $\frac{3}{84}$ in. thick in the tubes of a locomotive boiler caused a loss in efficiency of 9.55 per cent. From such observations as these the great importance of keeping plates and tubes of a boiler clean may be appreciated.

THE EFFECT OF HIGH GAS VELOCITIES IN DESTROYING THE "DEAD" GAS FILM AND THEREBY INCREASING THE RATE OF HEAT TRANSMISSION.

If, as has been shown in the preceding paragraphs, the existence of the "dead" gas film at the surface of the metal plate separating the source of heat from the water in a boiler is the main and most potent obstacle to rapid heat transmission, it follows that its complete or even partial destruction would greatly assist the flow of heat. This was first recognised by the late Professor Osborne Reynolds, of Manchester, who, in the year 1875, published a remarkable paper³ in which he suggested that the best solution of the problem of diminishing the influence of the "dead" gas film probably lay in increasing the velocity of the hot gases through the boiler system. From theoretical considerations he concluded that the rate of heat transmission would prove to be a linear function of the speed at which the hot gases traversed the system, and gave the following formula:—

$$Q = (A + Bdv) (T - \theta)$$

in which:—

Q = amount of heat transmitted in B.Th.U.s. per sq. ft. per sec. from the hot gases to the water

d = the density of the hot gases in lb. per cub. ft.

v = the velocity of the hot gases in ft. per sec.

T = temperature of the gases in ° Fahr.

θ = mean temperature of the heating surface

A and B = experimental constants.

His contention that the rate of heat transmission depends upon

¹ *Bull. de la Soc. d'Encour. Indust. Nat.*, Vol. 5, p. 302.

² *Railroad Gazette*, Vol. 31, p. 60.

³ *Mem. Lit. Phil. Soc. Manchester* (1875), Vol. XIV., p. 7.

COMBUSTION AND HEAT TRANSMISSION

the velocity of the gases was subsequently supported by other investigators, among whom may be mentioned J. G. Hudson¹ (1890), whose formula, however, made the rate of heat transmission depend on the square root of the gas velocity, Brillié (1897),² and Professor John Perry (1898),³ but it was left to the late Professor J. T. Nicolson of the Manchester School of Technology to develop the theory and its practical application to boiler design in the year 1909.⁴

Nicolson's experiments had convinced him that, inasmuch as the evaporation from the firebox due to convection was negligible in comparison with that due to radiation, in designing a boiler "the proper thing to do was to form a combustion chamber of glowing refractory—that is non-water-cooled—surface behind the firebridge and before the flues or tubes or convective heating surface commenced," in order that any unburnt gases from the fire might be caught and perfectly burnt. With regard to the transmission of heat by convection from the hot burnt gases through the plate to the water, his own experimental work, whilst supporting the general validity of Osborne Reynold's equation, as expressing the law for the heat flow from fluid to metal or *vice versa* under the most varied conditions, led him to amplify it, owing to the fact that the rate of heat transmission depends not only upon the product of the density and velocity of the hot gases, but also upon such factors as the mean hydraulic depth of the tubes or flues through which the gases passed, and the nature of the metal plate. As the result of a prolonged experimental investigation of this subject he finally put forward the following revised equation :

$$Q = \left[\frac{\phi}{200} + \frac{\sqrt{\phi}}{\text{const.}} \left(1 + \frac{p}{a} \right) dv \right] (T - \theta)$$

where :—

T = mean gas temperature in flue in ° Fahr.

θ = mean plate temperature in flue in ° Fahr.

φ = mean temperature of gas and plate in ° Fahr.

d = mean density of gas (lb. per cub. ft.)

v = mean velocity of gas in ft. per sec.

a = area, and p = perimeter of gas flue in ft.

¹ *Engineer* (1890), Vol. LXX., p. 523.

² *Le Génie Civil* (1897), Vol. XXXI., p. 260.

³ *Trans. Inst. Eng. Ship. Scot.* (1898), Vol. CXXXII., p. 274.

⁴ *Trans. Jun. Inst. Eng.*, Feb. 1909, and also "Discussion on Professor Dalby's Paper" (*loc. cit.*), p. 1007.

COAL AND ITS SCIENTIFIC USES

For practical boiler work, however, he put forward the following simpler form :—

$$Q = Cdv(T - \theta)$$

where C is a constant varying between the limits 3 and 6, according to the condition of the surfaces, the size of flues, and the gas temperature. With clean surfaces, narrow flues, and high temperatures it might be as high as 6, but with cool gas, wide flues or sooty plates it might drop to as low as 3.

THE NICOLSON EXPERIMENTAL BOILER

Professor Nicolson applied the foregoing principles in an experimental boiler erected to his design by Messrs. Joseph Adamson & Co., at their works at Hyde, near Manchester. It is shown diagrammatically in Fig. 27¹ and consisted of a Cornish boiler 24 ft. long by 6 ft. 6 in. in diameter with one internal flue 3 ft. 5 in. in diameter. The grate, A, had an area (exclusive of the dead plate) of 18.1 sq. ft. and the firebridge, B, was perforated for the admission of the secondary air, the amount of which could be controlled by a door in the ash-pit. For a length of 5 ft. 4 in. beyond the bridge the flue was lined with firebrick, 4½ in. in thickness, to form a hot combustion chamber, C, which was spanned by a firebrick arch, D, in order to break up the gas currents. The area of the flue beyond this chamber was reduced by the introduction of a hollow cylinder, E, of firebrick, 10 ft. long by 3 ft. 1 in. external diameter, leaving an annular passage of 2 in. between itself and the flue plates for the stream of hot gases, with the object of increasing their velocity and of forcing them into contact with the plates, thereby diminishing or destroying the heat retarding influence of the "dead gas film." After leaving the boiler flues the gases were passed upwards through a cylindrical flue, F, 16 in. in diameter, called the "evaporator," containing 102 water tubes, each 11 ft. 6 in. long by ⅝ in. external and ⅜ in. internal diameter. From the top of this the gases were led downwards through another similar flue, G, called the "economiser," containing 90 water tubes, each 13 ft. 9 in. long by ⅞ in. outside and ⅝ in. inside diameter, and along the axis of each was fixed a ½ in. square rod, 13 ft. 9 in. long, to reduce the cross-sectional area, and consequently to

¹ This diagram, together with Table LIV, are reproduced with the kind permission of Mr. Michael Longridge, M.A.

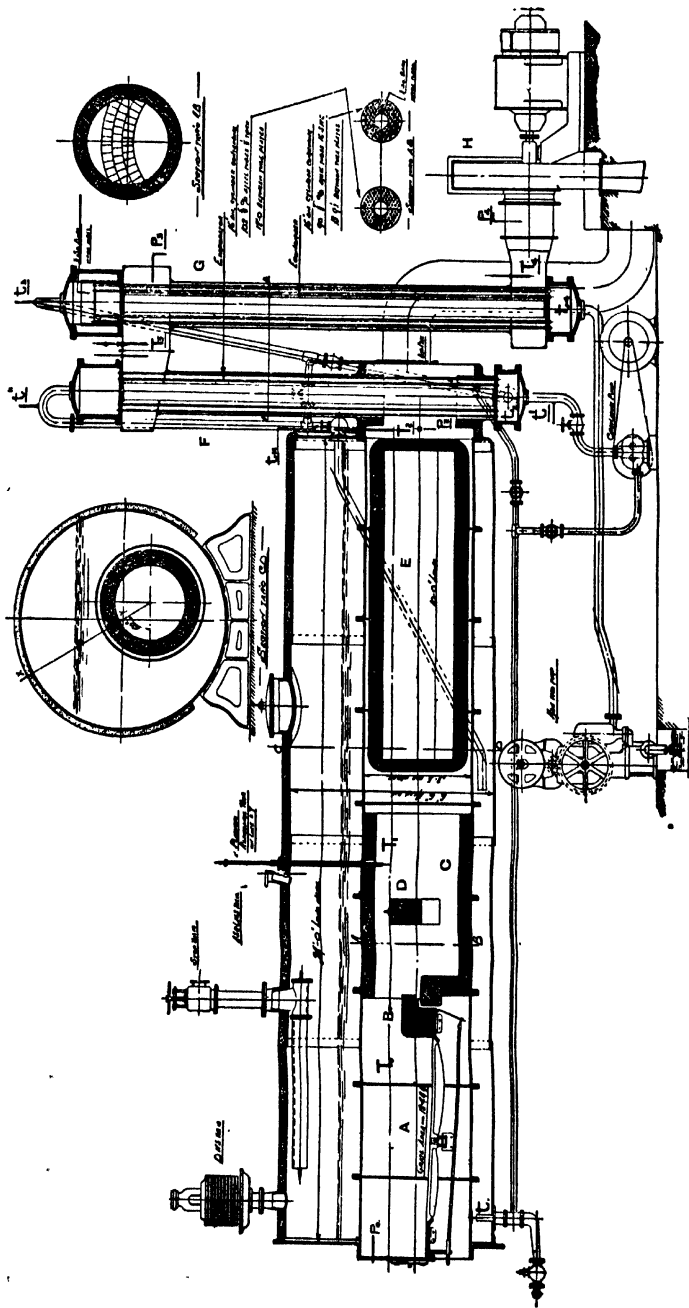

FIG. 27.—Nicolson Experimental Boiler (at Joseph Adamson & Co. Works, Hyde, October 1909).

COAL AND ITS SCIENTIFIC USES

increase the velocity of the water and to force it into contact with the surface of the tube. From the bottom of the economiser the cooled gases were discharged through a motor-driven fan, H, which provided the necessary suction, into the chimney.

The heating surface of the boiler (excluding the surface below the grate and the firebrick-lined combustion chamber, C), was 171 sq. ft., of the evaporator 192 sq. ft., and of the economiser 293 sq. ft., or a total for the whole system of 656 sq. ft. The capacity of the "water space" in the boiler was 230 cub. ft., that of the "steam space" 185 cub. ft., whilst the area of the water surface was 132 sq. ft.

During October 1909 the boiler was handed over to Mr. Michael Longridge to undergo a series of trials with the object of testing both the soundness of the underlying principle of its design and its evaporative power.

The results of two of these trials, in which the boiler was fired with a good Welsh steam coal, containing in the dry state—

C = 87.60, H = 4.23, S = 1.52, N = 2.13, O = 1.18, and ash = 2.13 per cent.,

and of calorific value 14,929 B.Th.U.s. per lb., are given in Table LIV. These results showed (1) that combustion of the fuel was practically complete in the furnace and combustion chamber with only 1.25 times the theoretical amount of air, the burnt gases containing an average of 14.7 per cent. of carbon dioxide, with only 0.22 per cent. of carbon monoxide; (2) that the temperature on leaving the system had been reduced to as low as 294° Fahr.; (3) that the rate of evaporation per square foot of heating surface of the boiler and evaporator combined was as high as 23 lb. of water "from and at 212° Fahr.," or something like three times that of an ordinary Lancashire boiler; whilst (4) the heat actually utilised in the system amounted to 75 per cent. of that capable of being developed by the complete combustion of the coal in the furnace. It was also estimated that on an average as much as 32,400 B.Th.U.s. per hour were transmitted to the water per square foot of the area of the flue surrounding the firebrick cylinder, E.

Taken as a whole the results certainly seem to prove the soundness of Professor Nicolson's ideas, although, as Mr. Longridge pointed out, probably in practice it would be found necessary to substitute some other more convenient device for the rather cumbrous firebrick plug, E.

COMBUSTION AND HEAT TRANSMISSION

TABLE LIV

RESULTS OF MR. MICHAEL LONGRIDGE'S TESTS OF THE NICOLSON
BOILER WITH A WELSH STEAM COAL

Date of Trial	20/10/1909	20/10/1909
Duration in Hours	6·05	6·65
Dry Coal Burnt per Hour, lb.	724·0	721·0
Calorific Value of Dry Coal B.Th.Us. per lb. . .	14,929	14,929
<i>Evaporation</i> { per Hour	8265	8372
in lb. Water { per lb. Dry Coal Burnt	11·41	11·61
from and at { per sq. ft. Heating Surface of		
212° Fahr. { Boiler and Economiser per Hr.	22·77	23·06
{ per sq. ft. Total Heating Sur-		
{ face per Hour	12·58	12·75
Steam Pressure (absolute) in lb. per sq. inch.	135	135
<i>Feed Water</i> { Entering Economiser in ° Fahr.	77°	71°
<i>Temperature.</i> { Leaving Economiser in ° Fahr.	288°	275°
{ Leaving Evaporator in ° Fahr.	350°	350°
<i>Mean</i> { in the Combustion Chamber, ° F.	3000°	3000°
<i>Temperature</i> { Entering Evaporator, ° Fahr. . .	1360°	1418°
<i>of the</i> { Entering Economiser, ° Fahr. . .	870°	871°
<i>Gases.</i> { Leaving Economiser, ° Fahr. . .	291°	294°
<i>Percentage</i> { CO ₂	14·86	14·50
<i>Composition</i> { CO	0·30	0·15
<i>of the</i> { O ₂	3·84	4·45
<i>Gases.</i> { N ₂	81·00	81·00
Ratio Air used to that theoretically required for Combustion	1·23	1·27
<i>Percentage</i> { Transferred to the Water	73·8	75·0
<i>of heat of</i> { Carried off by Burnt Gases and		
<i>Combustion</i> { Excess Air	5·2	5·6
<i>of the Coal.</i> { Carried off by Unburnt Gases . .	1·1	0·6
{ Lost in the Ashes (no Carbon) . .	3·7	3·3
{ Balance	16·2	13·5
B.H.P. used by Feed Water Pump and the Fan	41·23	41·48
Estimated <i>net</i> Efficiency of whole Plant after deducting B.H.P. used for driving Pump and Fan	64·4	66·1

THE BETTINGTON BOILER FOR ATOMISED FUEL

As an instance of another recent development in scientific boiler design in a somewhat different direction, the Bettington boiler may be appropriately described, inasmuch as it embodies a possible solution of the difficulty of completely burning a

COAL AND ITS SCIENTIFIC USES

homogeneous mixture of pulverised coal and pre-heated air in a continuous flame, and is capable of being applied successfully to low-grade lignitic coals, which in ordinary boilers yield but poor results.

The boiler, shown diagrammatically in Fig. 28, consists of a cylindrical body, AB, fixed vertically on a suitable foundation, and containing the combustion chamber, C, which is formed by a circle of vertical water tubes separated by keyed refractory firebricks, so that the wall of the chamber is partly the exposed tubes and partly the filling of firebricks. This construction of a water-cooled combustion chamber has overcome one of the causes of failure in dust-burning boilers hitherto experienced, namely the difficulty of getting any arrangement to stand the very high temperature involved. The fuel is fed from a bunker, D, into a rotary pulveriser and blower, E, where it is ground to a fine dust and mixed with a stream of air (sufficient in quantity for its complete combustion) which has been pre-heated by passage through an "air-heater" at the top of the boiler at the expense of part of the sensible heat of the waste gases. The intimate mixture of coal dust and hot air is blown by the fan through a chamber, F, where any coarse particles of coal are deposited and returned to the pulveriser, and thence by a duct to the burner, G, which is fixed in a central position at the bottom of the combustion chamber of the boiler.

The explosive mixture of coal dust and hot air is ignited as it emerges from the mouth of the burner, producing a continuous mushroom-shaped flame which fills the combustion chamber. The combustion of the fuel, being thus "explosive" in character, is completed with a minimum excess of air; the ash in the fuel during its passage through the flame is converted into a liquid spray, which is projected against the hot brick lining of the furnace, and in course of time drips down into the ash-pit at the bottom of the chamber, where it is sufficiently chilled to prevent the successive drops from adhering to each other. The cold ash is in the form of small globules $\frac{1}{4}$ to $\frac{1}{2}$ in. in diameter which can easily be removed periodically. Also, it is claimed that the liquid spray of ash serves to close up all crevices in the fire-brick filling of the furnace, cementing it into one solid piece and glazing the inner surface as with an enamel.

The continuous flame of the burning coal dust and air mixture rises vertically upwards in the boiler chamber, and on striking against the water chamber, H, at the top thereof, is deflected into a downward vertical course for some distance along the

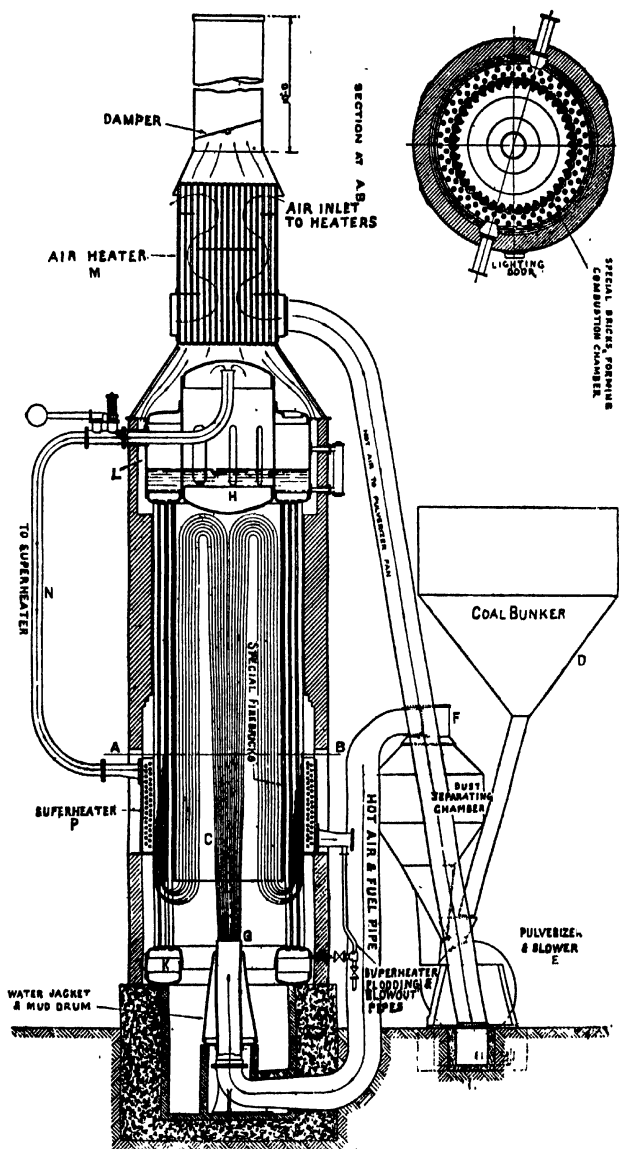

FIG. 28.—Sectional Elevation and Cross Section of Bettington Boiler, showing the Path of the Gases.

COAL AND ITS SCIENTIFIC USES

inner walls of the chamber, until on nearing the bottom the hot products are turned upwards again through the annular space between the inner and outer walls of the boiler in which are fixed a series of solid drawn mild steel water evaporating tubes. These tubes are arranged in double rank between the top and bottom "headers," H. and K. The gas stream after emerging into a chamber, L, surrounding the top header, H, finally passes thence upwards to the chimney *via* the tubular air-heater, M, in which part of their sensible heat is transmitted to the cold air which is drawn by the fan blowers downwards through the tubes of the heater on its way to the pulveriser where it mixes with the coal dust.

The steam generated in the vertical evaporating tubes collects in the top header, H, from which it passes downwards through the pipe, N, into the annular superheater, P, which is fixed like a belt round the lower part of the combustion chamber.

It is claimed that the boiler is capable of burning smokelessly low-grade slack coals, containing up to even 25 per cent. of ash, with a steam-raising efficiency up to between 70 and 80 per cent.; moreover that, owing to its being possible either to start or to stop the combustion almost instantaneously, not only can steam be got up or shut down very rapidly, but also that the rate of combustion can be rapidly adjusted to variations in the load.

Steam Trial.—As an example of what the boiler is capable of doing with a low-grade coal, the results of the following steam trial carried out by the author with a Malayan (Rawang) lignitic coal in the year 1912, may be described.

The boiler used was a vertical cylinder, 29 ft. in height by 10 ft. in diameter, with a water-heating surface of 2100 sq. ft., and a superheating surface of 500 sq. ft. Its rated capacity was equivalent to an evaporation of 10,000 lb. of water per hour "from and at 212° Fahr." The construction of the boiler was such as to admit of accurate steaming trials being carried out within a relatively short time, inasmuch as (1) the pulverised fuel was completely and practically instantaneously burnt as fast as it was fed into the combustion chamber; (2) there was no heat-retaining brickwork setting or the like; and (3) the water capacity of the boiler was very small in relation to its rate of evaporation.

On the day of trial, the boiler had been fired for a continuous period of several hours with the Rawang coal, before the actual official test commenced. The latter extended over a period of 1½ hours. The coal was weighed out in 2 cwt. lots at regular intervals of from 7½ to 10 minutes, each lot being immediately

COMBUSTION AND HEAT TRANSMISSION

transferred to the hopper of the pulveriser attached to the boiler. A sample was taken from each charge as it passed into the hopper, so as to provide a representative sample of the fuel over the whole period of the trial.

The graduated tank through which all the feed water passed to the boiler was subsequently calibrated by weighing the water discharged between various selected levels on the graduated scale against the same set of weights which had been used for weighing out the coal during the trial, and proper corrections were applied for the difference between the density of the feed water (at 159° Fahr.) used during the trial and that of the water (at 58° Fahr.) used for the subsequent calibration of the tank. Systematic temperature and pressure readings were made at regular intervals of 15 minutes throughout the trial.

The coal as charged into the boiler contained 13.8 per cent. of water and 4.4 per cent. of ash, whilst the calorific value of the *dry* coal was 11,644 (gross) and 11,066 (nett) B.Th.U.s. per lb.

The mean rate of evaporation maintained throughout the trial was somewhat higher than the rated capacity of the boiler, and the efficiency attained was 70.3 per cent. based on the *net* calorific value of the dry coal; combustion was complete, and the average amount of CO₂ in the chimney gases was 11.7 per cent.

The detailed results of the trial are set forth below:—

Duration of Trial = 1½ Hours

Temperature of Air in Boiler House = 75.5° Fahr.

Barometer = 30.4 in.

(1)	Total <i>dry</i> Coal fired per hour	1287 lb.	
(2)	Total Water actually evaporated per hour	8870 lb.	
(3)	Temperature of Feed Water	159° Fahr.	
(4)	Absolute Steam Pressure, lb. per sq. inch	165	
(5)	Temperature of Evaporation	366° Fahr.	
(6)	Superheat of Steam	114° Fahr.	
(7)	Factor of Evaporation, including super-heat	1.168	
(8) <i>Evaporation</i> " From and at 212° Fahr.	{	lb. per hour	10.360
		lb. per sq. ft. Heating Surface	4.93
		lb. per lb. of Coal as charged	6.9
		lb. per lb. of <i>dry</i> Coal	8.05
		217	

COAL AND ITS SCIENTIFIC USES

- | | | | |
|------|--|---|---|
| (9) | <i>Average Temperature of Waste Gases</i> | { | leaving Boiler 676° Fahr.
in Chimney Flue 592° Fahr. |
| (10) | Average Percentage of CO ₂ in Chimney Gases | | 11.7 |
| (11) | <i>Efficiency on net cal. value of dry Coal</i> | . | 70.3 per cent. |

N.B.—(The current required to drive Electric Motor of Dis-integrator = 105 amps. at 220 volts.)

CHAPTER XII

DOMESTIC HEATING

ACCORDING to the Report of the British Association Fuel Economy Committee (1916), "the amount of coal annually consumed for domestic purposes in the United Kingdom probably does not fall far short of thirty-six million tons per annum, or nearly one-fifth of the total consumption for all purposes in the Kingdom. To this would have to be added the 'coal equivalent' of the gas and electricity consumed for domestic purposes, if a correct estimate of the total domestic coal consumption is to be made."

The wastefulness of the Englishman's cheerful fireplace has always been a favourite theme with those iconoclasts who would prohibit it except in their own homes, and if efficiency were the only consideration there is something to be said for its abolition. But with characteristic conservatism, and disrespect for Science when it counters his cherished customs, the average Englishman undoubtedly has a decided objection to the introduction of central heating systems into his living rooms, and much prefers to be warmed by the radiation from a bright fire.

Hence it is (to quote again from the British Association Committee's Report) "that the whole question of the domestic use of fuel bristles with difficulties and complications . . . (that) . . . the selection or recommendation of particular means or apparatus for domestic heating cannot always be based simply upon the question of thermal efficiency, because it also involves considerations of a physiological and even of a psychological character . . . (and) . . . that there is probably no single solution of the domestic heating problem which is likely to be universally adopted within any measurable period of time . . . (also that) . . . it is necessary to discriminate between fuel or energy consumed in the kitchen for cooking and other similar purposes, and that applied for the heating of ordinary living rooms. In the vast majority of the houses inhabited by the artizan population the kitchen fire or stove is the only place in the house where

COAL AND ITS SCIENTIFIC USES

fuel is burnt; also in better-class houses it is only in the kitchen that fuel is burnt daily throughout the whole year. Hence it would appear that the kitchen is responsible for the greater part of our annual domestic fuel bill, and, therefore, the question of the relative efficiencies of kitchen ranges, gas and electric cookers, and hot-water-supply apparatus assumes considerable importance."

The Committee put forward the following as, in their opinion, the chief objects to be aimed at in any reform of domestic fuel consumption, namely:—

- (1) Actual reduction in cost of domestic heating, either in the form of direct saving of fuel or labour, or both;
- (2) mitigation or abolition of the domestic smoke nuisance; and
- (3) better hygienic conditions in living apartments generally.

A householder in our large cities and towns is usually offered a fairly wide range of choice in respect both of available fuels (or energy) and of the ways and appliances in which to utilise them. He may, for instance, use one or more of the following sources of heat, namely anthracite, bituminous coal, coke or gas from the local gas-works, or even electricity. And he will have no difficulty in finding suitable means for applying each or any of these commodities, either for the cooking of his dinner or the heating of his rooms. Moreover, with the exception of bituminous coal—which, however, practically every house in the kingdom burns—the use of none of them will lay him open to the charge of adding to the pollution of the atmosphere round his dwelling.

Why, then, it may be asked, is raw bituminous coal the universal choice of the average British citizen for his domestic hearth? The question is not easily or simply answered. It is no doubt partly a matter of first cost, partly the force of two centuries of custom and ingrained habit, and lastly because there is something indefinably pleasing about the ever-changing aspect of a coal fire with its dancing flames and genial warmth, which appeals to the "fire-worshipping" instinct of mankind. Also the character of the British winter, with its sombre skies, searching fogs, and rapid changes in temperature, makes an open fire a welcome companion; and the sitting round it is undoubtedly one of the most cherished features of our home-life.

DOMESTIC HEATING

In the severe winters which are prevalent in the corresponding latitudes of North America or Mid-Europe, and still more so in the sub-arctic climates of the farther North, either central heating systems or the closed stove become necessary for domestic heating on grounds of comfort and economy, and, therefore, are almost universally adopted. Also, in countries such as France, where coal is not so abundant as with us, anthracite stoves are largely used. But in Great Britain central heating is mainly confined to hotels and country mansions.

Some idea of the wastefulness of our British open fireplaces and kitchen ranges may be gained from the fact that, whereas with a population of 46 millions we annually consume in our houses about 36 million tons of coal, in Germany, with its population of 67 millions and its severer winter climate, where closed stoves and ranges are universally employed, only 17 million tons are so burned. In other words, each inhabitant of the United Kingdom requires a domestic consumption of 15 cwts. of coal per annum, as against only 5 cwts. in Germany.

Comparing the first cost of energy units in the form (1) of a good house coal of (say) 13,500 B.Th.U.s. per lb. at £1 10s. per ton; (2) of gas of 500 B.Th.U.s. per cub. ft. at 2s. 6d. per 1000 cub. ft.; and (3) of electricity at 1d. per unit, a pound sterling will purchase the possibility of developing the following quantities of heat:—

(1) In the form of coal . . .	20,000,000 B.Th.U.s.
(2) " " " " gas . . .	4,000,000 "
(3) " " " " electricity . . .	825,000 "

These figures, however, do not represent the relative costs of the energy actually utilised in heating apartments or for cooking purposes, because a much greater proportion of the heat developed by the combustion of gas is utilised than by the combustion of coal, and the proportionate loss in the case of electricity is the least of all. The percentage losses in the three cases may be considered as approximately not less than 60 in the case of coal, about 20 in the case of gas, and not more than 10 in the case of electricity. Hence for the expenditure of one pound sterling the following number of " utilised " heat units would probably be obtained:—

(1) <i>Via</i> coal . . .	8,000,000
(2) <i>Via</i> gas . . .	3,200,000
(3) <i>Via</i> electricity . . .	750,000

COAL AND ITS SCIENTIFIC USES

Nor does a fair comparison of the three commodities end here, because not only are gas and electricity absolutely clean and can be turned on and off without trouble at a moment's notice, so that when the heat is not required it need not be developed, but also the labour necessarily expended in maintaining coal fires, and the smoke and dirt which their use entails, are serious items in household economy. Moreover, the use of raw bituminous coal, capable as it is of yielding by proper treatment products whose value to the community far exceeds their mere heating potentialities, must be regarded as a national waste. The use of coke or semi-carbonised coal would, however, remove this reproach.

COAL AND COKE FIRES

A good house coal should be selected for its free-burning qualities and low ash content, and in a closed-in kitchen cooking range with its stronger draught a "harder" coal should be burnt than in the open fireplace of an ordinary sitting-room, or otherwise undue waste will result. Indeed for a properly designed kitchen range of this type a good quality of gas coke is often preferable to most "house coals," either used by itself or in conjunction with the coal.

Even a well-designed closed-in kitchen range may be very wasteful of coal unless those managing it not only regularly remove the accumulation of soot and ashes which are always being deposited in the oven flues, but also control the draught by means of the various dampers according to the varying requirements of each day's operations. If the passage of the hot products of combustion round the oven flues is impeded by undue accumulation of soot and fine ashes therein, the oven cannot be brought to a good baking or roasting heat, and all attempts to force it by opening of the dampers are usually not only futile, but involve great waste of fuel. On the other hand, it may be that if the oven flues are clear and the draught is not checked by the damper, the air is drawn at an unnecessarily high velocity through the fuel, with the result that the fire "roars" and the coal is too quickly consumed. Those who operate kitchen ranges need reminding that the rate at which the glowing coal burns in the grate is determined by the rate at which the air is drawn through it.

In this connection it is well to point out that the design of

DOMESTIC HEATING

many kitchen ranges is defective in that the air is allowed too free an access to the fire when the oven dampers are open, and in such a case the plan of partially closing in the open space between the level of the firegrate and the ash-box below it by means of a wrought-iron plate may be resorted to with the object not only of checking the flow of air, but also of causing it to be directed through the cavity below the grate so that it may be somewhat preheated before it reaches the fire. Indeed, all kitchen ranges should be fitted with means of regulating the inlet of air to the fire, a far preferable way of reducing the draught through the fire than by a damper in the flue, which has the disadvantage of throttling the flue and impeding the products of combustion getting freely away. Also if a pan of water be placed in the ash-box, the warm air passing over it will carry forward into the fire a certain amount of steam, which will generate "water gas" by its endothermic reactions with the incandescent coke, and thus cool the bars and diminish somewhat the loss by radiation from the grate.

A good deal of the smoke emitted from kitchen chimneys may be avoided by the selection of a cooking range provided with properly constructed grooved metal fire-cheeks, in which most of the smoke is consumed by an air supply which, entering the grooves at the bottom and being heated in passing through the cheeks, meets the smoke at the top and causes it to burst into flame.

Before leaving the question of coal consumption in kitchen ranges, something ought to be said about the boiler. In small and middle-class houses, a supply of hot water for domestic use, including baths, can be economically obtained from the range boiler, provided it is scientifically designed and constructed. But, unfortunately, this branch of engineering is not properly understood and has been very much neglected by those whose business it is to select and fix domestic ranges, with the result that tens of thousands of tons of coal are annually wasted by inefficient appliances.

For any one who has even an elementary knowledge of the principles of heat transmission, it is only necessary to examine the average small range saddle-boiler to be convinced of its inefficiency. The ordinary house is usually provided with a 40 to 60 gal. hot-water cylinder or tank, which is often connected with a boiler whose effective heating surface is only 2 or 3 sq. ft. Hence, in order to heat up such a quantity of

COAL AND ITS SCIENTIFIC USES

water quickly, the damper in the boiler flue has to be fully opened, with the result that the fire "roars" and the rate of coal consumption is at least doubled. On the other hand, with a properly designed and proportioned arrangement, a reasonable supply of hot water should be obtained with the boiler damper only slightly opened.

We owe many recent reforms in the construction of house firegrates to the pioneering work and observations of Mr. T. Pridgin Teale, F.R.S., the eminent Leeds surgeon. The principles which he advocated are set forth in a pamphlet on *Economy of Fuel in House Fires* which he published in 1883, and also in a lecture on the "Principles of Fireplace Construction" which he delivered on February 5, 1886, before the Royal Institution of Great Britain, and they have since been embodied in the well-known "Teale" fireplaces.

In the first of these publications he tells that his ideas embody a combination of two conditions, namely, "one, that no current of air should pass through the grate at the bottom of the fire; the other, that the space or chamber under the fire should be kept hot." He laid down seven rules to be observed in the construction of fireplaces, which in substance are as follows:—

- (1) As much firebrick and as little iron as possible to be used.
- (2) The back and sides of the fireplace should be constructed of firebrick.
- (3) The back of the fireplace should lean or arch over the fire so as to become heated by the rising flame, whereby smoke is consumed, and much more heat is radiated into the room.
- (4) The bottom of the fire or grating should be deep (9 to 12 in.) from before backwards, in order that the fire may be made horizontal and slow-burning instead of vertical and quick-burning.
- (5) The slits in the grating should be narrow ($\frac{1}{4}$ to $\frac{3}{8}$ in. in width).
- (6) The bars (if any) in front should be narrow (less than $\frac{1}{2}$ in. thick) and not more than four in number for an ordinary fire.
- (7) The chamber beneath the fire should be closed in front by a shield or "economiser," so as to stop all currents of air that would pass *under* the grate and *through* the fire.

Some of these principles, or the objects aimed at by their

DOMESTIC HEATING

adoption, had been set forth, as Mr. Teale acknowledged, by Count Rumford as long ago as the year 1800, whose words are well worth quoting here :—

“Iron and, in general, metals of all kinds are to be reckoned amongst the very worst materials that it is possible to employ in the construction of a fireplace . . . the best materials I have hitherto been able to discover are firebricks and common bricks and mortar. The fuel, instead of being employed to heat the room *directly*, or by the direct rays from the fire, should be so disposed or placed as to heat the back and sides of the grates, which must always be constructed of firebrick or firestone, and never of iron or any other metal. . . . I should increase the depth of the fireplace at the hearth to 12 or 13 in., and should build the back perpendicular to the height of the top of the burning fuel, and then sloping the back by a gentle inclination forward, bring it to its proper place, that is to say, perpendicularly under the back part of the throat of the chimney.” And in regard to a fireplace whose back was so inclined forward he said : “The flame rising from the fire broke against the part of the back which sloped forward over the fire, and this part of the back being soon very much heated, and in consequence of its being hot (and when the fire burned bright it was frequently quite red-hot) it threw off into the room a great deal of radiant heat.”

Mr. Teale also recommends (1) that the “lean over” at the back of the fire should be at an angle of 70° to the horizontal line of the hearth, also subsequently in a private note to the writer he added, “better an angle of 60° in some cases”; and (2) that the sides of the hearth should form an angle of 60° with the front base line so as not to cut off radiation from the back part of the fire. Thus in plan the ideal form is based upon an equilateral triangle, as shown in the accompanying diagram (Fig. 29).

In 1887 Mr. Teale, in conjunction with his son, worked out a design, since known as the “Front Hob Fireplace,” which embodied, in the most perfect form, the principles advocated in his Royal Institution Lecture the year previously. In it, either the hearth is raised to form the front of the fire, or the fire space is sunk below the level of the hearth, thereby doing away altogether with the use of front bars, and their impeding effect upon free radiation. This innovation was the forerunner of the numerous “barless” fires which have since come so much into vogue for the heating of apartments.

COAL AND ITS SCIENTIFIC USES

Among other improved domestic fireplaces should be mentioned those in which provision is made for regulating combustion, according to the needs of the moment, by means of doors or fronts closing up in sections. For very slow combustion the lower section, formed of two doors, is closed over the front of the fire so as to exclude all but the small amount of air required to keep it smouldering until such time when a greater heat is required. When it is necessary to increase the heat, the upper doors are shut and the bottom ones opened, thus forming an efficient "blower," and a hot bright fire is quickly obtained. Such a device is invaluable for sick rooms, where a fire has to be

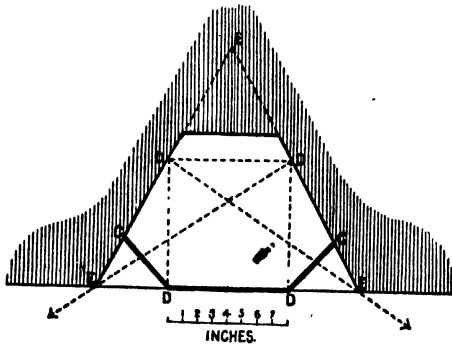

FIG. 29.—"Economiser" Fireplace.

maintained throughout the night, or for dining-rooms, where it is only wanted at certain hours of the day.

Although the practice of burning raw bituminous coal in domestic stoves and fireplaces is to be condemned as dirty and unscientific, it by no means follows that the open fireplace ought to be abolished. The proper solution of the domestic problem lies rather in the directions of (1) providing all houses with stoves and fireplaces designed and constructed in accordance with sound principles; and (2) burning in them some form of carbonised coal or gas.

The proposal to manufacture for domestic consumption a smokeless "semi-coke" by carbonising bituminous coals at low temperatures is scientifically sound, if it can be carried out on commercial lines in such a way as to yield a product which will not only stand transport reasonably well, but can also be sold

DOMESTIC HEATING

to the consumer at a price not exceeding that of a good house coal. To make it coherent enough to stand transport by rail such a "semi-coke" might be briquetted with, if necessary, a small addition of a suitable binding agent. If such conditions can be fulfilled on a large scale, the domestic hearth would be freed from its present reproach of being a prolific smoke-producer, and the Englishman could satisfy with a clear conscience his love of an open fire.

To burn gas-coke or anthracite requires a stronger draught than is given by the slow combustion grates of the Teale type. Anthracite may, however, be burned efficiently in a properly constructed closed stove, provided that a good draught is allowed and that the flue is properly connected with a chimney, so that the products of combustion are all vented into the outside atmosphere without contaminating the air in the room. Such stoves are largely used on the Continent, and to a limited extent also in the London area. They are kept burning continuously day and night throughout the winter, and for many purposes, such as, for example, heating a library or a room where musical instruments are kept; they are clean and economical, and after being once lighted up they require but little attention.

Although gas-coke is more difficult to burn than bituminous coal in an ordinary domestic fireplace, there is no particular reason why fireplaces should not be constructed so as to overcome the difficulty. The main thing is a good draught with a deeper but narrower fuel bed than is used for bituminous coal. The chief objection to gas-coke as a domestic fuel is its greater ash content than a good house coal. Coke intended for domestic use should be manufactured from coal specially selected for its low ash content and should be broken and screened into a suitable size before delivery to the consumer.

Dr. A. Vernon Harcourt, F.R.S., recently described, in a paper before the Royal Society of Arts,¹ a type of fireplace designed and used for many years by him, which he claims as being specially adapted for the burning of coke in sitting-rooms.

The grate, which is designed to yield as much radiant heat as possible from the fuel, supports an upright wall of coke, 4 to 4½ in. from back to front, and varying in width from 8 to 24 in., according to the size of the room to be heated. The grate consists of a series of slender horizontal bars in front, and a firebrick slab underneath and at the back. There are

¹ *Journ. Roy. Soc. Arts*, LXIII. (1915), p. 570.

COAL AND ITS SCIENTIFIC USES

ten such bars, each successive pair being 2 in. apart, so that the height of the grate from the base to the top is 25 in. It is filled to the top with coke, and on this is laid paper and wood, or other fire lighter, and a layer of coke with a few pieces of coal reaching nearly to the throat of the chimney. The fire burns, as it were in sections, from the top downwards like a candle. The air is directed on to the uppermost section of incandescent fuel by the slight suction effect of a metal screen, or shutter, which is extended or pulled downwards as successive sections of the fire are brought into operation. The grate is charged each morning with an amount of fuel sufficient to last the whole of the day; and the fuel having been lighted at the top, no replenishment is needed during the day.

Such a fire presents certain good features, which are worth consideration by would-be designers of domestic fireplaces. In the first place, the face of the fire is vertical, so that the chief radiation is horizontal, and not, as in many coal fires, directed largely towards the chimney or to the ceiling. Secondly, the fire is narrow from back to front, so that there is a minimum impediment to radiation from the back parts of the glowing fuel; and, thirdly, the air required for combustion passes in through the front bars, and not through a grate underneath. This last is an important condition, because the chief seat of vivid combustion, and therefore of intensest radiation, in a fire is where the air and fuel meet, which place should, therefore, be at the front of the fire and not underneath it. Dr. Harcourt stated in his paper that, when the width of the grate is 18 inches, a charge of 34 lbs. of gas-coke fills the grate and maintains a good fire for 14 hours, which with coke at £1 per ton would entail a cost of 3 $\frac{2}{3}$ d.

With regard to the relative merits of coal and coke as a domestic fuel, Dr. Harcourt says:—

- (1) "Bulk for bulk, coal is nearly twice as heavy as coke, burns for longer under the same conditions, and from an open grate radiates rather more heat because it lasts longer."
- (2) "Weight for weight, coke has the advantage for domestic use, and would retain it even if through increased demand the price of the two were the same."
- (3) "If public benefit can be brought into account, the advantages of the use of coke for domestic fires are very great. The fires are smokeless."

DOMESTIC HEATING

Many people, unacquainted with the science of combustion, have at various times had the notion that the sprinkling of coal or coke with a minute quantity of a solution of some mineral substance, such as common salt, will, somehow or other, give a better effect as regards heating a room. Thus, for example, on November 4, 1915, there appeared a letter in *The Times* newspaper from a correspondent, saying how he had considerably reduced his domestic coal bill by the simple expedient of dissolving a large tablespoonful of salt in somewhat less than a pint of water, and sprinkling this fluid from a watering-can over a hundredweight of coal spread out over the floor of the coal-cellar, taking care that each piece of coal got some part of the fluid. "I am aware," he continued, "that my scientific friends will regard the whole matter with scepticism; for they will say, no doubt rightly, that it is impossible to increase by any process of doctoring the number of thermal units which are contained in a hundredweight of a particular kind of coal. But it seems possible that a method of doctoring which leads to more complete combustion may nevertheless be a method of saving coal, and I would also not exclude the possibility of a psychological process at work."

It is perhaps an index of the lamentable ignorance which prevails in this country with regard to the elementary principles of chemical science that the real efficacy of such a procedure should nowadays be seriously entertained. The results of scientific investigations certainly afford no ground for the belief that the mere sprinkling of a large quantity of coal or coke with so minute a proportion of a solution of a mineral salt will in any way materially increase its heating effect, although, of course, the wetting of a fire does tend to increase its life, without, however, adding either to the total amount of heat developed by the combustion of a pound of the fuel, or that proportion of it which is radiated into the room.

In regard to the general question raised in the letter referred to, it may be noted incidentally that Dr. Harcourt has recorded the results of some experiments which he made with his fire to test whether sprinkling the fuel with a small quantity of a solution of a powder, mainly composed of common salt, would give a better or more economical effect as regards heating a room.

A heaped teaspoonful of the powder was stirred up in a pint of water and three scuttlesful of coal were sprinkled with the

COAL AND ITS SCIENTIFIC USES

resulting fluid. He was, however, unable to find that such treatment resulted in any material difference in the rate of burning the fuel. Any difference there was seemed to be due to the water added. He then proceeded, with the aid of a simple type of instrument, called a "radio-thermometer," devised and constructed for measuring the relative amounts of heat radiated from the fire, to carry out a number of measurements of the radiation from coal and from coke when (1) dry, (2) soaked in water, and (3) sprinkled with a minute quantity of the fluid. The results showed no material difference in the radiation obtained from the untreated or treated fuel, although the heat radiated from coke which had been *soaked* in water was only about two-thirds of that derived from the same coke in its natural state. He therefore concluded that coke, whether sprinkled or not with such fluid, radiates practically the same amount of heat, a result which will hardly surprise any person who is moderately informed about the science of combustion.

GAS FIRES

The gas oven for cooking purposes is now so well established in the kitchen of all types of houses throughout the Kingdom, that it hardly needs more than a passing reference. Its popularity is doubtless due in the first place to its being ever ready for operation at a moment's notice with a minimum expenditure of time and fuel; next, to the ease with which the heat may be regulated so as to suit the work in hand; and finally, to its cleanliness, convenience, and general efficiency. These advantages have combined to secure for it an assured position in our domestic economy.

Until recent years, however, the use of gas fires for living apartments was viewed askance by perhaps the majority of British people, as being not only unhealthy but also generally unpleasant. And it must be admitted that the crude gas fire of even ten years ago left much to be desired on both these counts. The attitude of most people at that time towards the gas fire was once aptly described by an old lady who said she could always "smell one being lighted in the next street." The medical profession in general was also prejudiced against the use of gas in living apartments, on grounds which scientific investigation has proved to be illusory, at least so far as any modern types of such fires are concerned.

DOMESTIC HEATING

The typical gas fire of to-day consists essentially of a series of atmospheric burner nozzles, varying usually between seven and fifteen in number, according to the size of the apartment to be heated, arranged equidistantly along a common horizontal supply pipe, provided with suitable means for properly adjusting the relative gas and primary air supplies so as to ensure a vertical series of non-luminous and, as nearly as possible, silent bunsen flames of uniform height and character. Above each flame is fixed a hollow fireclay columnal "radiant," perforated in a manner expressly contrived to promote uniform heating of the column throughout, and with each flame rising into the cavity of its particular radiant. Care is taken to prevent any impingement of the inner cone of the flame upon its radiant. The back of the fire is formed by a fireclay slab fixed vertically behind the radiants, which are held in position by means of one slight horizontal iron rod. At a suitable distance above the top of the radiants is fixed a metallic hood or "canopy," by means of which the products of combustion are collected and discharged through the flue vent into the chimney, without contaminating the atmosphere of the apartment. This arrangement of burners, radiants, canopy, and the flue vent is suitably enamelled dull black. Needless to say the flue vent of the fire should not only be ample in area but should also be properly connected with a good chimney, which is as necessary to a gas as to a coal fire. The fire should be either built into an existing chimney breast, or, if placed in front of it, the chimney breast should be closed in except for an opening just large enough to allow of the passage through it of the flue pipe of the fire, and such further openings as may be required to allow of the necessary ventilation of the apartment as hereinafter mentioned.

It cannot be too often insisted that, whereas with a flue vent of sufficiently large area and a good chimney draught, a properly constructed gas fire will in addition to warming, also satisfactorily ventilate a room, everything depends on the draught, and above all, upon the absence of down-draught. For the mere substitution of a gas for a coal fire will not of itself cure a down-draught, as some people seem to think, unless the gas fire be installed in a scientific manner with due regard to all the circumstances.

The energy developed by combustion in a gas fire is dissipated in one or other of three ways, namely:—(1) a considerable proportion is directly radiated into the apartment; (2) another part

COAL AND ITS SCIENTIFIC USES

is carried off as "sensible heat" by "conduction" through the metal casing and fittings, whence it is imparted to currents of air which come into contact with them, thus creating "convection" currents in the room; whilst (3) the remainder is carried off up the flue in the heated products of combustion *plus* the excess air which the fire vents with them up the chimney.

Of these three portions, (1) passes instantaneously in straight lines through the air of the room, without sensibly heating it, until it strikes some surface, such as the walls or furniture of the apartment, or the body of some occupant, which will partly or wholly absorb and convert it into sensible molecular heat, which latter is eventually imparted as "convected heat" by such objects to the air of the room coming in contact with them; (2) goes to heating directly the air of the room; whilst (3) is the only part which is ultimately lost, although it indirectly does useful service in ventilating the room. The object of a properly designed gas fire should be to secure the maxima of radiant and ventilating effects with a minimum of "flue heat," and there is no doubt that the greatly improved types of fires which several of the leading makers have put on the market within recent years do achieve successful results in this direction.

The first scientific investigation of the heat balance of a gas fire was made, under the author's general supervision, at the University of Leeds on behalf of a Committee appointed in 1907 by the University in conjunction with the Institution of Gas Engineers. The experimental methods employed are described in detail in their first Report which was published in 1909.¹

In investigating such a heat balance, it is usual to determine the aforementioned parts (1) and (3), that is to say the "radiant efficiency" and the "flue heat," by direct measurement, leaving (2), that is to say the percentage of "convected heat," to be estimated by difference. In the Leeds investigation, the method adopted for determining the "radiant efficiency" consisted essentially in firstly establishing, by thermopile readings, a relation between the intensity of the radiation at a central equatorial area in a hemisphere in front of the fire and the total radiation received over the whole hemisphere (a relation which is sometimes called the "distribution factor" of the fire), and then in determining, by means of a radiometer of the water calorimeter type, designed by Professor R. H. Smith, the actual number of calories radiated by the fire per hour on to the said

¹ *Trans. Inst. of Gas Engineers*, 1909, pp. 59 to 101.

DOMESTIC HEATING

central equatorial area. The number of such calories multiplied by the "distribution factor" of the fire gives a measure of the total energy radiated by the fire per hour in terms of calories, and the relation of this to the total *net* heat developed by the combustion of the gas in the fire per hour gives the radiant efficiency of the fire.

The Leeds Investigation.—In the Leeds experiments a gas fire, which may be taken as representative of those ordinarily supplied at the time (1907-9) to consumers by the leading makers, was tested in a specially constructed double-walled chamber in such a manner that the amount of air carried up the flue along with the hot products of combustion could be controlled within wide limits by means of a small electrically-driven fan, which fitted exactly into the outer end of the flue. The dimensions of the experimental chamber were 9 ft. \times 9 ft. \times 9 ft., and its internal capacity, after allowing for the various instruments installed therein, was 710 cub. ft. It was built of tongued and grooved boards within one of the rooms of a building adjacent to the Fuel Department of the University of Leeds, and it was made as nearly air-tight as possible by lining the inside walls, floor and ceiling with calico coated with asbestos paint, whilst the outside walls were coated with pitch. The fire had seven bunsen burners, all connected with the same gas and air supplies, which were adjustable; combustion took place within seven fireclay "radiants," along the top of which several other pieces of similar material were arranged. The back of the fire was formed of a thick firebrick slab, and the products of combustion passed away by means of a hole ($4\frac{1}{2} \times 1\frac{1}{2}$ in.) into a copper flue (6×4 in.) which was well lagged by means of asbestos. The incandescent front of the fire measured 9×9 in.

The average gas consumption of the fire was 17 cub. ft. per hour, measured *dry* at 0° C. and 760 m.m., whose net calorific value was about 570 B.Th.Us. per cub. ft. The air supply to the burner was so arranged that, after getting a distinct inner cone, it was adjusted until a slightly hazy inner cone was obtained. The flame was then of such a size and shape that the outer cone, where combustion was being completed, very slightly impinged on the fireclay.

In the following experiments (Table LV), which are quoted as typical of the rest, the fire was so fixed that its centre was horizontally opposite that of the radiometer; in Nos. 16 and 17, the fan was not working, so that the draught conditions were

COAL AND ITS SCIENTIFIC USES

quite normal, whereas in Nos. 13 and 14, with the fan on, a considerable volume of surplus air was drawn up the flue.

TABLE LV
LEEDS EXPERIMENTS ON GAS FIRES (1907-1909)

Experiment No.	Gas Consumption Cub. Ft. Per Hour at 60° C and 760 m.m.	Net Cal. Value of Gas, B.Th.U. per Cub. Ft. at 60° C and 760 m.m.	Percentage of Net Heat of Combustion.			Cub. Ft. of Air passing up Flue per Hour at 60° C and 760 m.m.	Temperature Flue Products ° C.	Carbon Dioxide. Parts per 10,000.	
			(1)	(2)	(3)			In Room.	Out- side.
			Radiated	Convected	Carried Off up the Flue				
13	17.62	546.4	35.30	19.57	45.13	2100	85.0	3.62	3.55
14	17.90	585.3	31.10	31.20	37.20	1760	89.5	3.70	3.54
16	18.10	565.3	27.37	51.21	21.42	494	132.2	6.0	3.20
17	17.34	562.2	30.60	50.63	18.77	538	128.0	5.7	3.30

The principal conclusions which may be drawn from the investigation may be summarised as follows:—

(1) That the total radiation from an open gas fire of that date averaged as nearly as possible one-third of the total net heat of the combustion of the gas burnt, and that it was unaffected by the amount of ventilation through the room.

(2) That the amount of surplus air vented up the flue pipe under normal conditions of draught was comparatively small. It is generally considered that the air of a room should be changed not less than three times per hour, and when this degree of ventilation was reached with the aid of the fan in Experiment 13, not less than 45 per cent. of the heat was carried away up the flue and about 20 per cent. of it only was imparted to the room as "convected" heat. The total energy utilised in this Experiment was 55 per cent. of the *net* heat of combustion of the gas.

(3) That the proportion of the flue heat increased and that of the "convected" heat decreased with the ventilating effect of the fire.

(4) That the combustion of the gas to carbon dioxide and steam was substantially complete in all experiments, and that no trace of noxious products escaped into the atmosphere of the room heated. Also that (as in Experiments 13 and 14) the amounts of carbon dioxide and steam added to the atmosphere

DOMESTIC HEATING

of the room were practically negligible, as the following figures show :—

Experiment.	Cub. Ft. Surplus Air per Hour.	Parts CO ₂ per 10,000 Air		Grains of H ₂ O per Cub. Ft. Air.	
		Outside Room.	Inside Room.	Outside Room.	Inside Room.
13	2100	3.55	3.62	3.4	4.3
14	1760	3.54	3.70	2.7	4.1

RECENT DEVELOPMENTS IN GAS FIRES

Thanks mainly to the stimulus imparted by the Leeds investigation, all the leading manufacturers of gas fires have within recent years set up scientific departments in their own works, with the result that further great improvements have been made both in regard to the radiant efficiencies and the ventilating capacities of the fires. These improvements were admirably summarised by Mr. H. James Yates, whose well-known pioneering work in this direction has been responsible for many of them, in papers which he read at the British Association Meetings (Chemical Section) in 1913 and 1915.¹ In conjunction with Professor H. L. Callendar and the author he also worked out a new Bolometric Method of determining the Efficiencies of Radiating Bodies (now known as the B-C-Y Method) which is much more rapid and accurate than the Leeds Radiometric-cum-Thermopile Method.²

TESTS AT THE IMPERIAL COLLEGE OF SCIENCE AND TECHNOLOGY, LONDON, ON RADIATING EFFICIENCY OF A MODERN FIRE

In December 1914, Bone, Callendar and Yates applied their new bolometric method to the determination of the radiant efficiency of a 10-inch gas fire working on London coal gas, of average net calorific value 521.5 B.Th.U.s. per cub. ft. at 6° and 760 m.m., in a laboratory at the Imperial College of Science and Technology, 38 ft. × 32½ ft. × 15 ft. high, the temperature of which varied between 14° and 17° C. during the

¹ *British Association Reports*, 1913 (Birmingham), p. 435, and 1915 (Manchester), p. 390.

² *Proceedings of the Royal Society*, (A) XCI. (1915).

COAL AND ITS SCIENTIFIC USES

various tests. The average gas (dry) consumption was 24.25 cub. ft. per hour at 0° C. and 760 m.m., which was supplied at a constant pressure. The results of ten separate tests made on seven different days (see Table below) showed an average radiant efficiency of 45 per cent., reckoned on the *net* heat of combustion of the gas burnt, which was a very marked advance upon the performance of the gas fire as it existed at the time of the Leeds investigation.

TABLE LVI

Date.	Barometer m.m.	Dry Gas Consumption Cub. Ft. per Hour at 0° C. and 760 m.m.	Net. Cal. Value of Dry Gas B.Th.Us. per Cub. Ft. at 0° C. and 760 m.m.	Radiant Efficiency per cent.
Dec. 9 . .	750.3	24.00	523.8	44.8
„ 10 . .	752.5	24.49	519.9	45.0
„ 11 . .	746.1	24.25	518.2	43.2
„ 14 . .	732.7	23.78	516.6	46.0
„ 16 . .	748.4	24.19	523.0	46.6
„ 17 . .	761.1	24.77	525.0	44.6
„ 17 . .	764.7	24.49	525.0	44.6
„ 17 . .	763.2	24.51	522.6	45.5
„ 17 . .	763.2	24.26	522.6	45.5
„ 18 . .	751.4	23.82	518.2	44.0
Mean = 45.0.				

Mr. Yates's Work on the Problem of Ventilation.—As Mr. Yates correctly pointed out in his British Association paper in 1913 (*loc. cit.*), “the problem of total heating efficiency is however not the only one which makers of gas fires have to solve; the equally important question of ventilating effect must be considered, for a properly constructed gas fire should effectively ventilate as well as heat an apartment.”

It is not sufficient that a fire, when connected with a chimney flue in the ordinary way, should merely allow no products of combustion to escape into the room, an elementary hygienic condition which must in any case be fulfilled, but it ought to produce a ventilating effect comparable with that of a coal fire. It is not difficult to design and proportion the flue vent and the canopy of a gas fire to ensure the drawing up the flue of a large volume of air in excess of that required for combustion, thus producing good ventilation. The real difficulty has been to

DOMESTIC HEATING

avoid drawing this excess of air over the upper portion of the radiants, thus cooling them, and unnecessarily diminishing the radiant efficiency and correspondingly increasing the "flue heat." A scientifically constructed gas fire ought to ensure good "ventilation" without sacrificing radiant efficiency.

Mr. Yates's investigations have shown that the last-named condition can be fulfilled provided (1) that the area of the flue vent behind the fire is large enough; and (2) that an adequate vertical distance between the top of the radiants and the bottom of the canopy of the fire is preserved. Applying the Leeds Method to a series of gas fires of different sizes, so constructed as to fulfil these conditions, he obtained the following interesting series of results, the fire in each case being properly connected with a chimney 30 ft. high:—

TABLE LVII
MR. H. JAMES YATES'S TESTS UPON GAS FIRES (1913)

Width of Fire. Inches.	Dry Gas Consumption Cub. Ft. at 0° C. and 760 mm. per Hour.	Cal. Value of Dry Gas B.I.U.S. Per Cub. Ft. at 0° C. and 760 mm.	Per cent. CO ₂ in Flue Products.	Temp. of Flue Products ° C.	Percentage of Net Heat.		
					Radiated.	Con- vected.	In Flue Products.
10	25·24	568·5	0·90	117°	47·8	21·4	30·8
14	34·02	577·5	0·80	104°	50·3	19·0	30·7
17	42·62	568·2	0·93	109°	49·2	21·4	29·4
21	52·90	574·5	0·77	101°	51·0	22·6	26·4

In his second paper (*loc. cit.*) Mr. Yates described a newly designed gas fire which, when properly connected with an ordinary chimney, not only removed at least twice as much air from a room (11,800 cub. ft. per hour as compared with 4500 to 5000 cub. ft.) as did the previous best types for the same gas consumption and radiant efficiency, but approached the ventilating capacity of an ordinary open coal fire as closely as is necessary for the maintenance of a perfectly fresh atmosphere in the apartment heated. Briefly described, the new contrivance provides two outlets to the chimney so designed and proportioned that by the under outlet the entire combustion products are carried

COAL AND ITS SCIENTIFIC USES

off, whilst by the upper or "ventilating" outlet a large volume of excess air (the amount of which may be controlled by a simple device) is also removed.

Other Improvements.—In addition to the aforesaid great improvements which have been effected in regard to the radiating efficiencies and ventilating effects of gas fires since the days of the Leeds investigation, manufacturers have devoted a good deal more attention than formerly to the construction of the burner arrangements with a view to obtaining a perfectly silent combustion of the gas, and so suppressing the unpleasant "burring" noise which the older type of fires always made. The combined result of these investigations in which the scientific staffs employed by the various manufacturers have participated, has been the evolution of gas fires which, besides having a high radiant efficiency, are both thoroughly hygienic and practically silent in their combustion, and from these points of view they may be unreservedly commended.

CHAPTER XIII

THE SMOKE NUISANCE AND ITS ABATEMENT

THE EVILS OF SMOKE

NEXT to the waste of valuable by-products, otherwise recoverable, the most serious evil attendant upon the use of raw bituminous coal as a fuel is the pollution of the atmosphere with the smoke which daily issues from our factories and domestic chimneys.

This evil, which is ever present in our large centres of population, not only deprives us of much beauty of form and colour that we might enjoy both in Nature and in Art, but spells death or disease to thousands of our fellow-men. Some years ago it was estimated that the material loss and damage due to smoke in London amounts to £4,000,000 annually, whilst, according to the Chairman of the Air-Pollution Board appointed by the Manchester Corporation in 1912, the measurable damage done in Manchester and Salford by smoke amounts to nearly £1,000,000 per annum, in addition to the immeasurable evil effects of smoke and fog upon public health.¹ Also, it must be remembered that, besides the direct damage to buildings and public health, the smoke cloud which hangs over our large industrial areas greatly reduces the amount of available sunlight, at times by as much as 50 per cent., and that the baneful effects of such reduction upon vegetation and human health, especially that of children, are very serious. Thus in the course of an investigation carried out by Dr. G. H. Bailey and others at the Owens College, Manchester, during the years 1888-90, at the instance of the Manchester Field Naturalists Society, it was found that throughout a continuous period of twelve months the inhabitants of the Hulme district, a typical artisan area within the city, received only 50 per cent. of the

¹ *Report of Discussion upon Smoke Abatement and Air Pollution at the British Association* (Manchester), 1915. *B.A. Reports*, 1915, p. 387; also *Report of the Sanitary Committee of the City of Manchester on Air Pollution*, April 1915.

COAL AND ITS SCIENTIFIC USES

actinic rays of sunlight which fell on the more favoured dwellers in the suburban district of Didsbury some four miles away. Also, that during three days of a dense winter fog no less than 0.75 ton of soot and 1.5 cwt. of sulphuric acid fell on every square mile within the industrial area of Manchester.

According to subsequent experiments carried out in Leeds by Professor J. B. Cohen and Mr. A. G. Ruston in 1907, no less than 450 tons of soot fall per square mile per annum in the industrial area of Hunslet, whilst over another city area of 16 square miles the amount averages 220 tons per square mile per annum; it was estimated that the pall of smoke which continually hangs over Leeds absorbs as much as 40 per cent. of the total daylight during the year.

Mr. A. G. Ruston of Leeds University reported to the British Association in 1915 (*loc. cit.*) that, in regard to the damage done to vegetation in the Leeds area, not only do plants suffer from this general reduction of sunlight, but the black deposit upon the leaves still further hinders the sunlight from getting into contact with the green colouring matter of the leaf, while the acids present in the smoke damage its structure and hasten its fall. Damage is also done to the roots of plants, especially those possessing few root-hairs or fibrous roots. Moreover, the acid rain falling on the soil limits the activity of the bacteria, and especially of the most useful nitrifying organisms in it. It has also recently been found that the enzymes or ferments which are mainly responsible for the chemical changes taking place in the plant are inhibited by smoke pollution. This causes a distinct cutting down of the intensity of colour in the plants, and also handicaps them in forming any reserves, either in the form of bulbs or seed, and considerably reduces the germination capacity and energy of seeds, thus generally lowering the vitality of plants and preventing them from putting up a fight against adverse conditions.

PARLIAMENTARY ENQUIRIES AND LEGISLATION

The baneful effects of smoke in cities has been a public question ever since the use of raw coal as a domestic and raw fuel began. Thus we find the citizens of London as long ago as 1648 petitioning Parliament against the importation of coal from Newcastle because of the smoke nuisance created by its use, and although the petition failed, it is said that some time afterwards a pro-

THE SMOKE NUISANCE AND ITS ABATEMENT

clamation was issued forbidding the burning of coal whilst Parliament was sitting.¹

At various times during the nineteenth century Select Committees of the House of Commons were appointed to enquire into the smoke nuisance with a view to legislative enactments for its abatement. The first of these reported in 1819, but apparently nothing in the way of legislation resulted from its labours. The question remained in this unsatisfactory state until 1843, when a second Committee took it in hand again and reported that, while the time was ripe for the enactment in the public interest of a law requiring the owners of stationary steam engines to abate "the issue of opaque smoke" from their chimneys, it was undesirable to include metallurgical furnaces in the suggested Bill.

The publication of this second Report led the Government of that day to appoint Sir Thomas de la Beche and Dr. Lyon Playfair to investigate the matter from a scientific standpoint. But even their recommendation (1846) of the imposition of a fine "when the emission of smoke is due to the carelessness of those entrusted with the management of the furnaces" led to no more effective action beyond the sanction in several Local Improvement Bills of Clauses dealing with smoke abatement.

In 1855 another detailed Report was made to the Government, this time by the General Board of Health, which included, in addition to much sound advice, the opinion "that notwithstanding the great and obvious advantage of perfecting the combustion of fuel, and the certainty that the cost of doing so will be amply repaid by the saving effected, such is the indisposition of practical men to depart from the beaten track, that nothing but the force of law is likely to ensure the care and attention necessary to protect the public from a grievous nuisance, the manufacturers themselves from heavy unnecessary expense, and the national resources from grievous waste of fuel to the amount of millions a year."

So ingrained and persistent, however, was the *laissez-faire* attitude of the Governments of those days in regard to legislative interference with industry, even when the clearest case had been established for such action in the public interest, that it was not

¹ See *Smoke Abatement*, by William Nicholson, Chief Smoke Inspector to the Sheffield Corporation (Griffin & Co., 1905), p. 18, a manual which admirably summarises the history of legislation in this and other countries against the smoke nuisance, and to which the reader is referred for further details than can be given in this chapter.

COAL AND ITS SCIENTIFIC USES

until the passing of the Public Health Act in 1875 that any special law was enacted to enforce some mitigation of the more flagrant aspects of the smoke nuisance. Sections 91 to 108 inclusive of that Act made the emission of black smoke from any chimney (not being the chimney of a private dwelling-house) "in such quantity as to be a nuisance" one of the nuisances "liable to be dealt with summarily in manner provided by this Act," and so far as general legislation is concerned, this is the only Act of Parliament under which fines for the emission of smoke can be levied. Some of the larger municipalities,¹ however, have got special provisions in their local Acts and Bye-laws for the abatement of the smoke nuisance, but it is to be feared that public opinion on the subject has been, in most cases, so apathetic that the powers thus conferred are too sparingly and haltingly used. In 1914 the Local Government Board appointed a Departmental Committee to review the whole question of Smoke Abatement in the light of recent research, but, unfortunately, its meetings were suspended soon after the outbreak of the war.

RECENT INVESTIGATIONS BY PUBLIC BODIES

The recent appointment (1912) by the Corporation of Manchester of an Air-Pollution Board composed of public men, manufacturers, and scientific experts, to investigate with the object of propaganda and research instead of the older method of prosecutions may be welcomed as a sign that in the near future public bodies will take up the matter anew on better lines.

The Manchester Board has set itself to tackle the question of the reduction of domestic smoke by laboratory research in the belief that much remains to be done in the direction of improvements in coal and coke fires, gas fires, and by developing the use of semi-coked coal. As regards factory smoke, the view taken by the Board is that the chief problems are the design of mechanical stokers and the supply of air at the correct point to ensure smokeless combustion, and that they can only be solved by large-scale experiments carried out either by, or in conjunction with, manufacturers.

The Health Committee of the City of Sheffield has, in conjunction with the University, recently (1914-15) undertaken

¹ *E. g.* London (1891), Edinburgh (1879 and 1892), Glasgow (1892), Manchester (1882), Salford (1862), Leeds (1866), Sheffield (1900), and Bolton (1872).

THE SMOKE NUISANCE AND ITS ABATEMENT

experimental work extending over twelve months, on the distribution of smoke in various areas within the city (manufacturing and residential), the result of which has indicated that the amount of pollution in the Attercliffe industrial area in the east end of the city, where the armament works are situated, is roughly about twice as great as in three other areas situated, respectively, N.N.W., W. and S. of the centre of the city. It is also stated by Professor W. P. Wynne, who directed the work, that if an opinion as to the contribution of house fires to the pollution of the atmosphere may be based on the proportion of tar and ammonia collected by the rain, no difference could be traced between the values for the summer and the winter six months.

Mention should also be made of the work of the Coal Smoke Abatement Society formed in London in the year 1898, which mainly deals with the matter as it affects the Metropolis. There is good reason for the belief that in recent years black fogs have been decidedly less prevalent in London than formerly, a circumstance which is probably partly due to improved domestic fire-grates, and partly also to the growing and now very considerable use of gas fires in the residential areas.

THE NATURE AND COMPOSITION OF SMOKE

In order that the reader may rightly understand something of the relative harmfulness of domestic and factory smoke, respectively, as contributory factors to the general smoke nuisance, about which diverse opinions have been expressed, it is necessary to discuss the nature and composition of each, as revealed by recent chemical investigation.

Speaking generally, coal smoke consists essentially of carbon, tarry hydrocarbons, ammonium salts, and mineral matter (ash), and it frequently has an acid character. But the soot deposited in, or emitted by, chimneys varies considerably in character and composition, according to the circumstances under which the coal is burnt, and the height of the chimney stack, and, in the case of boilers, the distance of the latter from the furnace.

The smoke-producing constituents of coal are chiefly those which decompose at comparatively low temperatures, and black smoke, which is always a sign of incomplete combustion, is produced by the destructive distillation of the more volatile portions of the coal substance. The direct heat loss occasioned by smoke, including that due to the unburnt gases associated with it, is

COAL AND ITS SCIENTIFIC USES

usually not so considerable as is sometimes thought, and with good coals and careful firing need not exceed 5 per cent., but with soft coal and under bad conditions, it sometimes amounts to over 10 and even as much as 20 per cent. of the total heat of combustion of the coal (*vide* Tables XLVIII and L in Chapter XI).

We are indebted to the researches of Professor J. B. Cohen and Mr. A. G. Ruston of the University of Leeds for perhaps the most complete chemical examination yet published of the soot produced from a typical British bituminous coal when burnt under different conditions.¹

The following analyses, taken from their papers, show very clearly how the composition of the soot from a given coal varies not only according to whether it is burnt in an ordinary domestic grate or at the higher temperature of a boiler furnace caused by the stronger draught of a chimney 110 ft. high, but also, in the latter case, according to the distance up the chimney :—

TABLE LVIII
ANALYSES OF SOOT

	Coal.	Domestic Soot.	Soot from a Boiler Chimney.		
			At Base.	70 ft. up.	Top 110 ft.
Carbon . .	69.30	40.50	16.66	21.80	27.00
Hydrogen . .	4.89	4.37	0.86	1.44	1.68
Nitrogen ² . .	1.39	4.09	nil	1.18	1.21
Sulphur . .	1.74	2.99	2.07	2.58	2.84
Chlorine . .	0.27	5.19	0.11	1.46	1.60
Tar	1.64	25.91	0.09	0.80	1.66
Ash	8.48	18.16	75.04	66.04	61.80
Acidity . .	0.00	0.37	1.33	0.58	0.56

The chief points to be observed in regard to these analyses are, first of all, the marked difference between the composition of domestic and factory soot, and secondly, the variations in the latter as the chimney is ascended. The domestic soot contained about twice as much carbon, twenty times as much tar, nearly four times as much nitrogen (ammonium) compounds, but only a fourth of the ash, found in the boiler soot, whilst in the case of

¹ *Nature*, Oct. 14, 1909; *Journal of Gas Lighting*, Nov. 30, 1909; and *Journ. Soc. Chem. Ind.*, 1911, p. 1360; also their book on *Smoke and Town Air* (Ed. Arnold, London).

² The nitrogen in soot is chiefly in the form of ammonium chloride and sulphate.

THE SMOKE NUISANCE AND ITS ABATEMENT

the latter, the carbon and nitrogen contents increased, and the proportion of ash diminished, as the chimney was ascended. All this points to the coal having been less completely burnt in the domestic grate, whilst in the presumably hotter boiler chimney there was less opportunity for the more volatile constituents of the smoke to condense. The stronger draught of the boiler chimney caused more of the ashes of the coal to be carried over mechanically with the smoke, and the heavier mineral matter was deposited sooner in the flues than the lighter carbon. The composition of "domestic" soot from a given coal is also liable to considerable variation, according as to whether it is burnt in an ordinary open sitting-room grate, or at the higher temperature and in the increased draught of a kitchen range, as the following analyses indicate:—

TABLE LIX
PERCENTAGE COMPOSITION OF SOOT FROM A COAL BURNT IN
DOMESTIC FIRES

	Coal.	Soot from Kitchen Chimney.	Soot from Dining-room Chimney.		
			5 ft. up.	20 ft. up.	35 ft. up.
Carbon . .	76·80	52·3	36·5	34·1	37·2
Hydrogen . .	4·90	3·7	3·5	3·5	3·5
Nitrogen . .	1·72	4·11	6·89	6·04	5·05
Sulphur . .	0·79	2·20	2·18	2·56	2·45
Chlorine . .	0·25	1·35	9·07	6·41	4·96
Tar	0·88	12·5	34·9	37·2	40·4
Ash	1·80	17·8	5·09	4·97	4·94
Acidity . .	0·00	0·28	0·92	0·55	0·92

With regard to the total amount of "domestic" soot produced, Cohen and Ruston, on the basis of analyses made by the late Sir W. Roberts-Austen for the London Smoke Abatement Exhibition in 1884, estimate it as equivalent to a loss of not less than 6·0 per cent. of the carbon of the coal burnt in domestic fireplaces throughout the Kingdom. This on an annual domestic consumption of 36 million tons would be equivalent to nearly 2 million tons of carbon per annum, and assuming domestic soot to contain on an average 60 per cent. of carbon (in the free state and as tar), the total weight of domestic soot produced would be about 3·3 million tons annually.

With regard to "factory" soot, the percentage loss of carbon

COAL AND ITS SCIENTIFIC USES

of the coal burnt is probably very much smaller than in the "domestic" case. According to Scheurer-Kestner's researches, the fuel loss due to the production of soot from boiler furnaces never exceeds 1 per cent. of the carbon burnt, but in Constam and Schläpfer's more recent Zürich trials (see Chapter XI., Table L), the loss of heat in "smoke" (apart from "unburnt gases") was never less than 1 per cent., and in exceptionally bad cases rose to as much as even 5 per cent. We should be inclined to put it down at about 2 per cent. with hand-fired, and at 1 per cent. for mechanically stoked boilers, with, say, an all-round average of 1.5 per cent. So that on an assumed annual "factory" consumption of 100 million tons, the heat loss due to "smoke," apart from "unburnt gases" might be estimated as equivalent to 1.5 million tons of coal per annum. Now, seeing that factory soot probably contains on an average about 25 per cent. of carbon, the total weight of soot and smoke produced in factory chimneys throughout the Kingdom may be put down as approximately 6 million tons per annum.

From such data it seems reasonable to suppose that the total weight of "factory" smoke and soot produced from the coal burnt in the Kingdom is about twice as great as the corresponding amount of "domestic" smoke and soot, although there is probably no great difference between the corresponding fuel or heat losses. But in comparing the relative damage done by the two kinds of smoke it must be remembered (1) that, on account of its very much greater tarry content, "domestic" soot will adhere much more tenaciously to anything on which it falls, and will therefore not be nearly so easily removed by wind and rain as "factory" soot; and (2) that the proportionate effect of domestic smoke is presumably much greater in the winter than in the summer. Consequently, weight for weight, domestic smoke is undoubtedly the more pernicious of the two in regard to its direct effects upon human and vegetable life and health, and in densely populated city or industrial areas the combined effects of the two must be very disastrous.

Messrs. Cohen and Ruston have reported that the average deposit of soot over the whole of Leeds amounts to at least 220 tons per square mile per annum; some idea of how this varies as between the different industrial and residential areas in the city may be gained from the following estimation of the average deposits of tar in each of six representative areas during two quarterly periods in 1910.

THE SMOKE NUISANCE AND ITS ABATEMENT

TABLE LX

District.	Deposit of Tar in Milligrams per Square Foot.		Deposit of Tar per Annum in Cwts. per Square Mile.
	March to June.	June to September.	
1. Hunslet	52·6	46·5	110
2. Kirkstall	26·2	31·1	64
3. Philosophical Hall	26·4	30·4	68
4. Headingley	11·3	17·2	27
5. Observatory	15·4	9·0	32
6. Roundhay	2·0	2·1	4·5

By far the most polluted part of Leeds was Hunslet, a big industrial area to the south of the city, thickly populated with the artisan classes; next to that, but only half as bad, came Kirkstall, a residential district in a valley to the W.N.W. containing a well-known iron works and other industrial establishments. Probably, however, the unfavourable conditions apparently prevailing here are partly due to the effects of smoke which drifts up the valley from the other industrial districts in the S. and S.E. of Leeds. The Philosophical Hall is situated in the main commercial and shopping area in almost the centre of the city. Headingley is a residential suburb situated on a high ridge some 3 miles to the N.W. of the centre of the city, whilst the Observatory lies on Woodhouse Moor, a large open space about midway between the Philosophical Hall and Headingley. The district of Roundhay is a purely residential area with a fine park, situated on high open land, 450 ft. above sea level, 3½ miles to the N.E. of the centre of the city. The prevailing N.W. winds here blow straight from the Yorkshire hills and moorlands, and the air is usually clear and bracing. The pollution here is only one twenty-fourth of that in the much lower lying Hunslet area only 4 miles south of it.

DAMAGE DONE TO VEGETATION BY SMOKE

How evil are the effects of the cloud of smoke continually hanging over such an area in limiting the growth of plants may be judged from the following table of results obtained by Cohen and Ruston in regard to (1) the relative assimilation of carbon dioxide by laurel leaves, and (2) the relative total weights of

COAL AND ITS SCIENTIFIC USES

lettuce crops grown in different areas, on the same soil and under the same general conditions except as regards atmospheric conditions :—

TABLE LXI

District.	Position in Relation to Centre of City.	Relative Assimilating Power of Laurel Leaves.	Relative Weight of Lettuce Crops.
Weetwood Lane . . .	2½ miles N.	100	140
Headingley	1½ miles N.	53	120
University	1 mile N.	42	104
City Square and Park Square	Central	12	56
Hunslet	South	nil	44

SOOT AS A FERTILISER

The value of soot to the farmer depends partly upon its physical effects upon the soil and partly upon its content of ammonium salts and sulphur compounds. It is largely used as a top dressing for wheat in the early months of the year. The dead black colour of soot makes it a good absorbent of solar radiations, so that the soil which has been treated with it is kept perceptibly warmer than untreated land, whilst the ammonium compounds present in the soot are valuable fertilisers, and the sulphur compounds in it are very effective in preventing the ravages of slugs and snails. Domestic soot, which contains a very much higher proportion of ammonium salts, has a greater fertilising value than "factory" soot, whilst its higher carbon content also implies a greater heat absorbent power.

THE POSSIBLE ABOLITION OF SMOKE

Whilst improved furnaces and fireplaces, together with a better system of smoke inspection might do much to abate the present smoke nuisance, the evil thing will never be finally abolished so long as raw bituminous coal in its present form continues to be used as a fuel. Fortunately for mankind, the rapid development of Science, even with our present state of knowledge and experience, encourages the hope that the day is not far distant when serious atmospheric pollution by smoke will have become a thing of the past, and that future generations

THE SMOKE NUISANCE AND ITS ABATEMENT

will grow up in our cities amid much healthier and less depressing surroundings. The present sordid ugliness of our large industrial areas, largely caused as it is by the pall of smoke which continually hangs over them, is a standing reproach to our national economy, and we pay an appalling price for it both in direct loss and damage and even more so in physical lowering of vitality and depression of spirits. There are in Great Britain, perhaps, few dangers to the health and well-being of men more universal, insidious, and serious than those due, directly and indirectly, to this widespread nuisance, and few more appealing calls to Science than to assist in the amelioration and abolition of its effects.

The hope of finally ridding ourselves of the evil lies mainly in three directions, all of which are either now quite practicable, or will shortly become so. The first is a wider extension of the use of gaseous fuels for heating purposes, and all investigators who are in any way increasing the efficiency of gaseous combustion, or facilitating the generation and application of gas, are undoubtedly helping to slay the smoke dragon. The second is a much wider adoption of electricity as a motive power, a prospect which is not only within sight, but if realised would almost revolutionise industrial England.¹ The third lies in the direction of making and distributing some form of semi-carbonised coal as a smokeless domestic fuel at a price which will not exceed that of raw coal, and this is a problem whose solution is now exercising the minds of many able investigators. We may certainly look forward with confidence to the time when the barbarous use of coal as a direct heating or power agent, with its attendant smoke, will practically have ceased in all civilised communities.

¹ See the *Report of the Coal Conservation Committee (Ministry of Reconstruction) upon Electric Power Supply, 1917.*

CHAPTER XIV

GENERAL CONSIDERATIONS RELATING TO THE USE OF GASEOUS FUELS DERIVED FROM COAL

ALL experience has shown that the most economical way of burning any fuel is in as finely a divided state as possible, and when intimately mixed with as nearly the theoretical quantity of air as circumstances permit. The ideal conditions for efficient combustion are realised when a homogeneous mixture of some gaseous fuel with just the theoretical quantity of air required for its complete combustion is burnt in any manner easy of control, and especially (as in Surface Combustion, *q.v.*) if the combustion is accelerated by contact with an incandescent surface of a sufficiently refractory character.

The chief advantages of gaseous over other forms of fuels are, (1) that they may be generated and distributed in bulk from a given centre and supplied to the various places of consumption throughout a given area under conditions which should ensure a considerable degree of uniformity as regards quality and pressure at any particular point; (2) that they may be burnt under the ideal conditions referred to in the previous paragraph, or with such a minimum excess of air as may be considered as approximating thereto; (3) that the flow of the combustible is so amenable to control that it may instantly be varied at will, or even entirely checked, in response to the requirements of a particular heating operation; (4) that the use of gaseous fuels is, or should be, perfectly clear and smokeless; and (5) that gaseous fuels are, or may be proved to be, better adapted than others to the requirements of heat "recuperative" or "regenerative" systems, the adoption of which in large scale operations is essential to economy and the attainment of the highest temperatures.

Fortunately for civilisation, coal may be partially or completely "gasified" in a variety of ways, which, either separately or in suitable combination, have so far proved equal to meeting nearly

GASEOUS FUELS DERIVED FROM COAL

all the requirements of our highly developed industrial system. And almost every year brings with it some new development in the generation or application of the gaseous fuels derived from coal, which adds in some way or other to their energy or service-ability. Hence, there seems no reason to doubt but that so long as coal is available, human knowledge and ingenuity will be able to get from it the right kind of gaseous fuel for any industrial requirement within the limits imposed by natural laws upon the efficiencies and temperatures attainable from such fuels. And even when such temperature limits have been reached, the energy of the gas may, by means of an internal combustion engine and a dynamo, be transformed into electric energy which, in the various forms of arc furnaces now available, is capable of developing temperatures exceeding 3000° C.

The principal gaseous fuels derived from coal are the following:—

Coal Gas.—Coal, when partially gasified by the thermal decomposition of its constituents at high temperatures, yields (1) between 10,000 and 13,000 cubic feet of "coal gas" of gross calorific value from 550 to 600 B.Th.U.s. per cubic foot, (2) a series of valuable condensable by-products (tar, benzols, naphthalene, etc.), (3) ammonia (as sulphate), and finally (4) a residue of coke. Altogether some 33 million tons of coal are now being annually carbonised in this way in the kingdom, principally either for the sake of the gas (as in "gas works"), or for the purpose of manufacturing hard metallurgical coke (as in the by-product coking industry).

Water Gas and Producer Gas.—Coal or coke may be wholly gasified in a suitable "generator," either (1) by the endothermic interaction of steam upon the incandescent fuel, which must be maintained in some way at a sufficiently high temperature throughout the operation, as in the manufacture of "Water Gas," which may be represented by the equation—

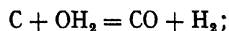

or (2) under the influence of a combined air and steam blast upon an incandescent fuel bed, as in the manufacture of "Producer Gas," a low-grade fuel which can be very cheaply produced, and is chiefly used either for the firing of large industrial furnaces (such as must be used in the manufacture of glass or steel), or

COAL AND ITS SCIENTIFIC USES

for the generation of power for factories by means of internal combustion engines in a central power house.

The second method (2) is one which has several advantages from the point of view of national economy, namely (a) that it is applicable to a wide range of low-grade coals, with a large ash content, the utilisation of which would otherwise be very difficult; and (b) that, with a sufficiently large proportion of steam in the blast, it enables from two-thirds to three-quarters of the nitrogen in the fuel to be converted into and recoverable as ammonium salts ("ammonia-recovery" gas-producer practice).

Blast Furnace Gas.—In addition to the above-mentioned gaseous fuels, our iron smelting blast furnaces, which throughout the kingdom altogether use upwards of 12½ million tons of coke per annum, produce a large amount of a low-grade "blast-furnace gas," which is nowadays used in iron and steel works for power and heating purposes. (See Chapter XIX.)

CALORIFIC VALUES OF GASES

All the various gaseous fuels obtainable from coal or coke admixture whose combustible constituents chiefly consist of one or more of the following, namely, hydrogen, methane, ethane, ethylene, propylene, benzene, and carbon monoxide, the densities and calorific values of which are as follows:—

TABLE LXII

	Formula.	Molecular Weight.	Density Air = 1.000.	Calorific Values.			
				K.C.Us. per Gram-molecule.		B.Th.Us. per Cub. Ft. at 0° C. and 760 mm.	
				Gross.	Net.	Gross.	Net.
Hydrogen . .	H ₂	2.00	0.06952	68.4	57.2	343.3	287.2
Carbon Mon-oxide . .	CO	28.00	0.96716	68.0		341.4	
Methane . .	CH ₄	16.00	0.5538	212.0	189.5	1064.0	951.3
Ethane . .	C ₂ H ₆	30.00	1.0494	370.5	336.9	1860.0	1691.0
Ethylene . .	C ₂ H ₄	28.00	0.9683	333.3	310.9	1673.0	1561.0
Propylene . .	C ₃ H ₆	42.00	1.36	492.7	459.1	2474.0	2305.0
Benzene . .	C ₆ H ₆	78.00	—	799.0	745.4	—	—

Note.—The density of atmospheric nitrogen (including argon, etc.) = 0.9721, and of carbon dioxide = 1.529.

GASEOUS FUELS DERIVED FROM COAL

It should be pointed out that inasmuch as the density and calorific value of any gaseous mixture are additive properties, they may easily be calculated from the known value of its separate constituents, provided of course that the proportion of each in the mixture has been accurately ascertained by chemical analysis.

With regard to calorific values, it would appear that, since the steam formed by the combustion of a given gaseous fuel cannot be condensed at all except at temperatures below the dew point of the products as a whole, the *net* figure is a truer index of its probable value to a would-be consumer than the corresponding *gross* one, although naturally the seller of the gas prefers to have the latter recognised as the proper criterion. But if the consumer had the option of choosing between two gases of the same *gross* but different *net* calorific values, he would rightly prefer the one with the higher *net* value.

Other Factors which need to be considered.—But the question of calorific value, whilst always an important one, is by no means the only factor to be taken into account in the choice of a gaseous fuel for a given purpose, and especially so in regard to large power and furnace installations. There has been in the past perhaps too great a tendency to regard calorific value by itself as the paramount consideration, to the exclusion of other important factors, such, for example, as (*a*) density, (*b*) the range of explosibility, and the rates of back-firing, of mixtures of a given gas and air, (*c*) flame temperature and combustion intensity, and (*d*) the radiative power of the flame produced. And as some of these functions depend in a high degree upon chemical composition, it follows that the latter ought always to receive due consideration, and to ignore it altogether would be foolishness. To deal adequately with the points just mentioned would take up a much larger space than can be allotted to them in this volume, and it is therefore not possible to do more than merely indicate why they are so important.

No one who intelligently uses a gaseous fuel will be inclined to deny the importance of the *density* factor. Also, inasmuch as many types of burners and furnaces are designed to burn *explosive* mixtures of gas and air, and seeing also that the development of flame presupposes the formation of such explosive mixtures, the manipulation of all appliances in which such mixtures are used or formed must be largely influenced by the

COAL AND ITS SCIENTIFIC USES

factors referred to under (b) in the preceding paragraph. These have been fully dealt with by the author in his Report upon Gaseous Combustion to the Sheffield Meeting of the British Association in 1910, and again in his Presidential Address to Section B at the Manchester Meeting in 1915.¹

THE STARTING AND PROPAGATION OF FLAME THROUGH EXPLOSIVE GASEOUS MIXTURES

The phenomena associated with the starting and propagation of flame through an explosive gaseous mixture are in reality so complex that it is not always easy in any particular case to analyse all the factors involved, because they vary so much, not only with the local conditions, such as the place and mode of ignition, or the form and dimensions of the containing vessel, but also according as to whether the mixture is stagnant, or flowing, or in a state of turbulence.

Ignition.—In the first place a given explosive mixture of combustible gas and air must be brought into a certain thermal (or thermo-electrical) condition before the rate of combination of its reactive constituents is sufficient to cause the chemical change to become autogenous, *i. e.* self-propellent, a condition which must always be fulfilled before flame can appear. As soon, however, as the rate of combination becomes such that the mixture "self-heats itself," its temperature will very rapidly rise to the point at which flame appears.

The *ignition temperature* of a given explosive mixture may be defined as that degree to which it must be raised, at least locally, in order that the chemical action becomes autogenous. The real ignition point, as thus defined, is not necessarily synchronous with the actual appearance of flame; there may be, and usually is, an appreciable "*pre-flame period*," and only in the fastest burning mixtures is this period negligible.

The experimental determination of the ignition point of an explosive mixture is by no means an easy matter, because, unless special precautions are taken to prevent it, a sufficient amount of slow combustion may take place during the preliminary heating up of the mixture to vitiate the experiment and give a blurred or irregular result. Either the preliminary heating-up period

¹ *British Association Reports* 1910, pp. 469 to 506, and 1915, p. 368.

GASEOUS FUELS DERIVED FROM COAL

It should be pointed out that inasmuch as the density and calorific value of any gaseous mixture are additive properties, they may easily be calculated from the known value of its separate constituents, provided of course that the proportion of each in the mixture has been accurately ascertained by chemical analysis.

With regard to calorific values, it would appear that, since the steam formed by the combustion of a given gaseous fuel cannot be condensed at all except at temperatures below the dew point of the products as a whole, the *net* figure is a truer index of its probable value to a would-be consumer than the corresponding *gross* one, although naturally the seller of the gas prefers to have the latter recognised as the proper criterion. But if the consumer had the option of choosing between two gases of the same *gross* but different *net* calorific values, he would rightly prefer the one with the higher *net* value.

Other Factors which need to be considered.—But the question of calorific value, whilst always an important one, is by no means the only factor to be taken into account in the choice of a gaseous fuel for a given purpose, and especially so in regard to large power and furnace installations. There has been in the past perhaps too great a tendency to regard calorific value by itself as the paramount consideration, to the exclusion of other important factors, such, for example, as (a) density, (b) the range of explosibility, and the rates of back-firing, of mixtures of a given gas and air, (c) flame temperature and combustion intensity, and (d) the radiative power of the flame produced. And as some of these functions depend in a high degree upon chemical composition, it follows that the latter ought always to receive due consideration, and to ignore it altogether would be foolishness. To deal adequately with the points just mentioned would take up a much larger space than can be allotted to them in this volume, and it is therefore not possible to do more than merely indicate why they are so important.

No one who intelligently uses a gaseous fuel will be inclined to deny the importance of the *density* factor. Also, inasmuch as many types of burners and furnaces are designed to burn *explosive* mixtures of gas and air, and seeing also that the development of flame presupposes the formation of such explosive mixtures, the manipulation of all appliances in which such mixtures are used or formed must be largely influenced by the

COAL AND ITS SCIENTIFIC USES

terrestrial conditions are concerned, the existing cause is chemical change (Smithells). The mechanism of the chemical phenomena associated with it is exceedingly complicated and need not be discussed here; it will be sufficient if we discuss some of its more important physical features.

LIMITS OF INFLAMMABILITY AND RATES OF FLAME PROPAGATION

Mallard and Le Chatelier, in their well-known researches upon gaseous explosions, discovered, as long ago as 1880,¹ that the propagation of flame when a given explosive mixture is ignited in a horizontal tube differs according to whether ignition occurs near the *open* or *closed* end of it. In the first case the flame was observed to travel for some distance down the tube at a uniform slow velocity, corresponding to what Mallard and Le Chatelier regarded as the true rate of propagation "by conduction." This period of uniform movement ("inflammation") was succeeded by an irregular oscillating period, the flame swinging backwards and forwards with increasing amplitudes, and finally either dying out altogether or giving rise to a third phase of greatly accelerated combustion, in some cases even "detonation"). When, however, such mixtures were ignited near the *closed* end of the tube, the forward movement of the flame was continuously (although not uniformly) accelerated, under the influence of reflected compression waves, until an intense condition of violent explosion was set up.

According to the recent investigations of Dr. R. V. Wheeler and his co-workers at the Home Office Experimental Station, Eskmeals, and particularly those upon mixtures of methane and air, it would appear that Mallard and Le Chatelier's interpretation of the "initial uniform movement" of the flame as a propagation from layer to layer by conduction only, needs some revision. If such a thing as propagation exclusively "by conduction" ever occurs, it would appear to be a limited phenomenon, obtainable only in tubes whose diameter whilst wide enough to prevent appreciable cooling of the flame, is sufficiently narrow to suppress the influence of convection currents. Moreover, ignition must be either just at, or within one or two centimetres of, the open end of the tube, or otherwise, and particularly with the more rapidly moving flame, vibrations may be set up from the beginning.

¹ *Annales des Mines*, 8^e Sec., Vol. IV.

GASEOUS FUELS DERIVED FROM COAL

Mixtures of methane and air have been more extensively studied than others in this connection, because of their importance in relation to the safety of coal mines; a brief statement as to their behaviour will perhaps suffice to illustrate the chief points to which attention need be drawn.

According to Wheeler the *limits of inflammability* for *horizontal* propagation of flame in methane-air mixtures, at atmospheric temperature and pressure, correspond to 5.4 and 14.3 per cent. methane contents, respectively. These limits are somewhat different for *upward* or *downward* propagation, owing either to the helpful or impeding influence of convection currents. The limits for mixtures of other combustible gases with air are also sharply defined, and are also similarly affected by the direction of flame propagation. Each combustible gas has a well-defined *range of inflammability* when mixed with air, which range varies according to the nature of the gas, and presumably also to the temperature and pressure. Thus for hydrogen-air mixtures the limits for horizontal propagation of flame at atmospheric temperature and pressure correspond to 10 and 70 per cent. hydrogen contents respectively.

Although all methane-air mixtures develop an initial uniform slow flame movement period when ignited at or near the open end of a horizontal tube, neither its linear duration nor the flame velocity is, according to Wheeler's experiments, independent of the diameter of the tube. The speed of the flame during this period increases with the diameter of the tube; also the linear duration of the uniform period increases with both the diameter and the length of the tube up to a certain maximum, and for the same tube it varies with the proportion of methane in the explosive mixture, being greater as the speed of the flame diminishes, until with the two "limiting" explosive mixtures it appears to last almost indefinitely.

The accompanying curves (Fig. 30) show the results of Wheeler's determination of the speeds of the initial uniform movement (horizontal) of flame through methane-air mixtures at atmospheric temperature and pressures in tubes of different diameters (ordinates = velocity in centimetres per second and abscissæ = percentages of methane). It is noteworthy that the flame velocity is still considerable at either of the two limits of inflammability instead of nearly approaching a zero value, as Mallard and Le Chatelier supposed it would do, and that it reaches a maximum with mixtures containing from 9.5 to 10.0 per cent.

COAL AND ITS SCIENTIFIC USES

of methane. In the next curves (Fig. 31) are shown results for hydrogen-air mixtures obtained by W. A. Howard and T. Otagawa under Dr. Wheeler's direction.

But although within recent years considerable advances have been made in respect of scientific knowledge upon such matters, much more needs to be done before it can be considered as having reached a satisfactory point. In regard to the deficiencies in our present knowledge, the author was led to remark in his

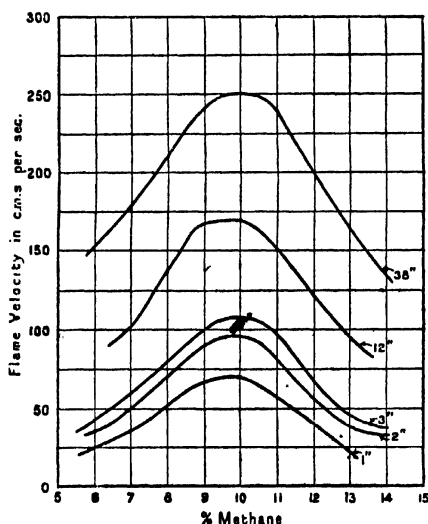

FIG. 30.—Speeds of Uniform Movement of Flame through Methane-Air Mixtures in Tubes of Different Diameters (Wheeler).

address to Section B of the British Association in 1915 that "an exact knowledge of the velocities of flame propagation during the initial period of uniform slow movement, as well as of the limits of inflammability for mixtures of various combustible gases and air, is very important from a practical point of view. Makers of apparatus for burning explosive mixtures of gas and air want to know the speed of flame propagation through such mixtures, not only at ordinary temperatures and pressures, but also when the mixtures are heated and used at higher pressures. Also, it would be important to know whether or not, in the case of a complex mixture of various combustible gases and air, whose

GASEOUS FUELS DERIVED FROM COAL

chemical composition can be determined by analysis (as for example, coal gas and air), the velocity of flame propagation can be calculated from the known velocities for its simple components. Unfortunately, although more than thirty years have elapsed since Mallard and Le Chatelier's work was published, the necessary data are still wanting to answer such questions, and any one who will systematically tackle the problem and carefully work it out in detail will be doing a real service to the gas-using industries."

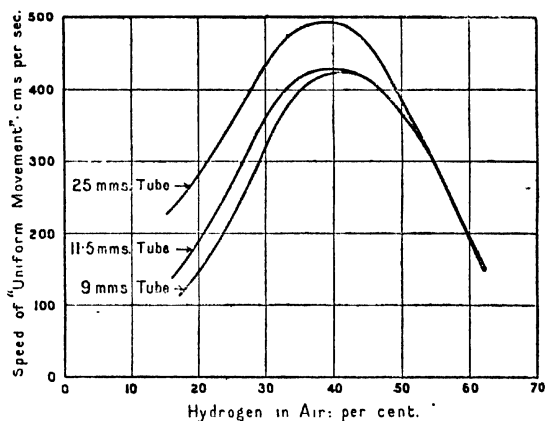

FIG. 31.—Rates of Propagation of "Uniform Movement" in Hydrogen-Air Mixtures (Haward and Otagawa).

Another point which needs much further investigation in this connection is the accelerating influence of turbulence upon both the propagation of flame and the intensity of combustion of an explosive mixture of gas and air; indeed, this as yet but little explored subject affords vast opportunities to the coming generation of scientific workers.

The important question of "flame temperature" in any given case of gaseous combustion is governed by several factors, such, for instance, as the relation of the heat capacity of the products, and of the energy directly radiated from the flame, to the total energy developed by combustion, as well as the size of the flame and the intensity of the chemical changes involved.

COAL AND ITS SCIENTIFIC USES

RADIATION FROM FLAMES

It is not sufficiently well understood by users of gas for heating purposes that a certain part of the energy developed by the combustion of a gas (from 12 to 18 per cent. in the case of an ordinary bunsen burner, according to the degree of aëration of the flame) is directly radiated away, and consequently does not appear as sensible heat of the products or determine the flame temperature. For if of the total energy Σ developed by combustion, a portion represented by r is directly radiated away, it follows that the other portion appearing as sensible heat in the products, and which causes the "temperature" of the flame, is the difference between Σ and r , i. e. ($\Sigma - r$).

The subject of Radiation from Flames was discussed at some length in the Third Report of the Committee appointed by the British Association to investigate Gaseous Explosions with special reference to Temperature, which was presented and discussed at the Sheffield Meeting in 1910,¹ and the importance of a proper understanding of the bearing of the subject upon practical problems by those whose business it is to control or supervise gaseous combustion in furnaces, cannot well be overestimated.

In that Report, Professor H. L. Callendar, in describing the results of a series of determinations which he had made upon the properties of heat radiated from aerated coal-gas flames, remarked that "with the air and gas adjusted as nearly as could be estimated in the proportion required for complete combustion, the proportion of heat radiated varied from 10 to 15 per cent. for burners from one inch to four inches diameter. As the air supply was reduced for the same rate of gas consumption, the size of the flame increased, and also the heat radiated. A maximum of 15 to 20 per cent. was reached for these burners when a brilliant and well-defined inner cone was formed. If the amount of air supplied was in excess of that required for complete combustion, the radiation fell off considerably in consequence of the reduction in size and fall in temperature of the flame. When the air supply was reduced until the inner cone disappeared with burners of this type, the flame became unsteady and was reduced in temperature, the radiation falling to about 12 to 16 per cent. With steady luminous flames of the Argand or bats-wing type, there was a considerable increase of radiation on excluding air from the flame. With small flames of low temperature the

¹ *British Association Reports (Sheffield)*, 1910, p. 469.

GASEOUS FUELS DERIVED FROM COAL

proportion of heat radiated might be as low as 2 or 3 per cent. These results appeared to indicate that the radiation depended largely on the size of the flame, as well as on the temperature, and on the presence of CO or solid C when the air was insufficient for complete combustion."

Most chemists who have investigated the subject attribute the radiation from non-luminous flames to the formation *at the moment of combustion* of intensely vibratory hydrogen-oxygen or carbon monoxide-oxygen "complexes" which eventually give rise to steam and carbon dioxide molecules. Thus, for example, in the case of a hydrogen flame, hydrogen and oxygen molecules meeting in collision may be conceived as forming, in the first instance, and for an indefinitely short period, not steam, but a vibratory system of hydrogen and oxygen. Such a system would, during its transitory existence, emit a considerable amount of radiant energy which would not, therefore, subsequently appear as sensible heat in the products. Afterwards would come the formation of steam, at first in a vibratory condition, until finally the system would rapidly settle down to a non-vibratory state in which the product would gradually lose its translatory energy (temperature) by ordinary cooling processes, *i. e.* by collision with other molecules or with the walls of the containing vessel.

A very complete spectroscopic analysis of the radiation from different flames was made by Dr. W. H. Julius, of Berlin, in 1890, whose experiments proved beyond doubt that the radiation is almost wholly due to incipiently formed (or forming) CO₂ and H₂O molecules. About the same time Robert von Helmholtz measured the amount of radiation emitted by "solid" flames, 6 mm. in diameter, burning hydrogen, carbon monoxide, hydrocarbons, and coal gas respectively. A flame burning hydrogen radiated 3 per cent., another burning coal-gas 5 per cent., and a third burning carbon monoxide 8 per cent. of the total heat of combustion. He also determined the *relative* amounts of radiation *per litre of gas consumed*, emitted by flames of given size burning various gases, the air supply in each case being adjusted so that the flame was just non-luminous, with the following results:—

Gas Burnt.	Relative Radiation per Litre of Gas.
Hydrogen . . .	74
Carbon monoxide . . .	177
Methane . . .	327
Ethylene . . .	510

COAL AND ITS SCIENTIFIC USES

The important things to observe about these results are (1) that a carbon monoxide flame has a radiating power for a given volume of gas burnt, nearly 2.4 times that of a hydrogen flame of similar size; and (2) that the relative radiating power of a flame burning a compound gas such as methane or ethylene is determined by the number of steam and carbon dioxide molecules produced from a given volume of the gas burnt. Thus the observed value of 327 per litre of methane burnt is, within the experimental error, equal to the 177 observed for carbon monoxide plus twice the 74 observed for hydrogen, namely 325, which agrees well with the supposition that the radiation is due entirely to incipiently formed (or forming) carbon dioxide and steam molecules in a vibratory condition.

With regard to the question of the influence of the size of flames upon their radiating powers, the British Association Committee Report admirably summarised the position as follows: "The size of the flame affects the matter in two ways. In the first place, a large flame radiates more per unit of area than a small one, because a flame is to a great extent transparent even to its own radiation, so that the radiation is received not only from molecules at the surface of the flame, but also from those at a depth within it. . . . The second point is that the cooling of the gas is slower in a large flame than in a small one. The radiation originates in the vibration of the CO_2 and steam molecules, and the life of one of these molecules as a radiating body extends from the moment of its formation to the time when its vibrational energy has been destroyed by radiations and by collisions with colder molecules, such as those of the air surrounding the flames. The smaller the flame the more rapid will be the extinction of the vibrations, and the less, therefore, the total amount of radiation per molecule."

The bearing of such experiments and considerations upon everyday practice will at once be conceded by any one who appreciates the importance of "radiation" in ordinary furnace operations. It has, for instance, been known for many years to those accustomed to work much with open-hearth steel furnaces, that a producer gas rich in carbon monoxide, but with a low hydrogen content, is a better fuel for such purposes than one of equal calorific value in which the relative properties of the two constituents are reversed. Other persons, who hold that "calorific value" is the only factor that matters, but have never studied furnace conditions at close quarters, have argued that the supposed difference is an illusion. When, however, it can be

GASEOUS FUELS DERIVED FROM COAL

demonstrated that the radiating power of a CO flame is, per unit volume of gas burnt, 2.4 times that of a hydrogen flame of the same size, the experience of steel workers is not only seen to be correct, but is also very largely explained. This illustrates how the results of scientific investigations can be applied to the elucidation of important practical problems, which otherwise would remain in an empirical state.

FLAME TEMPERATURE

The term "flame temperature" is often used very carelessly in both scientific and technical literature, and indeed it is difficult to assign a precise meaning to it. For, as Smithells¹ has truly said, "most flames are composed of thin films and their external surface includes a large quantity of unburnt gas," and whilst "we speak of the temperature of such a flame as meaning the average thermal state of the burning film and the included gas" it is more usual to mean the indication of some thermometric instrument wholly immersed in the region of combustion.

The temperature of the flame from a burning gas must presumably be governed or influenced principally by three factors, namely (1) the ratio of the thermal value of the reaction to the corresponding total heat capacity of the products; (2) the amount of energy directly radiated from the flame; and possibly also (3) the rapidity with which the remaining energy is transformed into sensible heat of the products.

The "theoretical flame temperature" has sometimes been calculated as the ratio between the heat of the reaction and the heat capacity at ordinary temperatures of the known products. But such a calculation is not only based upon two wrong assumptions, namely (1) that the reaction is instantaneous and the transfer of the energy developed to the products is adiabatic; and (2) that the specific heats of the products do not increase with the temperature; but it also (3) ignores the fact that part of the energy developed by the reaction is directly radiated from the flame.

Another misconception which, judging by the frequency with which it crops up in technical discussions, seems to be very prevalent is that calorific value and calorific intensity necessarily rise or fall together. Thus it seems often to be assumed that a gas of calorific value, say, 500 B.Th.U.s. (*net*) will necessarily burn with a hotter flame and give a higher temperature in a

¹ Article on "Flame," Thorpe's *Dictionary of Applied Chemistry*, Vol. II., p. 572.

COAL AND ITS SCIENTIFIC USES

furnace than one of, say, 300 B.Th.U.s. (*net*) per cubic foot, whereas it may easily be shown that such an assumption is not necessarily valid. Indeed, according to actual experience, a blue water gas of 300 B.Th.U.s. calorific value gives a hotter flame than does a coal gas of 500 B.Th.U.s. Also any such idea is hardly consistent with the following experimental figures:—

			Calorific Value per Cub. Ft. at 0° C. and 760 mm.		Observed Maximum Flame Temperature in Air ¹ (Fery). °C.
	Gross.		Net.		
Hydrogen	. 343·3	. .	287·2	. .	1900°
Coal Gas	. 560	. .	500	. .	1871°
Acetylene	. 1556·0	. .	1500·0	. .	2548°

Unfortunately for the possibility of making any exact calculations of flame temperatures, not only is our knowledge of the specific heats of steam, carbon dioxide and nitrogen at high temperatures imperfect, but also the measurements which have so far been made of the energy directly radiated from flames (*q.v.*) can hardly be considered as more than approximate. Moreover, as yet we hardly know sufficient about the relative times taken with various gas-air mixtures to effect the transference to the products of the energy developed by the reaction (less that directly radiated away) to warrant our assuming that in ordinary flames the process is rigidly adiabatic, although it is probably nearly so. Hence on its theoretical side the subject is beset by many difficulties and complications.

Nevertheless, whilst fully recognising this to be the case, it is perhaps permissible for us to make simple calculations of a *relative* character for various gas and air mixtures, the indications of which enable us to view more clearly the perspective of the subject, and prevent us unwarily falling into errors concerning it.

If now (1) the *net* heat of combustion of a gas be taken as a true thermal measurement of the heat liberated by its reaction with atmospheric oxygen; and (2) the mean specific heats of carbon dioxide, steam and nitrogen between say 0° and 2000° C. (or 100° and 2000° C. in the case of steam) be extrapolated from Holborn and Henning's curves, we can for the common combustible gases calculate the *mean thermal capacity, between 0° and 2000° C. (K), in calories per °C. of the products as a whole (that*

¹ As measured by an optical method.

GASEOUS FUELS DERIVED FROM COAL

is, carbon dioxide, steam and nitrogen), formed per 100 K.C.U.s. (100,000 cal.) developed on combustion when the gas is burnt with exactly the theoretical quantity of air, which latter may, for the purpose of calculation, be considered as a mixture of one volume of oxygen with four volumes of nitrogen.

The ratio of 100,000 calories to this number K would (assuming the correctness of Holborn and Henning's equations up to 2000° C., and also that all the energy produced is adiabatically transformed into sensible heat of products) give us a theoretical maximum mean flame temperature, T_1 , above that of the environment, attainable by the gas when burnt with the theoretical amount of air, making no allowance for the proportion of energy directly radiated away. And by making a certain deduction (r) from the latter, consistent with the actual measurements which have been made of the radiation from flames, we can arrive at a further approximate mean flame temperature, T_2 , which will probably nearly represent the relative calorific intensity of the combustion.

In making such calculations the author has assumed the substantial accuracy of Robert von Helmholtz's measurements and conclusions regarding radiations from flames, which have already been explained in the preceding section of this chapter.

TABLE LXIII

CALCULATION OF RELATIVE CALORIFIC INTENSITIES OF GAS-AIR FLAMES

Gas.	Net Cal. Value Cals. per Gram-molecule.	K Cals.	$T_1 = \frac{100,000}{K}$ C°.	r Cals	$T_2 = \frac{100,000 - r}{K}$ C°.
Hydrogen . .	57,200	45.89	2179°	12,000	1918°
Carbon Monoxide	68,000	44.64	2238°	24,000	1700°
Methane . . .	189,500	50.30	1988°	16,000	1670°
Ethylene . .	310,900	44.70	2238°	15,000	1900°
Acetylene . .	298,800	37.38	2675°	13,200	2322°

The values of T_2 , as calculated on the basis of the foregoing assumptions, are not very different from those actually observed by thermometric methods in the case of gas-air flames by the best workers in recent years. Thus, in 1905, Féry observed 1900° C. for a hydrogen-air flame, 2548° C. for an acetylene-air flame, and 1871° C. for a coal-gas-air flame, whilst Messrs. White and Travers, in 1902, gave 1780° for a coal-gas-air flame. It will be seen that the values of T_2 , as above calculated, for

COAL AND ITS SCIENTIFIC USES

the various constituents of coal gas all fall between 1670 and 1918° C. And if, in the case of a complex mixture such as coal gas, the flame temperature may be assumed to be an additive property, that of a gas containing 50 per cent. of hydrogen, 33.3 per cent. of methane, 10 per cent. of carbon monoxide, and 4 per cent. of ethylene, would be about 1750° C.

For reasons already explained no great stress is laid upon the above-calculated values in any absolute sense. The deductions to be made from the total energy developed on account of radiation alone necessarily vary with the size of the flame and its temperature, and a calculation of such deduction for an aerated flame of ordinary bunsen size, would not apply to similar flames of a quite other size. But the calculated values T_2 will have fulfilled a useful purpose if they prevent the unwary falling into the error of supposing that there is any necessary, or even usual, connection or coincidence between calorific values and calorific intensities in the case of gaseous fuels.

CHAPTER XV

THE CARBONISATION INDUSTRIES

INTRODUCTORY : THE GAS INDUSTRY

THE coal carbonised in the United Kingdom in the year 1916 amounted to 37.62 million tons, or about 14.7 per cent. of the total output of the mines, and 18.7 per cent. of that portion of it was consumed at home. Of this amount, 17.5 million tons were dealt with in various forms of retorts in gas-works, principally for the manufacture of town gas, whilst the remaining 20.1 million tons were used for the production of hard metallurgical coke, which is chiefly used as a blast-furnace fuel for the smelting of iron.

The importance of these carbonising industries from a national point of view is a great and growing one. Upon the gas industry, on the one hand, the community depends for supplies of gas suitable, not only for domestic and public lighting and heating, but also, in an increasing degree, for small-scale industrial heating operations and power purposes; on the other hand, the future prosperity of our iron and steel industries is bound up with the efficiency and proper development of the coking industries. Also, we rely equally on both branches of the industry for our entire supplies of benzene, toluene, anthracene, naphthalene, and other coal tar products, which constitute the raw materials for the manufacture of synthetic dyes, drugs, and high explosives. Moreover, at present we obtain 73 per cent. of our total output of ammonium sulphate by the high temperature carbonisation of coal.

In this brief review it is not proposed to enter into details concerning either the design or operation of carbonising plants; and with so many recent good handbooks on the subject available,

COAL AND ITS SCIENTIFIC USES

indeed, there is no need to do so.¹ All that will be attempted in this chapter is a survey of the trend of modern developments in the two main branches of the industry, so that the reader may get a proper view of their relation to the fuel problem as a whole.

THE GAS INDUSTRY

Introductory.—Under the term “gas industry” is included all the carbonising works which have been established almost everywhere throughout the Kingdom, either by the various Municipalities or by Companies working under special Acts of Parliament, principally for the object of ensuring public supplies of gas suitable for domestic or small-scale industrial and power purposes. Incidentally, also, the industry produces large quantities of gas-coke, tar, benzol hydrocarbons, and ammonium salts, but its essential function and responsibility is to supply the community with gas at as low a cost as possible, and to this end its organisation and development must necessarily be chiefly directed and adapted.

Another feature of its operations is that, whilst in regard to the supply of gas, the industry, whether publicly or privately owned, has practically a monopoly in each area so far as the ordinary consumer is concerned, its profits in the case of a municipality-owned undertaking all revert to the community as a whole. And in the case of a company-owned concern, they are regulated in such a way by Acts of Parliament that the public automatically gets the bulk of the financial benefit of any new cost-saving invention or development in the shape of lower price of gas. So that in either case the community has a very direct interest in the efficiency and well-being of the industry.

The magnitude and importance to which the operations of the industry have now attained, and their considerable development in relation to the population as a whole during the past thirty years, may be judged from the following figures, taken

¹ The reader may be referred to the following works: W. J. A. Butterfield's *Gas Manufacture* (2 vols., 1907, Griffin & Co.); S. C. Cooper's *By-product Coking* (Benn Bros. Ltd., London, 1912); and the articles in Thorpe's *Dictionary of Applied Chemistry*, Vol. II., upon “Coke Manufacture and the Recovery of By-products” (pp. 103-11), by Ernest Bury, M.Sc., and upon “Coal Gas” (pp. 653-95), by Dr. H. G. Colman. Also to the further monographs, which will appear in this series, upon *By-product Coking*, by Ernest Bury, M.Sc., and upon *The Purification of Coal Gas*, by E. V. Evans.

THE CARBONISATION INDUSTRIES

(except as to population) from the Board of Trade Returns for all authorised gas undertakings, whether municipally or privately owned, in the Kingdom :—

Year.	Estimated Population. Millions.	Capital or Loans.		Million Tons of Coal Carbonised.	Mill. Cub. Ft. of Gas.		Length of Gas Main. Miles.	Number of Consumers. Millions.
		Authorised. £	Paid up or Borrowed.		Made.	Sold.		
1885	35.9	71,863,267	35,513,570	8.378	84,637	77,393	18,967	2.095
1913	46.0	162,346,673	139,727,277	16.971	224,517	206,474	39,099	7.103

Early History.—The foundation of this huge industry dates back to the inventions of William Murdoch (born at Belton Mill, Ayrshire, in 1754, died in Birmingham 1839) in the years 1792-6. For although during the seventeenth and eighteenth centuries many observers had found that an inflammable gas could be obtained by distilling coal in closed vessels, it was not until Murdoch carried out such an operation in an experimental iron retort, which he had installed in the back yard of his house at Redruth in 1792, and carried the resulting gas by a pipe to a burner fixed near the ceiling over a table in one of the rooms in his house, that the use of the gas as an indoor illuminant was demonstrated. In November 1795, and again in February 1796, Murdoch operated a small experimental gas-making apparatus at the Neath Abbey Ironworks, in which coal was distilled in an iron retort provided with an iron pipe about 3 ft. long at the open end of which the issuing gas was burned, giving (it was said) "a strong and beautiful light, which continued burning a considerable time."

In 1799 Murdoch was recalled from Redruth to the Soho Works in Birmingham of Messrs. Boulton and Watt (the firm by whom he was employed), and continuing his experiments there, he installed an apparatus for the generation of the new illuminating gas, which was first publicly used in connection with an outdoor illumination to celebrate the Peace of Amiens in 1802. In the following year part of the Soho factory was regularly lighted by the gas. In 1804 he put up another apparatus to illuminate the residence of Mr. George Augustus Lee in Manchester, and so successful was the venture that a few months later the cotton

COAL AND ITS SCIENTIFIC USES

mills of Messrs. Phillips and Lee in that city were lighted by gas. Apparently also, in these Manchester installations some purification of the gas was attempted, for it is recorded that the gas made therefrom did not have the "Soho stink."

In February 1808, Murdoch read a paper before the Royal Society in London upon his inventions,¹ in recognition of which the Society awarded him its Rumford Medal, the latter having been instituted in 1800 to be presented "to the author of the most important discovery or useful improvement which shall be made and published by printing or in any way made known to the public in any part of Europe during the preceding two years on Heat and Light, the preference always being given to such discoveries as, in the opinion of the President and Council of the Royal Society tend most to good of mankind."

In 1810 an Act of Parliament was obtained for the formation of a Statutory Company for supplying coal gas to London. After its incorporation, two years later, the Company became known as the "Gas Light and Coke Company," the forerunner of the vast number of similar organisations which have since been established all over the world to supply towns and cities with illuminating gas. The centenary of the gas-lighting industry was fittingly celebrated in London, in October 1913, by a splendidly organised National Gas Congress and Exhibition, at which a number of papers were read and discussed by leading authorities upon the manifold advantages and problems connected with the uses of coal gas for domestic and industrial purposes by a modern community.²

In what is perhaps the earliest treatise³ on the Manufacture of Coal Gas, which was written by Frederick Accum in the year 1819, we have preserved a full account of the means and apparatus employed for generating, purifying, and burning the gas a century ago. We are told that there were already upwards of fifty-one thousand gas-lights in use in the metropolis, and that the total length of gas mains in the streets amounted to 288 miles. Also, that "establishments for the supply of new lights are carried on at Edinburgh, Glasgow, Liverpool, Bristol, Bath, Cheltenham, Birmingham, Leeds, Manchester, Exeter, Chester, Macclesfield,

¹ *Phil. Trans.*, Vol. XCVIII., p. 124.

² These papers were all subsequently published together as a memorial of the centenary under the general title of *National Gas Congress Papers*, 1913.

³ *Description of the Process of Manufacturing Coal Gas now employed at the Gas Works in London, etc.*, by Frederick Accum, Operative Chemist, London. Printed for Thomas Boys, No. 7 Ludgate Hill, MDCCCXIX.

THE CARBONISATION INDUSTRIES

Preston, Kidderminster, and in many other towns and places of Great Britain."

The retorts then employed in the London gas-works were made of cast iron, in several different sectional forms, but chiefly: (1) a *parallelepiped*, 6 to 7 ft. long, 20 in. wide, and 15 in. high, with slightly rounded angles, (2) *ellipsoidal*, 5½ to 6 ft. long, major axis 20 to 25 in., minor axis 10 in., and (3) *semi-cylindrical*, 5 to 6 ft. long, 18 in. wide, and 6 in. high. A number (up to 5) of such retorts were set over a fireplace in an oven heated by the combustion of small coal. The total number of retorts at all the London gas establishments in the year 1819 amounted to 900. Each semi-cylindrical retort was charged with two bushels of coal, the carbonising period being 6, but preferably 8, hours, at a temperature described as "cherry-red heat." The yield of gas obtained varied between 8300 and 10,000 cub. ft. per chaldron (27 cwt.) of coal (say between 6150 and 7400 cub. ft. per ton of coal), according to the duration of the carbonising period, whilst the weight of coal expended in heating the retorts amounted to about 25 per cent. of that carbonised. We are further told that the crude gas evolved from the retorts was purified from sulphuretted hydrogen and carbonic acid by bringing it "confined under a pressure equal to a column of water, not less than 8 or 10 in. in height, into contact with quicklime, diffused through water."

The following balance sheet of a full week's experimental run of an installation of 96 semi-cylindrical retorts, with 8 hour charges, at the Gas Light and Coke Company's Westminster Station early in 1819 is of great interest from many points of view, showing as it does, not merely the yields obtained, but also the prices ruling in London a century ago.

BALANCE SHEET FOR GAS PRODUCTION IN 1819

<i>Materials Expended.</i>	£	s.	d.	<i>Products Obtained.</i>	£	s.	d.
Coal decomposed: 107 chaldrons at £2 11s. 6d. the chaldron				Coke: 124 chaldrons, at £1 7s. the chaldron	167	8	0
Small coal: 26 chaldrons 27 bushels, used for fuel, at £2 2s. the chaldron	56	3	6	Breeze, or small coke: 4 chaldrons at 18s.	3	12	0
				Tar: 8 tons, at £6 the ton	48	0	0
				Ammoniacal liquor: 1945 galls. at 1¼d.	12	3	1½
				Gas: 1,070,000 cub. ft., at 15s. the thousand	802	10	0
Total	£331	14	0	Total	£1033	13	1½

COAL AND ITS SCIENTIFIC USES

From the foregoing descriptions it may be inferred that the carbonising temperature in the early days of iron retorts might be as low as 650°, and would probably not exceed 750° C. at the most. Consequently the gas would be very much richer in hydrocarbons, and poorer in hydrogen, than that used to-day, and its illuminating power would be very high. Indeed, in these days the gas was commonly called "carburetted hydrogen," as though the presence of hydrogen in it was not suspected. The residual coke would be soft, and would burn quite easily in an ordinary domestic fireplace, being probably much nearer in texture to a low temperature "semi-coke," of whose virtues as domestic fuel so much has been heard lately, than to a modern high temperature gas-coke. We can, therefore, well understand Accum's statement that in 1819 "the demand for coke in the capital, since the establishment of the gas-light works, has prodigiously increased. Numerous taverns, offices, and public establishments, which heretofore burnt coal, now use coke to the total exclusion of coal; and in almost every manufactory, which requires extensive lighting or heating, gas and coke are now the means jointly employed"

THE BUNSEN BURNER AND THE WELSBACH INCANDESCENT MANTLE

The development of the industry during the century following Murdoch's inventions was profoundly influenced by the work of two eminent chemists, to whom all users of gas throughout the world owe a debt of incalculable magnitude.

The story of how R. W. Bunsen came to invent, in the year 1855, his well-known atmospheric gas burner, the principles of which have since been applied in thousands of different ways in connection with gas lighting and heating, cannot better be told than in the following words of an eye-witness, Sir Henry E. Roscoe,¹ who at that time was working as one of his pupils in Heidelberg: "Some short time before the opening of the new laboratory, the town of Heidelberg was for the first time lighted with gas, and Bunsen had to consider what kind of gas burner he would use for laboratory purposes. Returning from my Easter vacation in London, I brought back with me an Argand burner with copper chimney and wire gauze, which was

¹ Extracted from his Bunsen Memorial Lecture before the Chemical Society on March 29, 1900. (*Trans. Chem. Soc.*, 1900, **77**, p. 547.)

THE CARBONISATION INDUSTRIES

the form commonly used in English laboratories at that time for working with a smokeless flame. The arrangement did not please Bunsen in the very least, the flame was flickering, it was too large, and the gas was so much diluted with air that the flame-temperature was greatly depressed. He could make a burner in which the mixtures of gas and air would burn at the top of the tube without any gauze whatsoever, giving a steady, small, and hot non-luminous flame, under conditions such that it not only would burn without striking down when the gas supply was turned on full, but also when the supply was diminished until only a minute flame was left. This was a difficult, some thought an impossible, problem to solve, but after many fruitless attempts, and many tedious trials, he succeeded, and the 'Bunsen burner' came to light."

In view of the many fortunes which have since been made by others out of applying the principles of Bunsen's burner to various economic ends, it may be recalled that (to quote Roscoe's words again) "the notion of making money out of his discoveries, or of patenting any of them, never entered into his head." Thus was the inestimable boon of this simple but ingenious atmospheric burner conferred upon the world as a free gift by the great Heidelberg chemist, and it may safely be said that without it the gas industry would never have attained its present colossal magnitude.

The next discovery referred to was made exactly thirty years later, also in Bunsen's laboratory at Heidelberg, when Auer von Welsbach found that the oxides of certain rare metals had a quite extraordinary power of emitting light when in a state of incandescence. Following upon this he made, during the next few years (1885 to 1893), a series of researches which eventuated in the invention of his well-known incandescent mantle. This mantle, which is got by incinerating a cotton or other fabric saturated with a solution of a mixture of the nitrates of thorium (9.9 per cent.) and cerium (1 per cent.), gives in conjunction with Bunsen's burner a magnificent white light, and it is not too much to say that the gas industry gained a new lease of life in its competition with the electric light from this second great invention of the Heidelberg chemists.

In thus recording these two outstanding discoveries, it must not be forgotten that honourable mention is also due to the pioneering labours of the late Thomas Fletcher of Warrington, who was perhaps the first practical mind to appreciate and

COAL AND ITS SCIENTIFIC USES

develop the enormously wide field of usefulness opened up by Bunsen's invention. The world undoubtedly owes to Fletcher the original designing of numerous types of furnaces and other ingenious appliances specially adapted to realise those possibilities, in manifold ways, for both domestic and industrial heating operations.

PERIOD 1815 TO 1890—PRIMARY REQUIREMENT: A SELF-ILLUMINATING GAS FOR OPEN FLAME BURNERS

During a period of about three-quarters of a century, after the establishment in London of the first public gas-works in 1813, the predominant use of coal gas was for lighting purposes, with what are sometimes termed "open flame" burners, in which the actual union of the gas and air only meet in a thin film forming the outer surface of the flame, where alone the active combustion, and therefore very high temperatures, can occur. Under the influence of the heat so developed in the outer region, the heavy hydrocarbons of unburnt gas in the inner parts of the flame undergo characteristic thermal decomposition resulting in the separating of solid particles of carbon, and possibly also of very dense hydrocarbons, which, being raised to incandescence, cause the well-known yellow luminosity of the flame.

Sir Humphry Davy, who was perhaps the first chemist to investigate the matter, believed that the light emitted by a coal-gas flame "*might be owing to the decomposition of a part of the gas towards the interior of the flame where the air was in smallest quantity, and the deposition of solid charcoal, which first by its ignition, and afterwards by its combustion, increased in a high degree the intensity of the light.*"¹ And although subsequent research may have revealed facts which require some modification in detail of this statement, it has fully confirmed its central proposition, namely, that the luminosity is due to the decomposition of part of the gas and the deposition of solid carbon towards the interior of the flame.

This being so, the prime object of the early gas manufacturers was to obtain a gas as rich as possible in the "heavy" hydrocarbons (ethane, ethylene, propylene, benzene, etc.), which readily decompose under the influence of heat producing carbon. For obviously such constituents as hydrogen and methane,

¹ *Journal of Science and the Arts*, Vol. II., p. 124, and *Collected Works*, Vol. III., p. 47.

THE CARBONISATION INDUSTRIES

which on being heated either do not yield carbon at all, or only with great difficulty, cannot contribute directly to the luminosity of the flame, although they undoubtedly play an important indirect rôle by reason of the high temperature developed by their combustion in the outer regions of the flame.

The High Illuminating Gas required Fifty Years Ago.—Seeing that such a “rich” gas is best produced by carbonising a high-grade coal at medium temperatures (say 750° to 900° C.), the practice naturally followed such lines so long as high self-luminosity of the gas was the controlling consideration. Horizontal \square -shaped or oval retorts still continued to be employed, but they were no longer made of cast iron, as in the earliest days, but of fireclay, and they were heated by the combustion of coke in “direct-fired” settings, without any regenerative arrangements. The temperatures, whilst higher than those attained when cast-iron retorts were employed, would be decidedly lower than those aimed at to-day. In many cases a considerable quantity of cannel coal was added to the charge, because of its giving a very large yield of gas of high illuminating power.

The following analyses of the gas made at such “medium” temperatures (a) in Heidelberg from a bituminous coal, and (b) in London from a cannel coal, will give some idea of the kind of result aimed at fifty or sixty years ago:—

	(a)		(b)	
	Per cent.		Per cent.	
Carbon dioxide	0·37	. .	1·19	
Carbon monoxide	5·73	. .	10·07	
Olefines and benzenes . .	7·27	. .	10·81	
Methane	38·40	. .	41·99	
Hydrogen	44·00	. .	35·94	

The Modern Need of a Lower Quality of Gas for both Lighting and Heating Purposes.—With the wide adoption of incandescent mantles for lighting purposes, which followed closely upon von Welsbach’s inventions, and the concurrent increasing use of gas for domestic heating purposes, which soon resulted from Thomas Fletcher’s pioneering efforts, the need of a rich gas of high self-illuminating power diminished, and has now practically disappeared. These new conditions opened the way for cheapening the production of gas by raising the temperature of the retort settings, whereby much larger yields of a gas of lower calorific and illuminating power were obtained, a policy which has now

COAL AND ITS SCIENTIFIC USES

become general throughout the industry, with, on the whole, beneficial results to the main body of gas-consumers.

The adoption of higher carbonising temperatures also led to improvements in the manufacture of the fireclay retorts, and also to greater fuel economy, in that it undoubtedly accelerated the substitution of "regenerative" methods of heating the retort settings, by means of producer gas generated from coke, for the older and uneconomical practice of firing them non-regeneratively by the combustion of coke in shallow fires maintained in the centre of the setting below the middle vertical line of retorts. Such substitution has meant that, whereas formerly the consumption of coke in the direct-fired non-regenerative settings usually amounted to between 25 and 30 per cent. of the weight of coal carbonised, it now rarely exceeds 15 to 18 per cent., and at the same time much higher temperatures in the setting are attained.

In the year 1888 the manufacture of water gas (*q.v.*) from coke was introduced into this country from the United States. Its rapid development during the next ten years soon placed at the disposal of the gas industry a means of cheapening the gas supplied to consumers by mixing with it a certain proportion (usually not exceeding 25 per cent.) of "blue" or carburetted water gas, which could be generated from part of the coke produced in the gas retorts at a comparatively low cost.

The net result of all these improvements has thus been not only to increase the yield of gas obtained from an average coal in the retorts up to between 11,000 and 13,000 cub. ft. per ton, but also to obtain both a greater *total* illuminating power (as measured by the product of the yield \times the specific illuminating power) and a much greater number of heat units in the gas from a ton of coal. And, concurrently, all this has been achieved with a much smaller expenditure of heat units in the retort settings.

So far as the increase in the yield of gas is concerned, the Board of Trade returns from all authorised gas undertakings already referred to show that whereas in the year 1885 the average yield of gas from the 8,378,904 tons of coal carbonised was a little more than 10,000 cub. ft. per ton, in the year 1915 the corresponding yield of gas from 16,684,087 tons was 11,650 cub. ft. per ton generated in the retorts *plus* a further 2150 cub. ft. added as water gas, etc., or a total average of 13,800 cub. ft. per ton of coal actually carbonised.

The average yield per ton of coal carbonised of the principal

THE CARBONISATION INDUSTRIES

products obtainable in a modern setting of horizontal retorts, fired regeneratively with producer gas made within the setting from part of the coke produced, will be about 10 galls. of tar (Sp. Gr. 1.15 to 1.25), between 20 and 30 lb. of ammonium sulphate, and some 14 cwt. of quenched coke, of which latter about 3 to 3½ cwt. have to be used for heating the setting, leaving between 10 and 11 cwt. for outside use or sale.

Coke manufactured in gas-works is used (1) for cupola melting in iron foundries; (2) for making water gas, which is largely used in steel welding operations; (3) for steam raising under boilers; (4) for the heating of green-houses, and in connection with central heating systems generally; and (5) it may also with advantage be used to mix with the coal burnt in domestic fires, more especially in closed-in ranges where the draught is good.

SELECTION OF COALS FOR GAS MAKING

The most suitable coals for gas-making purposes are those yielding between 30 and 40 per cent. of volatile matter at 900° C., reckoned on the dry ash-free coal substance. According to tests made by St. Claire Deville at the Paris gas-works, the best results are obtained from those containing between 7.5 and 9.0 per cent. of oxygen in the coal substance. In England it is generally considered that the nearer the ratio O:H in the coal substance approximates to 2.0 the better the results obtained. It is not, however, always safe to rely on such rules, and hence in many of the larger works provision is made for the testing of coals on a large scale by isolating a bed of retorts, with separate condensing and purifying and measuring arrangements, so that the whole process can be carried out experimentally under actual works conditions.

The best British gas coals are found in Northumberland, Durham, South Yorkshire, Derbyshire, Lancashire, and North Staffordshire. The great London gas-works draw their supplies chiefly by sea from the Durham coalfield, because of the cheaper cost of sea-freights as compared with railway carriage. The Durham coals as a rule yield a rather harder coke, but less ammonia, than those of South Yorkshire, Lancashire or Derbyshire, which latter, however, produce a somewhat better quality of gas and thinner tars.

A gas manager, in selecting his coal, must often, however, be guided by other than merely chemical data, important as they undoubtedly are. The question of pithead price and carriage

COAL AND ITS SCIENTIFIC USES

in relation to yields of gas and by-products, is always of course a ruling one with him; he has also to consider the demands for coke in his neighbourhood, and if the demand is good, then the particular kind of coke which is most needed.

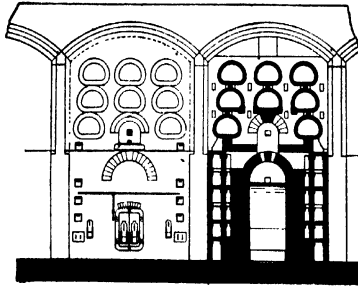

FIG. 32.—Horizontal Gas Retort Settings (Cross Section).

A REGENERATIVE HORIZONTAL RETORT SETTING

In all except the smaller gas-works a number, usually between 6 and 12, of "through" retorts, each 18 to 20 ft. long by 18 to 25 in. wide by 13 to 16 in. deep, with walls 3 in. thick, usually

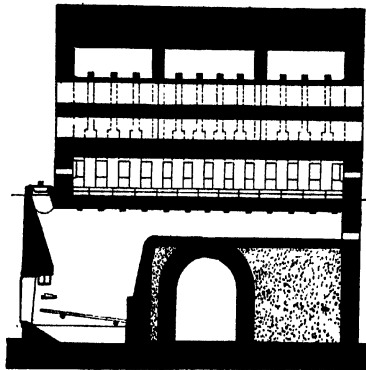

FIG. 33.—Horizontal Gas Retort Settings (Longitudinal Section).

Q-shaped or oval in section, are fixed horizontally in a single furnace or "setting," as shown diagrammatically in Figs. 32 to 36 inclusive.¹ The fireclay of which the retorts are made must

¹ Reproduced by permission from Dr. H. G. Colman's article on "Coal Gas" in Thorpe's *Dictionary of Applied Chemistry*, Vol. II., p. 663.

THE CARBONISATION INDUSTRIES

products obtainable in a modern setting of horizontal retorts, fired regeneratively with producer gas made within the setting from part of the coke produced, will be about 10 galls. of tar (Sp. Gr. 1.15 to 1.25), between 20 and 30 lb. of ammonium sulphate, and some 14 cwt. of quenched coke, of which latter about 3 to 3½ cwt. have to be used for heating the setting, leaving between 10 and 11 cwt. for outside use or sale.

Coke manufactured in gas-works is used (1) for cupola melting in iron foundries; (2) for making water gas, which is largely used in steel welding operations; (3) for steam raising under boilers; (4) for the heating of green-houses, and in connection with central heating systems generally; and (5) it may also with advantage be used to mix with the coal burnt in domestic fires, more especially in closed-in ranges where the draught is good.

SELECTION OF COALS FOR GAS MAKING

The most suitable coals for gas-making purposes are those yielding between 30 and 40 per cent. of volatile matter at 900° C., reckoned on the dry ash-free coal substance. According to tests made by St. Claire Deville at the Paris gas-works, the best results are obtained from those containing between 7.5 and 9.0 per cent. of oxygen in the coal substance. In England it is generally considered that the nearer the ratio O:H in the coal substance approximates to 2.0 the better the results obtained. It is not, however, always safe to rely on such rules, and hence in many of the larger works provision is made for the testing of coals on a large scale by isolating a bed of retorts, with separate condensing and purifying and measuring arrangements, so that the whole process can be carried out experimentally under actual works conditions.

The best British gas coals are found in Northumberland, Durham, South Yorkshire, Derbyshire, Lancashire, and North Staffordshire. The great London gas-works draw their supplies chiefly by sea from the Durham coalfield, because of the cheaper cost of sea-freights as compared with railway carriage. The Durham coals as a rule yield a rather harder coke, but less ammonia, than those of South Yorkshire, Lancashire or Derbyshire, which latter, however, produce a somewhat better quality of gas and thinner tars.

A gas manager, in selecting his coal, must often, however, be guided by other than merely chemical data, important as they undoubtedly are. The question of pithead price and carriage

COAL AND ITS SCIENTIFIC USES

veying the crude gas, tar, and other volatile condensable products *via* the *bridge pipe* and *dip pipe* into a collecting trough called the *hydraulic main*. The latter extends, in a line at right angles to the axes of the retorts, along the whole length of the bed of retorts, and in it a mixture of tar and liquor seals the dip pipes from each retort, thus forming a valve which, whilst allowing gas to pass through the "seal" onwards towards the condensing plant, effectively prevents any of it getting back when the retort lid is opened for charging purposes. The gas from the hydraulic main finds an outlet to the condensing and purifying plant through a pipe, called the *foul main*, fixed at the top or side

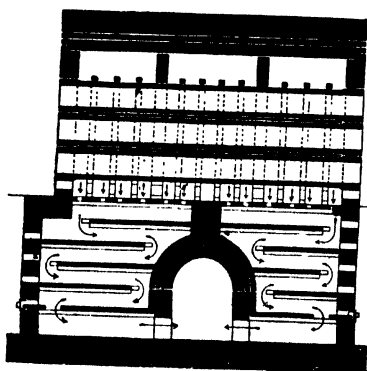

FIG. 35.—Regenerative Settings for Gas Retorts—
showing Course for Waste Gases.

of it. The general arrangements of these fittings in relation to the retort and setting will be understood by reference to Fig. 34.

The weight of coal charged into a retort 20 ft. long \times 16 in. deep \times 22 in. wide is usually about 6 to 7 cwt. It is spread evenly on the floor so as to allow of a sufficient free space above the charge, not only for the passage of the gas throughout the carbonising period, but also to allow of a rake being introduced for the purpose of discharging the coke at the end of the operation. And as most "gas-coals" swell up, some of them considerably, when carbonised, it is necessary to allow for such a contingency.

The time taken to carbonise completely an average "gas coal" is from 6 to 8 hours, at the end of which the temperature in the retort rises to beyond 900° C., and may go up to even 1100° C.

THE CARBONISATION INDUSTRIES

in cases where the operation is pushed to the furthest practical limits, having regard to the life of the retort. In Table XXXV on page 131 of Chapter VIII hereof, is shown the composition of the crude gases evolved at different times during the carbonisation of a Derbyshire coal when the final temperature was 950° C. And as the chemistry of carbonisation has already been fully discussed in Chapters VII and VIII, there is no need to refer again to the subject here.

In comparing the carbonising conditions in such "horizontal" with those in the more modern "vertical" retorts, which will be described later on, it is important to remember that, inasmuch

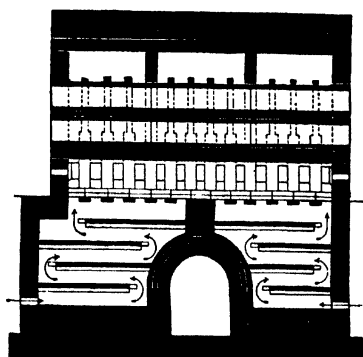

FIG. 36.—Regenerative Settings for Gas Retorts showing Course for Secondary Air.

as in the former case the coal is heated, not only by contact with the bottom and lower part of the side of the retort, but also largely by radiation from the arched top thereof, the zone of "active carbonisation" advances from the perimeter of the charge towards the central portion of it. Hence, during the greater part of the carbonising period, the gases and volatile matter evolved must of necessity pass out of the charge through a layer of incandescent coke which is always at a higher temperature than that at which the coal has been mainly carbonised. Also, these gases and volatile constituents, on emerging from this incandescent coke, have to traverse the free space above the charge, where they are subjected to intense radiant heat, and in so doing must come frequently into contact with the incandescent arch of the retort. When it is recalled that the radiation

COAL AND ITS SCIENTIFIC USES

from incandescent surfaces causes the heavier hydrocarbons (ethane, propane, ethylene, propylene, etc.) to decompose, and that contact with such surfaces greatly accelerates the thermal decomposition of methane, the importance of getting the gases out of the retorts as quickly as possible will be appreciated.

Hence the gas manager endeavours to keep down the pressure in the retorts uniformly to a point only slightly above that of the outside atmosphere; if he reduces it below the atmospheric pressure, air will be drawn through the retorts and by interaction with their contents produce a mixture of nitrogen and oxides of carbon which dilute the coal gas to the detriment of its quality.

Gas Carbon.—The decomposition of the hydrocarbons (principally the methane) in the gas by contact with the incandescent walls of the retort accounts for the deposition of "gas carbon" or "scurf" on them, which is a well-known feature of carbonisation in horizontal retorts. This "scurf," whilst rendering the retorts more gas-tight, slightly interferes with the heat transmission, if it is allowed to accumulate unduly. Hence it is removed periodically, and is used for the manufacture of carbon electrodes for electric furnaces.

The setting is heated by means of "producer gas" generated by the action of air, charged with a certain amount of steam, upon incandescent coke. A solid-bottom generator with a bar grate is built into each bed of retorts (see Figs. 32, 33, 35 and 36), usually below the ground level, and is charged with hot coke direct from the retorts. The "primary" air, together with some steam, is admitted through the bars, and, by means of the chimney draught, is drawn through a deep bed of incandescent coke in the generator, making a low-grade producer gas of which the following is a typical analysis:—

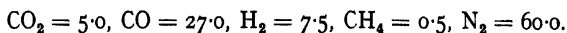

The hot gas, on entering the setting through holes made at the bottom of each of the spaces formed by the vertical cross walls supporting the retorts, meets with a regulated stream of preheated "secondary" air sufficient for its complete combustion. The combustion is completed as the intermingled stream of gas and air circulates round the retorts. The burnt gases, which must necessarily leave the setting at a temperature sufficiently high to maintain the uppermost retorts at the required carbonising heat, pass downwards on their way to the chimney

THE CARBONISATION INDUSTRIES

through a heat "recuperator" or "regenerator" system. This consists essentially of a series of flues adjacent to, and separated by, a thin firebrick partition from, a parallel set of flues through which the "secondary" air is allowed to flow on its way to the setting, travelling in the reverse direction to the waste gas stream.

The proper control and adjustment both of the "primary" and the "secondary" air supplies in such a setting (by means of slides in the admission ports and dampers at the regenerative outlets) is obviously a most important factor in determining the fuel economy of the process. The amount of "primary" air admitted should not exceed that required to generate sufficient producer gas of good quality to maintain the carbonising heat in the retorts, whilst no more of "secondary" air should be admitted than is needed to burn the gas completely.

In the smaller gas-works horizontal retorts are still charged and discharged by hand labour, but in nearly all the larger installations this work is now entirely done by specially designed machinery. The use of machines for this purpose has done away with the necessity for leaving so large a "free space" over the coal in the retort as was formerly so customary, and indeed some gas managers now work the retorts on "full charges."

As an example of the results obtainable in a modern horizontal retort setting, the following summarised figures may be given (Table LXIV) of a seven days' trial with a Derbyshire gas coal made in 1910 by Mr. J. Ferguson Bell of Derby for the Carbonisation Committee of the Institution of Gas Engineers.¹

The coal used was from the Blackshale Seam (Derbyshire), and, as charged, contained—

C = 72.22, H = 4.75, N = 1.35, S = 2.35, O = 7.36, Ash = 7.51, Moisture = 4.49 per cent., with Volatiles = 33.98 per cent.

The retorts, which were heated in settings of "eights" by producer gas in Klönne regenerator furnaces, were \square -shaped, 18 ft. long \times 22 in. wide \times 16 in. deep. In one set of trials, 12 cwt. "full" charges were carbonised in 12 hours, and in the other series 8.21 cwt. charges were worked off in 8 hours, the mean average final temperature in the retort being 995° C. in the first case and 986° C. in the second. The temperature in the combustion chambers of the settings was about 1330° C.

¹ *Trans. Inst. Gas Engineers*, 1910, p. 259.

COAL AND ITS SCIENTIFIC USES

Care was taken to maintain as nearly as possible a "zero pressure" in the inside of the retorts throughout each trial.

TABLE LXIV

MR. J. FERGUSON BELL'S TRIALS OF A DERBYSHIRE GAS COAL IN
HORIZONTAL RETORTS AT 986° TO 995°C.

Retort House	No. 1	No. 2
Average Retort Temperature °C.	995°	986°
Retorts charged	Full	$\frac{3}{4}$ Full
Total weight of Coal carbonised, in tons	295.5	751.4
Average weight of Coal per charge, cwt.	12.0	8.21
Average duration of charge, hours	12	8
Coke made per ton of Coal {	9.40	8.90
	2.47	2.96
	0.78	0.74
Tar made per ton of Coal, gallons	12.07	10.43
Specific gravity of Tar	1.156	1.189
Ammonia (as sulphate) per ton of Coal, lbs.	29.89	28.50
Gas made per ton of Coal	12,091	11,820
Cub. ft. at 60° Fahr. and 30 in. Bar. }		
Cwts. Coke used in Furnaces per ton of Coal carbonised	1.60	1.65
Percentage Composition of the Gas	2.20	2.60
	5.60	5.20
	3.80	3.30
	32.90	34.00
	48.60	43.50
	0.30	0.30
6.60	11.10	
Illuminating Power of Gas in No. 2 Metropolitan Burner	15.56	16.29

Notes. (1) The coke and breeze contained 6.56 per cent. of water.
(2) The gas was purified by iron oxide only.

CARBONISATION IN VERTICAL RETORTS

The first departure, so far as gas-works were concerned, from the practice of carbonising in horizontal retorts, was made in the year 1885, when, with the object of charging and discharging them by gravity unaided either by hand labour or elaborate machinery, the idea of setting the retorts at an angle of about 32° to the horizontal was tried with encouraging success at the Rheims Gas Works. The practice soon spread to other countries, and subsequently several installations of "inclined retorts,"

THE CARBONISATION INDUSTRIES

some of which were operated with "full charges," were put up in British gas-works. The technical results did not, however, differ materially from those obtained in the older horizontal settings.

It would appear that, as long ago as 1828, an inventor named Brunton had proposed a system of vertical retorts in which full charges were to be carbonised, on the "intermittent" plan, and the gas taken off at the top of each retort. But, for some reason or another, possibly connected with the obvious difficulty of satisfactorily heating such vertical retorts without gaseous firing under regenerative conditions, the idea did not at that time come to practical fruition. It was, however, revived and carried to success during the early years of the present century at the Dessau Gas Works in Germany by Dr. Bueb, who, in 1904, patented his new system in England.

It was soon recognised that the intermittent vertical system, as it is now called, possesses certain technical advantages over the older methods. In the first place, the problem of charging and discharging the retorts is reduced to its simplest form, and the retorts are worked with full charges. Secondly, it is claimed by Bueb that, inasmuch as in such intermittently charged vertical retorts the carbonisation proceeds through the coal from the periphery inwards, the gas and "volatiles" generated during the greater part of the period making their way out mainly through the relatively cool central core of partially carbonised coal, thereby avoiding very largely any contact with the incandescent coke and retort walls. And, finally, the system lends itself to the practice of passing steam through the incandescent charge during the last stages of carbonising, thereby conserving heat energy, and at the same time increasing the total quantity of gas obtained by the addition of a certain amount of water gas.

Contemporaneously with Bueb's investigations, a number of British engineers were independently engaged in designing and working out systems in which the coal was *continuously* passed through vertical retorts, somewhat on the lines of the continuous method for distilling oil-bearing shales invented by Beilby and Young in 1881.

In 1902 Settle and Padfield patented a method of "vertical" carbonisation in which the coal was continuously fed into the top of the retort, but the coke withdrawn by hand at intervals, but although good results were obtained, it has been said

COAL AND ITS SCIENTIFIC USES

that certain practical difficulties connected with the shape of the retorts were encountered. Eventually, however, complete success was achieved in the now well-known Woodall-Duckham (1903-8) and Glover-West (1905-9) "continuous" systems, in which the coal is carbonised under uniform conditions in the retorts. Also, Messrs. Robert Dempster and Sons of Elland (Yorks) have successfully designed both "intermittent" and "continuous" systems of vertical retort settings (the latter known as the Dempster-Toogood System), as the result of several years of practical trials. Hence, British enterprise and invention have fully maintained their reputation in this new field of development.

The various systems which are now in vogue have so many features in common, that it will suffice, for the purposes of this present exposition, to describe the Dessau and the Glover-West systems, as representative of the principles underlying "intermittent" and "continuous" vertical retort practice respectively.

The Dessau Intermittent System is shown diagrammatically in Fig. 37. The retorts, which are usually between 4 and 5 metres long, with a rounded oblong cross-section, gradually taper from the bottom upwards, in order to facilitate the discharging of the coke at the end of the operation. From 9 to 15 retorts are usually arranged, in rows of threes, in a single setting, and they are heated by "producer gas" made in the usual manner from coke in a deep generator built into one side of the setting.

The method of heating the retorts is what has been described as a "graduated" one, its main feature being that the setting is divided into four horizontal chambers or compartments. The burning mixture of gas and air, and the hot products therefrom, pass zigzag upwards through the four chambers in succession, and thence downwards again to the chimney flue at the base through a "continuous" heat recuperator, whereby part of their sensible heat is transferred to the "primary" and "secondary" air streams coming in to the setting.

The retorts are charged full, and discharged at regular intervals, hence the designation of the system as an "intermittent" one. The carbonisation period for each full charge usually extends over 10 to 12 hours, during the last two of which steam may be passed through the incandescent coke, for the purpose of generating some water gas and incidentally also of cooling the coke.

THE CARBONISATION INDUSTRIES

It is claimed that such a system yields from a given coal (1) a greater volume of gas, (2) thinner tars containing less pitch and free carbon, (3) a large amount of ammonia, but (4) much less naphthalene, and (5) a harder and superior coke

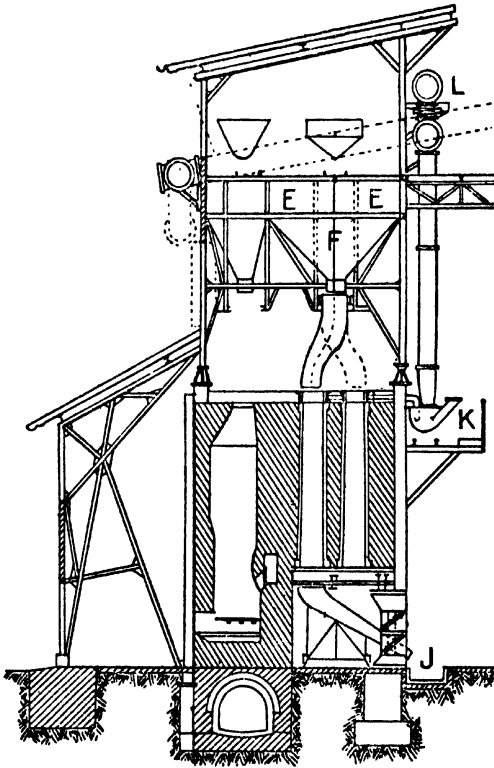

FIG. 37.—The Dessau Intermittent System.

than are usually made in horizontal retorts. Also, that all these advantages may be secured with a smaller consumption of fuel in the setting, and that labour costs are reduced. For further information, the reader may be referred to an instructive paper published by Mr. C. Dru Drury in the *Transactions of the Institute of Gas Engineers* for the year 1911, giving the result of

COAL AND ITS SCIENTIFIC USES

a year's practical working of the Dessau system at the Sunderland Gas Works upon a Durham coal containing—

Moisture = 1·56 to 2·28, Ash = 7·90 to 11·05, with Volatiles
28·69 to 29·54 per cent.

The yields obtained per ton from the 20,349 tons of coal carbonised during the year were as follows :—

	Per Ton of Coal.
Gas (at 60° Fahr. and 30 in. bar)	12,647 cub. ft.
Tar	11·40 gal.
Ammonia (as sulphate)	28·66 lb.
Coke and Breeze for sale	11·25 cwt.

Illuminating Value of Gas (in No. 2 Met. burner) . = 15·52 candles	}	per cub. ft.
Calorific Value of Gas {Gross, 590 } B.Th.U.s. {Net, 531 }		

The Glover-West Continuous System (Fig. 38).—In this system the coal falls by gravity into the vertical retort from a small hopper, the top of which is closed by a special gas-tight valve, which latter is only opened when fresh coal has to be drawn from the main supply bunkers overhead. The coal is continuously drawn through the system at a speed which is regulated by an ingenious mechanical coke extractor at the base of the retort, by which means the time of carbonisation can be adjusted to suit any particular class of coal. The resulting coke is received from the bottom of the retort into a hopper, from which it is periodically discharged.

The retorts are normally 21 ft. long, oval in section, and tapering from the bottom upwards. Usually there are 8 such retorts in a setting which may be divided into sections so as to allow either 2, 4, or 8 retorts to be fired, as circumstances require.

As a rule each setting is provided with one producer for the 8 retorts, but sometimes two such producers are provided.

The heating and regenerative system is somewhat as follows :—

The heating chambers round the retorts are arranged in ten tiers, the top two of which (called the "circulating chambers") are heated by the combined waste gases from the "live" chambers below. The next lower six tiers form the "combustion chambers" proper, each receiving a separate supply of producer gas, together with a suitably proportioned amount of preheated secondary air. Below these, again, are two other similar chambers

THE CARBONISATION INDUSTRIES

through which the secondary air is drawn on its way to the aforesaid "combustion chambers," a feature which results in part of the heat of the incandescent carbonised coke in the lower part of the retort being transferred to the incoming air, and the coke being discharged in a relatively cool state without having to be quenched. It will thus be seen that (1) the waste gases

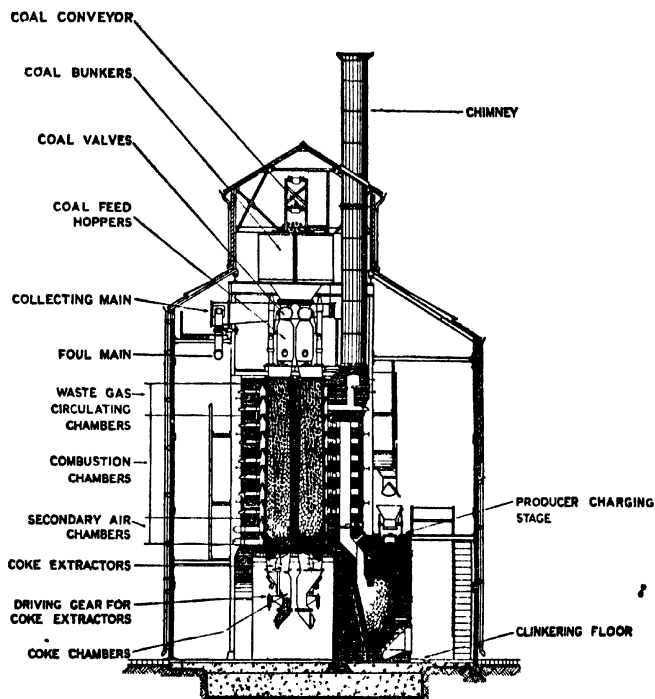

FIG. 38.—Glover-West Continuous Vertical Retort Setting.

from the "combustion chambers" impart their heat to the incoming coal as it passes downwards through the upper part of the retort; whilst (2) the incoming secondary air supply abstracts the greater part of the heat from the outgoing incandescent coke. Another important point to observe is that on account of the continuousness of the process, the carbonising and other working conditions are very uniform, a circumstance which decidedly makes for good results.

COAL AND ITS SCIENTIFIC USES

The carbonising conditions are somewhat different from those which prevail in intermittent vertical retort practice, because, owing to the continuous movement of the mass of material through the system, the uncarbonised coal "takes the form of an inverted cone, the base of which is at the top, and the apex at a point about two-thirds of the length of the retort below" (Dr. H. G. Colman).

In a paper published in 1911 by the late Mr. J. G. Newbigging, Chief Engineer to the Manchester Corporation Gas Works¹ are given the results of a series of large-scale trials which were carried out under the direction of a Glover-West installation at the Droylsden (Manchester) Gas Works upon Lancashire, Yorkshire, and Derbyshire gas coal. The tests with each coal were made in two ways, namely (A) with the object of ascertaining what quantity of gas of an illuminating power of seventeen candles could be obtained under normal working conditions, and (B) to secure a maximum yield of gas of an illuminating power of 15 candles. The results of these two tests with the Lancashire coal (containing 1.62 per cent. moisture, 3.68 per cent. ash, and 33.56 per cent. of volatiles) are summarised below:—

TABLE LXVa
SUMMARY OF MR. J. G. NEWBIGGING'S TESTS ON A LANCASHIRE COAL
AT THE DROYLSDEN GAS WORKS

Series.	A.	B.
Total tons of Coal carbonised	129.8	140.5
Yields of Products per ton of Coal		
{ Dry Coke, in cwts.	13.8	13.7
{ Tar, in gallons	11.52	9.41
{ Ammonia, in lbs. sulphate	30.7	30.2
{ Gas, in cub. ft. at 60° Fahr. and 30 in. Bar.	11,868	13,033
Percentage Composition of the Gas		
{ Carbon Dioxide	2.10	2.53
{ Carbon Monoxide	9.10	10.70
{ Unsat. Hydrocarbons	3.20	3.43
{ Methane	31.49	26.94
{ Hydrogen	51.18	52.27
{ Nitrogen, etc.	2.93	4.13
Illuminating Power of the Gas—candles	17.23	15.43
Cal. Value of Gas, in B.Th.U.s. per cub. ft. at 60° Fahr. and 60 in. Bar.		
{ Gross	586.6	551.8
{ Net	524.0	494.1
Parts Coke used as fuel in the setting per 100 of the Coal carbonised	9.49	9.37

¹ *Trans. Inst. Gas Engineers*, 1911, p. 129.

THE CARBONISATION INDUSTRIES

The following figures, taken from Mr. Newbigging's paper, show that the tars obtained in these trials and that normally made from the same coal in horizontal retorts bear out the claim that vertical retort tars are thinner, and contain less pitch and free carbon than those made in horizontals.

TABLE LXVb

	Vertical Retort Tars.		Horizontal Retort Tar.
	A.	B.	
Specific Gravity	1·074	1·146	1·193
Water	—	2·5	5·0
Light Oils, up to 170° C.	9·1	4·6	4·5
Middle Oils, 170° to 270° C.	25·7	22·4	12·0
Heavy Oils, 270° to 350° C.	24·9	19·7	19·5
Pitch, over 350° C.	40·0	55·4	57·0
Free Carbon	3·1	5·86	17·67

Heat Balance.—Taking the results of Trial B as fairly representing what can be accomplished by carbonising a good gas coal under the best working conditions in a modern vertical retort at high temperatures, we may now deduce the following approximate heat balance for the operation, which shows that no less than 89 per cent. of the energy expended is accounted for in the combined heat values of the resulting coke, tar, and gas :—

<i>Dr.</i>	Million B.Th.Us.	<i>Cr.</i>	Million B.Th.Us.
1 ton of Coal charged into Retorts	30·850	13·7 cwt. Coke	21·110
210 lb. of Coke used as fuel in Producers	2·889	13,033 cub. ft. of Gas	7·191
		105 lb. of Tar	1·731
Total	33·739	Total	30·032

$$\text{Ratio } \frac{30\cdot032}{33\cdot739} = 0\cdot89.$$

Attention may here be drawn to a recent paper by Mr. J. E. West¹ in which the results of passing steam through the retorts during the carbonisation period are demonstrated. The object

¹ *Gas Journal*, Nov. 13, 1917, Vol. CXL., p. 314.

COAL AND ITS SCIENTIFIC USES

of this procedure is of course to obtain, in addition to the gas arising from the distillation of the coal, a certain amount of blue water gas, thereby increasing materially the total make of gas per ton of coal treated. It is also claimed that the suggested improvement gives rise to increased outputs of both tar and ammonia.

Experimental trials were described in which a gas coal yielded, under normal distillation in the vertical retort, 14,084 cubic feet of gas per ton, of the following composition:—

$\text{CO}_2 = 1.9$, $\text{CO} = 12.0$, $\text{C}_n\text{H}_m = 2.6$, $\text{CH}_4 = 26.1$, $\text{H}_2 = 51.6$,
 N_2 , etc. = 5.8 per cent.

When, however, the same coal was put through the retort into the bottom of which steam was introduced at 40 lb. pressure, through $\frac{3}{8}$ -in. nozzle, the combined yield of distillation *plus* blue water gas, amounted to as much as 16,607 cubic feet per ton of coal, with the following average composition:—

$\text{CO}_2 = 3.7$, $\text{CO} = 17.1$, $\text{C}_n\text{H}_m = 2.2$, $\text{CH}_4 = 20.8$, $\text{H}_2 = 51.2$,
 $\text{N}_2 = 5.0$ per cent.

The total B.Th.U.s. in the gas made per ton of coal was 8,386,030 in the second experiment, as compared with 7,351,848 in the first. At the same time the increased yield of gas would obviously be obtained at the expense of part of the coke.

PURIFICATION OF COAL GAS

Although this subject lies somewhat outside the scope of the present book, and is to be treated in detail by Mr. E. V. Evans, the Chief Chemist of the South Metropolitan Gas Co., in a subsequent volume in this series, a few words upon it here will perhaps not be considered out of place, especially as the chief object is to record another remarkable achievement of British technologists which fittingly closed the first century's development of this pre-eminently British industry.

The most modern methods for the removal and recovery of tars, benzols, naphthalene, ammonia, and other condensable or soluble by-products from crude coal gas will be described in the next chapter, which deals with the coking industry, where they have been further developed than in gas-works. But when all these products have been removed, and the gas thoroughly.

THE CARBONISATION INDUSTRIES

cooled, there still remain, as impurities, (1) certain cyanogen compounds, the amount of which tends to increase with the temperature at which the coal is carbonised; and also (2) sulphur compounds, chiefly sulphuretted hydrogen and carbon disulphide, whose presence in a gas destined for domestic use is, from every point of view, deleterious.

Considerations of space preclude our dealing with the removal of the cyanogen compounds. Sulphuretted hydrogen has never presented any serious difficulties to the gas manager, for it may be easily, and completely, removed by passing the gas through a "dry" purifier containing layers of moist hydrated ferric oxide (preferably in the form of bog iron ore), when the following reactions occur:—

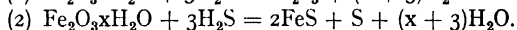
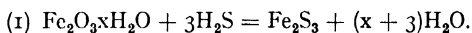

The spent oxide, after it has ceased to react with the hydrogen sulphide, may be "revivified" by atmospheric oxidation, whereby ferric oxide is re-formed with the separation of free sulphur. Therefore the purifying material is alternately used in the purifier, and revived by exposure to air several times over, until its sulphur content rises to beyond 50 per cent., when it is sold to the sulphuric acid manufacturers. In this way the sulphur existing as hydrogen sulphide in the crude gas is ultimately converted into sulphuric acid.

The removal of carbon disulphide has, however, always presented great difficulties. For although it can be partly effected where "lime purification"¹ is resorted to, such procedure is so uncertain in its effects, and so liable to cause "nuisances," that it has been largely abandoned in modern works. Hence, for many years, the consumer had to tolerate an undue proportion of sulphur compounds in the gas supplied to him.

In 1906, however, Dr. Charles Carpenter, in conjunction with Messrs. E. V. Evans and Doig Gibb, initiated investigations at the South Metropolitan Gas Works upon the well-known decomposition of carbon disulphide by heat in contact with suitable catalysts at moderate temperatures whereby, in presence of

¹ The removal of CS_2 by this method principally depends on the fact that the calcium hydrosulphide $\text{Ca}(\text{SH})_2$, which is first formed by the action of H_2S upon slaked lime, $\text{Ca}(\text{OH})_2$, will in time absorb CS_2 , forming calcium thiocarbonate, CaCS_3 , and H_2S , which latter must be removed either by means of fresh lime or hydrated ferric oxide. The process, however, is too complex to be treated here in detail.

COAL AND ITS SCIENTIFIC USES

hydrogen, which is always a predominant constituent of the gas, it is converted into sulphuretted hydrogen and carbon, as follows:—

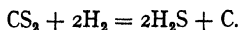

The sulphuretted hydrogen can then be removed in the usual manner. By using nickel, as the most suitable catalyst, at a temperature of 450° C., the investigators in question finally succeeded in evolving a practical process whereby the sulphur content (as CS₂) of the South London gas can be reduced on a large scale, in regular day-to-day working, from 40 to about 8 grains per 100 cub. ft., without in any way deteriorating the quality of the gas, at a cost (including interest and depreciation) of 0.299*d.* per 1000 cub. ft., thus providing a striking example of what may be achieved in industry by (to borrow Dr. Carpenter's own phrase) "the unrestricted and unreserved collaboration of the chemist and the engineer."¹

The Quality and Prices of Towns Gas in 1913.—During the decade prior to the war, the adoption of a calorific standard for towns gas had become fairly general, and the following figures may be quoted as showing the average gross calorific values for the year 1913 of the gas supplied in six of the largest cities of Great Britain:—

City	A.	B.	C.	D.	E.	F.
Gross Calorific Value in B.Th.Us. per cub. ft. of dry gas at 60° Fahr. and 30 in. Bar.	620	596	593	582	580	540

The prices charged to the ordinary consumer in these cities ranged from one shilling and threepence to two shillings and sixpence per 1000 cub. ft.

COAL GAS AS AN INDUSTRIAL FUEL

For some years prior to the war, coal gas had been rapidly making headway as an industrial fuel, and since 1914 the

¹ For further details the reader is referred to Dr. Carpenter's lecture on the "Purification of Gas by Heat" before the Institution of Gas Engineers at Liverpool in 1914. (*Trans. Inst. Gas Engineers*, 1914, p. 183.)

² For further information on this subject, a lecture delivered by the author in October 1913 at the National Gas Congress in London, also an article by Mr. Arthur Mead of Sheffield, in *Cassier's Engineering Monthly* for September 1913, may be consulted.

THE CARBONISATION INDUSTRIES

abnormal demands for gaseous fuel in connection with munitions factories have, for the time being at least, considerably increased its use for such purposes, and it may be confidently predicted that after the war it will continue to play an important part in the industrial field.

It should, however, be recognised that, apart from the special circumstances of its employment for munitions purposes during the war, its chief usefulness in normal times is most likely to be either (1) in the direction of supplying the manifold wants of innumerable, but relatively speaking, small industrial consumers; or (2) in connection with the manufacture of high-grade commodities, where the question of the cost of the heating operation is of less consequence than the certainty of attaining a particular result within a given time, as for instance in the heat treatment of special steels or alloys. In cases of other large scale operations, as in the heavy structural steel trades, where the cost of the gaseous fuel is of paramount importance, it will scarcely be able to compete with either producer gas, or with mixtures of coke-oven and blast-furnace gases, as a furnace fuel.

Before the war, the cities of Birmingham, Sheffield, and Glasgow led the way in the matter of supplying cheap coal gas for industrial purposes. Birmingham, in particular, had shown remarkable enterprise in the high-pressure distribution of gas, at 12 lbs. per square inch, to workshops, factories, and foundries within the city area. During the year ending March 31, 1913, no less than 1900 million cub. ft. (or 22½ per cent. of the total gas output) were sold for industrial purposes at an average price of fifteenpence per 1000 cub. ft., and a consumer taking more than 4 million cub. ft. per quarter was charged only 11.4*d.* per 1000. The gas was largely used for (1) brass and aluminium melting in crucibles, the total cost of which was said to have been less than in the older coke-fired furnaces; (2) lead melting in pots; (3) the annealing, hardening and tempering of small steel wares and the like; and (4) for glass annealing. During the war, the melting of aluminium bronzes, gunmetal, nickel, cupro-nickel, Admiralty metal, and brass billets have been added to the list. Also, gas-fired furnaces have been installed in connection with the manufacture of optical lenses, and porcelain.

The Sheffield United Gas Co. were no less enterprising than the Birmingham Municipal Authorities. Even the smallest

COAL AND ITS SCIENTIFIC USES

domestic consumer in Sheffield paid, in 1913, no more than 15*d.* per 1000 cub. ft. for gas, whilst the manufacturer using over 500,000 cub. ft. per annum was charged only 12*d.* per 1000 for all gas in excess of that amount, and for anything beyond 6 million cub. ft. per annum he paid 10*d.* per 1000 cub. ft. only. The principal uses in the industrial establishments were (1) in connection with the annealing, hardening, and tempering of special steels and other alloys; and (2) for file forging and the like.

In illustration of the effects of the war upon the demand for gas in a big munition centre like Sheffield, it may be said that thirteen of the principal firms in that city, whose consumption of coal gas in the year 1910 amounted altogether to just over 161 million cub. ft., used, in the year 1916, no less than 1004 million cub. ft., and in the year 1917 upwards of 1200 million cub. ft.

During the year ending May 31, 1913, the Glasgow Corporation sold 363 million cub. ft. of coal gas for manufacturing purposes (in addition to 344 million cub. ft. for gas engines) at an average price of 16*d.* per 1000 cub. ft., its principal use being (1) for brass and aluminium melting in crucibles; (2) for tempering and forging of tools; (3) for pipe welding; and (4) for glass annealing. During a similar period of twelve months in 1916-17, the total supplied for manufacturing purposes rose to upwards of 916 million cub. ft., or more than 2½ times the pre-war figure, the new outlets being principally in connection with shipbuilding, munitions and general engineering works. Also in the chemical trades, such processes as the evaporation and concentration of salt and sugar solutions, and the boiling of fats and oils, have all made considerable demands on the gas-works.

Another rapidly increasing application of coal gas is the annealing of the finer grades of wire in gas-fired furnaces; one firm alone in Yorkshire uses upwards of 45 million cub. ft. per annum for that purpose. It is also being largely used by the textile industries in connection with the tentering, singeing, and calendering of cloth, and the conditioning of wool. It must also not be forgotten that a very large amount of coal gas is now used in gas engines throughout the kingdom.

The important part played by the gas industry in connection with munitions of war has already been referred to, but to complete the story of its services to the nation, it ought to be added that since the outbreak of war plant has been installed in

THE CARBONISATION INDUSTRIES

practically all the large gas-works for "stripping" the gas of its benzene and toluene contents, thereby greatly adding to the supplies of raw material available for the manufacture of high explosives.

CONCLUSION

The end of the first century after its inception finds the gas industry in a state of active growth and development, adapting itself to the ever-changing requirements of our complex civilisation, and filling a foremost place in our national economy.

The net result of the century's progress, so far as the public is concerned, may be summed up by saying that when in 1818 the London Gas Works produced something between 6150 and 7400 cub. ft. of gas per ton of coal carbonised and their customers paid fifteen shillings a 1000 cub. ft. for it, during the year ending December 31, 1913, they produced 12,420 cub. ft. per ton, and charged, on the average, two shillings and fourpence per 1000 cub. ft. for it. To-day the yield is substantially the same as in 1913, but, owing to war conditions, the price is, for the time being, higher.

As it may interest the reader to know how many different items make up the cost of supplying a modern community with gas, and the proportion which each one bears to the whole, we will conclude our review by reproducing (see next page), from official records, the following analysis of the Accounts of the London Gas Companies for the year ending December 31, 1913.

COAL AND ITS SCIENTIFIC USES

TABLE LXVI
THE METROPOLITAN GAS COMPANIES' ACCOUNTS FOR THE YEAR 1913

	Totals.	Per 1000 cub. ft. of Gas Sold.
Capital and Borrowed Money	£ 40,528,420	s. d. 18 5·46
<i>Income—</i>		
Sales of Gas	5,131,568	2 4·04
Meter Rentals	234,661	1·28
Rental of Stoves, Fittings, etc.	545,093	2·98
Residual Products :		
Coke and Breeze	1,312,622	7·17
Tar and Tar Products	317,895	1·74
Amm. Liquor and Sulphate of Ammonia	412,021	2·25
Miscellaneous	30,498	0·20
Total Income from all Sources	7,990,358	3 7·66
<i>Expenditure—</i>		
Coal, Coke and Oil, including Carriage and Dues	2,868,498	1 3·67
Salaries of Works Officials	73,059	0·40
Wages—Manufacture	334,849	1·83
Purification	83,470	0·46
Wear and Tear—Manufacture	799,258	4·37
Salaries and Wages—Distribution	175,504	0·96
Maintenance of Mains and Services	301,287	1·65
Repair and Renewal of Meters, Stoves, etc.	697,418	3·81
Lighting and Repairing Public Lamps	63,300	0·35
Rents, Rates and Taxes	482,606	2·64
Salaries—Management	29,592	0·16
Collectors' Salaries and Commission	96,618	0·53
Stationery, Printing, etc.	59,532	0·32
Directors and Auditors	16,597	0·09
Co-partnership and Profit-sharing Schemes	105,948	0·58
Annuities to Officers and Workmen	86,791	0·47
Contributions, National Insurance Act	15,011	0·08
Law and Parliamentary Charges	8,153	0·04
Bad Debts and Extraordinary Expenses	22,807	0·12
Total Expenditure on Revenue Account	6,320,298	2 10·53
Gross Profit	1,670,060	9·13

CHAPTER XVI

THE CARBONISATION INDUSTRIES (*continued*)

THE COKING INDUSTRY

THE manufacture of hard metallurgical coke, which is chiefly used for the smelting of iron in blast furnaces, has always been an important industry in Great Britain since the middle of the eighteenth century. Such coke is produced by carbonising, at high temperatures and in large ovens, coals specially selected for their strongly caking properties and their relatively low ash contents.

As already shown in Chapter IV, the best coking coals are those yielding between 20 and 30 per cent. (on the "dry ashless" coal) of volatile matter when carbonised at 900° C., and the finest of them are those found in the S.W. areas of the Durham coalfield, which furnish the coke used in the blast furnaces of Durham and Cleveland.

The following are the results of an analysis of a typical first-class Durham coking coal, as freshly won from the seam in large blocks free from dirt :—

		Per cent.		
On the Dry Coal	}	Carbon	83.75	} Volatiles expelled at 900° C. = 26.7 per cent.
		Hydrogen	4.75	
		Nitrogen	1.10	
		Sulphur	1.30	
		Oxygen	7.50	
		Ash	1.60	

It does not, however, follow that coals yielding less than 20 or more than 30 per cent. of "volatiles" at 900° C. have not good coking properties. Some South Wales coals, yielding as low as 15 per cent. of volatiles, give a very dense hard coke. Also, some South Yorkshire, Derbyshire, and Lancashire coals, yielding between 30 and 35 per cent. of "volatiles," are rightly regarded as "coking" varieties, although the resultant coke from them is

COAL AND ITS SCIENTIFIC USES

somewhat inferior as a blast-furnace fuel to that from the best Durham coking seams.

The most essential qualities needed in a good blast-furnace coke, apart from low ash content, are a peculiar combination of strength and porosity, so that the fuel, whilst capable of withstanding the weight of the superincumbent materials in the furnace at a depth of some 65 or 70 ft. below the stock line, shall nevertheless be sufficiently porous to be both easily penetrated by the ascending furnace gases, and rapidly consumed by the blast at the tuyere level. It is also important that it shall be as hard and resistant as possible to the solvent action of the oxides of carbon in the furnace gases in the upper regions of the furnace. Indeed, Mr. C. D. Cochrane, a Cleveland iron-master, recently stated, in a paper read before the Iron and Steel Institute, that "the practical success of the working of a blast furnace is chiefly dependent on the mechanical condition of the coke used," an opinion that will be endorsed by every blast-furnace manager.

Hard metallurgical coke is also used (1) as the cupola fuel in iron foundries; and (2) for crucible steel smelting in Sheffield. For such purposes, a low ash content and comparative freedom from sulphur are desirable qualities.

The amount of metallurgical coke manufactured in the United Kingdom in the year 1916 was 13.42 million tons, to obtain which, just over 20 million tons of coal were carbonised. And if, as seems probable, measures are taken after the war to increase considerably the outputs of iron and steel in Great Britain, a large extension of our coking plants will be necessary. For a blast furnace must be supplied with at least from 20 to 25 cwt., according to the nature and quality of the ore, of good coke for every ton of crude iron it produces, and the laws governing the interactions between the furnace gases and the materials forming the charge leave little room for any material reduction of this amount.

Until the year 1880, or thereabouts, practically the whole of the metallurgical coke required in the world was manufactured in what are known as beehive ovens, without any attempt being made to recover any of the valuable by-products obtainable when coal is carbonised at high temperatures. It seems curious that, with the expansion of the gas industry, and the spread of technical science during the latter part of the nineteenth century, a method so obviously wasteful should have been tolerated so

THE CARBONISATION INDUSTRIES

long, but "beehive" coke was in every way so thoroughly satisfactory as a blast furnace fuel, and the ironmaster was so accustomed to its virtues, that he came to regard it with peculiar affection, and thought that no other kind of coke would suit his purpose so well. Actual experience, however, has now proved this prejudice to have been quite unfounded.

THE BEEHIVE OVEN

The old beehive oven (Fig. 39) consists of a fireclay chamber, C, circular in section with a floor sloping slightly from back to front, covered by a domed roof, and provided with (1) a door, A, at the floor level, (2) a passage, B, under the arch of the roof leading into the chimney flue, D, and (3) a hole, E, at the top of the roof communicating with the outer atmosphere, which

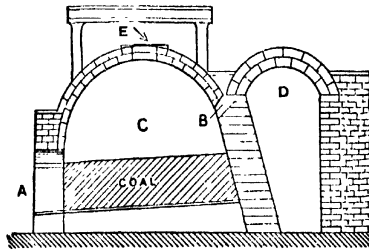

FIG. 39.—Old Beehive Oven.

may be used for charging the oven, but is always closed during the greater part of the coking period.

In working the process, a charge of ten tons of coal is either introduced through the door, A, or is dropped into the oven from tubs running on a railway above through the charging hole to a height of from $2\frac{1}{2}$ to 3 ft. above the floor. The coal is then ignited, and the door bricked up and plastered, except for a few holes about one inch or more in diameter in one or two of the upper courses of the door bricks which are left open for the admission of air. The ignited coal burns, and the heat so liberated sets up distillation in the under layers. The volatile products so expelled, rising through the decomposing mass, catch fire and burn in the dome of the oven where they meet with the air drawn in through the door. The dome is thus soon heated up to a high temperature, and by radiation powerfully assists in carbonising

COAL AND ITS SCIENTIFIC USES

the charge of coal below. Eventually, after about seventy hours, when all the volatile matter has been driven off from the coal, the door is opened, and the coke quenched by water as it lies on the oven floor, after which it is withdrawn by rakes.

It will thus be seen that inasmuch as the whole of the gas and volatile matter expelled from the coal is burnt in the oven to provide the coking heat, the sole surviving product of the operation is the coke itself. And even part of it, usually from 15 to 20 per cent., is burnt in the oven. The burnt products escape to the chimney at a high temperature and are often not utilised at all, except in the case of large batteries of ovens, although they have an evaporative power equal to the conversion of about

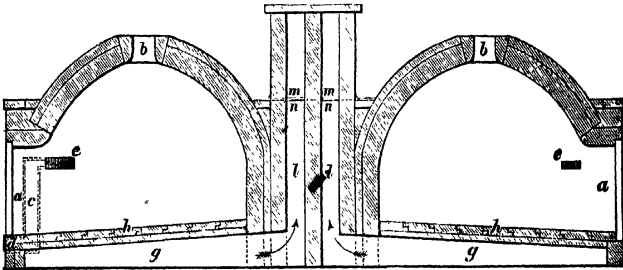

FIG. 40.—Breckon and Dixon's Coke Ovens (Sectional Elevation).

0.75 ton of water into steam "from and at 212° Fahr.," per ton of coal carbonised. Altogether the process is a very crude and wasteful one, and would never have survived so long as it has done, but for the fact that it did undoubtedly produce a uniformly good coke which, as a blast-furnace fuel, always commanded a relatively high price.

In 1858 Messrs. Breckon and Dixon designed and patented an improved beehive oven (shown in Figs. 40 and 41), in which the hot products of combustion, together with any gases in process of being burnt, were conducted away, through openings in the roof, into a series of flues under the floor, which was in this way heated. It was claimed that these improvements not only considerably shortened the coking period, but also resulted in a denser and better quality of coke. And in the course of several years' working experience of these ovens at a colliery near

THE CARBONISATION INDUSTRIES

Darlington, it was found that the coking period was reduced from 72 to 48 hours, and the coke yield increased from 58 to 69 per cent.¹

Various designs of rectangular ovens, with arched roofs, were

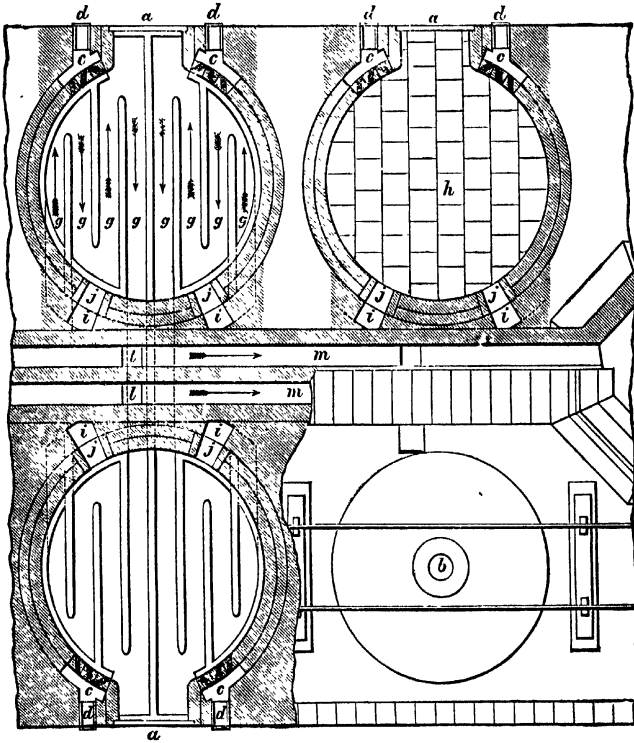

FIG. 41.—Breckon and Dixon's Coke Ovens (Plan of Four, partly in Sections).

(By permission from Phillips and Bauerman's *Elements of Metallurgy*. Charles Griffin & Co.)

proposed about this time, chiefly with a view to allowing the entire charge of coke to be withdrawn from the oven previously to its being quenched, thus avoiding cooling the oven suddenly with water at the end of each carbonising period.

¹ Phillips and Bauerman, *Elements of Metallurgy*, 2nd ed. (1887), p. 80.

COAL AND ITS SCIENTIFIC USES

EARLY ATTEMPTS AT BY-PRODUCT RECOVERY

As long ago as 1850 M.M. Pauwels and Dubouchet, and again in 1862 Pernolet, invented a system of carbonising caking coals in long rectangular chambers, heated from below by the regulated combustion of part of the gas in flues specially constructed under the floor, with the object of recovering tars, oils, and ammonia, and of producing not only coke suitable for metallurgical and other purposes, in greater proportion than in the ordinary manner, but also gas for burning and heating.

Pernolet's Oven, which is shown in plan and sectional elevation in Figs. 42 and 43, was a rectangular chamber 32 ft. long \times about 8 ft. wide, in which a charge of 6 to 7 tons of coal, spread evenly in a layer over the floor, was carbonised by heat developed in the flues underneath the floor, either by the burning of coal on the grate of a fireplace built into the setting, or by the combustion of part of the gas in the said grate and flues. The whole of the gas and volatile products evolved were passed through condensing and washing arrangements, whereby the tars and ammonia were removed, and the gas, or any surplus of it not required for providing the coking heat, could either be distributed through the public mains or be utilised in ironworks for heating purposes. At the end of the carbonising period, the coke was discharged by a steam ram which travelled along rails in front of the battery of ovens.

It will thus be seen that, although in some respects the Pernolet system foreshadowed modern by-product coking methods, it was not calculated to yield a quality of coke dense or hard enough for blast-furnace purposes, owing to the coal being carbonised in a relatively thin layer on the floor of a wide oven in which neither regenerative arrangements nor side heating flues were provided. The system was tried in the North of England in the year 1870, but the coke produced was too soft for metallurgical use. Indeed, other pioneering attempts to combine effective by-product recovery with coke manufacture fell short of success because those who made them, not being metallurgists, allowed their zeal for by-products to obscure the prime necessity of producing a first-class hard coke. Hence, doubtless, originated that prejudice on the part of ironmasters against "by-product" coke which, in later years, was in this country so formidable an obstacle to progress.

Evolution of the Modern By-product Coke Oven.—The modern

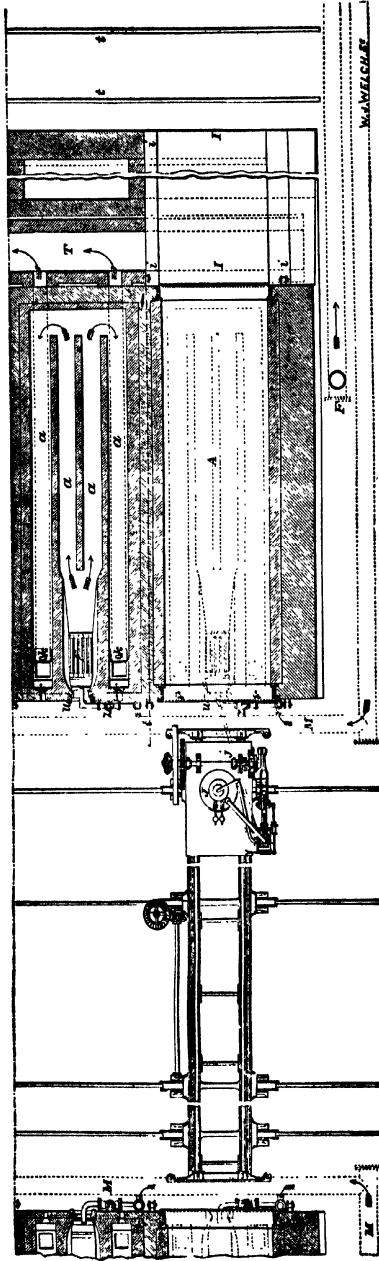

FIG. 42.—Pernolet's Coke Oven (Horizontal Section at Different Heights).
(From Phillips and Bauerman's *Elements of Metallurgy*.)

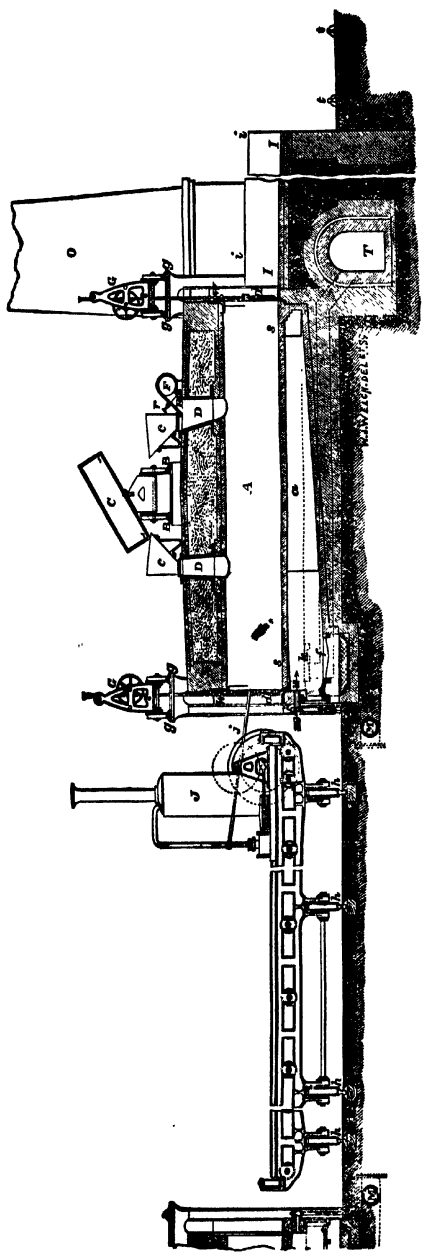

FIG. 43.—Pernolet's Coke Oven (Longitudinal Section).
 (From Phillips and Bauerman's *Elements of Metallurgy*.)

THE CARBONISATION INDUSTRIES

by-product oven is mainly the outcome of the independent work of two Belgian technologists, MM. Evence Coppée and Carvés. Coppée, whose inventions in this connection date back as far as 1861, introduced, as an improvement upon the old beehive oven, a "non-recovery" narrow rectangular oven in which a *full* charge of coal was carbonised at high temperatures, maintained by burning the resulting gases and volatile matter in vertical side flues into which was also admitted, under proper regulation, the necessary air supply. The coke was subsequently pushed out of the oven *en masse* by a ram and quenched outside it. Thirty such Coppée ovens were put down in the Sheffield district in 1873, and in the following year another sixty were installed in South Wales. Eventually some 20,000 of them were built, not only on the Continent, but largely also in Great Britain (chiefly in South Wales) and the United States, and some of them are still in operation. The Coppée Company has developed and adapted the original design for by-product recovery purposes with regenerative heating arrangements.

Carvés also (1866 to 1873), in conjunction with Knab, adopted the principle of heating narrow rectangular chambers by means of the combustion of gas in longitudinal side flues as well as in bottom flues, with the object of attaining both higher temperatures and a more uniform heat distribution. He succeeded not only in shortening the carbonising period, but also in improving the quality of the resulting coke. And when, in 1881, the late Mr. Henry Simon, of Manchester, supplemented the Carvés design by introducing a heat recuperator, whereby the air required for burning the gas in the side flues of the oven was pre-heated at the expense of part of the sensible heat in the burnt products from the flues, the Simon-Carvés system emerged as the immediate precursor of the modern by-product oven.

During the years 1880-5 several other similar systems were brought out in Belgium and Germany, among which may be mentioned those of Semet-Solway, Hüssener, Lürmann, Otto and Brunck, with the result that the practice of coking coal in the new types of narrow rectangular ovens, with some form of heat recuperation, and of recovering condensable by-products and ammonia from the gas before it was burnt in the oven flues, rapidly extended and developed on the Continent, and soon became almost universal there.

The new methods were, however, very slowly adopted both in Great Britain and America, in spite of the large profits to be

COAL AND ITS SCIENTIFIC USES

gained out of by-product recovery, owing mainly to the prejudice already referred to against by-product coke, which has only been gradually overcome as experience demonstrated its groundlessness. It may be said that, except for a few by-product installations here and there in the North of England, no great headway was made in this country until the opening of the present century.

With regard to the United States, the British Iron Trade Commission which visited that country and subsequently reported upon "American Industrial Conditions and Competition" in the year 1902, stated that by-product coke was then almost unknown in the Connellsville region which supplies the Pittsburg furnaces, although in other districts it was making progress. At the end of 1900 there were in the United States as a whole only 1085 by-product ovens built, the output of by-product coke in that year being no more than 1,075,727 tons out of a total production of 20,533,348 tons (or say 1 in 20). Four years previously, the proportion of by-product coke had been only 83,038 out of a total of 11,788,773 tons (or say 0.7 per cent.).

Among the more important technical developments within recent years in connection with by-product coking practice may be mentioned: (a) the substitution of "regenerators" similar to those employed in open-hearth steel furnaces of the Siemens type, for the older "recuperator," as a more effective means of utilising the serviceable heat of the hot products leaving the combustion flues of the ovens, and of increasing the supplies of gas available for outside purposes; (b) the total removal of tar from the hot gases by means of a tar spray at a temperature above their dew point, combined with the *direct* recovery of ammonia (as sulphate) on the main gas circuit; and (c) the recovery of naphthalene which was rendered feasible by the adoption of (b), together with improvements in the recovery of benzols from the gas.

COMPARISON BETWEEN THE BEEHIVE AND BY-PRODUCT PROCESSES

For purposes of showing how much more economical are the modern by-product systems than the older beehive practice which they have superseded, the author cannot do better than quote the following data¹ given by his friend, and one-time

¹ From the article upon "Coke Manufacture and the Recovery of By-Products" in Thorpe's *Dictionary of Applied Chemistry*, 1912 ed., Vol. II., p. 105. a

THE CARBONISATION INDUSTRIES

pupil, Mr. Ernest Bury, M.Sc., formerly of the Brackley Coke Works, and now of the Skinningrove Iron Co. Ltd., who has done so much to promote sound knowledge of the subject among British manufacturers.

TABLE LXVII

MR. E. BURY'S ESTIMATE OF THE RELATIVE YIELDS OF PRODUCTS FROM A COAL CONTAINING 30 PER CENT. OF VOLATILE MATTER

Types of Ovens.	Beehive.	By-product.
Operating Conditions	(a) Coking chamber heated by the combustion of gas and volatiles <i>within</i> it. (b) Air admitted into oven. (c) Coke quenched <i>inside</i> the oven.	(a) Coking chamber heated <i>externally</i> by combustion of gas from which by-products have been extracted. (b) Air excluded from oven. (c) Coke quenched <i>outside</i> the oven.
Percentage Yields in Dry Coal	Coke 56.0 Tar nil Crude Benzol nil NH ₃ as Sulphate nil	70.0 4.0 to 4.5 1.0 1.0 to 1.2
Waste Heat	Usually not utilised, but approximately equal to the evaporation of 0.75 ton of water per ton of coal carbonised.	Always utilised : equal to 1 ton of water evaporated per ton of coal carbonised.
Surplus Gas	nil	2000 to 5000 cub. ft. per ton of coal carbonised.

With regard to the above data it may be observed :—

- (1) that the absolute figures given for coke yields apply to a coal supposed to contain 30 per cent. of volatile matter ; for a typical Durham coking coal containing 25 per cent. volatiles, they would be 65 per cent. for beehive and 75 per cent. for by-product ovens.
- (2) that the amount of "surplus gas" available depends on whether the transfer of heat from the hot burnt gases

COAL AND ITS SCIENTIFIC USES

leaving the oven combustion flues to the incoming cold air on its way to the flues is carried out (a) in the older types of heat *recuperators* (Waste Heat Ovens), or (b) by means of *regenerators* similar to those employed in open-hearth steel furnaces (Regenerative Ovens). In Waste Heat Ovens the surplus gas does not exceed 3000 cub. ft., whereas in Regenerative Ovens it is seldom less than 4000 cub. ft. per ton of coal carbonised.

- (3) that the figure for the yield of tar seems somewhat high; for most North of England Coking Coals it will range between 3.5 and 3.85 per cent. (See Table LXIX hereafter.)

On the basis of prices prevailing before the war (1910-1912) Mr. Bury estimated the gross and net values of products per 100 tons of coal carbonised to be as follows :—

	Gross Value.			Cost of Recovery.			Net Value.		
	£	s.	d.	£	s.	d.	£	s.	d.
1 Ton Ammonium Sulphate	12	0	0	2	10	0	9	10	0
4.5 Tons Tar at 18s.	4	1	0	9	0	0	3	12	0
300 gallons Crude Benzol at 5d.	6	5	0	1	17	6	4	7	6
Total per 100 Tons	<u>£22</u>	<u>6</u>	<u>0</u>	<u>£4</u>	<u>16</u>	<u>6</u>	<u>£17</u>	<u>9</u>	<u>6</u>

According to this estimate the net profit per ton of coal carbonised would be equal to 3s. 6d., to which should be added the fuel value of the surplus gas, reckoned at 3d. per 1000 cub. ft. It is also important to bear in mind that a much larger yield of coke is obtained in by-product than in beehive ovens.

Concerning the quality of by-product coke as a blast-furnace fuel, my relative, Mr. T. C. Hutchinson, Managing Director of the Skinningrove Iron Co., who during the past forty years has acquired an unrivalled experience in smelting Cleveland ironstone with Durham coke, has recently assured me in writing that the change over from beehive to by-product coke at the Skinningrove Works has not appreciably affected the consumption of it in the blast furnace. Indeed, the exceptionally low consumption during recent years in the Skinningrove furnaces (namely 22.5 cwt. per ton of Cleveland iron produced) of coke made in the Company's own by-product ovens from an *unwashed* Durham coal containing an average of 10 to 11 per cent. of ash, is in itself a practical and conclusive proof that "by-product" is in no way inferior to "beehive" coke as a blast-furnace fuel.

THE CARBONISATION INDUSTRIES

In this connection, however, it should be understood that the quality of by-product coke varies according to the nature of the coal from which it is produced, and therefore that comparisons made between cokes from different localities are apt to be misleading. Thus, for example, a by-product coke from a South Yorkshire coal would probably prove to be decidedly less economical in the blast furnace than the best "beehive" Durham coke, although the latter will not be superior to the coke made from the same Durham coal in a by-product oven. What the reader must understand is that there is no longer any ground for supposing that, *from one and the same coal*, "beehive" has any inherent superiority over "by-product" coke as a blast furnace fuel.

One great advantage which the "by-product" possesses over the "beehive" oven is that by admitting of the compressing of the coal before it is charged into the oven, it enables inferior qualities of coal, which it would be impossible to coke with good results in a beehive oven, to be utilised for the manufacture of a satisfactory metallurgical coke. This applies particularly to Scottish coals, but compressing any coal of inferior coking properties before charging it into the oven will always be found to improve the quality of the resulting coke, making it harder and denser. Such compression is best done with a "washed" coal, because a moisture content of not less than 9 per cent. is necessary to ensure the cohesion of the small particles of crushed coal in a solid block or "cartridge" so that it does not fall to pieces when being pushed into the oven.

PROGRESS IN THE BY-PRODUCT COKING INDUSTRY IN GREAT BRITAIN SINCE 1900

As already stated, by-product recovery methods made surprisingly little headway in this country until the beginning of the present century, but from about the year 1903 progress became much more rapid, as the following figures indicate:—

British By-product Coking Plants.			
Year.	Estimated Mill. Tons of Coal Carbonised.	Tons of Am- monium Sulphate Produced.	No. of Beehive Ovens in Operation.
1903 . .	1·75	17,435	—
1908 . .	6·45	64,227	—
1913 . .	13·38	133,816	13,162
1916 . .	14·60	159,506	6,892

COAL AND ITS SCIENTIFIC USES

How far we lagged behind Germany in the production of ammonium sulphate in coke ovens during the first decade of the century will be apparent from the following figures, given by Professor O. Rau of Aachen,¹ although it may be noted that our backwardness in this respect was in some measure compensated for by the much larger dimensions of our coal-gas industry :—

Year.	Ammonium Sulphate (in 1000 Tons) obtained by Carbonising Coal in			
	Coke Ovens.		Gas Works.	
	Gt. Britain.	Germany.	Gt. Britain.	Germany.
1900 . . .	10	80	145	20
1903 . . .	18	111	152	25
1906 . . .	44	200	160	30
1909 . . .	75	278	171	40

It seems probable that at the present time about three-quarters of the coal carbonised for metallurgical coke in Great Britain is being dealt with in by-product ovens, and, such has been the impetus imparted by war conditions, that the time is rapidly approaching when the old beehive ovens will have become as extinct here as they have been for so many years past in both Belgium and Germany.

There were, in November 1917, about 8700 by-product ovens of all types built and in operation in the United Kingdom, with a total rated carbonising capacity of 17.5 million tons of coal per annum. Of these, about 3500 were of the regenerative type, and 8000 were fitted with benzol recovery arrangements. A considerable number more were in course of construction, all of the latest types, and it is probable that before long the number of ovens in operation will be as large as 10,000, with a total carbonising capacity of 20 million tons of coal per annum. Indeed, the experience gained during the war, together with the fact that so large a proportion of our plants are of the most recent type, give much ground for hoping that our coking industries will never again be allowed to fall behind those of the Continent.

Supposing, then, that the above-mentioned 20 million tons of coal were all to be carbonised in regenerative by-product ovens, with benzol recovery, the *gross* and *net* values of the by-product

THE CARBONISATION INDUSTRIES

TABLE LXVIII
SOME LABORATORY TESTS OF REPRESENTATIVE BRITISH COKING COALS

Coal No.	1	2	3	4	5	6	7	8	9	10	11	12	13	14	
Origin	Scotland, Stirling.	Scotland, Dumfries.	Durham.	Durham.	Durham.	S. Yorks.	S. Yorks.	Lancs.	N. Staffs.	S. Staffs.	Wilts.	Monmouth.	S. Wales, Glam.	S. Wales, Glam.	
Yields of 1	Ash	2.06	5.47	8.30	6.00	7.00	4.17	7.65	5.50	7.10	3.91	8.37	4.51	8.45	
	Volatiles	23.50	32.46	27.97	21.38	24.15	27.33	26.71	25.80	35.04	24.50	21.17	20.0	18.71	
	Gas	12.0	11.5	12.0	11.2	11.6	11.0	11.6	11.5	12.15	11.1	11.0	11.2	11.0	
	Tar	3.34	5.25	4.22	3.46	4.22	4.67	3.82	2.78	2.15	5.39	5.60	2.93	2.47	2.58
	Ammonium Sulphate	1.59	1.68	1.59	1.13	1.58	1.35	1.39	1.83	1.54	1.67	1.23	1.09	1.04	1.01
Coke {	Description	Hard	Hard	Dense and Very Hard	Hard	Hard	Hard	Hard	Hard	Hard	Dense, Strong	Very Hard	Very Hard	Very Hard	
	% Sulphur	0.78	1.01	—	—	1.33	1.22	1.72	—	1.85	—	—	1.13	0.925	

1 Expressed in percentages, except "Gas," which is in thousands of cubic feet at 15° C. and 760 mm. per ton of dry coal.

COAL AND ITS SCIENTIFIC USES

and surplus gas, based on pre-war standards, would be as follows :—

	Gross. £	Net. £
600,000 tons of Tar at 18s.	540,000	480,000
220,000 tons Ammonium Sulphate at £12	2,640,000	2,100,000
60 Mill. Galls. Crude Benzol at 5d.	1,250,000	875,000
100,000 Mill. Cub. Ft. of surplus gas at 3d.	1,250,000	1,250,000
	Total = £5,680,000	£4,705,000

With regard to America, it has been reported¹ that, at the end of 1915, there were in the United States 6268 by-product coke ovens already built, and 1191 more in course of construction. And in a paper read by T. C. Clarke before the New York Section of the Society of Chemical Industry in 1916,² it was stated that, as soon as all the new ovens then being built were in full operation, the possible production of by-product coke in the United States would amount to 24 million tons per annum, although it was admitted that neither tar nor ammonia recovery then had become so good as in either Great Britain or Germany.

BRITISH COKING COALS

Fortunately for the prospects of our metallurgical industries, we have in this country a wide range of good coking coals, although the probable supplies of the very best kinds are not unlimited, a circumstance which should make us all the more careful to use them economically and to the best advantage.

In Table LXVIII are recorded the results of comparative Laboratory Trials of a number of a series of fourteen representative British Coking Coals, which may serve to indicate their *relative* values.

Finally, the average yields of coke and by-products actually obtainable from British coking coals of different origin by the most up-to-date recovery methods may be taken to be approximately as follows :—

¹ *Iron and Coal Trades Review*, Feb. 1917.

² *Metallurgical and Chemical Engineering*, 1916, Vol. XIV., p. 502.

THE CARBONISATION INDUSTRIES

TABLE LXIX

PERCENTAGE YIELDS, CALCULATED UPON THE WEIGHT OF DRY COAL
CARBONISED, OBTAINABLE FROM BRITISH COKING COALS

Origin of Coal.	Coke.	Anhydr- ous Tar.	Crude Benzol.	Refined Benzols.	Ammonium Sulphate.
Durham . . .	75.0	3.85	0.93	0.56	1.16
S. Yorkshire . . .	70.0	3.62	1.37	1.00	1.35
Lancashire . . .	70.0	3.50	1.20	0.84	1.25
S. Wales . . .	80.0	2.62	0.60	0.35	0.95
Scotland . . .	68.0	3.25	0.70	—	1.00

MODERN BY-PRODUCT COKE OVENS

The modern by-product coke oven is a rectangular chamber from 30 to 33 ft. long, 6 to 9 ft. high, and from 17 to 22 in. wide, with side and bottom heating flues. It is closed at each end by a cast-iron or steel firebrick-lined door, which is lifted by a small crane whenever the contents of the oven are discharged. There are usually three equidistant circular holes in the roof through which the coal is charged into the oven from hoppers, and into a fourth hole near the front is fitted an iron "ascension pipe," through which the gases and volatile matter expelled during the carbonising period are led into the tar-sealed "hydraulic main" which runs along the whole battery of ovens much as in gas-works practice (*q.v.*).

In most British and Continental plants the oven linings and combustion flues are constructed of special bricks which are manufactured from a mixture of a high-grade fireclay and some siliceous material such as ganister. The finished bricks should contain not less than 80 per cent. of silica, upwards of 14 per cent. of alumina, not more than 2 per cent. of iron oxide, while the alkalis should be less than 1.3 per cent., and the lime and magnesia each less than 0.5 per cent. In the United States, silica bricks containing 92 to 96 per cent. of silica, 2 to 3 per cent. of alumina, and 1.3 to 2.5 per cent. of lime, are extensively employed on account of their superior heat conductivity. Such highly siliceous bricks, however, have so far not been favoured by British coke manufacturers, who consider that a more aluminous brick is more durable, especially with coals whose moisture content, when charged into the oven, exceeds about 7 per cent.

The design of the side-heating flues varies in different ovens;

COAL AND ITS SCIENTIFIC USES

in the Simon-Carvés (waste-heat), Semet-Solway, Hüssener, and Simplex, they are horizontal, whilst in the Coppée, Koppers, Otto, and Simon-Carvés (regenerative), they are vertical. Also the details of the arrangements for distributing and burning the gas (after all the condensable products and ammonia have been removed from it) in the heating flues vary in the different designs. In all cases, however, the air required for combustion is pre-heated, at the expense of part of the sensible heat in the burnt gases passing away from the ovens, before it enters the combustion flues.

The ovens are built in batteries of from 25 to 60 units. Each oven carbonises a charge of about 8 to 12 tons of coal in from 28 to 36 hours, and a battery of 60 ovens will take about 2500 to 3000 tons of coal and produce from 1750 to 2200 tons of coke per week.

The method of charging the ovens depends upon the nature of the coal. In most cases small slack or crushed coal from which the "dirt" has been removed in a "washery" is used, and it is important from the point of view of heat economy that it should be drained until its moisture content has been reduced to below 6 per cent. before being charged into the oven, excepting where the coal is to be compressed, when the moisture can only be reduced to 9 per cent.

The hard coking Durham or Welsh coals are usually allowed to flow loosely from the hoppers into the oven through the aforesaid holes in the roof, the charges being subsequently levelled by a mechanical device introduced through one of the end doors. In the case of the less strongly coking coals of S. Yorkshire and Lancashire, the crushed coal is compressed by a mechanical stamping machine in a wrought steel box slightly less in size than the oven chamber, and thrust *en bloc* into the oven as a solid cartridge through the front doorway on the movable bottom of the box which forms the charging peel. At the end of the carbonising period the coke is discharged from the ovens by an electrically driven ram on to a sloping bench where it is quenched by water. Plate IV is a back view of a battery of Otto ovens, showing the coal bunker, hydraulic main, quenching apparatus, and the sloping bench in which the quenched coke is drained.

It is of the utmost importance that the heating of the ovens should be uniform, and that after the introduction of a fresh charge the temperature of the coal should be raised as rapidly as possible. And inasmuch as the heat is applied from both of

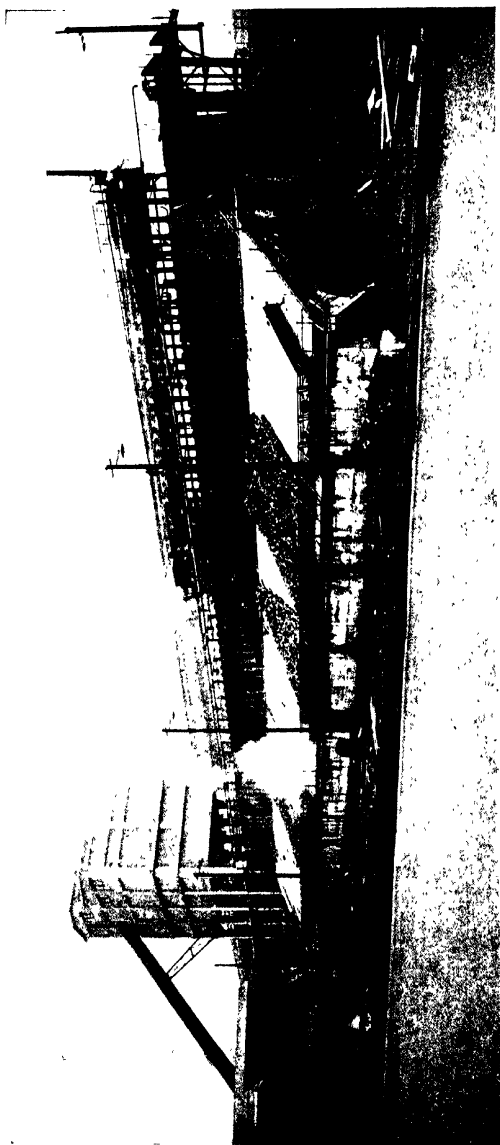

PLATE IV.—Back View of a Battery of Otto Coke Ovens.

THE CARBONISATION INDUSTRIES

the side walls of the oven the charge is carbonised from each side towards its middle plane.

For details of the design of the principal coke ovens used in Great Britain the reader is referred to the late Mr. G. Stanley Cooper's book on *By-product Coking* (Benn Bros. Ltd., London, 1917). Through the courtesy of his publishers the author is able to reproduce here the following diagrams of the Otto Regenerative and Waste Heat ovens respectively (Figs. 44 to 47 inclusive), as typical examples of modern coke-oven construction, which, together with the foregoing descriptive matter, will, it is hoped, enable the reader to understand the main features of the general design.

DIRECT RECOVERY SYSTEMS

Up to a few years ago coke-oven engineers were content to follow the main lines of the older gas-works practice in regard to the arrangements for the cooling of the gas, the condensation and removal of tars, and the recovery of ammonia (as sulphate) from the crude products. The first attempt to depart from these lines was made by F. Brunck of Dortmund, who endeavoured to absorb the ammonia by a "direct" method, on the main gas circuit, by passing the hot gases through sulphuric acid. But inasmuch as he did not first of all remove the tar, he was unable to make a good salt, and his efforts came to nothing.

Koppers's Process.—Subsequently H. Koppers of Essen devised a "semi-direct" process for the recovery of ammonia, in which, after condensing all the tars and much of the moisture from the gas, the latter was passed (1) through pipes externally heated by hot waste gas from the oven in an apparatus (called the heat exchanger) in order to raise its temperature well above the dew point, and thence (2) direct into a "sulphate saturator" containing sulphuric acid, into which was also passed the ammonia distilled in the ordinary way by means of steam and lime from any liquor made in the condensers. In this way all the combined and "free" ammonia in the gas leaving the ovens was converted into sulphate in a saturator on the main gas circuit. And inasmuch as (1) the gas passes into the saturator at a temperature well above its dew point and (2) the reaction between the ammonia and sulphuric acid in the saturator is exothermic, dilution of the liquor in the saturator may be prevented so that the separation of solid ammonium sulphate may proceed continuously.

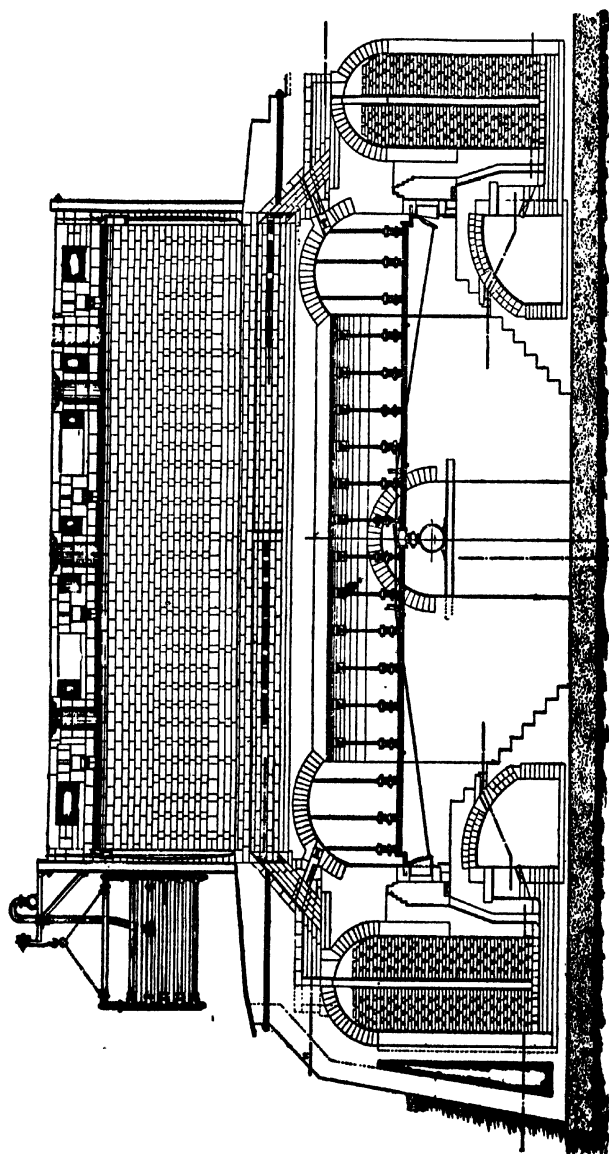

FIG. 44.—Section through Otto Regenerative Oven.

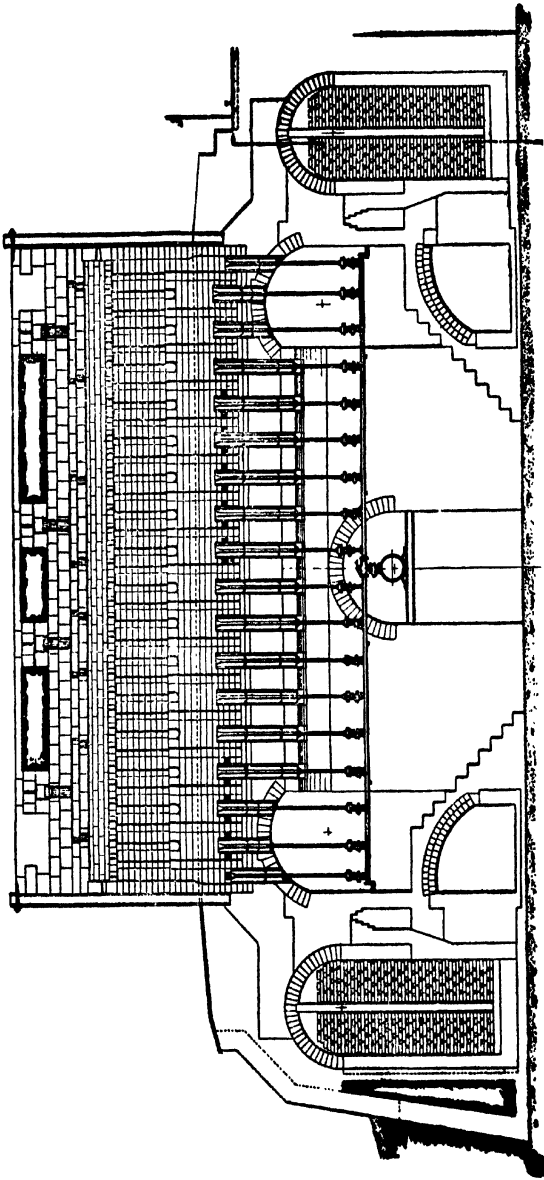

FIG. 45.—Section through Wall of Otto Regenerative Oven.

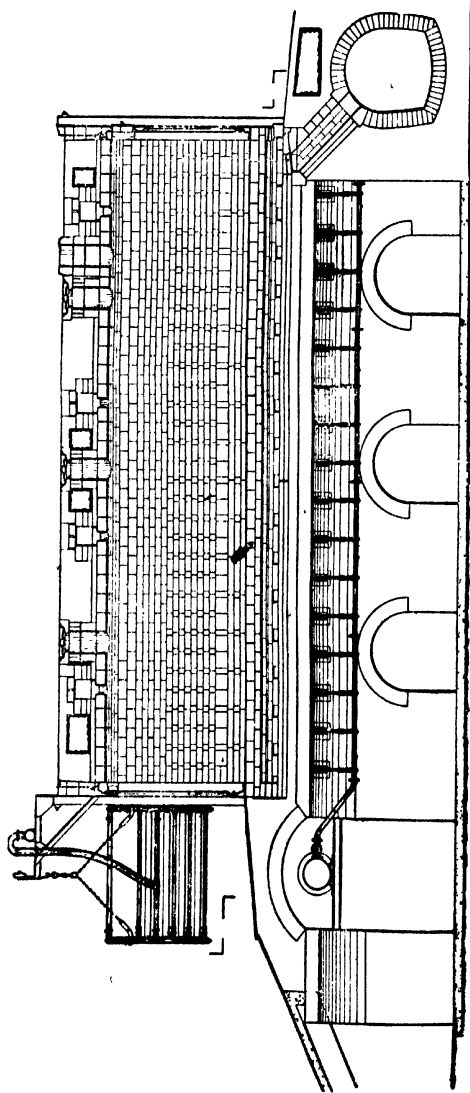

FIG. 46.—Section through Otto Waste Heat Oven.

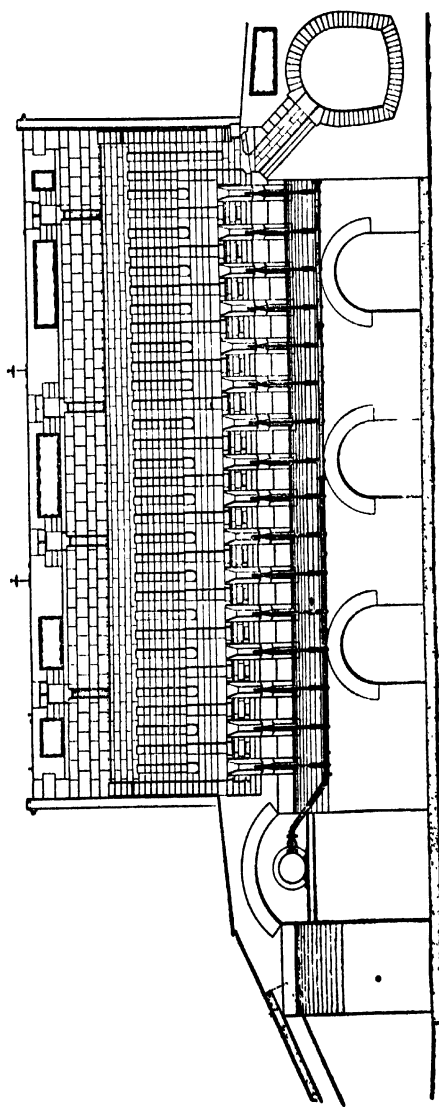

FIG. 47.—Section through Wall of Otto Waste Heat Oven.

COAL AND ITS SCIENTIFIC USES

THE OTTO DIRECT RECOVERY PROCESS

A further advance was made by the Otto-Hilgenstock Company of Dahlhausen in their new "Otto Direct Recovery Process," of which an outline will now be given. Briefly, it consists in extracting all the tar from the hot gas above its dew point, and then forcing the tar-free gas, without any re-heating, through a saturator in the main circuit containing dilute sulphuric acid, under conditions such that the natural heat in the gas, aided by the exothermic interaction of the ammonia and sulphuric acid, keeps the volume of the absorbing liquor constant so that the separation of ammonium sulphate proceeds continuously.

Such a method of "direct recovery" entirely dispenses with the use of water coolers, ammonia scrubbers, lime mixer and ammoniacal liquor stills, and waste liquor tanks, reduces the loss of ammonia to a minimum, economises space and labour, and avoids the making of deleterious effluents which formerly were such a serious source of trouble.

The process is represented diagrammatically in Fig. 48. The crude gas leaves the ovens by means of the usual ascension pipes and thus enters the hydraulic main through which tar is continuously circulated, in order to remove any heavy tars or pitchy matter deposited therein. From this point the gas travels through a long horizontal overhead "air cooler," A, whose real function is to cool the hot gas down to a temperature just a little above its dew point, which naturally varies according to the amount of moisture which the gas carries over with it from the ovens. The amount of cooling necessary therefore depends somewhat upon the nature of the coal, but chiefly upon its moisture content when charged into the ovens.

Recovery of Tar and Ammonium Chloride.—After leaving the air cooler, the gas passes on to the "tar extractor," B. It is here met by a large volume of hot tar and liquor which is pumped into the apparatus and forced "injector-wise" through a narrow nozzle under a high pressure, in such a manner that it is broken up into a fine spray. The crude gas is drawn into the apparatus by this "injector" action, and the sprayed tar and liquor dash against the small tar vesicles contained in the gas. This mechanical spraying of the gas, together with the solvent action of the washing medium, results in the complete removal of tar, including tar fog, from the gas, which passes out of the extractor

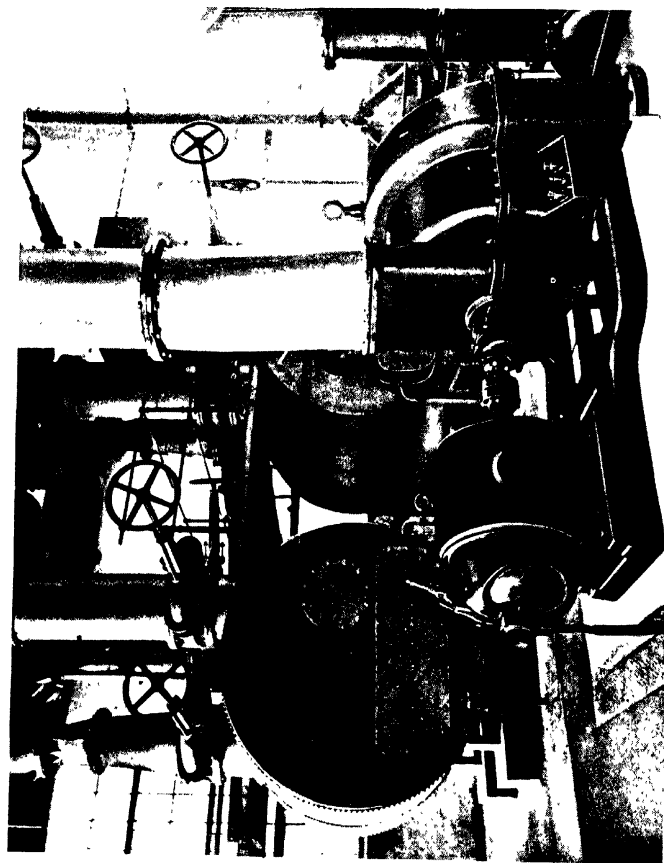

PLATE V.—Otto Tar Sprayer.

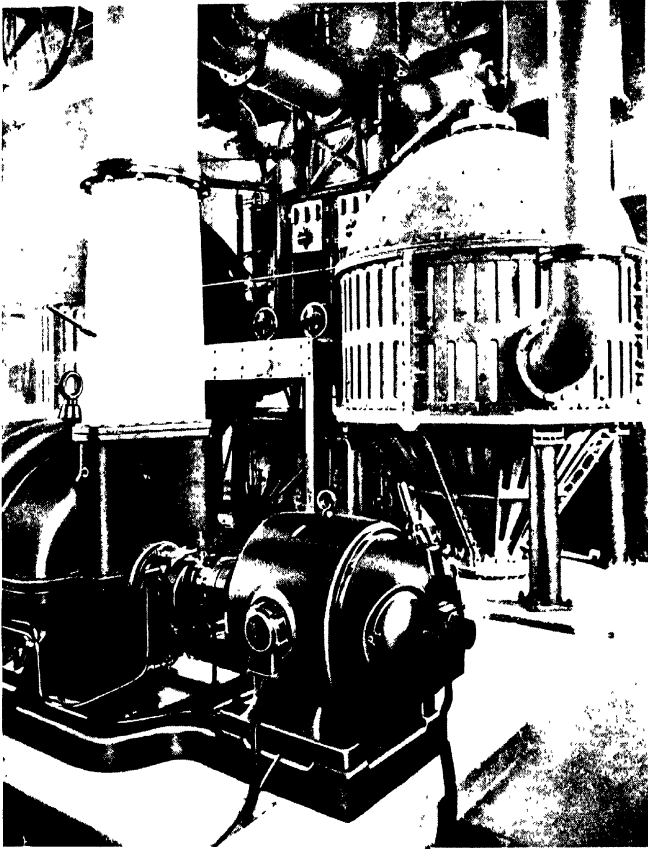

PLATE VI.—Otto Saturator.

THE CARBONISATION INDUSTRIES

in a perfectly clean condition. Also, it should be noted that if a "salty" coal is being carbonised, so that the crude gas contains ammonium chloride, the latter may be removed at the tar sprays as a fairly strong aqueous solution. Indeed, "fixed ammonia" generally may be removed at this point provided the temperature conditions are such as will allow of the condensation of a small amount of liquor in the apparatus. From this the importance of a perfect control of the temperature of the gas, both in entering and leaving the apparatus, will be understood. A photograph of the "tar sprayers," as they are called, is reproduced in Plate V. The tar extracted from the gas overflows into the tar deposit tank, C, which also serves to recover any tars which separate out in the long "air cooler," A, already referred to.

Recovery of Ammonia.—The tar-free gas, which still contains the free ammonia, benzol, and nearly the whole of the naphthalene and water vapour, passes onwards, at a temperature (say between 65 and 75° C.) so regulated as to be near to (but not below) its dew point, into the large enclosed "saturator" D (see also Plate VI), containing a hot saturated solution of ammonium sulphate plus an excess of sulphuric acid. In this apparatus, which is lead-lined and cased in a cast-iron framework, the gas is divided into a very large number of small streams, and, under the suction of an exhaustor, K, applied at a point further along the system, it is drawn through the seal of the acid liquor, whereby all the ammonia is removed, and precipitated as sulphate in the coned bottom of the saturator. The exothermic reaction serves to keep the temperature of the gas above the dew point, so that no condensation of steam occurs in the saturator. The salt is mechanically and continuously ejected from the apparatus by means of compressed air, together with a certain amount of solution, into the cone-shaped receiver, E. The ammonium sulphate crystals settle to the bottom of this receiver, whilst the hot mother liquor overflows from the top and finds its way back into the saturator. When this cone-shaped receiver is full of the crystallised sulphate it is passed into a centrifugal dryer, F.

In this machine the sulphate is made thoroughly dry in about three minutes, the mother liquor thus extracted mixing with the above-mentioned mother liquor and with it flows back into the saturator, whilst the dried sulphate of ammonia is dropped through the bottom of the centrifugal machine, sufficiently dry to be immediately bagged and shipped or put into stock, as shown

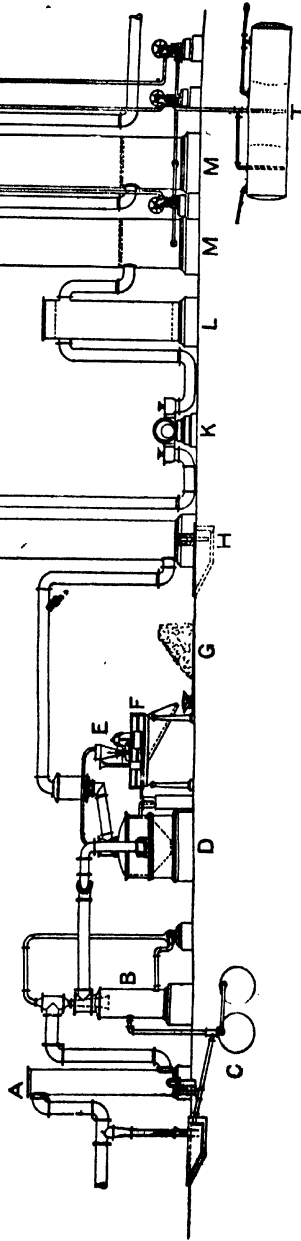

FIG. 48.—Otto Direct Recovery Process.

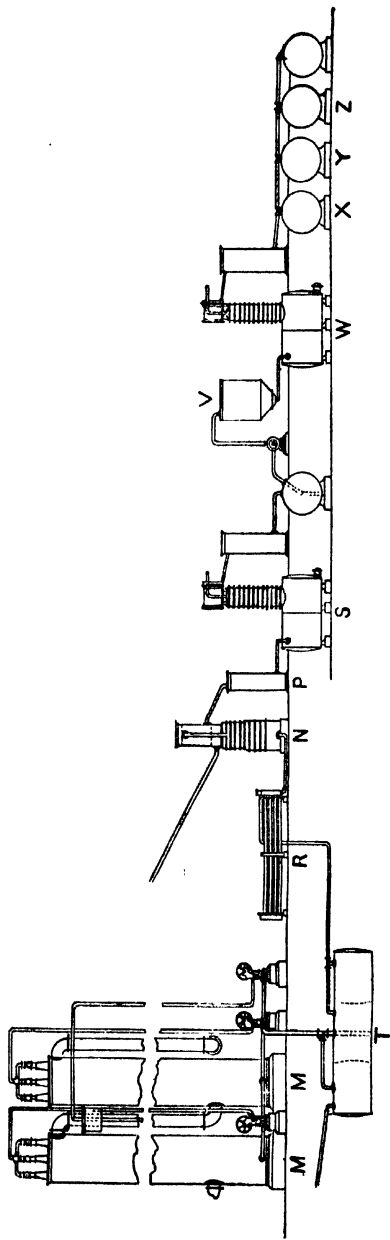

FIG. 49.—Otto Direct Recovery Process.

COAL AND ITS SCIENTIFIC USES

at G, in the diagram. A photograph of the saturator is reproduced in Plate VI.

Recovery of Naphthalene.—The gas from the saturator, which is now freed from both ammonia and tar, but still containing the benzol, moisture and naphthalene, passes through a lead-lined catch pot (not shown in the diagram, but whose situation prevents all fear of any acid spray being carried over from the saturator) and on to the naphthalene extractor and spray cooling tower, H. This tower is quite devoid of any filling or apparatus, but at the top there are several jets through which cold water is sprayed at high pressure. The action of this mass of finely-divided cold water beating suddenly on to the hot gas produces a rapid chill, which, together with the concussion brought about by the water, precipitates and washes out practically all the naphthalene, which flows away along with the water into a catch tank beneath this apparatus. The naphthalene is filtered off whilst the water can be either allowed to flow away, or re-cooled and used over again continuously, as circumstances permit. This tower also serves the purposes of cooling the gases. It is necessary to extract the naphthalene, otherwise it would pass on to the Benzol Scrubbers, where it would be dissolved by the Benzol Wash Oil, which would very soon become saturated with naphthalene and rendered useless for the purpose of collecting benzol. The naphthalene thus extracted is of a pale yellow colour, and is readily sold in this country for 50s. a ton, which more than pays the cost of running this part of the Plant.

Recovery of Benzols.—The gas now being cooled but still containing the benzol, passes through the exhauster, K, and a second water cooler, L, which takes out the last traces of moisture, and thence to the benzol scrubbers, MM, which vary in number according to the size of the plant. These scrubbers are from about fifty feet to seventy feet high, the lower portion forming a reservoir for the circulating benzol wash oil, and the remaining portion being filled with wooden grids. Benzol wash oil is constantly circulated downwards over these grids, the gas having to pass upwards through them. By this means the gas is brought into very intimate contact with the oil, with the resulting absorption of the benzol. After leaving these scrubbers the gas passes either wholly back to the ovens, or in the case of Regenerative ovens, about one half of it returns to the ovens, and the other half is used either for firing boilers, town lighting, operating gas engines, or any other purpose.

A fuller account of the process is given in a paper by Mr. E.

THE CARBONISATION INDUSTRIES

Bury before the Institution of Mining Engineers in the year 1914, from which the following temperatures of a plant at New Brancepeth Colliery (Co. Durham) are taken :—

	Cent.°		Cent.°
Hydraulic Main . . .	225°	In Saturator . . .	67°
Before Tar Extraction .	86°	After „ . . .	58°
After „ . . .	58°	After Exhauster . . .	66°

Distillation and Rectification of Benzols.—The “Wash Oil” containing the benzols in solution is sent on to the continuous Crude Benzol Still, N. (Fig. 49), where, after being pre-heated by the hot vapours coming away from the still, it passes downwards over a series of trays. Dry steam at about 100 lb. pressure, reduced, however, at the still to 10 lb. pressure, is delivered into the bottom of the apparatus, and passing upwards bubbles through the Wash Oil liberating the benzol hydrocarbons which it carries over into the condenser, P. Here the steam and benzols are condensed, and the condensed water and oil separated. The crude benzol then either passes into a storage tank, or (if its rectification is to be carried out) into the “Primary Rectifying Still,” S. The debenzolised “Wash Oil” leaving the crude benzol still is passed through the Refrigerator, R, whence, after being cooled down to the atmospheric temperature, it is sent into the “Oil Storage Tank,” T, and from there it is used over again in the Benzol Scrubbers.

The crude benzol is first of all fractionally distilled in the Primary Rectifying Still, S, 3000 to 5000 gallons capacity and intermittent in its working, in which it is heated under high pressure by means of steam coils, and, with the aid of a long dephlegmating column, it is separated into :—

- (1) Crude 90 per cent. Benzol
- (2) „ 90 „ „ Toluol
- (3) „ 90 „ „ Xylol
- (4) „ 90 „ „ Solvent Naphtha

Each of these fractions is separately condensed and pumped into a large vessel, V, termed the Agitator, where it is successively treated with (a) pure strong sulphuric acid, and (b) a solution of caustic soda, in order to remove all resinous, basic, or acidic substances. Each of the “washed” fractions is finally re-fractionated under reduced pressure in the “Secondary Rectifying Still,” W, and the re-distilled resulting fractions, after

COAL AND ITS SCIENTIFIC USES

condensation, are sent forward into their respective storage tanks, XYZ, ready for transport.

Other firms (*e.g.* the Simon-Carvés and the Simplex Companies) have also adopted efficient "direct recovery" processes, on much the same lines as the Otto process just described, the chief difference between them being in the precise mechanical arrangement for the removal of tar and tar fog from the hot gas before it enters the saturator where the ammonia is absorbed.¹

THE UTILISATION OF COKE OVEN GAS

That the composition of the gas obtained by carbonising a given coal at high temperatures is not materially affected by the substitution of a coking chamber, of the type described on p. 315 for a vertical gas retort, may be judged by comparing the following figures with those given for town's gas in the preceding chapter:—

TABLE LXX
COMPOSITION OF COKE OVEN GAS FROM TYPICAL BRITISH COALS
(WITHOUT BENZOL RECOVERY)

Coal.	A. Durham.	B. Lancashire.	C. 50 p. c. S. Yorks. 50 p. c. Derbyshire.	
Percentage Volatiles	26.0	30.2	—	
Type of Oven . . .	Otto-Regenerative	Semet Solway Waste Heat	Koppers's Regenerative; heated by Mond Gas.	
Percentage Composition of the Gas	$\left\{ \begin{array}{l} \text{CO}_2 \text{ . . .} \\ \text{CO} \text{ . . .} \\ \text{C}_n\text{H}_m \text{ . . .} \\ \text{CH}_4 \text{ . . .} \\ \text{H}_2 \text{ . . .} \\ \text{N}_2 \text{, etc. . .} \end{array} \right.$	$\left\{ \begin{array}{l} 2.5 \\ 6.5 \\ 3.2 \\ 28.0 \\ 48.0 \\ 11.8 \end{array} \right.$	$\left\{ \begin{array}{l} 2.5 \\ 6.4 \\ 3.7 \\ 33.9 \\ 49.1 \\ 4.4 \end{array} \right.$	$\left\{ \begin{array}{l} 2.1 \\ 7.8 \\ 2.9 \\ 30.0 \\ 50.0 \\ 7.2 \end{array} \right.$
Yield of Gas, cub. ft. per ton of Coal . . .	—	—	12,640	
Calorific Value of Gas, B.Th. Us. per cub. ft. at 15° C. and 760 mm.	$\left\{ \begin{array}{l} \text{Gross} \\ \text{Net} \end{array} \right.$	$\left\{ \begin{array}{l} 536.5 \\ 475.7 \end{array} \right.$	$\left\{ \begin{array}{l} 611.3 \\ 542.9 \end{array} \right.$	$\left\{ \begin{array}{l} 560.7 \\ 497.1 \end{array} \right.$

¹ See a paper on "Recent Developments in By-product Coking," by Mr. G. Blake Walker. (*Proc. Inst. Civil Engineers*, 1917.)

THE CARBONISATION INDUSTRIES

Debenzolisied Gas.—The amount of benzol vapours included among the unsaturated hydrocarbons C_nH_m in the above Table would be approximately 1 per cent. in each case, and the effect of removing them would be to reduce the calorific value of the gas by from 5 to 10 per cent. The average percentage composition of the "debenzolisied" gas from typical Durham and South Yorkshire coking coals is somewhat as follows :—

	CO ₂	CO	C _n H _m	CH ₄	H ₂	N ₂	Calorific Values per cub. ft. at 15° C. and 760 mm.
Durham	2.5	6.5	2.0	25.0	55.0	9.5	{ 484.6 gross 425.5 net
S. Yorks	2.4	5.6	2.0	26.4	54.6	9.1	{ 493.6 gross 434.2 net

Amount of Surplus Gas.—Assuming that with regenerative ovens the surplus "debenzolisied" gas per ton of coal carbonised amounts to 5000 cub. ft. the corresponding calorific values available for outside purposes would be 2,450,000 B.Th.U.s. (*gross*) and 2,150,000 B.Th.U.s (*net*) respectively.

With a battery of sixty such ovens carbonising 1680 tons of coal per week, the hourly yield of surplus "debenzolisied" gas would be 50,000 cub. ft., at 15° C. and 760 mm., and the corresponding calorific values would be 24,450,000 (*gross*) and 21,500,000 (*net*), or sufficient to generate in an internal combustion engine 2150 B.H.P. continuously day and night.

Taking the country as a whole, and assuming that the whole of the 20 million tons of coal now annually carbonised for metallurgical coke were dealt with in regenerative ovens, the *net* calorific value represented by the surplus gas available for outside purposes would be about 5000 million B.Th.U.s. per hour, day and night, throughout the whole year, or sufficient to generate about 500,000 B.H.P. continuously in internal combustion engines.

The most effective utilisation of such a huge surplus of energy is a matter of the highest importance to the nation, and there is no doubt but that a good deal of the coke-oven gas available from existing plants is not being used to the best advantage.

So far as the manufacture of coke for the heavy structural steel trade is concerned, it is now generally agreed that the best scheme would be to build the coke ovens always on the same site as the blast furnaces, steel works, and rolling mills, so that the surplus gas, together with that generated in the blast furnaces, could be wholly used for power and heating purposes

COAL AND ITS SCIENTIFIC USES

in connection with the steel works and rolling mills. This aspect of the question will be more fully dealt with in a subsequent chapter.

A large proportion of our by-product coking plants have, however, been erected either (a) at the collieries, away from the ironworks, or (b) adjacent to the blast furnaces, but away from the steel works and rolling mills. In such cases the surplus gas cannot as a rule be wholly utilised on the spot, and outside uses for it must be found.

Among the more obvious directions in which the surplus gases from such plants can be utilised to good advantage may be mentioned :—

(1) *For Steam Raising and Power Purposes.*—By burning the gases in the tubes of a Bonecourt Boiler, on the principle of "surface combustion," it is possible to transform 92 per cent. of the *net* heat of combustion into the energy of steam which can be either (a) converted into mechanical power by means of a steam turbine, or (b) used for evaporative purposes in connection with chemical operations. Or, power may be generated from the gases by means of large internal combustion engines, with a thermal efficiency of, say, from 20 to 25 per cent. (*i. e.* from *net* calorific value of the gas to B.H.P. at the engine). And by suitable combinations of either (c) boilers, turbines, and dynamos, or (d) gas engines and dynamos, electrical energy can be generated at a very low cost. Many collieries now generate from their surplus coke-oven gases (or waste heat) sufficient power to meet all the requirements of the mine. Others, again, sell their surplus gas (or waste heat) to a Power Company, who convert it into electric energy which is distributed for public consumption over a wide area, as in the North East Coast Power Scheme (*q.v.*).

If no Power Company or group of power users is at hand to purchase the surplus gas (or waste heat), it might with great advantage be utilised in an adjacent chemical factory. Indeed, there is no reason why the crude tars, benzols, and naphthalene produced on the coking plant should not be refined and transformed into other more finished products on the spot in the chemical factory, the heat and power from which shall be wholly derived from the surplus gases. Or, alternatively, any chemical operations requiring cheap electric current might very well be carried out in factories erected in close proximity to by-product coking plants.

(2) *As a Heating Gas for Industrial Establishments.*—From

THE CARBONISATION INDUSTRIES

what has been said in the preceding chapter about the increasing industrial uses of coal gas, it will be understood that in districts (such, for example, as the Sheffield area) where there are on the one hand a large number of coking plants, and on the other many industrial establishments needing large supplies of a high-grade heating gas, a scheme for connecting up the coke-oven plants with the works by means of high-pressure gas distribution mains is one worthy of consideration.

(3) *As a Domestic Lighting and Heating Supply.*—Coke-oven gas, after purification in the usual manner from sulphuretted hydrogen and cyanogen compounds, is already extensively used both in Germany and in America as a public supply for domestic consumption. And it is probable that in the near future its use in this country for this purpose will become much more prevalent than it is to-day, especially now that the incandescent mantle is so universally employed for indoor gas-lighting and that the former self-illuminating standards for towns gas supplies are being largely superseded by calorific standards. Indeed, in this connection it is perhaps significant that in some gas-works (e. g. Vienna and Birmingham) regenerative by-product coke ovens, fired by gas generated from either coal slack or coke breeze in outside "producers" under ammonia recovery conditions, have recently been installed in preference to even vertical retorts for the production of a combination of good coke, with satisfactory gas and yields of by-products. And there seems no reason why coke ovens should not be extensively fired with "producer gas" made from low-grade fuel, if suitable markets for all the high-grade coke-oven gas produced could be found.

In Germany a large number of towns in Rhineland and Westphalia are supplied with purified gas from the neighbouring coke ovens at prices which are said to be less than *9d.* per 1000 cub. ft. Also in the United States, the city of Boston, Mass., to mention one centre of population only, has since 1901 been supplied with purified gas from a battery of 100 Otto-Hofmann coke ovens installed at Everett, Mass., and owned by the Dominion Iron and Steel Company. The average yield of gas from these ovens is 10,390 cub. ft. per ton, of which 5143 cub. ft. are available for supplying the city of Boston.

In both Germany and America the plan has been adopted of reserving for town's supply the richer gas evolved during the eighteen hours immediately following the first two hours of the whole carbonisation period. For this purpose the hydraulic

COAL AND ITS SCIENTIFIC USES

main, and all the by-product recovery arrangements and connections on the plant are duplicated, so that the richer gas may be separately treated, purified, and sent out for public distribution, leaving the poorer gas made during the first two and the last twelve hours of the carbonising period to be retained for consumption in the heating flues of the ovens.

The first application of coke-oven gas for public lighting in England was made in 1910 when Parliament sanctioned the use of gas from the Brackley Coke Works to the Urban district of Little Hulton (near Bolton, Lancs.), under a guarantee of a minimum illuminating power of 14 standard sperm candles, when tested in a No. 2 Metropolitan Argand Burner, and a gross calorific power of 550 B.Th.U.s. per cub. ft. at 60° Fahr. and 30 in. pressure. Since that year, however, the Corporation of Middlesbrough has entered into an arrangement whereby the town now draws its entire supply of gas from a battery of Otto regenerative ovens situated at the neighbouring Newport Ironworks of Sir B. Samuelson and Co., Ltd. Also the city of Leeds now takes part of its supply from the Simon-Carvés ovens of the Middleton Estate and Colliery Co., Ltd., and, as already stated, the City of Birmingham Gas Committee has installed a battery of sixty-six Koppers Regenerative Ovens, fired by Mond gas, at their Saltley Works for the production of towns gas and furnace coke.

CHAPTER XVII

THE COMPLETE GASIFICATION OF COAL

PRODUCER GAS AND AMMONIA RECOVERY

INTRODUCTION. THE CHEMISTRY OF THE PROCESS.

FOR the rapid production of gaseous fuel for large furnace operations, as well as, in some cases also, for power purposes, no cheaper process has yet been discovered than the complete gasification of bituminous coal, coke, or anthracite by means of a mixed air-steam blast (sometimes air alone is employed) in some form of "gas-producer," whereby the fuel may be converted into a mixture of oxides of carbon, hydrogen, methane, and nitrogen containing between 40 and 45 per cent. of combustible constituents. Moreover, by pre-heating the air-blast and adding to it a proportion of steam corresponding to saturation at 85° C., nearly two-thirds of the nitrogen in the fuel may be obtained as ammonia, which may then be recovered as ammonium sulphate, a circumstance which greatly enhances the economy of the process, making it one of the most scientific ways of utilising coal.

A modern gas-producer consists of a cylindrical furnace (6 to 12 ft. internal diameter and 10 to 15 ft. high), lined with firebrick, with an outer mild steel casing, and usually water-sealed at the bottom. Means are provided (1) for the introduction of the blast through some form of grate or tuyère fixed immediately above the level of the water in the seal, and its regular distribution through the bed of incandescent fuel (usually 3 to 5 ft. in thickness) which rests upon a lower bed of ashes; and (2) for the charging in of the raw fuel through some form of bell hopper fixed centrally on the top of the producer, round which are arranged a number of equidistant poking holes closed by iron balls. The gas outlet is fixed near the top of the cylindrical furnace.

Taking as a typical example the case of a producer of 10 ft. internal diameter, gasifying some 10 cwt. of bituminous coal

COAL AND ITS SCIENTIFIC USES

per hour, with a bed of fuel 3 ft. in effective depth, the chemistry of gasification may be epitomised as follows—

When a fresh charge of coal is dropped into the producer, it first of all undergoes, in the uppermost layers of the fire, a process of destructive distillation, whereby hydrogen, methane, tarry hydrocarbons, oxides of carbon, together with some steam and also small quantities of ammonia and sulphuretted hydrogen, are evolved, probably in much the same proportions as in the high temperature distillation of coal. It seems likely that nearly the whole of the 3 per cent., or thereabouts, of methane usually found in producer gas originates in this way. Olefines and higher paraffins are, however, so rapidly decomposed that they rarely, if ever, appear in the gas passing out of the producer.

The carbonaceous residue (coke) containing, as it does, the whole of the ash and four-fifths of the nitrogen originally present in the coal, is rapidly gasified as it descends through the incandescent fuel bed by the upward flowing air-steam blast, yielding chiefly the oxides of carbon and hydrogen, together with further small quantities of both methane and ammonia.

The blast on entering the bottom layers of the fuel bed almost immediately loses the whole of its free oxygen, and the gases withdrawn from this region invariably contain a considerable proportion of carbon dioxide. This latter, together with the steam in the blast, rapidly attacks the incandescent carbon in the middle portion of the fuel bed, so that if the fuel be of sufficient porosity, and the requisite high temperature be maintained, the gases as they pass into the uppermost layer of "distillation" should consist principally of carbon monoxide, hydrogen, and nitrogen, with only a small proportion of carbon dioxide, or of undecomposed steam. These gases, mingling with the distillation products, make up the crude "producer gas," which passes out of the furnace.

In order to understand better the chemistry of the process, it is necessary to consider separately the well-known interactions between incandescent carbon and air or steam, respectively. For these reactions, occurring simultaneously, are responsible for the gasification of the whole of the carbonaceous residue (coke) in the middle and lower regions of the fire.

A. The Action of Air upon Incandescent Carbon.—In a solid bottom producer operated with a *dry* air blast, the initial action of the oxygen upon the incandescent carbon, which may be supposed to give rise initially to the transient formation of a physico-

THE COMPLETE GASIFICATION OF COAL

chemical complex C_xO_y (*vide* Rhead and Wheeler, Chap. X, p. 171), is rapidly succeeded by the reversible reaction—

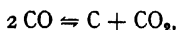

in which the state of dynamic equilibrium is a function of both temperature and of the partial pressures of the CO and CO_2 , in accordance with the Le Chatelier thermodynamical equation already considered in Chap. X (*q.v.*). It has also been demonstrated that the time required for the establishment of the equilibrium at the temperatures prevailing in the fuel bed of such a producer (1200° to 1500° C.) is far shorter than the time occupied by the reacting gaseous mixture in traversing the same.

Moreover, from Rhead and Wheeler's experimental researches (*q.v.*), as well as from the aforesaid equation, it is evident that at such high temperatures the percentage of carbon dioxide remaining when equilibrium is established must be very small; so small, indeed, that for all practical purposes the conversion of the "carbon residue" into the monoxide may be regarded as complete, although, theoretically, in no circumstances can the dioxide be entirely absent.

Hence, provided that the temperature in the lower regions of the fuel bed exceeds 1200° C., the principal action of the air blast upon the incandescent carbon may be considered to involve the almost instantaneous formation of carbon monoxide, and the liberation of as nearly as possible 30 per cent. of the total potential energy of the coke, thus—



KARL WENDT'S EXPERIMENTS WITH AN AIR-BLOWN PRODUCER

The nature and sequence of the chemical reactions in a coal-fed air-blown producer are clearly demonstrated by experiments carried out in Germany by Karl Wendt on a dry bottom producer charged intermittently with a suitable bituminous coal, and blown by an air blast without any addition of steam. The fuel bed, which rested upon an ordinary bar grate, had a total depth of 7 ft. 6 in., and in order to ascertain the temperature and composition of the gases at various levels in it, a series of seven holes were drilled through the walls of the producer at regular intervals of 10 in. along a vertical line commencing on a level with the blast pipe. The results showed that not only

COAL AND ITS SCIENTIFIC USES

did the whole of the oxygen in the blast almost instantly disappear, but that equilibrium in the system

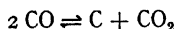

was practically established before the ascending gases had traversed the lowest 10 in. of the fuel bed.

TABLE LXXI

RESULTS OF KARL WENDT'S EXPERIMENTS WITH AN AIR-BLOWN PRODUCER

	Height above Tuyères. Inches.	Temp. °C.	Percentage Composition of the Gas.				
			CO ₂ .	CO.	CH ₄ .	H ₂ .	N ₂ .
Rapid Gasification of the Coke by Blast and attainment of equilibrium in the System $2\text{CO} \rightleftharpoons \text{C} + \text{CO}_2$	0	—	15.0	9.7	nil	nil	75.3
	10	1400°	0.2	34.1	nil	nil	65.7
	20	—	0.2	34.3	nil	nil	65.5
	30	1250°	nil	34.5	nil	0.4	65.1
Distillation of the Coal	40	1030°	0.4	33.4	0.3	2.4	63.5
	50	—	0.6	30.0	0.6	11.7	57.1
	60	—	1.0	28.9	2.0	9.8	58.3
Gas Outlet		580°	0.7	31.3	2.4	6.3	59.3

From the foregoing it would appear possible to gasify a fuel such as coke, the combustible part of which is essentially carbon, with a dry air blast, so as to produce a gas of the composition—

• CO₂ = 0.2, CO = 34.3, N₂, etc. = 65.5 per cent.,

provided that the temperature in the fuel bed were maintained at about 1300° to 1400° C. The chief practical difficulty would arise out of the fusibility of the ash, which in most cases would cause serious clinkering troubles. These might, however, be overcome by the addition of an amount of lime-stone to the fuel charge sufficient to form a fusible slag with the ash. This procedure was, as a matter of fact, adopted by Ebelmen in the first "gas producer" erected by him at Audincourt in October 1840; the gas obtained, from wood charcoal and coke respectively, having the following percentage composition—

	CO ₂ .	CO.	H ₂ .	N ₂ .
• Wood charcoal	0.50	33.30	2.80	63.40
• Coke	0.83	33.53	1.48	64.16

THE COMPLETE GASIFICATION OF COAL

Some years ago the same idea was carried out in the **Thwaite Cupola Producer**, which is still in use in some works in the United Kingdom. This producer is of the blast-furnace type, 30 ft. in height, with internal diameter 6 ft. The blast is introduced through a series of tuyères placed horizontally a little above the hearth, and a slag-notch is provided for running off the molten slag formed by the fluxing of the ash of the fuel with the limestone added to the charge. The rate of gasification is rapid, and the gas is of uniform composition and rich in carbonic oxide; moreover, owing to the great height of the producer, it leaves at a comparatively low temperature. Typical analyses of the gas produced from a Lancashire raw slack coal are as follows—

	CO ₂ .	CO.	H ₂ .	CH ₄ .	N ₂ , etc.
(i)	2·25	28·85	5·80	1·95	61·15
(ii)	1·80	29·20	4·90	2·15	61·95
Average	2·0	29·0	5·35	2·05	61·6

Total combustibles = 36·4 per cent.

Mean calorific value per cub. {Gross 138·7}
feet at 0° C. and 760 mm. {Net 130·8} B.Th.U.s.

The objection to such a procedure as the above, apart from the necessity of adding limestone to the charge when dealing with clinkering fuels, as well as from the great wear of the lining of the producer, lies in the fact that the gasification of coke or charcoal by means of a dry air blast means the conversion of at least 30 per cent. of the potential energy of the fuel into sensible heat, which in many cases would be dissipated by radiation before the resulting gas reaches the place where it is to be utilised.

B. The Action of Steam upon Incandescent Carbon.—The best possible way of utilising the heat necessarily generated by the exothermic action of the air-blast upon the incandescent carbon in the producer is to immediately re-absorb it by effecting the endothermic interaction of steam and carbon, thereby increasing the potential energy of the resulting gas at the expense of some of its sensible heat.

The composition of the gas obtained when steam reacts with solid carbon depends chiefly upon the temperature, assuming that the fuel be of sufficient porosity and depth. At comparatively

COAL AND ITS SCIENTIFIC USES

low temperatures (500° to 600° C.) the chief products are carbon dioxide and hydrogen, in accordance with the equation,—



whereas, at temperatures of 1000° C. and upwards, the main result is the production of equal volumes of carbon monoxide and hydrogen (the so-called "water gas" reaction), according to the equation,—



At temperatures intermediate between 600° and 1000° C., the products correspond to the simultaneous occurrence of both reactions, the second gradually asserting itself as the temperature rises, until, at 1000° C., it almost entirely supersedes the first.

Both reactions are strongly endothermic, the first representing the absorption of 19·0, and the second of 29·0 K.C.Us. per gramme-atom of carbon gasified. Hence it is that when steam is added to the air-blast of a producer the *exothermic* effect of the carbon-oxygen combustion is partly counteracted by the *endothermic* carbon-steam reaction. The resulting gas is thereby enriched, its hydrogen content notably increased; and more of the potential energy of the original fuel is transferred to the furnace in the form of gas.

The function of the steam in a gas-producer is, therefore, to absorb part of the heat liberated during the partial "air combustion" of the carbon by doing chemical work, thereby raising the potential energy of the resulting gas at the expense of some of its sensible heat. Incidentally, also, clinkering trouble with a fusible ash is greatly diminished by the admixture of steam in the blast.

C. The Influence of the Reversible System $CO + OH_2 \rightleftharpoons CO_2 + H_2$.—The composition of the resulting gas is appreciably affected by the mutual interactions between (a) carbon monoxide and steam, on the one hand, and (b) carbon dioxide and hydrogen on the other, which at all temperatures above 500° C. constitute an active reversible cycle,—



In accordance with the laws of mass-action, the system must ultimately attain a state of dynamic equilibrium, which may be

THE COMPLETE GASIFICATION OF COAL

defined in terms of the relative concentrations of the reacting gases and the absolute temperature. Thus we may write—

$$\frac{\text{CO} \times \text{OH}_2}{\text{CO}_2 \times \text{H}_2} = K$$

where K is a constant (the "equilibrium constant"), the numerical value of which depends upon the temperature.¹

On thermodynamical grounds it may be predicted that the value of K will increase with the temperature, since the equilibrium in a reversible system must shift with rising temperature in the direction of negative heat change. This conclusion has been verified by Oscar Hahn in his determinations of the values of "K" for the above system at various temperatures between 786° and 1405° C., as follows²—

Temp. °C.	K.	Temp. °C.	K.
786° . . .	0.81 . . .	1086° . . .	1.95 . . .
886° . . .	1.19 . . .	1205° . . .	2.10 . . .
986° . . .	1.54 . . .	1405° . . .	2.49 . . .

As shown some years ago by the author, in conjunction with Dr. R. V. Wheeler, this reversible system also comes into play, and may profoundly affect its composition, when "producer gas" passes through the hot regenerators of an open-hearth furnace. For a full discussion of this point the reader is, however, referred to the original memoir.³ Suffice it here to say that, in generating a gas for furnace purposes, care should be taken not only that the gas *as it leaves the producer* shall have a given desired composition, but also that it shall be in a hygroscopic condition conformable with the said composition remaining unaltered as the gas passes through the furnace regenerators, where its temperature may be raised to as high a point as 1200° C.

KARL WENDT'S EXPERIMENTS WITH AN AIR-STEAM-BLOWN PRODUCER

The influence of the addition of steam to the blast upon the temperature distribution, and the chemical interchanges taking

¹ Since the movement in either direction in the system is unattended by any "volume" change, variations in pressure only at a given temperature would be without influence upon the value of K.

² *Zeit. für Physik. Chemie*, 1903, 43, p. 705, and 44, p. 513.

³ *Journ. Iron and Steel Institute*, 1908; also *Journ. West of Scotland Iron and Steel Institute*, 1911.

COAL AND ITS SCIENTIFIC USES

place in the incandescent fuel, is well brought out by the results of another experiment carried out by Karl Wendt upon the same fuel and with the same producer as was referred to earlier in the chapter. In this further experiment, live steam was added to the blast until the latter was saturated at about 60° C. Observations were then made of the composition of the gas and the temperatures at different levels of the fuel bed, which, as in the first experiment, was 7 ft. 6 in. in depth, as follows—

TABLE LXXII
RESULTS OF KARL WENDT'S EXPERIMENTS WITH AN AIR-STEAM-BLOWN PRODUCER

	Height above Tuyères. Inches.	Temp. °C.	Percentage Composition of Gas.					
			CO ₂ .	CO.	CH ₄ .	H ₂ .	N ₂ .	O ₂ .
Interaction of Air and Steam with Incandescent Coke.	0	—	11·4	nil	nil	nil	79·1	9·5
	10	1110°	9·3	22·0	0·4	10·6	57·7	nil
	20	—	5·5	28·0	0·9	13·7	51·9	nil
Distillation of the Coal	30	925°	3·0	32·7	1·2	17·9	45·2	nil
	40	—	5·0	28·7	5·0	21·8	39·5	nil
	50	810°	6·0	28·3	4·8	20·7	40·2	nil
	60	—	5·3	28·0	4·1	19·0	43·6	nil
	Gas Outlet	440°	5·5	26·8	3·4	14·6	49·7	nil

Comparing these results with those obtained in the first experiment, where a dry-air blast was used (*vide* Table LXXI) we find, in the first place, that the temperatures at corresponding levels in the fuel bed were considerably lowered by the use of steam; thus we find—

Height above Tuyères.	Dry-Air Blast.	Air-Steam Blast.
10" ..	1400° ..	1110°
30" ..	1250° ..	925°
50" ..	1030° ..	810°
<hr/> Gas Outlet	<hr/> 580°	<hr/> 440°

in the second place, owing to this temperature reduction, the

THE COMPLETE GASIFICATION OF COAL

gases at corresponding levels when steam was used (except just where the blast entered) contained much more carbon dioxide and less carbon monoxide than when the blast was dry, although the deficiency in carbon monoxide was outbalanced by an increase in the hydrogen, as might be expected. Thirdly, and probably also in consequence of the general lowering of the temperature, the zone of distillation extended further downwards in the fuel bed when steam was used than with dry blast.

BONE AND WHEELER'S INVESTIGATIONS ON THE USE OF STEAM IN GAS-PRODUCER PRACTICE

The influence of successive additions of steam to the blast of a gas-producer upon the general character and efficiency of the gasification process was thoroughly investigated on a large scale some years ago by Dr. R. V. Wheeler and the author, with results which were embodied in two papers read before the Iron and Steel Institute.¹

The plant placed at our disposal for the investigation was situated at the Iron and Steel Works of Messrs. Monks, Hall & Co., Ltd., Warrington, and was of a slightly modified Mond type, with arrangements for superheating the blast and saturating it with steam at any desired temperature. It comprised two producers, each 10 ft. internal diameter (rated capacity = 16 cwt. of coal per hour), with the usual "superheaters" (*vide* Mond System) connected with a condensing system in which the gas was suitably cooled and scrubbed for subsequent consumption in (1) two engines, one of 650 H.P. driving a 10-inch bar rolling-mill, and the other of 250 H.P. generating electricity; and (2) gas-fired puddling, swarfe, and re-heating furnaces.

The plant was operated day and night continuously throughout each working week of between 112 and 136 hours, but, owing to the fact that the rolling-mill worked during the day-shifts only, the average rate of gasification during the 12 hours day-time (about 23.5 cwt. of coal per hour) was nearly double that during the 12 hours night-shift (10.8 to 13 cwt. per hour). The fuel used throughout the investigation was washed nuts from the Florida Seam of the Collins Green and Bold Collieries near Earls-town, Lancashire. It had been previously screened over a one-inch linear mesh, and as charged into the producer it contained

¹ *Journ. Iron and Steel Institute*, 1907, i, p. 126; 1908, ii, p. 206.

COAL AND ITS SCIENTIFIC USES

anything between 3 and 7 per cent. of moisture. The dry coal contained on the average—

	Per cent.	
Carbon . . .	78.0	} Volatiles at 900° C. = 36.0 per cent.
Hydrogen . . .	5.4	
Nitrogen . . .	1.4	
Sulphur . . .	1.0	
Oxygen . . .	10.0	} Calorific Value { 13,900 gross B.Th.U.s. per lb. { 13,375 net.
Ash . . .	4.2	
100.0		

The investigation comprised altogether ten trials, each (with one exception) extending over a full working week, in which the blast-steam saturation temperature was either raised or lowered, week by week in each successive trial, by regular stages of 5° C. between 45° and 80° C. During each week's run, therefore, this saturation temperature was kept quite constant, but during the interval between two successive trials it was either raised or lowered by 5° C.

In one series of trials (which in point of time happened to be the second) the whole load was put on one of the two producers only, which was worked throughout with a bed of incandescent fuel 3 ft. 6 in. deep. The producer gasified the fuel during the day-time at 1.47, and during the night-time at 0.85, times its rated normal capacity. The blast-steam saturation temperature, beginning at 60°, was between each successive trial lowered by 5° until it finally fell to 45° C. At this last-named temperature, however, the fire bars got so hot that the trial had to be suspended after 60 hours' duration, it being clear that the lowest limit of practical working had been reached.

In the other (chronologically, however, the first) series, both of the producers, each with a bed of incandescent fuel 7 ft. deep, were used for substantially the same load. This meant that, in comparison with the former series, a fire twice as deep was blown at only half the blast speed, and therefore that the actual time of contact between the ascending gases and the incandescent fuel would be about four times as long. The blast-steam saturation temperature, beginning at 60°, was raised between each successive trial by increments of 5° C. up to 80° C. Determinations of the ammonia yields at different blast saturation temperatures were made. A comparison between the results obtained

THE COMPLETE GASIFICATION OF COAL

TABLE LXXIII
RESULTS OF BONE AND WHEELER'S GAS-PRODUCER TRIALS

Average Depth of Incandescent Fuel.	3 Feet 6 Inches.										7 Feet.			
	22.5 Cwt.										11.5 Cwt.			
	1	2	3	4	5	6	7	8	9	10				
No. of Trial	45°	50°	55°	60°	70°	60°	65°	70°	75°	80°				
Steam Saturation Temperature of Blast	2:35	2:50	4:40	5:10	9:25	5:25	6:05	9:15	11:05	13:25				
Carbon Dioxide	31:00	30:00	28:10	27:30	20:35	27:30	25:40	21:70	18:35	16:05				
Carbon Monoxide	11:00	12:35	15:45	15:50	19:75	16:60	18:30	19:65	21:80	22:05				
Hydrogen	3:00	3:00	3:00	3:05	3:45	3:35	3:40	3:40	3:35	3:50				
Methane	51:40	51:55	49:05	49:05	46:70	47:50	45:95	46:10	44:85	44:55				
Nitrogen	46:25	45:95	46:55	45:85	44:05	47:25	47:10	44:75	43:50	42:20				
Total Combustibles	180:0	178:5	180:8	178:7	175:5	185:6	185:4	177:5	172:0	169:5				
Calorific Value of the Gas, B. Th. Us.) Gross	170:5	168:7	169:1	166:9	161:0	173:0	172:0	163:3	157:3	154:3				
per cub. ft. at 0° C. and 760 m.m.) Net	133:700	132:500	132:700	135:000	—	138:250	134:400	141:450	145:800	147:500				
Yield of Gas, cub. ft. at 0° C. and 760 m.m. per ton of Coal.	0:2	0:21	0:32	0:45	—	0:45	0:55	0:80	1:10	1:55				
Steam added to Blast, lbs. per lb. Coal	All	All	All	76:0	—	87:0	80:0	61:0	52:0	40:0				
Percentage Steam Decomposed	All	All	All	76:0	—	87:0	80:0	61:0	52:0	40:0				

COAL AND ITS SCIENTIFIC USES

in the trials with a blast-steam saturation temperature of 60° C. in each series showed how very little the quality of the gas was affected by the great difference between them in regard to the rate of gasification.

The general results are reproduced in Table LXXIII.

Whilst the reader must study all the results detailed in the original memoirs, in order to understand the wide range covered by the investigation, and its many-sided applications to current gas-producer practice, its main conclusions may be summarised as follows—

(1) That with an ordinary bituminous producer coal, such as is usually employed in the North of England, some 92.25 per cent. of the total carbon in the fuel is converted into permanent gas (*i. e.* into oxides of carbon and methane). Another 6.5 per cent. leaves the producer either as dense tarry hydrocarbons, or as soot, and the remaining 1.25 per cent. is lost in the ashes. These proportions are independent of the steam saturation temperature.

(2) That with steam saturation temperatures of blast up to and including 55° C., the whole of the steam introduced may be decomposed in passing through the incandescent fuel bed, the depth of which need not exceed 3 ft. 6 in. above the grate or blast dome. As the blast saturation temperature is gradually raised beyond the limit of 55° C. a decreasing proportion of the steam introduced is decomposed, although the absolute amount decomposed may increase; this is shown in the following table—

Steam Saturation Temp. of Blast. ° C.	Lbs. of Steam in Blast per lb. of Coal Gasified.	Per cent. Steam Decomposed approx.	Lbs. of Steam Decomposed.
45°	0.20	100	0.20
50°	0.21		0.21
55°	0.32		0.32
60°	0.45	80	0.36
65°	0.55		0.44
70°	0.80	60	0.48
75°	1.10	50	0.55
80°	1.55	40	0.62

(3) That, in accordance with thermodynamical requirements, successive increments in the proportions of steam introduced in the blast, by reason of their increasing cooling effects upon the

THE COMPLETE GASIFICATION OF COAL

fuel bed, profoundly affect the course of the reactions occurring therein, and consequently also the composition of the resulting gas. For the lower the temperatures throughout the fuel bed, the more will the interaction $C + 2OH_2 = CO_2 + 2H_2$ displace the $C + OH_2 = CO + H_2$ change, and the more also will the equilibrium in the two reversible systems $2CO \rightleftharpoons C + CO_2$ and $CO + OH_2 \rightleftharpoons CO_2 + H_2$ shift towards the right hand. These combined effects were strikingly reflected (a) in the marked decrease in the CO-content, and (b) in the corresponding increases in both the CO_2 - and the H_2 -contents of the resulting gas as the blast-steam saturation temperature was progressively raised during the trials. There was, however, no material change in the production of methane, which as a distillation product would only be slightly (if at all) affected by a lowering of the temperature.

(4) That the best "furnace" gas is obtained with a blast-steam saturation temperature of about $50^\circ C$. Lowering the steam saturation temperature below this limit had a detrimental influence upon the general working conditions, without any compensating improvement in the quality of the gas, whilst on raising the saturation temperature beyond 50° , the quality of the gas, from the furnace standpoint, at first gradually, and afterwards rapidly, deteriorated, owing to the increasing production of hydrogen at the expense of the more effective carbon monoxide. Moreover, what is of great importance, the proportions of carbon dioxide, carbon monoxide, hydrogen, and steam in the gas generated with a steam saturation temperature of $50^\circ C$. will correspond to those in equilibrium at $1200^\circ C$., provided that the dew point of the gas leaving the producer is about $20^\circ C$., which will be the case unless the fuel charged into the producer is very wet. Hence the gas as generated under such conditions will not alter in composition during its passage through the furnace regenerators.

(5) That the ratio of the net calorific value of the cold gas obtained to that of the coal gasified did not vary very much with the blast-steam saturation temperature throughout the investigation. For if the result of Trial No. 6 in Table LXXIII (where there was reason to suppose that the yield of gas per ton of coal had probably been overestimated by about 2 per cent.) be neglected in this connection, the particular ratio in question worked out between the limits of 0.744 and 0.773 in all other cases, with a mean value of 0.76. On the other hand, however, if the thermal value of the steam added to the blast be brought into account,

COAL AND ITS SCIENTIFIC USES

it would appear that the thermal efficiency of the gasification process would not be appreciably affected thereby up to a saturation temperature of 60° C., after which limit, however, there would be a steady falling off. Hence it would seem that the conditions under which the best furnace gas is generated are compatible with the maximum thermal efficiency, which probably is reached with a blast saturation temperature within the range 45° to 55° C.¹

(6) That, as might be expected from theoretical considerations, the yield of ammonia rapidly increases with steam saturation temperatures, as the following figures show—

Steam Saturation Temperatures ° C.	60°	65°	70°	75°	80°
Ammonia as lbs. sulphate per ton of dry coal gasified	39·0	44·7	51·4	65·25	71·8
Proportion of N in the coal evolved as NH ₃	0·265	0·304	0·35	0·444	0·49

(7) That, given a suitable construction of grate and blast arrangements, a very high rate of gasification—exceeding 20 cwt. of dry coal per hour per producer of 10 ft. internal diameter (or, say, about 30 lbs. per hour per square foot of fire area)—can be continuously maintained, night and day, without detriment either to the quality of the gas or to the general working conditions. Moreover, it is quite possible to vary the load within very wide limits without appreciably altering the quality of the gas or impairing the efficiency of the process. A producer which, with a suitable quality of coal (*i. e.* not strongly caking or clinker-ing), will not permit of such rapid gasification, or variation in load, without impairing the quality of gas, must be regarded as, in some way, structurally defective.

GAS FOR FURNACE PURPOSES

In gas generated for use in furnaces, and particularly of the open-hearth type as used in connection with the manufacture of glass and steel, it is desirable that the CO-content should be

¹ This conclusion was supported in a subsequent paper by J. Voight (*Z. Angew. Chem.*, 22, p. 1539), who argued that the maximum thermal efficiency is attained when the blast contains 80 grams of steam per cubic metre. Seeing that the air used in a producer working on a bituminous coal amounts to as nearly as possible 40 cub. ft. (at 15° C. and 760 m.m.) per lb. of fuel charged, Voight's recommendation would correspond to a steam saturation temperature of between 45° and 50° C.

THE COMPLETE GASIFICATION OF COAL

as high as possible, and that the proportion of hydrogen present should not exceed 12 or 14 per cent. Steel works managers find from practical experience that the most suitable gas for a melting furnace is one containing between 10 and 12 per cent. of hydrogen, and with as high a percentage of carbon monoxide as possible, and the author has found similar views prevalent among glass-makers. Probably the facts that (1) the radiation from a CO-flame is 2.4 times that from a hydrogen flame of like dimensions (*vide* Chap. XIV); and (2) that the rates of back-firing of CO-air mixtures are much less than those of the corresponding H₂-air mixtures, have a considerable influence upon the furnace results, and account, at least in some measure, for the supposed greater efficiency of carbon monoxide as compared with hydrogen.

Moreover, for a regenerative furnace supply, the gas leaving the producer should not only contain a high percentage of carbonic oxide, but should also be in a hygroscopic condition such that the proportions of CO₂, CO, H₂, and H₂O in it shall substantially conform to their equilibrium ratio at the highest temperature in the regenerator (say 1200° C.), as expressed by the equation—

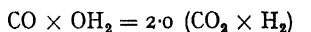

These requirements would be fulfilled by gasifying a suitable bituminous coal with an air-blast saturated with steam at a temperature of 50° C., so that it leaves the producer plant in a hygroscopic condition corresponding to saturation at 20° C. The composition of the (dry) gas so produced would be approximately—

$$\begin{aligned} \text{CO}_2 &= 2.5, \text{ CO} = 30.0, \text{ H}_2 = 12.0, \text{ CH}_4 = 3.0, \\ &\text{and N}_2 = 52.5 \text{ per cent.} \end{aligned}$$

SELECTION OF FUEL

The best "gas-producer" coals are the non-caking or only weakly caking classes yielding (as a rule) 34 to 40 per cent. of volatile matter at 900° C., such as are found in Scotland, Northumberland, Derbyshire, Nottinghamshire, and Staffordshire. A strongly caking coal should, if possible, be avoided, and also one with a large percentage of a very fusible ash.

Anthracites and anthracitic coals, with a low ash content, are often used for small "power" plants, because they yield an almost tar-free gas, and occasion no clinkering troubles. Coke

COAL AND ITS SCIENTIFIC USES

is also a good fuel, although the gas from it contains not much more than 0.5 per cent. instead of the usual 3.0 per cent. of methane, and is therefore of lower calorific value than that from a bituminous coal.

It seems possible that, in connection with future power-gas developments, the fuel charged into the producer will be coal which has been subjected to some preliminary distillation for the recovery of tars and light oils, and that the residue will then be gasified under ammonia recovery conditions, but this is a matter which needs much further exploration.

GAS FOR POWER PURPOSES

In regard to gas generated primarily for power purposes, its actual composition is not so important as when it is required for large furnaces, provided, of course, that the total content of combustible constituents is high. Indeed, in the case of a large power-gas installation, the ruling consideration should be the recovery of ammonia, in which case a large proportion of steam must be mixed with the air-blast, and the resulting gas will have a composition somewhat as follows—

$$\begin{aligned} \text{CO}_2 &= 16.0, \text{CO} = 12.0, \text{H}_2 = 24.0, \text{CH}_4 = 3.0, \\ &\text{and N}_2 = 45.0 \text{ per cent.} \end{aligned}$$

A gas supply for internal combustion engines must be thoroughly cleaned from both dust and tarry vapours, and also be cooled down to the atmospheric temperature, before delivery to the engine.

The possibilities opened up by recent improvements in gas-producer design, in conjunction with boilers working on the Bonecourt surface-combustion principle and turbines, have now made it possible to generate steam power economically from low-grade fuels *via* an ammonia recovery gas plant, and some installations on these lines are already in successful operation.

GAS-PRODUCER DESIGN

The main points to be considered in relation to the gas-producer design are: (1) the easy and accurate control of the blast-steam saturation temperature; (2) a suitable form of grate or tuyère which should permit of a rapid rate of gasification, together with uniform distribution of the blast through the fuel bed; (3) the

THE COMPLETE GASIFICATION OF COAL

contour of the furnace body; and (4) the arrangements for charging the producer and removal of the ashes.

Historical.—One of the earliest forms of gas-producers (Ebelmen, 1840) was of the cupola type, in which charcoal or coke was gasified, with a positive blast introduced through tuyères, limestone being added (if necessary) to the charge to flux the ash. In 1845 Ekman, a Swedish ironmaster, designed a furnace and producer combined, for which the fuel was charcoal. The producer itself consisted of a cylindrical firebrick chamber, enclosed in an iron casing, a space being left between the brickwork and the casing through which the air supply was admitted and preheated on its way to the fire.

In 1861 the Brothers Siemens patented their well-known producer,¹ consisting of a firebrick chamber, rectangular in section, the front of which was inclined at an angle of from 45° to 60°, provided with a grate at the bottom, through which a current of air was induced. Below the grate was a trough of water, which, on evaporation by heat radiated from the grate, added a certain proportion of steam to the induced air supply. Subsequently the front of the producer was closed by an iron door, and the air supply forced in under the grate by steam injection. This producer was the first to gasify successfully bituminous coals; it was capable of generating a fairly good quality of gas, but its rate of gasification was low.

In 1876 Messrs. Brooke and Wilson patented a producer consisting of a cylindrical chamber having a solid hearth but no fire bars. The mixed air-steam blast was obtained by steam injection, and was introduced into the fuel bed by means of a box-shaped casting which traversed the middle of the hearth. In 1882 Mr. Wilson patented another form of generator in which the ash and clinker were automatically removed by means of two worm screws revolving in a water seal. Water-sealed producers have now almost entirely superseded the older solid or bar-bottom types.

About the same period (1879-81) Mr. J. E. Dowson succeeded in devising a practical apparatus for generating, cleaning, and cooling producer gas with the object of applying it for small scale-heating (including domestic) operations where taps and burners are used, and also for driving gas engines. In the original Dowson Plant a bed of incandescent fuel (small anthracite) was blown, in a cylindrical generator, by a jet of high-pressure

¹ For use in connection with their new regenerative furnace.

COAL AND ITS SCIENTIFIC USES

superheated steam, which, acting as an injector, induced the requisite mixed air-steam blast to make the gasification continuous. The hot gas was washed, cooled, and scrubbed free from tar by an ingenious arrangement consisting of a cylindrical scrubber placed inside the tank of the gas-holder, which acted automatically as a governor to the system. The scrubber was divided into two sections by a vertical partition down the middle. One half was fitted with water sprays and acted as a wet scrubber, the other half was dry, and the gas had to pass up the one and then down through the other. The resulting "Dowson Gas" had approximately the following composition—

$$\begin{aligned} \text{CO}_2 &= 6.55, \text{CO} = 25.10, \text{C}_2\text{H}_4 = 0.30,^1 \text{CH}_4 = 0.30, \\ \text{H}_2 &= 18.75, \text{N}_2 = 49.0 \text{ per cent.} \end{aligned}$$

The first trial of a gas engine with producer gas was made by Dowson in 1879 with a small Otto engine developing 3 B.H.P., and subsequently he read a paper on the subject of the possibilities of applying the gas for power purposes before the York Meeting of the British Association in the year 1881. These experiments, together with the Wilson inventions, may be regarded as completing the pioneering stage of gas-producer design and practice. Plate VII shows a modern 800 H.P. Power Plant for Bituminous Coal.

MODERN DESIGNS

(1) **The Duff Producer** (Fig. 50) may be cited as a modern producer of simple design. It consists of a cylindrical chamber, A, 7 to 10 ft. internal diameter, with a 9-inch firebrick lining within an outer steel shell. At the bottom of the lining is a circular angle-iron casting, which dips into the water seal in the trough, BB. The "Duff" grate, or blast grid, C, is a \wedge -shaped structure, with transverse grids, extending as a ridge across the producer immediately above the water seal. The air-steam blast enters the space beneath the grate, and the grid ensures its uniform distribution over a considerable area of the fuel bed. The latter (which as a rule extends to a height of about 3 ft. above the apex of the grate) is supported upon a bed of ashes, which extends downwards from the grate level into the water trough. In the lower part of the shell of the producer, and on a level with the grate, are inserted cleaning doors, DD. The fuel is charged intermittently into the furnaces through the belled hopper, E.

¹ The author, however, doubts whether even the small quantity of ethylene was present.

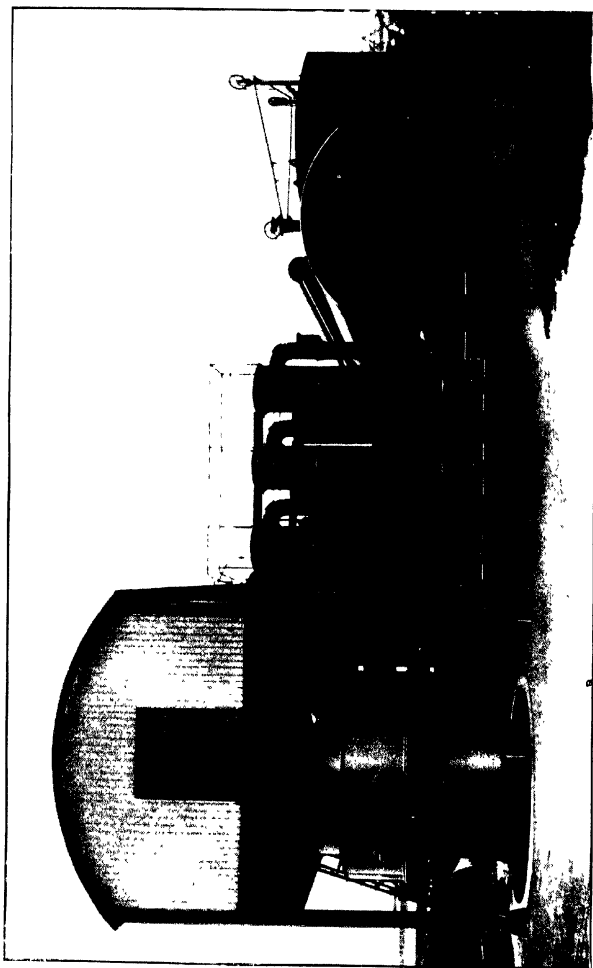
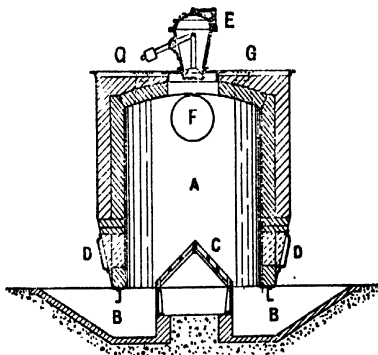

PLATE VII.—Dowson 800 B H.P. Power Plant for Bituminous Coal.

THE COMPLETE GASIFICATION OF COAL

and the gas outlet is at F. The dotted lines at GG indicate poking holes. Ashes are withdrawn from the water trough at regular intervals in quantity corresponding to the rate of accumulation in the furnace. A producer of 10 ft. internal diameter will gasify 10 cwts. of coal per hour, or about 15 lbs. per sq. ft. of fire area.



SECTION THROUGH WATER SEAL.

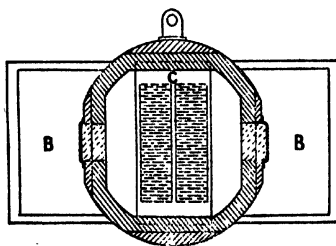

FIG. 50.—The Duff Producer.

(2) **The Mond Producer** (Fig. 51) shows the latest form of this well-known producer, which, although designed with special reference to ammonia-recovery practice, is eminently adapted to all working conditions. The chief features about it are: (1) the annulus, A, between the inner firebrick lining and outer steel shell through which the incoming preheated air-steam blast passes before reaching the grate; (2) the hanging bar grate, B, which takes the shape of an inverted truncated cone, with spaces between the bars for the admission of the blast, an

COAL AND ITS SCIENTIFIC USES

arrangement which ensures an adequate grate area and a very uniform and effective distribution of the blast in the fuel bed; and (3) the large bell, C, at the top of the producer below the

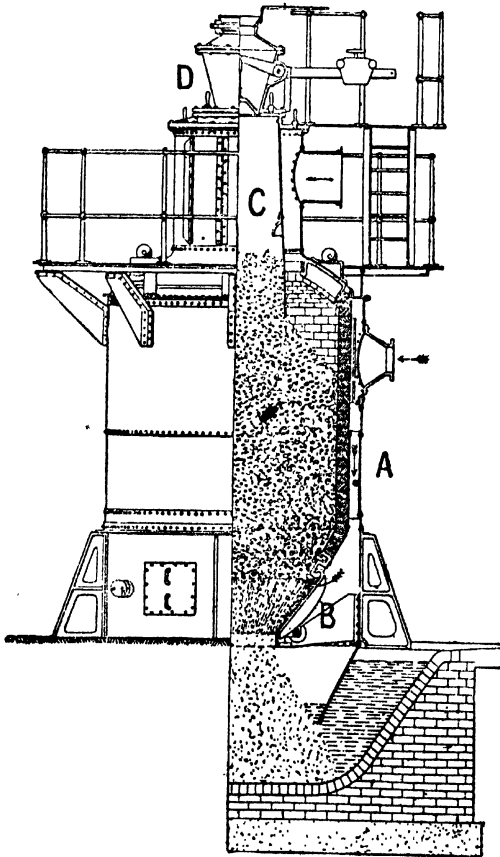

FIG. 51.—The Mond Producer.

charging hopper, D, which is supposed to expedite the preliminary distillation of the raw fuel. The Mond producer is usually worked with a very deep fuel bed, as indicated in the diagram, but if the bell, C, be dispensed with, a much shallower fuel bed may be used

THE COMPLETE GASIFICATION OF COAL

with advantage. In Fig. 52 is shown a similar producer, with an improved form of hanging bar grate, which was patented in 1909 by the author in conjunction with Dr. R. V. Wheeler, as having been shown by their investigations to be specially adapted for rapid gasification with a shallow fuel bed. In a producer of this type, 10 ft. internal diameter, from 20 to 25 cwts. of coal (or from 30 to 35 lb. per square foot of fire area) may be gasified per hour.

(3) **The Morgan Producer.**—Some years ago considerable

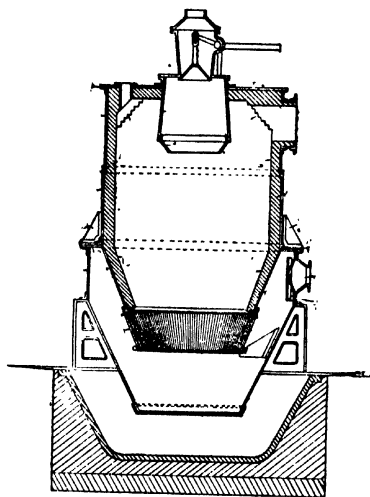

FIG. 52.—The B.-W. Producer.

attention was given to the automatic and continuous feeding of the fuel into producers so as to ensure a more even distribution over the fire-bed, and more uniform working conditions. The "George" feed of the Morgan producer (Fig. 53) was designed to effect this purpose. The essential feature of this device is an inclined and slowly rotating water-cooled feeding-spout, A, fixed immediately under the charging hopper, B, the fuel being continuously forced from B into A by the slowly revolving circular disc, C, working up against the fixed bracket, D. The producer itself is water-sealed and circular in section, but tapering from the middle downwards. The blast is introduced through the central dome, E, and

COAL AND ITS SCIENTIFIC USES

the gas outlet is at F. The producer may be worked with a shallow fuel bed (3 ft. thick), and with a fire of 10 ft. diameter will gasify about 10 cwts. of fuel per hour.

Mechanical Grates for Automatic Ash Removal.—The most recent constructional developments have been in the direction of introducing a mechanical contrivance for the automatic removal of the ashes and the diminution of clinker troubles, which with some coals are serious drawbacks to their gasification. The

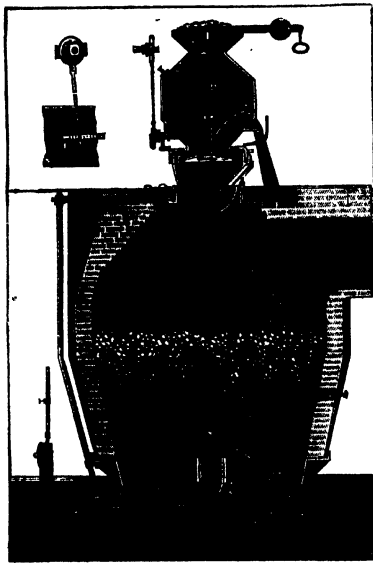

FIG. 53.—The Morgan Producer.

quantity of ashes to be withdrawn in a given time from a gas-producer depends, of course, upon the ash content of the fuel and the rate of its gasification. If the working conditions are such that the latter can be kept fairly constant over a long enough period of time, the automatic removal of ashes by some mechanical device, such, for example, as a revolving grate, not only saves labour, and enables low-grade fuels of high ash content to be used, but also by imparting a constant movement to the fuel bed it diminishes the tendency to clinker, prevents channeling, and facilitates the proper settling down of the charge.

THE COMPLETE GASIFICATION OF COAL

The **Kerperley Producer** (Fig. 54) embodied one of the first successful devices for such purpose. It consists of a revolving conical grate, A, fixed eccentrically upon the foundation, and provided with a flattened top. The cone comprises a number of plates through which the steam-air blast reaches the fire. The

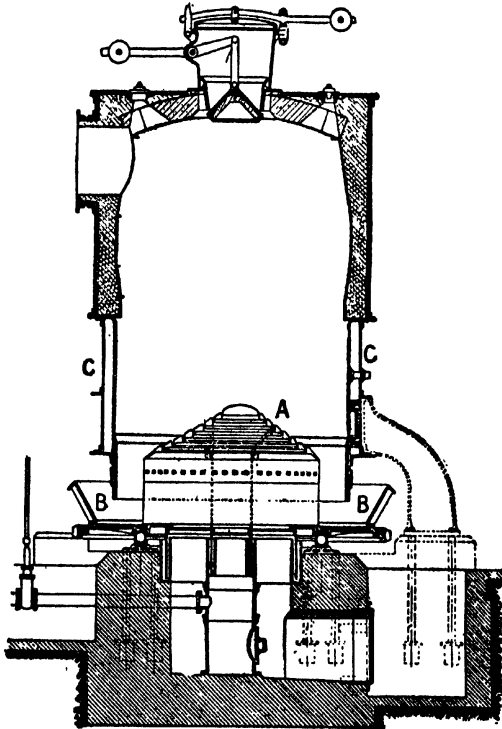

FIG. 54.—The Kerperley Producer.

grate is fixed in one piece with the shallow iron water trough BB, which is continuously rotated at the slow rate of one revolution every $2\frac{1}{4}$ to 3 hours. The lower part of the producer surrounding the zone of active chemical action is water-jacketed, CC, in order that no incipient clinkers can adhere to the cold side plate. The slowly revolving eccentric grate disintegrates clinkers before they attain large dimensions, and, pushing the ashes

COAL AND ITS SCIENTIFIC USES

outwards into the water trough, causes them to be automatically discharged.

Several others of the leading makers or producers have successfully fitted their designs with similar mechanical revolving grates for the automatic removal of ashes, and they are being employed in increasing numbers on large installations in steel works and the like.

(6) **Blowing Arrangements.**—All large gas-producers are blown on the pressure system, either by means of steam injection, or, preferably, by a suitable fan or blower, steam or electrically driven. The pressure required is usually only from 3 to 6 in. water gauge, according to the thickness of the fire. In the case of a blower-produced blast, the requisite steam is introduced through a lateral opening into the air duct a few feet before it enters the producer. It cannot be too often urged that perfect control and adjustment of the steam saturation temperature of the blast is of the utmost importance from the point of view of efficient and uniform working.

POWER PLANTS AND SUCTION-PRODUCERS

For the cleaning and cooling of producer gas for gas engines, various arrangements of plant are employed, comprising usually (1) a dust-catching chamber, (2) atmospheric condensers, usually of annular type, (3) water-sprayed coke or "hurdle" scrubbers, (4) water-sprayed fans or tar extractors, and finally (5) sawdust scrubbers or other equivalent devices for removal of tar fog. A photograph of a Dowson 800 B.H.P. power plant for Bituminous Coal is shown in Plate VI.

For small (up to 200 H.P.) power installations, producers in which the blast is induced by the suction of the engine cylinder ("suction producers") are now largely employed with anthracite or coke as fuel. The first successful attempt to operate a producer by suction in conjunction with a gas engine was made by Léon Bénier in 1896, who employed a suction pump, placed side by side with the engine cylinder and driven by means of a connection with the fly-wheel axle. Soon afterwards the suction of the engine itself, on the outstroke of the piston, was substituted for the Bénier suction pump, thus cheapening construction, and at the same time reducing frictional losses.

By the year 1901 "Suction Gas Plants" were established on the market, and their use has since steadily extended. Such a

THE COMPLETE GASIFICATION OF COAL

plant (as illustrated in Fig. 55) consists of the following essential parts: (1) a firebrick-lined *generator*, A, of cylindrical section in which the fuel is gasified by means of an air-steam induced draught. The fuel is introduced through an *air-tight feeding hopper*, B, which drops it into a *storage and distillation bell*, C,

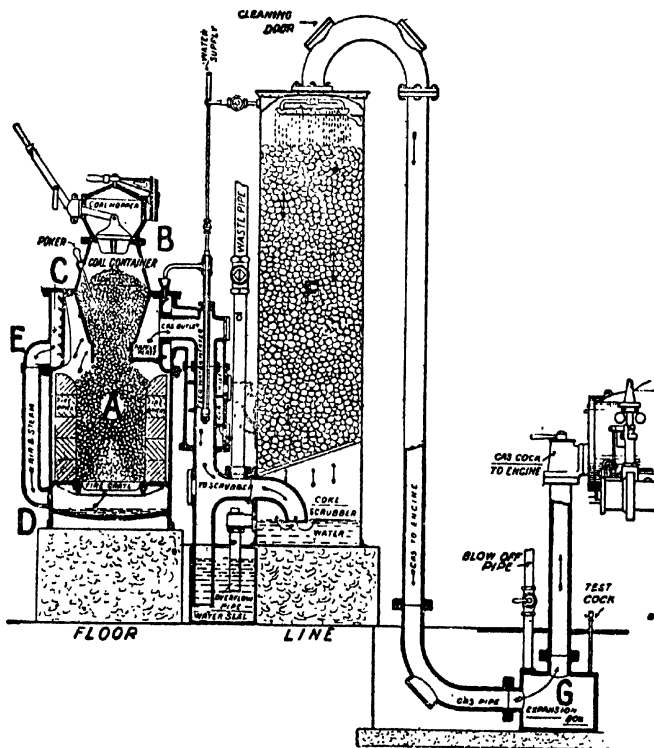

FIG. 55.—A Suction-Gas Plant.

situated within the generator. The fire rests upon a horizontal grate under which is a shallow chamber, D, with a solid bottom, and a lateral opening communicating with the air and steam supplies. (2) A *vapouriser*, E, fixed either within or without the upper part of the shell of the generator, in which a regulated water supply is vapourised, usually at the expense of some of the sensible heat of the hot gas leaving the generator, or sometimes

COAL AND ITS SCIENTIFIC USES

by the heat of the fire. (3) A water-sprayed *coke-scrubber*, F, for cooling and washing the gas, and (4) an *expansion box*, G, which serves the double purpose of a gas reservoir for the engine, and, on the suction stroke, of minimising the pulsations of the suck.

The generator is started up by kindling a wood fire on the grate with a layer of coke or anthracite above. The fire is blown up by means of a hand fan, which is a necessary auxiliary to the apparatus. During the starting-up period the products of combustion are sent into the atmosphere through a vent pipe, but as soon as a rich enough gas is generated (about 20 to 30 minutes from the start) the engine is started and the fan is shut off.

A typical "suction gas," generated from gas coke, with air saturated with steam at 51.7° , contained—

$$\begin{aligned} \text{CO}_2 &= 5.15, \quad \text{CO} = 25.45, \quad \text{H}_2 = 13.10, \quad \text{CH}_4 = 0.30, \\ &\text{and } \text{N}_2 = 56.00 \text{ per cent.} \end{aligned}$$

its net calorific value being 127 B.Th.U.s. per cub. ft. at 0° and 760 mm.

The thermal efficiency of the gasification, allowing for the power required to draw the gases through the system, and based on the net calorific values of the coke and gas respectively, is about 78.5 per cent. The fuel consumption on a suction plant is about 1 lb., or even slightly less, per B.H.P. developed, the water consumption for scrubbing the gas being about 1.2 gallons per B.H.P.

Although the earlier Suction Producers were all designed to gasify either anthracite and coke (and for plants up to 200 H.P. capacity this is still recommended) attempts have been made with some success to solve the problem of dealing with bituminous coal on the suction principle for power purposes. This is a development which will be watched with interest by all who wish to see power generated from coal more economically in medium-sized units.

AMMONIA RECOVERY SYSTEMS

In the Young and Beilby Patent, No. 1377 of 1882, in connection with the distillation of oil-bearing shales, etc., the claim was made for—

"The production of ammonia from coal, shale, ironstone, or

THE COMPLETE GASIFICATION OF COAL

other bituminous or carbonaceous mineral containing nitrogen by decomposing or burning the carbon resulting from the distillation thereof . . . at such a temperature and in the presence of such an excess of steam, either alone or co-mingled with air or with the products of combustion of carbon and air as will burn the carbon and will eliminate the nitrogen contained therein substantially as hereinbefore described."

In a paper by Mr. (now Sir) George Beilby in the *Journal of the Society of Chemical Industry*, in 1884, large-scale experiments were described in which small coal (dross), containing nitrogen equivalent to from 165 to 170 lb. of ammonium sulphate per ton, was fed into the top of a red-hot vertical retort by screw feeders and was there distilled, yielding tar vapours and steam, which on passing downwards through the red-hot coke below were decomposed into permanent gas and ammonia. The gaseous distillation products were taken off through a suitable duct situated about the middle of the retort. The coke passing down into the lower half of the retort was there burnt in a mixture of air and steam ($1\frac{1}{4}$ parts by weight of steam to 1 part of coal). The united gases from the upper and lower regions of the retort were subsequently drawn through condensers and scrubbers, where the ammonia was separated and recovered.

In this way between 60 and 70 per cent. of the nitrogen in the coal was recovered as ammonia (the yields of ammonium sulphate ranging from 90 lb. to 125 lb. per ton of the coal charged), together with a gas, one sample of which contained—

$$\begin{aligned} \text{CO}_2 &= 16.6, \text{CO} = 8.1, \text{H}_2 = 28.6, \text{CH}_4 = 2.3, \\ &\text{and N}_2 = 44.4 \text{ per cent.} \end{aligned}$$

The author of the paper remarked that this composition indicated "a rather excessive air supply, as we aim generally at a consumption of one half of the fixed carbon with air, the other half with steam. With such an admission of air the composition of the gas would probably be—

$$\begin{aligned} \text{CO}_2 &= 21.32, \text{CO} = 10.72, \text{H}_2 = 37.19, \text{CH}_4 = \text{nil}, \\ &\text{and N}_2 = 30.77 \text{ per cent.}'' \end{aligned}$$

These experiments, extending as they did continuously over a period of many weeks, clearly demonstrated the possibility of completely gasifying incandescent coal, or the carbonaceous residue formed by distillation therefrom, in a current of air

COAL AND ITS SCIENTIFIC USES

carrying with it a large amount of steam, so as to produce a combustible gas together with ammonia equivalent to, on an average two-thirds of the nitrogen in the coal.

The Mond System

The final solution of the problem on a commercial basis was due to the late Dr. Ludwig Mond, who, in his Presidential Address to the Society of Chemical Industry in the year 1889, described how he had evolved the well-known Mond System for generating producer gas from bituminous coal slack under conditions which admitted the recovery of as much as 70.6 lbs. of ammonium sulphate per ton.

A modern Mond producer has already been described on p. 351. The best practical results are obtained by working the producer with a blast-steam saturation temperature of 85° C., the mixture of air and steam being preheated to about 250° C. before it enters the fuel bed. There is carried into the producer by the blast about 2 lbs. of steam for every 1 lb. of coal gasified. One-third only of this steam is decomposed, by interaction with carbon in passing through the fuel bed, the remaining two-thirds passing with the hot gases out of the producer.

The outstanding features of the process are (1) that, owing to the cooling influence of the large proportion of steam in the blast upon the fuel bed, the low temperature interaction—

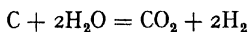

predominates over the high temperature "water-gas" reaction,



so that the resulting gas has a high hydrogen and low carbon monoxide content as compared with ordinary producer gas; and (2) that for economical working it is necessary that the large proportion of steam leaving the producer shall be conserved to the system by some efficient recuperative arrangement.

From a coal containing between 1.2 and 1.6 per cent. of nitrogen, it is possible to obtain up to 90 lbs. per ton of ammonium sulphate, together with up to 150,000 cub. ft. of gas (at 0° and 760 mm.), of calorific value about 150 gross and 135 net B.Th.U. per cub. ft. at 0° and 760 mm., containing—

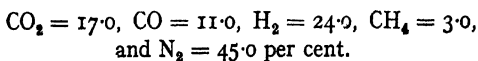

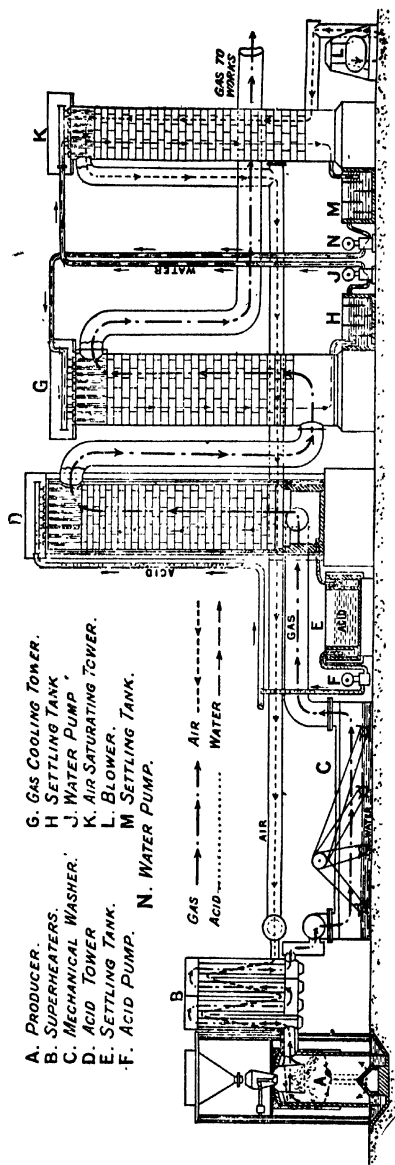

- A. PRODUCER.
- B. SUPERHEATERS.
- C. MECHANICAL WASHER.
- D. ACID TOWER.
- E. SETTLING TANK.
- F. ACID PUMP.
- G. GAS COOLING TOWER.
- H. SETTLING TANK.
- J. WATER PUMP.
- K. AIR SATURATING TOWER.
- L. BLOWER.
- M. SETTLING TANK.
- N. WATER PUMP.

Fig. 56.—Mond System of Ammonia Recovery.



COAL AND ITS SCIENTIFIC USES

According to the original **Mond System of Ammonia Recovery** and steam recuperation, the gas leaves the producer heavily charged with steam and tarry vapours at a temperature usually between 500° and 600° C. It then traverses the central tubes of a series of three annular "superheaters," indicated by B in the diagram (Fig. 56), each about 20 ft. long. The incoming steam-air blast passes through the annulus between the central and outer tubes in the reverse direction. The temperature of the gas is thus reduced to between 300° and 400° C., whilst that of the blast is raised to about 250° C. Further "superheating" of the blast occurs as it subsequently traverses the annulus between the inner and the outer steel casings of the producer itself.

The partly cooled gas next passes through a long rectangular and water-sealed chamber (the "mechanical washer"), C, where it encounters a water spray thrown up by a series of revolving dashers, by which means dust, soot, and a large amount of heavy tar are removed, and the gas itself is further cooled to about 100° C. It next passes up the lead-lined scrubbing tower, D, packed with perforated bricks or tiles, down which an acid liquor containing ammonium sulphate plus 2.5 per cent. of sulphuric acid is sprayed, the volume of liquor being so adjusted in relation to the upward flow of gas that the latter leaves the tower at a temperature of 80° C. and free from ammonia.

The liquor from the bottom of the tower, D, runs into an open tank provided with suitable partitions, in order to eliminate any small quantity of surface tar in it. To the main bulk of the circulating liquor is added a regulated quantity of sulphuric acid, after which it is again pumped up to the top of the acid tower, D. A portion of the liquor is, however, removed from the circuit, and evaporated to crystallising point in a special vacuum evaporator heated by means of steam pipes. After separation of ammonium sulphate, the mother liquor is pumped back into the main liquor circuit.

The ammonia-free gas, on leaving the acid tower at 80° C., is passed up the "gas-cooling tower," G, where it encounters a downward spray of cold water, so regulated that, whilst the gas is cooled down to about 60° C., the water is heated up to between 75° and 78° C.

The gas passes thence onwards to the place of consumption, a second water-sprayed cooling tower being previously used in order to cool the gas down to 30° C., at which temperature it

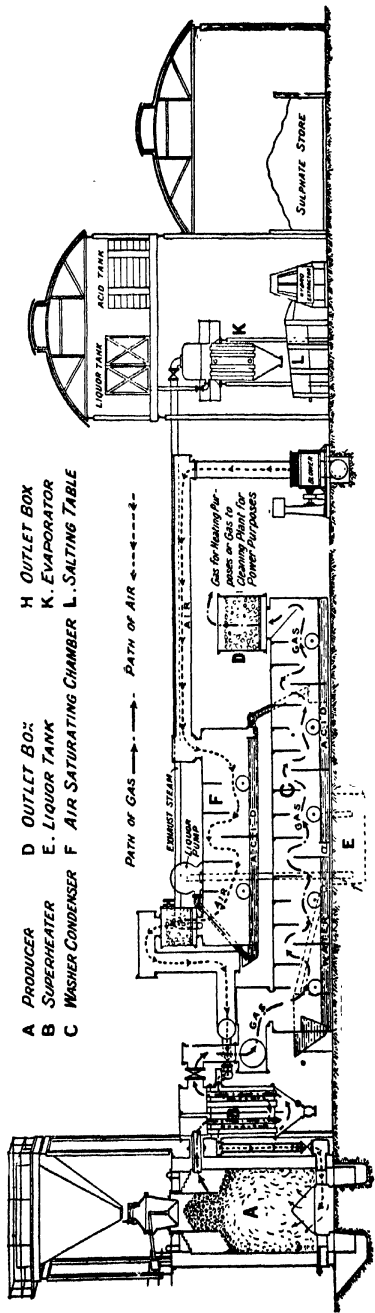

Fig. 57.—The Crossley and Rigby System of Ammonia Recovery.

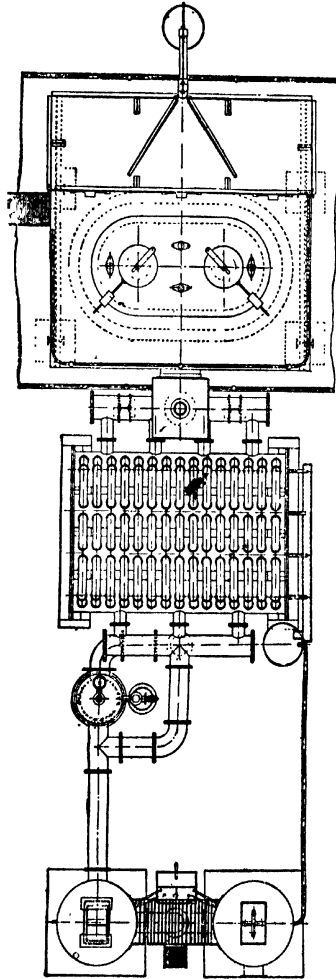

FIG. 58.—“Moore,” Water-jacketed Producer with By-product Recovery (Plan).

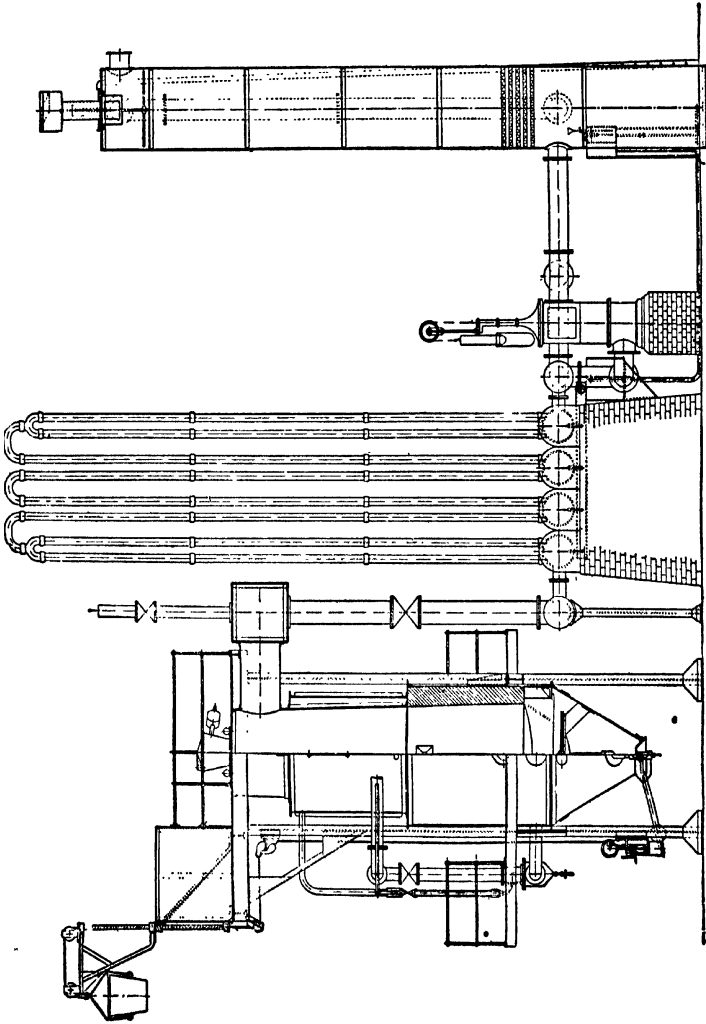

FIG. 59.—"Moore" Water-jacketed Producer with By-product Recovery (Elevation).

COAL AND ITS SCIENTIFIC USES

contains only 4 per cent. by volume of water vapour. If, however, the gas is intended for engines, it must be further cooled down to within a few degrees of the atmospheric temperature, and be also passed through a sawdust scrubber to remove the last traces of tar.

The hot water from the "gas-cooling tower" is passed through a tar separator, after which it is pumped up to the top of the "air-saturating tower," K, down which it is sprayed. The air blast for the producer is forced up this tower by means of a blower. In this way the blast is heated up to, and saturated with steam at, 75° C., at the expense of the hot water. A further quantity of live steam is added to the air blast as it passes forward to the superheaters in order to raise its steam-saturation temperature to 85° C.

The chief drawback to the original Mond System was the large capital outlay involved, which rendered ammonia recovery unprofitable unless either the amount of coal gasified exceeded about 180 tons per week, or the fuel was very cheap and contained more than 1.5 per cent. of nitrogen. Moreover, the gas, being rich in hydrogen and poor in carbon monoxide, is not quite so well suited for open-hearth steel or glass-melting regenerative furnaces as is one generated with a much smaller proportion of steam in the blast.

Successful efforts have been made to reduce the capital cost of the plant by the substitution of rectangular horizontal washers, constructed of steel or iron work and rendered resistant to the acid liquor by special treatment, for the expensive lead-lined vertical acid tower, and numerous Mond plants on these modified lines have been erected and are working satisfactorily.

In the **Crossley and Rigby System** (Fig. 57), details of which were given in the author's article on "Fuel" in *Thorpe's Dictionary of Applied Chemistry*, Vol. II, p. 624, similar rectangular horizontal washers were used, and the innovation was introduced of making the acidified sulphate liquor play the double rôle of an absorbent for the ammonia in the gas and an agent for the transference of undecomposed steam back to the blast.

The Moore System:—In this connection, also, mention may be made of an interesting attempt to achieve a satisfactory ammonia recovery on new lines which is embodied in the Moore Water-jacketed Producer and Recovery plants (Figs. 58 and 59), the following summarised description of which was published in the *Iron & Coal Trades Review* of February 21, 1913:—

THE COMPLETE GASIFICATION OF COAL

The characteristic feature of the producer is that the fuel is treated in a continuous manner in three zones. (1) The lowest, a fire-brick-lined high-temperature zone, in which the bulk of the gas and ammonia is generated with only such an excess of steam as will prevent the temperature rising too high in that zone; (2) a water-jacketed or low-temperature zone in which the gas is cooled with the object of preventing the decomposition of the ammonia formed without the necessity of a large excess of steam; and (3) what is really a continuation of the second zone, an upper or air-cooled zone. Whilst obviously there is a distinct line of demarcation between the lowest—*i. e.* the high-temperature zone and the intermediate zone—there is no such obvious limit between the last-mentioned and the upper zone.

It will be noted that to ensure this cooling effect the internal diameter of the producer, which is slightly conical, is less in proportion to its height than usual. Further, in order to get the best effect from the water jacket and air-cooled surfaces, the producer is elliptical in form, with rounded corners in cross-section.

The producer is continuously fed with fuel through a gas-tight feeding device, whilst the ashes are withdrawn without the use of a water bottom by means of two circular coned tables, one on either side of the grate, which is built up in halves. It will thus be seen that the producer is always approximately full, whilst the fuel is kept in slow but steady movement downwards, the tendency for the fuel to jamb being negated by the taper formation already referred to. At the same time the necessity for poking is reduced to a minimum, as the gradual heating combined with the constant movement tend to prevent caking.

The water jacket serves a double purpose, as, in addition to cooling the gases, it supplies the bulk of the steam necessary for operating the plant. As a matter of fact, the amount of live steam required from an outside source, calculated upon the total coal gasified in the producer, amounts to no more than 8.5 per cent. of that total, the amount of steam required for saturating the blast for the production of 80 to 90 lb. (depending upon the nitrogen content of the coal) being from 0.8 to 1 lb. of steam per lb. of coal.

The calorific value of the gas, working under the conditions necessary for the recovery specified, varies from 155 to 160 B.Th.U.s. per cubic foot at N.T.P., the average analysis being—

COAL AND ITS SCIENTIFIC USES

$\text{CO}_2 = 10.0$, $\text{CO} = 20.0$, $\text{H}_2 = 20.0$, $\text{CH}_4 = 3.0$,
and $\text{N}_2 = 47.0$ per cent.

By reducing the quantity of steam added to the blast it is possible to obtain a gas containing 25 per cent., or more, of CO, but the ammonia yield would be reduced by about 20 per cent. On the other hand, where the quality of the gas is of less account than a high yield of ammonia it is economically possible, by the addition of more steam to the blast, to materially increase the specified ammonia yield.

The temperature of the gas leaving the producer is comparatively low, being only about 200°C . Passing through air coolers the tar is extracted, the ammonia being subsequently scrubbed out in two washers arranged in series, the gases leaving the plant at, or under, atmospheric temperature and practically free from moisture.

The Lynn System.—Another Ammonia Recovery System, which has recently been developed by Mr. Arthur H. Lynn, of London, is shown diagrammatically in Fig. 60, and the author is informed that there are already between thirty and forty of these plants under construction or in operation in different parts of the world, including two in this country. It may briefly be described as follows:—

An ordinary Blower (A) is used to produce an air blast (shown thus - - - - - in the diagram) which passes through a vertical static intensive Air-Saturating Apparatus (B), in which it is brought into intimate contact with hot water (made hot by cooling the gas at a later point of the process). It thus becomes saturated with steam, and, after receiving a still further supply of steam, it passes into the Superheaters (C), in which the air and steam mixture is superheated by means of hot gases leaving the Producer (D). The air and steam mixture then passes to the grate of the Producer.

The Producers (D), which may have a mechanical or non-mechanical grate (E), according to circumstances and the coal to be used, are provided with a water seal (F), from which the ashes may be removed in the former case automatically and in the latter manually—without interfering in any way with the operation of the Producers. The hot gases containing the ammonia leave the Producers at the top and pass into the Superheaters (C) and superheat the air and steam blast which is passing (in the opposite direction) to the producers, and at the

THE COMPLETE GASIFICATION OF COAL

same time the gases are cooled thereby—thus recovering a great amount of heat. On leaving the superheaters the gases, after passing through special Dust Separating Apparatus (G), enter the vertical intensive static Ammonia Absorber (K), where they are brought into intimate contact with an atomised solution of sulphate of ammonia, containing a small excess of sulphuric acid, which absorbs the ammonia thus produced. The said

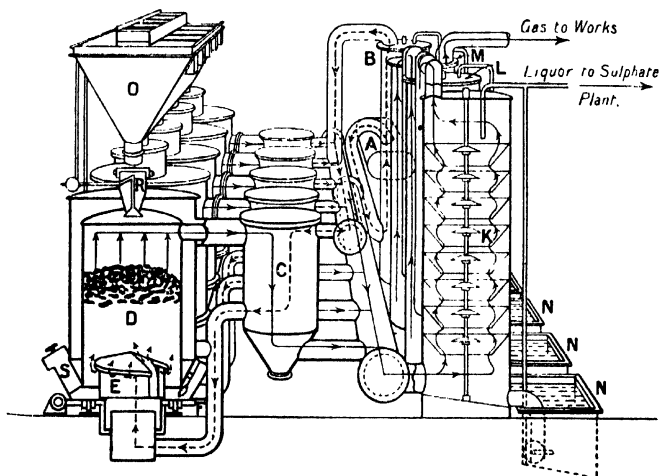

Fig. 60 —Lynn Ammonia Recovery Producer Gas Plant.

- | | | |
|--------------------------|-----------------------|----------------------|
| (A) Blower. | (B) Air Saturator. | (C) Superheaters. |
| (D) Producers. | (E) Mechanical Grate. | (F) Water Seal. |
| (K) Ammonia Absorber. | (L) Gas Cooler (1). | (M) Gas Cooler (2). |
| (N) Circulating Vessels. | (O) Fuel Bunker. | (R) Charging Hopper. |
| | (S) Ash Remover. | |

Air --->--- Gas ———>———

solution thereby becomes very concentrated and requires very little evaporation for the crystallising out of the solid salt.

From the Ammonia Absorption Apparatus the gases, after being freed from the ammonia, pass into the vertical intensive Gas Cooler (L), in which they are brought into intimate contact with cooled water. The Gas Cooler and the Air Saturator work in one cycle, the water first passing through the Gas Cooler in order to cool the gas (the water being heated thereby), and then into the Air Saturator in order to saturate the air and again cool the water ready for the Gas Cooler. It will be seen

COAL AND ITS SCIENTIFIC USES

that by this means a very large amount of steam is recovered from the gas.

From the Gas Cooler the gases pass to a second Gas Cooler (M), wherein they are brought again into contact with cold water. The gases are now sufficiently cool and clean for firing boilers or furnaces. If for use in gas engines, the gases have to pass through one or perhaps two centrifugal Cleaners, where they are almost entirely freed from tar; from here (after traversing a special Water Spray Separator), the gases are passed through a dry Scrubber filled with sawdust or wood shavings in which the last traces of tar are removed; the last two apparatus are not shown on the diagram. The gas is then quite clean and suitable for use in gas engines.

The circulating vessels (N) receive the water or liquor from the washers, whence they are repumped to the washers. (O) is the overhead fuel bunker, and (R) the charging hopper of the producer. (S) is the automatic Ash Removing Apparatus.

Before leaving the subject of Ammonia Recovery mention should be made of the enterprise of the South Staffordshire Mond Gas Company, who, from a central generating plant at Dudley Port near Tipton (a photograph of which is reproduced in Plate VIII) distribute gas of net calorific value 140 B.Th.U. per cubic foot at 0° and 760 mm. to various consumers over an industrial area of 123 square miles. The average price charged before the war was as low as 1½d. per 1000 cub. ft., which was equivalent to ordinary town's gas at about 7d. per 1000 cub. ft.

In concluding this short review of modern gas-producer practice attention may be directed to its importance in relation to the problem of the utilisation of low-grade fuels, especially when combined with ammonia recovery methods. The general adoption within recent years of mechanical devices for the automatic removal of ashes has enlarged its economic possibilities in regard to gasifying non-caking or feebly-caking coals, containing, or associated with, a large proportion of mineral matter, which could not be treated in a Washery with a view to subsequent coking.

With an efficient type of generator, properly controlled, it is possible to gasify practically the whole of the coal substance in such a way that the net calorific value of the resulting gas, when cooled and washed free from tar, shall be equivalent to 75 per cent. that of the original fuel. Moreover, the net value of the recoverable ammonia, with a coal containing 1.25 per

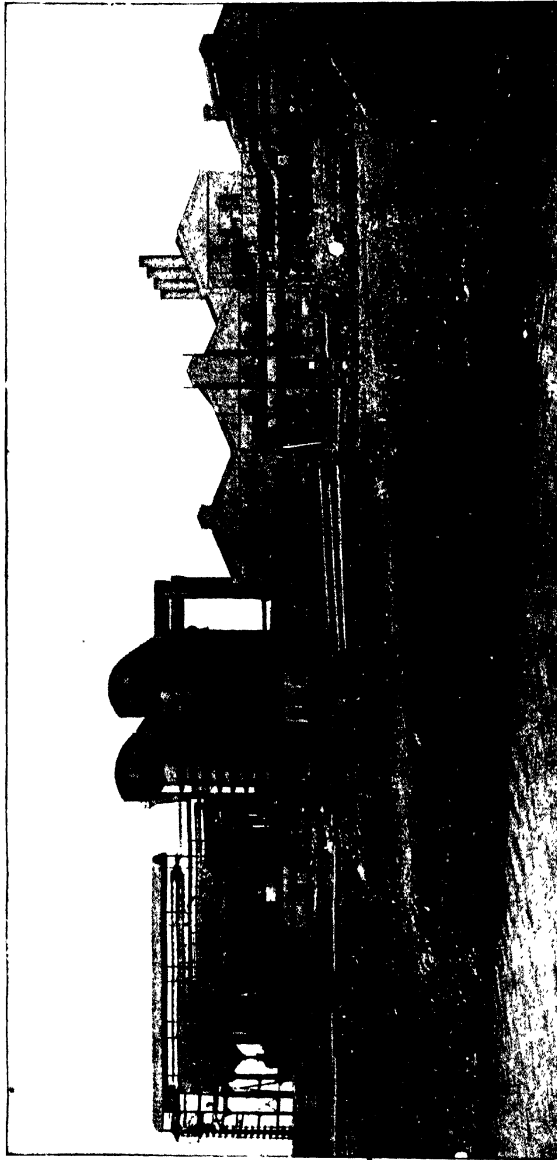

PLATE VIII.—Mond Gas Central Generating Plant at Dudley Port, Tipton.

. THE COMPLETE GASIFICATION OF COAL

cent. of nitrogen, may amount (on pre-war prices) to from 3s. 6d. to 4s. 6d. per ton of coal gasified. The chief hindrance to the more general adoption of ammonia recovery methods has hitherto been the ground space required by the plant and the initial capital outlay needed; but it is undoubtedly a profitable undertaking where these factors are of subordinate consideration.

In operating on a large scale, and especially in metallurgical or ceramic works, where gas is being generated mainly for furnace purposes, concentration of the gasification in one central battery of producers under proper scientific control is, in the author's experience, an essential condition to the attainment of the best results. The running of such plants is too often left to unskilled workmen under the supervision of a foreman who understands little or nothing about the principles involved. In such cases it is not surprising that the results attained fall far short of what they might be under better direction. In the course of his professional experience the author has sometimes come across cases, and especially in steel works, where, for want of proper scientific control, upwards of 100 tons of coal per diem were being gasified in producers under conditions which mean the needless waste of fully 25 per cent. (and sometimes more) of the fuel consumed. And, so far as this country is concerned, there is perhaps no branch of fuel technology in which the substitution of scientific for rule-of-thumb methods would realise greater margins of improvement than in connection with the generation and application of producer gas for furnace purposes.

CHAPTER XVIII

WATER GAS AND ITS APPLICATIONS

THE need of a cheap gaseous fuel of high calorific intensity for certain industrial purposes (*e. g.* steel welding) has led to the utilisation of the well-known endothermic interaction of steam and incandescent carbon at high temperatures, discovered by Fontana as long ago as the year 1780.



A mixture of carbon monoxide and hydrogen in nearly equal volumes, which is generally known as "Water Gas," can be easily generated on a large scale by passing steam, preferably super-heated, through a bed or column of coke or charcoal maintained at a temperature of 1000° C. or upwards.

For the process to be made continuous in practice, heat would have to be transmitted, from an external source, through the walls of the reaction chamber (*e. g.* a retort), made of some suitable refractory material whose heat conductivity would be fairly low. And inasmuch as such procedure would certainly be uneconomical, all idea of adopting it was soon abandoned in favour of an intermittent process, in which the bed of fuel (usually coke) is alternately blown (1) with air, until the whole mass attains the necessary high temperature, and (2) with super-heated steam for so long as the high temperature reaction,

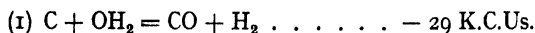

(which may be termed the true "water-gas" reaction) can proceed without undue occurrence of the low temperature change,

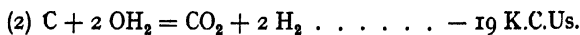

The influence of (2), which begins to be felt as soon as the temperature falls much below 1000° C., rapidly increases as the fuel bed is further cooled, until at 600° it becomes predominant.

Under conditions prevailing in large-scale practice, it is never

WATER GAS AND ITS APPLICATIONS

possible to exclude altogether the operation of (2); all that can be done is to restrict it within narrow limits. Hence the "water gas" which is generated for industrial uses is never the theoretical mixture of equal volumes of carbon monoxide and hydrogen resulting from the true "water gas" reaction (1), but usually contains at least 3 or 4 per cent. of carbon dioxide, and somewhat higher proportions of hydrogen than of carbon monoxide, because of the simultaneous but limited operation of the aforesaid reaction (2).

The manufacture of the gas on a large scale is always carried out in a "generator" whose form and dimensions are similar to those of an ordinary "dry bottom" gas producer (*vide* the preceding chapter) in which the fuel bed is supported on a suitable grate. Indeed, it may be said that the main difference between the processes of making "producer gas" and "water gas" is that whereas (1) in the former case a mixture of air and steam is passed *continuously* through the fuel bed, in such proportion as will maintain its temperature conditions as nearly constant as possible, so that a gas of uniform composition is *continuously* generated, (2) in the latter case the two gasifying agents (*i. e.* the air and the steam) are admitted *alternately*, each for a definite period, and the products of the action of each are kept separate. In both cases gasification of the fuel goes on continuously, in the first case uniformly all the time, but in the second case in accordance with *alternating* reactions.

THE ORIGINAL LOWE PROCESS

In reviewing the commercial history of water gas, it should be noted that already in 1830 the use of a carburetted gas for illuminating purposes had been introduced by Donovan, but apparently the project was only very short-lived. Also, that in 1849 Gillard devised a system of generating the gas, which embodied the principle of alternately blowing the incandescent fuel with air and steam so as to avoid any external heating of it. Moreover, during a period of nine years ending 1865, the town of Narbonne was lighted by blue water gas in conjunction with mantles or meshes of platinum wire, and in this connection internally heated generators were employed. The use of the gas in Europe seems to have died out altogether with the abandonment of this Narbonne project.¹

¹ See Prof. G. Lunge's article on "Gaseous Fuel," *Encyclop. Brit.*, 10th ed. (1902), XXVIII., p. 602.

COAL AND ITS SCIENTIFIC USES

The later revival and development of water gas as an industrial fuel must be credited to the pioneering labours of J. S. C. Lowe, Strong, and Tessié du Motay in the United States during the early seventies of last century. The first permanent success was achieved in the year 1873, when Lowe introduced his system at Phoenixville. In 1882 a Lowe apparatus was installed at Essen.

Nothing, however, was done in this country until in the year 1888, when the British Water Gas Syndicate installed the first Lowe plant in Great Britain at the Leeds Forge. This plant embodied the now obsolete idea of, during the "air blow," manufacturing a low-grade "producer gas" (a mixture of the oxides of carbon and nitrogen in which carbon monoxide was the predominating carbon constituent), for furnace purposes by blowing a deep fuel bed with an air blast at moderate pressure. This operation was alternated with the usual "steam blow" for the production of water gas." The "air blow" occupied 10 minutes, and the "steam blow" only 4 minutes, and each ton of gas coke yielded no more than about 34,000 cub. ft. of "water gas," and as much as 140,000 cub. ft. of "producer gas," only 25 per cent. of the carbon in the fuel appearing in the "water gas."

According to the late Professor V. B. Lewes the composition of this "producer gas" made during the "air blow" was—

$$\text{CO}_2 = 4.0, \text{CO} = 29.0, \text{H}_2 = 2.5, \text{and } \text{N}_2 = 64.5 \text{ per cent.},$$

so that it could be used as a low-grade furnace gas, thus making the whole cycle of operations thermally more economical than might appear at first sight.

THE DELLWIK-FLEISCHER SYSTEM

About ten years later the process was much improved by Dellwik and Fleischer, who proposed, during the air blow, to heat up a comparatively thin bed of fuel as rapidly as possible by means of a powerful blast supplied in such quantity as to burn the carbon as completely as possible to the dioxide.

In the Dellwik-Fleischer system (Figs. 61 and 62), as described by Mr. Dellwik in a paper before the Iron and Steel Institute in the year 1900,¹ the generator is of cylindrical section with a firebrick lining encased in a steel shell. The fuel bed (about 3 ft. in thickness) rests on a flat bar grate on a level with which are

¹ *Journ. Iron and Steel Institute*, 1900, I., p. 123.

WATER GAS AND ITS APPLICATIONS

clinking bars, and below which are doors for the removal of ashes. The air blast always enters the fuel bed from below through a valve, and the products of the "air blow" leave the generator by the central stack valve, through which also the fuel is charged from a small hopper wagon.

During the "steam blows" superheated steam from a boiler, working at a pressure of 150-160 lbs. per square inch, is blown through the incandescent fuel bed in either an upward or downward direction, the direction being reversed in each successive

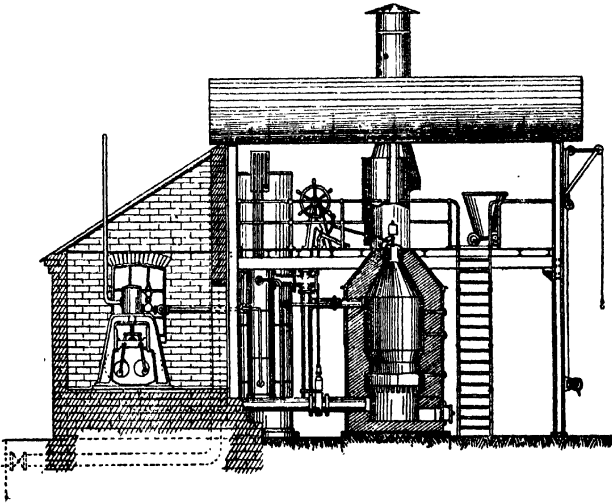

FIG. 61.—Dellwik-Fleischer Water Gas Plant.

blow. Accordingly, there is one "water gas" outlet at the top of the generator, and another below the grate, each provided with a valve leading to the annular "superheater," which serves to effect a heat exchange between the outgoing hot gas and the incoming steam blast, thus superheating the latter.

At the bottom of the "superheater" is a water seal through which the gas passes onwards to a coke-scrubber, where it is cooled and cleaned from dust by means of a water-spray; from thence the cold gas passes into a holder. The various valves of the generator are operated by an interlocking gear, which makes it impossible for the operator to make a mistake or to

COAL AND ITS SCIENTIFIC USES

get an explosive mixture in any part of the plant. A set of water gauges and a test flame on the operating platform indicate the working conditions in the generator at any moment and also the quality of the gas during the "steam blow."

The method of working the process is as follows:—A fire having been built on the grate, and the generator filled to the proper level with coke, the blast valve is opened, and the fuel raised as quickly as possible to a high degree of incandescence. The products of combustion, which should contain a much larger proportion of carbon dioxide than of the monoxide, are allowed to escape through the central stack valve. At the completion of the "air blow," one of the two gas outlets—for instance the upper one—is opened, the blast and stack valves being simultaneously closed by means of a gearing on the working stage. Steam is then admitted to the bottom of the generator, and on passing up through the bed of incandescent coke is decomposed by interaction with the carbon, forming water gas. As soon as the temperature of the fuel bed has fallen below the point at which carbon dioxide is generated in larger proportions than the normal, the steam is shut off, the gas-valve being simultaneously closed and the stack valve opened again. The blast valve is then opened for another blow of 60 to 90 seconds. For the next gas-making period the lower gas outlet is opened, and the steam admitted above the fuel bed, which it then traverses in a downward direction. By thus reversing in alternate runs the direction of the "gas-making" current, the temperature of the fuel bed is, as far as possible, equalised, and excessive wear at any one point on the lining of the generator avoided. In normal working each air blow lasts from 60 to 90 seconds, and each gas-making run from 4 to 6 minutes.

The Dellwik-Fleischer system was investigated by the late Professor V. B. Lewes, who found that "one thousand cubic feet of water gas, containing 15 lb. of carbon, are obtained by the total expenditure of 29 lb. of carbon, so that over 51 per cent. of the carbon is obtained in the gaseous form . . . the coke used in the experiment made contained 87.56 per cent. of carbon, or 1961.3 lb. per ton . . . and this amount yielded 77,241 cubic feet of water gas." The latter (average of three analyses) contained—

$$\begin{aligned} \text{CO}_2 &= 4.73, \text{CO} = 38.90, \text{H}_2 = 51.76, \text{O}_2 = 0.81, \\ &\text{and N}_2 = 3.8 \text{ per cent.} \end{aligned}$$

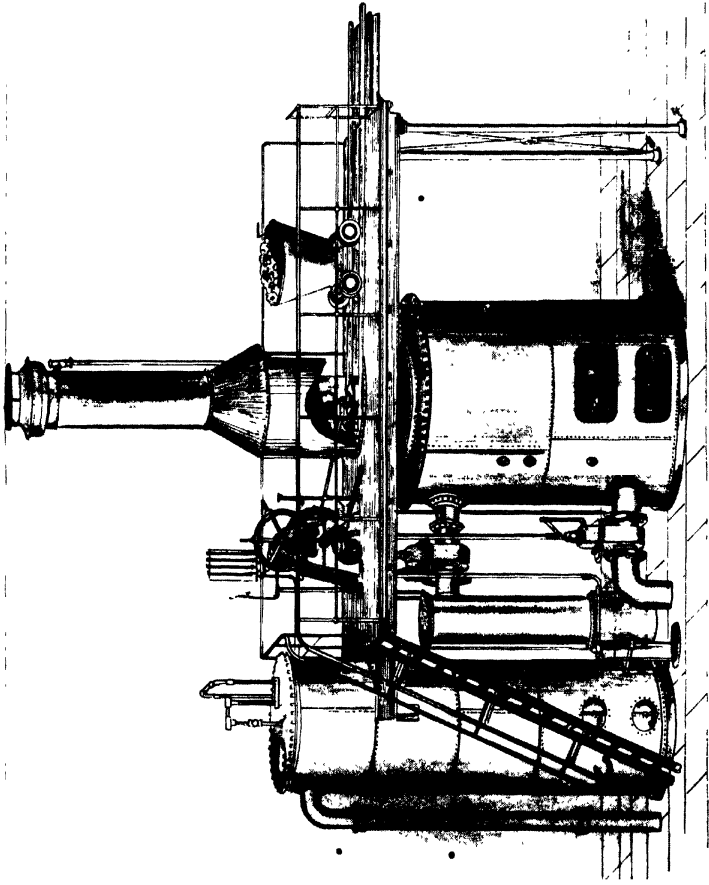

FIG. 62.—Dempster-Dellwik Water-Gas Plant.

WATER GAS AND ITS APPLICATIONS

According to Mr. Carl Dellwik, the average composition of the gas produced from coke by the system is approximately—

$$\begin{aligned} \text{CO}_2 &= 4.0, \text{CO} = 42.0, \text{H}_2 = 51.0, \text{CH}_4 = 0.5, \\ &\text{and N}_2 = 2.5 \text{ per cent.} \end{aligned}$$

In a ten-hours test of a Dellwik-Fleischer Plant carried out some years ago under the author's supervision at a large works in the North of England, where the gas was used for steel-welding purposes, the yield of gas per ton of *dry* coke containing 87.4 per cent. of carbon was 61,800 cub. ft. at 0° C. and 760 mm. (= 65,200 cub. ft. at 15° C. and 760 mm.), and the ratio of the carbon in the gas obtained to that on the dry coke used was 0.505. The average calorific value of the gas was 321 *gross* and 293.1 *net* B.Th.U.s. per cub. ft. at 0° C. and 760 mm., and its average chemical composition was as follows:—

$$\begin{aligned} \text{CO}_2 &= 3.90, \text{CO} = 42.90, \text{H}_2 = 49.15, \text{CH}_4 = 0.55, \\ &\text{and N}_2 = 3.5 \text{ per cent.} \end{aligned}$$

The ratios between the heat units in the gas and those in the coke were *gross* = 0.656 and *net* = 0.605. The average duration of each of the "air blows" was 60 seconds, and that of each "steam or gas-making run" was 234 seconds.

THE "K AND A" SYSTEM

Another system of water-gas making is that embodied in the Kramers and Aarts patents (the "K and A" system), according to which two generators, A and B (Figs. 63 and 64), connected through a double "regenerator," C, are operated in parallel during the "air blow," but in series during the "steam blow," somewhat as follows:—

During the "air blow" the fires (5 to 6 feet in thickness) in both regenerators are simultaneously blown in parallel by a powerful blast, which is introduced from below. The hot products (CO₂, CO, and N₂), on leaving the top of the generators pass upwards through the "double regenerator," a cylindrical structure filled with firebrick checker work and divided vertically into two chambers or compartments by a central firebrick wall. As the hot products enter in parallel streams at the base of one or other of the two chambers, they meet a secondary air supply sufficient to burn completely all the carbon monoxide which they may contain. The checker work in the chambers absorbs part

of the heat of the burnt gases which eventually make their exit into the outer atmosphere through the stack valve, D (Fig. 64), at the top of the double regenerator.

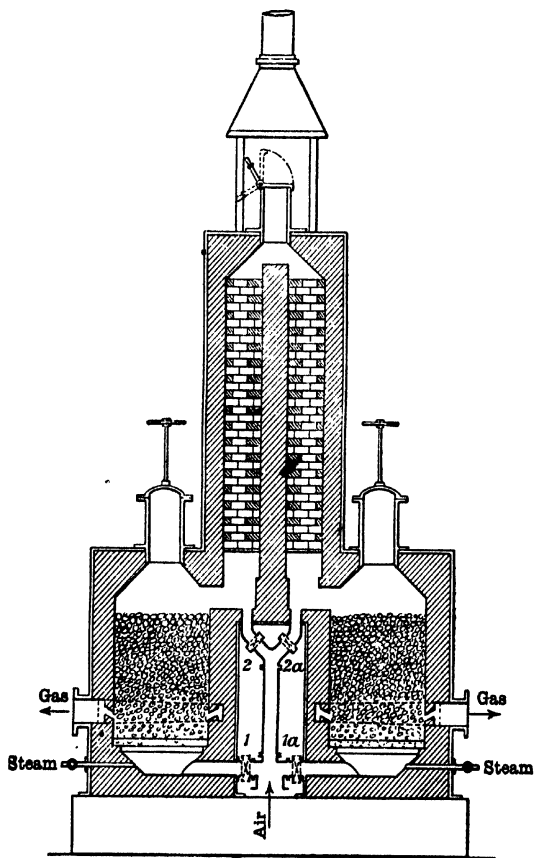
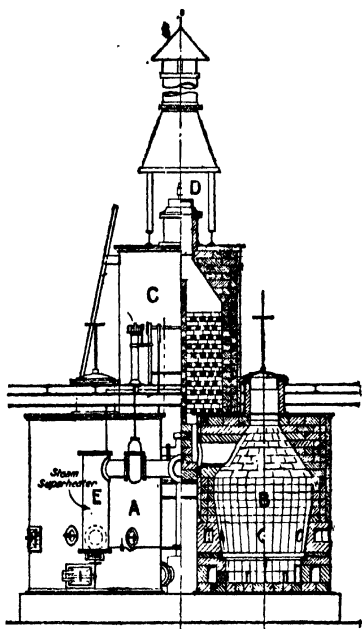

FIG. 63.—Kramer and Aart's Water Gas Producer.
(From Brame's *Fuel*.)

As soon as the fires in the two generators have attained the necessary high temperature, the air and stack valves are shut, and the steam valve simultaneously opened. The steam, entering the base of the first generator, traverses the fire contained therein in an upward direction. The products (CO_2 , CO , H_2 , and some



ELEVATION.

SECTION.

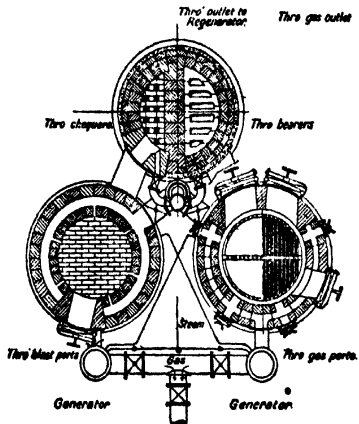

SECTIONAL PLAN.

FIG. 64.—Kramer and Aart's (the "K and A") Water-Gas System.

COAL AND ITS SCIENTIFIC USES

undecomposed steam), passing out at the top, traverse in a direction the two chambers of the "double regenerator," after which they enter, in a highly "superheated" condition, the top of the second generator, through which they pass in a downward direction.

In this way, it is claimed, the gases, just prior to leaving the system, come into contact with a bed of highly incandescent carbon, the temperature of which has not been sensibly lowered by the main endothermic steam-carbon interaction, which principally occurs in the first of the two generators. In alternate "steam blows" the direction of the steam and gases is reversed, in order to ensure the maximum of uniformity in the working conditions.

The plant (Plate IX) is operated by means of an interlocking valve gear, which prevents mistakes on the part of the workmen. The hot gas produced passes from the bottom of the second generator upwards first of all through the annular "steam superheater," E (Fig. 64), whereby part of its sensible heat is transmitted to the in-going steam blast, and then through a coke-scrubber, where it is cleaned and cooled by a downward water spray.

Soon after the process had been established in this country the author had the opportunity of thoroughly investigating its working in conjunction with steel welding operations in the North of England. The results of a measured trial, which extended altogether over a period of 6 hours, may be summarised as follows:—

- (1) The gas coke charged into the generator contained 1.40 per cent. of moisture.
- (2) The *dry* coke contained—
Carbon = 87.20, Hydrogen = 1.20, and Ash = 7.30 per cent., and its net calorific value was 13,300 B.Th.Us. per lb.
- (3) Total weight of *dry* coke gasified = 35.45 cwt. = 5.91 cwt. per hour.
- (4) Total *dry* gas made, at 0° C. and 760 mm. = 131,000 cub. ft. = 21,833 cub. ft. per hour.
- (5) The average composition of the dry gas was—
CO₂ = 3.75, CO = 43.70, H₂ = 45.10, CH₄ = 0.5, and N₂ = 6.95 per cent.
- (6) The average calorific value of the dry gas was 308.9 gross, and 284.9 net, B.Th.Us. per cub. ft. at 0° and 760 mm.

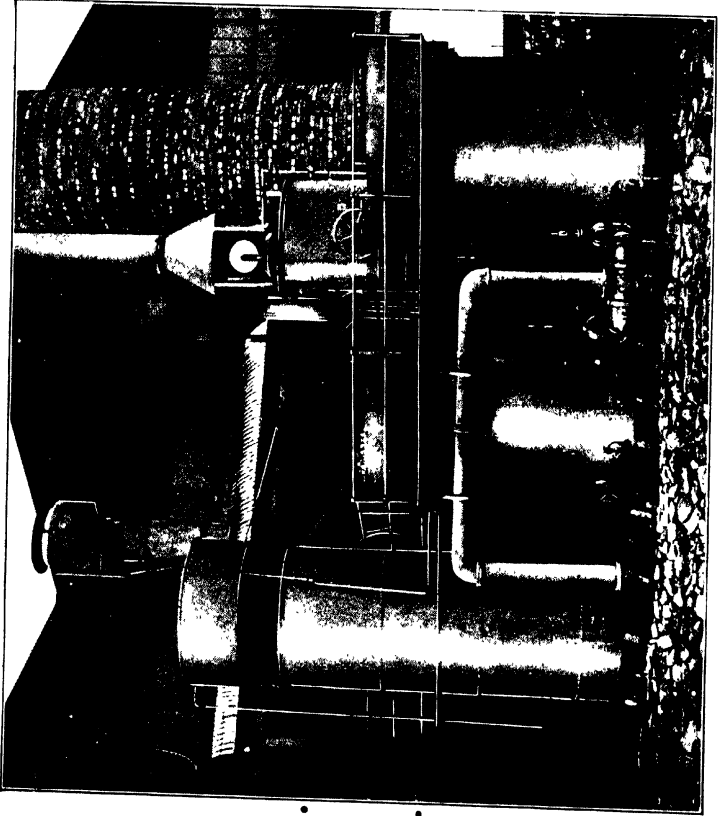

PLATE IV.—G.C. and A. D. WATER CARRIAGE. 1911.

WATER GAS AND ITS APPLICATIONS

- (7) The average duration of each "air blow" was 70 seconds.
(8) The average duration of each "steam run" was 308 seconds.

From the foregoing figures it follows that—

- (9) The yield of dry gas at 0° C. and 760 mm. per ton of dry coke gasified = 73,920 cub ft. = 77,980 cub. ft. at 15° C. and 760 mm.
(10) The ratio of the carbon in the gas obtained to that in the coke gasified was 0.6065.
(11) The ratio between the heat units in the gas to those in the dry coke were : *gross* = 0.766, and *net* = 0.705.

It should be observed, however, that the above figures do not take into account the energy expended either in raising the steam required to generate the gas or in blowing the fuel bed during the air blows.

From the foregoing descriptions and data, it seems reasonable to conclude that the more efficient types of water-gas plants are capable, in regular daily working, of transforming into water gas between 50 and 60 per cent. of the carbon in the coke charged into the generator, and of yielding a gas whose *net* calorific value may be anything between 60 and 70 per cent. of that of the fuel gasified, without counting the energy required either to raise the steam or blowing the fuel bed.

In pre-war days, with coke at 12s. 6d. per ton, the cost of making "blue water gas" in this country, based upon an assumed yield of 70,000 cubic feet per ton, would with continuous running be from 4½d. to 4¼d. per 1000 cub. ft., including fuel, wages, interest, depreciation, and all standing charges. This would be equivalent to coal gas at from 8½d. to 9d. per 1000 cub. ft. The cost of purifying the gas from sulphuretted hydrogen by means of oxide of iron may be taken at between 0.60 and 1.0d. per 1000 cubic feet.

BLUE WATER GAS

The gas generated from coke by such processes as the foregoing has the following representative composition :—

Carbon dioxide (and H ₂ S)	. . .	4.5
Carbon monoxide	. . .	43.0
Hydrogen	. . .	48.0
Methane	. . .	0.5
Nitrogen	. . .	4.0

COAL AND ITS SCIENTIFIC USES

Its density, referred to air as unity, is 0.553 and its *gross* and *net* calorific values, per cub. ft. at 0° C. and 760 mm. are 316.4 and 289.4 B.Th.U.s. respectively. It burns with a blue non-luminous flame (hence the name "blue water gas"), and requires rather less than half of its own volume of oxygen for complete combustion (*e. g.* one volume of gas of the above composition would require 0.465 volumes of oxygen or 2.22 volumes of air).

Owing to the fact that the heat capacity of the products *per unit of heat developed on combustion* is comparatively low, and to the shortness of its flame, its calorific intensity is higher than that of coal gas, and it is well adapted for operations requiring intense local heat. On this account it is much used for steel welding and like purposes.

Its high CO-content makes it a very poisonous gas, and in

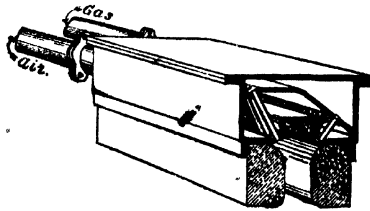

FIG. 65.

using it special precautions should be taken to avoid escapes or leakages of it into the workshops. Moreover, on account of its large hydrogen content, its mixtures with air have a rather wide range of explosibility, and are very liable to back fire.

Steel Welding by Water Gas.—The most important industrial application of blue water gas is undoubtedly steel-plate welding, and a large industry has grown up, especially in Germany, for the manufacture of welded steel tubes of large dimensions. The overlapping joint to be welded is heated simultaneously from both sides by special burners (Fig. 65) fed with both water gas and air under pressure, which on mingling produce aerated flames of great heating powers. As soon as the joint attains the proper welding heat, it is quickly passed through special rolls which bring about a perfect weld. The gas has also been used in Sweden for small steel melting and re-heating furnaces.

WATER GAS AND ITS APPLICATIONS

CARBURETTED WATER GAS AND ITS USE IN CONNECTION WITH PUBLIC SUPPLIES

Owing to the ease and rapidity with which it can be generated in a plant of moderate dimensions, together with its, comparatively speaking, low cost of production, water gas has, for many years past, been largely used in this country for mixing with ordinary coal gas for public supply.

Sometimes "blue water gas" purified from sulphuretted hydrogen is so used. Thus, one large English gas-works sent out a mixture composed of 80 per cent. of coal gas and 20 per cent. blue water gas, having a 14.5 to 15.0 candle illuminating power and a net calorific value equal to 550 B.Th.U.s. per cubic foot.

Usually, however, it undergoes a process of enrichment with gaseous hydrocarbons, generated by cracking petroleum oil at high temperature, before being mixed with the coal gas. This enriched water gas, which is really a homogeneous mixture of "blue water gas" and "oil" gas, is generally known as "carburetted water gas." Its composition depends of course upon the proportion of oil used in its manufacture, but the following may be given as typical analyses:—

	(1)	(2)	(3)
Carbon dioxide	0.14	0.30	3.8
Carbon monoxide	28.26	23.58	31.0
Ethylene and Propylene	11.29	12.80	11.4
Benzenes	1.53	2.63	
Methane	18.88	20.95	15.0
Hydrogen	37.20	35.88	32.9
Nitrogen	2.70	3.86	5.9
	<hr style="width: 100%;"/>	<hr style="width: 100%;"/>	<hr style="width: 100%;"/>
	100.00	100.00	100.00
Density (Air = 1)	0.5825	0.6057	—
Candle Power	22	26	—
Vols. of Air required to burn } 1 vol. of the gas	5.52	6.20	—

The density of the gas (Air = 1.00) usually varies between 0.57 and 0.75 and, compared with coal gas of equal candle power, it burns with a smaller and more brilliant flame. Moreover, as it contains hardly more than a fifth of the sulphur usually present in crude coal gas, and this almost entirely in the form

COAL AND ITS SCIENTIFIC USES

of sulphuretted hydrogen, it is readily purified by oxide of iron treatment only, which is said to reduce the sulphur to sometimes as low as 5 grains per 100 cub. ft.

In the United States, where the manufacture of Water Gas originated in 1885, some of the gas companies supply carburetted water gas only to their consumers. In other cases a mixture of one part of coal or coke oven gas with anything up to five, or even six, parts by volume of carburetted water gas is supplied. The following figures, kindly furnished to the author by Messrs. Humphreys & Glasgow, Ltd., showing the relative proportion of each gas contained in the public supplies of a number of the largest American cities, are of considerable interest in this connection :—

City.	Percentage of	
	Coal Gas.	Carburetted Water Gas.
Baltimore, Ind.	46.2	53.8
Boston, Mass.	44.5	55.5
Chicago, Ill.	17.5	82.5
St. Louis, Mo.	71.0	29.0
Rochester, N.Y.	17.0	83.0
Springfield, Mass.	47.5	52.5
Washington, D.C.	nil	100.0
Worcester, Mass.	61.0	39.0
New York and Brooklyn Area	13.4	86.6

The quality of the gas supplied to these cities, both as regards self-illuminating power and calorific value, is, as a rule, decidedly higher than that which we in England are nowadays accustomed to. Thus the results of the tests made by the Public Service Commission on the gas supplied in New York, Brooklyn, and Metropolitan District between January 1 and August 31, 1917, at various public testing stations in the area were as follows :—

Illuminating Value in Candles. Gross Calorific Value in B.Th.U.

No. of Tests.	Max.	Min.	Mean.	No. of Tests.	Max.	Min.	Mean.
3146	27.4	16.9	22.4	2644	750	568	659

The following may be given as a representative "mean" composition of the Carburetted Water Gas manufactured by the Consolidated Gas Company of New York during 1917, which

WATER GAS AND ITS APPLICATIONS

shows that it contained as much as one-eighth of its volume of heavy hydrocarbons ("illuminants"), and nearly 20 per cent. of methane:—

CO ₂ .	CO.	H ₂ .	C _n H _m .	CH ₄ .	O ₂	N ₂ .
3·2	27·0	30·6	12·5	19·3	1·0	6·4 per cent.

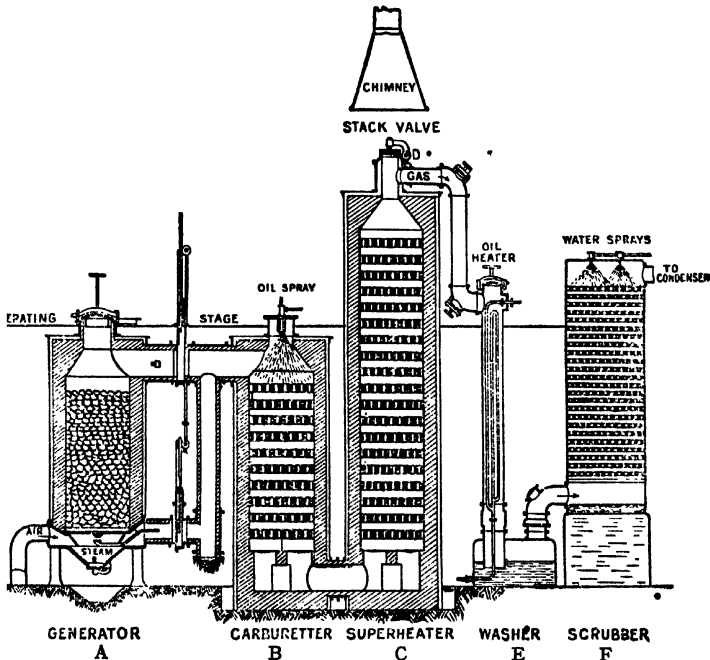

FIG. 66.—Diagrammatic Section of the Humphreys and Glasgow Carburetted Water-gas Plant.

In Great Britain, on the other hand, owing to the prejudice against having a gas supplied for domestic consumption containing more than 16 per cent. of carbon monoxide (which is regarded as a reasonably safe limit), the proportion of carburetted water gas mixed with the "straight" coal gas rarely exceeds one in three by volume.

Manufacture.—The accompanying diagrams (Figs. 66 and 67) represent the well-known Humphreys and Glasgow Plant, which

COAL AND ITS SCIENTIFIC USES

is now largely used for manufacturing carburetted water gas.¹ The generator, A, is worked with a deep bed of fuel (coke or anthracite), and during the "air-blow" the blast is so regulated that the gases evolved from the generator contain sufficient carbon monoxide to make them burn readily. They pass from the generator through successively (1) the carburettor, B, and (2) the superheater, C, each of which is filled with firebrick checker work. At the top of B, and again at the bottom of C, the gases meet secondary air streams, by means of which they are burnt, and the heat developed raises the checker work in both B and C to red heat. The products of combustion finally pass outwards into the air through a stack valve, D, at the top of the superheater.

As soon as the fuel bed in the generator has been raised to the necessary high temperature (3 to 4 minutes), the air valve, as well as the stack valve, is closed, and steam is turned on at the bottom of the generator. This, on rising through the incandescent fuel, produces "blue water gas," which passes outwards to the top of the carburettor. Here a petroleum oil is sprayed into the gas, and passing with the latter over the hot checker work in the carburettor and superheater, it is successively vaporised and decomposed into permanent hydrocarbon gases ("oil gas"). The resulting mixture of "blue water gas" and "oil gas" passes out from the top of the superheater and onwards successively through (1) a water-sealed oil heater and washer, E, (2) a scrubber, F, where it is water-sprayed, and finally (3) a water-cooled tubular condenser, G. It is afterwards purified in the usual manner from carbon dioxide and sulphuretted hydrogen by means of lime and oxide of iron.

The "steam run" usually occupies between 5 and 7 minutes, and the alternating "air blow" between 3 and 4 minutes. The checker work of the carburettor and superheater is best maintained at 750° C. or thereabouts. A small quantity of thin tar (sp. gr. 1.00 to 1.05), consisting chiefly of aromatic hydrocarbons, separates out in the washer and scrubber.

The coke consumption (including that required to raise the steam) does not exceed 50 lb. per 1000 cub. ft. of gas made, whilst the oil consumption varies with the quality of the gas produced.

¹ This description of the H. and G. Plant has been abbreviated from that given in Dr. H. G. Colman's article on the subject in Thorpe's *Dictionary of Applied Chemistry*, Vol. II., p. 685; the author is, however, indebted to Messrs. Humphreys and Glasgow for their courtesy in allowing him to reproduce Fig. 67.

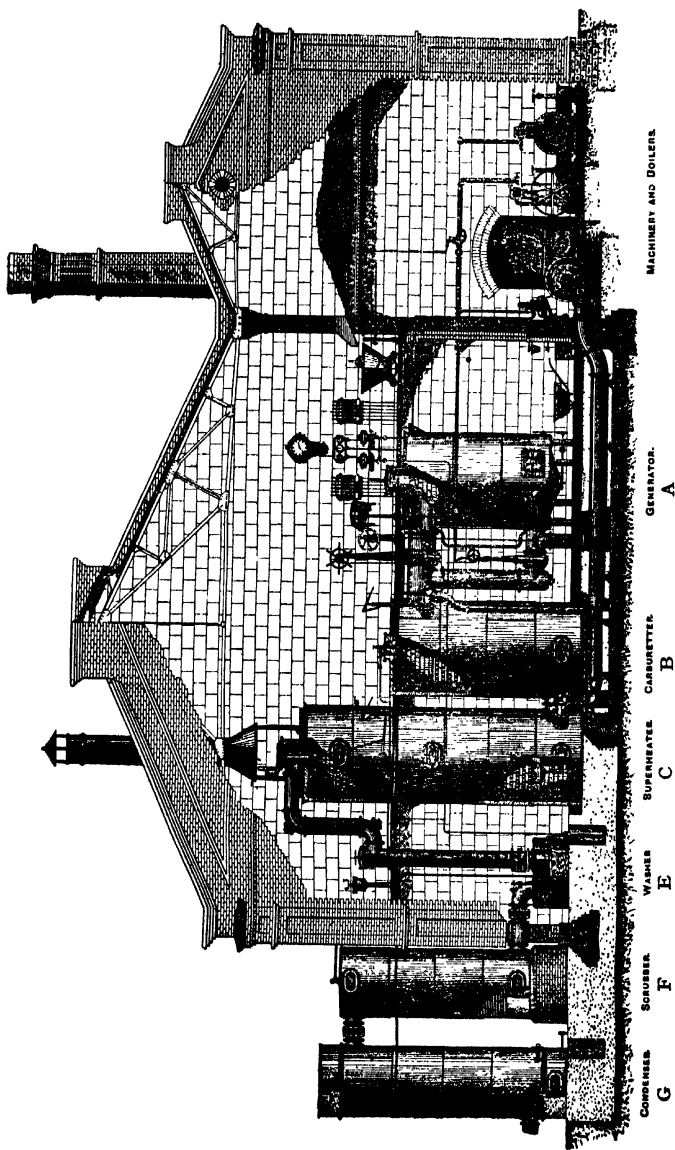

FIG. 67.—Humphreys and Glasgow Carburetted Water-gas Plant.

COAL AND ITS SCIENTIFIC USES

It is usually considered that with good management each gallon of oil used per 1000 cub. ft. of gas will give an illuminating power of 7 or 8 candles, so that to make a 15-candle-power gas, 2 gallons of good petroleum oil per 1000 cub. ft. would be required.

It should also be stated that Messrs. Humphreys and Glasgow have erected many successful blue water-gas plants in different parts of the world.

CHAPTER XIX¹

FUEL ECONOMY IN THE MANUFACTURE OF IRON AND STEEL

INTRODUCTION

It is proposed in this and the next following chapter to review briefly the salient features of the problem of fuel economy in relation to the smelting of iron ores in the blast furnace and the subsequent conversion of the resulting pig iron into finished steel sections.

In the year 1913, the total output of pig iron in the United Kingdom amounted to 10·48 million tons, from which the following quantities of steel were subsequently produced :—

		Tons.		
Bessemer	{	Acid 1,048,772	}	or 20 per cent. of the total.
	{	Basic 551,929		
Open Hearth	{	Acid 3,811,382	}	or 80 " " "
	{	Basic 2,251,793		
Total		7,663,876		

The amount of fuel consumed in the blast furnace per ton of pig iron produced would obviously depend upon the grade and character of the ore smelted, and therefore would vary in different localities. But from recent information placed at the author's disposal, the average coke consumptions per ton of pig iron from the different ores smelted were approximately as follows :—

Ore.	Coke per Ton of Pig Iron. Cwts.
Haematite	21·0
Cleveland	23·5
Lincolnshire	32·5
Other varieties	28·0

¹ The author desires to express his indebtedness*to his relative, Mr. T. C. Hutchinson, as well as to his former pupil, Mr. Ernest Bury, M.Sc., of the Skinningrove Iron Co. Ltd., for much help and guidance in connection with the subject matter of this chapter; it has been his good fortune to have had many opportunities during recent years of discussing with them the manifold problems in fuel economy connected with the general arrangement and operation of a modern iron and steel-works.

COAL AND ITS SCIENTIFIC USES

It would also appear from the aforesaid information that the average coke consumption for the whole Kingdom probably amounted to about 25 cwt. of coke per ton of pig iron produced. And if it be further assumed that the corresponding amount of coal probably would be 37.5 cwt.,¹ it follows that the total coal used in producing the 10.48 million tons of pig iron in the year 1913 would amount to 19.65, or say approximately 20.0 million tons.

Again, from similar information regarding the total amount of coal consumed in producing the 6 million tons of open hearth steel sections from pig iron, including all the fuel used in the furnaces, soaking pits, rolling mills, and the like, it would appear that this probably did not fall far short of 4½ million tons. Altogether, taking into account the 1.6 million tons of finished products from Bessemer steel, the manufacture of special steels, and the coke consumed in iron foundries, it seems reasonable to suppose that the total consumption of coal in connection with the manufacture of iron and steel during the year in question would amount to not much less than about 30 million tons.

With a view to concentrating attention upon the main issues, it is proposed to leave out of consideration in this review the production of special steels (such as are employed for the manufacture of guns, armour plates, cutting tools, cutlery, and other like appliances), and to confine it to the larger and more general problem of how fuel may be economised in the production of pig iron and ordinary structural steel, which, of course, comprise by far the greater part of the total output.

The central and ruling fact which confronts every ironmaster, and upon which the whole question of fuel economy hinges, is that the natural laws governing the reduction of the ore in the blast furnace are such as make it practically impossible to utilise within the furnace itself more than about 60 per cent. of the total available energy of the coke charged into it. This arises from the well-known fact of the reversibility at all temperatures within the furnace of the interactions between carbonic oxide and the oxides of iron:—

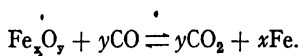

¹ The average yield of coke made in *all* coke ovens in the year 1914 amounted to 13.422 million tons from 20.145 million tons of coal, or just over 64 per cent.; the above estimate is, however, based upon the assumption that two tons of coke were obtained from three of coal.

ECONOMY IN MANUFACTURE OF IRON AND STEEL

SIR LOWTHIAN BELL'S SCIENTIFIC INVESTIGATIONS UPON COKE CONSUMPTION IN THE BLAST FURNACE

We owe the demonstration of the above cardinal fact to the researches of the late Sir Lowthian Bell, who, following up the earlier work of Bunsen and Playfair upon the actions of the furnace gases upon the descending charge of ore, fuel, and flux, so elucidated the chemistry of the process in all its sequences that he may be said to have transformed blast-furnace practice from an empiric art into a truly scientific process. His treatise on the *Chemical Phenomena of Iron Smelting*, published in 1872, deservedly ranks among the world's metallurgical classics, and will long remain a standard work of reference for all who are engaged in iron smelting.

It is perhaps worth while to recall the circumstances which led Bell to publish his work, and some of the conclusions which he established by it.

The startling results in the direction of economising fuel which had followed the general adoption of Neilson's invention of hot blast in 1828, followed by Bunsen and Playfair's scientific investigations on the composition of the furnace gases at various levels in 1845, led, about fifty years ago, to the building of furnaces of much greater heights and capacities than had ever before been thought practicable. The temperature of the ingoing blast was also progressively raised by the gradual adoption of improved types of coal-fired stoves. And with each successive increment in either furnace height or blast temperature there followed more economy in fuel.

The first six furnaces erected in 1853 for smelting Cleveland ore at Messrs. Bell. Bros., Clarence Works, were each 48 ft. in height and 6174 cub. ft. in capacity. When put into operation with a moderately heated blast, the output reached per furnace was almost 130 tons per week with a coke consumption of nearly 34 cwt. per ton of pig iron. On increasing the blast temperature the output per furnace rose to a maximum of 220 tons per week, whilst the coke consumption fell to about 28·7 cwt. per ton.

In 1865 two new furnaces were added, each 80 ft. high and 15,000 cub. ft. capacity. The immediate result was an increase in the average weekly output per furnace to 310 tons and a drop

COAL AND ITS SCIENTIFIC USES

in the coke consumption to 23.11 cwt. per ton. Later on, in 1874, four new furnaces were built, each 80 ft. high and 20,200 cub. ft. capacity; the resulting average coke consumption fell to 22.4 cwt. per ton of iron produced, whilst the weekly output rose to between 440 and 470 tons.¹

Whilst these developments were in progress, the opinion had gained ground that a progressive increase in furnace dimensions, in combination with gradually increasing blast temperatures, must necessarily result in further fuel economy. In 1868 the designers of two furnaces erected at Ferryhill, in the county of Durham, built them 103 ft. high and 33,000 cub. ft. capacity, confidently expecting to reduce the coke consumption to a point considerably below what had been achieved in the case of the then 80 ft. furnace. But their expectations were not realised.

In the same year Charles Cochrane, a prominent Cleveland blast-furnace engineer, in a paper before the Society of Mechanical Engineers, had gone so far as to express the opinion that "*enough heat might be conveyed into the furnace with the blast to enable a ton of iron to be produced from Cleveland stone with 13 cwt. of coke.*"

Bell at once realised that any such notion was inconsistent with the results of his own scientific investigations, in which he had proved beyond all question the reversibility of the action of carbonic oxide upon the oxides of iron. He therefore boldly undertook the responsibility, in a paper read before the Iron and Steel Institute in 1869, of refuting what he considered to be the error underlying Cochrane's opinion.

In his subsequent treatise in 1872 he gave a wonderfully clear exposition of the laws governing blast-furnace practice, and especially of the operation in the furnace of the "*law of mass action,*" a principle which, although originally enunciated by Berthollet in his famous *Essai de Statique Chimique* in 1803, had been strangely disregarded by chemists until its revival in a modified form by Guldberg and Waage in 1867. Bell at once realised its importance, and assuming 1000° C. to be the limit beyond which it would not be practicable to preheat the blast,

¹ In his *Chemical Phenomena of Iron Smelting* (1872) Bell estimated that by increasing the dimensions of their furnaces and the temperatures of the ingoing blast, Cleveland ironmasters had already effected a saving equivalent to 1 million tons of coal per annum, exclusive of a further 0.75 million tons which had resulted from their adopting the French practice of using the waste gases from the furnaces for compressing and preheating the blast.

ECONOMY IN MANUFACTURE OF IRON AND STEEL

he summed up his views upon the whole question in two main conclusions, namely :—

- (1) that no advantage can possibly accrue from an increase in the height or capacity of the furnace beyond the limits which would permit of the gases leaving the furnace at a temperature of about 300° C., and
- (2) that the practical limit beyond which the reducing power of the gases cannot be further utilised in the furnace is reached when at their point of exit therefrom, and at a temperature of 300° C., they contain 45 to 50 of carbon dioxide to every 100 of carbon monoxide by volume.

The fundamental importance of Bell's investigations in relation to the central problem of fuel economy in the blast furnace is now universally acknowledged throughout the industry. And since his main conclusions are founded upon the recognition of the operations of certain immutable natural laws in the furnace, it follows from (2) that, no matter how blast furnace practice may in future change, either in the direction of increasing the weekly output, or in respect of greater mechanical efficiency, it will never be possible to utilise more than a certain fraction (which judging from Bell's experiments would seem to be about 53.3 per cent.) of the total available energy of the coke which must be charged into it.

With regard to the practical consequences of his experiments, Bell was led to believe that no further increase in the furnace dimensions beyond certain limits (which from actual observations he put at 80 ft. in height and about 16,000 cub. ft. in capacity) will be conducive to greater fuel economy. And he expressed the opinion that, "taking the ordinary run of Durham coal and Cleveland ironstone, the ironmaster who produces a ton of No. 3 iron with $21\frac{1}{2}$ cwt. (of coke), with the blast heated to 500° C., may consider himself as working very closely up to these limits of economy which are prescribed by the nature of the materials he is operating upon." And again, in another place he stated "with some degree of confidence that it is useless to hope to smelt a ton of grey iron from the Cleveland stone yielding 41 per cent. of pig metal with anything notably under $20\frac{1}{2}$ cwt. of coke." And the accumulated experience of the forty-five years which have elapsed since this conclusion was written may be said to have substantially confirmed its validity.

COAL AND ITS SCIENTIFIC USES

If, then, as Bell's researches seem to show, the *practical working limit* imposed by the proved reversibility of the inter-action—

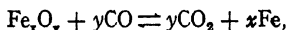

is reached when the gases, leaving the furnace at about 300° C., contain 50 of CO₂ to every 100 of CO, it follows:—¹

- (1) that the heat of combustion of the exit gases can never be less than about 47 per cent. of that of the coke charged, and
- (2) that, so soon as the said limit is attained, any further fuel economy in blast-furnace practice must be sought after in the better utilisation of the heat of combustion of the exit gases *outside* the furnace, except in so far as the heat in the molten slag or iron may be so utilised.

Hence the blast furnace, though primarily designed for the smelting of iron ores, is, by virtue of the laws governing its operation, a big producer of combustible gas, which must be utilised to the best advantage for power and heating purposes if the utmost fuel economy in the process is to be attained.

A SUMMARY OF THE PRINCIPAL CHEMICAL CHANGES OCCURRING IN THE BLAST FURNACE

In order that the lay reader may the better understand the drift of the subsequent argument, it is desirable at this point

¹ This statement must not be read as meaning that the *theoretical* equilibrium ratio CO/CO₂ for the temperature at which the gases leave the furnace (250° to 300° C.) is as high as 2.0. Indeed, as will be seen in the next chapter, in American practice, where hematite ores are smelted with blast pressure from 12 to 15 lbs. per sq. in. (hot blast at 380° to 465° C., and exit gases at as low as 180° to 280° C.), ratios as low as 1.75 (with "normal" blast) and 1.25 even (with "dry" blast) have been attained. What Bell claimed to have established, as the results of numerous experiments, was that, in smelting such lean ores as Cleveland ironstone, the reducing action of the gases at the temperature at which they leave the furnace (250° to 300° C.) becomes so *extremely feeble* when they contain from 30 to 50 of CO₂ per 100 of CO, that the ratio CO/CO₂ = 2.0 may be regarded as "*the real practical limit*." And he further argued that any increase in the blast temperature beyond a point at which the gases would leave the furnace at 300° C. or thereabouts, with this CO/CO₂ ratio, would not result in any further economy in coke consumption in the furnace. It is possible that, as the result of future research and development, the actual limiting ratio assigned by Bell for such ores as the Cleveland ironstone may be somewhat lowered, although as yet there is no indication in practical working that it will be, but that some such limit is really imposed by natural law is indisputable.

ECONOMY¹ IN MANUFACTURE OF IRON AND STEEL

to make a short digression with the object of explaining the character and sequence of the principal reactions occurring in the blast furnace. Limitations of space forbid any exhaustive treatment of the subject, nor indeed is any such necessary to the purpose in view; it will suffice if a clear outline of the main phenomena is given. And the case of a furnace smelting calcined Cleveland ironstone with Durham coke will be taken as a typical example of present-day British blast-furnace practice.

A modern blast furnace is shown in section in Fig. 68. The height from the bottom of the hearth to the charging platform may be taken as approximately 80 ft., whilst the greatest diameter at the boshes averages about 22 ft., and the total capacity between 18,000 and 20,000 cub. ft. Such a furnace will, with blast at 5 to 6 lb. pressure preheated to 725° C., produce between 800 and 1000 tons of pig iron (Fe = 92.5 per cent.) per week from ironstone containing, in the raw state 27.0, and after calcination prior to being charged into the furnace 37.0, per cent., of metallic iron.

(A) *The Materials entering the Furnace per Ton of Pig Iron produced are—*¹

- (1) About 56 cwt. of calcined Cleveland ore, containing ferric oxide *plus* a matrix principally composed of silica, alumina, lime, and magnesia.
- (2) 15 cwt. of limestone, containing 90 per cent. of CaCO₃;
- (3) 22.5 cwt. of coke, containing 89 per cent. of carbon;
- (4) 138,700 cub. ft. (at 15° C. and 760 mm.) of air as blast, which is preheated to a temperature of (say) 725° C.

(B) *The Principal Changes occurring in the Furnace may be summarised as follows:—*²

- (1) The fuel is gasified by the hot blast in the neighbourhood of the tuyères, producing a mixture of carbon monoxide and nitrogen.

¹ The data embodied in the calculations in the following paragraphs, (A) to (E) inclusive, are taken from a paper by Mr. T. C. Hutchinson, of the Skinningrove Iron Co., in the *Journ. Iron and Steel Institute*, 1908, III., p. 38, supplemented by later information.

² The author is well aware that the reactions in the furnace are actually more complex than is represented in this summary, but for the purposes of the present exposition it is not necessary to go beyond the simplest statement of the main character of the principal changes involved.

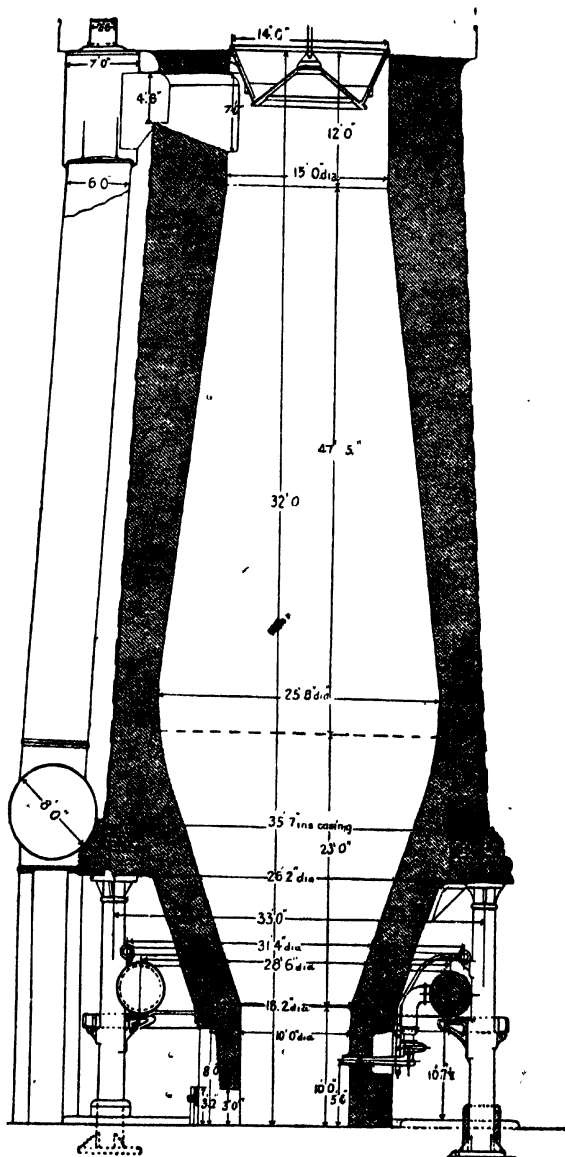
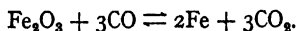

FIG. 68.—Sectional Elevation of Cleveland Blast Furnace.
 (From Sexton and Primrose's *Metallurgy of Iron and Steel.*)

ECONOMY IN MANUFACTURE OF IRON AND STEEL

- (2) The ferric oxide in the ore is reduced, principally by interaction with the carbon monoxide in the gases, as the materials descend the shaft of the furnace, yielding ultimately spongy iron and carbon dioxide, in accordance with the reversible system—



This reducing action begins in the furnace at a temperature of 300° C. and continues up to, and probably beyond, 800° C.

- (3) The spongy iron is impregnated with carbon, chiefly as the result of the catalytic decomposition of carbon monoxide at comparatively low temperatures in the furnace shaft—

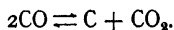

- (4) A certain proportion of the silica and phosphoric anhydride in the charge is reduced by solid carbon at the high temperatures prevailing in the lower regions of the furnace. No doubt also the reduction of the oxide of iron is completed in this way.
- (5) The limestone (CaCO_3) is decomposed into lime (CaO) and carbon dioxide, principally at temperatures between 800° and 900° in the "upper middle" region of the furnace. The carbon dioxide so liberated mixes with the ascending furnace gases, and participates with them in the changes occurring in the upper regions of the furnace.
- (6) The CaO resulting from (5) subsequently fluxes both with the matrix of the ore and with the ash in the fuel, at the highest temperatures prevailing in the lower regions of the furnace, forming the slag, which is essentially an alumino-silicate of calcium.
- (7) The incombustible solid constituents of the charge, after undergoing the aforesaid reduction or decomposition in the shaft of the furnace, are all ultimately brought into a state of fusion as they pass through the zone of highest temperature in the neighbourhood of the tuyères, and leave the furnace either as (a) molten pig iron or (b) the slag.

COAL AND ITS SCIENTIFIC USES

(C) *The Products leaving the Furnace, per Ton of Pig Iron, are—*

- (1) 20 cwt. of molten pig iron, containing 92 per cent. of Fe, and 3.2 per cent. of carbon;
- (2) 35 cwt. of molten slag (CaO = 34.3, MgO = 7.2, FeO and MnO = 2.1, Al₂O₃ = 25.7, and SiO₂ = 30.7 per cent.);
- (3) 185,700 cub. ft. (at 15° C. and 760 mm.) of gas, at a temperature of 250° C., containing—

CO₂ = 10.0, CO = 30.0, H₂ = 1.0, and N₂ = 59.0 per cent.

Its *net* calorific value = 100 B.Th.U.s. per cub. ft. at 15° C. and 760 mm.

(D) *Heat Account of the Furnace.*

Although as high a ratio of CO : CO₂ as 3.0 considerably exceeds the practical limit of 2.0, as defined by Lowthian Bell more than forty years ago, it is nevertheless typical of present-day Cleveland practice, which aims at larger weekly outputs per furnace than formerly was the rule. Comparing now, from the foregoing conditions, the amounts of energy represented by the ingoing coke and hot blast with that represented by the outgoing hot gases per ton of iron produced, we get—

	B.Th.U.s.
(1) Heat of Combustion of 1.125 tons of Coke containing 89 per cent. of Carbon	32,610,000
Sensible Heat in Hot Blast at 725° C. . . .	3,298,000
	35,908,000

	B.Th.U.s.
(2) Heat of Combustion of 185,700 cub. ft. of Gas	18,570,000
Sensible Heat in the Gas at 250° C. . . .	1,477,000
	20,047,000

It is thus seen that the heat of combustion of the exit gas (not counting its sensible heat) is equivalent to rather more than half of the total energy supplied to the furnace in the form of coke and hot blast, and to no less than 57 per cent. of the heat of combustion of the coke.

ECONOMY IN MANUFACTURE OF IRON AND STEEL

(E) *Hourly Production of Gas in a Furnace making 1000 Tons of Pig Iron per Week.*

A furnace making 1000 tons of pig iron per week (or, say, 6 tons per hour) under the aforesaid conditions, would produce $185,700 \times 6 = 1,114,200$ cub. ft. of gas at 15° C. and 760 mm. per hour. This on combustion would develop 111,420,000 B.Th.U.s., and its sensible heat on leaving the furnace at 250° C. would amount to a further 8,862,000 B.Th.U.s., or a total of as nearly as possible 120,000,000 B.Th.U.s. Neglecting its sensible heat, and assuming that in a gas engine the energy developed by its combustion could be converted into mechanical power with an efficiency of 25 per cent., it would be capable of developing continuously—

$$\frac{111,420,000}{2564 \times 4} = 10,864 \text{ B.H.P.}$$

When it is realised that the total output of pig iron from British furnaces in the year 1913 was 200,000 tons per week, or 200 times the output of such a furnace as the above, the enormous fuel value of the whole gas production will be appreciated.

(F) *Comparison of Foregoing Calculations with the Heat Balance of a Staffordshire Furnace.*

Although the foregoing figures relate to a furnace smelting calcined Cleveland ironstone, they lead to nearly the same conclusions, as regards the proportion which the energy in the exit gases bears to that of the coke charged, as does the heat balance of a Staffordshire furnace smelting mill cinder at Darlaston published by Mr. W. J. Forster in the year 1904.¹

This furnace was 72.5 ft. high (capacity 16,000 cub. ft.), and, with blast preheated to 454° C., it consumed 1.46 units of coke (1.285 units of carbon) per unit of pig iron (containing Fe = 90.78, C = 3.5, Si = 3.25, P = 1.49, S = 0.03, and Mn = 1.05) produced. The total make of pig iron amounted to 78.25 tons per day, or 537.6 tons per week. The following figures, summarised from Mr. Forster's results, show the percentage distribution during the smelting process of the energy represented by the total heat of combustion of the coke charged into the furnace.

¹ *Journ. Iron and Steel Institute*, 1904, I. p. 314.

COAL AND ITS SCIENTIFIC USES

	Percentage of Total Heat of Combustion of the Coke.
Heat used in effecting Chemical Changes	23.9
Heat in Molten Iron and Slag obtained	8.4
Heat dissipated by Radiation, Water-cooling, etc.	7.8
Heat of Combustion of the Gases evolved	52.5
Sensible Heat in Gases evolved	7.4
	59.9
	100.0

UTILISATION OF BLAST-FURNACE GAS

Although it is recorded as long ago as 1814 that the waste gases from blast furnaces had been employed by M. Aubertot in France for making steel by the cementation process and for the burning of bricks,¹ it was not until the year 1837, when Dufaur drew attention to the matter, that ironmasters began to realise the enormous amount of energy daily wasted by allowing the gases to burn as they issued from the furnaces. And even then it needed the classical investigations of Bunsen upon the furnace gases at Verkerhagen in 1838, followed by those of Bunsen and Playfair at Alfreton (Derbyshire) in 1845, to arouse any real interest in the problem of applying them generally to any practical purpose.

Bunsen and Playfair, in their Report to the British Association at Cambridge in 1845 upon the "Gases evolved from Iron Furnaces," made the following very pointed comments:—

"Hence it follows that hot-blast furnaces fed with coal² are peculiarly adapted for the economy of gaseous fuel, which may be conducted from the furnace and applied without in any way interfering with its operations.

"We have already shown, in the very lowest calculation, that at least 81.54 per cent. of valuable fuel must escape from the mouth of the Alfreton furnace. Now, as about 14 tons of coal

¹ *Vide* Prof. Thomas Turner's book on *Iron* (Griffin & Co.), 2nd ed. (1900), p. 26.

² The Alfreton furnace investigated was 40 ft. high, with a diameter of 11 ft. at the boshes, narrowing to 3½ ft. at the throat, and the fuel used was raw coal. Bunsen and Playfair reported the volumetric composition of the exit gases to be as follows:—

CO₂ = 8.370, CO = 26.846, CH₄ = 2.536, H₂ = 1.126, C_nH_m = 0.112,
H₂S = 0.045, NH₃ = 0.058, and N₂ = 60.907 per cent.

ECONOMY IN MANUFACTURE OF IRON AND STEEL

are used in that furnace every twenty-four hours, it follows, according to our experiments, that 11.4 tons of coal are lost every twenty-four hours by escaping in the form of gases still capable of being used as excellent fuel."

During the following fifteen years some progress was made in the direction of utilising the gases, principally for raising steam in boilers, and also to some extent for heating the blast. In 1845 J. P. Budd of Ystalyfera patented a stove, for heating the blast, which was fired by the furnace gases, and later on he successfully employed them for firing boilers. It is also said that iron ore was calcined by means of blast-furnace gases as early as 1852 at Coltness in Scotland. In 1850 G. Parry introduced at Ebbw Vale the now commonly used "cup and cone" device for closing the throat of the furnace, so that the gases, instead of burning to waste, could be conducted away by a wide tube inserted just below the cone to any point where they may be conveniently utilised.

The independent inventions by E. A. Cowper and Thomas Whitwell, during the years 1860-5, of hot-blast stoves fired by the furnace gases upon the regenerative principle, were not only a great advance upon any previous attempts to utilise the gases, but also enabled ironmasters to preheat the blast to much higher temperatures than had formerly been possible in the old pipe stoves. Fig. 69 shows a Cowper Stove in vertical section. The general adoption of these stoves immediately resulted in much larger weekly furnace outputs, together with a marked decrease in the coke consumption in the furnace per ton of iron produced.

Up to the end of last century no further new departure was made, and the distribution of the furnace gases on a blast furnace plant during the period 1875 to 1900 would usually be somewhat as follows :—

- (1) 40 per cent. would be used for heating the blast in the stoves;
- (2) 10 per cent. would be lost at the bell; leaving
- (3) 50 per cent. to be used for steam-raising in Lancashire boilers, fitted with special combustion chambers, to drive the blowing engines, furnace hoists, etc.

The utilisation of the gases by such methods was always greatly impeded by the fact that they left the furnace laden with

COAL AND ITS SCIENTIFIC USES

dust, some of which was deposited both in the boiler tubes and on the checker-work of the hot-blast stoves, where it hindered

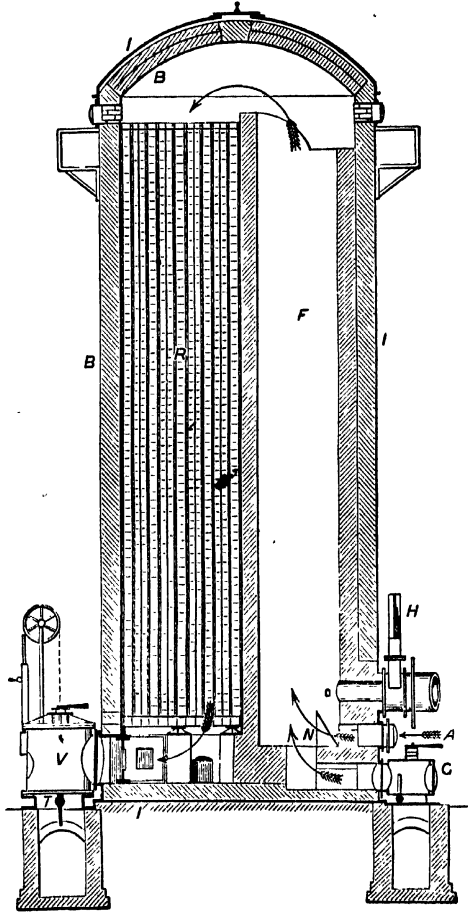

FIG. 69.—Cowper's Stove (Vertical Section).
(From Phillips and Bauerman's *Elements of Metallurgy*.)

the heat transmission. Moreover, the gas-firing of Lancashire boilers is at best inefficient.

Steam-raising in Boilers.—It has been estimated that with

ECONOMY IN MANUFACTURE OF IRON AND STEEL

the best type of water-tube boiler no more than 54 per cent. of the heat developed by the combustion of the gas was actually transmitted to the water, and that the combined efficiency of the boiler and steam-blowing engine did not exceed 6.732 per cent. And according to the author's own observations upon the utilisation of the gases under Lancashire boilers fitted with economisers, the efficiency realised under the best working conditions (*i. e.* using softened water, and after the boiler flues have been recently cleaned) does not exceed 60 per cent. of the heat developed by their combustion.

Heat Balances of Hot Blast Stoves.—According to an investigation carried out in 1915 by Mr. R. S. G. Knight (then a research student in the Department of Chemical Technology at the Imperial College of Science and Technology) upon the combustion of the gas in a modern Cowper hot-blast stove at the Skinningrove Ironworks, the heat balance, when working on uncleaned gas entering the combustion chamber at an average temperature of 240° C., was as follows:—

<i>D.</i>	<i>Cr.</i>
Sensible Heat in the Gas at 240° C. 7.3	Heat transmitted to Blast . . . 65.9
Heat of Combustion of the Gas 92.7	Heat carried off by Burnt Gases at 366° C. 29.1
Total <u>100.0</u>	Loss by Radiation 5.0
	Total <u>100.0</u>

The average composition of the burnt gases was—

$$\text{CO}_2 = 15.2, \text{O}_2 = 7.4, \text{and N}_2 = 77.4.^1$$

DEVELOPMENT OF THE LARGE GAS ENGINE FOR CLEANED BLAST-FURNACE GAS

Up to the end of last century, and until the development of the large gas engine for power generation in steel works had brought the recognition of the enormous advantages to be gained by concentrating coke ovens, blast furnaces, steel works, and rolling mills on one and the same site, there was no great incentive for ironmasters to improve the old methods for utilising the waste gases from their blast furnaces. For without any new

¹ *Iron and Steel Inst. Carnegie Scholarship Memoirs*, VII. (1916), pp. 83-99.

COAL AND ITS SCIENTIFIC USES

departure they could heat the blast, get all the power required for driving the blowing engine and doing other mechanical work connected with a blast-furnace plant, and still have a margin of gas to spare, for which, so long as the plant remained an isolated smelting unit, there was hardly any profitable use to be found.

The advent of the large gas engine, as an adjunct to the blast furnace, at the beginning of the present century suddenly transformed the whole aspect of the industry in regard to power production and fuel economy, and it will now be our business to trace the course of the rapid developments which have followed thereon.

Although blast-furnace managers must long have been aware of the possibilities of the gas if it could be used for power generation in an internal combustion engine, it was not until the year 1895 that any serious attempt was made to realise them in practice. Three *a priori* objections were usually raised, which, taken together, were regarded as serious enough to justify a policy of inactivity, namely—

- (1) It was considered that the low calorific value of the gas, together with the fact that its combustible part is almost wholly made up of the slow-burning carbon monoxide, would cause uncertainty of ignition in the engine cylinder.
- (2) The fact that the gas leaves the furnace at 250° C. highly charged with dust, which unless removed would be a fruitful source of trouble in the engine, was held to be a formidable obstacle to its utilisation. The problem of effectually cleaning and cooling such enormous volumes of gas as would continuously be required by a large power station would, it was thought, involve such a great capital outlay and working expenses as would largely counterbalance the prospective benefits accruing from the greater economy of the gas engine as compared with the existing steam-power installations.
- (3) The alleged relative unreliability of the gas engine in sufficiently large enough units for steel-works power purposes.

The experience of the past twenty years has, however, proved that all such objections were either entirely groundless or had no more than a temporary significance. The force of (1) dis-

ECONOMY IN MANUFACTURE OF IRON AND STEEL

appeared as soon as it was recognised that the thermal efficiency of a gas-engine cycle depends primarily upon the compression of the charge at the moment of ignition. Moreover, it happens that, owing partly to the higher temperature of ignition of carbon monoxide as compared with, say, hydrogen, and doubtless also partly to its containing so much carbon dioxide and nitrogen, an explosive mixture of blast-furnace gas and air will stand a high degree of compression without danger of pre-ignition in the engine cylinder. Also, the slower burning nature of carbon monoxide, as compared with either hydrogen or methane, make it in some respects an ideal gas-engine fuel.

To the late Mr. B. H. Thwaite undoubtedly belongs the credit of first demonstrating, in the years 1894-5, the practicability of generating power from blast-furnace gas in an internal combustion engine. Having previously satisfied himself that a synthetic gas similar in composition to that obtained from blast furnaces, and containing as much as 12 per cent. of carbon dioxide, could be used with no misfires in an engine, he patented his idea in May 1894 (No. 8670 of 1894).

Soon afterwards (Feb. 1895), with the help of the late Mr. James Riley, he put down a small horizontal 15 H.P. Acme 4-cycle engine, coupled with a direct-current dynamo, at the Wishaw Ironworks, near Glasgow, and successfully drove it with cleaned gas from the coal-fed blast furnaces of the following average composition:—

$$\begin{aligned} \text{CO}_2 &= 6.22, \text{CO} = 26.23, \text{H}_2 = 4.65, \text{CH}_4 = 3.18, \\ &\text{and N}_2 = 59.72 \text{ per cent.} \end{aligned}$$

The consumption of gas in two different tests amounted to 105 and 138 cub. ft. respectively per E.H.P. generated.

In 1897, at Frodingham, he successfully ran a similar engine on gas from an ordinary coke-fed blast furnace containing—

$$\text{CO}_2 = 6.0, \text{CO} = 27.3, \text{H}_2 = 1.5, \text{and N}_2 = 65.2 \text{ per cent.}$$

In 1899 he put down his first large engine (100 H.P.) from blast-furnace gas at Sheepbridge.¹

¹ The author is indebted to Mr. W. H. Booth, who witnessed these early experiments, for much of this information. The reader is also referred to (1) *The Iron and Coal Trade Review* of Nov. 16, 1894, (2) a paper by Prof. Watkinson before the West of Scotland Iron and Steel Institute on March 15, 1895, and the discussion thereon, and (3) to statements made during a discussion at the Iron and Steel Institute in July 1906 (*Journ. Iron and Steel Inst.*, 1906, III., p. 155), for fuller information about Mr. Thwaite's work and claims in this connection.

COAL AND ITS SCIENTIFIC USES

But whilst Thwaite's idea met with small encouragement from his own countrymen, it was eagerly taken up on the Continent, especially by MM. Bailly and Kraft, under the leadership of the late M. Adolphe Greiner,¹ at the Seraing works of the Société Cockerill in Belgium (Dec. 1895 onwards), and later (1898) by German engineers at the Hoerder Works near Dortmund.

The subsequent rapid development of the large gas engine for blast-furnace gas was largely due to M. Greiner and the Belgian engineers associated with him. In 1900 the Société Cockerill exhibited a 600 nominal H.P. single-cylinder engine at the Paris Exhibition, which on trial developed 670 B.H.P. with a thermal efficiency of 25.2 per cent., whilst in 1904 the same Company installed at their own works a 1400 nominal H.P. two-cylinder tandem engine, which on trial with blast-furnace gas developed 1582 B.H.P. with the remarkably high efficiency of 29.84 per cent.²

THE CLEANING OF BLAST-FURNACE GAS

Simultaneously with these developments, the problem of effectively cleaning blast-furnace gas on a large scale for power purposes had to be tackled. The gas as it leaves the furnace, at a temperature between 200 and 300° C., is heavily charged with dust, the coarser and heavier portions of which are deposited in the "dust catchers" inserted in the main down-coming pipe from the furnace, as well as in the flues leading therefrom. But there remain on an average about 5 grams per cubic metre of finer dust which is never so removed. Before the gas can be used in large engines it must be cooled down to below 20° C., and its dust content reduced to something like 0.01 gram per cubic metre.

One of the most successful solutions of the cleaning problem was due to E. Theissen of Munich, who devised an apparatus (Figs. 70 and 71) in which a drum is rotated at a speed of from 300 to 400 revolutions per minute within an outer slightly tapering fixed casing of circular cross-section. The circumference of the drum is provided with a number of inclined spiral vanes, the

¹ It is pleasing to note that M. Greiner in his Presidential Address to the Iron and Steel Institute in 1914 paid a well-deserved tribute to the pioneering work of Mr. B. H. Thwaite, adding that his "untimely death prevented him from reaping the fruits of his investigations" (*Journ. Iron and Steel Inst.*, 1914, I., p. 43).

² Vide a paper by Prof. H. Hubert, *Journ. Iron and Steel Inst.*, 1906, III., pp. 16-35.

ECONOMY IN MANUFACTURE OF IRON AND STEEL

effect of which is to make the gas take a long spiral course through the tapering annulus between the drum and the outer casing.

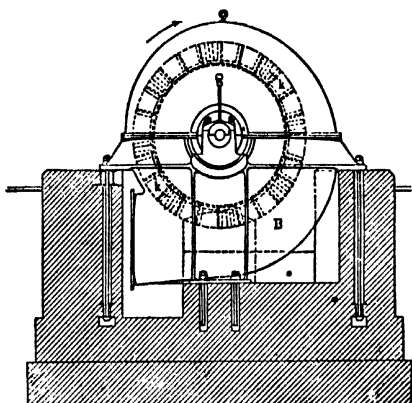

FIG. 70.—Theissen Washer (End Elevation).

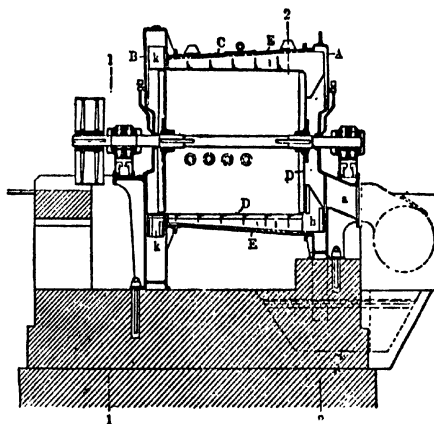

FIG. 71.—Theissen Washer (Side Elevation.)

Water is forced tangentially into the apparatus, and made to travel through the annulus in a contrary direction to that of the gas. Theissen washers are now made in sizes which will clean up to a million cubic feet of gas per hour, and reduce the

COAL AND ITS SCIENTIFIC USES

dust content down to the aforesaid limits. The power expended in cleaning the gas may be taken as about 5 per cent. of that developed from it in the engines, and the water consumption is about one litre per cubic metre of gas.¹ But a process of wet-cleaning, involving, as it must always do, a considerable expenditure of water, and the employment of settling tanks for the troublesome slurry produced, cannot be considered as finally satisfactory. Also, except for that portion of the gas intended for the gas-engines, the dissipation of the sensible heat in the gas by water-cleaning involves an unnecessary loss of energy.

Processes of dry-cleaning, such for example as the Beth-Halberg system, in which the gas is filtered through a special fabric, have also been successfully developed within recent years; but many competent judges consider it probable that the final solution of the problem will eventually be found in some electrostatic system, at any rate, for all but the finest part, if not for the whole, of the dust, and it is, therefore, in some such direction that future progress may confidently be looked for.

REGENERATIVE BY-PRODUCT COKE OVENS AS AN ADJUNCT TO THE BLAST FURNACE

Suppose now that the whole of the coke put into the blast furnace referred to in the preceding paragraph is made from a Durham Coking Coal in a battery of by-product ovens of the regenerative type erected on a site adjacent to the furnaces. Then to produce 6 tons of pig iron (*i. e.* the hourly output of a furnace making 1000 tons per week), about 9.6 tons of coal must be carbonised in the ovens, which would yield $5000 \times 9.6 = 48,000$ cub. ft. of surplus "debenzolised" coke-oven gas of average *net* calorific value 430 B.Th.Us. per cub. ft. The combined hourly outputs of blast-furnace and coke-oven gases resulting from the dual operation would therefore be:—

	B.Th.Us.
1,114,200 cub. ft. of Blast-furnace Gas	= 111,420,000
48,000 " " " " Coke-oven Gas	= 20,640,000
	<hr style="width: 100%;"/>
• Total B.Th.Us.	= 132,060,000
	<hr style="width: 100%;"/>
	(per hour).

¹ For further details of the Theissen Washer see a paper by K. Reinhardt in the *Journ. Iron and Steel Inst.*, 1906, III., pp. 47 to 50.

ECONOMY IN MANUFACTURE OF IRON AND STEEL

This amount of heat is equivalent to the heat of combustion of 4.55 tons of coke or 67 per cent. of that charged into the blast furnace to make the iron. So that if 22.5 cwt. of coke be charged into the furnace per ton of pig iron produced, the heating value of the combined blast-furnace and surplus coke-oven gas is equivalent to 15 cwt. of the same coke.

THE ORGANISATION OF A MODERN IRON AND STEEL PLANT WITH A VIEW TO FUEL ECONOMY

The British iron and steel industry still labours under a disadvantage compared with its German rival on account of its much earlier development. We built and organised most of our blast-furnace plants and rolling mills during the "iron age," in the years preceding the epoch-making inventions of Bessemer and the Siemens brothers, which ushered in the "steel age" in the early eighties of last century, and before by-product coking methods had been developed. It then mattered little whether or not the smelting of iron was carried out on the same site as the subsequent manufacture of rails and plates, on the one hand, or that of coke on the other.

The modern German industry took its rise *after* the inventions referred to, when the great advantages of close proximity of blast furnaces, steel works, and rolling mills were so manifest that all subsequent installations of plant were expressly planned and laid out so as to secure them. Consequently, whereas practically all the great German works erected during the past thirty years have from the outset embodied and profited by these advantages, most of the older British plants have had to be gradually re-modelled, as circumstances permitted, so as to conform, as nearly as possible, to the new conditions. And as such a change will necessarily take time, there are still many of our works that have not either undergone or completed the change.

In times past, and before the aforesaid advantages had become so obvious as they are now, the blast-furnace plant was frequently isolated both from the steel works and rolling mills on the one hand, and from the coke ovens on the other. Coke was always manufactured, as it still is in many places, at the pit-head in beehive ovens and then railed to the blast furnaces. The pig iron made in the blast furnace was then sent (often cold) to the steel works, where it was converted into steel and the latter subsequently rolled into girders, plates, rails, etc., operations

COAL AND ITS SCIENTIFIC USES

necessitating a considerable additional expenditure of fuel. For this purpose raw coal was gasified in producers at the steel works and a further quantity of it was also burned under boilers to provide steam power for driving the rolling mills.

For every ton of iron produced in the blast furnace, 1.75 tons of raw coal would be coked in beehive ovens at the collieries, and a further 0.75 ton, at least, had to be consumed at the steel works and in the rolling mills, involving in all an expenditure of not less (and often much more) than 2.5 tons of raw coal per ton of finished steel sections produced. This old procedure is represented diagrammatically in Fig. 72.

The introduction of by-product coking methods, the development of the large gas engine for blast-furnace gas, and of methods for cleaning the latter on a large scale for both power and heating purposes, and lastly the recent invention of suitable machinery for electrically driving the rolling mills, have entirely changed the whole complexion of the case, and inaugurated a new era in fuel economy in the manufacture of iron and steel of which we, in this country, are only beginning to reap the full benefit.

The advantages of concentrating by-product coke ovens, blast furnaces, steel works, and rolling mills on one plant, coupled with the utilisation of the combined surpluses of coke-oven and cleaned blast-furnace gases, partly in large gas engines driving dynamos generating electrical energy for driving the rolling mills and all other machinery on the plant, and partly also to displace producer gas as a fuel for the steel furnaces and rolling mills, became manifest during the early years of the present century, largely as the result of Continental experience (*i. e.* in Germany, Austria, and Belgium).

It has been the author's privilege during recent years to see these new possibilities demonstrated at the Skinningrove Iron and Steel Works, which have been re-modelled and extended, after a careful study of the best British and Continental practice, under the direction of Mr. T. C. Hutchinson, who brought to bear upon the task a life's experience in the pursuit of fuel economy in connection with blast-furnace smelting.

In 1910 Mr. Hutchinson, in his presidential address to the Cleveland Institution of Engineers, predicted, as the result of his investigations both abroad and in his own works, that, with a proper concentration and arrangement of the various parts of the producing units, *the time would shortly come when iron-stone would be brought in at one end of the works and finished steel*

PRODUCTION OF FINISHED STEEL ON OLD PLAN.

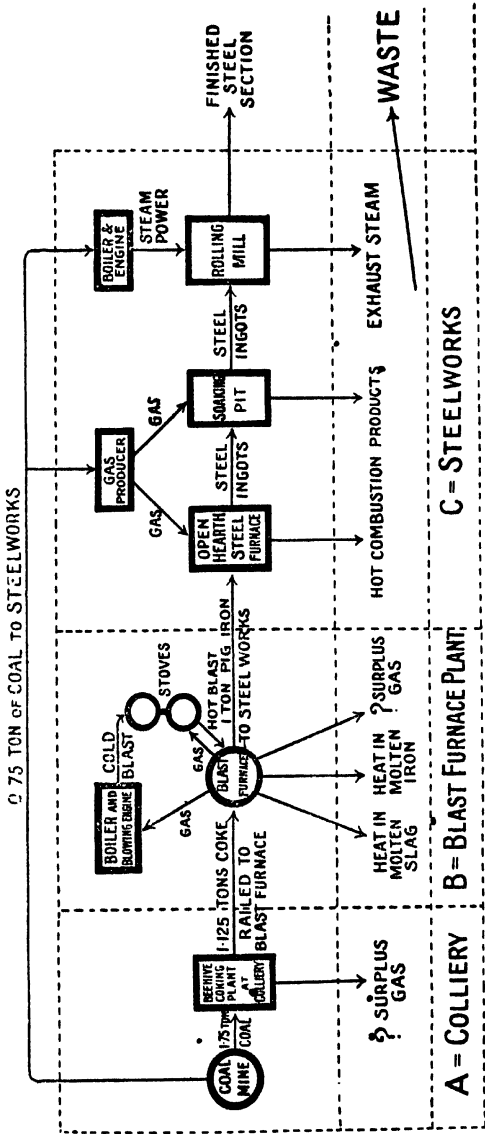

Fig. 72.

COAL AND ITS SCIENTIFIC USES

would be turned out at the other, only such coal being used as was required for the coke ovens to make sufficient coke to smelt the ironstone; and in September 1913 he repeated this prophecy in the course of a discussion at the Brussels Meeting of the Iron and Steel Institute. With his kind permission, the author was able to give supporting evidence and calculations both in a paper read before the British Association in 1913, and again in his Lectures on Fuel Economy before the Royal Institution in 1916.

The cardinal feature of this new development is the aforesaid concentration of by-product coke ovens, blast furnaces, steel works, and rolling mills on one plant, coupled with the utmost utilisation of the surplus blast-furnace and coke-oven gases for power and heating purposes. When this condition is fulfilled, it should be possible, under the new arrangements hereinafter outlined, to produce a ton of finished steel section from Cleveland ironstone and Durham coke, with the expenditure of not more than 1.6 tons of coal, as sketched in Fig. 73.

CONDITIONS TO BE FULFILLED FOR THE REALISATION OF THE MAXIMUM OF ECONOMY

For the realisation of the large economies outlined in the preceding paragraphs it is either necessary, or desirable, that certain conditions should be fulfilled. Broadly speaking, these may be summarised as follows:—

- (1) By-product coke ovens, blast furnaces, steel works, and rolling mills must all be concentrated on one site, and suitably laid out thereon in relation to each other.
- (2) The by-product coke ovens must be of the regenerative type, so as to yield the largest possible surplus of gas, which may be debenzolised.
- (3) The coal charged into the ovens should contain not more than 10 per cent. of ash, and 7 per cent. of moisture. The volatile matter in the dry coal should preferably be between 25 and 28 per cent.
- (4) The quenched-coke for the blast furnace should not contain more than 2 per cent. of moisture, and the breeze (below $\frac{1}{2}$ in.) should be removed and utilised in the calcining kilns or otherwise.
- (5) The blast furnaces should be fitted with double bells, in order to minimise loss of gas, and there should be proper

PRODUCTION OF FINISHED STEEL ON NEW PLAN

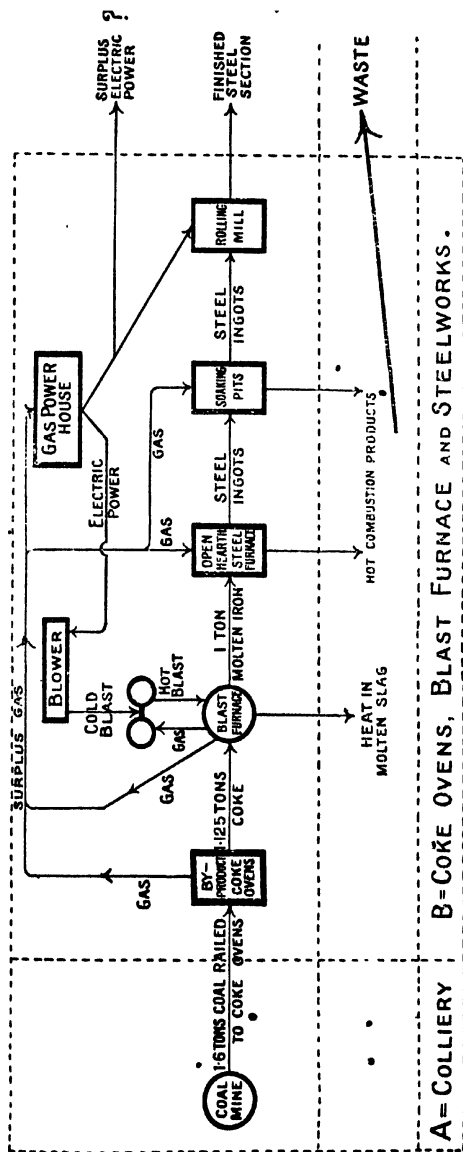

Total Coal Consumed = 1.6 tons.

FIG. 73.

COAL AND ITS, SCIENTIFIC USES

distribution in the furnace of the material (ore, limestone, and coke) by means of a suitably dimensioned bell.¹

- (6) The blast should be generated by means of a gas-driven blowing engine.
- (7) The furnaces should be driven by blast at low pressure (6 lb. per square inch), using large tuyères (7 or 8 in. nozzles), pre-heated to 700° C.
- (8) The gases leaving the furnace should be dry cleaned, preferably by some electrostatic method, so as to reduce the dust to about 0.1 gram per cubic metre, which degree of cleaning is sufficient so far as using the gas in stoves or furnaces is concerned. Such portion of the gas as is used for generating power in gas engines must be cooled to below 20° C., and further cleaned until its dust content does not exceed 0.015 gram per cubic metre.
- (9) The hot blast stoves should be heated by dry-cleaned gas. Three stoves should be used per furnace, two being kept on gas whilst one is on blast.
- (10) If conditions (6), (8), and (9) are fulfilled, the distribution of the gas as between blowing engines, stoves, and available surplus, should be somewhat as follows:—
 - (a) Not more than 20 per cent. for the Blowing Engines, etc.
 - (b) " " " 30 " " " Stoves,²
 - (c) Not less than 50 as surplus for the steel works.
- (11) Assuming a minimum surplus of 50 per cent. of blast-furnace gas available for the steel works and rolling mill, this, together with the surplus gas from the coke ovens,

¹ With regard to the question of bells, it has been variously estimated that the loss of gas at existing single bells amounts to between 5 and 10 per cent. of the whole, and of course it mainly occurs during charging when the bell is lowered. The use of double bells is intended to obviate this. As to the important question of the proper dimensioning of the bell relative to the stock line, Mr. T. C. Hutchinson, in a recent paper before the Iron and Steel Institute (May 1918), showed how in 1884-6, as the results of careful experiments, he had reduced the coke consumption in the Skinninggrove furnaces per ton of pig iron from 23.94 to 22.0 cwts., merely by substituting a 15½ ft. diameter bell for one of 13 ft. diameter. The Blast Furnace Committee of the Iron and Steel Institute have recently laid down the rule that "the area of the brickwork and the bell, when the bell is lowered."

² This is based on a stove efficiency of 66 per cent. with *uncleaned* gas (*vide* Knight's results, p. 403), but if *cleaned* gas were used the efficiency should be higher. If an efficiency of 75 per cent. were realised the amount of gas required for the stove would only be 25 per cent. of the whole. Also it should be possible to utilise some of the waste heat from the stove.

ECONOMY IN MANUFACTURE OF IRON AND STEEL

would make available, as a maximum, the following heat units per ton of pig iron :—

	B.Th.U.s.
92,000 cubic feet of blast-furnace gas	= 9,200,000
8,000 " " " coke-oven gas	= 3,400,000
100,000	Total = 12,600,000
	= 12,600,000

This amount of heat would be equivalent to that in 8 cwt. of an average bituminous coal. But inasmuch as the efficiencies of gas producers and boilers as used in steel works can hardly be put higher than about 75 per cent. (*i. e.* coal to gas or coal to steam), and also as steam engines are less efficient than gas engines, the coal equivalent of the surplus gas should really be counted as at least $8 \times \frac{100}{75} = 10.6$ cwt., and possibly more.

- (12) There should be separate supplies of surplus coke-oven and blast-furnace gases throughout the plant; mixing of the two supplies should be carried out at the several points of consumption as required.
- (13) The gas engine in the power house should be run on cleaned blast-furnace gas only.
- (14) The gas used for the steel furnaces and soaking pits should be a mixture of blast-furnace and coke-oven gases, preferably in such proportion as will yield a heating gas of between 160 and 180 B.Th.U.s. per cubic foot.
- (15) The pitch from the coke ovens should be utilised as fuel, in connection with the steel plant.
- (16) The waste heat in the molten slag from the blast furnace should be utilised.
- (17) The waste heat from the gas-engine exhausts and the steel furnaces and soaking pits should be utilised for steam-raising purposes.
- (18) The rolling mills should preferably be electrically, and not steam, driven.
- (19) There must be scientific management and control from beginning to end throughout the whole heating system, for it is essential that every available heat unit on the plant should be tracked down and effectively utilised to the best advantage.

COAL AND ITS SCIENTIFIC USES

The conclusion that it should be possible, as Mr. Hutchinson predicted, to convert iron ore into finished steel sections using only such coal as is required to make the coke for the blast furnaces, was supported by a very valuable paper on "The Utilisation of Blast-furnace and Coke-oven Gases in Metallurgy," read by E. Houbaer of the Cockerill Company's works at Seraing (Belgium) before the Iron and Steel Institute at the Brussels Meeting in September, 1913. In summarising the results of actual experience gained at the Cockerill works up to that date, M. Houbaer stated that, in the case of a works with a daily production of 1000 tons of pig iron and 1000 tons of coke, assuming the latter all to be made in regenerative ovens and that the available surplus of blast-furnace gas, after providing for leakages and all the furnace services, would be 40 per cent. of the whole output, it might be expected that—

- (1) The blast-furnace gases would supply motive power equal to 28,500 horse-power continuously.
- (2) The daily quantity of coke-oven gas available would allow of the production either of 625 tons of steel in open-hearth furnaces, or the raising to the proper temperature of 1150 tons of ingots or semi-manufactured products in re-heating furnaces.
- (3) The combustion of the pitch from the coke ovens would be capable of producing 150 tons of steel in an open-hearth furnace.

Therefore he concluded that "the tendency of metallurgical works producing coke and pig iron and converting the latter into steel and rolling it in their own mills, should be to cover their fuel requirements solely by the coking coal required from the supply of their smelteries." This is obviously the ideal to which a greater or lesser degree of approximation is being made, according to the varied circumstances which intervene in the most economical running of the plant.

It may be taken for granted that the more advanced and progressive sections of the iron and steel producers in Great Britain have already accepted in principle the views set forth in this chapter, even if circumstances have not yet enabled all of them to translate them into actual practice. It is probable that, with the results of recent experience and research before them, those responsible either for the putting up of new steel

ECONOMY IN MANUFACTURE OF IRON AND STEEL

works or for the re-organisation of old ones, would insist on most of the conditions laid down in the foregoing paragraphs being as far as possible fulfilled. There would, it is almost certain, be general agreement (1) as to the necessity of concentrating coke ovens, blast furnaces, steel works, and rolling mills on one site; (2) that the coke ovens must be of the regenerative type; (3) that the present loss of gas at the blast-furnace tops, which is inevitable so long as single bells are employed, must be diminished; (4) that *all* surplus blast-furnace and coke-oven gases shall be utilised for power and heating purposes in, or in connection with, the steel works and rolling mills; and (5) that, so far as the blast-furnace gas is concerned, this would be best utilised, so far as is possible, for power purposes in gas engines.

Whilst it may be conceded that these five points are of prime and dominating importance, attention may here be drawn to the possible economies which seem to deserve more serious consideration than they have hitherto usually received :—

(a) *The Dry Cleaning of Blast-furnace Gas for Stoves and Heating Purposes.*—When it is realised how large a proportion of the blast-furnace gas is at present burnt in the hot-blast stoves, and that (according to Mr. Knight's determination) at least 30 per cent. of the available heat in the gas so used is lost up the chimney, it is at once evident that there is a considerable margin for further economy in the present method of heating the blast. And probably the best means of saving in this direction would be to clean the gas as it leaves the furnace by some electrostatic method so as not to dissipate its sensible heat. Already promising attempts have been made to subject the gas to a preliminary cleaning in this way, and it does not seem unlikely, that the near future may see considerable further developments. And if the dust in the gas, which, owing to its potash content ought on other grounds to be removed, can be reduced to 0·1 gram per cubic metre, without dissipating the sensible heat, economies in the hot-blast stoves will undoubtedly follow.

(b) *The Utilisation of Waste Heat in Gas Engine Exhausts, and Chimney Gases.*—A careful investigation of the heat balance of a steel-works plant would probably disclose very considerable losses in both these directions. The sensible heat energy of the exhaust gases of a modern gas engine is probably equivalent to between 35 and 40 per cent. of that developed by combustion in the cylinder, and about two-thirds of this is, or should be, recoverable by means of a good waste heat boiler. Similar

COAL AND ITS SCIENTIFIC USES

considerations apply to a considerable part of the heat in the burnt gases from steel furnaces and the like.

(c) *The Utilisation of the Heat in the Molten Slag.*—The proportion which the heat carried off by the molten slag from a modern blast furnace bears to the total heat of combustion of the coke charged into it will obviously largely depend upon the proportion of slag-forming material in the furnace per ton of pig iron produced, and it increases with the leanness of the ore smelted. In a furnace smelting Cleveland ironstone the slag production may be as much as 35 cwt. per ton of pig iron, and as it leaves the furnace at a temperature of 1400° and upwards, the heat loss is considerable.

Sir Lowthian Bell, in his calculations of the heat distribution in the blast furnace, always adopted 550 calories as the heat in 1 gram of molten slag, a number which was based on a calorimetric determination by M. Vathaire. The specific heats of blast-furnace slags have been variously determined as between 0.29 and 0.33, and their latent heats of fusion as between 90 and 120. Taking the means of these determinations, and assuming the slag to leave the furnace at 1400° C. above the atmospheric temperature, we should get for the heat in a unit weight of molten slag $(1400 \times 0.31) + 105 = 539$, which is not very different from Bell's figure.

In the case of the Cleveland furnace referred to, producing one unit of pig iron and 1.75 units of slag for every unit of carbon charged into it as coke, the heat in the molten slag at 1400° C. (943 cal.) would be 11.65 per cent. of the total heat of combustion of the carbon in the coke charged (8080 cal.). In other words, the recoverable heat at present lost in the molten slag for the said furnace is equivalent to that in about 2.62 cwt. of coke per ton of pig iron produced.

Within recent years attempts have been made on an experimental scale to utilise the heat by quenching the molten slag with water and using steam generated in a low-pressure turbine. Particulars of the performance of an experimental plant on such lines at Sir B. Samuelson and Co.'s works at Middlesbrough were published in 1912. It was stated that chemical analysis had shown no trace of sulphuric acid in the water condensed from the steam, and that the amount of sulphuretted hydrogen produced was not sufficient to damage the blades of the turbine. Also that the steam, though almost instantaneously generated, is superheated about 70° Fahr. and that the amount so generated

ECONOMY IN MANUFACTURE OF IRON AND STEEL

from a furnace producing 1800 tons of slag per week could be relied upon to develop 500 K.W. of electric current per hour with an expenditure of 6 H.P. per operating plant.¹

In 1914 Mr. Walter L. Johnson published particulars of experiments made at the Clarence Works of Messrs. Bell Bros., Ltd., Middlesbrough, on the subject.² The method consisted in (1) quenching and granulating the molten slag in water, and (2) using the dirty steam at 100° so generated to evaporate clean water in a Kestner single-effect climbing-film evaporator (heating surface 548 sq. ft.) under a pressure of about 9 in. of mercury (at which water boils at 90° to 91° C.). In this way 91 lbs. of clean water were evaporated from each 100 lbs. of dirty steam generated by quenching the slag,* and the experimental results showed that 855 lbs. of clean steam could be obtained per ton of slag quenched. And, inasmuch as a modern exhaust turbine, working with a full load and under a vacuum of 28.5 in., uses no more than 27 lbs. of steam per horse-power under the said conditions, the available horse-power would be 31.6 per hour per ton of slag. On this basis, the power which could be generated by a Cleveland furnace making, say, 6 tons of iron and 10.0 tons of slag per hour would be 316 H.P.

Mr. Johnson stated that, as the mean result of seven experiments, he obtained 1017 lbs. of dirty steam (at 100° C.) per ton of slag quenched. Assuming that the water was fed into the quenching apparatus at 15° C., these figures enable the following approximate estimate to be made of the proportion which the heat of the molten slag recoverable by such a method of quenching would bear to the total heat of combustion of the coke in respect of a furnace producing 1.75 tons of slag and using 1.125* units of coke (say, 1 unit of carbon) per unit of pig produced.

Heat of Combustion of 1 unit of Carbon = 8080 cal.

1.75 Units of Slag would evaporate $\frac{1017 \times 1.75}{2240} = 0.80$ unit of water.

Heat recovered by quenching = $620 \times 0.8 = 496$ cal.

Therefore, the heat in the molten slag, recoverable by the quenching method in question, would be 6.14 per cent. of total heat of combustion of the coke to carbon dioxide, and, allowing for the subsequent generation of clean steam in the Kestner evaporator employed, the heat finally recovered was as nearly

¹ *Journ. Iron and Steel Inst.*, 1912, I., p. 510; also *Iron and Coal Trades Review*, 84, p. 607.

² *Journ. Iron and Steel Inst.*, 1914, II, p. 98.

COAL AND ITS SCIENTIFIC USES

as possible equal to 5 per cent. of the total heat of combustion of the coke charged into the furnace, or say about 1 cwt. of coke per ton of iron produced.

SOME GENERAL CONSIDERATIONS

In discussing the organisation of an iron and steel works with a view to fuel economy, it is important to take account of certain conditions which have not yet been considered.

In the first place, by no means all the iron produced by the blast furnaces in the kingdom is converted into steel (thus in the year 1913, 10.46 million tons of iron but only 7.66 million tons of steel were produced), and therefore the total thermal value of the blast-furnace and coke-oven gases produced per ton of steel would on the average be greater than the foregoing figures indicate, except in the case of such plants where the whole output of the blast furnace is converted into steel.

Secondly, whereas the blast furnaces and coke ovens work continuously day and night throughout the whole year, the steel furnaces are shut down from 20 to 30 hours each week-end, and the rolling mills often work only one shift per diem. Hence there is always a large surplus of gas at the week-ends which, without special and costly storage arrangements, cannot be utilised in the plant; also when the rolling mill is out of action the amount of gas required for power purposes is considerably reduced. In other words, the problem which confronts the iron-master is complicated by the fact that whereas the production of gas, both at the coke oven and in the blast furnace, goes on fairly uniformly day and night throughout the year, the demands for it are constantly fluctuating.

To provide storage capacity for the millions of cubic feet of surplus gases which are produced on the plant each week-end, when the steel furnaces and rolling mills are using little or none, would probably involve far too great a capital outlay, although M. Houbaer (*loc. cit.*) reported that the Cockerill Company were in 1913 erecting a 50,000 cubic metre (say, 1,650,000 cub. ft.) holder to store coke-oven gas made during the week-end at their works.

The solution of the problem would be extraordinarily difficult were each plant to be treated as an isolated unit. Fortunately, however, it usually happens that a large number of works are all concentrated in a particular smelting area, as in the Cleveland

ECONOMY IN MANUFACTURE OF IRON AND STEEL

District, and by linking them all up, through the medium of a Public Electric Power Company, much can be done towards equalising the load throughout the whole area during six days of the week. Indeed, without some such linking up, it would be almost impossible, even with the most perfect organisation and the most efficient producing units at each isolated works, to achieve the full benefits of the policy outlined in this chapter. Hence the need of some effective co-operation, so far as power services are concerned, between all the producing plants within a given area. This would, however, hardly solve the week-end problem, because all the steel works and rolling mills throughout the area are then requiring but a minimum of power, as also usually are all the other industrial establishments in the area.

CHAPTER XX

ECONOMY OF FUEL ATTAINABLE IN THE BLAST FURNACE BY THE USE OF DRY BLAST

THE present review would be incomplete without some reference to the fuel economies associated with the use of dry blast in the blast furnace.

As long ago as 1853 Prideaux suggested in his book on *Fuel Economy* that the desiccation of the blast would probably result in the saving of coke in iron smelting; and the then Duke of Devonshire, in his Presidential Address at the Inaugural Meeting of the Iron and Steel Institute in 1869, mentioned the effect of great variations in the moisture contained in the air of the blast at different seasons of the year as being one of the important furnace problems which at that time remained unsolved.

In his *Chemical Phenomena of Iron Smelting* (1872) Lowthian Bell referred to the water vapour introduced in the blast as a disturbing agent in the furnace, because of its fluctuating quantity. He said that it lowered the temperature in the zone of combustion, but whether this decomposition of water is a real heat loss over the entire process depends on the extent to which hydrogen reduces the oxides of iron higher up in the furnace. But notwithstanding this, "there is always a serious derangement in the working of the smelting process by the admission of water, due to the fact that heat is absorbed where it is most wanted, and evolved where its presence is a questionable benefit."

In November 1890, W. H. Fryer read a paper before the Cleveland Institution of Engineers on "The Desiccation of the Blast in the Manufacture of Pig Iron," as a means both of increasing the output and making the furnace conditions more uniform.

When it is realised that a Cleveland furnace, working under conditions such as have been described in the foregoing pages, consumes nearly 140,000 cub. ft. at 15° C. and 760 mm. (or

USE OF DRIED AIR IN BLAST FURNACES

nearly 9.65 cwt.) of air per ton of iron produced, and that the amount of moisture in the air varies enormously according to the state of the weather and the season of the year, it is quite clear, that whatever else may be done to secure uniformity of working conditions in the furnace, so long as there is no means of controlling the hygroscopic condition of the blast, the whole smelting process will remain dependent upon the caprice of the atmosphere.

The problem of desiccating such huge volumes of air as are needed to work a modern blast-furnace plant appeared to be almost outside practical politics until Mr. James Gayley of New York, in two papers before the Iron and Steel Institute in 1904-5,¹ brought forward some remarkable, not to say astonishing, figures as to the fuel economies which had resulted from the experimental adoption of dry blast at the works of the Carnegie Steel Co. at Etna, Pittsburg.

The nature of these results will be sufficiently indicated by a description of the first experimental run with dry blast on the Isabella Furnace at the above works in September 1904, confirmed as these were by more thorough and extensive trials in the following year.

The furnace in question (height = 90 ft., diameter at boshes = 21 ft., capacity = 18,090 cub. ft.) smelted a mixture of Mesabi and Michigan hæmatite ores, containing 53.5 per cent. of iron, with coke containing between 10.5 and 12.5 per cent. of ash. In accordance with the usual American practice of hard driving and big outputs, it was blown through twelve 6-in. tuyères, with blast at 12 to 15 lbs. per sq. in. pressure, preheated to 850° Fahr., and it produced a basic iron with as low a percentage of silica as possible consistent with the essential low sulphur content.

The experiment in question extended altogether over a period of forty days, divisible into three, namely:—

(a) 1st to 4th August 1904.—Furnace blown with normal (*i. e.* undried) blast, with a burden proportioned as follows:—

Coke = 10.0, Ore = 20.0, Limestone = 5.0.

During this period the moisture content* of the blast varied between 3 and 8 (mean = 5.56) grains per cub. ft., and with an average blast temperature of about 720° Fahr., the average daily output of pig iron was 358 tons, with a coke consumption of 2147 lbs. per ton.

¹ *Journ. Iron and Steel Inst.*, 1904, II, 274, and 1905, I, 256.

COAL AND ITS SCIENTIFIC USES

The waste gases leaving the furnace at 538° Fahr. contained—

$\text{CO}_2 = 13.0$, and $\text{CO} = 22.3$ per cent.

(b) *12th to 25th August.*—An intermediate period during which dry blast was gradually introduced until by 25th August dry blast was being used entirely. The first noticeable effect of gradually drying the blast was a brightening in the zone of combustion in front of the tuyères of the furnace and an increasing temperature of the slag. This was followed by the furnace gradually taking a proportionately heavier burden of ore and limestone, and giving a larger output of iron from the same consumption of coke, until these favourable results reached their consummation during the subsequent run with "all dry" blast.

(c) *25th August to 9th September.*—Furnace blown with blast dried by refrigeration until it contained very uniformly between 1.33 and 1.85 (average 1.75) grains of moisture per cub. ft. The burden was proportioned as follows:—

Coke = 10.2, Ore = 24.0, Limestone = 6.0.

It was found that the speed of the blowing engines, which before applying dried blast were running at 114 revolutions and supplying 40,000 cub. ft. of the air per minute, could be reduced to 96 revolutions per minute, owing to their working on a refrigerated blast; also that the blast temperature on leaving the

TABLE LXXIV

RESULTS OF MR. GAYLEY'S EXPERIMENT WITH THE ISABELLA FURNACE,
PITTSBURG, AUGUST 11 TO SEPTEMBER 25, 1904

Period.	(a) Normal Blast.	(c) Dried Blast.
Average Moisture in Blast. Grains per cubic foot .	5.56	1.75
Average Daily Output of Iron in tons	358	447
Average Coke Consumption. lbs. per ton of Iron .	2147	1726
Temperature of Hot Blast. ° Fahr.	720°	870°
Temperature of Exit Gases. ° Fahr.	538°	376°
Ratio CO/CO_2 in Gases.	1.70	1.25

USE OF DRIED AIR IN BLAST FURNACES

regenerative stoves rose to 870° Fahr. But the most remarkable result of the trial was that, whilst the average daily output increased to 447 tons, the average coke consumption fell to 1726 lbs. per ton. The gases leaving the furnace at 376°, or at 162° lower than in (a) contained—

$$\text{CO}_2 = 16.0 \text{ and } \text{CO} = 19.9 \text{ per cent.}$$

Summarising the whole experiment (*vide* Table LXXIV, p. 424), we find that desiccation of the blast had increased the daily output by about one-third, and at the same time had reduced the coke consumption per ton by about one-fifth, a truly remarkable result.

Astonishing as these results were, they were substantially confirmed by those of a further extended series of trials at the same works during the following winter (October to March), in which two furnaces, Nos. 1 and 3 respectively, were alternately worked on "normal" and "dried" blast; thus (to select two months, November and February, as a typical example):—

TABLE LXXV

Month.	Furnace.	Average Daily Output. Tons.	Average Coke Consumption. lbs. per ton Iron.	Average Blast Temperature.
November 1904	{ No. 1 (Dry Blast)	447	1816	854°
	{ No. 3 (Normal Blast)	386	2279	750°
February 1905	{ No. 1 (Normal Blast)	424	2248	800°
	{ No. 3 (Dry Blast)	412	1815	784°

In 1909 were published the following results of the adoption of dry blast at Messrs. Guest, Keen, and Nettlefold's Dowlais Works, near Cardiff:—

	Weekly Output of Iron. Tons.	Coke Consumption. lbs. per ton of Iron.
Average of 50 Weeks of Normal Blast	2001	2278
Average of 5 Weeks on Dry Blast operated for Increase in Output	2530	1972
Average of 4 Weeks on Dry Blast operated for Economy in Fuel	2286	1857

COAL AND ITS SCIENTIFIC USES

Although the claim that the use of dry blast results in an increased output and a saving of coke in the furnace is now generally admitted, opinion has been much divided as regards (a) the causes of these improvements, and (b) the circumstances which would justify the adoption of dry blast, having regard to the capital involved in installing the necessary desiccating plant.

With regard to the causes of the considerable fuel economy effected, although no complete explanation has yet been given, the following may be assigned as either probable or possible contributory factors, namely:—

(1) That any marked diminution of water in the ingoing blast must of necessity increase the temperature of the zone of combustion in the region of the tuyères, and thus act in the same way as an increase in the blast temperature. And it may here be pointed out that the hot-blast temperature in Gayley's experiments were not very high (720° to 870° Fahr. or, say, 382° to 465° C.), a circumstance which would be likely to accentuate the effect of this cause. In order to understand the full import of this cause upon coke consumption, it must be remembered that when steam reacts endothermically with incandescent carbon at high temperatures producing carbon monoxide and hydrogen, in accordance with the equation—

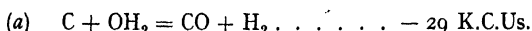

exactly as much heat is absorbed as is generated by the oxidation of the same amount of carbon to the monoxide, thus—



Consequently, when the steam and oxygen in the blast react with the incandescent carbon in front of the tuyères, then for every participating molecule of steam, two atoms of carbon are gasified without producing on the balance any evolution of heat, thus—

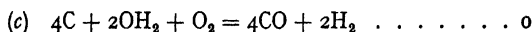

whereas, without the presence of water, the same amount of carbon would on burning to the monoxide evolve 58 K.C.Us.



And, inasmuch as the reducing actions of either carbon monoxide or hydrogen upon the materials in the charge do not come actually into play until temperatures below, say, 1000° C. have

USE OF DRIED AIR IN BLAST FURNACES

been reached, it follows that, so far as the hottest regions of the furnace where the materials undergo fusion are concerned, the presence of a weight unit of water in the blast nullifies, so to speak, the heat-producing power of 1.33 weight units of carbon.

Applying this reasoning to Gayley's experiment of August and September 1904 with the Isabella furnace, where the difference between the "normal" and "dry" blast conditions meant, on the average, the elimination of 69 lbs. of moisture per ton of iron produced, it might possibly account for an average saving of 92 lbs. of carbon (= say, 104 lbs. coke), but no more, per ton of iron produced. The actual saving, however, was as much as 421 lbs., or more than 4.5 times that amount. Clearly, then, whilst the endothermic interaction of steam and carbon in front of the tuyères must be a contributory cause, it is by no means the only, or even the main, one.

(2) Another probable cause is that the higher temperature at which the mixture of carbon monoxide and nitrogen generated at the tuyères would leave the zone of fusion, when most of the water was eliminated from the blast, would almost certainly accelerate its reducing action in passing upwards through the middle region of the furnace. Moreover, the amount of water reformed by the catalytic oxidation of hydrogen higher up in the furnace would presumably be some function of the proportion of hydrogen in the gases leaving the zone of combustion. And O. Boudouard has found that the reduction of oxides of iron by carbon monoxide was stronger when *dry* than when *moist*, and that this difference was most marked at about 400 to 500° C., gradually diminishing as the temperature rises, until at 1050° C. it disappeared altogether.¹ Such considerations as these would indicate that any considerable elimination of moisture from the blast would be very likely to accelerate the reducing action of the furnace gases upon the oxides of iron in the middle and upper regions of the furnace, and thus utilise more of their potential energy. And the fact that in Gayley's experiment the ratio CO/CO₂ in the exit gases fell from 1.7 to 1.25 when the average moisture in the ingoing blast was reduced, from 5.56 to 1.75 grams per cubic foot, may be cited in support of the view.

(3) Many competent judges among blast-furnace managers have expressed the opinion that the main cause of the economy claimed from dry blast is mainly to be found in the greater uniformity in the working conditions thereby established, and

Comptes rendus, 140, p. 40.

COAL AND ITS SCIENTIFIC USES

doubtless this is an important contributory, though by no means the only, factor.

Mr. Gayley himself put forward the view that "the drying of the air not only removes an unfavourable and varying element from the blast, but by keeping the content of moisture in the dry air practically uniform, through refrigeration to a uniform temperature, permits the delivery into the furnace of a practically constant weight of air, and therefore of oxygen—a result which cannot be obtained through an increase in blast temperature. The elimination of moisture removes a heat-extracting element at the tuyères, and, together with the uniform weight of oxygen constantly supplied, intensifies the combustion, and localises the fusion zone. With natural air the fusion zone is constantly fluctuating; when the zone is lowered, incipient scaffolds form on the area through which it is lowered; and when the zone is again raised, these scaffolds are melted loose, and, descending into the hearth, absorb heat. For this purpose alone, a margin of safety in fuel must be carried in the burden."¹

In considering the other important question of the circumstances that would justify the adoption of the Gayley System, it must be remembered that in America, where it has been successful, furnaces are as a rule driven very much harder than in Great Britain. It is not unusual for an American furnace working with high-pressure blast on hæmatite ores, containing between 50 and 60 per cent. of iron, to produce 3000 tons of iron per week, whereas British furnaces, working mainly on much leaner ores, are rarely driven harder than is necessary to obtain an output of 1000 tons per week. And it by no means follows that what is both technically and commercially possible, or feasible, in the one case will be equally beneficial in the other. Each case must be decided after due consideration of the particular local climatic conditions, of the character of both of the ores smelted, and of the product aimed at, as well as of the speed at which the furnace is to be operated.

Thus Dr. Josef von Ehrenwerth of Leoben, after a careful study of the problem from the point of view of Styrian practice, has concluded, in a paper read before the Iron and Steel Institute in 1913,² that "whereas the economical result of drying the blast in some instances is very remarkable, it varies considerably, and the question of introducing dry blast must be

¹ *Journ. Iron and Steel Inst.*, 1906, IV., p. 818.

² *Ibid.*, 1913, p. 118.

USE OF DRIED AIR IN BLAST FURNACES

settled in each case on its own merit. The advantages are dependent in every case on local conditions, such as the dampness of the atmosphere, and the cost and quality of the fuel. They are influenced besides by the kind of product, the quantity of output, the reduction period, and the type of furnace." But, assuming that the average amount of moisture normally present in the atmosphere is high enough, he considered that the use of dry blast would unquestionably be advantageous in the following cases :—

- (a) Where the furnaces are working with high blast temperatures, and correspondingly high waste-gas temperatures, as in smelting ferro-manganese, ferro-silicon, or ferro-chromium ;
- (b) also, where the furnaces, working under conditions similar to (a), produce Bessemer, foundry, or high silicon pig iron ; and
- (c) generally in localities, such as near the sea coast in climates where the atmosphere is normally very moist.

In the discussion which followed Ehrenwerth's paper it was made clear that, so far as British conditions are concerned, the cost of putting down a suitable desiccating plant would in most cases probably outweigh any prospective saving in fuel. Mr. T. C. Hutchinson, who had gone carefully into the question as regards the conditions prevailing in the Cleveland District, had arrived at the conclusion that it would not be "economically wise" to instal the Gayley system there, and, generally speaking, he doubted whether it would be so in Great Britain as a whole.

But, apart from the important question of capital outlay, there is one paramount consideration which, in the author's opinion, ought not to be overlooked. If in a modern steel-producing plant comprising coke ovens, blast furnaces, steel furnaces, and rolling mills, the objective to be aimed at, in the interests of an all-round fuel economy, is such a utilisation of the combined surpluses of coke-oven and blast-furnace gases as will do away with the necessity of gasifying coal in producers, or burning it under boilers, and to use no more fuel than is charged into the coke ovens to make the coke required for the blast furnace, it is obvious that there must be a certain *minimum* quality of blast-furnace gas which is compatible with the attainment of such an ideal.

COAL AND ITS SCIENTIFIC USES

Now in Mr. Gayley's experimental run with dry blast in August-September, 1904, the gas evolved from the furnace was of very poor quality, containing, as it did, no less than 16.0 per cent. of carbon dioxide and no more than 19.9 per cent. of carbon monoxide, instead of the 10.0 and 30.0 respectively usually contained in the gas from a Cleveland furnace. A saving of coke in the blast furnace, if accompanied by the production of a gas of less than a certain limiting CO-content, might be outweighed by the necessity of having to burn more than the equivalent amount of coal elsewhere on the plant. The whole question would, therefore, involve other considerations than the mere saving of coke in the blast furnace, and could only be decided after a very careful review of the requirements of such a plant as a whole.

CHAPTER XXI

POWER PRODUCTION FROM COAL

THE subject of power production from coal is so many-sided that any brief review of it in these pages is bound to be inadequate. Yet, seeing that the omission of any reference to it might be considered as detracting from the complete exposition of the scientific uses of coal, an endeavour will be made in this chapter to give in outline the more salient aspects of the problem, without reference to its technical details.

It has already been explained in a former chapter that were it possible to transform the available energy of coal into mechanical power, without loss of any kind, a horse-power hour would be obtained by the expenditure of about one-fifth of a pound of coal of average quality. Needless to say the attainment of anything like such perfection is altogether precluded, alike by the nature of the materials available for the construction of the various machines which must be used as prime movers, and also by the natural conditions under which they must be operated.

There are two principal ways in which the energy of coal may be converted into mechanical work. One is by raising steam in a boiler, and then utilising as much as possible of the energy of the steam in some form of steam engine, either of the reciprocating or turbine type. The other is by gasifying the coal completely in some form of gas-producer, and then burning the resulting gas in an internal combustion engine. Both these methods are of course imperfect, but it may perhaps be of interest to compare them from the point of view of thermal efficiency.

In the first place, it may be stated that the thermal efficiency of a good modern type of coal-fired boiler is not far short of that of the gasification of coal in a gas-producer, when due allowance is made for the fact that in the latter case it is necessary to clean and cool the resultant gas before it is delivered to the engine. We shall not be far wrong in putting down the efficiency of each method under good working conditions at about 75 per cent.

COAL AND ITS SCIENTIFIC USES

Again, under favourable working conditions, a gas engine will convert about 27 per cent. of the energy of the gas supplied into available horse-power, so that the coal consumption required to obtain a shaft horse-power hour by means of the combination of an efficient gas-producer and a gas engine need not be more than 1 lb.

$$\frac{0.20}{0.75 \times 0.27} = 1 \text{ lb.}$$

Within recent years great advances have been made in the development of the steam turbine. And, according to the published results of trials on the new 35,000 H.P. Parsons turbo-alternator erected at the Fisk Street Power Station in Chicago, the fuel consumption on so large a turbo-steam set (assuming a boiler efficiency of 75 per cent.) has now been reduced to 1 lb. of coal per shaft horse-power hour. Therefore, it would seem that there is now probably little to choose between the thermal efficiencies of the best types of steam and gas systems, each working under the most favourable conditions.

Broadly speaking, the selection of a power scheme in a particular case will usually involve several considerations. First of all, of course, there is the question of the relative thermal efficiencies of the different systems of converting the energy of coal into available power. But this is by no means the only, or in many cases even the most important, consideration. Equally, and sometimes more, important is the further question of the general planning and organisation of the scheme as a whole in regard to capital outlay, running costs, and other conditions of a local character. The question of the ultimate net cost of the power, including cost of fuel, labour, supervision, interest, redemption, and depreciation, must always be the main consideration in any given case, and it by no means follows that the most efficient system from a purely thermal point of view will, under any given conditions, be necessarily the cheapest in the long run.

Bearing this in mind, certain general considerations relative to the rival claims of gas and steam systems in relation to fuel economy may be pointed out. Some years ago, it appeared as if the combination of the gas-producer and internal combustion engine would soon out-distance the boiler and steam engine, partly because of the then much superior thermal efficiency of the internal combustion engine, and partly also because of the capacity of the gas-producer to gasify low-grade coal under

POWER PRODUCTION FROM COAL

ammonia-recovery conditions—two very important considerations. For it must be remembered that a great deal of coal obtained by the miner is so inferior in quality that it does not ordinarily pay to bring it up to the surface, and it is therefore usually left below in the mine. It has been claimed that the gas-producer is more capable than any form of boiler of dealing with such inferior grades of fuel, and, moreover, that it can gasify them under ammonia-recovery conditions. On the other hand, the capital outlay and the ground area involved in the erection of an ammonia-recovery gas-producer plant, as compared

A.

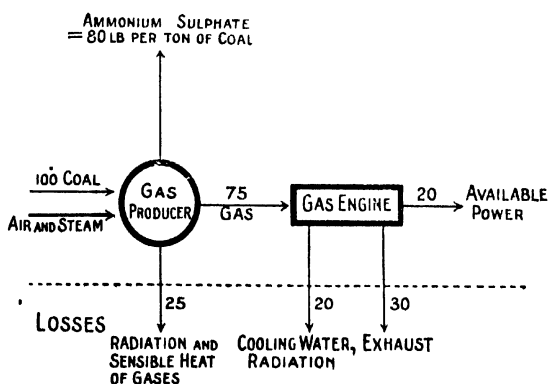

FIG. 74.

with a boiler installation, have hitherto formed formidable obstacles to the extension of the system.

The above diagram (Fig. 74) shows approximately the net efficiency (coal to brake horse-power) of a gas-producer and internal combustion engine combination. Calling the coal energy to be debited against the system 100, the items to be credited to it under full working conditions are 20 in respect of brake horse-power, and up to 80 lbs. of ammonium sulphate per ton of coal gasified. Of the energy losses involved per 100 coal energy, 25 are in respect of radiation and sensible heat of the hot gas at the producer, and approximately 50 at the gas engine—20 in respect of loss in cooling water and radiation, and 30 in respect of the exhaust gases.

COAL AND ITS SCIENTIFIC USES

Now, it is possible to improve this result by coupling the engine exhaust to some form of waste-heat boiler. In connection with the author's investigations upon surface combustion in relation to steam raising, a type of multitubular waste-heat boiler was evolved in which the exhaust gases from an internal combustion engine are passed through tubes packed with granular material, the effect of which is to bring about a very rapid heat transmission between the hot gases and the water in the boiler, so that a considerable proportion of the energy in the exhaust gas is quickly transferred to the water and is obtained in the form of steam. Assuming it to be possible in this way to reduce

B.

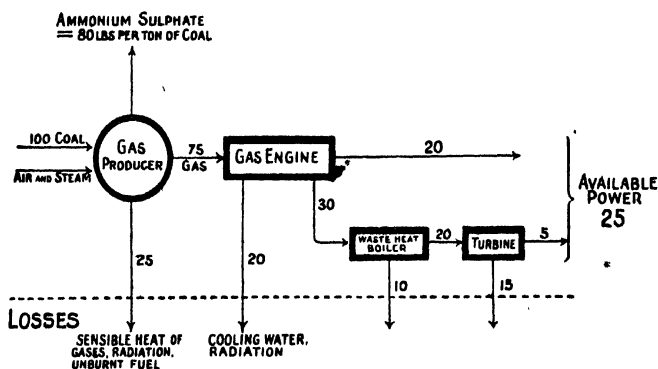

FIG. 75.

the temperature of the engine exhaust (say) from 600° to 200° C., and to generate steam at 60 lbs. pressure for a turbine, the total brake horse-power efficiency of the system might be increased from 20 to about 25 per cent., as shown in Fig. 75.

Turning, now, to the results obtainable from the combination of coal-fired boiler *plus* turbine, which are shown diagrammatically in Fig. 76, it is seen that against the debit of 100 in respect of coal energy, the only credit is 26 in respect of available power, assuming 27 per cent. as the turbine efficiency. There is no possible credit in respect of ammonium sulphate, and, moreover, the boiler should be supplied with a fairly good grade of fuel.

With regard to the gas-firing of boilers, it may be said that until recently such procedure has usually been so inefficient

POWER PRODUCTION FROM COAL

that its adoption on a large scale was out of the question, except where great surpluses of gas were available which would otherwise have been wasted. The invention of the method of burning gases flamelessly in contact with incandescent surface (Boncourt System), by providing a means of achieving both very high efficiencies and evaporative powers with gas-fired multitubular boilers, has completely changed the outlook in this direction.

In view of this new development, the nature of which will be further considered in the next chapter, another effective system of power production may be suggested. The raw coal would, in the first instance, be gasified in a producer under ammonia-recovery conditions; the resulting gas would then be burnt in a surface combustion boiler the efficiency of which with producer gas may be put down at certainly not less than 87 per cent.

C.

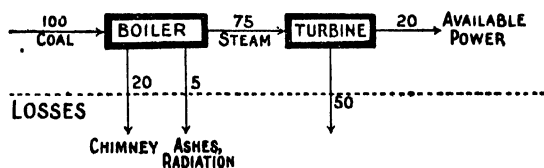

FIG. 76.

The resulting steam would then be turned into a steam-turbine, of assumed 27 per cent. efficiency, whereby a net result of 18 per cent. in respect of power on the available energy of the coal consumed, plus 80 lbs. per ton of ammonium sulphate would be obtained (Fig. 77). So much then for the efficiencies of coal to power energy conversion obtainable, either now or in the near future, with the most modern and scientific apparatus and methods.

With regard to the rival merits of the steam-turbine and internal-combustion engine, which time alone can finally decide, it would seem under present conditions (1) that from the point of view of the size of the units, the turbine has shot far ahead of its rival. The large Parsons turbo-alternator recently installed at Chicago of 35,000 H.P. capacity, far surpasses anything yet attempted with an internal combustion engine unit; (2) that, whereas a gas engine only works at its highest efficiency with a

COAL AND ITS SCIENTIFIC USES

high load factor, a turbine maintains its efficiency over a wider range of load, and at low load surpasses its rival; (3) that a gas engine requires much more lubrication, but, on the other hand, usually less cooling water, than the turbine; and (4) that, owing to its simpler construction, the turbine requires less adjustment and repairs, and is more reliable than its rival.

These considerations have led to the almost universal adoption of the steam turbine for large power stations, except in cases where there are available supplies of surplus gases from coke ovens, blast furnaces, or the like. On the other hand, for smaller generating units—say up to 3000 H.P.—where the load factor is

D.

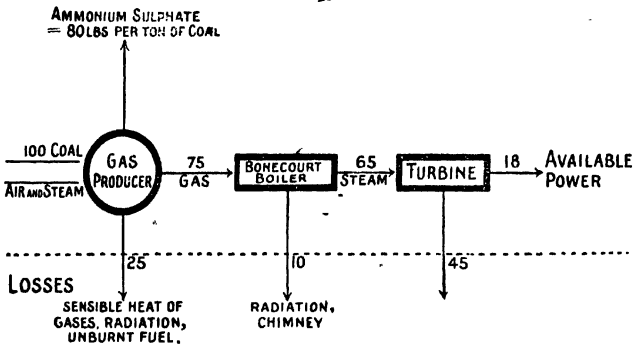

FIG. 77a.

uniformly high and not subject to abrupt variations, the gas engine has certain important advantages which specially apply to power plants in connection with steel works. In any case, however, the choice between the two rival systems will not always be determined on purely thermal considerations, but on other equally important factors.

THE ORGANISATION OF PUBLIC POWER SCHEMES

The recent development of comprehensive electric power schemes in various parts of the world, notably in Chicago (Illinois), on the north-east coast of England, on the Rand, and in certain industrial districts of Germany, has shown that power production in large super-plants, with generating machines of 50,000 H.P. or more, is not only far more economical than in a large number

POWER PRODUCTION FROM COAL

of smaller plants, but will ultimately involve great economies of capital by ensuring a better load and a more effective use of the plant.

Given suitable conditions, there are undoubtedly great advantages to be gained in the way of cheap power production by the co-operation of consumers with a properly organised electric power scheme operating over a large industrial area. And probably no other European country is better adapted than our own for such co-operative schemes, because of the compactness of our great industrial areas, the density of their populations, and their proximities to the coal-fields.

In every industrial area there are factories which under normal conditions work during the day only; others must of necessity work both day and night continuously. In some cases the power requirements are fairly uniform throughout the day's run, whilst in others they are subject to large and abrupt variations.

Some establishments, as, for instance, steel rolling mills, have intermittent loads for short periods far in excess of their average hourly requirements. Others again, such, for example, as isolated by-product coke ovens or blast furnaces, have large surpluses of gas which cannot be fully utilised on the plant itself. Some factories, also, may have surplus energy to dispose of in the form of so-called "waste-heat" or of unutilised "exhaust steam." In every large industrial area there are enormous energy losses continuously going on in different ways, which the individual manufacturer may be unable to utilise effectually himself, but which he would be willing to sell to a public organisation empowered not only to sell electrical energy, but also to purchase surplus gas, waste heat, and exhaust steam from any of its customers, and convert the same into electrical energy for general distribution.

The question of the future of electric-power supply in Great Britain has been the subject of an Interim Report by Lord Haldane's Coal Conservation Committee (of which the author was a member) under the Ministry of Reconstruction, which was issued on December 7, 1917,¹ for the information of the public.

This Report reviews the present position of power generation throughout the Kingdom and makes a number of important recommendations for its future organisation, and the reader will find that the manifold points dealt with therein will amply repay

¹ His Majesty's Stationery Office, 1918, price 3d.

COAL AND ITS SCIENTIFIC USES

a careful perusal in detail. Whilst various considerations preclude any lengthy survey of the subject in these pages, one or two outstanding features of the Report may be mentioned.

In the first place the Committee point out it is only by largely increasing the amount of power used in industry that the average output per individual worker can be increased in this connection. They find that the amount of power used in the United States per worker is on the average 56 per cent. more than in the United Kingdom, and that if workers in trades where the use of power is limited, or even impossible, be eliminated, the figure for the United States would probably be nearly double what it is in this country. They also estimate that if power supply in the United Kingdom were dealt with on comprehensive lines and advantage were taken of the most modern engineering developments, it would be possible either (a) to save 55 million tons of coal per annum on the present output of power and manufactured products, or alternately (b) from the present coal consumption in factories to generate continuously day and night throughout the year, no less than 15 million additional horse-power.

On the assumption that power may be most efficiently applied to industry by the medium of electricity, the Committee are of the opinion that the present system of electrical power distribution throughout the country, which is undertaken by over 600 authorities in as many separate districts, is both technically wrong and commercially uneconomical.

The present average size of generating stations is stated to be only 5000 H.P., or about one-fourth of what should now be the smallest generating machine in a power station. The Committee accordingly made a number of recommendations for the supervision of the present system by a comprehensive scheme for Great Britain, of which the first six may here be quoted :—

- (1) It is essential that the present inefficient system of over 600 districts should be superseded by a comprehensive system in which Great Britain is divided into some sixteen districts, in each of which there should be one authority dealing with all the generation and main distribution.
- (2) Centres, or sites, suitable for electric generating purposes should at once be chosen on important waterways as the future main centres of supply for each of the districts into which the country is to be divided.

POWER PRODUCTION FROM COAL

- (3) The sites so chosen should be as large as possible, having in view the land available in suitable localities, and should have ample water and transport facilities. Land is required, not only for the power stations themselves—which for the sake of security and safety would have to be suitably subdivided, that is, they would not be contained all in one building—but for the processes involved in the extraction of by-products from the coal before it is used for the production of power, where such extraction is found to be justified. It is also required for the development of electro-chemical processes, which may be most conveniently carried on in close proximity to the power plant. This condition entails the sites being chosen outside, not inside, towns. The health of the great industrial centres and the congestion of the railway lines in their neighbourhood would be radically improved by arranging that the conversion of coal into motive power was carried out away from the densely populated centres.
- (4) Plans should be prepared for the construction immediately after the war on these sites of the first instalment of large super-power plants capable, first, of supplying through a comprehensive electric power distribution system which must also be arranged for, the existing demands of the community; and, secondly, of supplying electrical energy at the lowest possible price for new processes and manufactures.
- (5) Such plants would be designed so that, as methods are perfected for extracting by-products from the fuel, before using it for the purpose of the production of electric power, the by-product plant can be combined with the power plant. Each site should be laid out with this in view, and with a view to the unrestricted extensions of the plant as required.
- (6) Power available from surplus gas or waste heat should be turned into electrical energy on the spot in local plants which would feed into the main distribution system. As regards waste coal, *i.e.* coal which it does not at present pay to bring to the surface—this could, where transport was the ruling consideration, also be used on the spot.

The cost of delivering electric current from a public power

COAL AND ITS SCIENTIFIC USES

station to a consumer is made up of two parts, namely, (a) generating costs at the station, and (b) distribution costs. Of these (b) is usually by far the larger item, for it is principally made up of the interest upon the heavy capital expenditure involved in the laying of the main cables. The cost of generating current at a public supply station of average size in this country should not, as a rule, exceed a fraction of a penny. It includes, principally, three items, namely, (i) fuel, (ii) interest and depreciation on capital, and (iii) other charges, such as salaries and wages, lubrication, and repairs to plant.

The pre-war cost of generating electric current at a moderately efficient station in this country (including fuel, interest and depreciation, and all other charges) might be put at between 0.25 and 0.60*d.* per unit, of which the cost of fuel might be reckoned as about half of the total. The increased cost due to the war may perhaps be put at about 50 per cent. of the pre-war figure, so that to-day (1918) the total cost would probably range between 0.37 and 0.90*d.* per unit.

The coal consumed in a fairly efficient station, with a tolerably good load factor, should not exceed 2.25 lbs., or, say, one thousandth part of a ton, per unit of electricity generated, and under the most favourable conditions it might be reduced to 1.75 or even 1.50 lb. per unit. The last-named figure has, indeed, been achieved under the North-East Coast Power Scheme, which is perhaps, from a technical standpoint, the most efficient in Great Britain.

The author has already drawn attention, in his Lectures on "Fuel Economy" before the Royal Institution in 1916, to the present unsatisfactory organisation of London's electric supply, which perhaps may be cited as a conspicuous example of what Lord Haldane's Committee have described as "technically wrong and commercially uneconomical." The population of the area covered by Greater London is about 7½ millions. Its electrical supply, instead of being organised under a simple controlling authority on one uniform scheme, is at present in the hands of no less than 65 separate authorities, which generate current on 49 different systems at no less than 70 different generating stations, containing altogether some 585 prime movers. The average size of the generating stations is only 5285 kilowatts; many of the older stations still contain reciprocating engines, and some are so situated that it is necessary to cart coal to them. Current is distributed from these stations at 54 different

POWER PRODUCTION FROM COAL

voltages, and the consumer is charged at one or other of some 70 different rates for the current he buys. There is no doubt but that were the London supply to be reorganised on lines recommended by the Committee's Report, electric current would be considerably cheapened throughout the area, to the great benefit of the whole population.

THE NORTH-EAST COAST ELECTRIC POWER SCHEME

As an example of what has already been done since the beginning of the century in one important industrial area in the Kingdom in the direction of organising a comprehensive scheme of electric power supply, the following particulars of the North-East Coast Scheme may be given :—

The area in question (1400 square miles), which includes the Northumberland and Durham Coalfields and the Cleveland Iron District, together with the cognate and associated engineering and shipbuilding industries of the Tyne, the Wear, and the Tees, extends for a distance of 70 miles from Morpeth and Blyth in the north to Stockton and Middlesbrough in the south.

The district is a remarkable one in many respects. With a population (in 1911) of 2·3 millions, or about 5 per cent. of that of the whole country, it produced in 1913 nearly 20 per cent. of total coal, 36·5 per cent. of the total coke, and 37·7 per cent. of the total pig iron raised or made in the kingdom. And owing to its three deep estuaries, the Tyne, the Wear, and the Tees, it built in that year no less than 51 per cent. of our total output of merchant shipping tonnage. It was the district which gave birth to the first public railway in 1825, and later on, after the discovery of the Cleveland ironstone deposits, it led the world in the development of that mighty engine of production the modern blast furnace, and brought to fruition the basic steel process.

The local conditions governing power supply throughout the district are (1) a good supply of cheap coal; (2) the large size and considerable technical development of most of the industrial establishments; and (3) the fact that there are abundant supplies of potential energy in the form of surplus coke-oven and blast-furnace gases and waste heat which only a comprehensive power scheme can fully utilise.

The present scheme owed its inception to an amalgamation or association of three power companies—namely, the Newcastle

COAL AND ITS SCIENTIFIC USES

Company, which started in 1889 as a small lighting company, the Durham Company, which started in 1901 with three generating stations at Jarrow, Gateshead, and Durham, and the Cleveland Company, which started in 1903, with its principal generating station at Grangetown, near Middlesbrough. In addition to these three Companies, the scheme has absorbed the Durham Collieries Electric Power Company and the Northern Counties Electrical Supply Company.

There are now seventeen generating stations (see Table LXXVI), namely, five coal-fired (total capacity, 111,600 H.P.),

TABLE LXXVI
PARTICULARS OF GENERATING STATIONS (ALL 3-PHASE, 40 CYCLES) FOR
THE YEAR 1915

Power Station.	Type.	Horse-power of Generating Plant.	Voltage.
Carville, Old Station	Coal-fired	53,500	5,750
„ New Station	Coal-fired	32,000	5,750
Dunston	Coal-fired and Gas	45,500	5,750
Philadelphia	Coal-fired	16,000	5,750
Neptune Bank	Coal-fired	5,800	5,750
Hebburn	Coal-fired	4,300	5,750
Blaydon	Waste Heat and Gas	3,200	5,750
Bankfoot	Waste Heat and Gas	8,000	3,000
Bowden Close	Waste Heat and Gas	6,400	3,000
Grangetown	Coal-fired and Waste Heat	11,200	11,500
Newport	Waste Heat	7,300	2,750
Weardale	Waste Heat and Coal-fired	7,300	2,750
Clarence	Waste Heat	4,000	2,750
Ayresome	Waste Heat	3,200	2,750
Tees Bridge	Waste Heat	1,500	2,750
Shotton	Waste Heat	1,300	2,750
Horden	Waste Heat	1,300	2,750
	Total	211,800	

six waste-heat stations (total capacity, 18,600 H.P.), one partly coal-fired and partly gas-fired (capacity 45,000 H.P.), two partly coal-fired and partly waste-heat (total capacity, 18,500 H.P.), and three partly waste-heat and partly gas-fired (total capacity 17,600 H.P.). The total capacity of the generating plant installed up to the end of last year was 211,800 H.P. The gases utilised are either coke-oven gas or blast-furnace gas, of which there are enormous surpluses in the area. The waste-heat

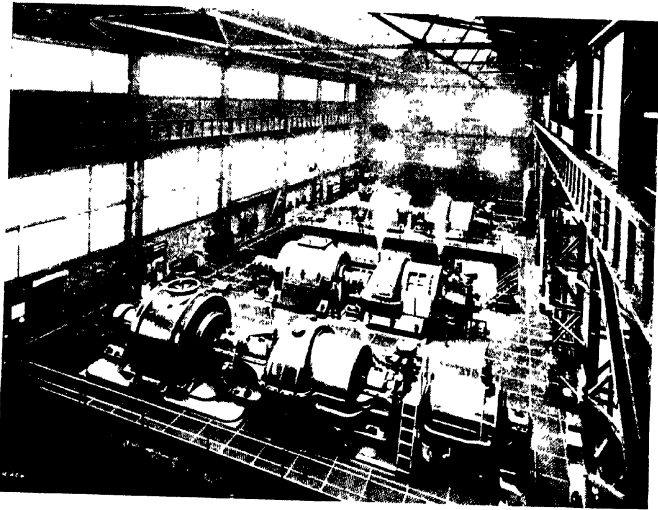

PLATE X.—Dunston Power Station.

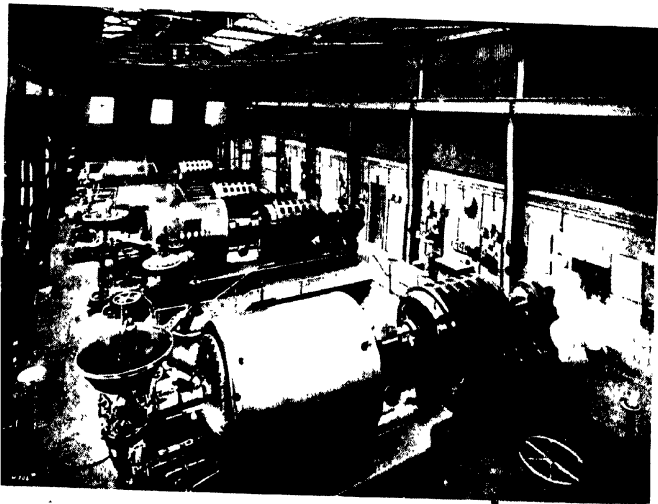

PLATE XI.—Newport Waste Heat Power Station.

POWER PRODUCTION FROM COAL

stations utilise either the sensible heat in the burnt gases from coke-ovens or the exhaust steam from blowing engines in iron-works, which, before being delivered to the steam engine, is sometimes "superheated" by the combustion of blast furnace gas. All the prime movers are steam-turbines, no gas engine being used. When gas is employed as a source of energy, it is always burnt under boilers, generating steam for turbines.

I am permitted, through the courtesy of Messrs. Merz and McLellan, the Consulting Engineers for the scheme, to give, by way of example, the following particulars relating to two of the generating stations. The first is the Dunston station of the Newcastle Company (Plate X), which is not only the most modern, but also, when completed, will be one of the largest in Europe. It is fired partly by coal and partly also by surplus gas from the Teams Otto by-product coke ovens. Its five large turbo-alternators have an output capacity of 45,500 H.P. But the station is laid out for six generating units, with a maximum total capacity of about 70,000 H.P. Steam is generated from coal-fired Babcock and Wilcox boilers at a pressure of 200 lbs. per square inch, and is then superheated to 570° Fahr. before delivery to the turbines. Three-phase current is generated at a normal pressure of 6000 volts and a frequency of 40 complete cycles per second.

The second example is the Newport Waste-Heat Station (Plate XI) near Middlesbrough, which is equipped with four 1666 H.P. Parson's turbines, driven by exhaust steam from the blowing engines in Sir B. Samuelson & Co.'s ironworks close by, and also a 900 H.P. Brush turbo-alternator, driven by supplies of high-pressure steam from the same works. The two main alternators were built by the British Westinghouse Company, and run at 2400 revolutions per minute, generating electrical energy at 3000 volts and 90 cycles per second, the greater portion of which is transformed up to 11,000 volts before being fed into the Company's high-tension main. All the power stations generate three-phase current at 40 cycles per second. At the larger stations the generating pressure is 6000 volts; but in the "waste-heat" stations it is 3000 volts, while at Grangetown it is 11,000 volts. In some of the stations it is at once transformed up to 11,000 or 20,000 volts, at which it is transmitted throughout the area to the various sub-stations, where it is transformed down to 6000, 3000, 600, or 440 volts.

Fig. 77b illustrates the phenomenal development of the scheme during the fifteen years (1900-1915) since its inception.

COAL AND ITS SCIENTIFIC USES

The total horse-power connected is now nearly 340,000, while the total capacity of the generating plant is nearly 220,000 H.P.

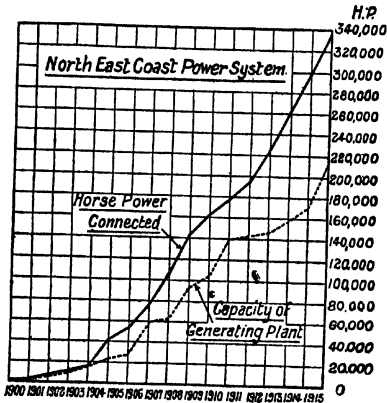

FIG. 77b.

The system supplies electricity in bulk to towns and urban districts at prices considerably less than it would cost any local authority to generate it. The North-Eastern Railway Company have electrified some forty miles of the Newcastle suburban railways, and, in addition, drive by electricity from the Power Company's mains their locomotive works at Gateshead, their wagon shops at Shildon (790 H.P.), the repair shops at Walker Gate, Tyne Dock, and Percy Main, as well as their goods stations at Newcastle, and their docks at Middlesbrough (800 H.P.) and Hartlepool (540 H.P.). Many tramway companies and most of the large industrial establishments in the area are also large customers. Most of the large industrial establishments in the area—including collieries, ironstone mines, iron and steel works, shipbuilding yards, engineering shops, cement works, soap and alkali works, flour mills, and electro-chemical factories—are connected with the system.

The average price for electric energy is less than $\frac{1}{2}d.$ per unit, whilst the coal consumption per H.P. hour delivered at consumer's terminals is only 1.54 lb. It has been estimated that this latter figure has replaced a former coal consumption of 7 lbs. per H.P. hour when the various industrial establishments now connected with the power scheme generated their own power individually. On the total of 560,000,000 H.P. hour delivered at consumers' terminals during the year 1915, this would represent a saving of no less than 1,365,000 tons of coal per annum. The utilisation of "waste heat" throughout the area now amounts to an equivalent of about 150,000 tons of coal per annum.

CHAPTER XXII

" SURFACE COMBUSTION " ¹

A Discourse by the Author before the Royal Institution of Great Britain on Friday, February 27, 1914

DURING his researches upon Flame,² Sir Humphry Davy discovered, in 1817, that the constituents of a combustible mixture will combine slowly below the ignition temperature; this led him to enquire whether, seeing that the temperatures of flames far exceed those at which solids become incandescent, a metallic wire can be maintained at incandescence by the combination of gases at its surface, without actual flame. He thereupon tried the effect of introducing a warm platinum wire into a jar containing a mixture of coal-gas and air rendered non-explosive by an excess of the combustible constituents; the wire immediately became red hot, and continued so until nearly the whole of the oxygen had disappeared.

We will repeat the experiment, in a modified form, with the aid of a platinum crucible and a Bunsen burner. If the platinum crucible be warmed by the flame, and the flow of the explosive mixture through the burner be momentarily arrested, and then immediately renewed, the gases, instead of burning with flame at the burner head, will immediately combine without flame over the platinum surface, causing it to glow.

During the twenty years which followed Davy's discovery, several distinguished chemists (William Henry and Thomas

¹ In response to many requests that this volume should include a chapter on the subject of "Surface Combustion," the author decided, with the kind permission of the Royal Institution authorities, to reprint this Lecture just as it was delivered, supplemented by Addenda briefly describing certain developments which have taken place since it was given. The subject was treated in greater detail in the course of Howard Lectures which the author delivered in 1914 before the Royal Society of Arts, and also in his Lectures in 1911 and 1912 before the American Gas Institute (*Proc. Amer. Gas Institute*, VI., 565), the Franklin Institute, and the German Chemical Society (*Ber.*, 1913, Vol. XLVI, p. 5).

² *Collected Works*, Vol. VI., p. 8.

COAL AND ITS SCIENTIFIC USES

Graham in this country, but more particularly Dulong and Thénard, and, independently, Döbereiner on the Continent) experimented upon the slow combination of gases at temperatures below the ignition point, in contact with hot solids, whereby it was established (1) that hot solids, and pre-eminently metals of the platinum group, have the power of inducing gaseous combustion at relatively low temperatures; and (2) that hydrogen is of all combustible gases, the most susceptible to this action.

The mechanism of this induced slow surface combustion formed the subject of a celebrated controversy between Faraday and De la Rive in 1834-5. De la Rive held the view that it consists essentially in a series of rapidly alternating oxidations and reductions of the surface; Faraday, on the other hand, contended that the function of the surface is to condense both the oxygen and the combustible gas, thus producing in the surface layers a condition comparable to that of high pressure. But, owing to lack of crucial experiments, no satisfactory theory of the phenomenon could be evolved, nor, with the exception of the well-known "Döbereiner Lamp," was there any practical outcome of this early work. In 1836 interest in the subject suddenly dropped, and was not revived for half a century.

Meanwhile, the researches of Deville upon the dissociation of steam and carbon-dioxide at high temperatures led to the notion, which was strongly upheld by the late Frederick Siemens, that inasmuch as incandescent surfaces promote dissociation, they must necessarily hinder combustion. This, of course, is fallacious; we now recognise that if, as Deville proved, an incandescent surface accelerates the dissociation of steam, it must, according to a principle enunciated by Ostwald, of necessity accelerate the combination of oxygen and hydrogen in like degree, provided always that the surface remains chemically unaltered.

A notable demonstration of the possibility of realising flameless incandescent surface combustion in contact with metals other than those of the platinum group was given by Thomas Fletcher in a lecture at the Manchester Technical School as far back as 1887.¹ He injected a mixture of gas and air on to a large ball of iron wire, flame being used at first in order to heat the wire to the temperature necessary to induce a continuous surface combustion; on extinguishing the flame, by momentarily stopping the gaseous mixture, the combustion continued without any flame, but with an enormous increase of temperature. Fletcher grasped three

¹ *Journal of Gas Lighting*, 1887, I., p. 168.

'SURFACE COMBUSTION'

important points, namely: (1) that "this invisible flameless combustion is only possible under certain conditions;" (2) "that the combustible mixture shall come into absolute contact with a substance at high temperature . . .;" and (3) that "in the absence of a solid substance at a high temperature, it is impossible to cause combustion without flame"; but, so far as I am aware, he did not follow up the matter beyond this point, either in its theoretical aspects or practical applications, and his work had but little influence upon contemporary opinion or practice.

My own investigations upon surface combustion began in 1902 with a systematic attempt to elucidate the factors operative in the slow combination of hydrogen and of carbon monoxide in contact with various hot surfaces (*e. g.* porcelain, fireclay, magnesia, platinum, gold, silver, copper and nickel oxides, etc.) at temperatures below 500°C. Into the details of these earlier experiments, which preceded and led up to the technical developments about which I shall speak later, I do not propose to enter; it will be sufficient for my present purpose if I say that it was proved beyond all question (1) that the power of accelerating gaseous combustion is possessed by *all* surfaces at temperatures below the ignition point in varying degrees, dependent upon their chemical characters and physical texture; (2) that such an accelerated surface combustion is dependent upon an absorption of the combustible gas, and probably also of the oxygen, by the surface, whereby it becomes "activated" (probably ionised) by association with the surface; and (3) that the surface itself becomes electrically charged during the process. Finally, certain important differences between homogeneous combustion in ordinary flames and heterogeneous combustion in contact with a hot surface from a chemical point of view were established, so that there can be no longer any doubt as to the reality of the phenomenon.¹

The fact that such catalytic combustion depends upon an intimate association of the surface with the combining gases is beautifully illustrated by two photomicrographs of the surface of a silver gauze taken *before* and *after* a long series of experiments in which it was employed as the catalysing medium for the

¹ Bone and Wheeler, *Phil. Trans. Roy. Soc.*, 1906 (A. 206, pp. 1-67), also further (unpublished) results (1905-12) in collaboration with Messrs. G. W. Andrew, A. Forshaw, and H. Hartley, which are summarised in *Berichte der Deutschen Chem. Ges.*, 1913.

COAL AND ITS SCIENTIFIC USES

combination of hydrogen and oxygen at 400°C . (848°F). Fig. 78 shows the original smooth condition of the surface, and Fig. 79 shows the "frosted" effect produced by the deep "pitting" action of the reacting gases during their absorption and "activation" by the surface.

My next contention is that if hot surfaces possess the power of accelerating gaseous combustion at temperatures below, or in the neighbourhood of, the ignition point, the same power must also be manifested in even a greater degree at higher temperatures, and especially so when the surface itself becomes incandescent. Indeed, there are experimental grounds for the belief that not only does the accelerating influence of the surface rapidly increase with the temperature, but also that the differences between the catalysing powers of various surfaces, which at low temperatures are often considerable, diminish with ascending temperatures until at bright incandescence they practically disappear.

Such considerations as I have thus briefly explained convinced me some years ago that if an explosive gaseous mixture be either injected on to or forced through the interstices of a porous refractory incandescent solid under certain conditions, which will be hereafter explained, a greatly accelerated combustion would take place within the interstices or pores, or, in other words, within the boundary layers between the gaseous and solid phases wherever these may be in contact—and the heat developed by this intensified combustion would maintain the surface in a state of incandescence *without any development of flame*, thus realising the conception of *flameless incandescent surface combustion*, as a means of greatly increasing the general efficiency of heating operations wherever it can be conveniently applied.

There are critics who, whilst admitting the accelerating influence of an incandescent surface upon gaseous combustion, are sceptical about the process being really flameless. The force of such objections largely disappears when we get into close quarters with the phenomenon, and realise how extremely slow a trans-action flame combustion really is when considered in terms of molecular time. Take, for example, the case of such a quick-burning mixture as electrolytic gas ($2\text{H}_2 + \text{O}_2$): When this is ignited at atmospheric pressure, the flame is initially propagated by conduction with a uniform slow velocity of 20 metres per second, and during this initial period of "*inflammation*," the total duration of chemical change in each successive layer is something like the order of $\frac{1}{100}$ second, an interval of at least one hundred

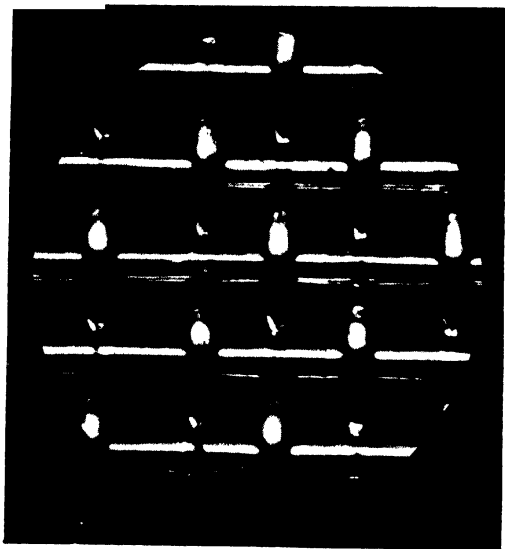

FIG. 78.

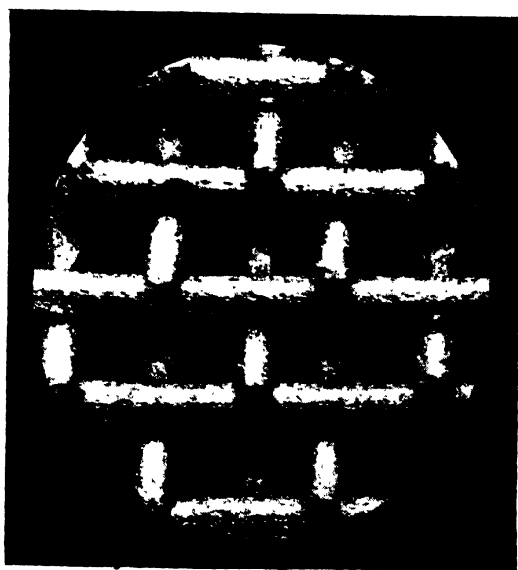

FIG. 79.

Photomicrographs of Silver Gauze before and after Surface Combustion Experiment.

'SURFACE COMBUSTION'

million times as long as the average interval between successive molecular collisions in the gas. Even after "detonation" has been set up in the mixture, when the combustion is propagated from layer to layer as a wave of adiabatic compression, at a velocity of 2820 metres per second, the total duration of chemical change is still of the order of $\frac{1}{8000}$ or $\frac{1}{10000}$ second, or about a million times as long as the interval between successive molecular collisions.

To illustrate how a flame may be extinguished by the introduction of an active catalysing surface, I will perform an experiment which was first exhibited here a year ago by my colleague Professor the Hon. R. J. Strutt, who has very kindly lent me his apparatus. Most of you will be familiar with his discovery of the active modification of nitrogen produced by a powerful electric discharge. This bulb (capacity 300 c.c.) is full of rarefied nitrogen, at a pressure of about $\frac{1}{10}$ mm.; and in the side tube lies an oxidised copper wire, which fits it as closely as is consistent with easy sliding.

If the nitrogen in the bulb be subjected to a powerful electrodeless discharge, it is transformed into an active condition; the gas continues to glow brilliantly, owing to the fact that the "active" modification is reverting to the ordinary kind producing a luminosity which may be regarded as a condition analogous with flame. The glow will last for a minute or more during the progress of the chemical reversion, and finally dies out when the latter is completed.

But if, on repeating the experiment, the bulb be tilted so that the oxidised copper wire drops into the glowing gas, the luminosity is instantly extinguished. This shows that the reversion process is so enormously accelerated by the surface that practically the whole of the chemical action is concentrated at the surface, and instantaneously completed there, thus extinguishing the glow.

I think we have, in Professor Strutt's experiment, a close analogy to what I conceive as occurring when an incandescent surface is employed to accelerate ordinary gaseous combustion; the action is so concentrated at the surface that a substantially "flameless" effect results. I want to emphasise the fact that the incandescent solid plays a specific rôle in this surface combustion; it is no mere idle looker-on at the surging crowd of reacting molecules which swarm around it. On the contrary, it so galvanises and incites the dormant affinities between the

COAL AND ITS SCIENTIFIC USES

combustible gas and oxygen, that the stately minuet of ordinary combustion gives place to the wild intoxication of the Venusberg.

The manner in which the surface acts is still perhaps a matter of conjecture, but the fact that it so acts can no longer be disputed. In a discussion which took place at the British Association in 1910, Sir J. J. Thomson insisted that combustion is concerned not only with atoms and molecules, but also with electrons, *i. e.* bodies of much smaller dimensions and moving with very high velocities, and suggested that in reference to the influence of hot surfaces in promoting combustion it was not improbable that the emission of charged particles from the surface was a factor of primary importance. It is known that incandescent surfaces emit enormous streams of electrons travelling with high velocities, and the actions of these surfaces in promoting combustion may ultimately be found to depend on the fact that they bring about the formation of layers of electrified gas in which chemical changes proceed with extraordinarily high velocity.

THE NEW PROCESSES OF INCANDESCENT SURFACE COMBUSTION

Leaving the theoretical aspects of the subject, I will now describe some of the more important features of two processes of incandescent surface combustion evolved at the works of Messrs. Wilsons and Mathiesons, Ltd., in Leeds under my direction, with the assistance of Mr. C. D. McCourt, in which a homogeneous explosive mixture of gas and air, in the proper proportions for complete combustion (or with air in slight excess thereof), is caused to burn without flame in contact with a granular incandescent solid, whereby a large proportion of the potential energy of the gas is immediately converted into radiant form. The advantages claimed for the new system, now known as the "Boncourt" system, are: (1) the combustion is greatly accelerated by the incandescent surface, and, if so desired, may be concentrated just where the heat is required; (2) the combustion is perfect with a minimum excess of air; (3) the attainment of very high temperatures is possible without the aid of elaborate regenerative devices; and (4) owing to the large amount of radiant energy developed, transmission of heat from the seat of combustion to the object to be heated is very rapid. These advantages are so uniquely combined in the new system that the resultant heating effect is, for many important purposes not only pre-eminently economical, but also easy of control.

'SURFACE COMBUSTION'

DIAPHRAGM HEATING AND ITS APPLICATIONS

In the first process the homogeneous mixture of gas and air is allowed to flow under slight pressure through a porous diaphragm of refractory material from a suitable feeding chamber (see Fig.80), and is caused to burn without flame at the surface of exit, which

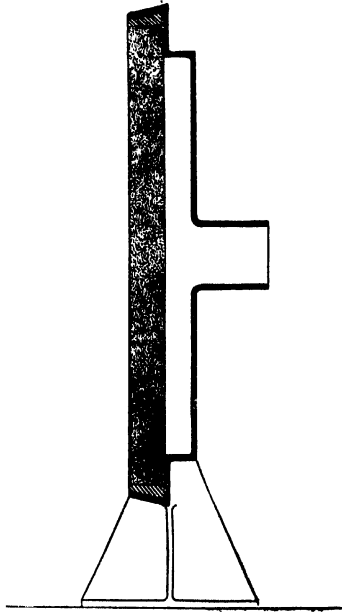

FIG. 80.

is thereby maintained in a state of red-hot incandescence. The diaphragm is composed of granules of firebrick, or other material, bound together into a coherent block by suitable means; the porosity of the diaphragm is graded to suit the particular kind of gas for which it is to be used. The diaphragm is mounted in a suitable casing, the space enclosed between the back of the casing and the diaphragm constituting a convenient feeding-chamber for the gaseous mixture. Such a mixture may be obtained in either of two ways, namely (1) by means of suitable connections through a Y-piece with separate supplies of low-pressure gas and air (2

COAL AND ITS SCIENTIFIC USES

or 3 in. W.G. is sufficient), or (2) by means of an "injector" arrangement connected with a supply of gas at a pressure of 1 to 2 lbs. per sq. in.; the gas in this case draws in its own air from the atmosphere in sufficient quantity for complete combustion, the proportions of gas and air being easily regulated by a simple device.

We will now start up a diaphragm. Gas is first of all turned on and ignited as it issues at the surface; air is then gradually added until a fully aerated mixture is obtained. The flame soon becomes non-luminous, and diminishes in size; a moment later, it retreats on to the surface of the diaphragm, which at once assumes a bluish appearance; soon, however, the granules at the surface attain an incipient red heat, producing a curious mottled effect; finally, the whole of the surface layer of granules becomes red hot, and an accelerated "surface combustion" comes into play. All signs of flame disappear, and there remains an intensely glowing surface throwing out a genial radiant heat which can be steadily maintained for as long as required.

Whilst the diaphragm is in operation before you, I may point out some of the more striking features of the phenomenon which it presents. *Firstly*, the actual combustion is confined within a very thin layer— $\frac{1}{8}$ to $\frac{1}{4}$ in. only—immediately below the surface, and no heat is developed in any other part of the apparatus. Kindly observe that whilst the front of the diaphragm is intensely hot, the back of the apparatus is so cold that I can lay my hand on it. *Secondly*, the combustion of the gas, although confined within such narrow limits, is perfect, for when once the relative proportions of gas and air have been properly adjusted, no trace of unburnt gas escapes from the surface. *Thirdly*, the temperature at the surface of the diaphragm can be instantly varied at will by merely altering the rate of feeding of the gaseous mixture; there is practically no lag in the temperature response, a circumstance of great importance in operations where a fine regulation of heat is required. *Fourthly*, a plane diaphragm such as this may be used in any position, *i. e.* at any desired angle between the horizontal and vertical planes. *Fifthly*, the diaphragm method is amenable to a variety of combustible gases—coal or coke-oven gas (either undiluted or admixed with water gas); natural gas, petrol-air gas, carburetted water gas are all well suited in cases where unimpeded radiation is required. *Finally*, the incandescence in no way depends upon the external atmosphere. When once the diaphragm has become incandescent,

'SURFACE COMBUSTION'

and the proportions of air and gas supplied in the mixing chamber at the back have been properly adjusted, the surface will maintain its incandescence unimpaired, even in an atmosphere of carbon dioxide.

I need hardly point out to you the many obvious purposes, domestic and industrial, to which "diaphragm heating" may be applied. In the domestic line, the boiling of water, grilling, roasting and toasting are at once suggested, and although the best existing types of gas fires are thoroughly hygienic and efficient, I think that the diaphragm may come in for the heating of apartments; at any rate experiments are being carried out in that direction.

I have recently been told of a large restaurant in London where they are grilling by means of an electric radiator fixed horizontally above the work so that the radiant energy is directed downwards on to it. It has been claimed that the value of the recovered fat, which in the ordinary method of grilling drops into the fire and is consumed, has more than paid for the electricity used. With a diaphragm, similar advantages can be secured with gas at a considerably less cost; for comparing gas of net calorific value 500 B.Th.U.s. per cub. ft. at 2s. 6d. per 1000 cub. ft. with electricity at 3d. per unit, the initial cost of a given amount of energy is about 14 times greater in the form of electricity than in the form of gas.

Turning now to the industrial field, I had the satisfaction of visiting not long ago a large confectionery factory where the diaphragms have been employed for more than a year for boiling and concentrating sugar solutions. The solution is boiled in a copper pan over a 13-in. diameter circular diaphragm (see Fig. 81); the supply of gaseous mixture is controlled by one lever which operates in a single movement the gas and air cocks. The ignition is effected automatically by means of a small pilot light. Each boiler does 10 to 12 heats per diem, each lasting twenty minutes, and some of the diaphragms have been in continuous daily use for about a year. I saw in the factory a battery of thirteen such boiling pans, all in constant use, and was informed that the gas consumption was not more than half what it formerly used to be when the pans were heated over ordinary atmospheric flame burners. The secret of this higher efficiency lies in the fact that gas flames are a very unsatisfactory means for boiling liquids in metallic vessels, owing to the non-conducting layer of relatively cool gas which forms between the flame and the under-

COAL AND ITS SCIENTIFIC USES

surface of the pan; but with a diaphragm the large percentage of radiant heat is quickly absorbed by the vessel and transferred to the liquid with high efficiency.

Moreover, in evaporating liquids it is possible to use an overhead diaphragm, directing the radiation downward on to the surface of the liquid, thus eliminating altogether the influence of the containing vessel. In this way only the upper layers of the liquid are actually heated up to the working temperature, whilst the evaporation is extraordinarily rapid and efficient. Given a sufficiently cheap high-grade gas there would appear to be endless possibilities for diaphragm heating in the industrial field.

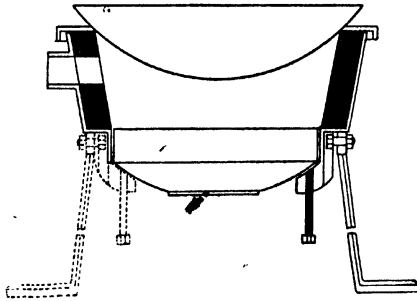

FIG. 81.

INCANDESCENT SURFACE COMBUSTION IN A BED OF REFRACTORY GRANULAR MATERIAL

The second process is applicable to all kinds of gaseous or vaporised fuels; it consists essentially in injecting, through a suitable orifice at a speed greater than the velocity of back-firing, an explosive mixture of gas (or vapour) and air in their combining proportions into a bed of incandescent granular refractory material which is disposed around or in proximity to the body to be heated.

I can perhaps best describe the process by the aid of two diagrams showing its applications to the heating of crucible and muffle furnaces. Fig. 82 shows the process as applied to a crucible furnace. The crucible is surrounded by a bed of refractory incandescent granular material. The mixture of gas and air is injected at a high velocity through a narrow orifice in the base

'SURFACE COMBUSTION'

of the furnace, and as it impinges upon the incandescent bed, combustion is instantaneously completed without flame.

The seat of this active surface combustion is in the lowest part of the bed; the burnt gases, rising through the upper layers, rapidly impart their heat to the bed, maintaining it in a high degree of incandescence. Fig. 83 shows a similar arrangement

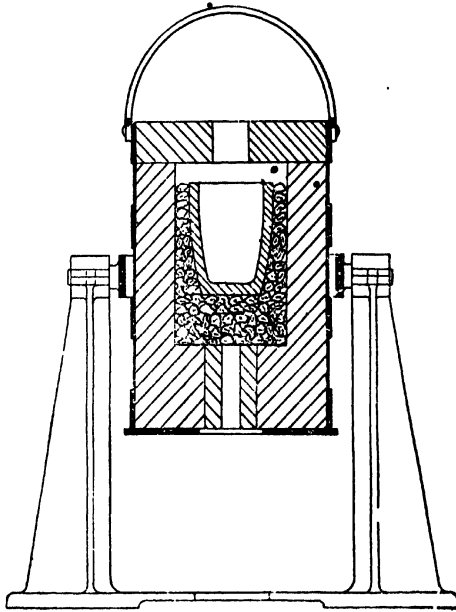

FIG. 82.

for the heating of a muffle furnace which needs no further explanation.

It is obvious that this process is capable of adaptation to all kinds of furnace operations, as, for example, to the heating of crucibles, muffles, retorts, and to annealing and forging furnaces generally. Moreover, it is not essential that the bed of refractory material should be very deep; indeed a quite shallow bed suffices to complete the combustion. Neither is it necessary that the bed shall be disposed *around* the vessel or chamber to be heated; for if contact with the burnt products is not objectionable, a

COAL AND ITS SCIENTIFIC USES

shallow bed may be arranged *within* the heating chamber itself (Fig. 84, p. 458); or the refractory material may be equally well packed into tubes, or the like, traversing the substance or medium to be heated. The last-named modification is, as we shall see later, specially important in relation to steam-raising in multitubular boilers.

By means of this process much higher temperatures are attainable with a given gas than by the ordinary methods of flame combustion without a regenerative system, and, as a matter of fact, we have found that with any gas of high calorific intensity (such

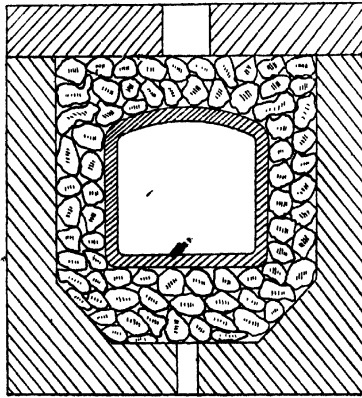

FIG. 83.

as coal gas, water gas, or natural gas) the upper practicable temperature limit is determined rather by the refractoriness of the material composing the chamber to be heated (*i. e.* the muffle or crucible) than by the possibilities of the actual combustion itself. When I tell you that in a crucible fired by coal gas on this system we have melted Seger-cone No. 39, which according to the latest determination of the German Reichsanstalt melts at 1880° C. (3416° F.), and also that we can easily melt platinum, you will appreciate the possibilities of the method in regard to high temperatures with gas-fired furnaces.

The maximum temperature obtainable, without "regenerative" appliances, with any particular gas will obviously depend upon the relative heat capacities of their products of combustion

‘SURFACE COMBUSTION’

for a given heat development in the bed. In this connection, it is of interest to compare the principal gaseous fuels available for industrial operations in the order of their calorific intensities, as follows:—

TABLE LXXVII
THE COMBUSTION OF TYPICAL GASEOUS FUELS

	Per Cubic Foot of Gas Burnt.			Per 100 B.Th.U.S. <i>net</i> developed on Combustion.			
	Net B.Th.U.s	Vol. of Air Required.	Vol. of Products	Vol. of Air Required.	Vol. of Combining Mixtures	Vol. of Products	Relative Heat Capacities of Products
Blue Water Gas . .	290	2.290	2.82	0.79	1.14	0.97	0.95
Coal or Coke Oven Gas	500	4.656	5.36	0.93	1.13	1.08	1.00
Producer Gas . . .	140	1.166	2.00	0.84	1.50	1.43	1.38
Blast-furnace Gas .	100	0.716	1.58	0.72	1.72	1.58	1.52

Now, whilst with coal gas, coke-oven gas or water gas, it should be easily possible, without regeneration, to obtain in a refractory granular bed temperatures of up to at least 2000° C. (or say 3630° F.), with a low-grade producer gas, such as Mond gas, about 1500° C. (or say 2730° F.), would probably be the approximate maximum without regeneration. But with some degree of heat recuperation, which in large furnaces is quite practicable, still higher temperatures would be attainable.

Moreover, within the maximum limits, the heating with any kind of gas is very uniform, economical, and controllable; indeed the temperature for a given furnace fired by gas of uniform composition is chiefly controlled by the amount of gas burnt, or in other words, the rate of heat development in the bed. And as for economy, tests made about three years ago in Leeds under my supervision upon medium-sized muffle furnaces convinced me that to maintain a given temperature between say 800° and 1400° C., a properly constructed "surface combustion furnace" would require between 70 and 40 per cent, only of the gas used in an ordinary flame-heated furnace of the same dimensions, and that the advantage in favour of "surface combustion" would increase rapidly with the working temperature.

This was confirmed by independent competitive trials carried

COAL AND ITS SCIENTIFIC USES

out in New York shortly after my lectures there in the autumn of 1911, in which our surface-combustion furnaces were pitted against the best American types; it was proved that in order to maintain a temperature of 1400° C. we practically halved their gas consumption, whilst to maintain 800° C. our consumption was about 0.7 of theirs.

Any one who understands furnace design and construction will appreciate the many difficulties which are necessarily encountered in applying a new and revolutionary idea of this sort to the firing of large industrial furnaces. Indeed, the new conditions of heating are so radically different from the old, that a new experience has to be built up. There are problems connected with the proper feeding and distribution of gaseous mixture, with the dimensions and arrangement of the combustion beds, and with the refractiveness of the furnace walls, which have to be solved. Nevertheless, judging from reports that reach me from time to time, substantial progress has been made in the direction of gas-fired crucible furnaces for brass and aluminium melting, annealing furnaces, and forging furnaces, the latter fired with producer gas with regeneration of gas and air. Some large annealing furnaces (for example, Fig. 85) are now running satisfactorily in industrial establishments on both Mond gas and town gas, and I understand that brass melting can be carried out in 50 to 60 lb. charges in tilting crucible furnaces with the remarkably low consumption of about 1.75 cub. ft. per pound of metal melted and poured.

SURFACE COMBUSTION AS APPLIED TO STEAM RAISING

I now come to an important application of the new process to the raising of steam in multitubular boilers; not that the application of surface combustion is limited to boilers of the multitubular type, but because our investigations have so far been principally made with these.

It is well known that the gas-firing of steam boilers has not been very successful from the point of view either of thermal efficiency or of rate of evaporation. In this country the gases available for steam-raising purposes on a large scale are principally (1) blast-furnace gas, of which there are large surpluses available in all iron-smelting areas; (2) the surplus gas obtainable during the manufacture of coke in by-product ovens; and (3) producer gas of various compositions, but more particularly that

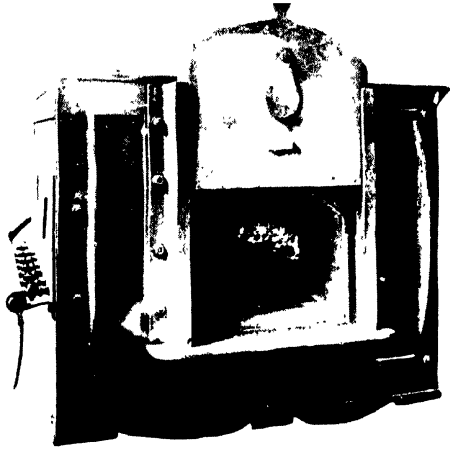

FIG. 84.

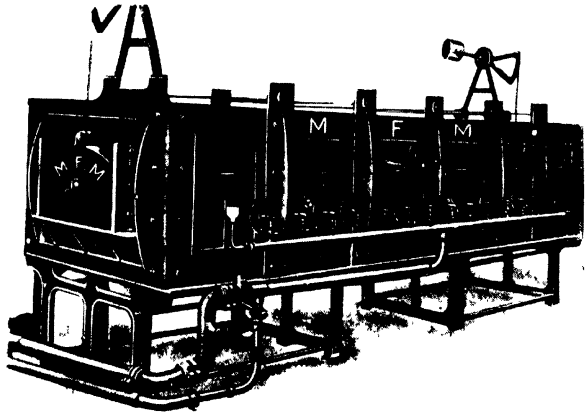

FIG. 85.
Surface Combustion Furnaces.

'SURFACE COMBUSTION'

manufactured under ammonia recovery conditions. In the United States, and some other oil-producing countries, natural gas of high calorific power is also available. All these gases have been found to be amenable to the system I am about to describe.

It has been estimated by a prominent British blast-furnace engineer that the thermal efficiency of the best type of water-tube boiler, fired by blast-furnace gas, does not exceed about 55 per cent., whilst in the case of boilers fired by coke-oven gas the average thermal efficiency probably does not much exceed 65 to

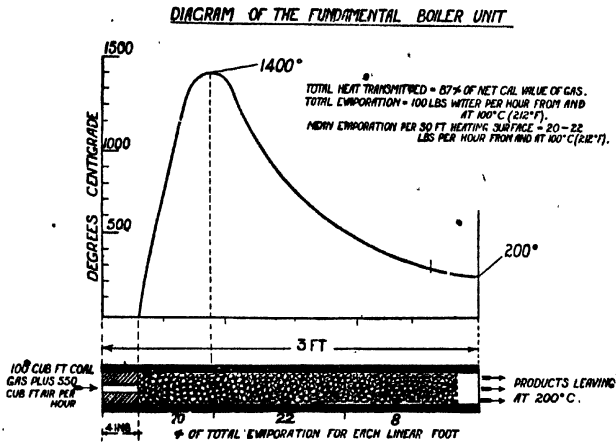

Fig. 86.

70 per cent. But on applying the principle of surface combustion to the gas-firing of multitubular boilers we have been able to obtain results with coal gas corresponding to the transmission of nearly 95 per cent. of the *net* calorific value of the gas to the water in the boiler.

Our first experiments in Leeds were made with a single steel tube 3 ft. in length and 3 in. in diameter, packed with fragments of granular refractory material, meshed to a proper size, and fitted at one end with a fireclay plug, through which was bored a circular hole, $\frac{3}{8}$ in. in diameter, for the admission of the explosive mixture of gas and air at a speed greater than that of back-firing (Fig. 86). The tube was fitted into an open trough, such as you see here on the table, in which water could be evaporated at

COAL AND ITS SCIENTIFIC USES

atmospheric pressure. After the lecture my assistants will demonstrate the boiling of water in this apparatus.

Such a tube may be appropriately termed the fundamental unit of our boiler system, because boilers of almost any size may be constructed merely by multiplying the single tube, and as each tube is, so to speak, an independent fire or unit, the efficiency of the whole is that of the single tube, or in other words, the efficiency of the whole boiler is independent of the number of tubes fired.

Experimenting with such a tube, it was found possible to burn completely a mixture of 100 cub. ft. of coal gas plus 550 cub. ft. of air per hour, and to evaporate about 100 lb. of water from and at 100° C. (212° F.) per hour (20 to 22 lb. per sq. ft. of heating surface), the products leaving the further end of the tube at practically 200° C. This meant the transmission to the water of 88 per cent. of the net heat developed by the combustion, and an evaporation per sq. ft. of heating surface nearly twice that of an express locomotive boiler. The combustion of the gas was completed within 4 or 5 in. of the point where it entered the tube. Of the total evaporation, no less than 70 per cent. occurred over the first linear foot of the tube, 22 per cent. over the second foot, and only 8 per cent. over the last foot. This points to a very effective "radiation" transmission from the incandescent granular material in the first third of the tube, where the zone of active combustion is located, although it should be remarked that the *loci* of actual contact between the incandescent material and the walls of the tube are so rapidly cooled by the transmission of heat to the water on the other side that they never attain a temperature even approaching red heat. The granular material in the remaining two-thirds of the tube serves to baffle the hot products of combustion, and to make them repeatedly impinge with high velocity against the walls of the tube, thus materially accelerating their cooling, and either preventing or minimising the formation of the feebly-conducting stationary film of relatively cold gases which in ordinary boiler practice clings to the tube walls, seriously impairing the heat transmission.

Having thus satisfied ourselves of the efficiency of the fundamental unit as an evaporator, we proceeded to construct our first experimental boiler, made up of ten tubes, each 3 ft. long and 3 in. in diameter, fixed horizontally in a cylindrical steel shell capable of withstanding a pressure of over 200 lb. per sq. in. This boiler is shown diagrammatically in Fig. 87 (section showing three



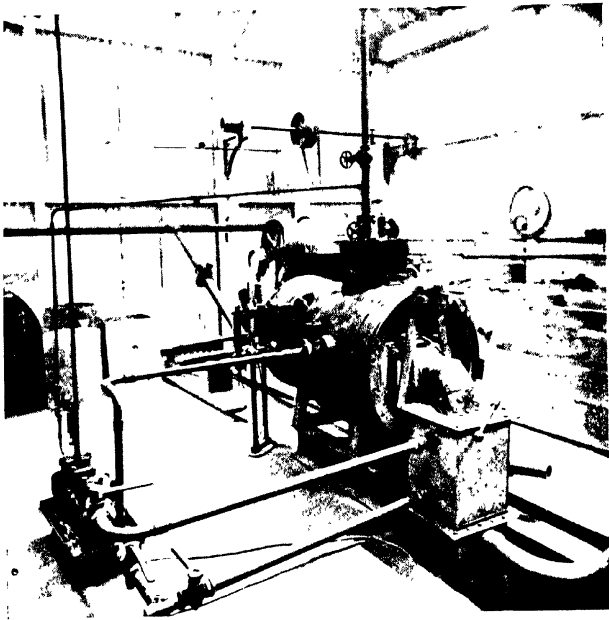

FIG. 88.—Surface Combustion 10-Tube Experimental Boiler.

'SURFACE COMBUSTION'

tubes only), whilst Fig. 88 is a photograph of it (back view showing feed-water heater). The gaseous mixture was forced through the tubes under pressure from a special feeding chamber attached to the front plate of the boiler; the products of combustion, after leaving the boiler, passed through a small feed-water heater containing nine tubes, each 1 ft. long and 3 in. in diameter, filled with granular material to facilitate the exchange of heat.

This combination of boiler and feed-water heater proved phenomenally successful in every way; in a trial run at Leeds on December 8, 1910, with coal gas of net calorific value 562

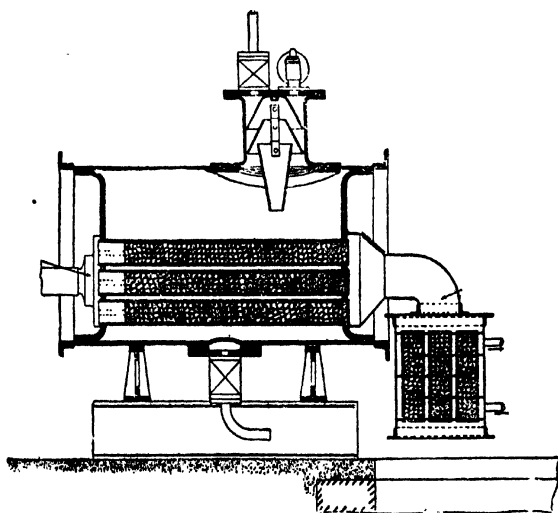

FIG. 87.

B.Th.U.s. per cub. ft. at N.T.P., and evaporating at the rate of 21.6 lbs. of water "from and at 212° F." per sq. ft. of heating surface per hour, the ratio of the heat utilised to the net heat developed in the tubes was 0.943. But this remarkable result was eclipsed in another independent trial carried out by German Engineers in London on January 8, 1913, when, with coal gas of net calorific value 510 B.Th.U.s. per cub. ft. at N.T.P., and evaporating at the enormously high rate of 33.9 lbs. "from and at 212° F." per sq. ft. of heating surface, the ratio of the heat

COAL AND ITS SCIENTIFIC USES I

utilised to the net heat developed by combustion was 0.933. The details of these tests are shown herewith:—

TABLE LXXVIII

—	I. Dec. 8, 1910.	II. Jan. 8, 1913.
1. Net cal. value of gas : B.Th.U.s. per cub. ft. at N.T.P.	562	510
2. Rate of evaporation : Lbs. of water per sq. ft. heating surface per hour (from and at 212° Fahr.)	21.6	33.9
3. Pressure of gaseous mixture entering the tubes : Inches W.G.	17.3	40.9
4. Pressure of products entering the feed water heater : Inches W.G.	2.0	5.14
5. Steam-gauge pressure : Lbs. above atmospheric	100	103
6. Boiling point of the water : Fahr. Degrees	338°	340°
7. Temperature products leaving boiler : Fahr. Degrees	446°	534°
8. Temperature products leaving feed-water heater : Fahr. Degrees	203°	289°
9. Net heat supplied to the boiler per hour : B.Th.U.s.	559,800	728,333
10. Net heat transmitted per hour : B.Th.U.s.	527,800	680,000
Efficiency Ratio	0.943	0.933

THE 110-TUBE BOILER AT THE SKINNINGROVE IRONWORKS

Six months' continuous experience with our first experimental unit gave us great confidence in its reliability, so that when in the early months of 1911 we received an enquiry from the Skinningrove Iron Co., Ltd., for a boiler of about ten times the capacity of the experimental unit, to be fired by means of the surplus gas from their new *Q*to by-product coking-plant, we had no hesitation in accepting a commission to instal our first large boiler there, under a strict guarantee as to its output and efficiency. This boiler (Fig. 89) was built by Messrs. Richardsons and Westgarth, Ltd., of Middlesbrough, to the design of Mr. Michael Longridge, to whom I had been indebted for much valuable advice and encouragement during the earlier experiments. It consists of a cylindrical drum 10 ft. in diameter and 4 ft. from front to back, traversed by 110 steel tubes, each of 3 in. internal diameter, which are packed with fragments of suitable refractory granular material. To the front of the boiler is attached a specially designed feeding chamber which delivers washed coke-oven gas

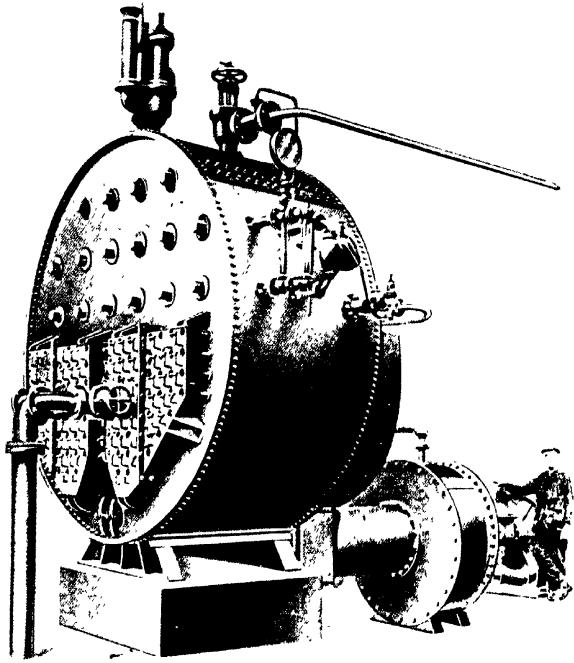

FIG 89 —Surface Combustion Boiler at Skinningrove Ironworks.

'SURFACE COMBUSTION'

at 60° to 70° Fahr., and under a pressure of 1 to 2 in. W.G., to each of the 110 combustion tubes; this gas, together with a regulated proportion of air from the outside atmosphere, is drawn, under suction from a fan, through a short mixing tube, into each of the said combustion tubes, where it is burnt without flame in contact with the incandescent granular material. The products of combustion having traversed the 4-ft. length of packed tube, pass outwards into a semicircular chamber at the back of the boiler, and thence through a duct to the tubular feed-water heater. The fan which is attached just beyond this feed-water heater and is driven by a three-phase A.C. electric

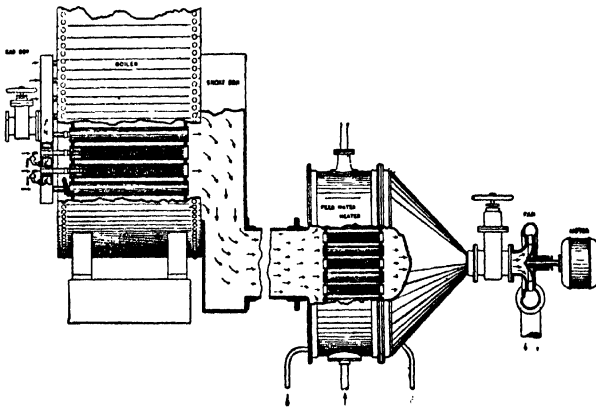

FIG. 90.

motor, sucks out the cooled products, at a temperature of 100° C. (212° F.) or under, and discharges them, through a short vertical duct, into the atmosphere. The arrangement of the whole plant is shown in the accompanying diagram (Fig. 90).

The plant was successfully started up on November 7, 1911, for a month's trial run—day and night continuously—after which it was opened up for an official inspection by the representative of a Boiler Insurance Company. Everything worked without a hitch during this trial; steam was generated, at 100 lb. gauge pressure, from a feed-water of about four degrees of hardness, whilst the average temperature of the waste gases leaving the feed-water heater was reduced to 80° C. (say 175° Fahr.), a sure indication of the high thermal efficiency of the plant. When,

COAL AND ITS SCIENTIFIC USES

at the conclusion of the month's trial, the boiler was opened up for inspection, the combustion tubes were found to be in good condition and free from scale; indeed, owing to the extremely high rate of evaporation, the scaling troubles experienced with other types of multitubular boilers appear to be completely obviated, the scale being automatically and continuously shed from the tube in thin films (about $\frac{1}{30}$ in. thick) as fast as it is formed; a very important advantage, as any one who is plagued by scaling troubles will appreciate.

After this official inspection, the plant, having amply fulfilled our guarantee, was taken over by the Skinningrove Iron Co., and it was at once re-started under the direction of Mr. E. Bury, M.Sc., the Manager of the Coke Oven Plant, who maintained it in continuous commission for three months until the great coal-strike of 1912 brought everything to a standstill.

At the end of July, 1912, after altogether five months actual running, exhaustive trials were made under the personal superintendence of an eminent American steam engineer who had crossed the Atlantic with a commission to investigate the boiler; he subsequently reported the following results of a ten-hours steam trial on July 29, which speak for themselves

RESULTS OF STEAM TRIAL, JULY 29, 1912

Duration of test in hours	10
Mean steam gas pressure, lbs. per sq. in. above atmospheric	97.2
Total gas burnt, cub. ft. at N.T.P.	101,853
Net cal. value of gas, B.Th.U.s. per cub. ft. at N.T.P.	510.5 ¹
Total net heat supplied, B.Th.U.s.	52,003,996
Temperature of products leaving boiler, Fahr. Degrees	386° (196° C.)
Temperature of products leaving feed-water heater, Fahr. Degrees	202° (94.6° C.)
Total water evaporated, lbs. from and at 212° Fahr.	49,824
Evaporation in lbs. per sq. ft. of heating surface per hour.	14.1
Per cent. Dryness of steam	99.3
Total heat utilised, B.Th.U.s.	48,208,399

¹ An analysis of a typical example of the gas gave:—

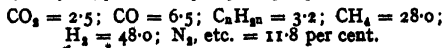

‘SURFACE COMBUSTION’

$$\text{Ratio } \frac{\text{Heat utilised}}{\text{Net heat supplied}} = 0.927^1$$

$$\left. \begin{array}{l} \text{Power taken by fan} \\ \text{[Suction = 20 in. W.G.]} \end{array} \right\} = 6097 \text{ watts} = (\text{say}) 8.2 \text{ H.P.}$$

The heat balance of the test is as follows, and for purposes of comparison I will give the heat balance for a trial of a marine boiler fired with a good steam coal of net calorific value 13,800 B.Th.U.s. per lb. (volatile matter = 16.1 per cent.).

TABLE LXXIX

	Gas-fired Surface Combustion Boiler.	Coal-fired Marine Boiler
<i>Heat utilised</i>	Per cent. 92.7 ²	Per cent. 75.1
<i>Heat lost</i> } in Burnt Gases	3.0	18.1
} in Unburnt Gases	nil	2.8
} by Radiation, etc. . . .	4.3	4.0
	100.0	100.0
Rate of Evaporation in lbs. per sq. ft. heating surface per hour . .	14.1	4.3

The engineer who superintended these trials was very anxious to find out whether, in view of the intensity of the combustion and the high rate of heat transmission, the boiler tubes after five months continuous running day and night would show any signs of deterioration. Consequently, one of the boiler tubes, selected by him, was cut out and subjected to severe mechanical tests, similar tests being simultaneously made with a new and unused boiler tube of same dimensions. The results proved conclusively that the five months service had not in any way impaired the mechanical properties of the boiler tubes, thus falsifying the

¹ It should be stated that the boiler was *not* lagged during the trial, otherwise this figure would have been about 0.94.

² Deducting the steam equivalent of the power consumed in driving the fan on the Skinningrove boiler, the “*over-all efficiency*” of the plant is *practically 90 per cent.* To complete the comparison, the coal-fired boiler should be similarly debited with the power (whether human or mechanical) expended in stoking.

COAL AND ITS SCIENTIFIC USES.

confident predictions of several critics that the tubes would be speedily burnt through:—

	New Tube.	Old Tube after 5 Months' Service.	
		Front End of Boiler.	Back End of Boiler.
Ultimate tensile strength, tons per sq. in.	25·3-27·1	27·9-29·6	29·7-31·6
Elastic limit	11·9-14·4	20·05	19·3-20·5
Per cent. elongation on 8 in. length .	23-24	19-21	18-23
Per cent. area contraction	55·6-58·8	61·3-63·1	53·4-61·3

The new tube was slightly thinner than the old one, and therefore the better comparison would be between the results obtained for the specimens taken from the *front* and *back* ends of the old tube, because, whereas the specimen from the front end had surrounded the intensely heated "zone of combustion," that from the back end had never been subjected to a higher temperature than that of the water in the boiler (say 168° C. or 335° F.). The results of the tests show practically no difference between the mechanical strengths of the two specimens. Perhaps the best testimonial to the success of this initial installation of a large boiler on the new principle is the fact that the Skinningrove Iron Co. have put down a second unit for their new battery of coke ovens, which is now being started up, and I expect, within a few weeks at most, to see the two boilers working side by side.

Within the last few months the firm of Krupps have put down a boiler in connection with one of their coking plants in the Ruhr district of Westphalia, from the plans of the Skinningrove plant. This boiler has been running successfully since October last, and about three weeks ago underwent its official steam trials, which were carried out by the Bergbauliche Verein. Pending the official publication of the results in the German technical press, I am precluded from giving any details to-night, but an unofficial test on October 30, 1913, showed a total evaporation of 6750 lbs. of water "from and at 212° Fahr." per hour, with an efficiency ratio of 0·925; and I am informed that the results of the recent official tests have confirmed these satisfactory figures.

As this is the first occasion on which I have been able to refer in public to the successful inauguration of these inventions on a

'SURFACE COMBUSTION'

commercial scale in Germany, and in anticipation of the publication of the results of the official German trial, I wish, with your kind permission, to mention a matter which, although it may appear personal, is nevertheless bound up with the credit of British scientific invention.

This boiler, invented and developed as it was in Leeds, by a group of British chemists, all University trained men, aided by the advice of Mr. Michael Longridge and by the enterprise of my friends of the Skinningrove Iron Co., may truly be claimed as an "all-British" invention, if ever there was one. Nevertheless, it has recently been described in the German technical press as the "Bone-Schnabel," or the "Schnabel-Bone" boiler, instead of the "Bonecourt" boiler, as it should be. It may be necessary at some future time to deal more fully with this aspect of the matter, but to-night I will content myself with a protest against any attempt to claim or represent this boiler as, in part, a German invention.

I have perhaps said enough already about the boiler and its working; to convince you that it combines high thermal efficiency and concentration of power, in a unique degree, and perhaps I may be permitted to summarise the other important advantages which may be claimed for it. *Firstly*, from the constructional point of view, nothing could be simpler or more compact than a cylindrical shell only 4 ft. long by 10 ft. in diameter, traversed by straight tubes, supported on a casting, and requiring neither elaborate brickwork setting nor expensive chimney flues and stack. *Secondly*, it has a further advantage over all multitubular boilers in that the front plate can never be heated beyond the temperature of the water, however much the firing may be forced, a circumstance which, coupled with the extremely short length of the tubes, implies an absence of strain and greatly reduces the risk of leaky joints. *Thirdly*, the high rate of mean evaporation obviates scaling troubles, and the very steep evaporation gradient along each tube causes a considerable natural circulation of water in the boiler, a factor of great importance from the point of view of good and efficient working. In this connection I may remind you that under normal working conditions we obtain a *mean evaporation* of 20 lbs. per sq. ft. of heating surface per hour, and can, if need be, force this up to 35 lbs.; of this total evaporation, 70 per cent. occurs over the first *third* length of the tube, 22 per cent. over the *second* third, and only 8 per cent. over the last third. *Fourthly*, inasmuch as each tube

of the boiler is, so to speak, an independent combustion unit, capable of being shut off or lit up without affecting the others, and as it only takes five minutes after lighting up a cold tube to attain its maximum steam output, it is obvious that not only is such a boiler highly responsive to rapid variations in the load, but also it works with equal efficiency at both small and big loads; indeed, within very wide limits, its efficiency is practically independent of the load.

I have endeavoured, within the hour, to trace the history of an idea from its inception in the laboratory through its experimental stages right up to its successful technical applications. Modern chemistry originated in the primeval instinct of "fire-worship," and even a century after Davy's work, the science of combustion is not yet a completed record. On the theoretical side, there are still obscure points concerning the mechanism of "surface combustion" for future investigation, and it will probably take many years to realise the wide range of industrial possibilities in gas-firing already opened up, not to speak of the equally important problem of "oil-firing." The number of applications of "surface combustion" which have been pressed upon our attention from without is positively embarrassing, and the task of fulfilling all expectations in the near future is indeed formidable. I hope, however, I have succeeded in convincing you that a sound foundation has been laid, upon which may be reared an enduring edifice.

ADDENDA

A. *Surface Combustion Boilers.*—Although a boiler with tubes 4 ft. long by 3 in. in diameter packed with loose fragments of a suitable granular refractory material, as described in the foregoing lecture, is eminently suitable for use with a perfectly clean (*i. e.* dustless and tarless) gas, such as coke-oven gas, it has been found advisable, when dealing with gases, such as producer gas, which are liable to contain dust or tar, to substitute a special rigid system of refractory surfaces (Fig. 93) over which the combustible mixture sweeps and in contact with which it is burnt at a highly accelerated rate.

As the result of a long series of experimental trials it was found possible, with the new packing, to increase the diameter of the boiler tubes from 3 to 4½ in., or even 6 in., and their length from 4 ft. to between 13 and 21 ft. without impairing materially

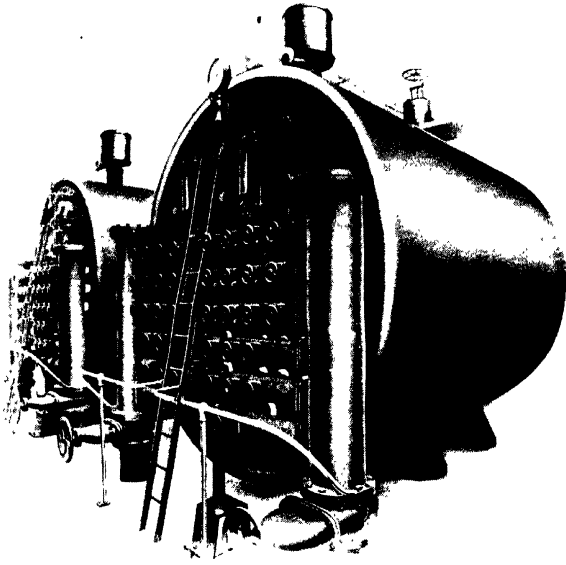

FIG. 91.—Front View of Bonecourt Surface Combustion Boiler

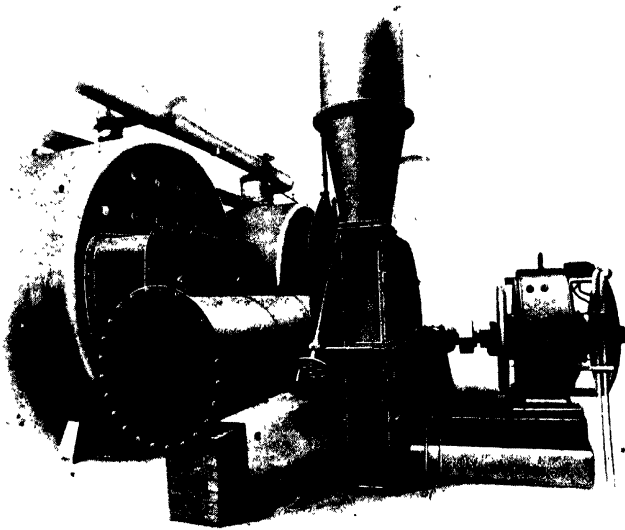

FIG. 92.—Back View of Bonecourt Surface Combustion Boiler.

'SURFACE COMBUSTION'

the high rate of evaporation per sq. ft. of heating surface. As the result of these alterations the number of tubes, and, therefore, of burners necessary to secure a given evaporative power in the boiler, has been greatly reduced, and, by increasing the length of the tubes up to 21 ft., it is now possible to design a boiler containing 220 tubes each $4\frac{3}{8}$ in. in diameter which, with producer gas, will evaporate 70,000 lbs. of water per hour from and at 212° Fahr.

In Figs. 91 and 92 are shown the front and back views of two boilers, each 10 ft. in diameter by 15 ft. long, fitted with 38 tubes of 6 in. diameter which are successfully working at a factory in the Midlands upon ammonia-recovery producer gas. The tubes are packed with a rigid system of specially moulded refractory blocks one section of which is shown in Fig. 93.

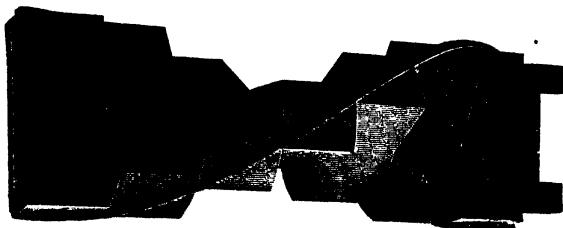

Fig. 93.—Refractory Blocks used in Bonecourt Boilers.

Each such section of blocks fits into the next one until the boiler tube is wholly filled with them from end to end. Each of the 38 tubes in the boiler is provided with its own gas supply which can be easily regulated by means of a wheel-valve on the boiler front, whilst the air requisite for combustion, together with a regulated proportion of gas, is drawn into each tube, through a short mixing chamber, by the suction (up to 16 in. water gauge) of an electrically driven fan situated at the back of the installation.

Each of the two boilers in question will evaporate up to 30,000 lb. of water from and at 212° Fahr. per hour. The combustion in the tubes is perfect, and when the gauge pressure of steam in the boiler is 85 lbs. per sq. in. (equals, say, 100 lbs. absolute pressure) the products leave the system (there being no feed-water heater included in the installation) at 250° C. containing:—

$\text{CO}_2 = 18.1$, $\text{CO} = \text{nil}$, $\text{O}_2 = 1.2$, and $\text{N}_2 = 80.7$ per cent.

COAL AND ITS SCIENTIFIC USES

So well is the boiler lagged, and so little cold air circulates through the setting when the fan is stopped, that after shutting down with 85 lb. gauge pressure of steam at 6 p.m., no less than 60 lb. pressure is retained 12 hours afterwards, and the original pressure is restored in about 10 minutes after firing up again.

The latest development in Boncourt boiler design, which has resulted from experiments carried out by Mr. P. St. G. Kirke, M.A., in London, has been in the direction of designing boilers for power-station work in which the gaseous combustion, super-heating of steam, and feed-water heating, are all combined in one boiler shell. Details of these developments are, however, reserved for future publication.

A number of successful experimental trials carried out before the outbreak of war gave satisfactory proof that the system can be adapted to the oil-firing of boilers.

B. Waste Heat Boilers.—The Boncourt principle of using multitubular boilers packed with refractory material, besides being highly efficient for gaseous firing, where the combustion is accelerated by contact with the incandescent surfaces, has also proved itself to be eminently adapted for the rapid extraction of heat from burnt products of combustion. This is doubtless due to the high velocity with which the gases traverse the packed tubes, and to their constant deflection at varying angles against the walls of the tube, factors which the investigations of the late Dr. Nicolson (*vide* Chapter XI) proved to be essential to rapid heat transmission. Boncourt Waste Heat Boilers have been designed to raise steam from the sensible heat in the burnt gases from non-regenerative coke ovens, open hearth furnaces, gas retort settings, gas engines, and the like, with efficiencies of from 50 to 80 per cent. dependent upon the temperature of the particular form of "waste heat," which may be anything between 400° and 1000° C.

C. Furnaces.—The applications of Surface Combustion to industrial furnaces have been more largely developed in America than in this country. This has perhaps been due to the great interest aroused there in such possibilities during the author's visit in 1911, when he found that the certainty and ease with which high temperatures are attained by surface combustion methods strongly appealed to American technologists, whose attitude seemed uniformly keen and receptive towards new ideas and practice.

With regard to the high temperatures attainable with towns

'SURFACE COMBUSTION'

gas in surface-combustion furnaces, without any regenerative devices whatsoever, it may be stated that during his Lectures before the American Gas Institute at St. Louis on October 19, 1911, the author melted platinum in a small crucible furnace with carburetted water gas (as locally supplied) within 20 minutes from starting "all cold." Also that, subsequently to his Lecture, a further independent trial was made at Philadelphia "with the object of determining the maximum temperature obtainable by means of artificial illuminating gas . . . an alumina crucible of an extremely high refractory character containing a Seger Cone No. 39 was completely melted down showing that a temperature approximating 2000° C. had been obtained."¹

In the year 1916 the following communication was made by the U.S. Bureau of Standards to the Franklin Institute at Philadelphia:—

"In view of the fact that surface combustion processes appear to offer many advantages for high-temperature laboratories in which the Bureau is interested, it was decided to submit a crucible furnace of this type to a thorough test. For this purpose the furnace was equipped with meters in the gas and air line and with a chimney to permit the collection of gas samples. In several runs the mixture proportions were maintained constant, while varying the rate of gas consumption. Temperature were read by a Holborn-Kurlbaum optical pyrometer. The highest temperature reached was 1675° C., at which point the muffle failed. The test established that complete combustion could be obtained without excess of air; that the best air-gas ratio was 5.5, and that a 20 per cent. excess of air caused lowering of the furnace temperature of 100°."²

According to American reports, several surface combustion furnace plants have been successfully installed in that country since the outbreak of the war, of which the following typical case may be recorded here. The Eddystone Ammunition Co. of Eddystone, Pa., laid down, in 1916, a large installation of "surface combustion" gas-fired furnaces for hardening and tempering 3-in. steel shells. This installation comprised three sets, each set working as a distinct unit, and consisting of

¹ *Journal Franklin Institute*, Feb. 1912, p. 128.

² *Journal of Gas Lighting* (now the *Gas Journal*), 1916, 133, p. 263. It should be noted that the highest temperature attained in this trial was that at which the muffle (? crucible) collapsed rather than that which might have been reached had it been made of more refractory material.

COAL AND ITS SCIENTIFIC USES.

hardening and tempering furnace (outside dimensions = 22 ft. long by 8 ft. wide by 7 ft. high). The shells were $8\frac{1}{2}$ in. long by 3 in. diameter (weight = 8 to 10 lbs.) and were "hardened" at 1500° Fahr. and "tempered" at 1100° Fahr. The hourly consumption of gas (calorific value = 580 B.Th.U.s.) per unit (*i. e.* one hardening and one tempering furnace) was 3300 cub. ft. for an output of 340 shells. Shortly after the first two units had been put in operation, it was reported that they had proved "fully equal to all expectations." They are fired by the surface combustion high-pressure system, in which high-pressure gas is made to inspire the air necessary for complete combustion and automatically maintain a constant proportion in the mixture. Analyses of the flue gases had proved the absence of both oxygen and carbon monoxide, whilst they contained 15.2 per cent. of carbon dioxide. The combustion efficiency was, therefore, 100. It was stated that the efficiency of the installation as a whole, *i. e.* the ratio of the energy actually utilised in heating the metal put through to that developed by combustion, was 32 per cent., which for such operations as hardening and tempering may be regarded as very satisfactory.¹

A more recent development in the United States is in connection with the welding of tool steel to soft steel.²

The possibilities of attaining high temperatures very economically by burning low-grade gases, such as producer gas, in a surface combustion furnace under regenerative conditions, may be illustrated by the following experimental trial carried out in London under the late Mr. C. D. McCourt's supervision. The furnace was of the type illustrated in Fig. 84 of the author's 'Royal Institution' Lecture, in which the working space (3 ft. 1 in. long by 3 ft. 2 in. wide by 1 ft. 6 in. high) was heated by two parallel surface combustion beds, and it was also provided with regenerators of the tubular type, for the continuous preheating of both gas and air supplies at the expense of the sensible heat of the burnt gases from the furnace. In the trial in question it was fired by washed producer gas generated from anthracite, the average percentage composition of which was:—

$\text{CO}_2 = 5.60$, $\text{CO} = 23.60$, $\text{H}_2 = 15.50$, $\text{CH}_4 = 1.50$,
and N_2 , etc. = 53.8 per cent.
(net calorific value = 139 B.Th.U.s. per cubic foot at 0°C .
and 760 m.m.)

¹ See *Journal of Gas Lighting*, 1916, 186, p. 603.

² *Gas Journal*, 1917, 189, p. 462.

'SURFACE COMBUSTION'

The furnace, having been started up early in the morning, systematic observations were made throughout the day of (a) rate of gas consumption, by means of a wet meter on the main gas supply, (b) furnace temperature, and (c) temperature of the hot gas and hot air leaving the regenerators as well as of the burnt products leaving the system. The trial was continued over a total period of 9 hours (8 a.m. to 5 p.m.), during the last two or three of which a steady temperature of about 1400° C. was maintained in the furnace.

The principal observations made during the trial are here tabulated :—

TABLE LXXX

Hour.	Rate of Gas Consumption Cub. Ft. per Hour.	Furnace Temperature ° C..	Temperatures of		
			Hot Gas ° C.	Hot Air ° C.	Burnt Products ° C.
9.35 a.m. . .	7630	800°	105°	145°	172°
10.0 „ . . .	7280	985°	129°	191°	206°
11.0 „ . . .	6720	1220°	184°	264°	283°
12.0 noon . . .	6280	1305°	231°	309°	—
1.30 p.m. . . .	4920	1365°	295°	—	—
3.45 „	5200	1410°	320°	—	400°
5.0 „	4920	1395°	—	—	390°

Analyses of the burnt gases leaving the furnace were made at intervals, as follows :—

	10 a.m.	Noon.	3 p.m.	Mean.
CO ₂	16.4	16.7	17.0	16.70
CO	0.3	0.2	0.2	0.23
O ₂	2.0	2.4	2.0	2.13
N ₂	81.3	80.7	80.8	80.94

From these results it is clear that not only was the combustion practically perfect with a minimum excess of air, but that a temperature of 1400° C. could be easily maintained in the furnace with the burnt gases leaving the system at no more than 400° C.

D. *The Melting of Easily Fusible Metals and Alloys.*—As an example of how the principle embodied in the Boncourt boilers may be adapted to the continuous melting of easily fusible metals such as lead or type metal, the author will now give the results of an experimental trial carried out under his personal direction some years ago in Leeds.

COAL AND ITS SCIENTIFIC USES

The apparatus used (Fig. 94) consisted of an iron tank, efficiently lagged, and filled up to the top with molten lead at a temperature about 50° C. above its melting point. In the molten bath was fixed a vertical iron tube, 3 ft. long by 3 in. internal diameter, packed with suitable granular refractory material. At the bottom of the tube was a tightly fitting cylindrical plug, bored with a circular $\frac{3}{4}$ -in. passage for the admission of the explosive mixture of gas and air, which burnt flamelessly as it impinged upon the incandescent granular material immediately above the plug. The burnt products passed upwards through the remainder of the packing, quickly imparting their

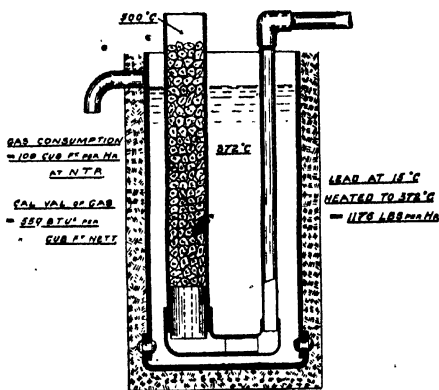

FIG. 94.

residual heat to the remainder of the bath, and finally made their exit through the open end of the tube at a temperature only 130° C. above that of the molten metal in the bath.

Suitable arrangements were made for the introduction of the explosive mixture of gas and air burnt in the tubes. Care was taken to maintain a constant temperature of 372° C. (as ascertained by a standard thermojunction) in the molten bath throughout the experiment. Lead ingots, each weighing 30 lb., were added at regular intervals of $1\frac{1}{2}$ minutes, and the molten metal thereby displaced was simultaneously run off into moulds. Burning towns gas of net calorific value 559 B.Th.Us. per cub. ft., at a rate of 100 cub. ft. per hour, it was possible to raise the temperature of no less than 1176 lbs. of lead per hour from 15° C.

‘SURFACE COMBUSTION’

to 372° C., the temperature of the products of combustion leaving the tube being only 500° C., as follows:—

	° Cent.	° Fahr.
Temperature of Metal charged	15°	60°
Temperature of Metal tapped	372°	702°
Temperature of burnt gases leaving the apparatus	500°	932°
Lead melted per hour = 1176 lbs.		
Gas burnt per hour = 100 cub. ft. at 0° C. and 760 m.m.		
Net Cal. Value of gas = 559 B.Th.U.s. per cub. ft. at 0° C. and 760 m.m.		

Taking the latest determination by Spring of the specific heats of lead up to and above its melting point, and adopting the usually accepted value for its latent heat of fusion, we get the following ratio:—

$$\begin{array}{l}
 \left. \begin{array}{l}
 \text{Heat required to raise} \\
 1176 \text{ lbs. of lead from} \\
 15^\circ \text{ C. to } 372^\circ \text{ C.}
 \end{array} \right\} = 1176 \times 32.67 = 38,420 \text{ B.Th.U.s.} \\
 \left. \begin{array}{l}
 \text{Net Heat developed by} \\
 \text{combustion of 100 cub.} \\
 \text{ft. of gas}
 \end{array} \right\} = 100 \times 559 = 55,900 \text{ B.Th.U.s.} \\
 \text{Ratio} = \frac{38,420}{55,900} = 0.686
 \end{array}$$

If, however, due allowance be made for the fact that the temperature of the gases leaving the combustion tube could not have been reduced to below that of the molten metal in the bath (372° C.), the “thermodynamical efficiency” of the melting operation was practically 80 per cent. of that theoretically possible.

The author desires to draw special attention to the above results, which have been repeated and confirmed on many different occasions, because it has come to his knowledge that attempts have been made to apply surface combustion to lead melting in far less efficient ways.

In concluding this short review of “Surface Combustion,” the author wishes to pay a heartfelt tribute to the memory of his gifted friend and collaborator in this investigation, Cyril Douglas McCourt, who, shortly after the outbreak of the war, exchanged the research work to which he was so passionately

COAL AND ITS SCIENTIFIC USES.

devoted for a commission (Sec. Lieut.) in the Army, where he anticipated that his scientific training and knowledge of the management of men would stand him and his country in good stead. He laid down his life for his country while gallantly leading, as bombing officer, an attack made on the German lines in France on the night of October 8, 1916.

APPENDIX

Coal Consumption in Germany and in the United States

WHILST this volume was going through the press, Sir Robert Hadfield kindly drew the author's attention to the following estimates of the consumption of coal for various purposes in Germany and the United States. The subject is more fully dealt with in Sir Robert Hadfield's Presidential Address to the Society of British Gas Industries (April 18, 1918), in which also will be found a great deal of other interesting information relative to Fuel, Gas, and Electric Power.

Germany

According to statistics given in a paper read by Professor G. Klingenberg of Berlin before the Engineering Association of Germany on November 24, 1917, the distribution of the 187 million tons of bituminous coal raised in Germany in the year 1913 was approximately as given in Table on page 478.

Comparing these figures with those given in Chapter I for Great Britain, it will be seen (1) that 54 million tons of coal were carbonised with by-product recovery in German gas works and coking plants in the year 1913 as against only about 30 million tons in Great Britain. This is entirely due to the much greater development of the by-product coking industry in Germany than in Great Britain, for in Germany the manufacture of towns gas in gas works has never reached such huge dimensions as it has with us; (2) that the domestic consumption of coal in Germany is only about one-half what it is in Great Britain; and (3) that about 22.5 per cent. of the electric current used in Germany is generated in public power stations.

APPENDIX

<i>Purposes.</i>	<i>Million Tons.</i>	<i>Per Cent.</i>	<i>Total Per Cent.</i>					
1. <i>Carbonisation with Complete By-product Recovery.</i>	<table style="display: inline-table; vertical-align: middle;"> <tr> <td style="font-size: 3em; vertical-align: middle;">{</td> <td style="padding-left: 10px;">Coke Ovens . . . 44.0 . .</td> <td style="padding-left: 10px;">23.4</td> </tr> <tr> <td style="font-size: 3em; vertical-align: middle;">}</td> <td style="padding-left: 10px;">Gas Works . . . 10.0 . .</td> <td style="padding-left: 10px;">5.3</td> </tr> </table>	{	Coke Ovens . . . 44.0 . .	23.4	}	Gas Works . . . 10.0 . .	5.3	28.7
{	Coke Ovens . . . 44.0 . .	23.4						
}	Gas Works . . . 10.0 . .	5.3						
2. <i>Electric Power Production in which Partial Recovery of By-products is possible.</i>	<table style="display: inline-table; vertical-align: middle;"> <tr> <td style="font-size: 3em; vertical-align: middle;">{</td> <td style="padding-left: 10px;">Public Electricity Works 5.5 . .</td> <td style="padding-left: 10px;">2.9</td> </tr> <tr> <td style="font-size: 3em; vertical-align: middle;">}</td> <td style="padding-left: 10px;">Industrial Establishments . 18.7 . .</td> <td style="padding-left: 10px;">10.0</td> </tr> </table>	{	Public Electricity Works 5.5 . .	2.9	}	Industrial Establishments . 18.7 . .	10.0	12.9
{	Public Electricity Works 5.5 . .	2.9						
}	Industrial Establishments . 18.7 . .	10.0						
3. <i>Industrial Uses in which By-product Recovery is precluded.</i>	<table style="display: inline-table; vertical-align: middle;"> <tr> <td style="font-size: 3em; vertical-align: middle;">{</td> <td style="padding-left: 10px;">Manufacturing . . . 26.3 . .</td> <td style="padding-left: 10px;">14.1</td> </tr> <tr> <td style="font-size: 3em; vertical-align: middle;">}</td> <td style="padding-left: 10px;">Agriculture . . . 7.5 . .</td> <td style="padding-left: 10px;">4.0</td> </tr> </table>	{	Manufacturing . . . 26.3 . .	14.1	}	Agriculture . . . 7.5 . .	4.0	18.1
{	Manufacturing . . . 26.3 . .	14.1						
}	Agriculture . . . 7.5 . .	4.0						
4. <i>Transport.</i>	<table style="display: inline-table; vertical-align: middle;"> <tr> <td style="font-size: 3em; vertical-align: middle;">{</td> <td style="padding-left: 10px;">Railways . . . 17.5 . .</td> <td style="padding-left: 10px;">9.3</td> </tr> <tr> <td style="font-size: 3em; vertical-align: middle;">}</td> <td style="padding-left: 10px;">Navigation . . . 10.0 . .</td> <td style="padding-left: 10px;">5.3</td> </tr> </table>	{	Railways . . . 17.5 . .	9.3	}	Navigation . . . 10.0 . .	5.3	14.6
{	Railways . . . 17.5 . .	9.3						
}	Navigation . . . 10.0 . .	5.3						
5. <i>Domestic Consumption</i> 17.0 . .	9.1	12.6					
6. <i>Briquetting Plants</i> 6.5 . .	3.5						
7. <i>Surplus for Exportation</i> 24.0 . .	13.1	13.1					
	187.0	100.0						

It is interesting to note that in the opinion of the German writer in question the idea that the heat required for domestic heating purposes might in future be supplied to consumers in the form of gas only is mistaken and devoid of prospect, because in that case the gas works would have to be planned for the maximum demand in winter, and their working capacity would be very badly utilised during the greater part of the year. On the other hand, he thinks it is far cheaper to cover the great requirements of heat in winter by the accumulation of stacks of coke at the gas works and of coals and block fuel at the collieries and coal merchants, for, he says, a simple computation will show that the mechanical transport of caloric energy by the conveyance of coal by canal or rail is, in the majority of cases, cheaper than the delivery of gas through a pipe system over large distances. The opinion is also expressed that, although the gasification of coal used for railway purposes is closely

APPENDIX

ound up with the electrification of the lines, it is questionable whether such a policy is practicable within a measurable period.

The United States

According to a paper read before the American Society of Mechanical Engineers by Professor L. P. Brekenridge, of New Haven, Connecticut, the total production of anthracite and bituminous coal in the United States from 1807 to 1915 was as follows :—

<i>Period.</i>	<i>Million Tons.</i>
1807-1825	0·5
1826-1835	4·0
1836-1845	23·0
1846-1855	84·0
1856-1865	174·0
1866-1875	490·0
1876-1885	848·0
1886-1895	1586·0
1896-1905	2832·0
1906-1915	4919·0
Total	<u>10890 approx.</u>

In the year 1915 the total coal raised in the States was 534 million tons, of which 89 million tons were anthracite and 445 million tons bituminous coals. The distribution of the huge output was somewhat as follows :—

	<i>Anthracite.</i> <i>Mill. Tons.</i>	<i>Bituminous.</i> <i>Mill. Tons.</i>	<i>Total.</i> <i>Mill.</i> <i>Tons.</i>
1. Domestic and Small Steam Purposes	47	71	118
2. Industrial Steam Purposes	32	144	176
3. Railways	6	122	128
4. { Bee-hive Coking Ovens	—	42	62
{ By-product Coking Ovens	—	20	
5. Coal Gas Works	—	5	5
6. Steam and Heat at Mines	—	10	10
7. Bunker Coal for Steamships	—	11	11
8. Exported	4	20	24
	<u>89</u>	<u>445</u>	<u>534</u>

APPENDIX

It has been estimated that in 1917 the total coal production in the United States was not less than 700 million tons, and that in the current year (1918) it will be greater still.

There can be little doubt but that, owing to the low cost of getting coal in the States, the question of fuel economy has, up to the present, received even less attention in America than with us. But there are not wanting signs that American engineers are now becoming alive to the importance of checking the extravagant use of fuel which goes on in their country. One prominent engineer has stated that of the 469 million tons which he estimates were burnt in the States for steam-raising purposes in the year 1917, no less than 117 million tons were wasted by inefficient methods, hundreds of boiler plants operating at a no greater efficiency than 58 per cent. Mr. E. W. Rice, Jr., President of the American Institution of Electrical Engineers, has expressed the opinion that 100 million tons of coal per annum could be saved by electrifying all the railways in the States.

BIBLIOGRAPHY

THE following is a list, though by no means an exhaustive one, of some of the best works of reference upon Coal, excluding original memoirs published in scientific and technical journals that have already been mentioned in the text of this volume.

A.—General, Statistical, and Geological

1. *The Coal Question*, by W. Stanley Jevons. New and revised Edition, edited by A. W. Flux. (Macmillan & Co., Ltd., 1906.)
2. *The British Coal Trade*, by H. S. Jevons. (Kegan, Paul, & Trench, Trübner & Co., 1915.)
3. *Report of the Royal Commission on Coal Supplies*, 1905.
4. *Report of the Coal Conservation Committee*, 1918.
5. *Report of the British Association Fuel Economy Committee*, 1916.
6. *First Report of the Fuel Research Board*, 1917.
7. *Report of the International Geological Congress on the World's Coal Resources*. 3 vols. and maps, 1913.
8. *Report of the Coal Testing Plant of the U.S. Geological Survey at the Louisiana Purchase Exposition, St. Louis, Ind.* 3 vols., 1906.
9. *Bulletins of the U.S. Geological Survey and of the U.S. Bureau of Mines*.
10. *University of Illinois Bulletins*.
11. *An Investigation of the Coals of Canada*—Canadian Department of Mines, 1912-13. 6 vols.
12. *The Utilisation of Peat Fuel*, by J. B. F. Haanel, Canadian Department of Mines.
13. *Peat, Lignite, and Coal*, by J. B. F. Haanel, Canadian Department of Mines, 1914.
14. *Investigation of the Peat Bogs and Peat Industries of Canada*, by A. V. Anrep, Canadian Department of Mines.
15. *The Brown Coal Industry in Germany and Austria*, by James Stirling, Victoria Department of Mines, 1901.

BIBLIOGRAPHY

16. *Coalfields of Great Britain*, by Edward Hull. (Ed. Stanford, Ltd., London, 1881.)
17. *Geikie's Geological Map of England and Wales*. (Bartholomew & Co., 1897.)
18. *Series of Maps of the Coalfields of Great Britain*, published by W. A. K. Johnston & the Colliery Guardian Co., Ltd.
19. *The Coals of South Wales*, by Drs. A. Strahan and W. Pollard. (*Memoirs of the Geological Survey of England and Wales*, 2nd Edition, 1915.)
20. *The Geology of Coal and Coal Mining*, by Dr. Walcot Gibson. (Ed. Arnold, London, 1908.)
21. *The Natural History of Coal*, by E. A. N. Arber. (Cambridge University Press, 1911.)

B.—Chemical and Technical

22. Articles on "Fuel" (W. A. Bone), "Coke Manufacture and the Recovery of By-products" (E. Bury), "Gas, Coal" (H. G. Colman), and "Gas, Water" (V. B. Lewes) in Thorpe's *Dictionary of Applied Chemistry*, Vol. II. (Longmans, Green & Co.)
23. *Metallurgy*: Part I., "Fuel," by Dr. John Percy. (John Murray, 1875.)
24. Groves and Thorp's *Chemical Technology*: Vol. I., "Fuel," by Mills and Rowan.
25. *Fuel*, by J. S. S. Brame. (Ed. Arnold, 2nd Edition, 1917.)
26. *Fuel Economy and the Utilisation of Coal*. Reprint of three Lectures at the Royal Institution, 1916, by W. A. Bone. (Walter King.)
27. *Analyses of British Coals*, compiled by A. Greenwell and J. V. Elsdon. (Colliery Guardian Co., Ltd., 3rd Edition, 1909.)
28. *The Examination of Thermal Values of Fuels*, by J. H. Coste and E. R. Andrew. (Griffin & Co., 1901.)
29. *Cellulose*, by Cross and Bevan. (Longmans, Green & Co., New Edition, 1916.)
30. *Researches on Cellulose*, 3 vols. (1895-1900; 1900-5; 1905-10), by Cross and Bevan. (Longmans, Green & Co.)
31. *Steinkohlenchemie*, by Muck.
32. *Heat Energy and Fuels*, by H. von Juptner, trans. by O. Nagel. (McGraw Publishing Co., New York, 1908.)

BIBLIOGRAPHY

33. *Heat Transmission*, by W. E. Dalby. Report issued by the Institution of Mechanical Engineers, 1909.
34. *Steam Power*, by W. E. Dalby. (Ed. Arnold, London, 1915.)
35. *Steam Boilers*, by W. Inchley. (Ed. Arnold, 1912.)
36. *Kempe's Engineers' Year Book*. (Crosby, Lockwood & Son.)
37. *Smoke Abatement*, by William Nicholson. (Griffin & Co., 1905.)
38. *Smoke Prevention and Fuel Economy*, by W. H. Booth and J. B. C. Kershaw. (Constable & Co., Ltd., 1911.)
39. *Smoke—A Study of Town Air*, by J. B. Cohen and A. G. Ruston. (Ed. Arnold, London, 1912.)
40. *The Carbonisation of Coal*, by V. B. Lewes. (John Allan & Co., 1912.)
41. *Gas Manufacture*, by W. J. A. Batterfield. 2 vols. (Griffin & Co., 1905.)
42. *Modern Retort Settings*, by T. Brooke. (John Allan & Co., 1912.)
43. *Purification of Gas by Heat*, by Charles Carpenter. (South Metropolitan Gas Co., 1914.)
44. *Handbook for Gas Engineers and Managers*, by Thos. Newbigging. (Walter King, 4th Edition, 1913.)
45. *By-product Coking*, by G. S. Cooper. (Benn Bros., 1917.)
46. *Chemistry of Coke*, by W. Carrick Anderson. (Hodge & Co., 2nd Edition, 1904.)
47. *Coal Tar and Ammonia*, by G. Lunge. (3 vols., Gurney & Jackson, 5th Edition, 1916.)
48. *Producer Gas*, by A. Humboldt Sexton. (Scientific Publishing Co., Manchester.)
49. *Producer Gas*, by J. E. Dowson and A. T. Larter. (Longmans, Green & Co., 1908.)
50. *Chemical Phenomena of Iron Smelting*, by Lowthian Bell. (Routledge & Co., Ltd., 1872.)
51. *Principles of the Manufacture of Iron and Steel*, by Lowthian Bell. (Routledge & Co., Ltd., 1884.)
52. *Gas, Petrol, and Oil Engine*, by Dugald Clerk. 2 vols. (Longmans, Green & Co., 1909.)
53. *Howard Lectures on Surface Combustion*, by W. A. Bone. (Royal Society of Arts, 1914.)
54. *Thermodynamics of Gas Reactions*, by F. Haber, trans. by A. B. Lamb. (Longmans, Green & Co., 1908.)

INDEX OF SUBJECTS

- ACETYLENE, 137, 138, 144, 145, 146; Calorific value of, 264
- Alloys, melting by Surface Combustion, 473
- Ammonia Recovery Systems, 360; Crossley and Rigby, 366; Lymn, 368; Mond, 360; Moore, 366
- Ammonium Sulphate, statistics concerning production of, 18
- Aniline, action on coal of, 94
- Anthracite Stoves, 227
- Anthracites. *See* Coals, Anthracitic.
- Ashes, from coal, 38; compositions of, 40; melting points of, 41; sulphur in, 133
- Baum Washery, 44
- Beehive Coke Ovens. *See* Coke Ovens.
- Benzene, action on Coal of, 95; calorific value of, 252; density of, 252
- Berthelot Mahler Bomb Calorimeter, 60
- Bituminous Coals. *See* Coals, Bituminous.
- Blast Furnace, Bell's investigations, 391; by-product coke ovens as adjunct to, 408; chemical changes in, 394; consumption of coke in (historical), 391; heat balance of, 398; use of dried air in, 422
- Blast Furnace Gas, 252; cleaning of, 406; composition of, 405; development of engines for, 409; dry cleaning of, 417; firing of Cowper stoves by, 401; history of, 400; power production from, 415; steam raising in boilers by, 402; Theissen washers for, 406; utilisation of, 400
- Blue Water Gas, 381
- Boilers, avoidance of unsoftened "Hard Feed" water in, 209; Bettington, 313; Bonecourt Surface Combustion, 459, 462, 465, 468; Bonecourt Waste Heat, 473; chimney losses in, 197; dead gas-films in, 206; forced draught in, 194; heat transmission in, 184, 204, 206; high gas velocities in, 209; imperfect combustion of fuel in, 190; induced draught in, 194; mechanical stoking for, 195; Nicolson, 210; radiation in, 205; selection of fuels for, 186; steam-raising by blast-furnace gas in, 402
- Boiler Practice, heat losses in, 186
- Bolometer, the B.C.Y. for testing gas fires, 235
- Bonecourt Surface Combustion System, 458, 462, 468, 470. *See also* Surface Combustion.
- British Coal Trade, history and economics of, 12
- Bromine, action on coal of, 84, 152
- Bunsen Burner, 272
- Calorific Values, of gases, 252; of some typical fuels, 50
- Carbon, action of air on incandescent, 334; action of steam on incandescent, 337; combustion of, 165; in coal, 51
- Carbon Dioxide, density of, 252; sensible heat in, 201; specific heat of, 200
- Carbon Monoxide, calorific value of, 252; density of, 252
- Carbonisation of Coal, at high temperatures, 129, 133; at low temperatures, 99, 119, 124, 125, 133; Dessau intermittent system of, 286; Glover-West continuous system of, 288; in horizontal

INDEX

- retorts, 278; in vertical retorts, 278
- Carburetted Water Gas, 383
- Cellulose, 24, 116
- Cellulosic Derivatives in Coals, 74, 125
- Coals, action of aniline on, 94; action of benzene on, 95; action of bromine on, 84, 152; action of phenol on, 94; action of pyridine on, 86, 91; action of quinoline on, 93; action of solvents on, 85; anthracitic, 67; ashes, composition of, 40; ashes from, 38; ashes, melting point of, 41; ashes, sulphur in, 133; bituminous, 66; British outputs, 13; British coking, 314; calorific values of, 59; carbon in, 51; census of production of, 19; chemical investigation of, 82; classification of, 58, 63, 64, 69, 70, 71; combustion of, 164; composition of coking, 299; constitution of, 111, 126; consumption of, in Germany, 477; consumption of, in United States, 479; distillation of, 102, 175 (*see also* Carbonisation of Coal); dust, inflammability of, 153; effect of oxidation on calorific value of, 151; export of, from United Kingdom, 4; gas, *see* Gas (Coal); gas occluded in, 35; gasification of, 250; geographical distribution of, 23; geology of, 27; hydrogen in, 51; in relation to shipbuilding, 5; lignitic, 65; mineral matter in, 38; moisture in, 37; nitrogen in, 54; nitrogenous constituents of, 76; origin of, 22; oxidation of, 149, 151, 154, 158; pit-head cost of, 21; power production from, 431; production of, in Germany, Great Britain, and the United States, 12; purposes of consumption of, 17; reserves, duration of British, 15; reserves, Royal Commission on, 15, 17; resinic constituents of, 75, 111, 125; salt in, 47; selection of, for gas-making, 68, 277; selection of, for gas producer practice, 68; selection of, for steam-raising, 68; self-heating of, 155; semi-bituminous, 67; storage, precautions for, 156; sub-bituminous (*see* Lignitic); substance, 49; sulphur in, 58; ultimate analysis of, 50; values of, 7; volatile combustible matter in, 56; war, effect of, on output of, 22; washing of, 42; water combined in, 117; weathering of, 149; world's demand for, 11; world's output of, 12; world's reserves of, 8
- Coalfields, geographical distribution of British, 29
- Coal trade, history and economics of, 12
- Coke, blast furnace, 300; combustion of, 174; comparative yields of, from beehive and by-product ovens, 309; consumption of, in blast furnace per ton of iron, 389; domestic use of, 227; metallurgical, 300
- Coke Oven Gas, calorific value of 329; composition of, 328; utilisation of, 328
- Coke Ovens, as adjunct to blast furnace, 308; beehive, 301; Breckon and Dixon, 302; by-product recovery, 304; by-product recovery compared with beehive process, 308; Coppée, 307; direct recovery systems of, 317; Koppers, 317; modern by-product, 307, 315; Pernolet, 304
- Coking Industry, 299; growth of, 307; modern progress in by-product recovery, 311
- Conductivities, Table of Heat, 207
- Dead Film in Boilers, 206
- Densities of Gases, 252
- Diaphragm Heating (Surface Combustion), 451
- Domestic Heating, 219
- Dowson Gas, composition of, 350
- Dried Blast in Iron Smelting, 422; Gayley System of, 423, 428
- Ethane, calorific value of, 252; density of, 252; thermal decomposition of, 143
- Ethylene, calorific value of, 252; density of, 252; thermal decomposition of, 143, 147
- Fireplaces, domestic, 224; Harcourt, 227; Teale, 225; wastefulness of open, 221
- Fires, coal, 222
- Firing, by coal dust, 180
- Flame(s), definition of, 255; radiation from, 259; rates of propagation of, 255; temperatures of, 263

INDEX

- Furnaces, surface combustion, 456, 458, 470
- Gas (Blast Furnace), 252; calorific value of, 398; cleaning of, 406; composition of, 398, 405; development of internal combustion engines for, 403; dry cleaning of, 417; firing of Cowper stoves by, 401; history of, 400; power production from, 399; steam-raising in boilers by, 402; Theissen washer for, 406; utilisation of, 400
- Gas (Coal), 251; as industrial fuel, 294; calorific value of, 264; composition of, 130; consumption of, 296; high pressure distribution of, 295; purification of, 292; quality and prices of, in 1913, 291; uses of, 296
- Gas (Coke-Oven), calorific value of, 329; composition of, 328; utilisation of, 328
- Gas (Dowson), composition of, 350
- Gas (Oil), 386
- Gas (Producer), 251; composition of, for furnace purposes, 346; composition of, for power purposes, 348
- Gas (Suction), composition of, 358; plants, 356
- Gas (Water), 372; composition of, 385; Dellwik-Fleischer system, 374; history of, 373; Humphreys and Glasgow plant, 386; K & A system, 377; Lowe Process of, 374; steel welding by, 382; use of carburetted, 383
- Gases (Combustible), calorific values of, 252; composition of gas occluded in coal, 36; factors to be considered regarding use of, 253; ignition of, 254; ignition temperatures of, 254; limits of inflammability of, 256
- Gas Carbon, 282
- Gas Engine, 403
- Gas Fires, 230; Bolometric tests on, 235; distribution factor of, 232; Leeds investigations on, 233; recent developments in, 235
- Gas Generators, 333; B. & W., 353; blowing arrangements for, 356; Brooke and Wilson, 349; design of, 348; Dowson, 349; Duff, 350; Ebelen, 349; history of, 349; Kerperley, 355; Mond, 351; Morgan, 353; Siemens, 349; Thwaite cupola, 337
- Gas Industry, 267; history of, 269
- Gas Producer Practice, Bone and Wheeler's experiments, 341; chemistry of, 333; Wendt's experiments, 335, 339
- Gaseous Mixtures (explosive), starting and propagation of flame through, 254
- Gob Fires, 149, 157
- Heat, conductivities, table of, 207; utilisation of, in molten slag, 418; utilisation of waste, 417
- Heating, spontaneous, of coal, 150
- Humic Acids, formation of, 153
- Humic Derivatives. *See* Cellulosic Derivatives.
- Hydrocarbons, combustion of, 176; synthesis of aromatic, 134, 147; thermal decompositions of, 139
- Hydrogen* calorific value of, 252; density of, 252; in coal, 51
- Ignition, spontaneous, of coal, 151
- Inflammabilities, relative, of coal, 152
- Iron, output of, in United Kingdom, 7; pyrites, influence of, on oxidation of coal, 152
- Iron and Steel Plants, organisation of, 409
- Kitchen Range Boilers, 223
- Kitchen Ranges, 222
- Lignite. *See* Coal, lignitic.
- Metals, melting of, by Surface Combustion, 473
- Methane, calorific value of, 252; combustion of, 176; density of, 252; researches on, 140, 148
- Mineral Matter in Coal, 38
- Moisture in Coal, 37
- Nitrogen, density of, 252; distribution of, among coal distillation products, 77; in coal, 54; specific heat of, 200
- Nitrogenous Constituents in Coal, 76
- North-East Coast Electric Power Scheme, 441
- Oil Gas, 386
- Oxidation, effect of, on the calorific values of coals, 151; influence of iron pyrites on spontaneous oxidation of coal, 152, 155; of coals, 149, 151, 154, 158

INDEX

- Phenol, action on coal of, 94
 Power Schemes, North-East Coast Electric, 441; organisation of public, 436
 Producer. *See* Gas Generator.
 Producer Gas, 251; composition of, for furnace purposes, 346, and for power purposes, 348
 Propylene, calorific value of, 252; density of, 252
 Pyridine, action on coal of, 86
 Quinoline, action on coal of, 93
 Reports, of the British Association Fuel Economy Committee, 20; of the Coal Conservation Committee, 437; of the Committee of the British Association to investigate Gaseous Explosions, 260; of the Royal Commission on Coal Supplies, 15, 20
 Regnault-Grüner Classification of Coal, 63
 Resinic Constituents of Coal, 75, 111, 125
 Retort Settings, horizontal, 278; vertical, 284
 Salt in Coal, 47
 Sauerbeck's Index Numbers, 7
 Semi-Coke, 226
 Sensible Heat (at different temperatures), in carbon dioxide, 200; in gases, 198; in nitrogen, 200; in steam, 200; lost in flue gases, 203
 Slag, utilisation of heat in molten, 418
 Smoke, composition of, 243; damage to vegetation by, 247; effect on sunlight of, 240; legislation against, 239; nuisance, 240; possible abolition of, 248; prevention of, 178
 Solvents, action of, on coal, 85
 Soot, analysis of, 244, 245; as fertiliser, 248; fall of, 240
 Specific Heat, of carbon dioxide, 200; of nitrogen, 200; of steam, 200
 Steam, raising by surface combustion, 459; specific heat of, 200;
 Steel, output of, in the United Kingdom in 1913, 389; welding of, by water gas, 382
 Stove, anthracite, 227
 Sulphur in Coal, 58
 Surface Combustion, 446; applied to steam raising, 458; boilers, 460, 462, 467, 468, 470; boiler trials, 464; diaphragm heating, 451; furnaces, 456, 458, 470; history of, 446; incandescent, 450; incandescent in a bed of refractory material, 454; melting of alloys by, 473; melting of metals by, 473; modern investigation of, 447
 Tars (Coal), composition of low temperature, 110, 112, 133; and of high temperature, 132
 Underfeed Stoking, 179
 Ventilation of Rooms by Gas Fires, 231
 Volatile Combustible Matter in Coal, 56
 Washery, Baum, 44
 Washing of Coal, 42
 Waste Heat, boilers for, 472; utilisation of, 417
 Water Gas, 372; composition of, 385; Dellwik-Fleischer system, 374; history of, 373; Humphreys and Glasgow plant, 386; K. & A. system, 377; Lowe process of, 374; steel welding by, 382; use of carburetted, 383
 Welsbach Mantle, 273
 Welding of Steel by Water Gas, 382

INDEX OF AUTHORS' NAMES

- Accum, F., 270, 272
 Anderson, W. Carrick, 71, 76, 78,
 80, 83, 87, 107, 152
 Armstrong, H. E., 138
 Aubertot, 400
- Bailey, G. H., 239
 Bailly, 405
 Baker, C. J., 166
 Baker, H. B., 154, 162, 166, 167,
 169.
 Baker, P., 86
 Bedson, P. P., 36, 86, 88, 91, 93,
 94, 156
 Beilby, G. T., 18, 285, 359
 Bell, J. Ferguson, 283
 Bell, Lowthian, 165, 391, 398, 418.
 422
 Bénier, L., 356
 Bergfus, F., 75
 Berthelot, D., 134, 136, 137, 138,
 139
 Berthollet, 392
 Bessemer, H., 409
 Bevan, E. J. *See under* Cross, C. F.
 Bone, W. A., 108, 140, 152, 154,
 156, 176, 235, 254, 339, 341, 343,
 353, 434
 Boudouard, O., 83, 153, 154, 427
 Bouvier, M. *See* Pictet, A.
 Braçannot, 74
 Braünlich, F. *See* Donath, E.
 Breckenridge, L. P., 479
 Breckon, 302
 Brillié, 209
 Brodie, 113
 Brooke, 349
 Brunck, 349
 Brunck, F., 317
 Brunton, 285.
 Budd, J. P., 401
 Bueb, 285
 Bunsen, R. W., 272, 391, 400
 Burgess, M. J. *See* Wheeler, R. V.
 Bury, E., 309, 326, 464
- Callendar, H. L., 235, 260
 Carpenter, C., 293, 294
 Carvés, 308
 Christie, M. G., 76, 78, 107
 Clark, A. H. *See* Wheeler, R. V.
 Clarke, J. C., 314
 Cobb, J. W., 115, 117
 Cochrane, C., 392
 Cochrane, C. D., 300
 Cohen, J. B., 240, 244, 245, 246
 Colman, H. G., 290
 Constam, E. J., 175, 186, 187, 195,
 197, 246
 Cooper, G. Stanley, 317
 Coppée, E., 308
 Coward, H. F. *See* Bone, W. A.,
 and Dixon, H. B.
 Cowper, E. A., 401
 Crampton, T. R., 181
 Cross, C. F., 24, 25, 85
- Dalby, W. E., 204, 206, 207
 Darby, Abraham (father and son), 2
 Davidson, W. B., 130
 Davy, H., 274, 445
 de la Beche, T., 341
 de la Rive, 446
 Dellwik, C., 374
 Deville, St. Claire, 129, 130, 277,
 446
 Dixon, H. B., 166, 168, 169, 255
 Döbereiner, 446
 Donath, Ed., 84
 Donovan, 373
 Dowson, J. E., 349
 Drury, C. Dru, 287
 Dubouchet, 304
 Dudley, Dud, 2
 Dufaur, 400
 Dulong, 446
 Duna, J. T., 41
 Durston, J., 287
- Ebelmen 336, 349
 Ehrenwerth, J. von, 428, 429

INDEX

- Einof, 74
 Ekman, 349
 Evans, E. V., 292, 293
- Faraday, M., 446
 Fayol, H., 151, 152, 153, 162
 Feilitzen, H. von, 74
 Féry, 265
 Fischer, F., 84, 85, 98, 152
 Fleischer. *See* Dellwik, C.
 Fletcher, T., 273, 275, 446
 Fontane, 372
 Forster, W. J., 399
 Fremy, E., 83
 Friswell, R. J., 82
 Fryer, W. H., 422
- Gayley, J., 423, 424, 426, 427
 Gibb, Doig. *See* Carpenter, C.
 Gibson, Walcot, 29
 Gillard, 373
 Gluud, W. *See* Fischer, F.
 Graham, I., 157
 Graham, T., 446
 Greiner, A., 406
 Grüner, 58, 63, 64, 66. *See also*
 Regnault.
 Guldberg, 392
- Haber, F., 139
 Hadfield, R., 477
 Hadley, H. F. *See* Parr, S. W.
 Hahn, O., 339
 Haldane, J. S., 152, 156, 157, 163
 Hancock, W. C., 48
 Harcourt, V., 227, 228
 Harger, J., 78, 91
 Haward, W. A., 258
 Helmholtz, R. von, 261, 265
 Henderson, J. H. R. *See* Ander-
 son, Carrick.
 Henning. *See* Holborn.
 Henry, W., 445
 Herz, 74
 Holborn, 199, 264, 265
 Hollings, H., 115, 117
 Houbaer, 420
 Hudson, J. G., 207, 209
 Hutchinson, T. C., 310, 410, 429
 Hutton, W. S., 194
 Hills, J. *See* Graham, I.
- Ingle. *See* Smithells.
- Jevons, H. Stanley, 15, 16
 Jevons, W. Stanley, 1, 5, 17, 18
 Johnson, W. L., 419
 Johnston, J. F. W., 79
 Jones, D. T., 114, 115, 139, 147.
See also Wheeler, R. V.
- Jones, E. W., 179
 Julius, W. H., 261
- Kaiser, O. *See* Pictet, A.
 Kershaw, J. B. C., 204
 King, W. E. *See* Hancock, W. C.
 Kirke, P. St. G., 470
 Klingenberg, G., 477
 Knab, 307
 Knight, R. S. G., 403, 417
 Koppers, H., 317
 Kraft. *See* Bailly.
- Labouchere. *See* Pictet, A.
 Lambris. *See* Rau.
 Lang, J., 167, 168
 Le Chatelier, H., 171, 256, 259
 Lewes, V. B., 137, 138, 139, 145,
 152, 374, 376
 Lincoln, F. C., 46
 Longridge, M., 212, 462
 Louis, H., 21, 22
 Lowe, J. S. C., 374
 Lymn, A. H., 368
- McConnell, 36
 McCourt, C. D., 450, 472, 473
 Mahler, P., 153
 Mallard, E., 256, 259
 Mallet, J. W., 79
 Maybery, 98, 113
 Mendeléeff, D., 167
 Meyer, E. von, 36
 Miller, A. K. *See* Armstrong, H. E.
 Mond, L., 54, 360
 Mulder, 74, 78
 Murdoch, W., 269, 270
- Neilson, J., 2, 391
 Newbigging, J. G., 290
 Newcomen, 3
 Nicolson, J. T., 209, 210, 472
 Nübling, 85
- Ostwald, W., 446
 Otagawa, T., 258
- Padfield. *See* Settle.
 Parr, S. W., 94, 154, 157, 162, 163
 Parry, G., 401
 Papwels, 304
 Pernolet, 304
 Perry, J., 209
 Pictet, A., 97, 112, 113, 115, 126,
 139
 Platt, C. B. *See* Wheeler, R. V.
 Playfair, L., 241, 391, 400
 Pollard, W. *See* Strahan, A.
 Porter, H. C., 38, 107, 112, 118, 123,
 125
 Proust, 74

INDEX

- Ralston. *See* Porter, H. C.
 Ramseyer, L. *See* Pictet, A.
 Rau, O., 197, 312
 Regnault, 58, 63, 64, 66
 Renault, 26, 74
 Reynold, O., 209
 Rhead, T. F. E. *See* Wheeler, R. V.
 Rice, E. W., 405
 Richter, E., 151, 152, 153, 162
 Riley, J., 405
 Roberts, J. *See* Anderson, W. C.
 • Roberts-Austen, W., 116, 245
 Roscoe, H. E., 272
 Rumford, Count, 225
 Ruston, A. G., 240, 244, 245, 246

 Sauerbeck, 7
 Scheurer-Kestner, 246
 Schläpfer, P., 187, 195, 246
 Schultze, 25
 Schuppe. *See* Schultze.
 Settle, 285
 Seyler, C. A., 70, 71
 Shelby, 181
 Siemens, 49, 409, 446
 Simmersbach, O., 76
 Simon, H., 307
 Smeaton, 3
 Smith, R. H., 232
 Smithells, A., 170
 Smythe, J. A., 85
 Sorensen, S. S., 181
 Spring, 475
 Stein, S., 75
 Stein, W., 71
 Stephenson, Geo., 5
 Strahan, A., 15, 16, 30, 61, 70
 Strutt, R. J., 449

 Taylor, G. B. *See* Porter, H. C.
 Teale, T. P., 224, 225
 Theissen, E., 406
 Thénard, 446
 Thomas, W. J., 36
 Thomson, J. J., 450
 Thorpe, T. E., 138
 Threlfall, R., 224, 225
 Thwaita, B. H., 405
 Tollens, W. J., 36
 Travers. *See* White.
 Trobridge, F., 36

 Van't Hoff, 171
 Vathaire, 418
 Vignon, L., 94, 107, 108

 Waage. *See* Guldberg.
 Wahl, A., 90, 92
 Wänner. *See* Nübling.
 Watt, J., 30
 Wedding, 69, 70
 Welsbach, A. von, 273
 Wendt, Karl, 174, 335, 339
 West, J. E., 291
 Wheeler, R. V., 36, 37, 80, 89, 92, 93, 94, 96, 97, 100, 101, 102, 104, 105, 106, 108, 109, 110, 111, 112, 114, 117, 118, 124, 125, 126, 154, 156, 158, 162, 170, 171, 172, 256, 335
 White, 265
 White, D., 79, 80
 Whitwell, T., 401
 Wilson, 349
 Wynne, W. P., 243

 Yates, H. James, 235, 236, 237
 Young. *See* Beilby, G. T.
 Young, J. *See* Thorpe, T. E.

PRINTED IN GREAT BRITAIN BY
RICHARD CLAY & SONS, LIMITED,
BRUNSWICK ST., STAMFORD ST., S.E. 7,
AND BUNGAY, SUFFOLK.

