

**BURNING
LIQUID
FUEL**

WILLIAM N. BEST

Burning Liquid Fuel

A Practical Treatise on the Perfect Combustion of Oils and Tars, giving Analyses, Calorific Values and Heating Temperatures of Various Gravities with Information on the Design and Proper Installation of Equipment for All Classes of Service

BY

William Newton Best

Fellow of the Royal Society of Arts, Engineer in Caloric, Member Am. Ry. Master Mechanics Asso.; Am. Soc. M. E.; Am. Inst. Min. and Met. Eng.; Inter. Ry. Fuel Asso.; Am. Inst. of Metals; Am. Drop Forge Asso.; Aero Soc. of Am.; Franklin Inst.; N. Y. Academy of Sciences; and Petroleum Inst.

The Burners, Furnaces and Various Installations Described in this Book are Fully Protected by Letters Patents.



New York
U. P. C. BOOK COMPANY, Inc.
243-249 West 39th Street
Nineteen Twenty-Two

8246
F157 a

A516941

Dedication

AS THE YOUNGEST OF A LARGE FAMILY IT WAS MY CUSTOM IN CHILDHOOD TO BRING MY EXAMPLES AND COMPOSITIONS TO MY BROTHERS AND SISTERS FOR THEIR CORRECTION AND APPROVAL SO NOW I BRING TO THEM THESE PAGES, WHICH REPRESENT THE LABOR OF MANY YEARS SPENT IN MAKING EXHAUSTIVE TESTS, LESS CONFIDENT OF THEIR APPROVAL, BUT MORE FULLY APPRECIATING THEIR LOVE. TO THESE DEAR ONES WHO, EACH IN THEIR OWN WAY, AIDED AND ENCOURAGED ME IN MY CHOSEN CALLING, I AFFECTIONATELY DEDICATE THIS BOOK.

FIRST EDITION
COPYRIGHT, 1913,
By

WILLIAM NEWTON BEST

REVISED AND ENLARGED EDITION
COPYRIGHT, 1922,
By

U. P. C. BOOK COMPANY, INC.

FOREWORD

Dear Friend Best:

As the general subject of Petroleum, and particularly the fuel feature of the problem, has strongly appealed to me for the past thirty years, it was with exceeding interest and professional profit I read the advance proof sheets of your valuable and practical treatise on the efficient combustion of oils and tars.

Your distinct fitness to write upon this important subject will be recognized by our leading engineering experts, not only by reason of your broad experience as regards oil fuel matters but likewise due to the varied, progressive and successful results accomplished by you along that line.

During the extended series of boiler tests conducted by the Navy (1901-1904) with both coal and oil as a combustible, it was you who first distinctly and strikingly called attention to the importance and necessity of providing a very marked increase in the volume of combustion chamber with the use of oil as a fuel. It has been development in this direction which constitutes one of the distinct advances obtained in burning oil more efficiently and safely as well as in very materially increasing the output of boiler capacity.

There were other important features of the problems of safely, uniformly, efficiently and rapidly burning oil which were suggested and emphasized by you, and which have since been universally adopted.

The Navy as well as the Nation is therefore indebted to you for the far-reaching military and engineering counsel you rendered your country in promoting the successful development of the oil burning furnace—an achievement of importance whether viewed from an industrial, maritime or strategic standpoint.

As our economic advance may very materially influence our future welfare, it is fittingly supplementary to your other important accomplishments, that you should now give to the engineering world of this nation a Treatise that tells of the most progressive manner in which fuel oil, one of the important products of our most distinct national asset, should be handled and conserved.

With affection and esteem, I am sincerely,

(Signed)

JOHN R. EDWARDS,

Rear Admiral U. S. N. Ret.

Dr. W. N. BEST, F.R.S.A., Consulting Engineer,
11 Broadway, New York.

PREFACE

THE wisest man who ever lived upon this earth stated that righteousness exalteth a nation. Both history and ruins prove the truth of this statement. The greatest asset of any corporation is its reputation, for this reveals the character of its officials; hence, the necessity for producing goods of 100% quality. Scientific books benefit their readers only in proportion to the amount of truth which they contain, for science is truth. Often theory is termed science, but eventually it must give way to truth. The author has read hundreds of works only to find them disappointing both as to their statements and applications. The illustrations and data contained in this book are, however, based only on facts.

In the compilation of this edition of the Science of Burning Liquid Fuel the author has given data which cover all the various forms of equipment. This has been obtained from thousands of actual tests, and is the result of knowledge gleaned from more than thirty-three years' experience in the burning of oil and tar.

The language used is plain. It will be readily understood by professors and students of public schools, technical schools or universities; the mechanic or consulting engineer; the heater or forger of metals; the melter or superintendent of a foundry; the draftsman or a works manager; the superintendent or president of a manufacturing concern; and the metallurgist or the chemist.

The equipment shown are not mere photographs of the outside but give interior construction. They have been selected from the 42,000 installations in successful operation and reveal the most modern application of liquid fuel so as to obtain CO^2 therefrom (perfect combustion of fuel). The general construction and the principles on which the installations were based are different from all others. This edition contains data, tables and illustrations which are invaluable to multifarious branches of manufacture, transportation, etc.

These tabulated results of tests are surprising if we consider only the calorific value of coal and oil, but due allowance must be made for all phases and varieties of service.

We hope we have made clear the absolute necessity of thoroughly atomizing the oil, as well as the use of a burner that will not carbonize. It is also necessary to use a burner that will make a flame that will fit the combustion chamber or fire-box to which it is ap-

plied as perfectly as a drawer fits an opening in a desk. I cannot conceive how anyone could expect a round flame to fit a flat surface any more than one could expect a carpenter to fit a round drawer to an oblong opening in a desk. Such a thing is impossible. The flame must be made to fit perfectly.

As a lover of Youth I wish to make the statement that you can never succeed in this world unless you love your particular calling. It has been well said that "He who aspires must perspire." Genius is 90 per cent. work and 10 per cent. concentration. Knowledge is Power. You will find work to be your best friend, and in your life's calling you can be successful only in proportion to the amount of intelligent effort that you put forth in making your contribution to the world. My hope is that you will let the world know that it has been made better because you, the reader of this book, have lived in it.

In my life's work I am encouraged very much by the following poem by Rudyard Kipling:—

L'ENVOI

"When Earth's last picture is painted, and the tubes are twisted
and dried,
When the oldest colours have faded, and the youngest critic has died,
We shall rest, and faith, we shall need it—lie down for an æon
or two,
Till the Master of All Good Workmen shall set us to work anew!
"And those that were good shall be happy; they shall sit in a
golden chair;
They shall splash at a ten-league canvas with brushes of comets'
hair;
They shall find real saints to draw from—Magdalene, Peter and
Paul;
They shall work for an age at a sitting and never be tired at all!
"And only the Master shall praise us, and only the Master shall
blame;
And no one shall work for money, and no one shall work for fame;
But each for the joy of the working, and each, in his separate star,
Shall draw the Thing as he sees It for the God of Things as They
are!"

W. N. BEST.

July, 1921.

Table of Contents

	PAGE
CHAPTER I	
EARLY EXPERIENCES	7
CHAPTER II	
LIQUID FUEL—ITS ORIGIN, PRODUCTION AND ANALYSIS.....	15
CHAPTER III	
ATOMIZATION	33
CHAPTER IV	
OIL SYSTEMS	39
CHAPTER V	
REFRACTORY MATERIAL	69
CHAPTER VI	
LOCOMOTIVE EQUIPMENT	72
CHAPTER VII	
STATIONARY AND MARINE BOILERS.....	84
CHAPTER VIII	
LOW PRESSURE BOILERS AND HOT AIR FURNACES.....	129
CHAPTER IX	
COMMERCIAL GAS INDUSTRY EQUIPMENT.....	135
CHAPTER X	
SUGAR INDUSTRY EQUIPMENT	142
CHAPTER XI	
STEEL FOUNDRY PRACTISE	152
CHAPTER XII	
HEAT-TREATING FURNACE PRACTISE	171
CHAPTER XIII	
MALLEABLE IRON, GREY IRON AND BRASS FOUNDRY PRACTISE...	194
CHAPTER XIV	
MODERN FORGE SHOP PRACTISE.....	216

	PAGE
CHAPTER XV	
BOILER MANUFACTURERS' FURNACE EQUIPMENT.....	243
CHAPTER XVI	
COPPER INDUSTRY EQUIPMENT	264
CHAPTER XVII	
ENAMELING EQUIPMENT	269
CHAPTER XVIII	
CHEMICAL INDUSTRY EQUIPMENT	272
CHAPTER XIX	
CERAMIC EQUIPMENT	283
CHAPTER XX	
LIME INDUSTRY EQUIPMENT.....	286
CHAPTER XXI	
CEMENT INDUSTRY EQUIPMENT	291
CHAPTER XXII	
DRYERS AND ORE ROASTERS	295
CHAPTER XXIII	
BREAD AND CRACKER OVEN EQUIPMENT.....	306
CHAPTER XXIV	
CHOCOLATE INDUSTRY EQUIPMENT	312
CHAPTER XXV	
OIL AND TAR STILL EQUIPMENT.....	314
CHAPTER XXVI	
INCINERATOR EQUIPMENT	318
CHAPTER XXVII	
GLASS INDUSTRY EQUIPMENT	320
CHAPTER XXVIII	
COMBUSTION ENGINEERING	332

Chapter I

EARLY EXPERIENCE

The author of this book began the study of liquid fuel while Master Mechanic and Superintendent of the Los Angeles Electric Railway in the year 1887. We used the Daft system of electricity. This system had previously operated an electric railway in Boston, Mass. They, however, did not have the overhead wire, but used the third rail system. Ours was the first overhead system of electric railroad in the United States, if not in the world. A view of the electric motor car then used on this road is here given. You can also see the first electric locomotive with two trailers attached. It may be of interest to here state that after building the Myrtle Avenue branch of this road (which was a branch of the main line to Pico Heights), I reported to the Board of Directors that we should purchase motor cars for the branch line and not use the electric locomotive and trailers, because the latter was more costly to operate, but I also made the statement that in a few years electric locomotives would be used instead of steam locomotives in certain branches of work and for that service they would be better than electric motor cars. This portion of my report caused considerable merriment as there were grave doubts in the minds of many as to the fulfilment of this prophecy.

The boilers to which I first applied oil as fuel were the "Hazelton," and manufactured in New York City. The burners, if such they could be called, were made of gas pipe, and produced a round flame. These were soon changed to the flat type by simply flattening the pipe in a blacksmith's forge so that the nozzle would, in a measure, produce a flat flame, but which in reality produced a very uneven, irregular flame. The steam and the oil passed out in the same direction through the one orifice, which often resulted in much carbon forming therein, and necessitated the apparatus being removed quite frequently in order to remove the carbon which collected in the mouth piece. The equipment was exceed-

BURNING LIQUID FUEL



Fig. 1. The first electric locomotive built in the United States, drawing two trailers; also the first overhead wire system for trolley cars. Constructed in Los Angeles, California, in 1886.

ingly crude. I have since thought it was even more crude than the oil we were attempting to burn. We were, however (after much experimenting), able to get the normal rating of the boiler, but several months passed before this was accomplished. The oil was very heavy, being between 14 and 18 gravity Baume and of asphaltum base. While endeavoring to obtain information from those in the Eastern States and in Russia who claimed to have burned oil, I found that they were laymen in the art of burning the new fuel, and that I would have to put out to sea without any compass to guide me.

We obtained our supply of crude oil from wells in the Puente fields about 30 miles from Los Angeles. Often it was reported that the supply was about exhausted and at times we were not sure of getting enough for our requirements. Again, too, the coal interests were endeavoring to protect themselves from inroads by the oil company, which made the consumer doubly careful. A number of firms installed oil fuel upon their boilers but had difficulty with the elements of the boiler being injured or with not being able to maintain the required steam pressure. Thus becoming disgusted with the new fuel, nearly all of these firms returned to the use of coal, believing that the kind of crude oil which we had in southern California was not commercially a success as a fuel. The author, however, was never discouraged, but was alert to each new development in the changes of brick work, different locations of the burner and the air openings through which the air could enter to effect combustion until he became convinced that it was the fuel of the twentieth century. In order to obtain satisfactory results I realized that it had to be scientifically burned and that careful consideration was necessary in order to achieve the highest efficiency and the strictest economy. After thirty-three years of study, I take pleasure in giving to the world some of the results achieved by the use of this incomparable fuel.

After we had had the new fuel in service for several years other manufacturers became impressed with the fact that the California crude oil could be successfully burned and began to adopt it as a fuel.

The first locomotive I endeavored to equip was while I was Master Mechanic of the Los Angeles and Redondo Railway. Many, many were the discouragements encountered before success crowned our efforts and demonstrated that crude oil was a God-

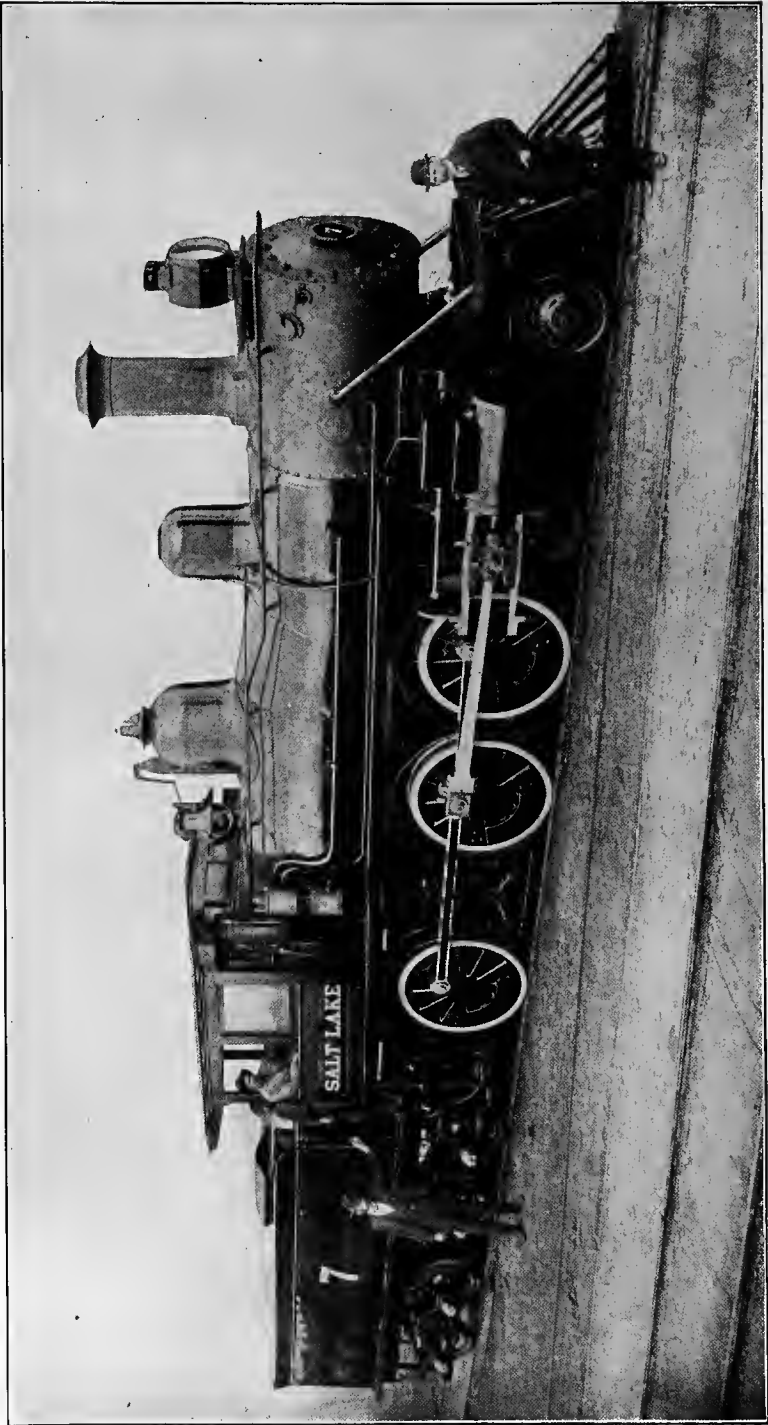

Fig. 2. Locomotive on which the first burner made by the author was installed.

send to both the engineer and fireman as this fuel increased the tonnage of the locomotive fully 15 per cent. over coal, and they could maintain the steam pressure at just below the limit required to prevent steam escaping through the pop valves. So successful was it on this road that I received a call to another road which had attempted but failed to burn this fuel. It was while Superintendent of Motive Power and Machinery of this road (The Los Angeles Terminal Railway, which afterwards became the Los Angeles & Salt Lake Railroad) that I invented my own burner. The locomotive which carried my first locomotive burner is shown in Fig. 2. I had tried every form and type of burner up to that time and saw imperfections of construction and operation which I strove to obviate by making a burner foreign to all others.

My experience in burning liquid fuel in furnaces began while I was Superintendent of the California Industrial Company's Rolling Mill in Los Angeles. We manufactured commercial iron (bar iron of all sizes and shapes) from scrap iron and soft steel. Many people have stated that oil cannot successfully weld iron and steel, while others, who have successfully used oil as fuel, state that oil is the only fuel for this class of work as it does not change the nature of the metal. As we had only scrap iron and soft steel to make the bar iron from, and as crude oil was our only available fuel, it was necessary to weld it perfectly; and, without fear of contradiction, will say that no better iron can be made than that produced with oil fuel, as oil, when properly used, is a purifier of metals.

Since leaving the Rolling Mill I have installed oil burners and supplied designs for the construction of nearly every form of furnace including the following: Annealing, asphaltum mixers, babbitt heating, bolt making, brass melting, brazing, bread ovens, etc., brick and art tile kilns, case hardening, cast iron melting, cement kiln rotary, channel iron heating, chocolate bean roasters, continuous heating, copper plate, core drying, crematories, crucible brass melting, crucible steel melting, drop forge work, enameling, flue welding, glass lehrs, glass melting, incinerators, indirect-fired, japanning ovens, ladle heating, locomotive steam raising, locomotive tire heating, malleable iron, mould drying, ore smelting, plate heating, pipe bending, pipe flange welding, portable torches, rivet making, rolling mill work, rotary kilns, shaft and billet heating, sand drying, sheet steel heating, steel melting, steel mixers, tar

stills, tempering, welding scrap iron, wire annealing, wire making. This book will show some of the different installations and the results obtained therefrom.

The burning of liquid fuel is a science. It can be burned either wastefully or economically. In order to obtain the highest possible efficiency and strictest economy from any installation the oil system must be installed and operated upon scientific principles. I am aware that many articles have been published on oil burning. Some have contained much valuable information, while others it has simply been a waste of time to read, because of the fact that the writer himself was not familiar with the subject. Several years ago I read an article on the different methods of burning oil and when I visited the city in which the author resided I called upon the gentleman, for I desired to ask him several questions on points not clear to me. This man acknowledged that he had never burned a gallon of oil in his life and that his article was simply a compilation of reports on tests made by others, he not even having been present at any of the tests. The burners described in his treatise all seem to fit perfectly and operate without the slightest difficulty. The equipment which he described reminded me of an artist's girl friend who, in describing the ability of the artist, stated that one of the portraits which she painted of a gentleman was so perfect that it had to be shaved twice a week. My point is that if a man wishes to write a treatise on welding iron he should first learn how to make a weld himself, for some time he is liable to meet a man from Missouri "who will want to be shown," and Mr. Author might then be humiliated because of his imaginary ability. Theory is needed, but without practical knowledge it is like faith without works—it is dead. To say the least, it is disappointing, especially in regard to the subject of heat, which we have been studying for centuries and by the knowledge of which we have raised ourselves above the brute creation and the Stone Age. A short time ago while addressing some students I asked, "What is the propelling power of a steam locomotive?" They thought long and hard, and at last after mentioning almost every part of the locomotive one student in desperation said "Heat," which of course is the propelling power of a steam locomotive.

While it is not possible for an engineer in calorics to tell you how many gallons of oil are required to run a locomotive over a division of a railroad without knowing her tonnage and the average

grades, or to tell you how much oil a burner will burn without having full particulars in regard to installation, or to even guess how much oil will be used in a furnace without knowing its exact form and proportions, temperature required, the size and quantity of metal to be heated in the furnace per hour or per day, yet he should have such a knowledge of his business and the capacity of the oil burner that he can recommend an installation which will not prove a farce. If it is a copper refining furnace (such as is described in this book) he should know the size of burner required, the amount of air needed to reduce and refine a given charge of such metal, or if an annealing furnace he should be capable of figuring out the graduated size and location of heat ports necessary to give an even distribution of heat throughout the entire length, width and height of the furnace. I consider that a man is simply playing or guessing who first installs three or four oil burners in a furnace and then if they do not give the required heat, installs three or four more. This is not the intelligent way of solving an engineering problem. It is simply the old "rule of thumb."

I have been asked if every man or firm makes a success of burning liquid fuel. To this I always answer "No. Many cannot burn oil successfully." The next inquiry is "Why not?" My answer is "Some men cannot learn to play the piano, others the harp. Some women are good cooks but cannot sew, and vice versa. Many men cannot burn coal or wood advantageously, and therefore I can frankly make the statement that many cannot learn how to burn liquid fuel." I have been often amused at men wanting to run tests on boilers and furnaces, using all the different types of burners which they can borrow for the occasion. The men conducting the tests never having had any theoretical or practical experience in the burning of oil or tar, their efforts are not a compliment to any of the burners. The result is as absurd as though two men, neither of whom had ever previously shot off a gun, were to institute a shooting contest, borrowing as many weapons as they could from the various gun manufacturers, assuring them that the result of the contest would be of great advantage to the firm that was fortunate enough to win in the contest. Let me assure the reader that the man who has never shot off a gun (or the man who has never operated a burner) had better become familiar with their construction and operation before exhibiting

the results of the contest, otherwise there might be some people who would not consider their efforts a criterion, and if their statement is incorrect they might have to meet the result of said decision in after years. I have known officials to be discharged because they selected an inferior article and after years had elapsed, another test with one of the same burners revealed the fact that the superior device had been rejected at the first test, resulting in irreparable loss to their firm of hundreds of dollars in fuel and thousands of dollars in output. Under such circumstances any man should be dismissed for incompetency. The most dangerous man on earth is an egotistical "Jack of all trades." Personally I would just as soon give my watch to be cleaned or repaired to a man who has never repaired one as to give a burner to an inexperienced man to run one of these so-called tests.

Chapter II

LIQUID FUEL—ITS ORIGIN, PRODUCTION AND ANALYSIS

“The origin of petroleum is still shrouded in mystery.”

Humboldt expressed the opinion that it is derived from deep-seated strata; Karl Reichenbach that it had its origin through heat action on turpentine, etc., etc.

The various theories propounded are divided by the scientific world into two groups, namely: those ascribing to petroleum an inorganic origin, and those regarding it as the result of the decomposition of organic matter.

M. P. E. Berthelot in 1866, after many experiments, suggested that mineral oil was produced by purely chemical action; while Mendeleeff ascribed its formation to the action of water at high temperature, on iron carbide in the interior of the earth. A near analogous theory to this is the one lately advocated by Eugene Coste, who ascribed its origin to solfatara volcanism.

On the other hand overwhelming opinions are adduced favoring the organic origin. Among those favoring the decomposition of both animal and vegetable marine organism may be cited J. P. Lesley, E. Orton and S. F. Peckham, while others have held that it is exclusively of animal origin. This view is supported by such an occurrence as that of the Trenton limestone, and also by the experiments of C. Engler, who obtained a liquid crude petroleum by the distillation of menhaden (fish) oil.

Similarly there is a difference of opinion as to the condition under which the organisms have been mineralized, some holding that the process has taken place at a high temperature; while others, because of the lack of practical evidence, have concluded that petroleum, like coal, has been formed at moderate temperature and under pressure varying with the depth of the containing rocks.

Consideration of the evidence leads us to the conclusion that at least in commercially valuable deposits, mineral oil has generally been formed by the decomposition of marine organism; in some cases animal, in others vegetable; in others both under practically

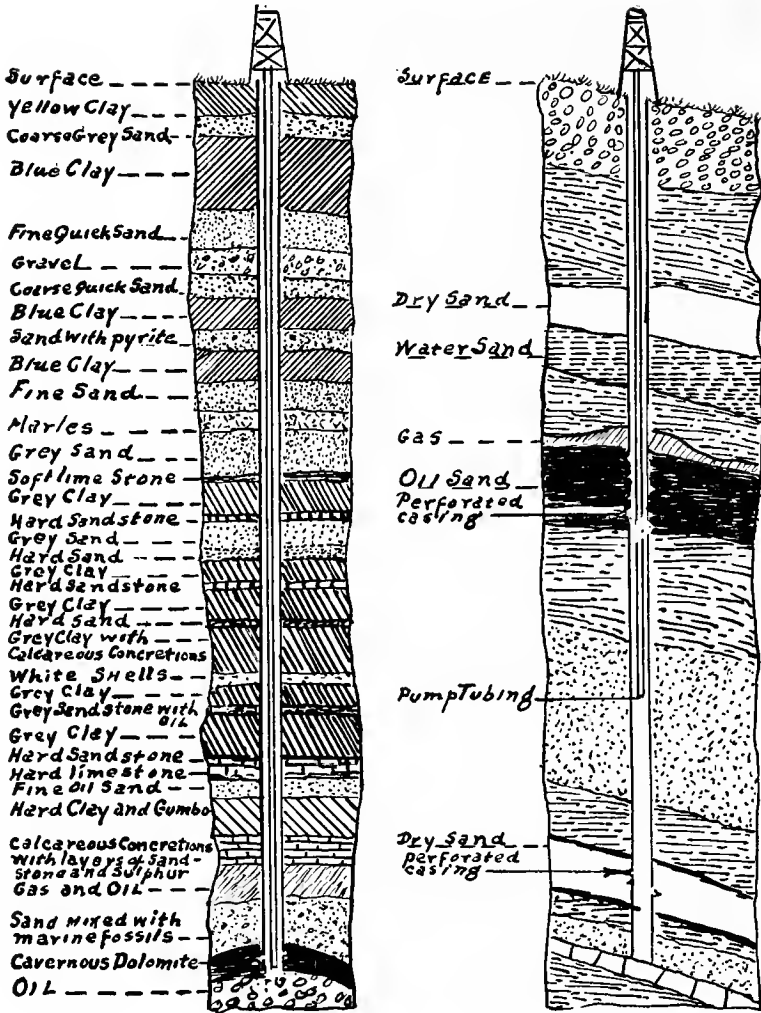

Fig. 3. Two logs showing geological formations or sands in which oil is found.



Fig. 4.
Pioneer
Gusher
in the
United
States.

normal conditions of temperature and pressure; and also in some to solfataras volcanism.

We are indebted to Capt. Anthony F. Lucas, who brought in the great gusher at Spindletop, Beaumont, Texas, in January, 1901, for the cut of the gusher, and also for the above article.

Oil was first discovered in the United States in 1859 at Titus-



No. 5. Col. Drake's Well at Titusville, Pa.

ville, Pa. During the first year only 2,000 barrels (42 gallons each) were produced. Since then each succeeding year the production and demand have increased until the world's consumption now aggregates 1,000,000 barrels a day. In the year 1911 the United States alone produced 220,440,391 barrels, or 63.80% of the total world production.

LIQUID FUEL PRODUCTION AND ANALYSIS 19

PETROLEUM PRODUCED IN THE UNITED STATES IN 1859-1918,
IN BARRELS OF 42 GALLONS

<i>Year</i>	<i>Pennsylvania and New York</i>	<i>Ohio</i>	<i>West Virginia</i>	<i>California</i>	<i>Kentucky and Tennessee</i>
	BBLs.	BBLs.	BBLs.	BBLs.	BBLs.
Prior to 1908.	687,425,409	366,250,105	185,039,718	201,965,825	5,276,578
1908.....	10,584,453	10,858,797	9,523,176	44,854,737	e727,767
1909.....	10,434,300	10,632,793	10,745,092	55,471,601	e639,016
1910.....	9,848,500	9,916,370	11,753,071	73,010,560	e468,774
1911.....	9,200,673	8,817,112	9,795,464	81,134,391	e472,458
1912.....	8,712,076	g8,969,007	12,128,962	h87,272,593	e484,368
1913.....	8,865,493	8,781,468	11,567,299	97,788,525	e524,568
1914.....	9,109,309	8,536,352	9,680,033	99,775,327	e502,441
1915.....	8,726,483	7,825,326	9,264,798	86,591,535	e437,274
1916.....	8,466,481	7,744,511	8,731,184	90,951,936	1,203,246
1917.....	8,612,885	7,750,540	8,379,285	93,877,549	3,100,356
1918.....	8,216,655	7,285,005	7,866,628	97,531,997	4,376,342
	788,202,717	463,367,386	294,474,710	1,110,226,576	18,213,188

<i>Year</i>	<i>Colorado</i>	<i>Indiana</i>	<i>Illinois</i>	<i>Kansas</i>	<i>Texas</i>
	BBLs.	BBLs.	BBLs.	BBLs.	BBLs.
Prior to 1908..	8,874,285	90,127,511	28,866,683	a42,357,150	117,819,991
1908.....	379,653	3,283,629	33,686,238	1,801,781	11,206,464
1909.....	310,861	2,296,086	30,898,339	1,263,764	9,534,467
1910.....	239,794	2,159,725	33,143,362	1,128,668	8,899,266
1911.....	226,926	1,695,289	31,317,038	1,278,819	9,526,474
1912.....	206,052	970,009	28,601,308	1,592,796	11,735,057
1913.....	188,799	956,095	23,893,899	2,375,029	15,009,478
1914.....	222,773	1,335,456	21,919,749	3,103,585	20,068,184
1915.....	208,475	875,758	19,041,695	2,823,487	24,942,701
1916.....	197,235	769,036	17,714,235	8,738,077	27,644,605
1917.....	121,231	759,432	15,776,860	36,536,125	32,413,287
1918.....	143,286	877,558	13,365,974	45,451,017	38,750,031
	11,319,370	106,105,584	298,225,380	148,450,298	327,550,005

BURNING LIQUID FUEL

PETROLEUM PRODUCED IN THE UNITED STATES—*Cont'd*

<i>Year</i>	<i>Oklahoma</i>	<i>Wyoming</i>	<i>Louisiana</i>	<i>Montana</i>	<i>Other</i>
	BBLs.	BBLs.	BBLs.	BBLs.	BBLs.
Prior to 1908..	b45,084,441	c85,785	27,413,511		d21,471
1908.....	45,798,765	f17,775	5,788,874		d15,246
1909.....	47,859,218	f20,056	3,059,531		d5,750
1910.....	52,028,718	f115,430	6,841,395		d3,615
1911.....	56,069,637	f186,695	10,720,420		d7,995
1912.....	51,427,071	1,572,306	9,263,439		
1913.....	63,579,384	2,406,522	12,498,828		i10,843
1914.....	73,631,724	3,560,375	14,309,435		j7,792
1915.....	97,915,243	4,245,525	18,191,539		j14,265
1916.....	107,071,715	6,234,137	15,248,138	44,917	j7,705
1917.....	107,507,471	8,978,680	11,392,201	99,399	k10,300
1918.....	103,347,070	12,596,287	16,042,600	69,323	k7,943
	851,320,457	40,019,573	150,769,911	213,639	112,925

ANNUAL PRODUCTION AND VALUE OF PETROLEUM FOR THE UNITED STATES

<i>Year</i>	<i>United States</i>	<i>Total Value</i>
	BBLs.	
Prior to 1908.....	1,806,608,463	\$1,657,113,275
1908.....	178,527,355	129,079,184
1909.....	183,170,874	128,328,487
1910.....	209,557,248	127,899,688
1911.....	220,449,391	134,044,752
1912.....	222,935,044	164,213,247
1913.....	248,446,230	237,121,388
1914.....	235,762,535	214,125,215
1915.....	281,104,104	179,462,890
1916.....	300,767,158	330,899,868
1917.....	335,315,601	522,635,213
1918.....	355,927,716	703,943,961
	4,608,571,719	\$4,528,867,168

- a—Includes Oklahoma in 1905 and 1903.
b—Production for 1905 and 1906 included in Kansas.
c—Includes Utah in 1907.
d—Michigan and Missouri.
e—No production recorded for Tennessee.
f—Includes Utah.
g—Includes Michigan.
h—Includes Alaska.
i—Alaska, Michigan, Missouri and New Mexico.
j—Alaska, Michigan and Missouri.
k—Alaska and Michigan.

I am indebted to the Department of the Interior, United States Geological Survey, for the above data.

SUMMARY OF PRODUCTION BY FIELDS

<i>Field</i>	<i>Preliminary Estimates 1919</i>	<i>Final Figures 1918</i>
Appalachian.....	29,232,000	25,401,466
Lima-Indiana.....	3,444,000	3,220,722
Illinois.....	12,436,000	13,365,974
Mid-Continent:		
Oklahoma-Kansas.....	115,897,000	148,798,087
Central and North Texas.....	67,419,000	17,280,612
North Louisiana.....	13,575,000	13,304,399
Gulf Coast.....	20,568,000	24,207,620
Rocky Mountain.....	13,584,000	12,808,896
California (a).....	101,564,000	97,531,997
	<u>377,719,000</u>	<u>b355,927,716</u>

a—Average of figures collected by the Standard Oil Company and the Independent Producers' Agency.
 b—Including 7,943 barrels produced in Alaska and Michigan.
 We are indebted to the Department of the Interior, United States Geological Survey, for the above data.

<i>Field</i>	<i>January-July, inclusive, 1919</i>	
	<i>Total</i>	<i>Daily Average</i>
Appalachian.....	17,462,000	82,368
Lima—Indiana and Southwest Indiana..	2,076,000	9,792
Illinois.....	7,496,000	35,359
Mid-Continent:		
Oklahoma-Kansas.....	63,243,000	298,316
Central and North Texas.....	36,005,000	169,835
North Louisiana.....	6,840,000	32,264
Gulf Coast.....	11,712,000	55,245
Rocky Mountain.....	8,025,000	37,854
California.....	59,390,000	280,142
	<u>212,249,000</u>	<u>1,001,175</u>

<i>Field</i>	<i>July, 1920</i>		<i>Jan.-July, inclusive, 1920</i>	
	<i>Total</i>	<i>Daily Average</i>	<i>Total</i>	<i>Daily Average</i>
Appalachian.....	2,613,000	84,290	17,165,400	80,589
Lima—Indiana and South- west Indiana.....	275,000	8,871	1,751,000	8,220
Illinois.....	925,000	29,839	6,386,000	29,981
Mid-Continent:				
Oklahoma-Kansas.....	12,919,000	416,742	85,857,000	403,085
Central and North Texas..	5,912,000	190,709	38,845,000	182,371
North Louisiana.....	3,293,000	106,226	20,473,000	96,117
Gulf Coast.....	2,296,000	74,065	13,751,000	64,559
Rocky Mountain.....	1,603,000	51,710	9,646,600	45,289
California.....	8,583,000	276,871	58,706,000	275,615
	<u>38,419,000</u>	<u>1,239,323</u>	<u>252,581,000</u>	<u>1,185,826</u>

BURNING LIQUID FUEL

ESTIMATED PRODUCTION
OF CRUDE PETROLEUM FOR 1919

Production of Petroleum in the United States in Barrels (Exclusive of Petroleum consumed on leases and of producers' stocks, except in California).

<i>Field</i>	<i>January</i>	<i>February</i>	<i>March</i>	<i>April</i>
Appalachian	2,420,000	2,185,000	2,453,000	2,542,000
Lima-Indiana	271,000	274,000	282,000	293,000
Illinois	1,094,000	940,000	1,166,000	1,008,000
Mid-Continent:				
Oklahoma-Kansas	8,971,000	7,887,000	8,734,000	8,387,000
Central and North Texas	5,094,000	4,479,000	4,959,000	4,762,000
North Louisiana	962,000	845,000	936,000	899,000
Gulf Coast	1,630,000	1,441,000	1,890,000	1,843,000
Rocky Mountain	1,085,000	990,000	1,168,000	1,259,000
California (a)	8,669,000	7,869,000	8,646,000	8,393,000
	30,196,000	26,910,000	30,234,000	29,386,000

<i>Field</i>	<i>May</i>	<i>June</i>	<i>July</i>	<i>August</i>
Appalachian	2,652,000	2,539,000	2,671,000	2,474,000
Lima-Indiana	324,000	311,000	321,000	306,000
Illinois	1,120,000	1,062,000	1,106,000	1,040,000
Mid-Continent:				
Oklahoma-Kansas	8,652,000	9,910,000	10,693,000	10,240,000
Central and North Texas	4,913,000	5,630,000	6,168,000	6,730,000
North Louisiana	927,000	1,064,000	1,207,000	1,286,000
Gulf Coast	1,621,000	1,521,000	1,766,000	2,044,000
Rocky Mountain	1,139,000	1,131,000	1,253,000	1,079,000
California (a)	8,637,000	8,467,000	8,709,000	8,663,000
	29,985,000	31,644,000	33,894,000	33,862,000

<i>Field</i>	<i>September</i>	<i>October</i>	<i>November</i>	<i>December</i>
Appalachian	2,489,000	2,513,000	2,064,000	2,230,000
Lima-Indiana	277,000	279,000	247,000	259,000
Illinois	877,000	1,064,000	1,033,000	926,000
Mid-Continent:				
Oklahoma-Kansas	10,976,000	10,764,000	10,408,000	10,266,000
Central and North Texas	6,369,000	6,219,000	6,107,000	5,989,000
North Louisiana	1,304,000	1,262,000	1,249,000	1,634,000
Gulf Coast	1,796,000	1,543,000	1,715,000	1,758,000
Rocky Mountain	1,169,000	1,054,000	1,137,000	1,120,000
California (a)	8,410,000	8,621,000	8,154,000	8,326,000
	33,667,000	33,319,000	32,114,000	32,508,000

WORLD'S PRODUCTION OF CRUDE PETROLUUM IN 1918 AND
SINCE 1857, BY COUNTRIES

Country	Production, 1918		Total Production, 1857-1918	
	Bbls. of 42 Gallons	Percentage of Total	Bbls. of 42 Gallons	Percentage of Total
United States.....	355,927,716	69.15	4,608,571,719	61.41
Mexico.....	63,828,327	12.40	285,182,489	3.80
Russia.....	40,456,182	7.86	1,873,999,199	24.97
Dutch East Indies(a)	13,284,936	2.58	188,388,513	2.51
Rumania.....	8,730,235	1.70	151,408,411	2.02
India.....	8,000,000	1.55	106,162,365	1.41
Persia.....	7,200,000	1.40	14,056,063	.19
Galicia.....	5,591,620	1.09	154,051,273	2.05
Peru.....	2,536,102	.49	24,414,387	.33
Japan and Formosa..	2,449,069	.48	38,498,247	.51
Trinidad.....	2,082,068	.40	7,432,391	.10
Egypt.....	2,079,750	.40	4,848,436	.07
Argentina.....	1,321,315	.26	4,296,093	.06
Germany.....	711,260	.14	16,664,121	.22
Canada.....	304,741	.06	24,425,770	.33
Venezuela.....	190,080	.04	317,823	.02
Italy.....	35,953		973,671	
Cuba.....			19,167	
Other Countries.....			397,000	
	514,729,354	100.00	7,504,107,138	100.00

a—Includes British Borneo.

b—Estimated.

c—Estimated in part.

I am indebted to the Department of the Interior, United States Geological Survey, for the above data

At this time the oil fields of Mexico are attracting a great deal of attention because of their magnitude. The proven territory of oil-producing land in Mexico is considered by many scientists the most valuable fields on this planet, and those who have carefully examined the fields and are competent to judge prophesy that that country will produce more oil than the combined production of all other sections of the world. The Mexican oil is high in calorific value per gallon, and is especially adapted for fuel in its crude state but not for refining. It is therefore fortunate that these fields have been discovered in order to supply the growing demand for crude oil, but I believe that other new fields will be discovered and developed with the ever-increasing demand until every coal-producing country will have an abundant supply of petroleum. The crude oil of Russia, Rumania and Borneo has approximately the same calo-

rific value as that of the Beaumont fields in Texas, while the oil thus far discovered in Argentine Republic, Chile and Peru is of approximately the same calorific value and gravity as the California petroleum.

Of the total production last year (1920), the United States supplied 443,402,000 barrels, or 64.4 per cent. Mexico produced 159,800,000 barrels, or 23.2 per cent, of the world's output. By far the greatest gains were made by this country and Mexico. United States production increased from 377,719,000 barrels in 1919 to 443,402,000 barrels in 1920, and Mexico increased its production from 87,072,954 barrels to 159,800,000 barrels. The estimated production, in barrels, by countries, follows:

	1920	1919
United States.....	443,402,000	377,719,000
Mexico.....	159,800,000	87,072,954
Russia (estimated).....	30,000,000	34,284,000
Dutch East Indies.....	16,000,000	15,780,000
India.....	8,500,000	8,453,800
Rumania.....	7,406,318	6,517,748
Persia.....	6,604,734	6,289,812
Galicia.....	6,000,000	6,255,000
Peru.....	2,790,000	2,561,000
Japan and Formosa.....	2,213,083	2,120,500
Trinidad.....	1,628,837	2,780,000
Argentina.....	1,366,926	1,504,300
Egypt.....	1,089,213	1,662,184
France.....	700,000	
Venezuela.....	500,000	321,396
Canada.....	220,000	220,100
Germany.....	215,340	925,000
Italy.....	38,000	38,254
Total.....	688,474,251	554,505,048

The above figures have been compiled by the American Petroleum Institute, to which I am indebted.

There are two kinds of oil or petroleum, one having paraffine base and the other asphaltum base. Either may be used as fuel in its crude state, but both are largely distilled in order to obtain the more volatile oils such as gasoline, benzine, kerosene, etc. The residue is called Fuel Oil and is used in every class of service where coal, coke, wood or gas can be used. It has proven a most superior fuel because the operator has the fire under perfect control at all times and can attain and maintain the heat required.

The analysis of Fuel Oil is as follows:

Carbon	84.35%
Hydrogen	11.33%
Oxygen	2.82%
Nitrogen60%
Sulphur90%

Gravity, from 26 to 28 Baume. Weight per gallon, 7.3 pounds.
Vaporizing point, 130 degrees Fahr. Calorific Value varies from 18,350 to 19,348 B.t.u. per lb.

Analysis of Beaumont (Texas) Crude Oil:

Carbon	84.60%
Hydrogen	10.90%
Sulphur	1.63%
Oxygen	2.87%

Gravity, 21 Baume. Weight per gallon, 7.5 lbs. Calorific value, 19,060 B.t.u. per lb. Vaporizing point, 142 deg. Fahr.

California oil varies in gravity from 12 to 36° gravity Baume.

Analysis of California Crude Oil (14 to 16° gravity Baume):

Carbon	81.52%
Hydrogen	11.01%
Sulphur55%
Nitrogen and Oxygen	6.92%

Weight per gallon, approximately 8 lbs. Calorific value, approximately 18,550 B.t.u. per lb. Vaporizing point, 230 deg. Fahr.

Mexican Topped Oil runs approximately 14° to 16° gravity Baume, and vaporizes at 175°F.; but the bottom oil or the oil that is left near the bottom of the earthen reservoir varies in gravity from 11° to 12° Baume and vaporizes at from 205° to 210°F. The weight of this bottom oil is approximately 8.2 lbs. per gallon.

Analysis of Mexican Topped Crude Oil (Tampico Fields):

Carbon	32.83%
Hydrogen	12.19%
Oxygen43%
Nitrogen	1.72%
Sulphur	2.83%

Weight per gallon, approximately 8 lbs. Calorific value, approximately 18,490 B.t.u. per lb. Vaporizing point, 175 deg. Fahr.

NOTE:—The British unit of heat, or British thermal unit (B.t.u.) herein referred to, is that quantity of heat which is required to raise the temperature of 1 pound of pure water 1 degree Fahrenheit at 39 degrees Fahrenheit, the temperature of maximum density of water.

Oil tar is a by-product of the water gas system used in numerous gas works. Coal tar is a by-product from coke oven benches. When either of these tars are heated sufficiently to reduce their viscosity they are a most excellent fuel. Per pound their calorific value is less than that of oil, but as they weigh from 9.5 to 10 pounds per gallon, while fuel oil only weighs 7.3 pounds per gallon, their calorific value per gallon is greater than that of fuel oil. Oil tar has a calorific value of 16,970 B.t.u. per pound or 161,200 B.t.u. per gallon, while that of coal tar is 16,260 B.t.u. per pound or 162,600 B.t.u. per gallon.

Analysis of London Tar and Tar from Dominion Coal:

	London	Dominion
Carbon	77.53	81.50
Hydrogen	6.33	5.68
Nitrogen	1.03
Oxygen	14.50	12.45
Sulphur	.61	.37

Comparison between Oil and Coal or other Fuels in Various Services

From data secured as a result of hundreds of tests and in order to show the value of liquid fuel in various forms of equipment, I give the following data which will furnish food for thought and which may prove beneficial to manufacturers in this and foreign countries. It can easily be seen that one cannot estimate the value of fuel oil by computing its calorific value without knowing the service to which the fuel is to be applied. So many engineers fail in their estimates simply because they have never run tests in burning liquid fuel against coal fuel. When using liquid fuel one can attain and maintain perfect combustion, but of course this cannot be done while burning bituminous coal.

In marine service using mechanical burners it requires 180 gallons of oil to represent a long ton (2,240 pounds) of coal having a calorific value of 14,000 B.t.u. per pound. In tug boat service, using atomizing burners, it requires 147 gallons of oil to represent a long ton of coal. Two tug boats equipped with oil fuel can readily perform the same amount of service that three tugs can using coal as fuel.

In locomotive service, using atomizing burners, 180 gallons of

oil will represent a long ton of coal. The tonnage of the locomotive may be increased 15% immediately after being changed from coal to oil.

In power plants with water tube boilers using atomizing burners, it requires 147 gallons of oil to represent a long ton of coal.

In large forging plants 82 gallons of oil equal a long ton of coal. In small drop forging furnaces it requires 62 gallons of oil to represent a long ton of coal.

In heat-treating furnaces with high temperatures 63 gallons of oil are equivalent to a long ton of coal. In heat-treating furnaces with low temperatures for drawing purposes only 56 gallons of oil are required to represent a ton of coal.

In flue-welding furnaces, welding safe ends of locomotive flues, only 58 gallons of oil are required to represent a ton of coal. The reason for this is obvious. You cannot make a welding heat with a green fire. You must coke your fire and in so doing you not only lose the volatile matter from the coal but you also lose valuable time while coking the coal.

Of course it should be remembered that the bituminous coal referred to has always the calorific value of 14,000 B.t.u. per pound, and is figured by long ton (2,240 pounds).

The oil referred to has a calorific value of 19,000 B.t.u. per pound, and weighs $7\frac{1}{2}$ pounds per gallon.

$3\frac{1}{4}$ barrels of oil (42 gallons per barrel) are equivalent to 5,000 pounds hickory or 4,550 pounds of white oak.

6 gallons of oil represent 1,000 cubic feet of natural gas, the gas having a calorific value of 1,000 B.t.u. per cubic foot.

$3\frac{1}{2}$ gallons of oil equal 1,000 cubic feet of commercial or water gas, having a calorific value of 620 B.t.u. per cubic foot.

$2\frac{1}{4}$ gallons of oil equal 1,000 cubic feet of by-product coke oven gas, having a calorific value of 440 B.t.u. per cubic foot.

42 gallons of oil equal 1,000 cubic feet of blast furnace gas of 90 B.t.u. per cubic foot.

This gas is used in this country in boilers and also in large furnaces but requires coal tar or oil to aid in the keeping up of the required horse-power of the boilers, or in furnishing the temperature required for the heating furnaces. Oil or coal tar are excellent fuels which can be readily used as fuel to operate in conjunction with the blast furnace gas in boilers or large furnace practice. Usually 10 gallons of coal tar are made from every ton of coal coked

in by-product coke ovens. This tar has a calorific value of 162,000 B.t.u. per gallon and weighs 10 pounds per gallon.

The following list showing typical value of the various kinds of fuel may be of service to the reader :

<i>Kind</i>	<i>B. T. U. per Pound</i>	<i>Pounds per Gallon</i>	<i>B. T. U. per Gallon</i>
Liquid:			
Fuel Oil (residuum of Petroleum)	19,000	7.3	138,700
Beaumont crude petroleum	19,060	7.5	142,950
California crude petroleum	19,500	7.6	147,200
Lima crude petroleum	18,820	7.5	141,150
Pennsylvania crude petroleum	18,940	7.5	142,050
Kerosene	16,120	7.2	116,000
Denaturated alcohol	13,140	5.7	74,900
Alcohol (90 per cent)	10,080	5.6	56,500
Coal tar	16,260	10.0	162,600
Oil tar	16,970	9.5	161,200
Solid			
Pocahontas coal	15,391		
Bituminous coal (Pittsburgh)	12,141		
Bituminous coal (Illinois)	10,506		
Anthracite	13,189		
Coke	13,000		
Turf (dried)	5,280		
Peat	8,160		
Oak wood	5,120		
Gaseous			
Illuminating gas (city coal gas)	550 to	650 B. T. U. per Cu. Ft.	
Natural gas	800 to	1,000 B. T. U. per Cu. Ft.	
Producer gas	130	B. T. U. per Cu. Ft.	
By-product coke oven gas	440	B. T. U. per Cu. Ft.	

In nearly every country on the face of the globe there are millions of tons of coal of very little calorific value that it is almost impossible to burn without the aid of some gaseous or liquid fuel. Fortunes can be made by utilizing in combination with oil the coal and coal products now wasted. For example, in the State of Rhode Island there is graphitic coal which has a calorific value of only 7840 B.t.u. per pound. Owing to the lack of volatile matter it is difficult to burn this coal, but with the aid of liquid fuel (as shown in Fig. 6) this coal burns readily.

Pulverized coal is delivered to the hopper and is fed in the manner shown upon the flat sheet of steam or compressed air produced by the oil burner, which carries the pulverized coal through the combustion chamber and delivers it as heat into the furnace. The

graphitic coal must of course be dried and pulverized in the usual manner. By this method the proper quantity of graphitic coal can be delivered to the furnace, using say 20 per cent oil and 80 per cent pulverized coal. The flat flame oil burner supplies the oil as well as the force for carrying the pulverized coal through the combustion chamber. (See Fig. 14, page 38.)

Of course, water gas tar or coal tar can be used instead of crude oil if desired.

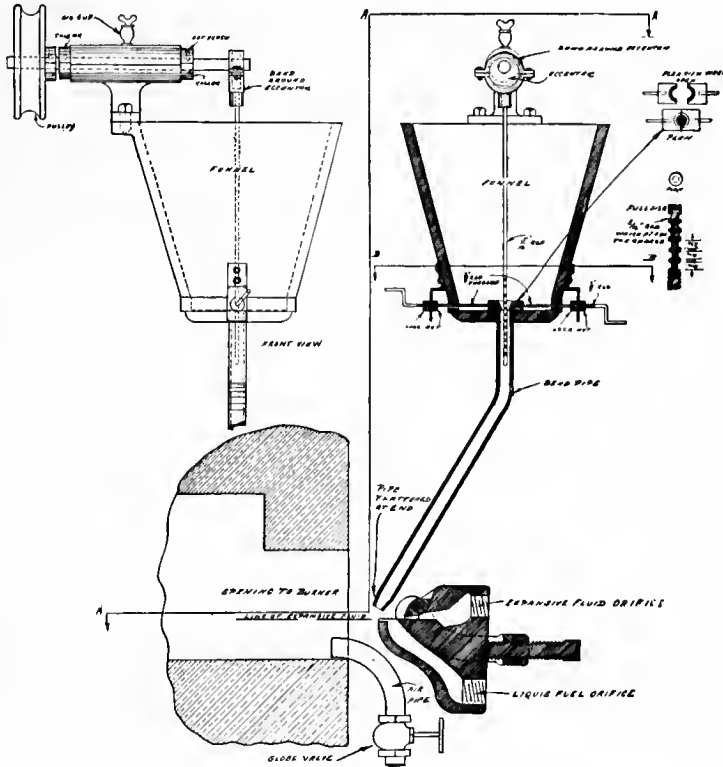

Fig. 6. Apparatus for burning liquid fuel in combination with pulverized coal or graphitic coal in melting, forging or heating furnaces.

Heat of Combustion

The chemical combination of a combustible with oxygen disengages energy in the form of heat.

The quantity or measure of this heat may be expressed in British

thermal units (B.t.u.) or the quantity of heat required to raise the temperature of one pound of water one degree Fahrenheit.

The number of British thermal units released by the combustion of one pound of the following substances, and the resultant temperatures are:

Hydrogen burned to H_2O , 62,032 B.t.u. Temp. 5,898°F.

Carbon burned to CO_2 , 14,500 B.t.u. Temp. 4,939°F.

Carbon burned to CO , 4,452 B.t.u. Temp. 2,358°F.

The great loss of heat due to the incomplete combustion of car-

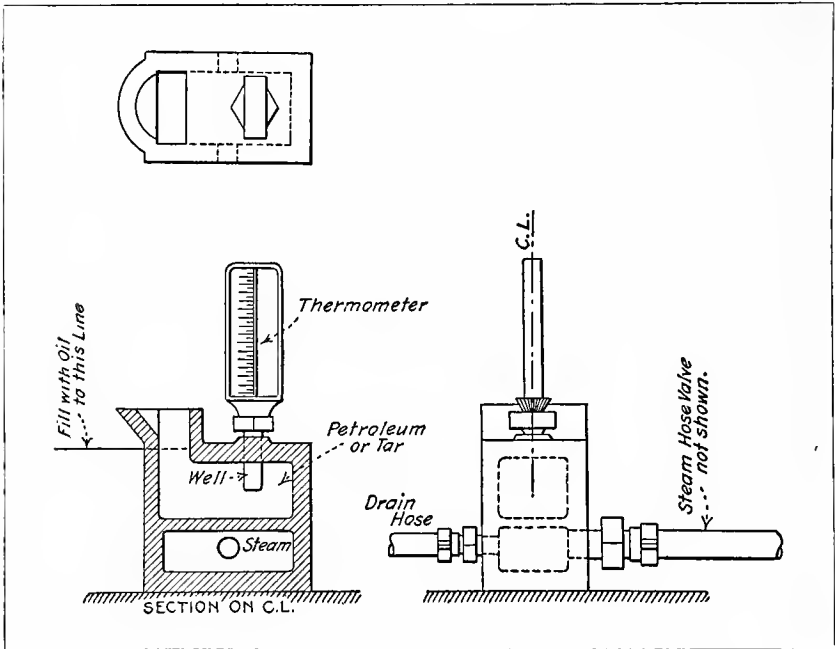

Fig. 7. Retort for determining vaporization point of petroleum.

bon is shown by the difference between the total heat of perfect combustion of carbon to CO_2 (14,500 B.t.u.), and that of carbon to CO (4,452 B.t.u.)

One pound of carbon when imperfectly burned produces $\frac{12+16}{12} = 2\frac{1}{3}$ pounds of carbon monoxide.

If this quantity of gas is burned to carbon dioxide the total

amount of heat released will be $14,500 - 4,452 = 10,048$ B.t.u.; therefore the calorific value of one pound of carbon monoxide is $\frac{10,048}{2.173} = 4,312$ B.t.u.

Testing Instruments

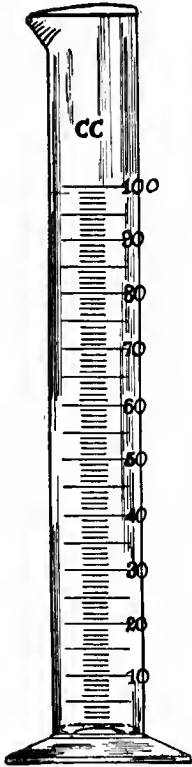

Fig. 8 Water test cylinder used to test the oil for water content.

Steam is used in the lower chamber of the retort shown in Fig. 7. The top opening is covered with a piece of cardboard having an $\frac{1}{8}$ " opening therein. When the steam has heated the oil so that vapor is seen passing out of this small opening in the cardboard cover, a temperature has been reached which is known as the vaporizing point of the oil. When vapor is thus visible, the oil has been heated to the temperature at which when burned, it gives an intermittent fire. A thermometer is placed on the retort so that the temperature of the oil at the vaporizing point may be recorded. The oil should be delivered to the burner at a temperature three or four degrees lower than the vaporizing point as recorded by the thermometer.

To ascertain the quantity of water contained in oil, fill the Water Test Cylinder (Fig. 8) with gasoline to the point marked 30 and then add crude oil until it reaches the place marked 60 on the cylinder. Expose the cylinder with its contents to the sun for several hours until the gasoline is all evaporated. The percentage of water in the oil is that found at the bottom of the cylinder after the gasoline has evaporated.

In order to ascertain the gravity, fill the glass cylinder shown in Fig. 9 with oil and place therein the hydrometer thermometer.

A calorimeter is an instrument used for testing liquid fuel in order to find out the number of British thermal units (B.t.u.) which it contains. Parr's calorimeter or any other approved make should be used.

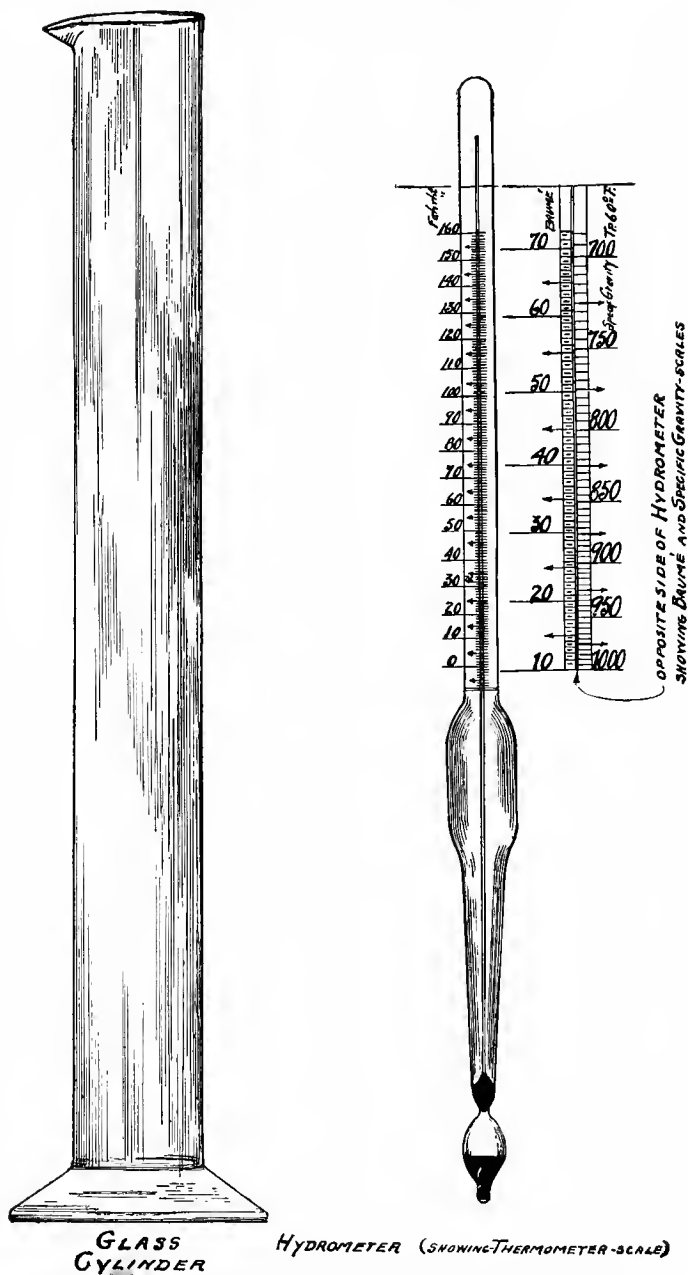

Fig. 9. Glass cylinder and hydrometer thermometer.

Chapter III

ATOMIZATION

Thousands of patents have been issued by our Government to inventors covering oil or tar atomizers or burners. Many of these inventions involve the same principle and all may be grouped in three distinct classes, viz.: mechanical, internal mixing and external atomizing. Many people have supposed that by simply mashing down a piece of pipe and coupling it to a steam or air and oil

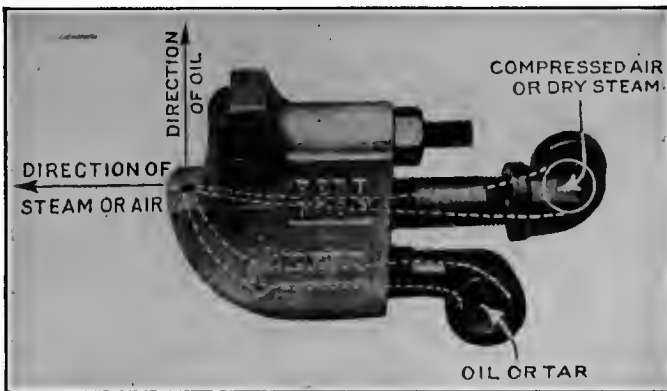

Fig. 10. High pressure, external atomizing oil burner.

supply line, they have evolved a cheap burner; a burner which, in 99 cases out of 100, they have seen working in some other shop. They very seldom state just where they have seen it in operation and often claim that it is their own invention, and that it only cost about fifteen or twenty cents to make. But there is another side to be considered. The first cost of an article may be a trifle but that is no sign that the article is really cheap. One must consider what the device will have cost in time, labor and fuel at the expiration of a year or more. One of the greatest abuses of liquid fuel is the endeavor to use it with burners that do not thoroughly atomize the oil and evenly distribute the heat throughout the entire fire-

box or the charging space of the furnace. A burner should be of such construction that it can be filed or fitted to make a long narrow flame or a broad fan-shaped blaze, fitting the entire length and width of a fire-box or furnace as evenly as a blanket covers a bed. A burner wherein the base of the fuel carbonizes over the fuel passage is absolutely worthless, for it should be capable of atomizing any gravity of fuel procurable in the open market without either clogging or carbonizing, no matter whether it be fuel oil of very light gravity or crude oil, oil tar or coal tar. A burner is not worthy of consideration unless it enables the operator to burn any gravity of liquid fuel, for no manufacturer should be limited to the purchase of one particular kind of fuel. There should be no internal tubes, needle points or other mechanism which will clog, wear away or get out of order readily. Each burner should be thoroughly tested so that when it leaves the shop where it is made the manufacturer knows that it will fill the requirements for which it is being furnished.

Considering that air contains 20.7 parts oxygen and 79.3 parts nitrogen, at 62 deg. Fahr. 1 lb. of air occupies 13,141 cu. ft. At 100 deg. Fahr. this air occupies 14,096 cu. ft. Theoretically it requires $13\frac{1}{2}$ to $14\frac{1}{2}$ lbs. of air to effect the perfect combustion of 1 lb. of oil. Allowing 14 lbs. at 62 deg. Fahr. it would require 183.97 cu. ft. of air to effect perfect combustion of 1 lb. of oil or at 100 deg. Fahr. it would require 197.34 cu. ft. of air. Practically it requires from $17\frac{1}{2}$ to $19\frac{1}{2}$ lbs. of air to effect perfect combustion of 1 lb. of oil. Allowing 19 lbs. at 62 deg. Fahr. this air occupies 249.68 cu. ft. or at 100 deg. Fahr. it occupies 267.82 cu. ft. Allowing 1 gal. of oil to weigh $7\frac{1}{2}$ lbs., practically it requires $142\frac{1}{2}$ lbs. of air to effect the perfect combustion of 1 gallon of oil or $1872\frac{6}{7}$ cu. ft. of air at 62 deg. Fahr. or at 100 deg. Fahr. it will require $2009\frac{1}{4}$ cu. ft. It is therefore essential that liquid fuel be thoroughly atomized so that the oxygen of the air can freely unite with it. Except where mechanical burners are used, the fuel is atomized by means of high or low pressure air or steam. Compressed air or steam is preferable to low pressure air because it requires power to thoroughly atomize liquid fuel. With low pressure or volume air you are limited to the use of light oils, whereas with compressed air or steam as atomizer you can use any gravity of crude oil, fuel oil, kerosene or tar which will flow through a $\frac{1}{2}$ -inch pipe. For stationary boilers steam at boiler pressure is

ordinarily used to atomize the fuel. In furnaces the most economical method of operation is the use of a small quantity of compressed air or dry steam through the burner to atomize the fuel, while the balance of the air necessary for perfect combustion is supplied independently through a volume air nozzle at from 3 to 5 oz.

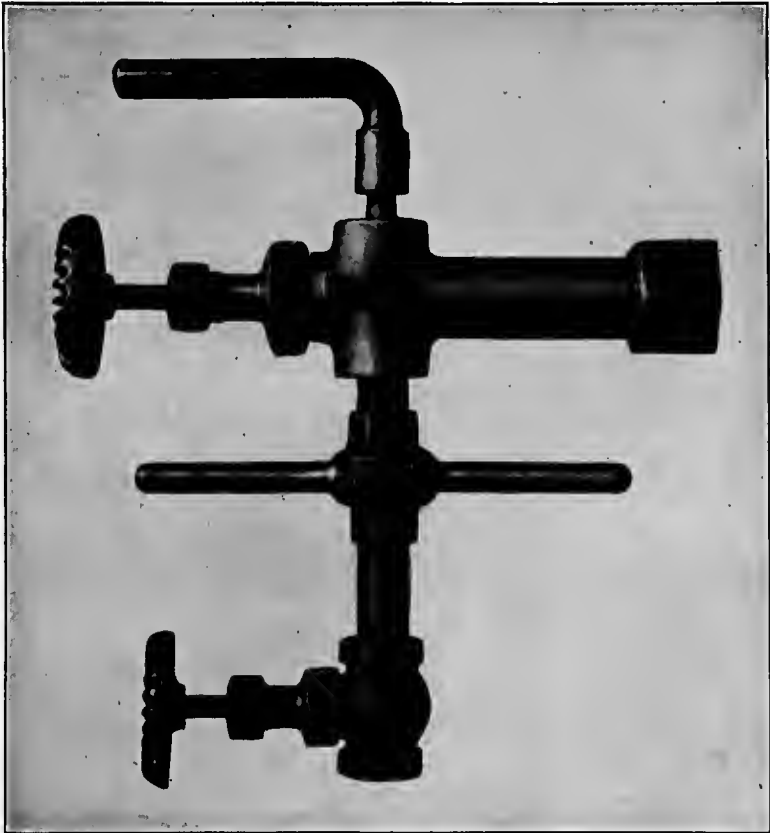

Fig. 11. Mechanical burner.

pressure. Every particle of moisture which enters a furnace must be counteracted by the fuel and it is therefore essential, if steam is used as atomizer, that it be as dry as possible. It is folly to attempt to use steam as atomizer on a small furnace, especially if the equipment is located some distance from the boiler room,

for oil and hot water do not mix advantageously. Numerous tests have proven that with steam at 80 lbs. pressure and air at 80 lbs. pressure, by using air there is a saving of 12% in fuel over steam, but of this 12% it costs 8% to compress the air (this includes interest on money invested in the necessary apparatus to compress the air, repairs, etc.), so there is therefore a total net saving of 4% in favor of compressed air.

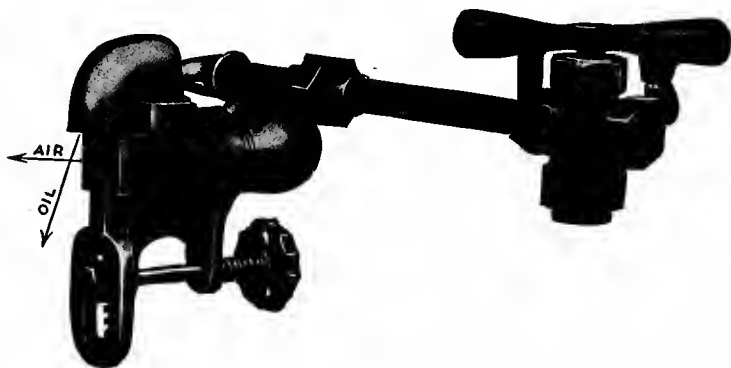

Fig. 12. Low pressure or volume air burner with oil regulating cock.

With high pressure air or steam as atomizer a burner having a large oil orifice below the atomizer orifice and independent of same is preferable, because there can then be no liability of the fuel solidifying or carbonizing over the atomizer slot at the nose of the burner. As the fuel passes out perpendicularly, as shown in Fig. 10, it is struck by the atomizer coming out of the small orifice horizontally and so thoroughly atomized that each drop of fuel is dashed into 10,000 molecules and looks like a fine mist or spray. This burner is provided with means whereby it can be cleaned or blown out without removing it from its position and thus any foreign solid particles such as sand, red lead, scale, etc., can readily be expelled. It produces a flat flame which may be a long narrow flame or it can be a fan-shaped flame of any width required, up to nine feet. This burner is not considered automatic, but it is automatic in its action, for in boiler service when the steam pressure lowers, it reduces the compression on the fuel at the nose of the burner and thus more fuel is syphoned out of the fuel orifice, which, of course, increases the fire and brings up the steam pressure.

As the use of steam means a waste of fresh water (which is a very scarce article on sea-going vessels), mechanical burners are attractive for marine service and many vessels have recently been equipped with them. With many of these burners you are, however, limited to very light crude or fuel oil and there has been considerable difficulty experienced in preventing the paraffine or asphaltum base of the fuel from clogging the delicate mechanism of the burner. The grade of oil required for the average mechanical burner can not be obtained in every country, and as that capable of being refined is being so largely distilled to obtain the more



Fig. 13. Commercial or natural gas burner.

volatile and valuable oils, the supply of this light oil is very limited.

It is necessary to use from 80 to 400 lbs. pressure on the oil supply line to burners, this, of course, varying with the gravity of the fuel. The internal construction is such that the fuel is atomized while passing through the body and out of the nose of the burner. A centrifugal air compressor operated by a modern type of turbine engine (Fig. 20, page 45) has been developed which, in the opinion of the writer, will attract a great deal of attention from marine engineers because with this system any gravity of liquid fuel procurable in any section of the world is thoroughly atomized, perfect combustion is effected, and as the system is provided with con-

densers there is no appreciable waste of fresh water. This apparatus is light, compact, durable and efficient, and furthermore high pressure is not required on the fuel; 20 lbs. air pressure is carried with this system to atomize the fuel.

Low oil pressure can be used and is preferable for a low pressure air or volume air burner. In this type of burner, the light crude oil or fuel oil used as fuel flows down upon and through the sheet of air. In order to get the benefit of the full impact of the air against

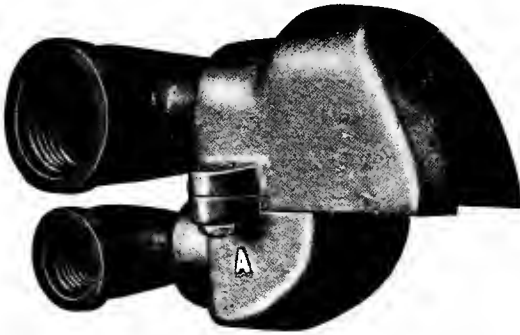

Fig. 14. Flat flame pulverized coal burner.

the fuel, the air supply should be regulated at the mouth of the burner as shown in Fig. 12, and it is always advisable to get as simple a burner as possible so that there will be no internal tubes, needle points or other mechanism to wear away, clog, carbonize or get out of order.

A natural or commercial gas burner, such as is shown in Fig. 13 may be used in combination with an oil burner if desired. It, as well as the pulverized coal burner (Fig. 14), is very simply constructed and without any intricate parts to get out of order. Both burners can be made to produce a long narrow flame or a broad fan-shaped blaze so as to span the width of the furnace or fire-box.

Chapter IV

OIL SYSTEMS

The method or manner whereby liquid fuel is supplied to the burners is commonly called the "oil system." Requirements vary according to the type of the installation and the fuel burned, but any one who has burned oil for a short time appreciates that the designing of an oil system is quite an engineering feat for so much of the success of the equipment depends upon the oil system. Perfect combustion is CO_2 , imperfect is CO . If you have one moment

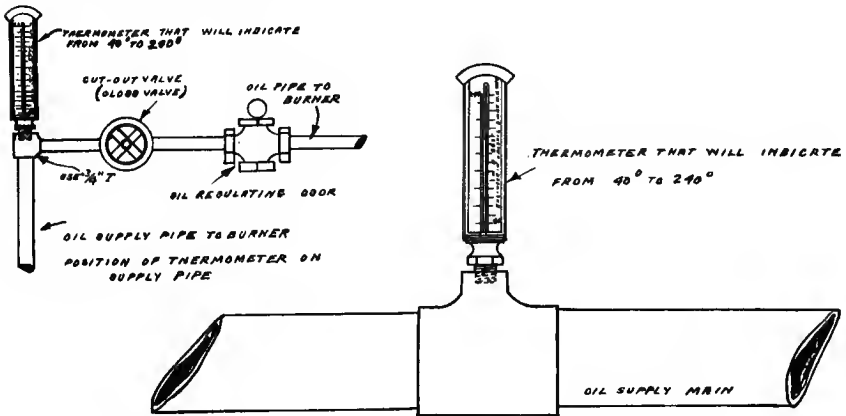

Fig. 16. Position of thermometer on oil supply main.

carbon dioxide and the next moment carbon monoxide, you can readily see the fuel is not scientifically consumed and this results in irreparable loss in time and fuel. The air pressure should be constant and the fuel should flow to the burner under a constant steady pressure, no matter whether that pressure be 1 pound, 20 pounds or more to the square inch. Light oils, which vaporize at about 130 degrees Fahrenheit, need not be heated but heavy oil or tar must be heated sufficiently to reduce the viscosity so that it will flow readily. This is ordinarily done by means of steam coils. Care

however must be taken not to get the fuel too hot, for if it vaporizes you can not pump it. The vaporizing point of the various fuels has already been given in this volume, and as steam at 100 pounds pressure is 338 degrees Fahrenheit you can readily see that it is possible to heat the fuel above the vaporizing point. Thermometers should be placed at various points throughout the works, and one should be conveniently placed for the man who is responsible for keeping the proper temperature upon the fuel.

In laying the piping care must be taken to keep the oil supply pipes below the level of the burner in order to prevent the formation of vapor pockets, which are liable to entirely shut off the flow of fuel. All pipe fittings should be malleable iron. All unions on pipe lines must be either ground joint or flange unions with lead gaskets. Rubber gaskets can not be used because liquid fuel soon disintegrates the rubber. The use of a paste of litharge and glycerine on all pipe joints will prevent their leaking. It is essential to place a strainer made of wire netting in the tank to prevent lamp black or other foreign substances from getting into the pipes and valves and clogging them.

No sane person to-day would venture near a storage tank with a lighted pipe, cigar, torch or any light other than electricity, but in order to prevent conflagration and serious loss of property through a steel storage tank being struck by lightning, or getting on fire through some accident, it is wise to run a large steam pipe line from the boiler room into the top of the tank. There should be a large number of holes in the pipe in the tank so that when the steam valve in or near the boiler room is opened, the steam will be widely diffused over the fuel in the tank.

Of course the most simple system is that often used in gas works, mines and other places, where there are no insurance regulations or city ordinances to prevent one from placing the tank so that the fuel will flow by gravity, the supply being controlled by the necessary valves. The bottom of the oil tank is ordinarily placed from four to six feet above the level of the burners, but in gas houses often the tank is placed on top of the boiler so that the heat in the boiler room will heat the fuel sufficiently to reduce its viscosity.

Figure 17 shows an oil supply system which conforms with the Underwriters' requirements and which is used in hundreds of plants. The storage tank, placed at some distance from any building, is covered with two feet of earth. As the average oil tank

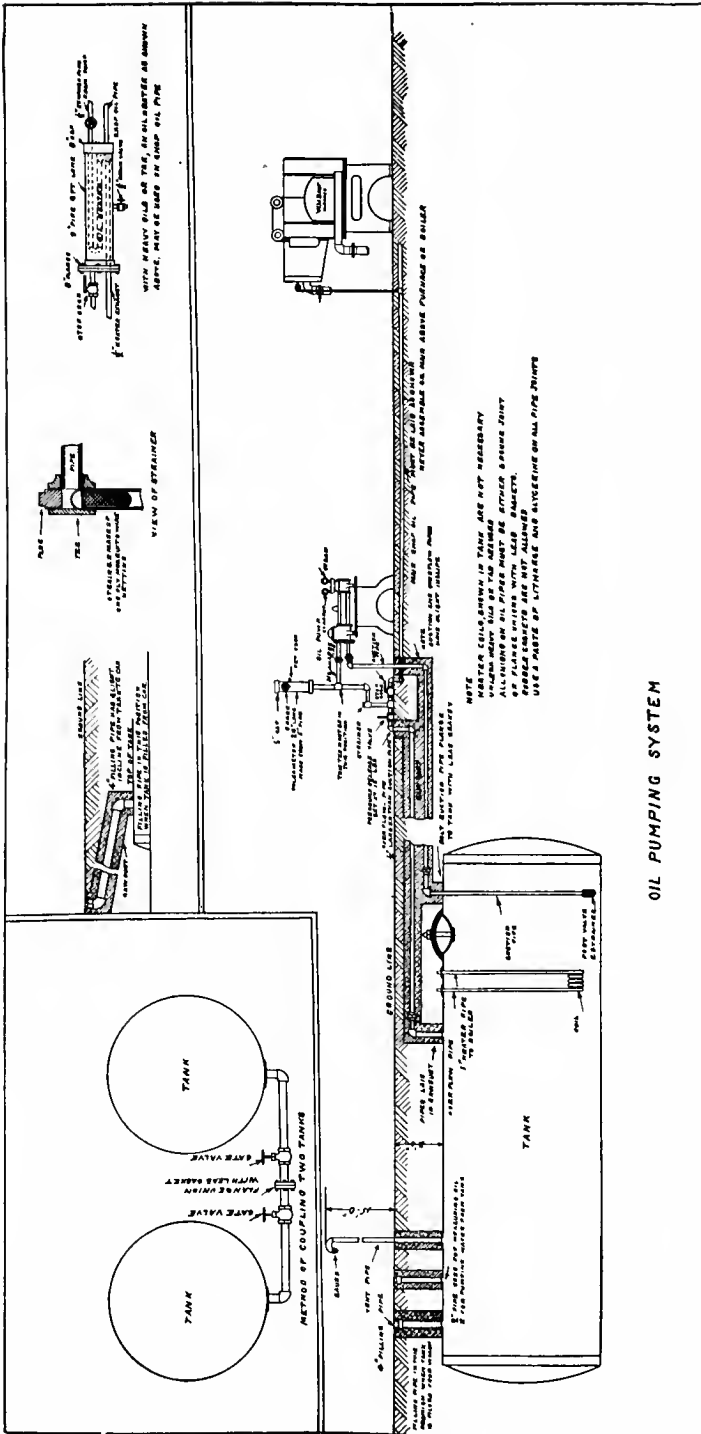

Fig. 17. Complete oil supply system whereby a constant even pressure is maintained on the oil line whether one or a dozen burners are in operation. Very heavy viscous fuel cannot be handled with this system.

car contains about 6,000 gallons I always recommend oil storage capacity of 10,000 gallons if the plant is on a railroad siding. Either one large tank or small ones coupled together as shown may be used. A reciprocating pump is preferable. I never advocate a rotary pump except when nothing but light oils will be used, and even then a rotary pump has a tendency to churn the fuel into a foam, thereby causing slight but noticeable explosions in the fire-box or furnace. By means of the pump, pulsometer and a pressure release valve (set at 12 pounds pressure), with this system 12 pounds pressure is constantly maintained on the main oil supply line whether one or a dozen burners are in operation. While light oil which vaporizes at about 130 degrees Fahrenheit does not need to be heated, oil of 16 gravity Baume is first heated by means of a steam coil in the storage tank and then by the exhaust from the pump so that after passing through this heater it is fed to the burner at just below the vaporizing point.

As the base and residuum of very heavy oil, oil tar or coal tar has a tendency to clog the pressure valve used in the above system and render it worthless, it is sometimes advisable to install a "valveless system" similar to that shown in Fig. 18. In this case that portion of the oil pumped which is not used by the burners flows into a column or standpipe of sufficient height to give six or eight pounds pressure on the oil line, and then back again to the storage tank. With this arrangement there can be no fluctuation in the oil pressure. Should the fuel be accidentally heated at any time above the vaporizing point, you will note that this vapor can readily pass out of the top of the standpipe through a vent pipe extending above the roof of the building and ten feet from any smoke stack. In case the Underwriters do not permit the use of a column or standpipe, it is necessary to use the pressure relief valve.

In Fig. 19 is shown oil system used for heating hotels, office buildings, etc. An electric motor operates an air compressor which supplies air to force the fuel from the storage tank to burner and also the air required through the burner to atomize the fuel. This system is absolutely reliable, for should a fuse burn out the oil and air supply to burner are stopped simultaneously. Or an oil or gas engine may be used and the compressor operated by a counter-shaft. In this case should the engine stop or belt break,

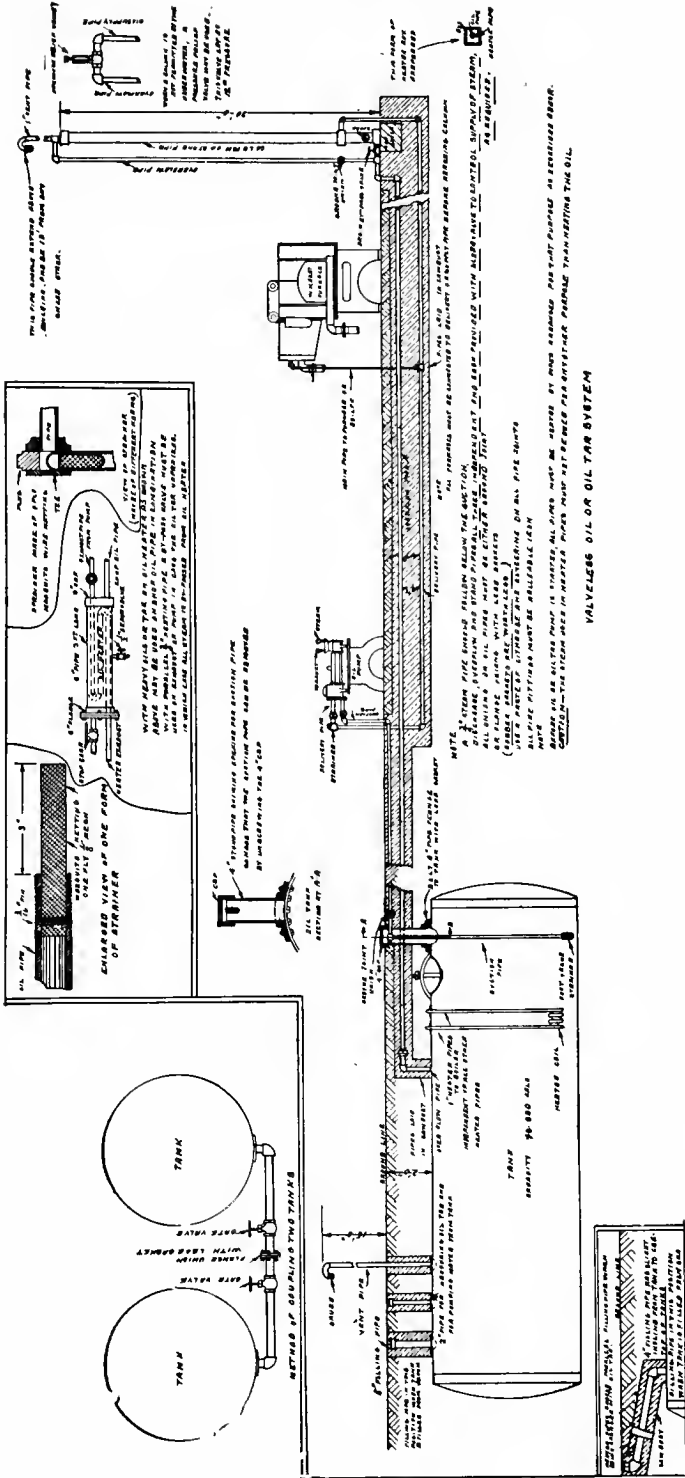

Fig. 18. Valveless fuel system used with heavy oil or tar.

the compressor will at once cease to force the fuel to the burner. Both these systems are simple, safe and sane.

For marine service, where the prevention of the waste of fresh water requires careful consideration, a turbine engine with con-

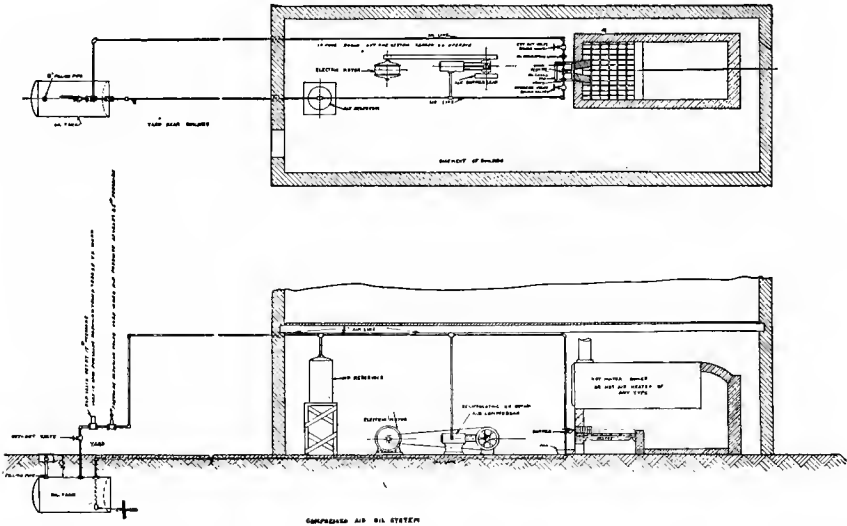

Fig. 19. Compressed air system—only adequate for light crude or fuel oil.

denser may be used to operate the oil pump and a compressor of adequate size to furnish air at sufficient pressure to atomize the gravity of oil obtainable in any port and to distribute the heat in the fire-box, also the additional air required in the boiler room. This system as shown in Fig. 20 is very compact, efficient and economical. As the engine exhausts into a condenser, the loss of fresh water is reduced to the minimum. While oil used exclusively as fuel cannot compete with the price of coal in many localities, it is very necessary to use it to aid the coal fire while carrying peak loads.

To effect the strictest economy crude oil or tar must always be heated to just below the vaporizing point. With the heavy oil, such as is produced in Mexico, it is sometimes advantageous to use an oil superheater so that, as for instance on a locomotive, if

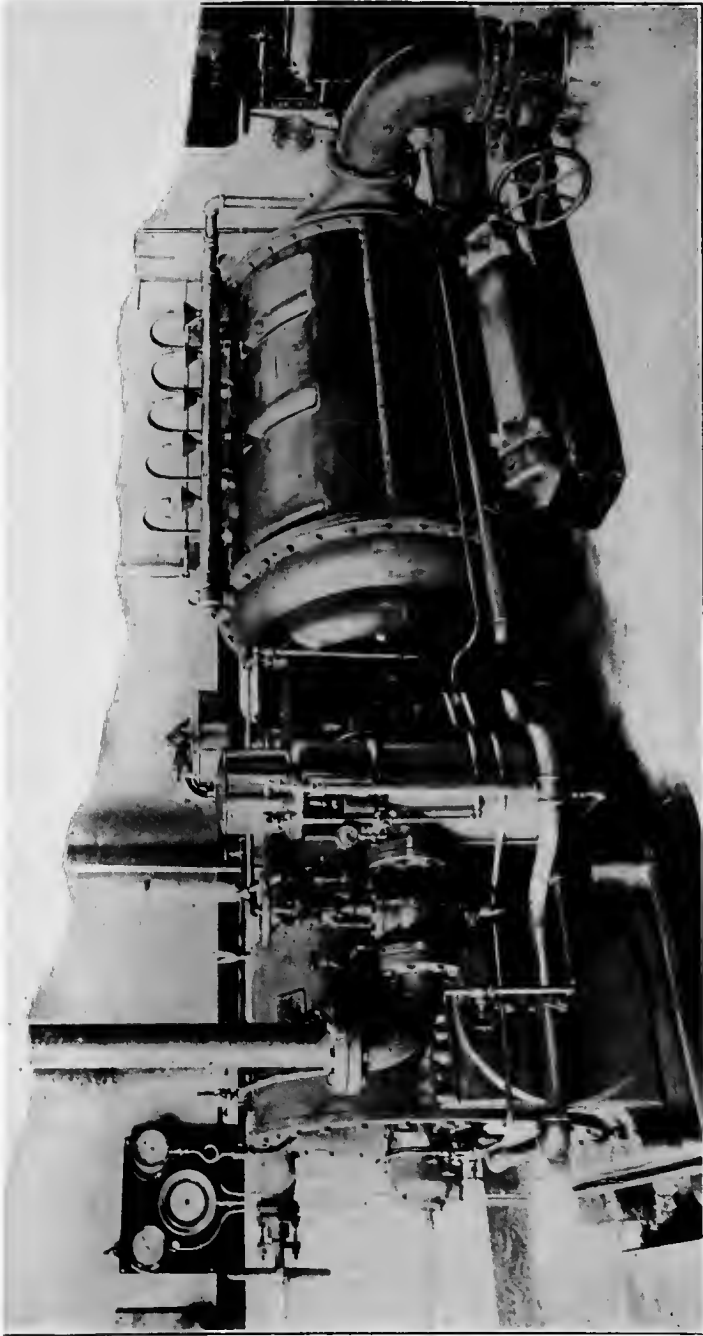

Fig. 20. Turbine engine operating a centrifugal air compressor of the most modern type. (Apparatus shown through the courtesy of the General Electric Co., West Lynn, Mass.)

the oil is not heated sufficiently in the storage tank of tender or if the tank has just been refilled at the end of a division, by passing through a superheater just before it reaches the oil regulating cock, it will be fed to the burner at just below the vaporizing point. (See Fig. 52, page 76.) When burning heavy oil in furnaces, if the fuel must come considerable distance, it is often essential to preheat it near the burner even if there is a steam heater pipe immediately under the oil supply line from the storage tank. A superheater is also valuable for heating tar between the storage

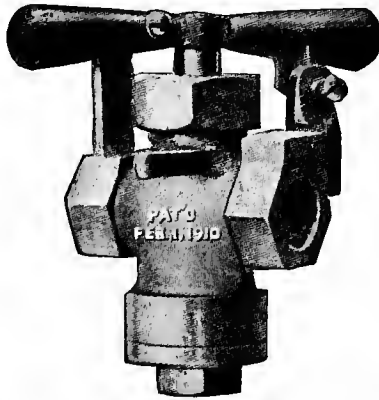

Fig. 21. Oil regulating cock.

tank and the burner so that it will be of such consistency that it can be readily atomized.

When an ordinary globe valve is used to regulate the fuel supply, and the valve is partly closed, the small opening between the valve proper and the seat acts as a strainer and any residuum or foreign substances in the oil finally closes the opening and cuts off the supply. We have here shown an oil regulating cock provided with a V-shaped, knife-edged opening in the plug, which not only has a shearing action on heavy liquid fuels, but enables the operator to secure the finest possible adjustment. It is unnecessary to make comparison between this cock and an ordinary globe valve or plug cock to any intelligent man who has had experience in handling liquid fuel. When a furnace is working continuously on

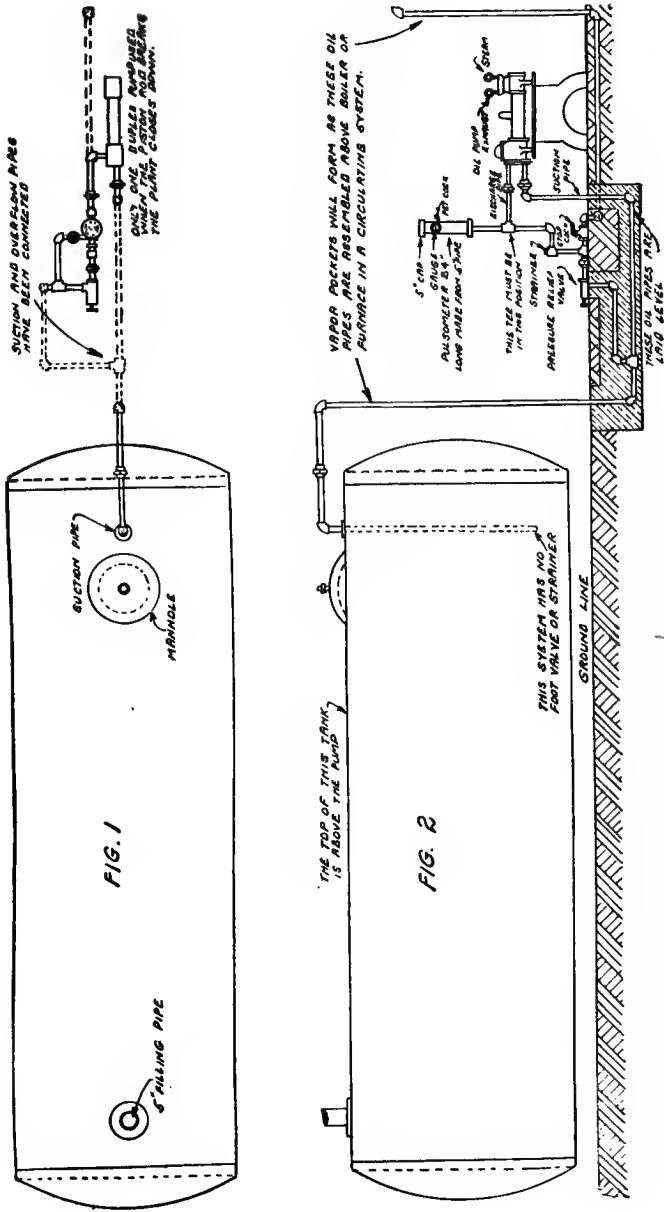

Fig. 22. Imperfect oil system.

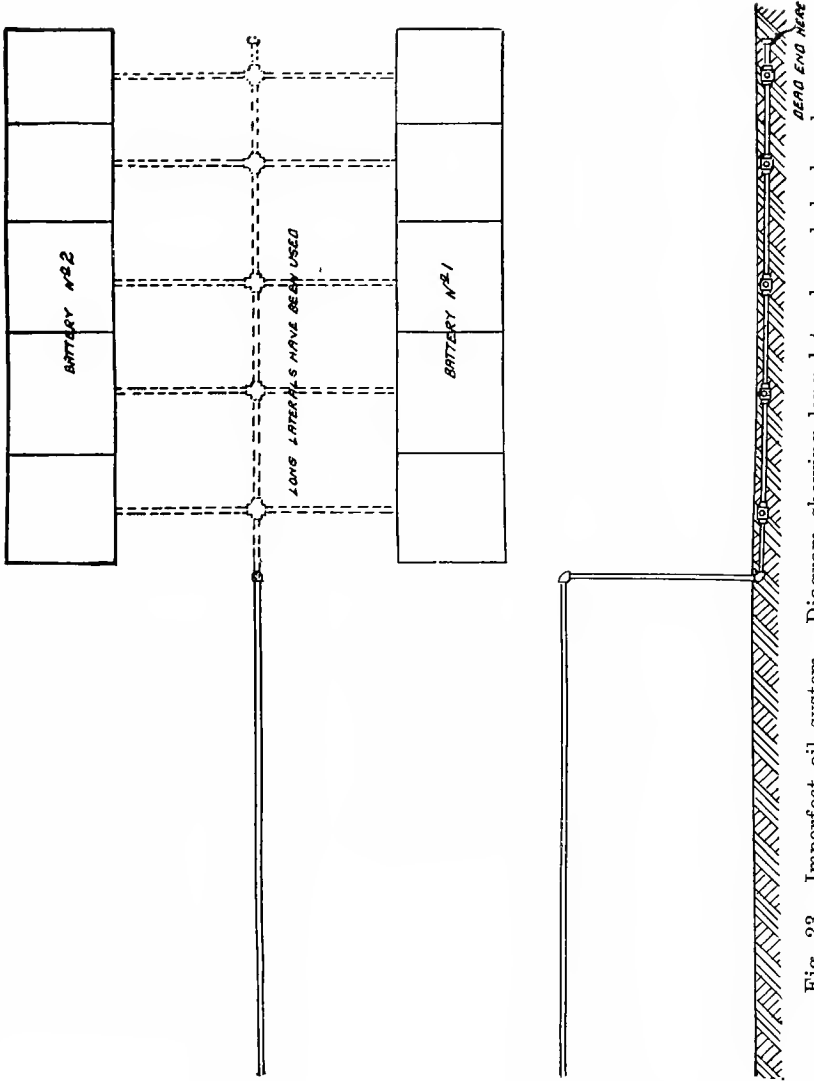

Fig. 23. Imperfect oil system. Diagram showing long laterals and dead ends.

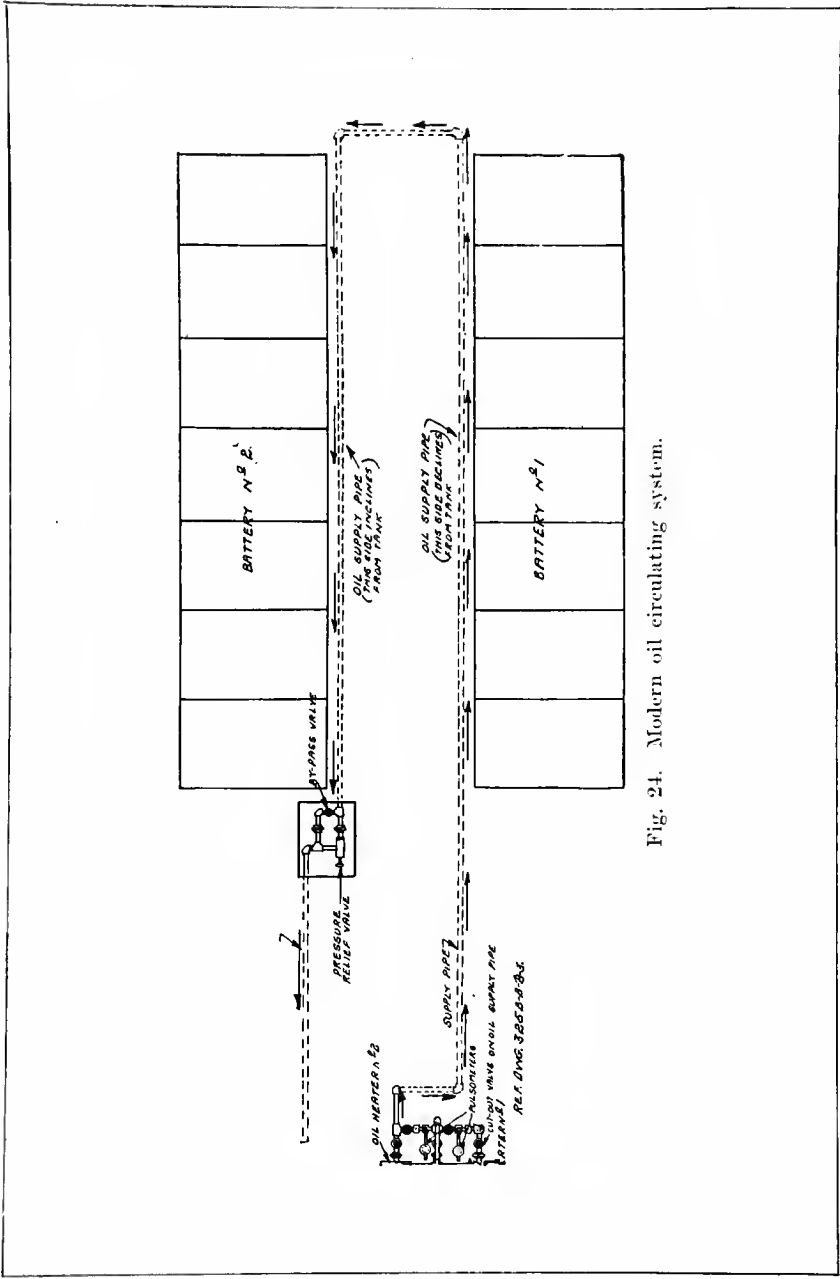

Fig. 24. Modern oil circulating system.

one class of work, this cock can be set by the adjusting screw so that when the burner is stopped for noon hour, or at night, it can be returned to the same adjustment when again started.

Improper Oil System. Please note the following points while studying Fig. Nos. 22 and 23:

1. There is no foot valve or strainer upon the suction pipe, which causes the pump to labor unnecessarily.
2. The suction pipe is so installed as to cause a vapor pocket, which results in the pump not functioning properly.
3. The supply pipe rises and then drops again. If the supply pipe is thus laid, the result is that there is a vapor pocket in the supply pipe, which always permits vapor to collect in the pipe and causes an intermittent flow of oil to the burner.
4. There is a "dead end." The laterals lead from the supply pipe to the boilers or furnaces (whatever the oil pumping system is for) and there is no provision for any circulation of the oil.
5. The overflow pipe from the pressure relief valve is coupled to the suction pipe, which is absolutely incorrect.
6. But one pump is provided, and should the piston rod of this pump break (which is liable to happen even with the best construction) the result is that the plant is shut down, all the officials humiliated, the output ceases and an investigation follows; all of which is absolutely unnecessary if the oil pumping system is properly installed.

An Oil System which never disappoints the operator is shown in Fig. Nos. 24, 25, 26, and 27.

Proper Oil System. Please note the following:—

1. The tank is buried underground to conform with Underwriters' requirements.
2. The pumps are above the oil tank.
3. Oil is heated by means of modern oil heaters.
4. Two pumps and heaters are supplied (one of each for reserve). Each pump is supplied with a pump speed regulator so that in case the oil pressure on the oil supply line exceeds 12 pounds the steam operating the pump is automatically shut off, which in turn stops the operation of the pump.

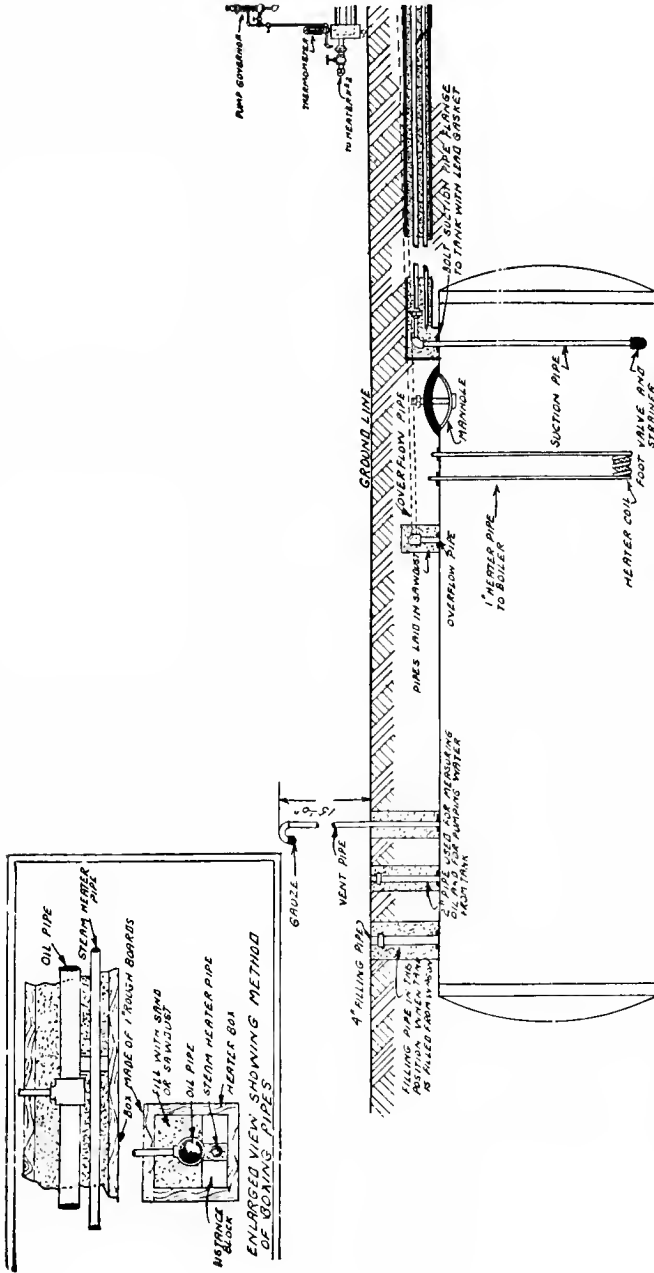

Fig. 25. Proper oil system. Note the foot valve, the strainer, heater, coil, steam heater pipe, etc. ELEVATION.

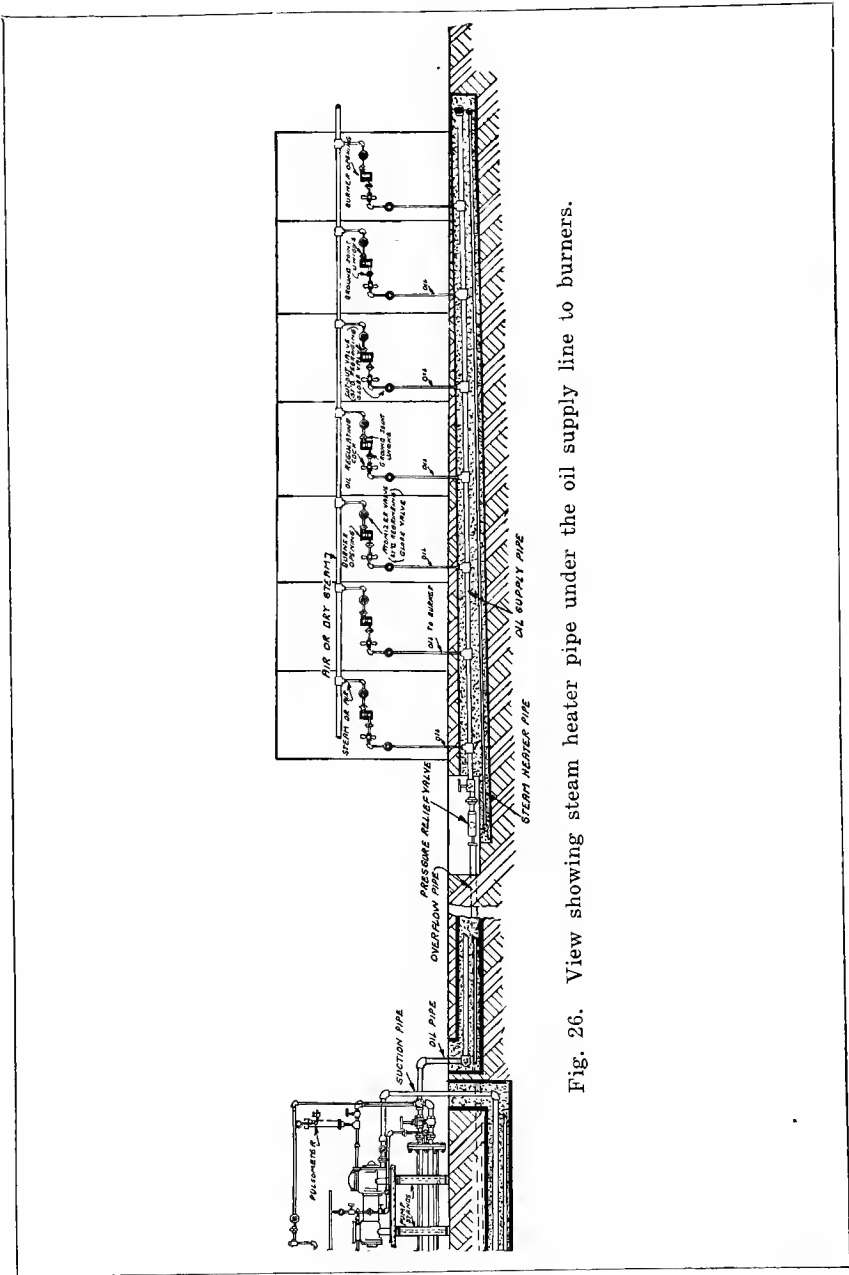
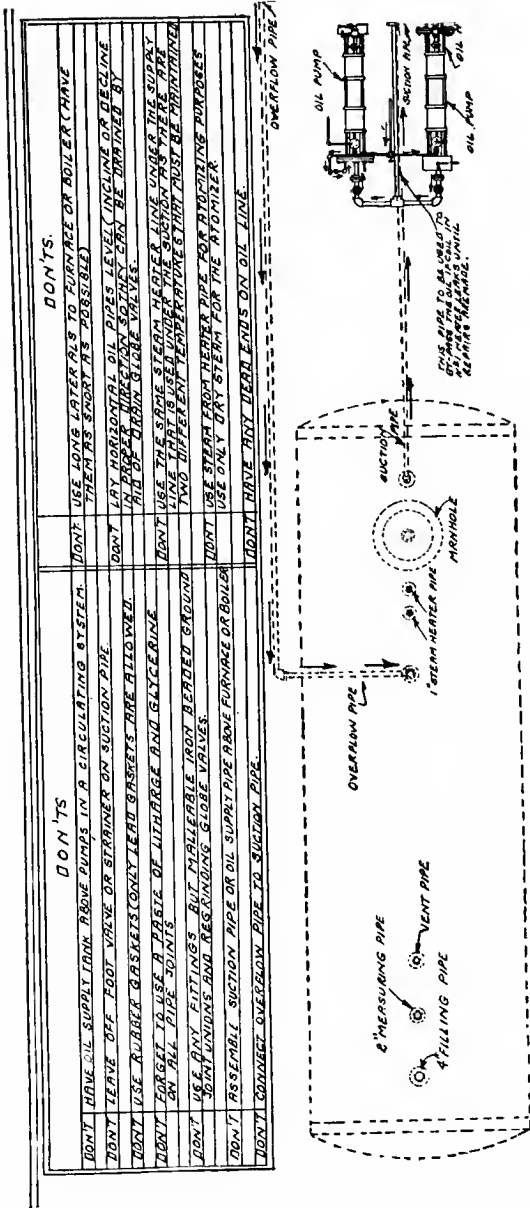

Fig. 26. View showing steam heater pipe under the oil supply line to burners.



PLAN VIEW
Fig. 27. Plan view of tank, etc.

5. The oil supply pipe is so run that very short laterals are required between the oil supply pipe and the boilers or furnaces.
6. The pressure relief valve is set beyond the last boiler or furnace so that if the oil is heavy and must be heated, hot

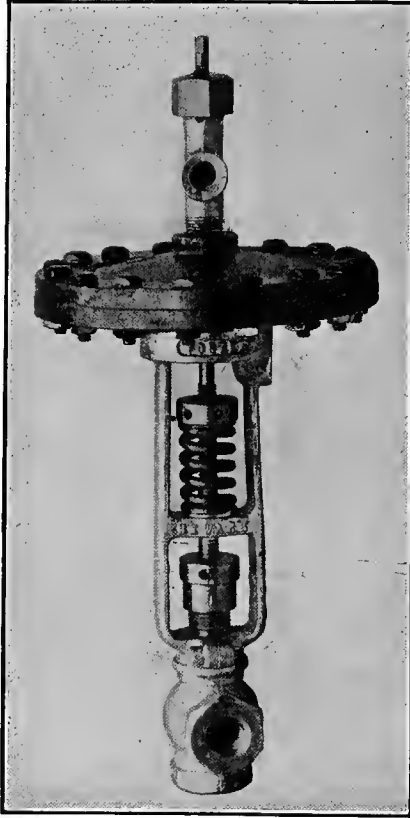

Fig. 28. Oil pump regulator.

oil is delivered to all of the furnaces or boilers at all times at the proper temperature.

7. There are absolutely no "dead ends," but a perfect circulation of the oil. The overflow or excess oil passes through the overflow pipe and back to the oil storage tank. The

overflow pipe is declined so that the oil will flow by gravity from the relief valve to the tank.



Fig. 29. Modern combination foot valve and strainer.

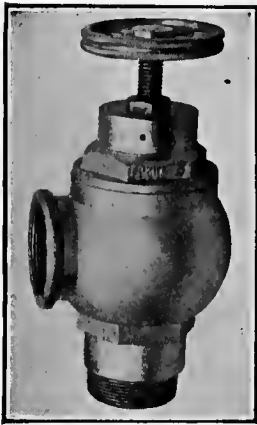

Fig. 30. Pressure relief valve.



Fig. 31. Pulsometer.

8. The oil supply tank is provided with a vent pipe, the exit end of which is covered with gauze so that the vapor rising from the oil can be vented from the vent pipe without danger.

The manner of applying a modern oil system to a boiler is shown in Figs. 33 and 34. The cost for installation of the extra pump and heater is of minor importance as compared with a possible shut-down because of a broken piston rod, valve, spring, etc. The exhaust of either pump may be employed for the heating of the oil, or if it is not desired to heat the oil, the exhaust of the pump may be by-passed to the open air. The valves upon the piping are so placed as to control the flow of oil to either one heater or to both heaters. The second heater, if desired, may be used to heat the oil by means of direct steam from the boiler to a higher temperature than can be obtained from the exhaust steam of the pump. The form of heater recommended is shown in Fig. 32.



Fig. 32. Oil heater.

Sometimes it is necessary during a coal strike or when for various other reasons the coal supply fails, to burn oil as an emergency fuel. In such a case it is advisable to use the temporary installation shown in Fig. 39. By means of the duplex pump and pressure relief valve set at 10 lbs. a complete circulating system is effected and the excess oil is pumped back into the oil tank car. The pump should be coupled to the bottom of the tank and it is quite necessary to place a valve for drainage. This is a good system to use if you desire to run a test in a furnace, burning oil in place of coal.

Oil storage tanks may be made in various forms and of various materials. That shown in Fig. 40 is of steel and you will note that there is an inner compartment provided with heater coils so that only approximately the quantity of fuel needed for one day is heated to the required temperature. This insures the fuel being supplied to the burners at the proper temperature and prevents deterioration

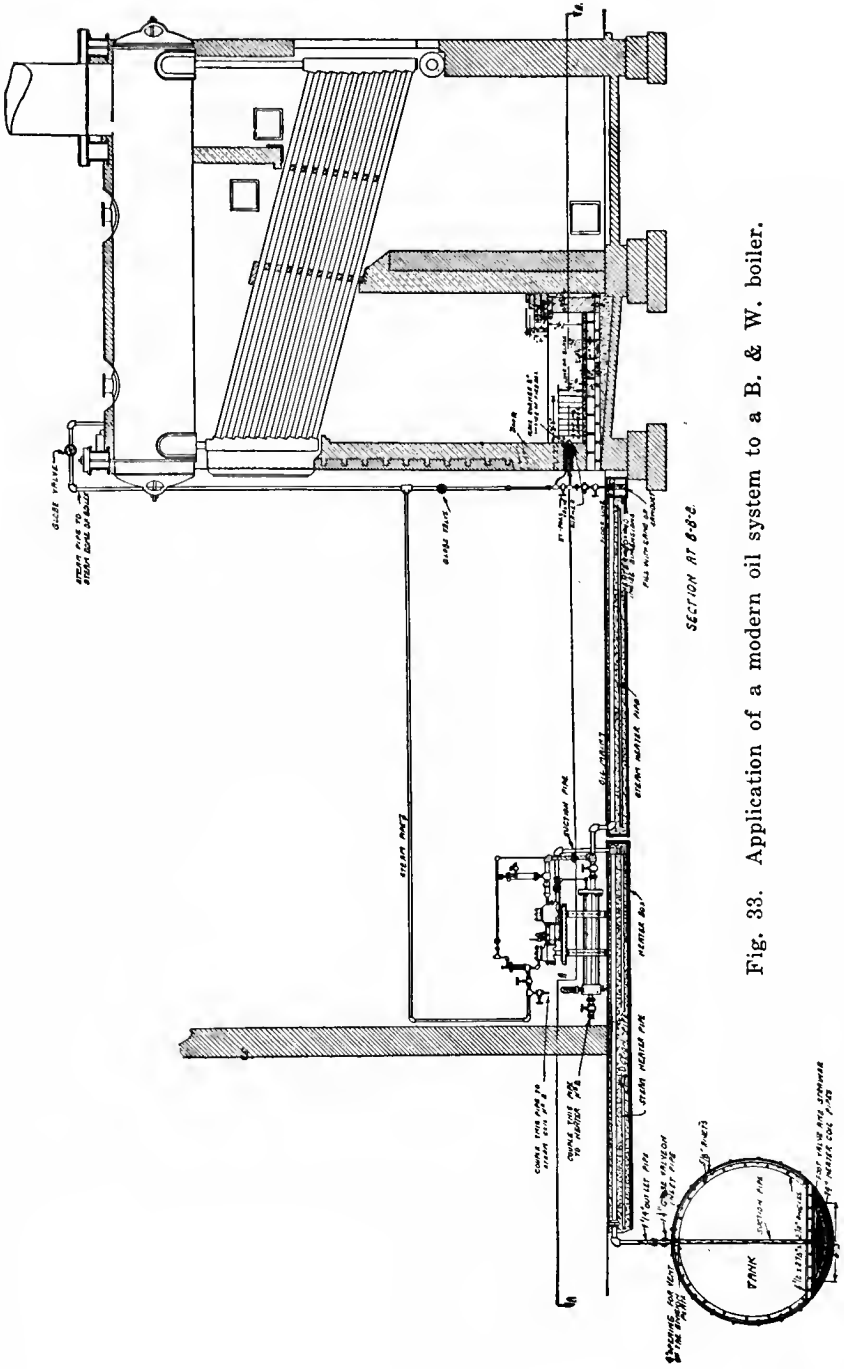

Fig. 33. Application of a modern oil system to a B. & W. boiler.

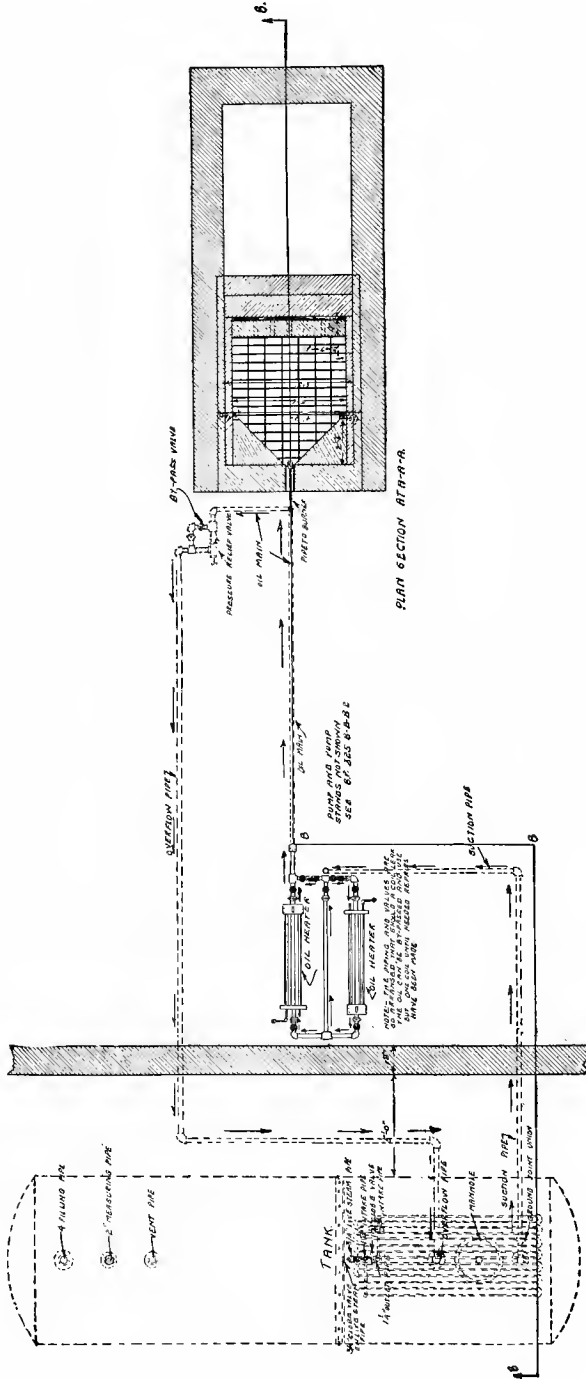

Fig. 34. Plan view of modern oil system as applied to a B. & W. boiler.

BURNING LIQUID FUEL

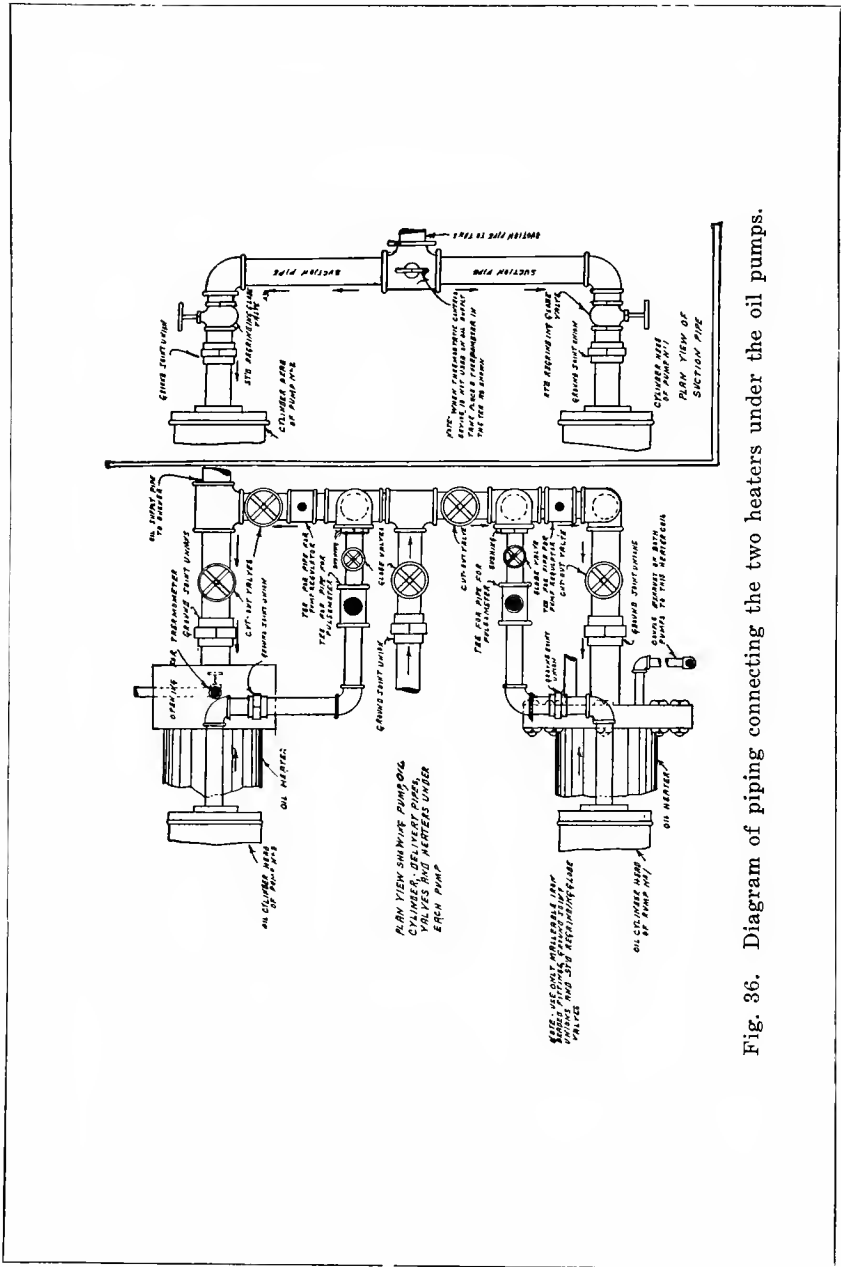
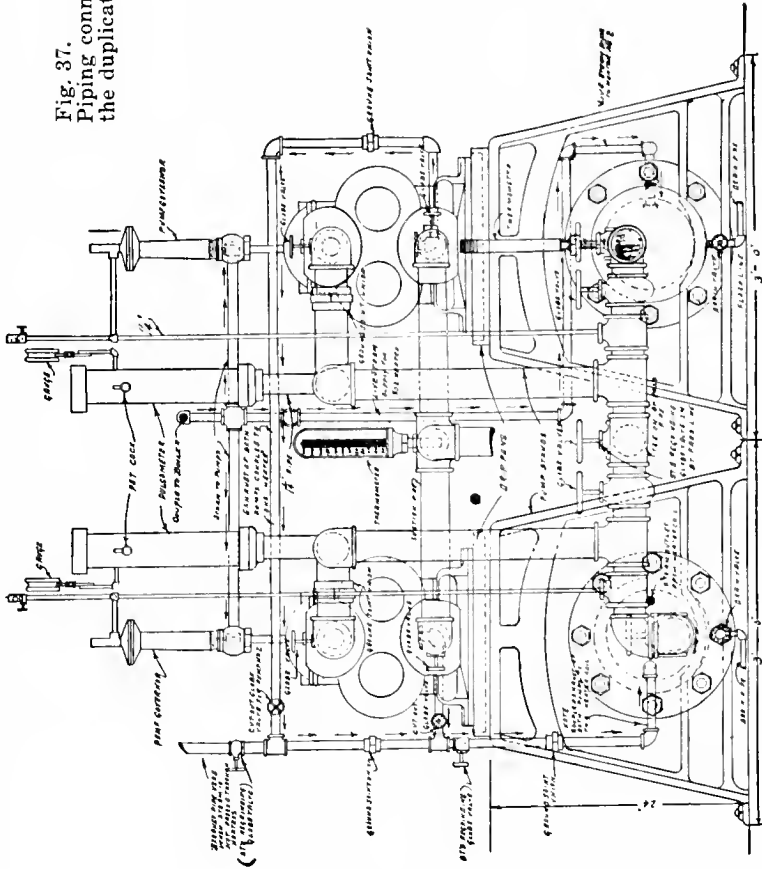

Fig. 36. Diagram of piping connecting the two heaters under the oil pumps.

Fig. 37.
Piping connecting
the duplicate system.



BURNING LIQUID FUEL

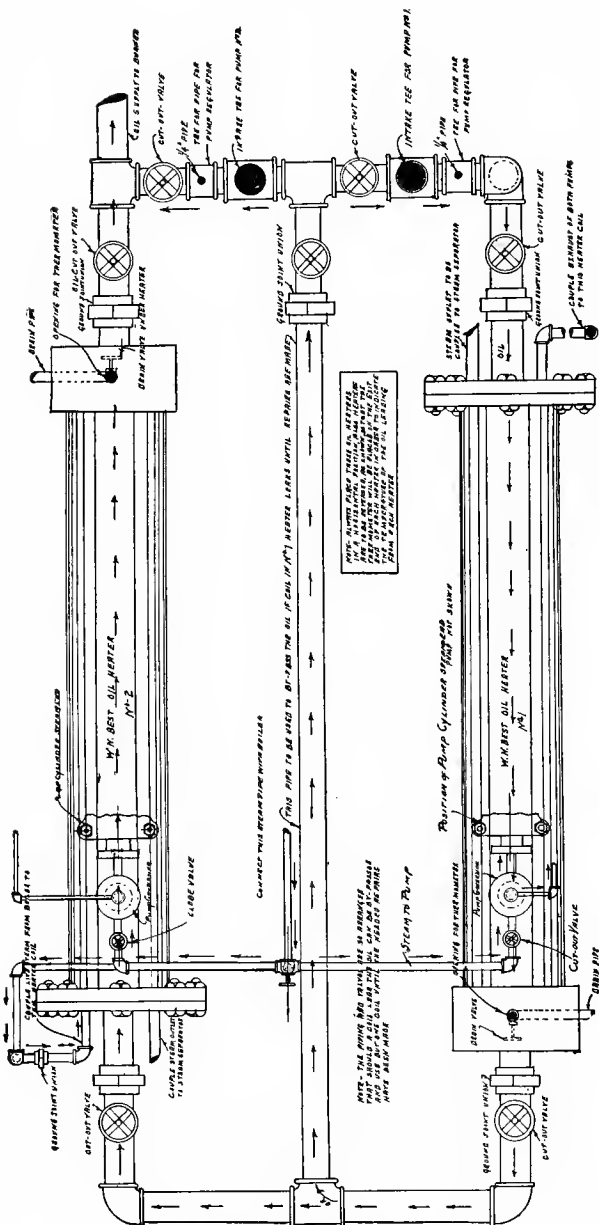
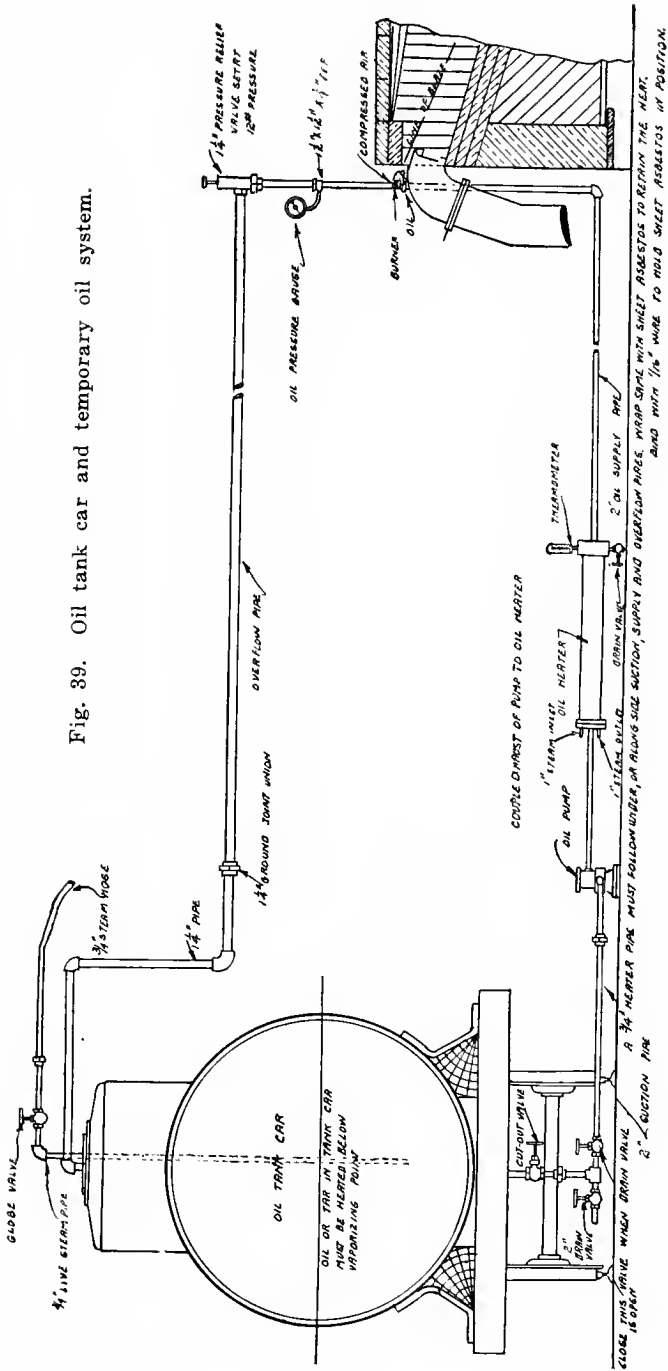

Fig. 38. Diagram showing location of the two oil heaters.

Fig. 39. Oil tank car and temporary oil system.



BURNING LIQUID FUEL

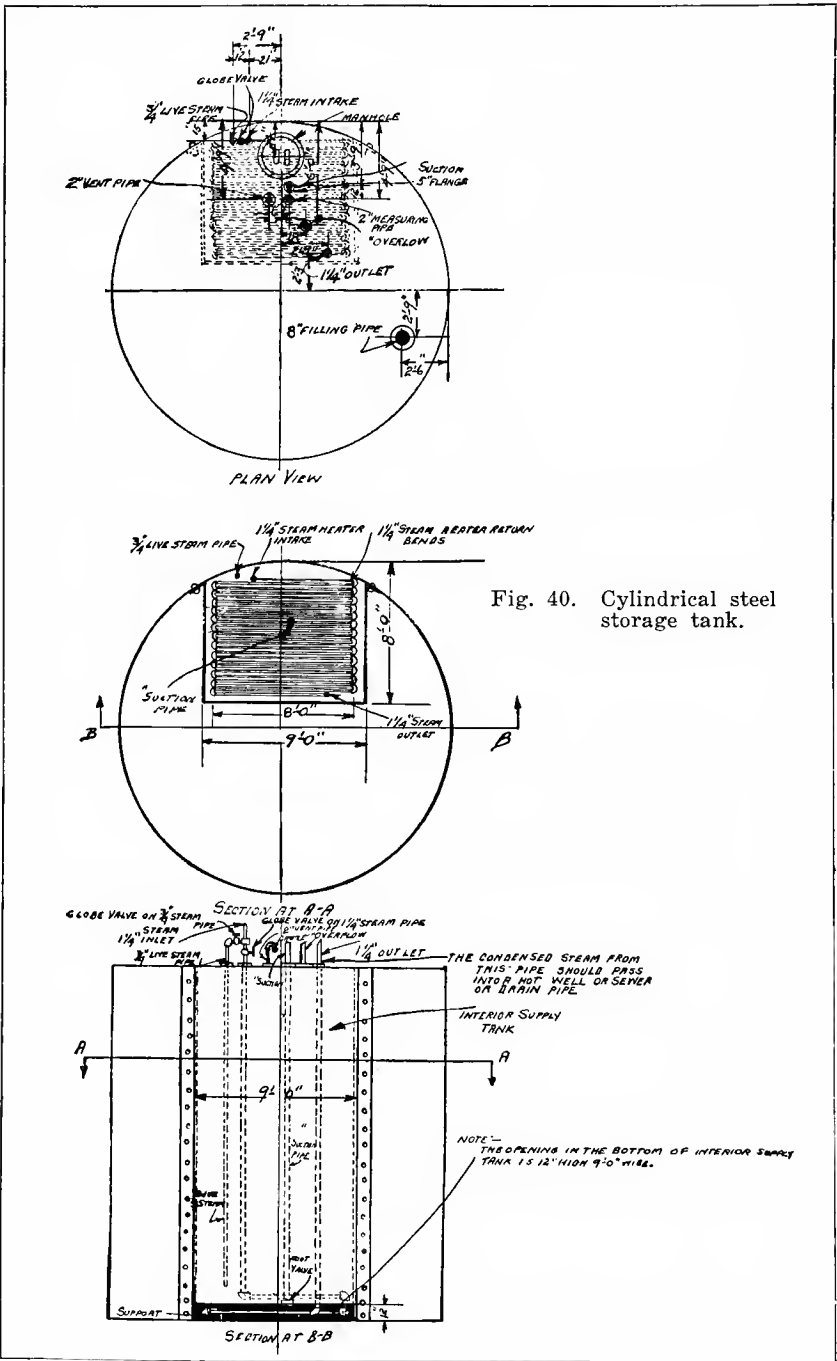
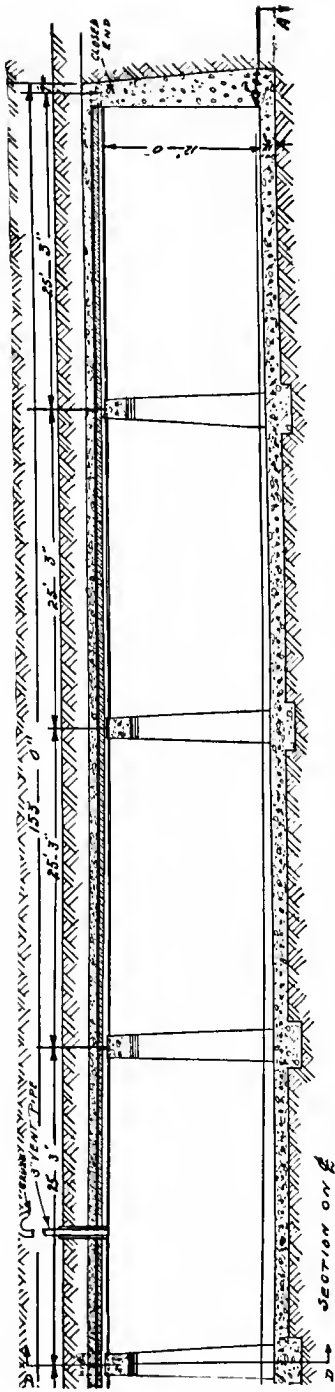

Fig. 40. Cylindrical steel storage tank.



REINFORCED CONCRETE STORAGE TANK
APPROX 480,000 GAL.

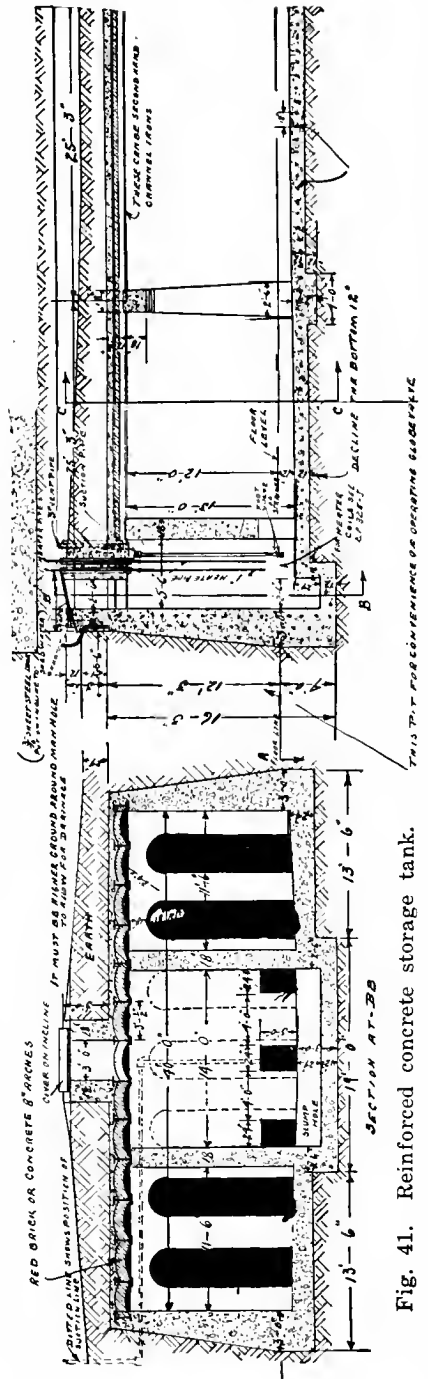

Fig. 41. Reinforced concrete storage tank.

BURNING LIQUID FUEL

or loss through evaporation of the more volatile gases in the larger body of fuel.

The dimensions of the walls and the manner of constructing or reinforcing a concrete oil storage tank depends upon the location

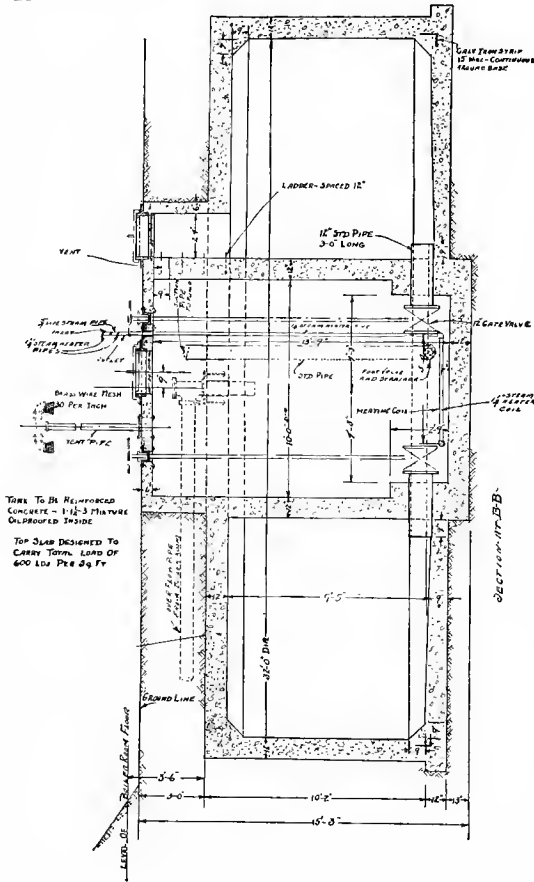

Fig. 42. Large cylindrical concrete oil storage tank.

and the soil. That shown in Fig. 41 is 153 ft. long, 40 ft. wide, capacity 480,000 gallons. The bottom of this tank slopes down toward the center and there is a slump hole from which the sand or other foreign substance may be removed through the trap

door on top of the small compartment immediately above the slump. Heater coils are so placed that only the fuel required for daily consumption is heated.

Often it is not convenient to install a long tank. The cylindrical form is shown in Fig. 42. This has the small compartment with coils for heating one day's supply in the center of the larger tank.

The Care of Oil Tanks

The following sign should always be placed in a position where it can easily be observed:—

“No smoking.

“Do not come near these tanks with an open flame torch or a lantern, nor use matches.”

It is very important that great care be taken in this particular; and when it becomes necessary to enter the interior of a tank, all oil should be removed and the tank steamed for at least one week. Do NOT under any circumstances allow men to enter a tank to remove oil if it contains over 1% sulphur. It is criminal carelessness to order men to go into an oil tank before all oil is removed and the tank thoroughly steamed for several days, for the effect of the sulphurous gas in the tank would possibly destroy the lives of many men.

Nothing but electric lights should be used in or about oil tanks after oil has once been placed in them.

Since it is a fact that vapor or gas is constantly passing from the oil in the oil tank, it is absolutely essential to provide a vent pipe and always cover this vent pipe with wire gauze of 1-16 inch mesh; for if wire gauze were not placed thereon and the flame from a torch, lantern, oxy-acetylene torch, etc., should come within, say, one foot of this vent, it would almost instantly cause an explosion. You should use every precaution to prevent such an occurrence.

To find the capacity of a cylinder or tank in gallons, square the diameter in inches by its length in inches, and by .0034; or square the diameter in inches by its length in feet and by .0408; or square the diameter in feet and by its length in feet and by 7.4805.

Pyrometers, thermometers, draft gauges, oil and water meters, etc., are all good paying investments, and tend to increase the efficiency of a plant.

BURNING LIQUID FUEL

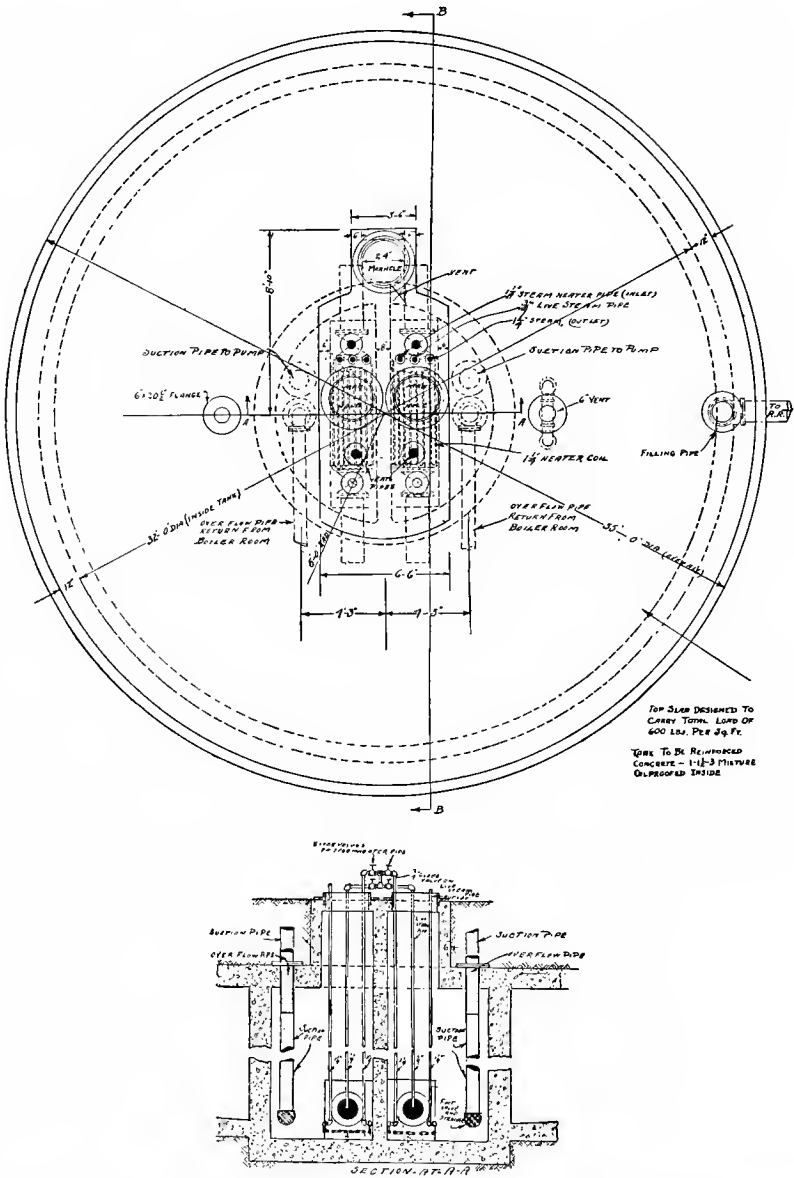

Fig. 43. Diagram showing central compartment with piping, heaters, etc., in cylindrical concrete tank.

Chapter V

REFRACTORY MATERIAL

Poor fire-brick should never be used as it is most disappointing both to the builder and owner of the furnace. It takes as much time and labor to construct a furnace of poor fire-brick as of good brick. Poor brick is dear at any price, no matter what may be the fuel used.

The excessive heat which can be obtained from liquid fuel makes it necessary in many instances to use a very superior grade of fire-brick. For example, in welding furnaces the lining should be capable of withstanding 3,000 degrees Fahrenheit without dripping or melting away, while in crucible melting furnaces the fire-brick must be capable of withstanding the high temperature required to melt fourteen pots of crucible steel at one heat. These bricks must be non-expanding, for if they were to expand in the same proportion as silica brick, the furnace lining would become six inches too long, which amount of expansion would ruin the construction of the furnace. The analysis of brick for crucible furnaces is as follows:

Silica	56.15 %
Alumina	33.295%
Peroxide Iron	0.59 %
Lime	0.17 %
Magnesia	0.115%
Water and inorganic matter.....	9.68 %

In open hearth furnaces a silica brick is essential because it will withstand the required high temperature, and as these furnaces are operated continually the expansion and contraction of this brick has not the detrimental effect in this class of service which it has in a furnace which is only operated eight or ten hours daily. In annealing furnaces, owing to the lower temperature required for the heat-treatment of metals, it is not necessary to use such good quality of brick. It is, however, essential that these bricks

do not expand nor contract. It is also very necessary that the furnace be carefully constructed by a competent furnace builder, for the bricks should not be laid in layers of fire clay the way ordinary red bricks are laid with mortar, but should simply be dipped in very liquid fire clay solution, and then laid in place. It is advisable to use special shaped bricks for lining small furnaces, owing to the fact that it does not require a skilled mason to place



Fig. 45. Furnace with front casting removed to show special shaped brick lining.

these blocks in position. For example, two blacksmith helpers can reline a furnace, having charging space 18 inches wide, 22 inches deep, by 16 inches high, with 13 large, accurately shaped blocks in forty minutes. As these shapes are interlocking and as the number of the joints is greatly reduced, this lining lasts about three times as long as a furnace lined with ordinary standard size fire-brick. This fully demonstrates the theory that every fire-brick joint in the furnace shortens the life of the construction.

As magnesite brick has no affinity for iron, it is often used for

furnace bottom in welding furnaces, etc. For air furnace bottoms a special grade of sand is necessary, the analysis of which is as follows:

Silica	89.94
Oxide of Iron	2.64
Oxide of Aluminum	3.26
Magnesia	trace
Lime	trace
Total Alkali	2.62
Loss on ignition	1.50

Chapter VI

LOCOMOTIVE EQUIPMENT

Hundreds of locomotive firemen are today rejoicing because of the discovery of liquid fuel, for instead of their runs being a continuous arduous task of shoveling coal they are riding like a prince on their seat in the cab, gazing out of the window at the track ahead, safeguarding their own lives as well as those of the traveling public in the train. One hand rests upon the lever of an oil-regulating quadrant by means of which they can instantly in-

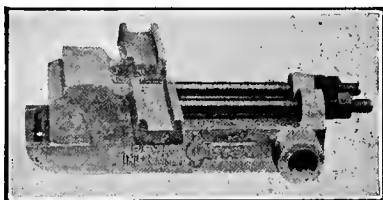

Fig. 47. Locomotive oil burner.

crease or decrease the flow of fuel passing into the fire-box. When a locomotive is changed from coal to oil, its tonnage is increased 15%, for you can at all times maintain the full boiler pressure of steam. Even while going up the highest grade or mountain, the steam pressure in the boiler is not lowered and there is absolutely no smoke. As there are no smoke or sparks emitted, the danger of setting fire to forests, bridges, buildings, etc., is eliminated, and, because of this fact, oil-burning locomotives are used in coal mines, on divisions passing through timber lands, etc. Before oil was introduced, timber of inestimable value was destroyed by sparks in Louisiana, the Adirondack Mountains, etc.

Great advances have been made in the equipment of locomotives, but the types are so numerous it is difficult to specifically describe these changes. Formerly it was customary to bolt the burner to

the mud ring below the fire-box door, directing the flame toward the flue sheet under an arch made of A-1 fire brick. This arch was a source of great difficulty, as it often fell or wasted away, thus deflecting the heat against the crown sheet. Again, too, often if the flues began to leak, the water dripping down upon the arch penetrated the fire-brick, thus generating steam which caused the

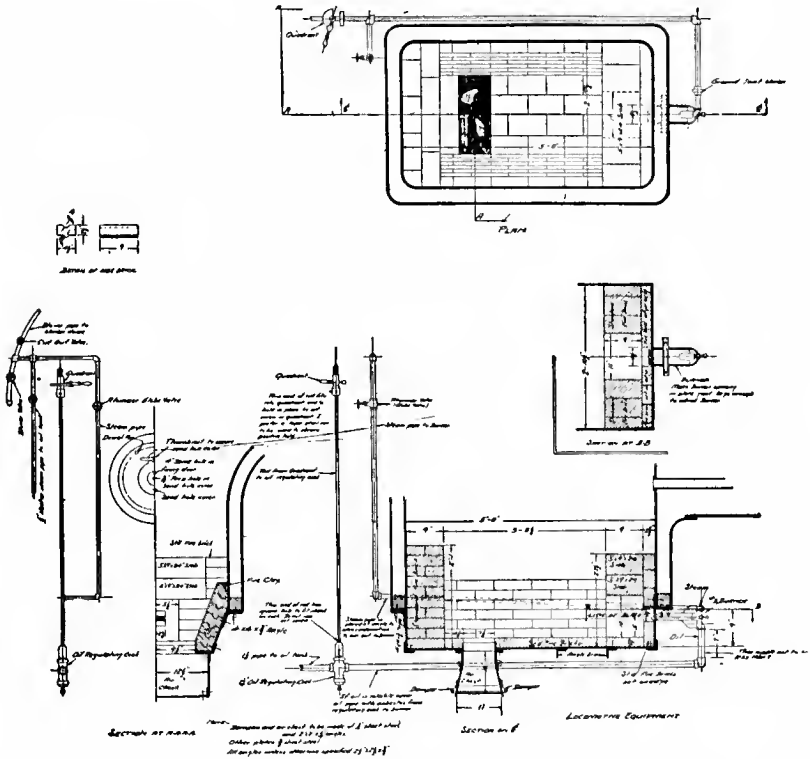

Fig. 48. A modern type of locomotive equipment.

structure to crumble and fall. The most modern practice is to eliminate the arch entirely, the burner being placed at the flue sheet end of the fire-box substantially as shown in Fig. 48. This insures a reverberatory movement of the flame and heat for the burner directs the flame against the fire-brick cross wall at the rear of the fire-box, where it is deflected and drawn forward by

the exhaust to the flue sheet end of the fire-box. The grates, of course, are always omitted. By means of the inverted arch with dampered air opening, the quantity of air necessary for perfect combustion is regulated according to requirements. When the locomotive is going forward the rear damper is open, and while the locomotive is going backward the front damper is open.

I show but one type of inverted arch, but will say that these vary in construction. Some have damper-controlling devices by which the fireman can accurately control the admission of air passing into the fire-box, while others admit the air through openings in the burner end of the inverted arch. A fireman who uses judgment in the operation of the damper type secures the highest economy in fuel by admitting just sufficient air while at the same time allowing no smoke to pass from smoke stack—in



Fig. 49. Fireman's regulating quadrant.



Fig. 50. Locomotive oil regulating cock.

other words, he effects perfect combustion. Careless firemen who do not use good judgment in controlling the damper make a better record in fuel economy by the use of the type of inverted arch with air openings at the burner end. Care should always be taken not to admit a superfluous amount of air into the fire-box, as it requires additional fuel to heat excess quantity air to the temperature of the fire-box.

The fireman's regulating quadrant takes the place of the coal shovel on an oil-burning engine. The early history of liquid fuel equipment shows that many locomotive fire-boxes were ruined because the fireman inadvertently shut off the fuel supply while drifting down a long grade or coming into a station. He thought he had a light fire, but there being none, the cold air, rushing in,

damaged the fire-box and started the flues to leaking. This difficulty is now entirely obviated by the use of a quadrant attached by means of a rod to an oil-regulating cock (Fig. 50), having a V-shaped knife-edge orifice in the plug through which the fuel enters and passes out through a much larger orifice. With this apparatus you can have the pops operate going up the steepest

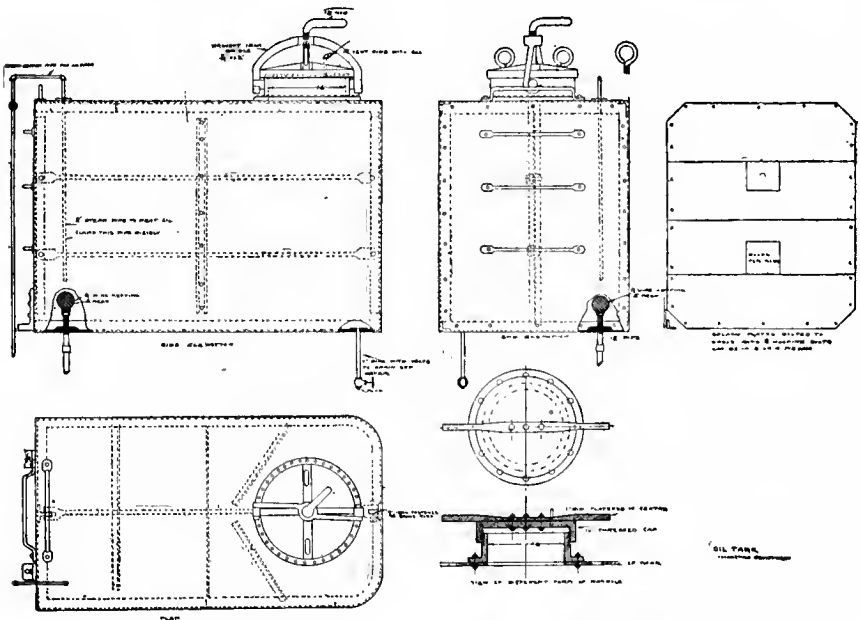

Fig. 51. Oil tank placed in former coal space of locomotive tender.

grade on any mountain if so desired, or you can hold the steam at any pressure without varying 5 pounds over the division of any railroad. While drifting the lug of the lever or handle of the quadrant engages with a set screw in the hinged latch, which insures a constant light fire sufficient to maintain steam pressure and operate the air pump. When speed or maximum power is required the lever is moved towards the left, which increases the flow of oil. When the engine is placed in the round house the hinged latch is thrown back, and the lever is moved to the right as far as possible and the top thumb screw tightened. In this

position the lever is stationary and the fuel supply to burner entirely shut off.

An oil tank, such as can be placed in the former coal space of the locomotive tender to supply fuel over a division, is shown in Fig. 51. This tank can readily be filled. Means are provided for heating the coil in this tank substantially as shown; also splash plates in order that the oil may be carried in this tank the same way as water is carried in the tender tank. The bottom of the tank is ordinarily only one foot above the burner, but with the form of atomizer shown in Fig. 47, which has a syphoning action, this pressure is sufficient so that air is not required to force the fuel to burner.

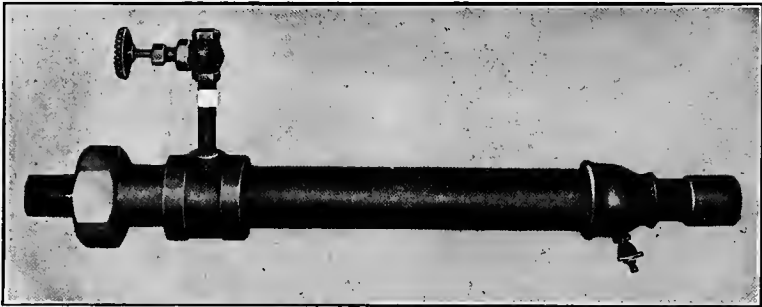

Fig. 52. Oil superheater.

When heavy oil is cold and viscous, the locomotive can not pull her tonnage, and carbon will lodge on the fire-brick lining of the inverted arch. Although heated by steam coils in the storage tank of tender it is often wise to have heavy viscous fuel pass through a superheater just before it reaches the regulating cock so that it will get to the burner heated to just below the vaporizing point. The superheater shown in Fig. 52 is both simple and durable, and is operated by a globe valve conveniently placed for the fireman, which allows the steam to surround the oil pipe, all condensation passing out of the drain cock at the bottom of the superheater. Such a device is really a necessity when the oil tank has been filled at the end of a division, for it takes some time for the cold, heavy oil to become sufficiently heated by the steam pipe in the tank.

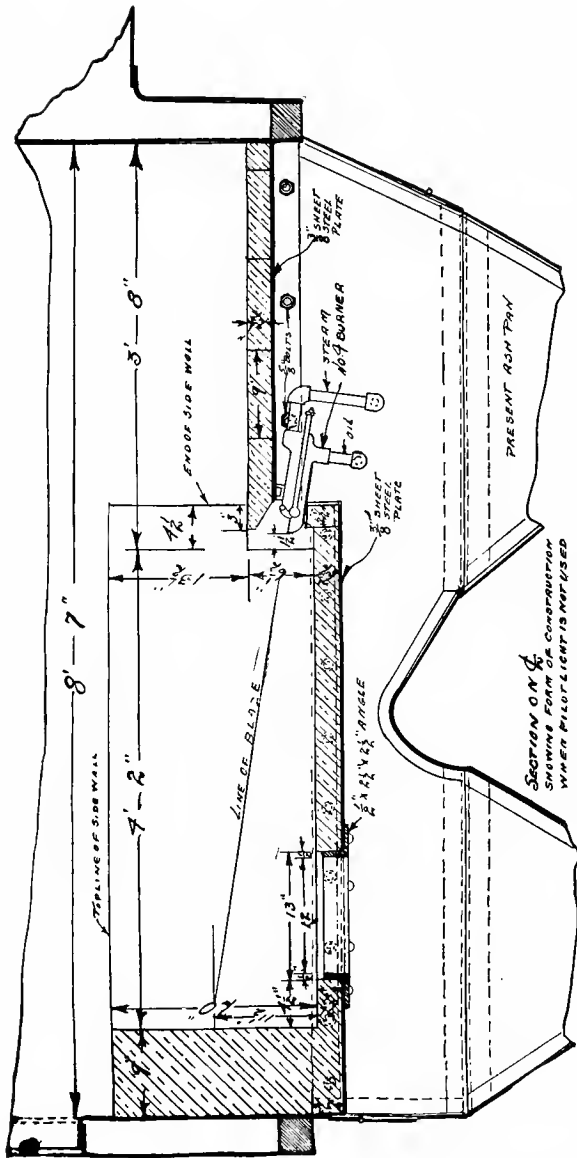

Fig. 54. Equipment of another type of locomotive.

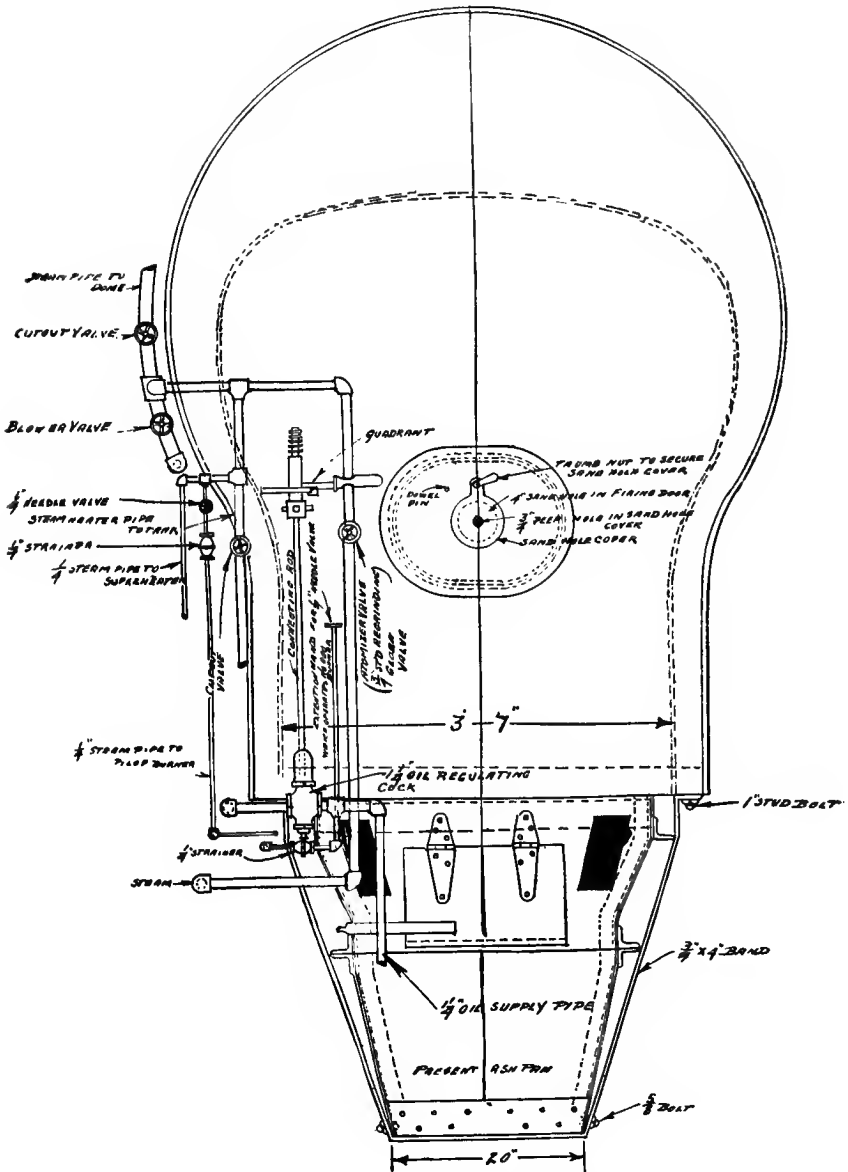

Fig. 55. Diagram showing fireman's operating valves, etc.

As soon as a locomotive is changed from coal to oil fuel (which can be done at a very small cost), the train-tonnage of the engine is increased 15 per cent., because the locomotive can easily carry the steam pressure at all times at just below its "popping-off" point. This, of course, cannot be done while using coal as fuel.

For locomotive service the most modern practice is "the duplex oil system," which employs two burners, a small and a large one. The former, used as the engine leaves the round house, and operated continuously thereafter, serves as a pilot light, as well as to keep just sufficient heat in the fire-box to maintain the temperature and the steam required when the locomotive is standing still. It keeps the steam at just below the "popping-off" point when only the air pump is running, and no other work is being done. The large burner, ordinarily placed above the smaller one, is operated when the locomotive is at work. By this system the life of the

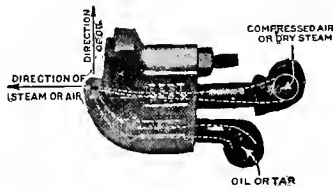

Fig. 56. Pilot burner.

boiler is increased, and the handling of the locomotive becomes much simpler. The larger burner is only operated when the locomotive is in actual service, which of course means a great saving in fuel. A small burner outfit will pay for itself in the saving of fuel effected by its use, many times during the course of a year.

Gravity oil feed is ordinarily used in locomotive service. Air pressure should not be used on the locomotive oil tank to aid in forcing the fuel to the burner; but in stationary or marine practice 10 pounds pressure should be maintained on the oil-supply pipe.

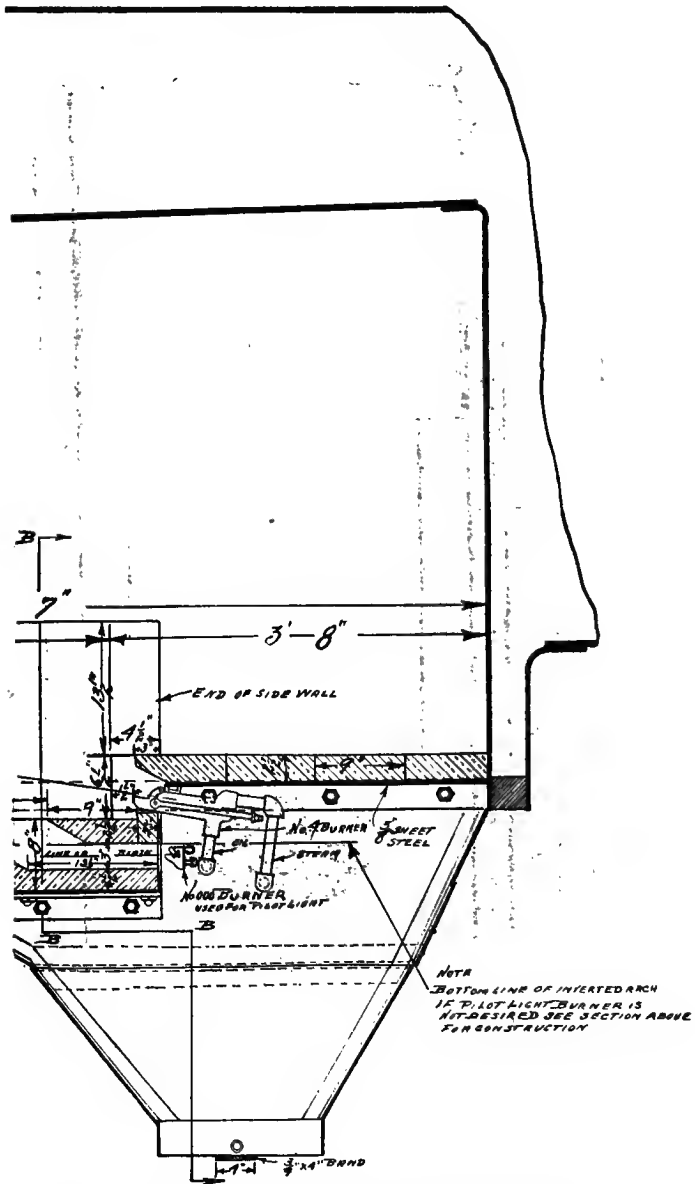
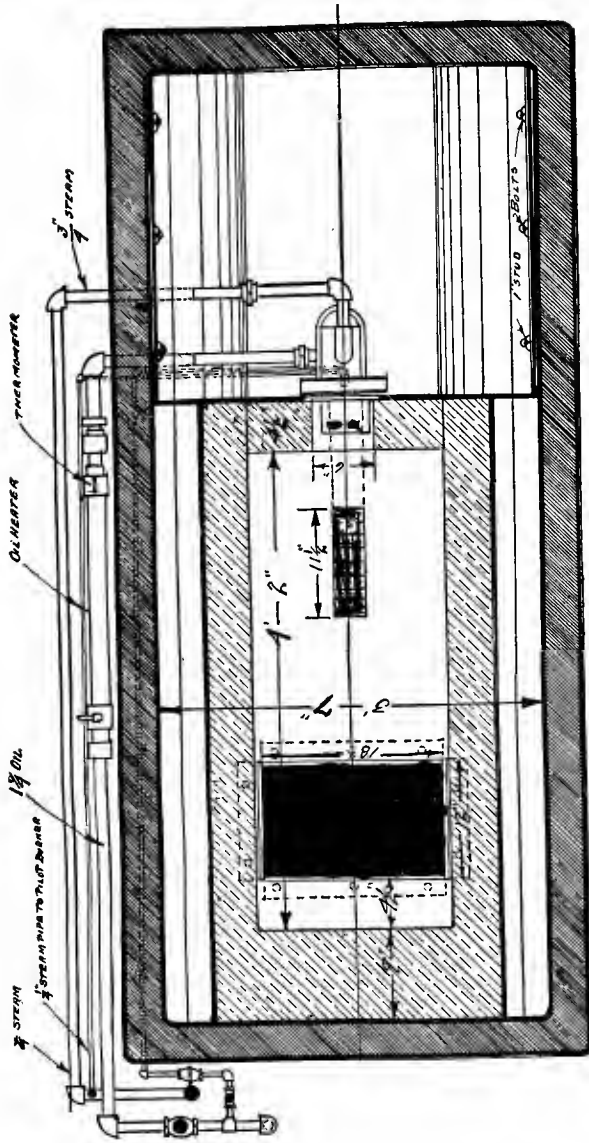

Fig. 57. Locomotive equipment using pilot burner.



SECTION AT-AA
Fig. 58. Plan view, pilot burner equipment showing piping to burners and openings in the inverted arch.

Chapter VII

STATIONARY AND MARINE BOILERS

The Steam Engineering Department of the United States Navy in 1904 conducted a series of tests upon a water-tube boiler using oil as fuel. The Bureau at that time was under the charge of the

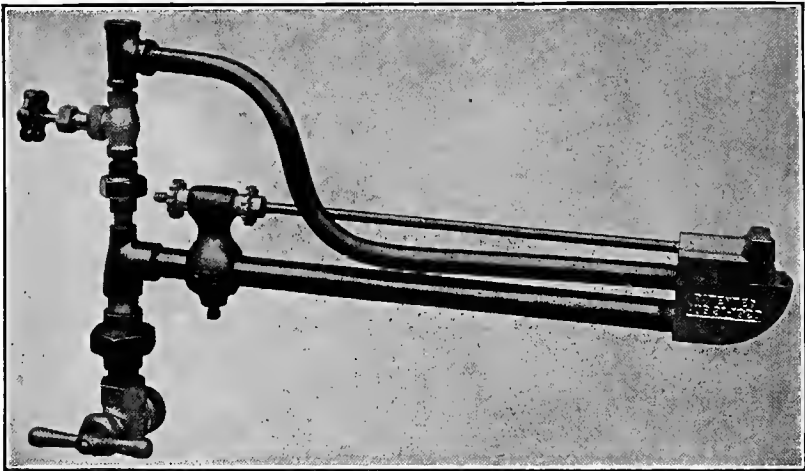

Fig. 61. High pressure oil burner mounted for marine or stationary boilers, burning oil or tar exclusively as fuel.

late Rear-Admiral George W. Melville, and the tests were conducted by a competent board of efficient naval engineers, viz.: John R. Edwards, Commander (now Rear-Admiral), U. S. Navy; W. M. Parks, Lieutenant-Commander, U. S. Navy; F. H. Bailey, Lieutenant-Commander, U. S. Navy; and Mr. Harvey D. Williams and Mr. Frank Van Vleck, two oil experts who served the Board as secretaries. These gentlemen faithfully discharged their duties and gave to the United States and, in fact to the whole world, a most accurate and exhaustive report on the burning of oil in boilers

which still remains the highest authority on boiler equipment and has done much toward the introduction of oil in the manufacturing world as well as in the navies and merchant marine. We owe this Board a debt of gratitude for their untiring efforts in our behalf.

In some sections of the country where oil is cheap it is extensively used in stationary and marine boilers. For this purpose it is most excellent, for it insures perfect combustion and a constant, even fire, whereas in the burning of coal it is impossible to keep up an even heat because of its being necessary to so frequently replenish the fuel supply. There is no expense for the handling of fuel and ashes. One man can fire and water-tend a battery of twelve oil-fired boilers using the oil burner shown in Fig. 61. This burner is mounted with piping of sufficient length to go through the front setting of the boiler. By means of the by-pass valve any foreign substances that might enter the oil pipes can be blown out. The atomizer lip is movable so that should any foreign substances, such as scale, sand or red lead collect in the atomizer pipes or slot, it can readily be removed. This is done by slackening the locknut on the end of the connecting rod, which allows the steam used for atomizing to push the lip forward and blow out the foreign substance without removing the burner from the boiler. With this type of burner, steam should be used for atomizing purposes in high pressure boilers, owing to the fact that the steam in passing over the oil orifice acts as a syphon. Furthermore, as the steam passes out of its small orifice and over the oil orifice, it expands, which has a compressing effect upon the fuel. When the steam pressure in the boiler lowers, this compression is reduced and this allows more oil to pass out of the oil orifice to meet the load. In other words, while this burner is not considered automatic, it functions automatically. The steam and oil orifices are independent of one another and on account of the atomizer orifice being above the fuel orifice, there is no liability of the burner carbonizing.

In traction power houses where, for about three hours in the morning and three hours in the evening, it is necessary to develop twice as much power as during the rest of the day, the engineers with oil have no difficulty in developing double the normal rated horse-power of each boiler without injury to the elements, thus entirely obviating the necessity of keeping extra boilers with banked fires. In some plants where coal is ordinarily used as fuel the boilers carry the peak loads by using a combination of oil and

BURNING LIQUID FUEL

coal, the burners being placed inside of fire-box as shown in Fig. 62.

Another service of great importance and of growing demand is in large electric light plants which formerly had a long battery of boilers carrying banked coal fires, for during a storm or threat-

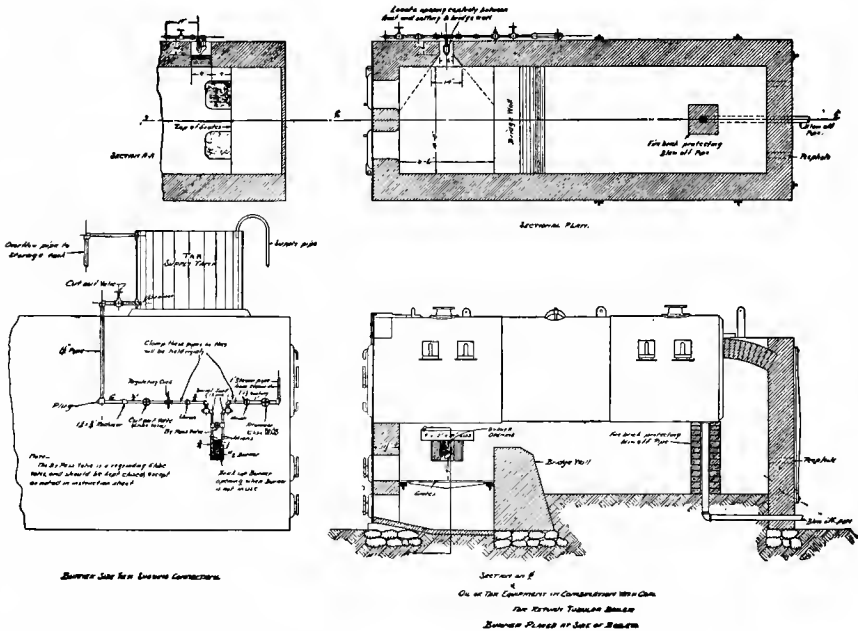

Fig. 62. Boiler equipped for the use of oil or tar to aid coal or breeze fire in carrying peak loads.

ening weather many lights are turned on simultaneously throughout a city, thus necessitating the immediate replenishing of electrical energy. A number of plants have been changed to oil by placing the burner in the front end setting of boiler, the grates being covered with a checker-work of fire-brick, the opening in the checker-work being of such proportions as to admit sufficient oxygen for the consuming fuel. A gas pilot light is constantly kept burning and when the boilers are suddenly called into service the oil burner is started in five seconds by simply operating the two operating valves, and in ten minutes 150 pounds of steam is on

the boiler. Of course, when not under fire, hot water is constantly passing through these boilers, this being the same practice as is used in fire-engine houses.

Oil is used in some power plants where they have stokers and where a boiler is called into service quickly. In this case the oil burner is mounted with swivel joints (see Fig. 63), and when called into use it is simply swung from its position at the side of the boiler and plays its fire over the bed of coal until the green coal fire has been properly ignited, after which it is swung out of po-

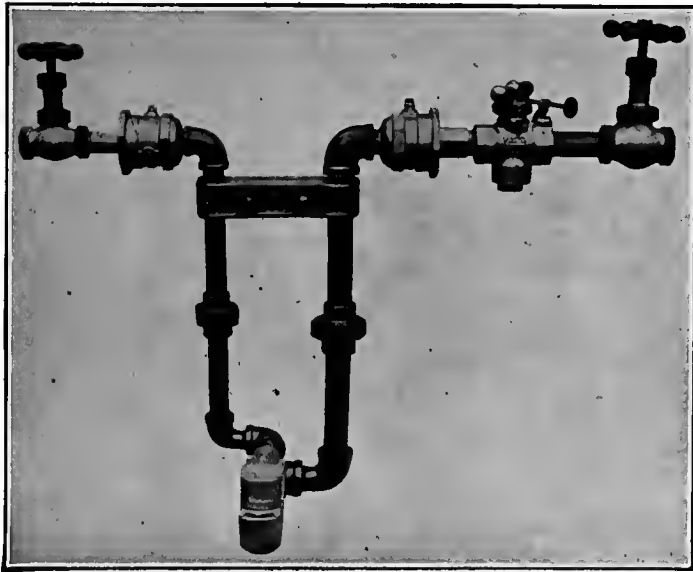

Fig. 63. Oil or tar burner mounted with swivel joints.

sition and the burner opening in the side of fire-box is closed by fire-brick of the exact size and form required to fill the burner opening.

With the average fluctuating load in stationary boilers it requires approximately 147 gallons of oil having calorific value of 19,000 B.t.u. per lb. and weighing 7.5 lbs. per gallon to equal one long ton of bituminous coal (2240 lbs.) having calorific value of 14,200 B.t.u. per lb.

The analysis of one of the best coals is as follows:

Carbon	82.26%
Hydrogen	3.89%
Oxygen	4.12%
Nitrogen64%
Sulphur49%
Ash	8.60%
	<hr/>
Total	100 %

Calorific value per lb. 15,391 B.t.u.

However, the average of good coals has a calorific value of 14,200 B.t.u. per pound.

There are many types of stationary boilers all of which play their particular part in the manufacturing world. Along the line of railroads old locomotive boilers discarded from railway service are often used in water pumping stations. Oil is an excellent fuel for this work, for the fireman can adjust the burner and have plenty of time to care for the pumping plant, as he does not have to regulate the burner for three or four hours at a time, but of course he must give attention to the water supply for the boiler. In Fig. 64 is shown the manner of equipping such a boiler. If, however, oil is simply to be used in emergencies, the grates need not be removed for they can be covered with a checker work of fire brick as indicated in Fig. 65. A $2\frac{1}{4}$ " tube through which to place the burner is placed in between the throat sheet and the flue sheet. This tube is beaded over in the same manner as when a flue is beaded against the flue sheet of the boiler. There are some equipments in which it is impossible to pass the burner through the throat sheet and in such cases the burner is installed as shown in Fig. 66. A deflection wall is placed across the fire-box in the manner shown and the burner is inserted through a $2\frac{1}{4}$ " tube, beaded on each end. It is important that no air be admitted between the flue sheet and the cross wall.

In the equipment of the water-leg boiler (Fig. 67) the burner is inserted in a tube which is beaded over on each end. The flame from the burner is directed towards the firing door. Sufficient space should be left in the door opening for firing up with wood when the boiler is cold and there is no steam with which to begin operating the oil burner.

If the refractory material is placed in an Economic boiler as shown in Fig. 68, the 18" arch prevents any short-circuiting of the flame and heat when the fire from the oil burner is reduced. The refractory construction shown makes it very easy to fire up this boiler with wood without removing the burner or piping. In plants where there is only one boiler, if the dampers are carefully closed when the burner is shut off at night, there will ordinarily be forty

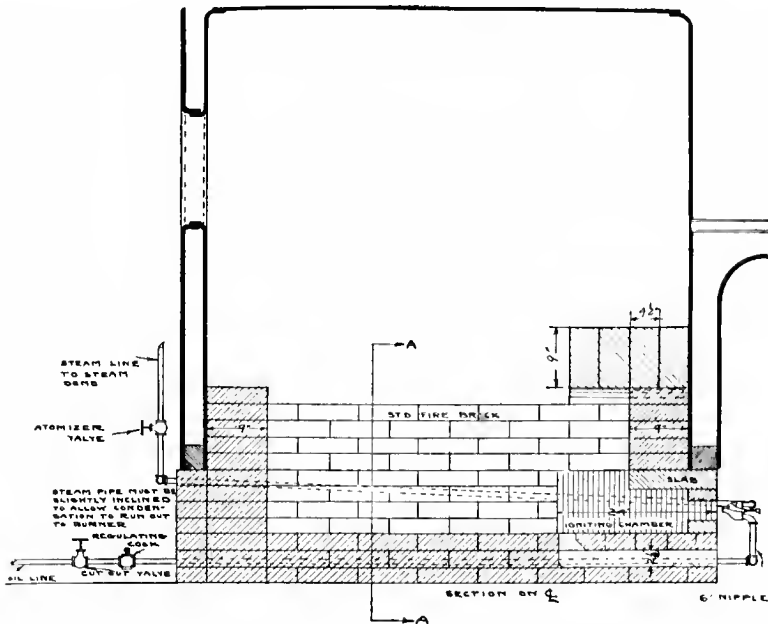

Fig. 64. Locomotive boiler equipped for stationary service.

or fifty pounds of steam on the boiler in the morning with which to begin operating the burner, as the heat radiating from the refractory material will maintain that pressure during the night. After the boiler has been washed out or closed down over Sunday it is necessary to fire the boiler with wood until ten or fifteen pounds of steam is raised, but with this type of equipment this can be done with the full assurance that no injury will be done to the burner.

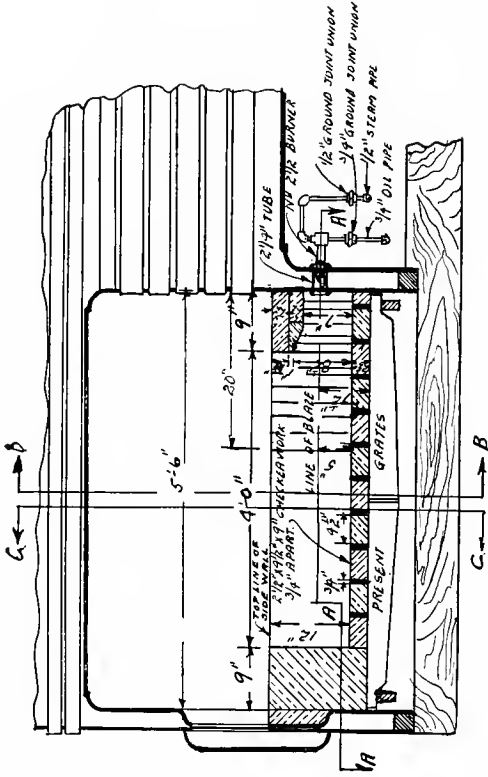

Fig. 65. Equipment of locomotive boiler for stationary service—grates not removed.

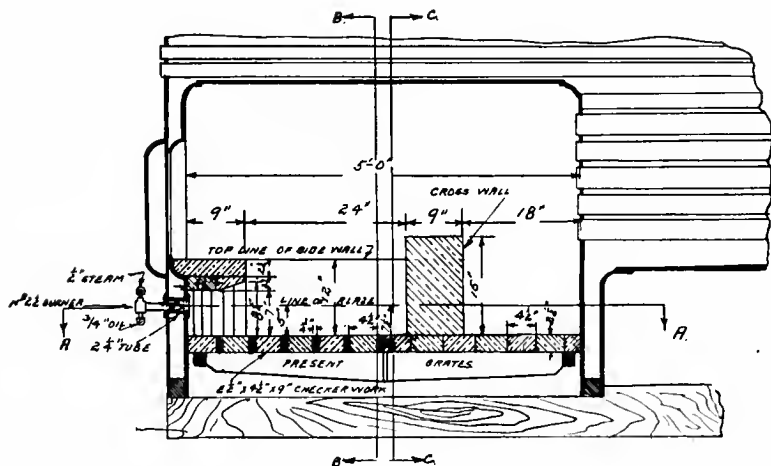

Fig. 66. Equipment of locomotive type stationary boiler when the burner cannot be inserted through throat sheet.

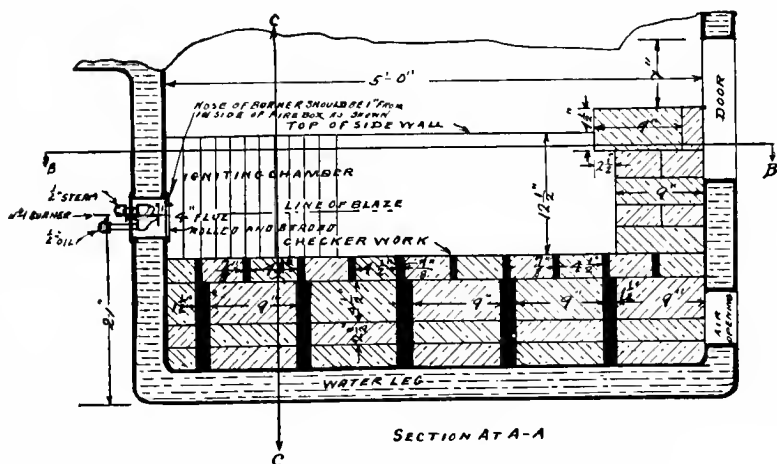
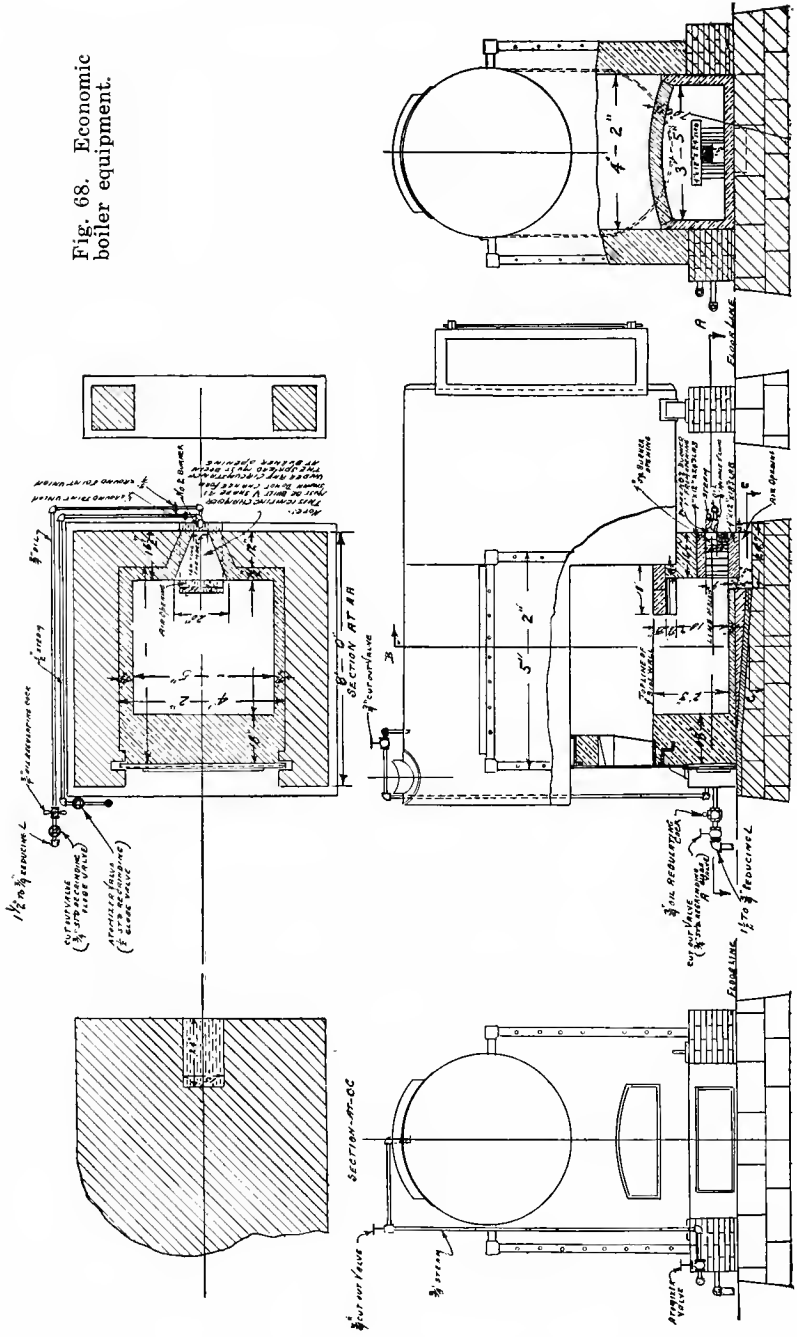

Fig. 67. Water-leg boiler equipment.

Fig. 68. Economic boiler equipment.



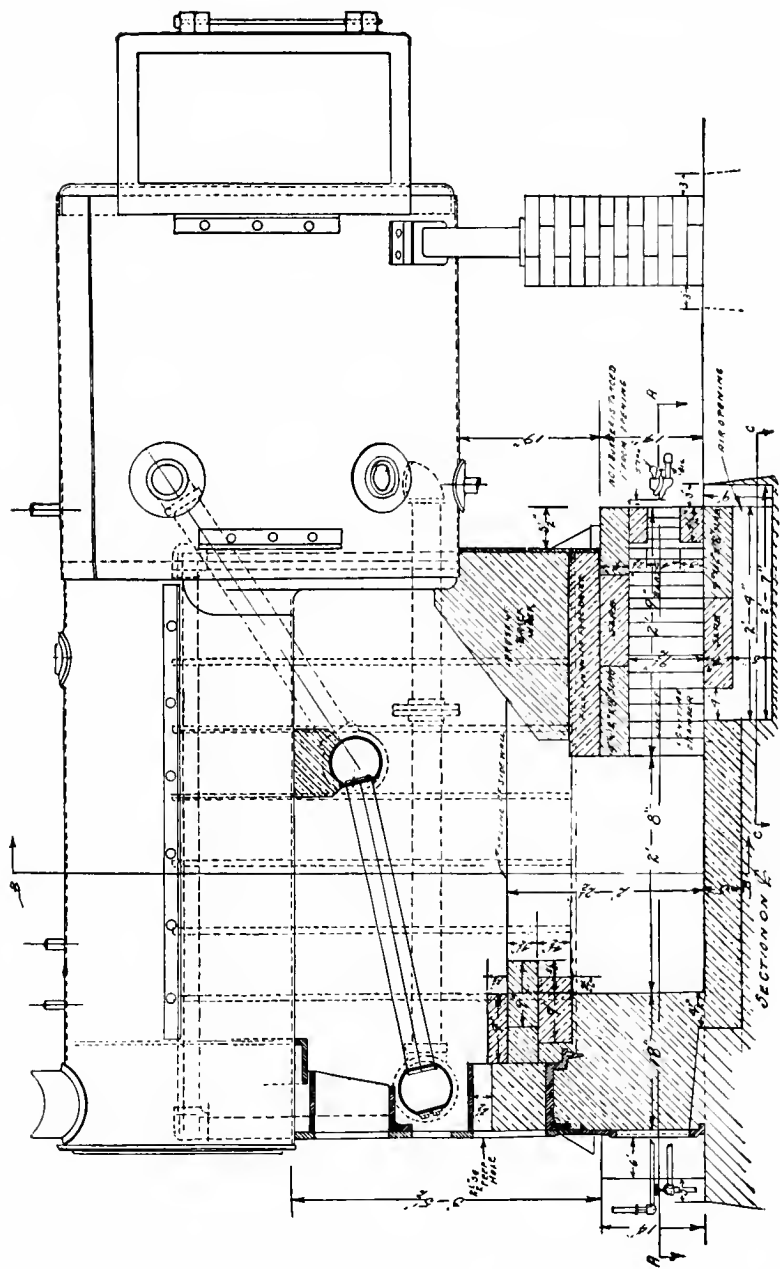

Fig. 69. Equipment of a back-fired boiler.

In a Stirling boiler (Fig. 77) the grates should be lowered and the burner placed between the two ash-pit doors. Unless the width of the fire-box exceeds 7½ feet only one burner giving a fan-shaped flame is required. Never remove the arch or arches over the grates, for these are necessary to deflect the heat to and through the elements of the boiler.

There are two methods of equipping a Heine boiler. One is known as the Deep Setting and the other the Grate Setting. The latter is simply placing a burner through the firing door as shown

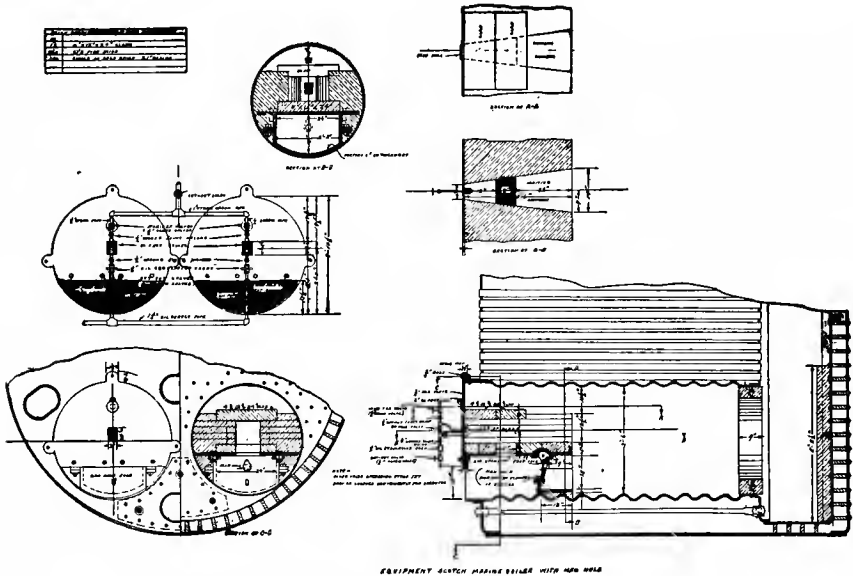

Fig. 70. Scotch marine boiler equipment.

in Fig. 78, and covering the grates with a checker-work of fire-brick, leaving a space of 3/8 inch between the bricks, so that the air required for combustion can readily pass up there through. Care must be taken to have the proper distance between the flame and the refractory material covering the grates. I have experimented a great deal in order to ascertain this distance, and have found that with a burner giving a fan-shaped flame there should be 8 inches between the nose of the burner or the Line of Blaze from the burner and the top of the fire-brick checker-work. In the "Deep

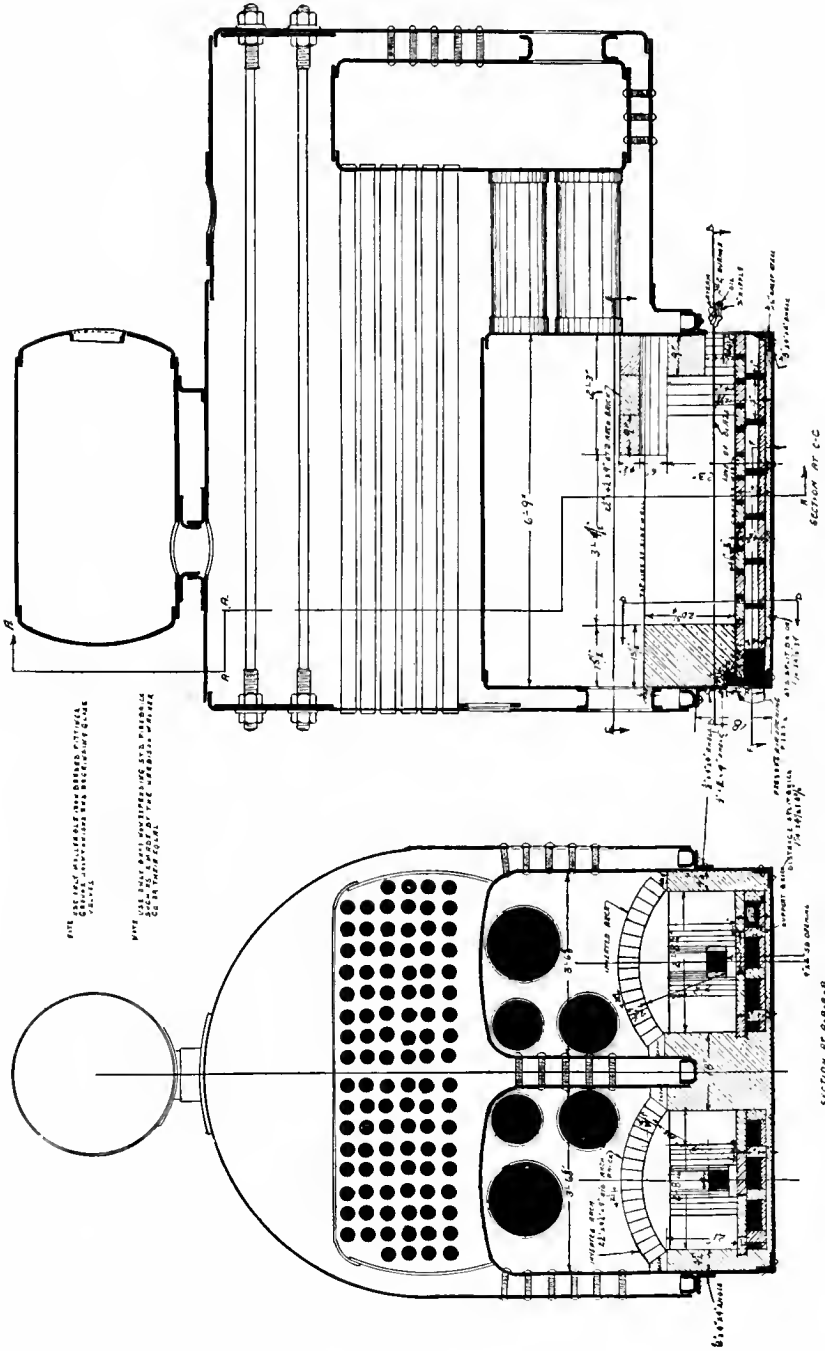

Fig. 71. Equipment of marine boilers, such as are often used on ferry boats, tug boats, etc.

Setting" (Fig. 79) the grates are removed and rows of support brick laid in the ash-pit. On these the checker-work is placed, leaving $\frac{3}{8}$ inch space between bricks if the stack is high or a greater distance if there is only a short stack. The "Deep Setting"

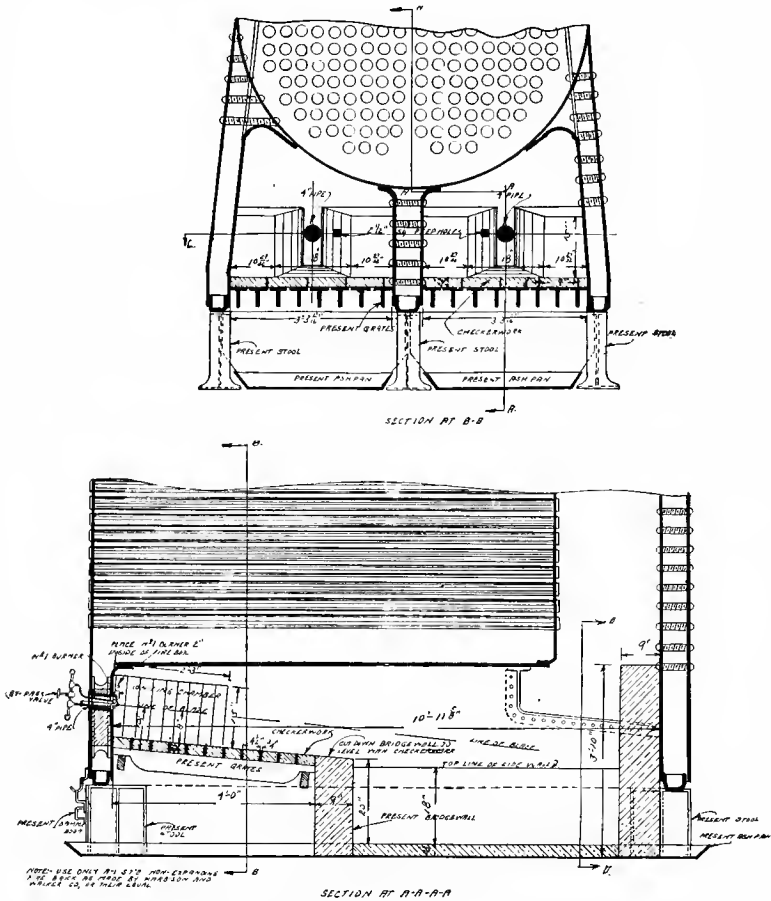

Fig. 72. Equipment of boiler with twin fire-boxes—grates not removed, oil being only used as an emergency fuel.

is always preferable because by removing the grates you increase the size of the fire-box, thus correspondingly increasing the efficiency of the boiler. With the "Deep Setting" you get practically $1\frac{1}{2}$ pounds greater evaporation per pound of fuel than with

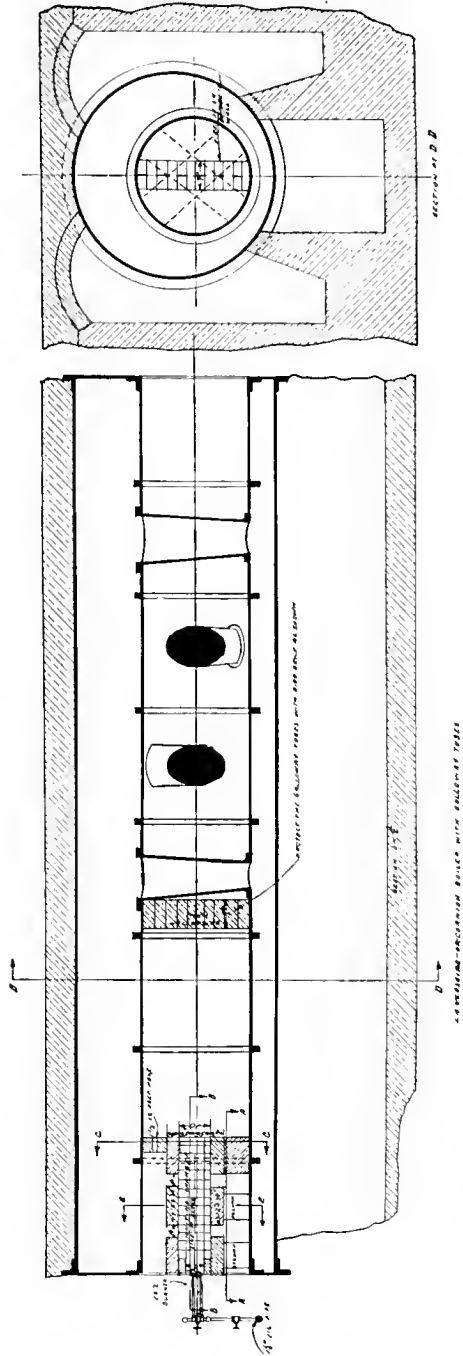
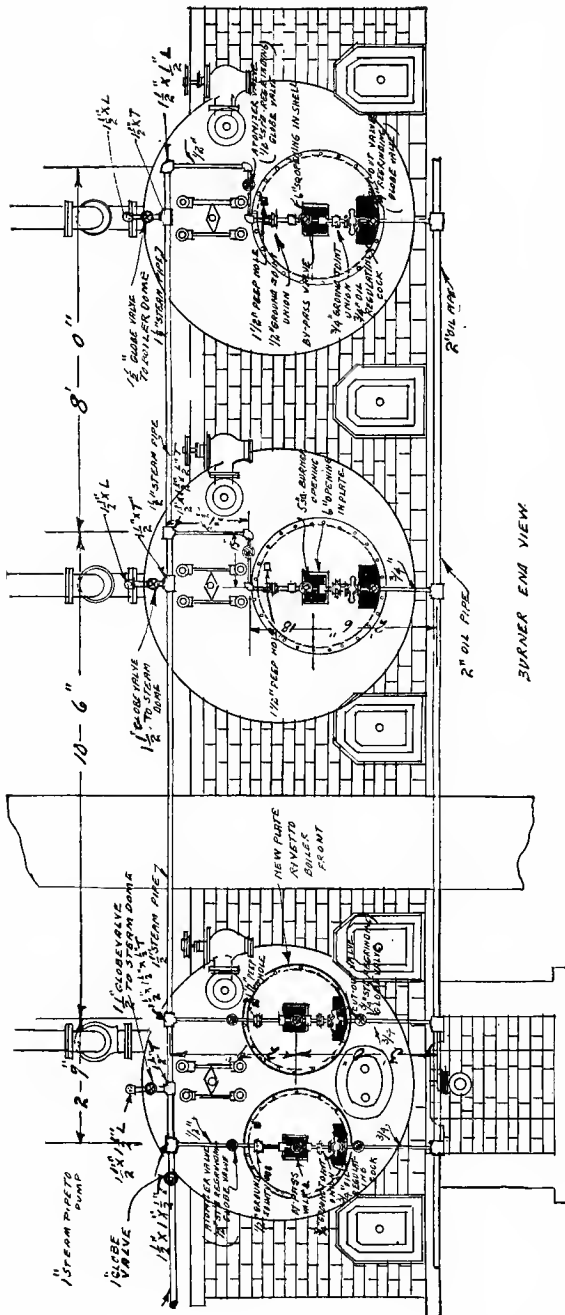

Fig. 73. Lancashire type of boiler, with Galloway tubes. The first tube must be protected with fire-brick in the manner shown.

BURNING LIQUID FUEL



LANCASHIRE BOILER

Fig. 74. Lancashire boiler equipment. One boiler is of double furnace type, while the other two have only single furnaces.

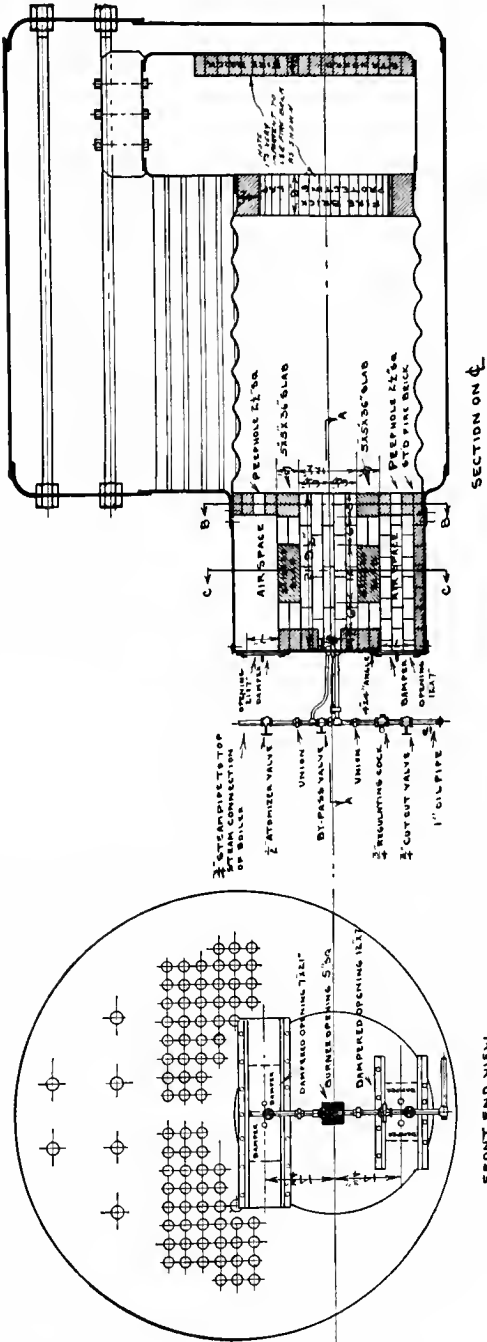

Fig. 75. Wet-back marine type, stationary boiler, with extension front end.

BURNING LIQUID FUEL

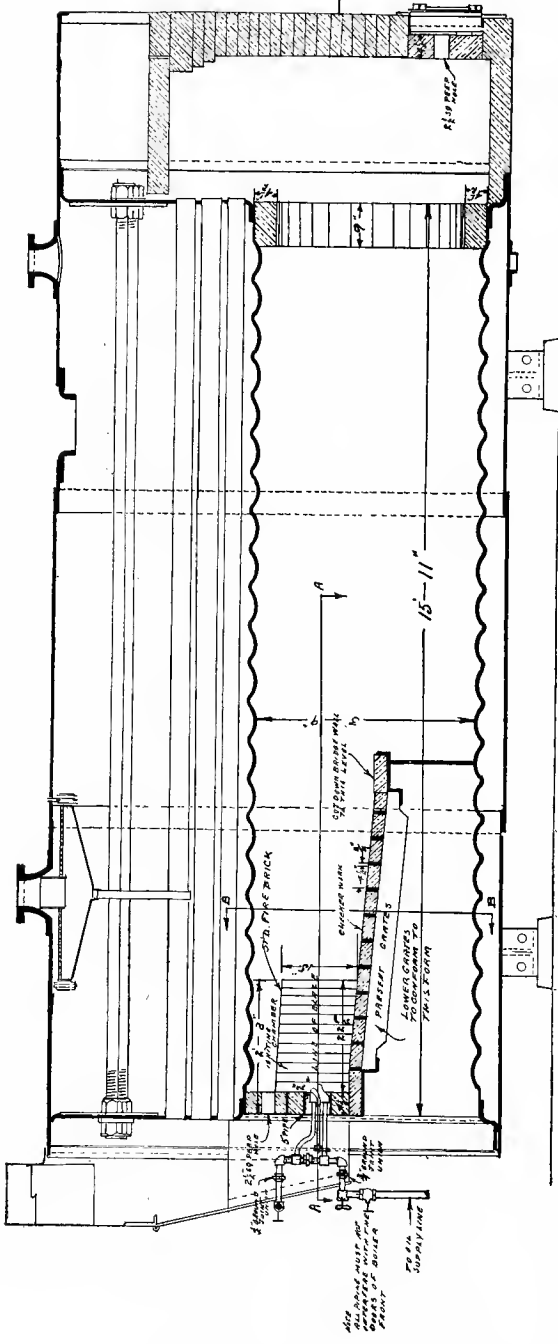

Fig. 76. Dry-back Scotch marine boiler, single furnace type, gratings not removed. The lap seam at furnace end must be protected with fire-brick as shown.

the "Grate Setting," and there is no liability of the elements being injured, even when forcing boiler far beyond its normal rated horse power. With either the Grate or Deep Setting the bridge wall is cut down level with the top of the checker-work so that the heat may be even throughout the entire length of the fire-box.

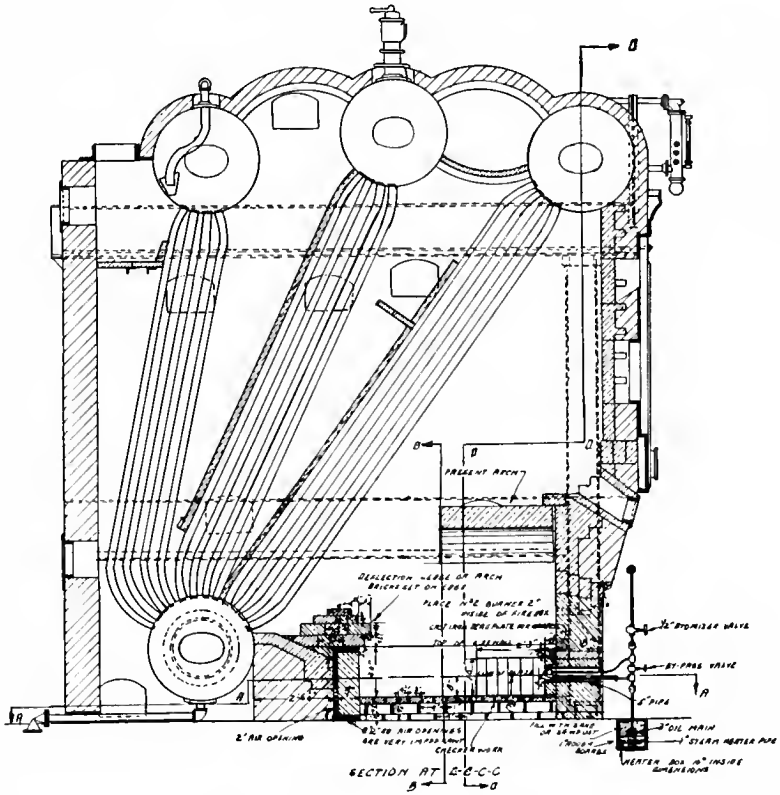

Fig. 77. Stirling boiler equipment.

In our early attempts to equip a Babcock & Wilcox boiler we covered the grates with a checker-work of fire-brick, placing the burner in the front end setting and directing the heat rearwardly. Our chief difficulties were the inadequate size of the chamber in which combustion took place, a concentration of the heat at the

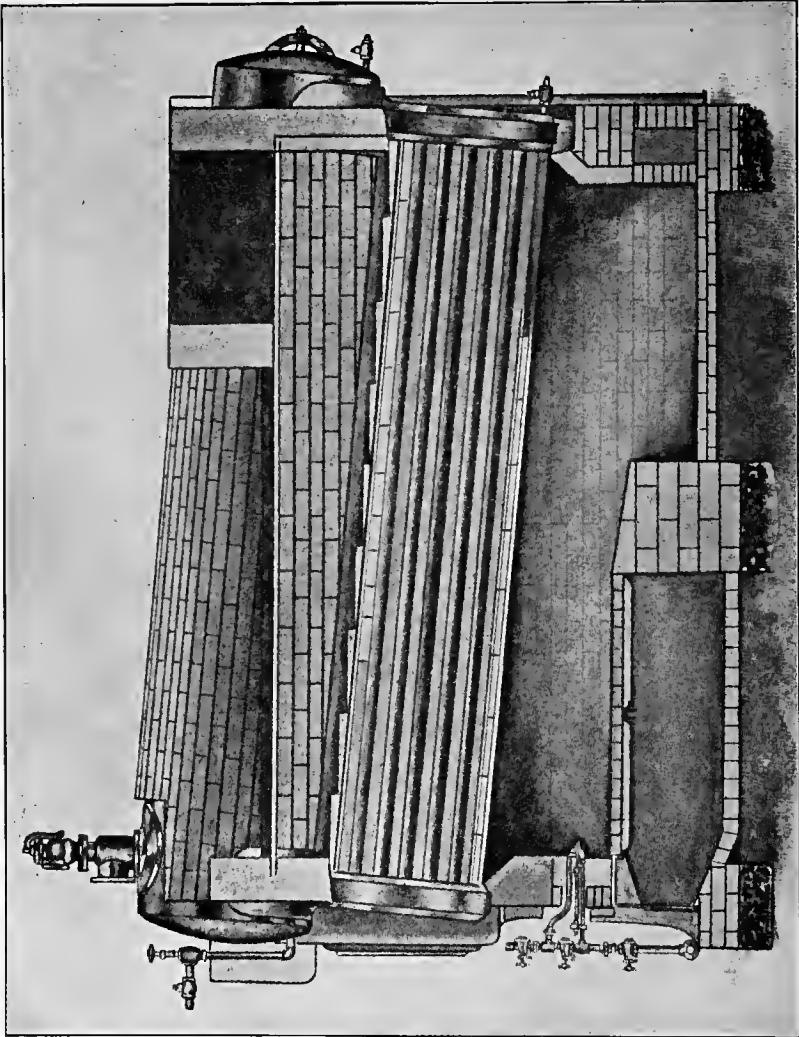

Fig. 78. Heine boiler equipment—grate setting.

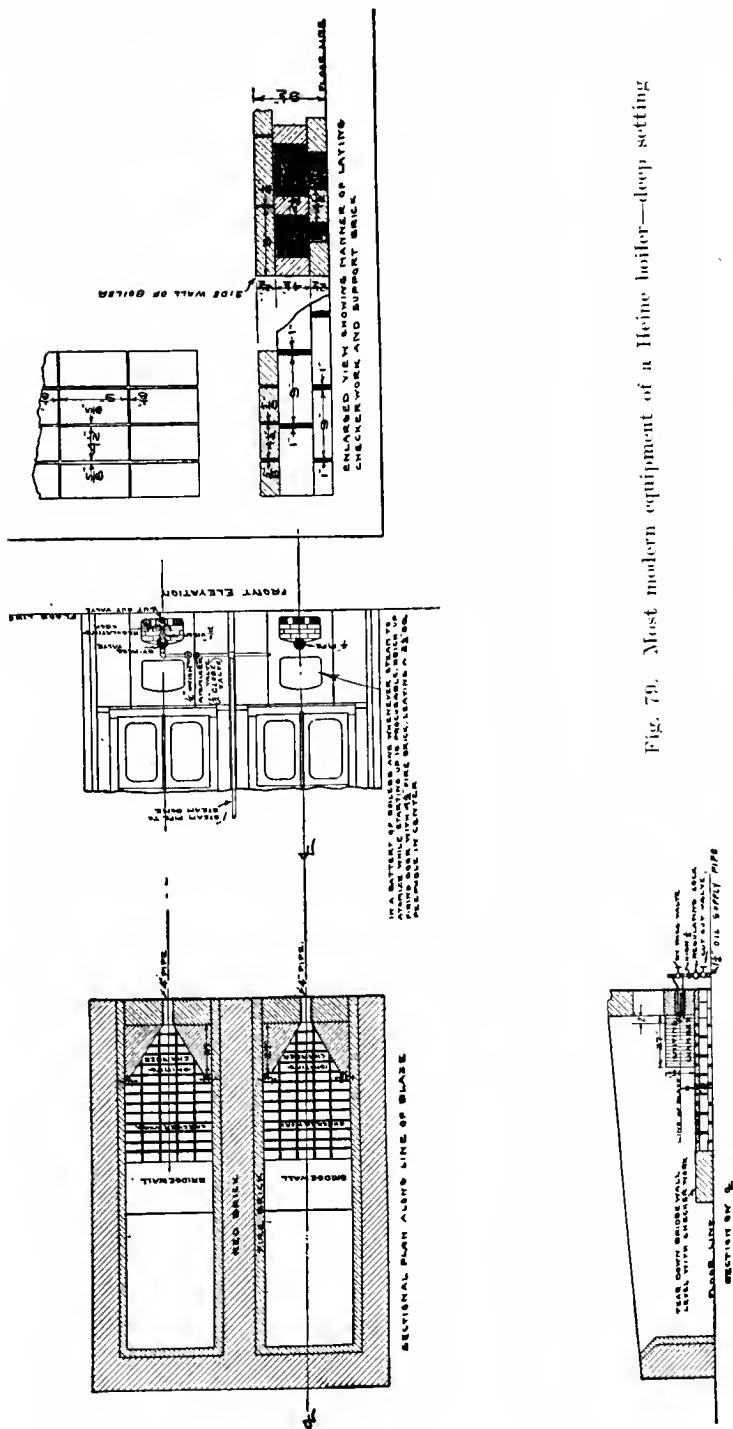

Fig. 79. Most modern equipment of a Heine boiler—deep setting

rearward end of the first pass and an insufficient amount of heat at the header-end of the boiler. Finally we removed the grates, placing the fire-brick checker-work on rows of support brick laid in ash-pit, and constructed a deflection arch or ledge to deflect the heat forward, as shown in Fig. 80. Further experiment-

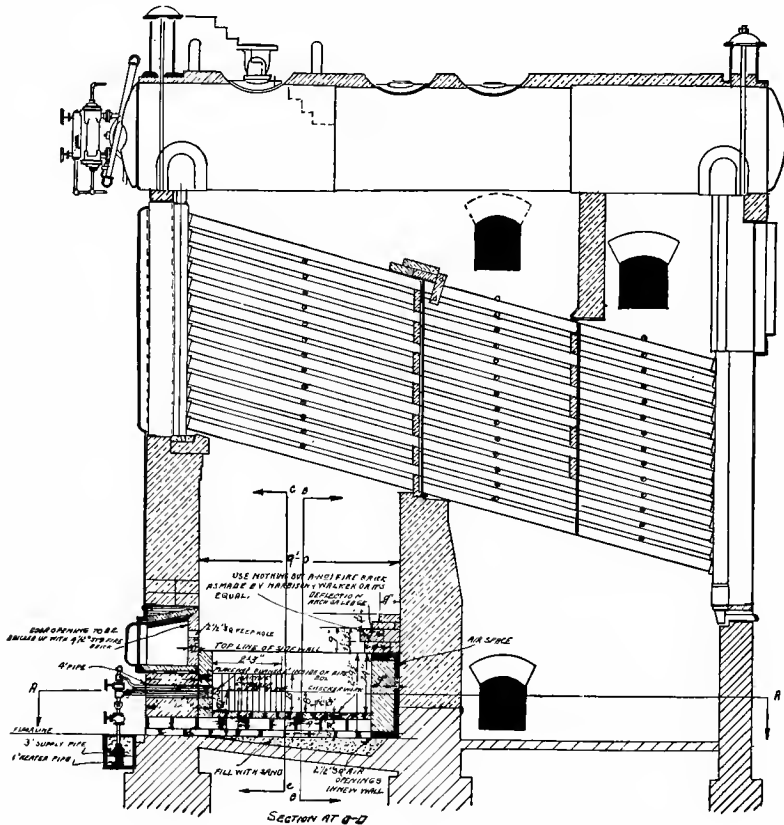

Fig. 80. Babcock & Wilcox boiler equipment.

ing revealed the fact that the very best results are obtained by having a distance of 3 feet between the base line of the setting and the floor line, and constructing the deflection cross wall as shown in Fig. 81. It may seem costly to make the setting so low but this

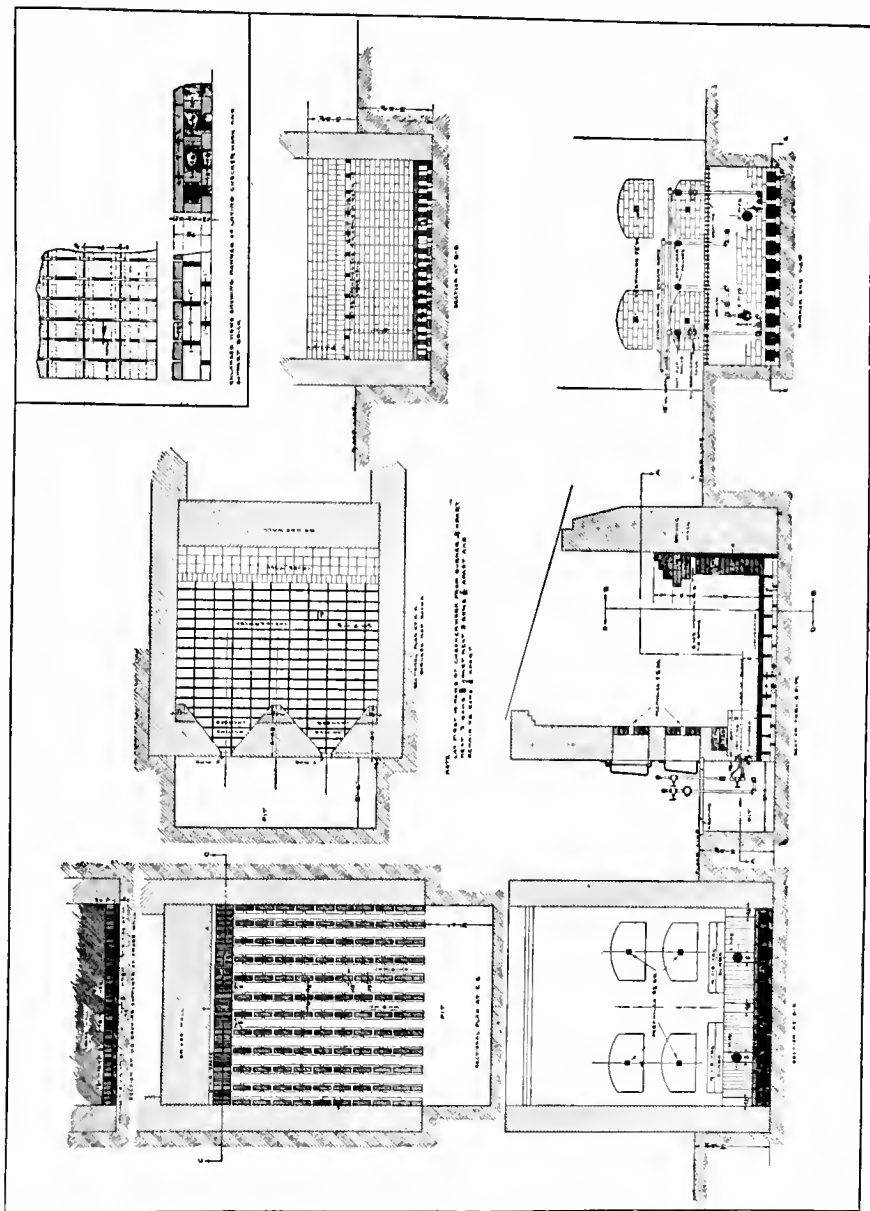

Fig. 81. Most modern and efficient manner of equipping a Babcock & Wilcox or an Altman-Taylor Boiler.

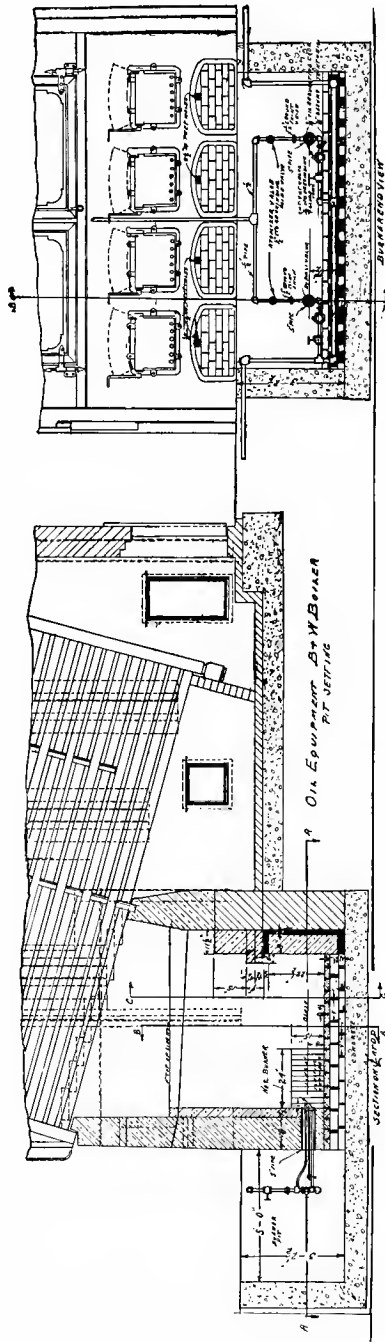

Fig. 82. Modern method of equipping a large Babcock & Wilcox boiler.

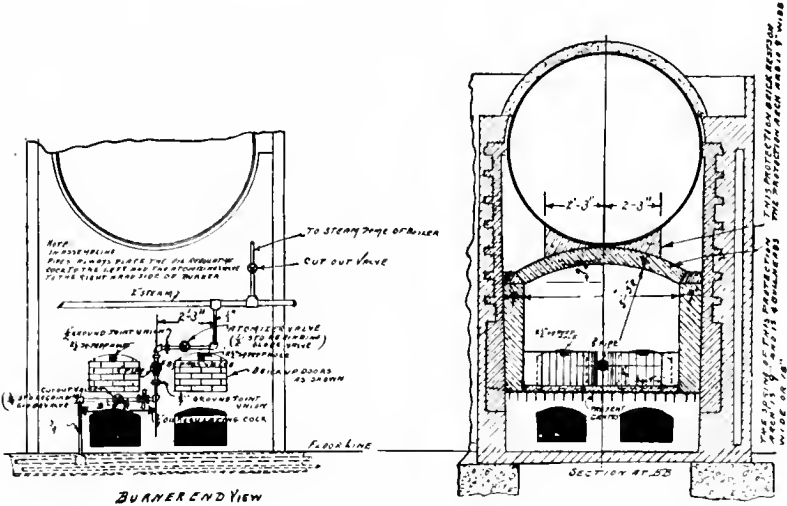
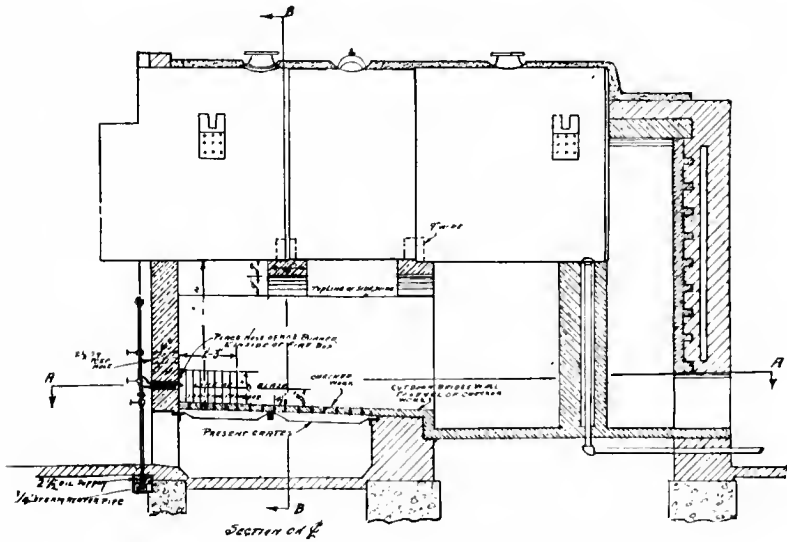

Fig. 83. Return tubular boiler equipment—grate setting.

cost is soon offset by the economy in fuel and efficiency effected because of your getting the benefit of an even distribution of heat throughout the first pass of the boiler.

A return tubular boiler may be equipped by simply placing checker-work on the grates and cutting the bridge wall down level therewith, as shown in Fig. 83, but personally I recommend the "Deep Setting," similar to that described under Heine boiler, see Fig. 79.

Admirable results are obtained from Vertical Boilers by placing the burner so that the flame enters the fire-box tangentially, for

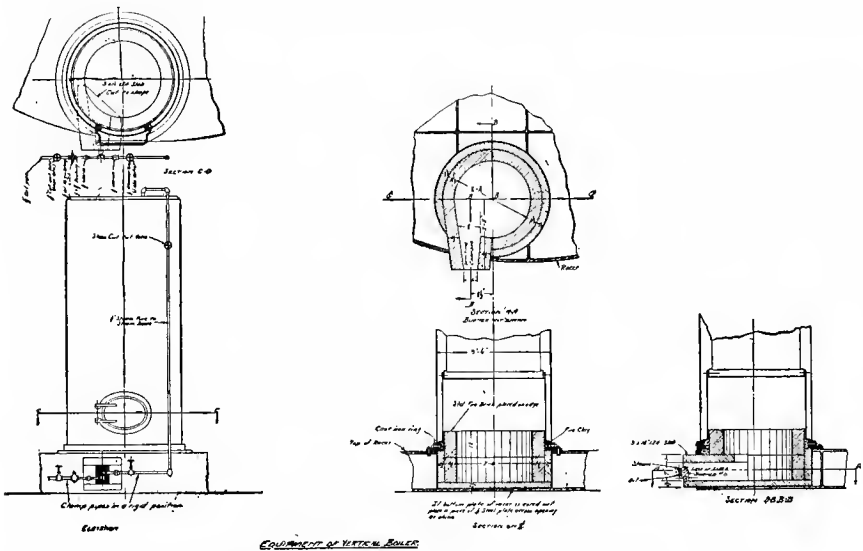

Fig. 84. Tangential flame equipment as applied to a vertical boiler.

this causes a reverberatory movement of the flame and heat and prevents impingement upon any of the elements of the boiler. To start the boiler shown in Fig. 84, when cold in a pumping station or when used as an auxiliary boiler, we simply break up a few boxes and pass them in through the fire-door and in a few moments ten or twelve pounds of steam is raised on this small boiler, which is sufficient to operate the oil burner on this boiler, and this boiler in turn furnishes steam to operate the burners of a large battery of boilers.

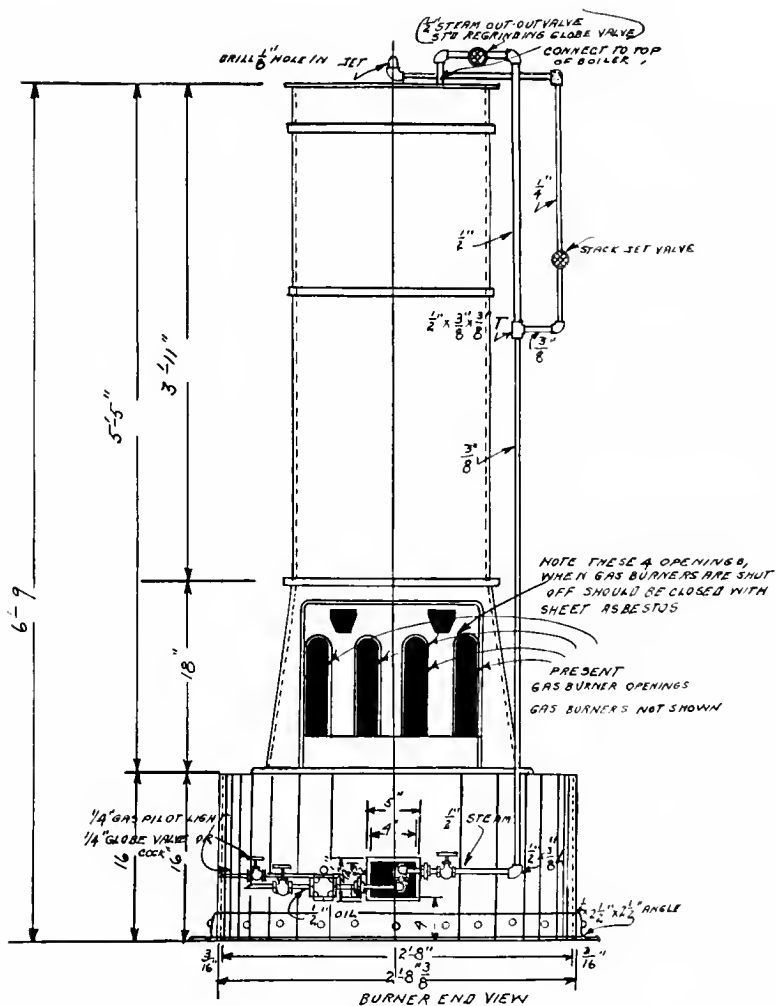

Fig. 85. Vertical boiler in which both gas and oil can be used as fuel.

Sometimes it is quite essential to have a small boiler in which either natural or commercial gas can be used in combination with oil or in which either fuel may be used without the other. For this purpose a small vertical boiler is becoming quite popular. This outfit (Fig. 85) is often used chiefly to supply steam in a small

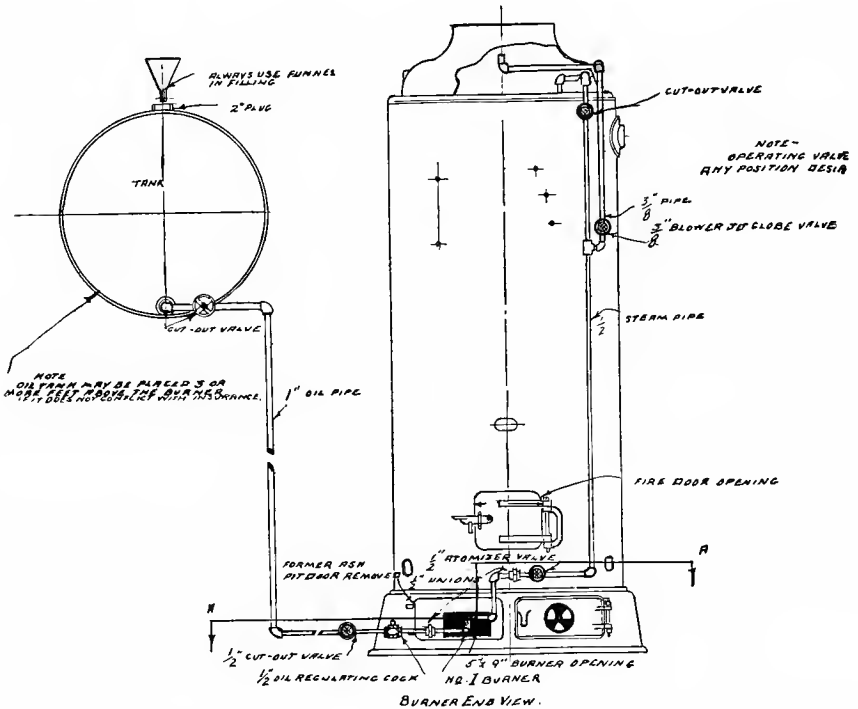

Fig. 86. Vertical boiler with gravity oil feed.

power plant with which to begin the operation of the oil burners in the larger boilers after they have been washed out or are cold from being shut down over a week-end or holiday. It only takes a few minutes to raise the necessary steam in this type of boiler.

Many vertical boilers can be equipped with a burner giving a fan-shaped flame but it is very much better to have the burner give a

narrow flame. With the tangential flame equipment shown in Figs. 86, 87 and 88, you get an absolutely even distribution of heat in the fire-box, this heat encircling the fire-box and passing upwardly through the elements of the boiler without impinging at any point. The grates should be removed and the ashpit lined sufficiently high to protect the mud ring. When the boiler is cold, five pounds steam

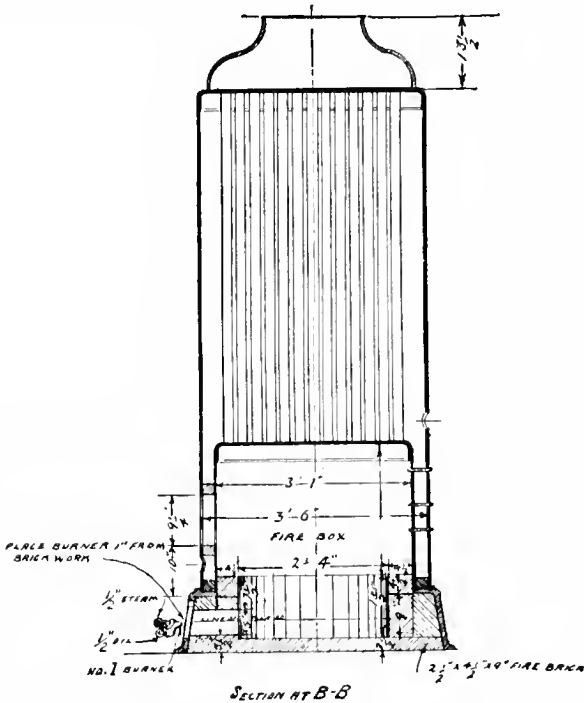

Fig. 87. Vertical boiler—longitudinal mid-section.

pressure with which to begin operating the oil burner, can readily be raised with a wood fire. The kindlings or wood can be put in through the firing door. The ashes from the burnt wood will very quickly pass away after the oil burner is started. In some equipments it is well to place a pilot burner to be used the same as in

BURNING LIQUID FUEL

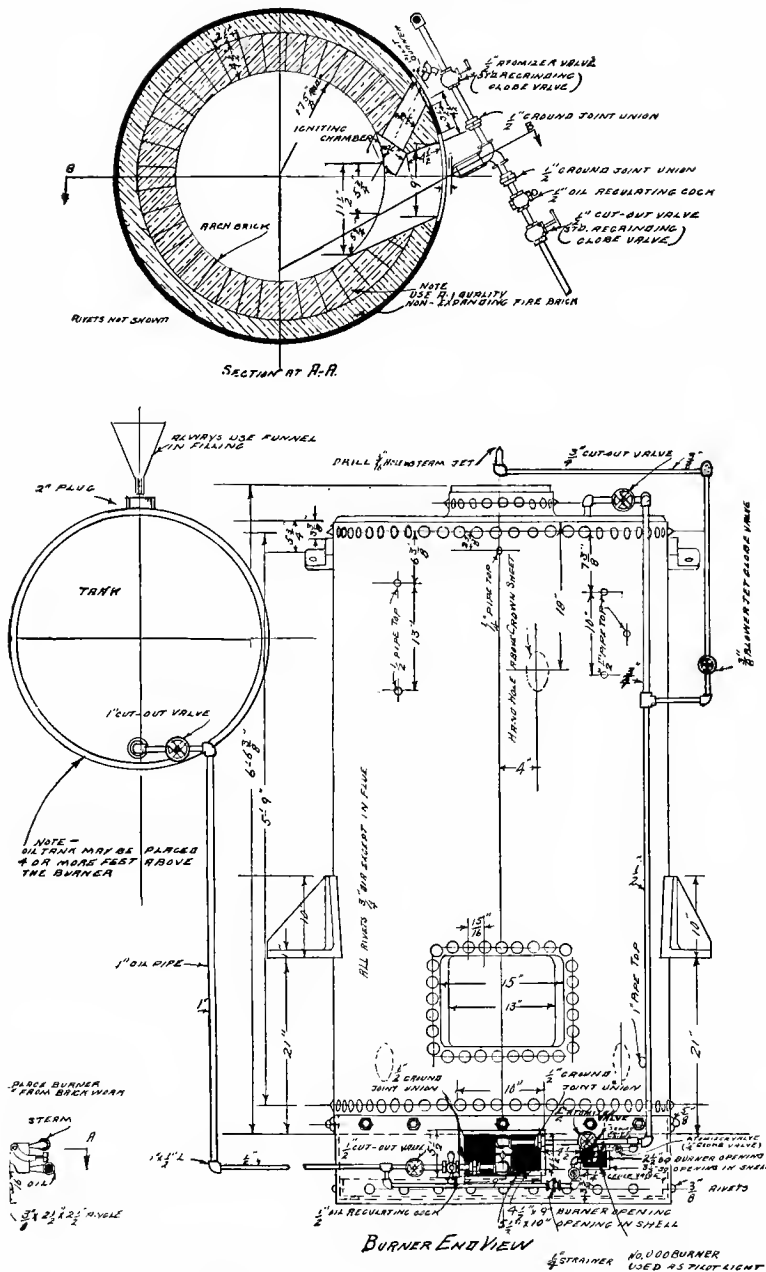

Fig. 88. Vertical boiler equipment.

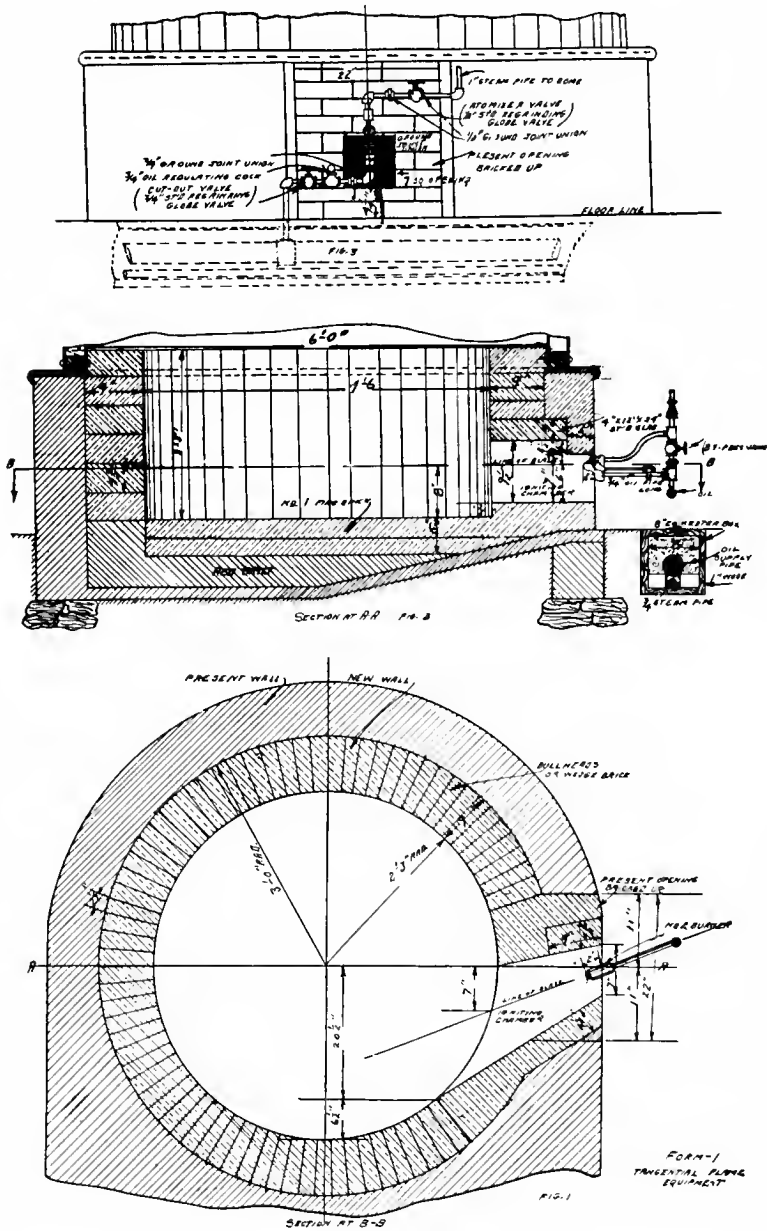

Fig. 89. Manning vertical boiler.

locomotive service to maintain the required steam pressure while the boiler is idle. Fig. 87 shows a portion of a portable outfit where a pilot burner is used on the boiler; also gravity oil feed.

In equipping a Fitzgibbons type of boiler, it is very important to place the burner so that the flame will not impinge against the crown sheet of the boiler. The equipment is very simple if the burner is placed on the side opposite the firing door as indicated in Fig. 90.

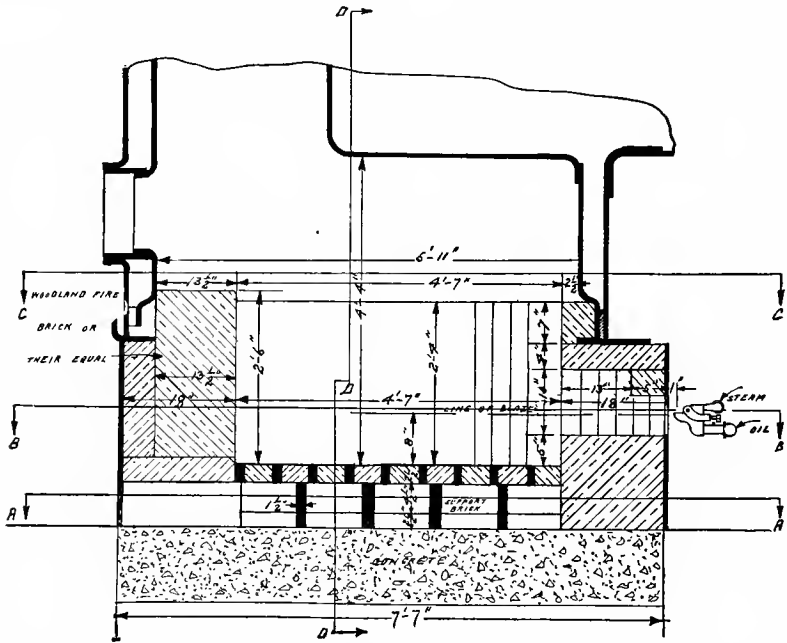

Fig. 90. Fitzgibbons boiler equipment.

The liquid fuel injectin apparatus (see Fig. 91) can be used either in combination with poor coal or with oil alone. If it is desired to use oil alone, the grates are covered with ashes and the burner is operated by opening the air damper and starting the burner, same as in furnace practice. When the strike or coal shortage is over the ashes can readily be removed from the grates, the burner shut off, the air damper closed by the lever shown in the

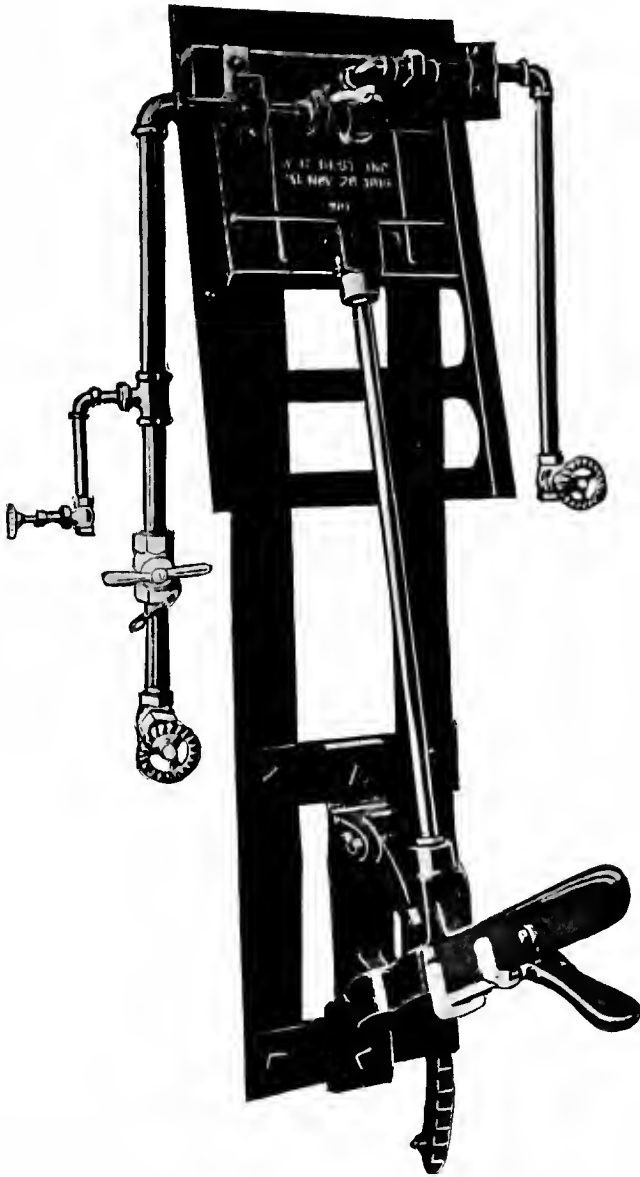

Fig. 91. Liquid fuel injecting apparatus.

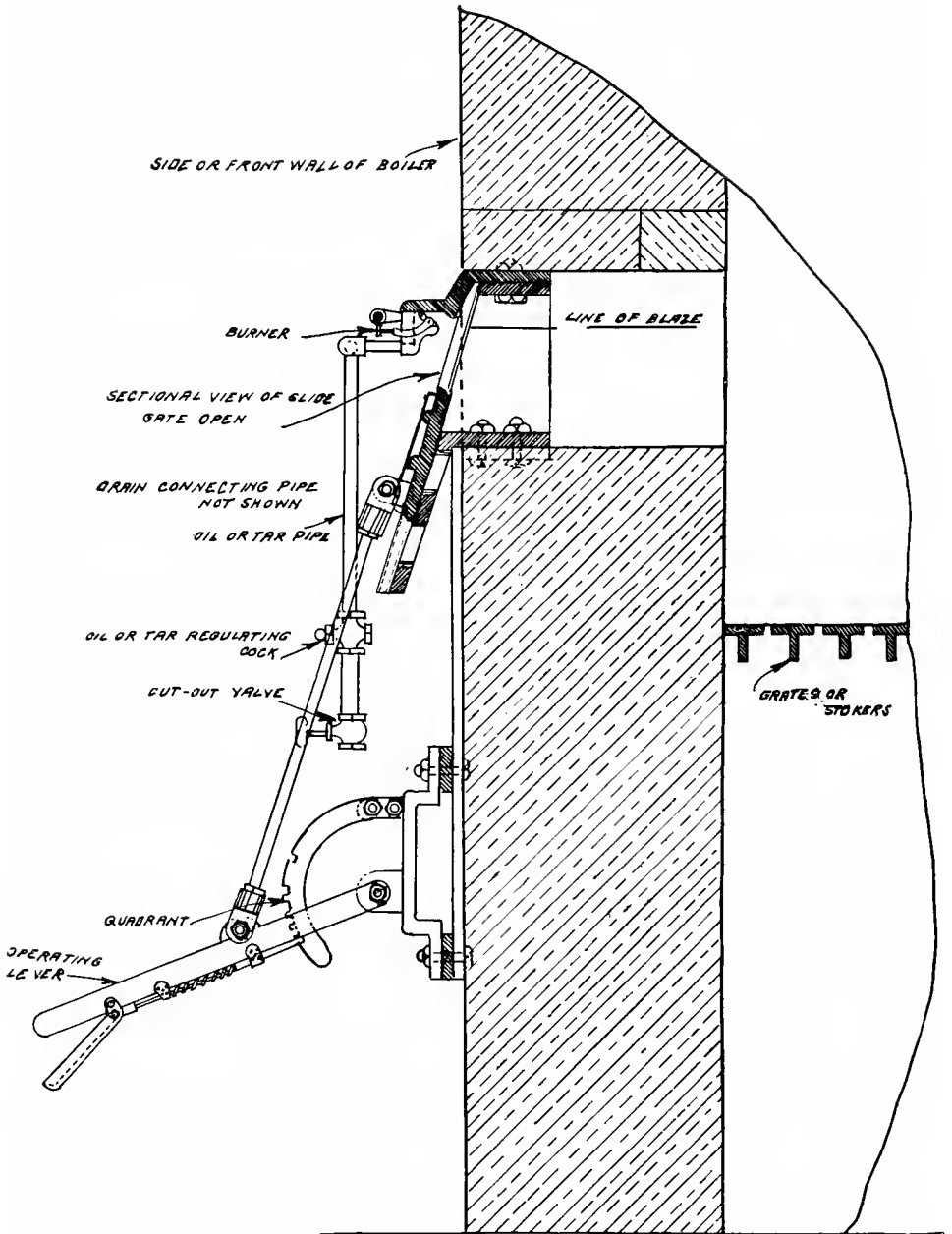

Fig. 92. Liquid fuel injecting apparatus in position for operation.

Fig. 92, and coal again burned. It should be remembered that in good boiler practice it requires 147 gallons of oil to represent a long ton of coal. Therefore unless the boiler is located in an oil-producing section, where oil can be purchased much cheaper than coal, it is not advisable to use oil in boilers except during a period

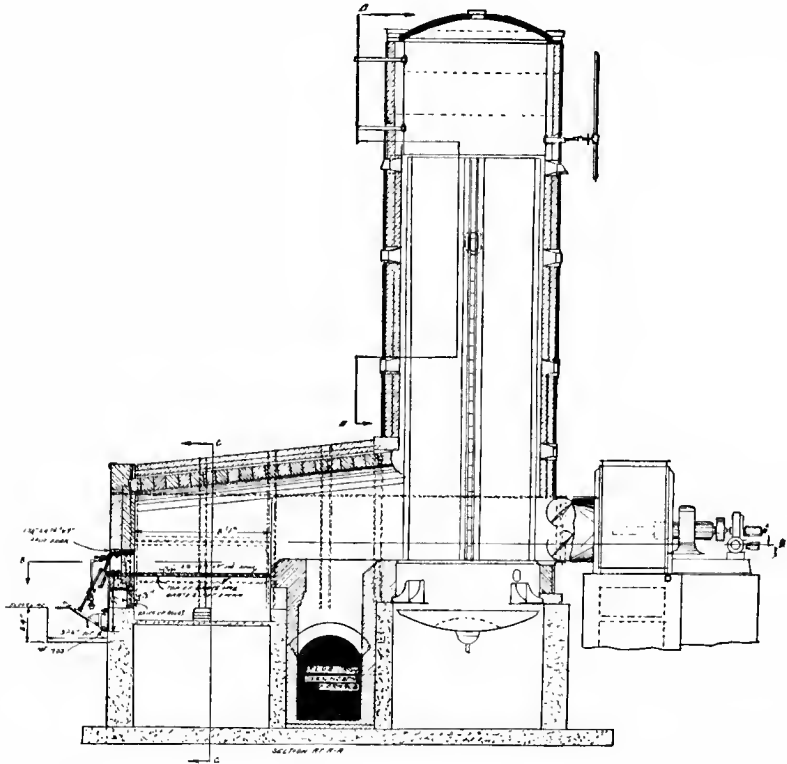
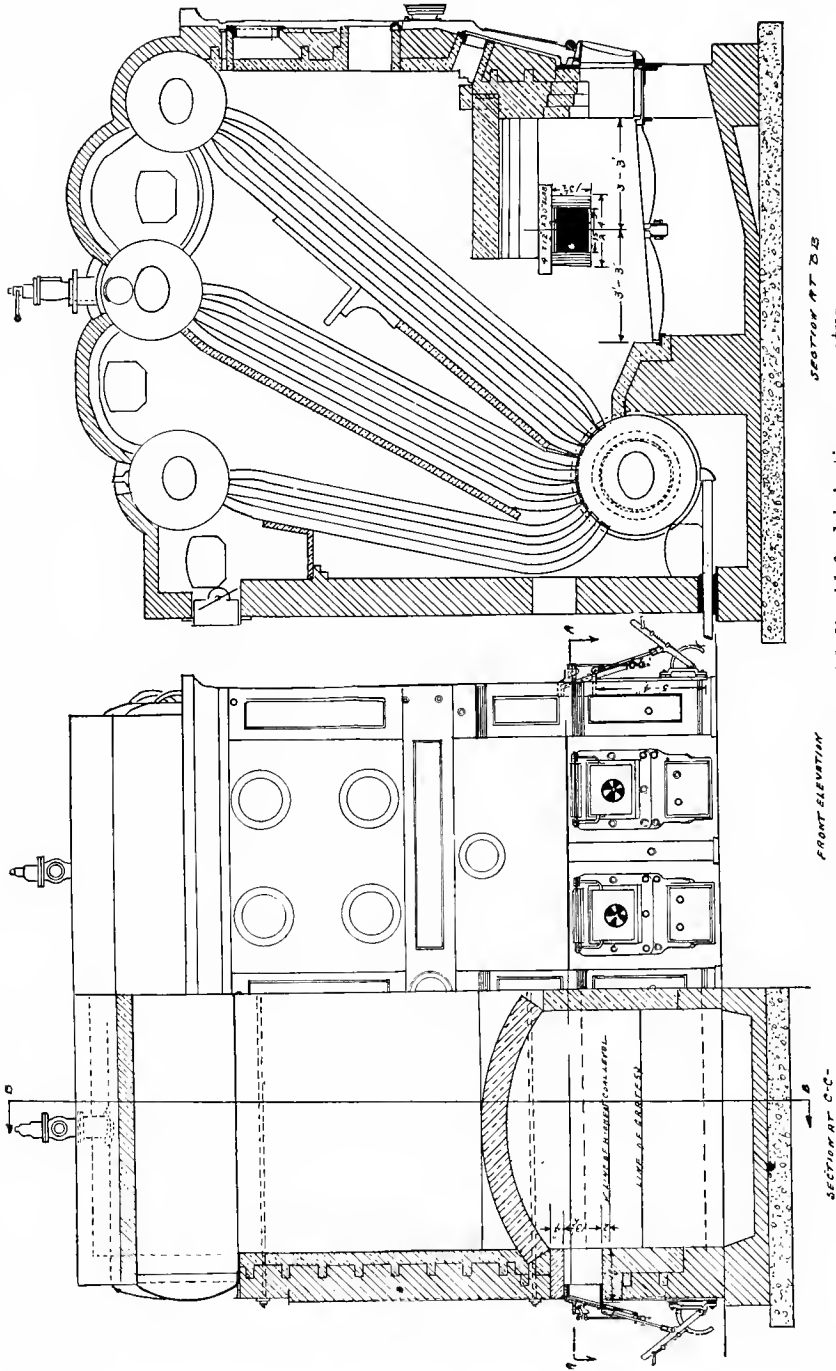

Fig. 93. Liquid fuel injecting apparatus installed on open hearth furnace waste heat boiler.

of coal shortage. You will note that this apparatus is placed in the side-wall of the boiler, midway between the front end setting and the bridge wall, and it does not in any way conflict with the operation of the stokers, or hand firing of the boiler. The waste heat coming from an open-hearth furnace is not always sufficient

BURNING LIQUID FUEL



SECTION AT B-B

FRONT ELEVATION

SECTION AT C-C

Fig. 94. Stirling boiler equipped with liquid fuel injecting apparatus.

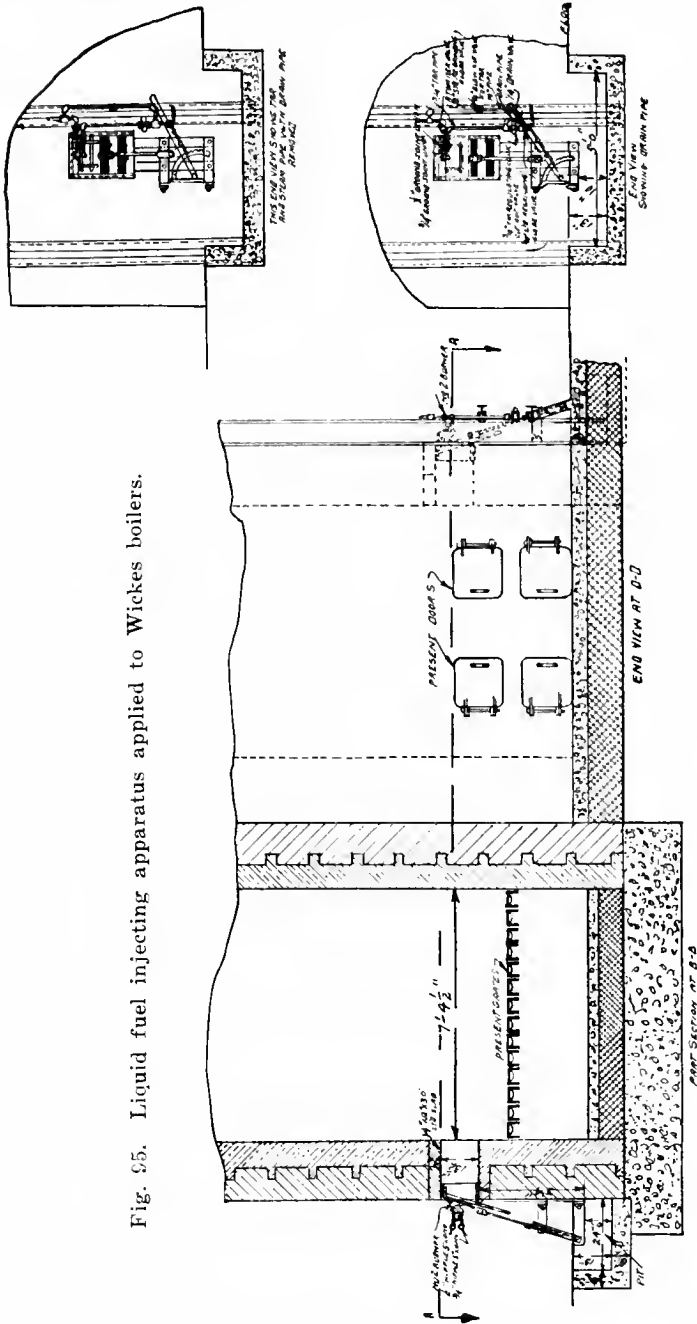

Fig. 95. Liquid fuel injecting apparatus applied to Wickes boilers.

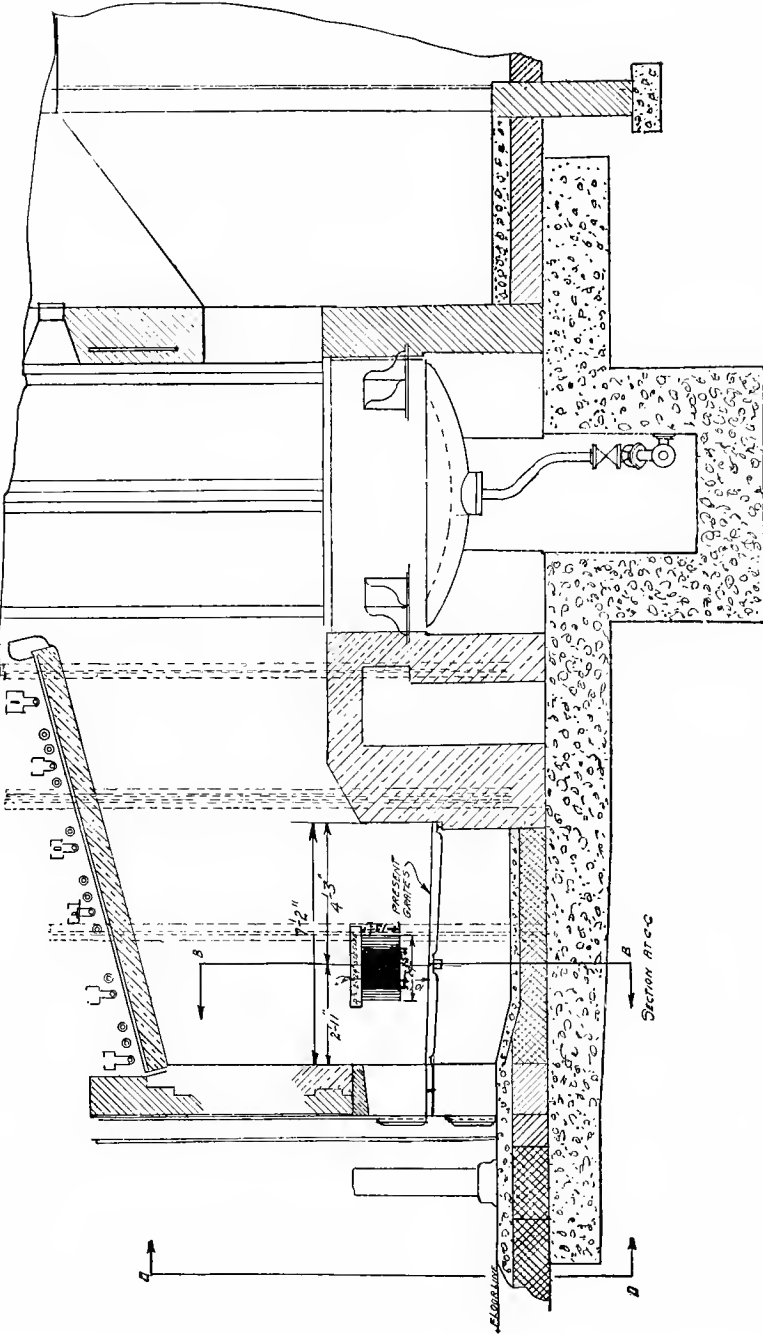

Fig. 96. View showing location of opening for liquid fuel injecting apparatus in side of fire-box.

to keep up the required steam pressure on a waste heat boiler at all times. All difficulty arising from this condition is obviated from installing the liquid fuel injecting apparatus as shown in Fig. 92.

The burner is capable of atomizing any gravity of liquid fuel purchasable in open market, and is made of material that has no affinity whatsoever for the oil or tar.

I am often amused at the specifications sent forth. Often they read as follows:

"The burner to be of cast-iron, honestly made, and provided with all necessary fittings of the same material."

One firm spent twelve years trying to find a material that has no affinity for oil and they have secured it. Years ago, they tried cast-iron, and then steel, but those metals were not satisfactory because they wanted to obviate the clogging of the oil orifice by the residuum of the oil. It must be amusing to this firm to get specifications for burners indicating the very metal which they years ago discarded!

I recommend that any firm desiring to conduct a test purchase from the Secretary of The American Society of Mechanical Engineers (29 West 39th Street, New York City) blanks showing standards adopted by that Society for use in boiler evaporation tests. Either the gravity feed or oil pumping system shown in Figs. 97 and 98 may be used to supply the fuel. Scales should be used for weighing the fuel in the upper tank. If the gravity feed test system is used, the bottom of the lower tank should be at least two feet above the level of the burner. .

Steam flow meters provide a means for accurately measuring the total flow of steam through pipes or closed conduits, and so furnishing information of great value in the economical management of any manufacturing industry or central station. (See Fig. 100.)

The most universal differential draft gage devised, for air supply control, is this new type of combination (the simplest and most valuable instrument introduced) gage. Based on true efficiency, first cost, attention and maintenance, it surpasses all other combustion instruments. It is the biggest value ever offered for the boiler room.

By a simple and ingenious system of cross-piping the cover type differential gage, a type has been developed whereby the furnace draft, the flue draft or the differential between the flue and furnace can be indicated on a single gage over the full length of the scale.

BURNING LIQUID FUEL

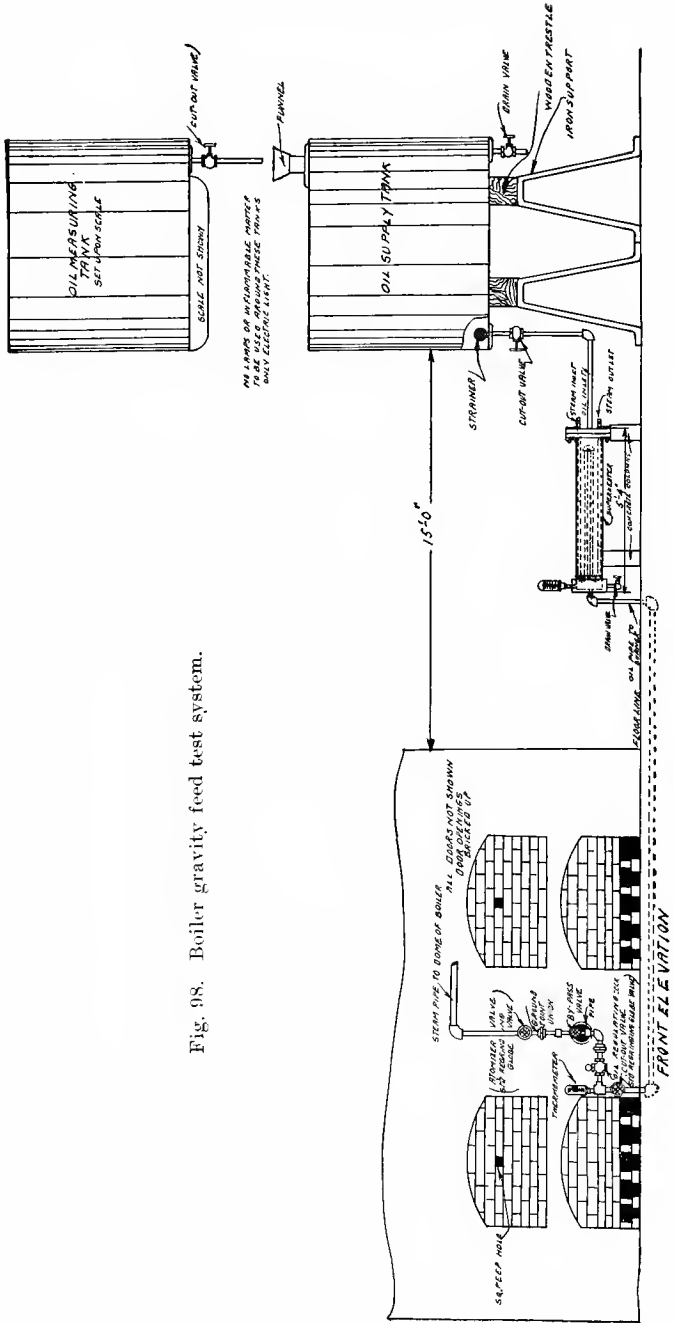

Fig. 98. Boiler gravity feed test system.

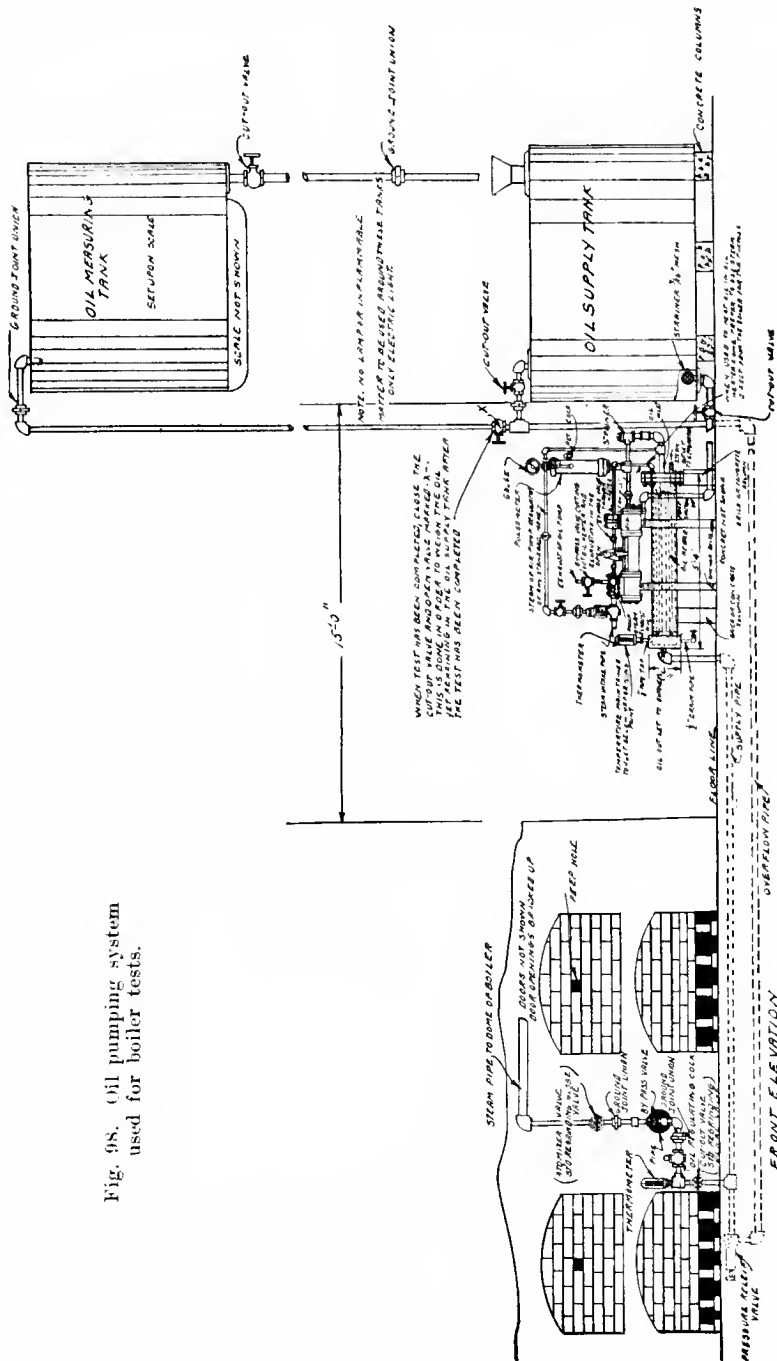

Fig. 98. Oil pumping system used for boiler tests.

As the differential gives a greater liquid movement for a given variation in air supply than the furnace draft, the gage is operated continuously on the differential. The ordinary draft gage when connected either to the furnace or to the flue indicates only

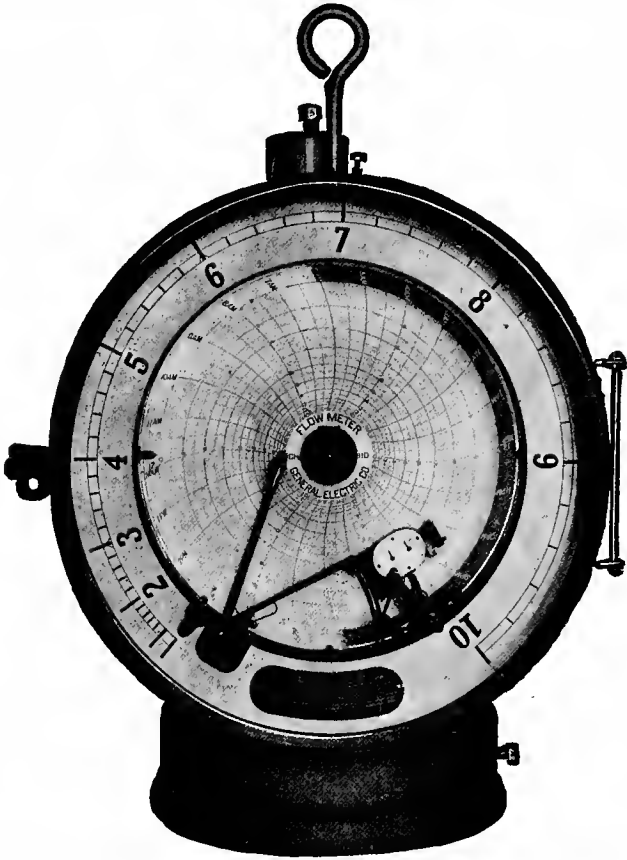

Fig. 100. Indicating, recording, integrating flow meter. (Cut used through courtesy of the General Electric Co.)

a difference in pressure between the furnace or the flue and the outside of the setting, and does not serve as a reliable guide to the actual amount of air passing through the furnace.

The air to an oil-burning furnace can be regulated in two ways:

by the ash pit doors and by the damper. With the ash pit doors wide open and the air regulated by the damper the ordinary type draft gage serves very well as an indicator of the amount of air

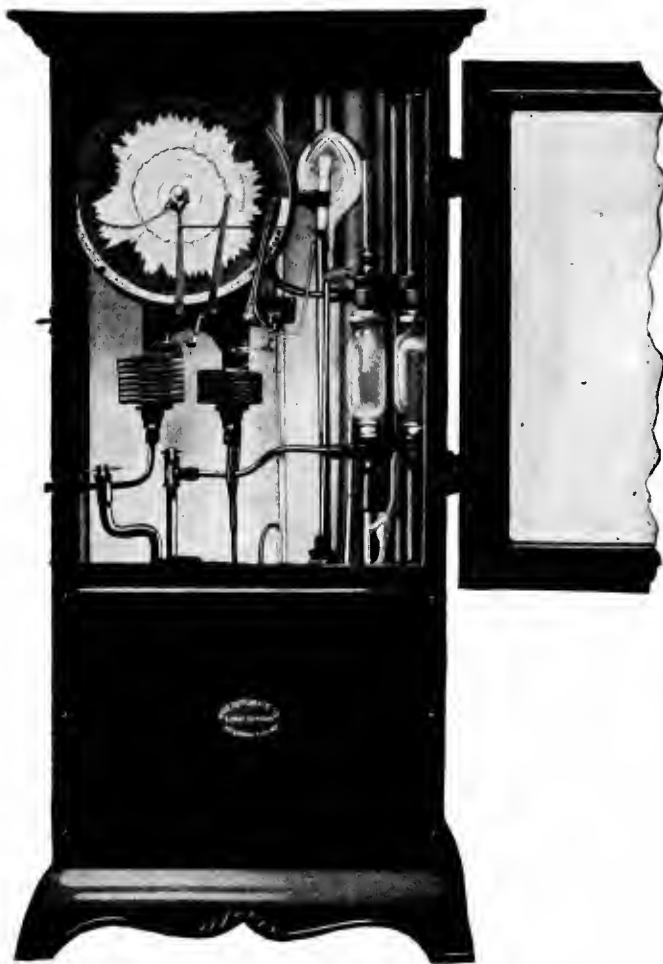

Fig. 101. CO₂ recorder. (Shown through courtesy of the Jos. W. Hays Corporation.)

passing through the setting, but should these conditions be reversed, that is, the damper space wide open and the ash pit doors partly closed, the indications of the ordinary type draft gage are

of no value whatever inasmuch as closing the ash pit doors tends to cut down the air and at the same time indicates a higher draft pressure.

With the differential draft gage an increase in air supply from any source moves the liquid in but one direction, forward, and a decrease in air supply has the opposite effect. Therefore the indications of this gage are a sure guide to the amount of air passing through the setting regardless of the position of the damper or ash pit doors.

To indicate the varying air supply the outside cocks are open and the middle cock is closed, as shown, the liquid operating between the air supply pointers as indicated.

The flue draft is indicated by opening the outside cock and closing the other two.

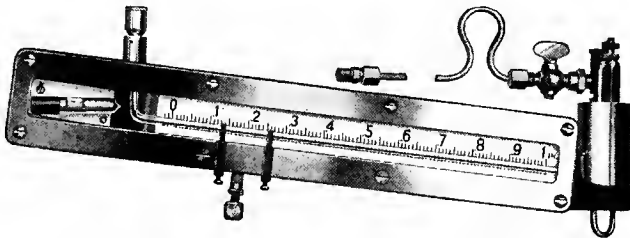

Fig. 102. Ellison draft gage. (Shown through courtesy of Lewis M. Ellison, Chicago, Ill.)

It is advisable to use a steam-flow meter of modern type and well known make; also CO₂ recorders and draft gages, and all other instruments which will aid in economically and accurately burning the fuel.

Standard adopted by the A. S. M. E. 1 boiler H. P. is equal to an evaporation per hour of 30 lbs. of water from 100°F. to 70 lbs. pressure, or is equal to 34.5 lbs. of water per hour from and at 212°F. This is not a measure of power but of evaporation.

Blast furnace gas is now being used very successfully in both large furnaces and boilers. This gas having a calorific value of only 90 B.t.u. per cubic foot must be supplied in large quantities, and necessarily a large gas burner is used to deliver the gas to the boiler or furnace. On account of its low calorific value it is also necessary to use either oil or tar as an auxiliary fuel to aid

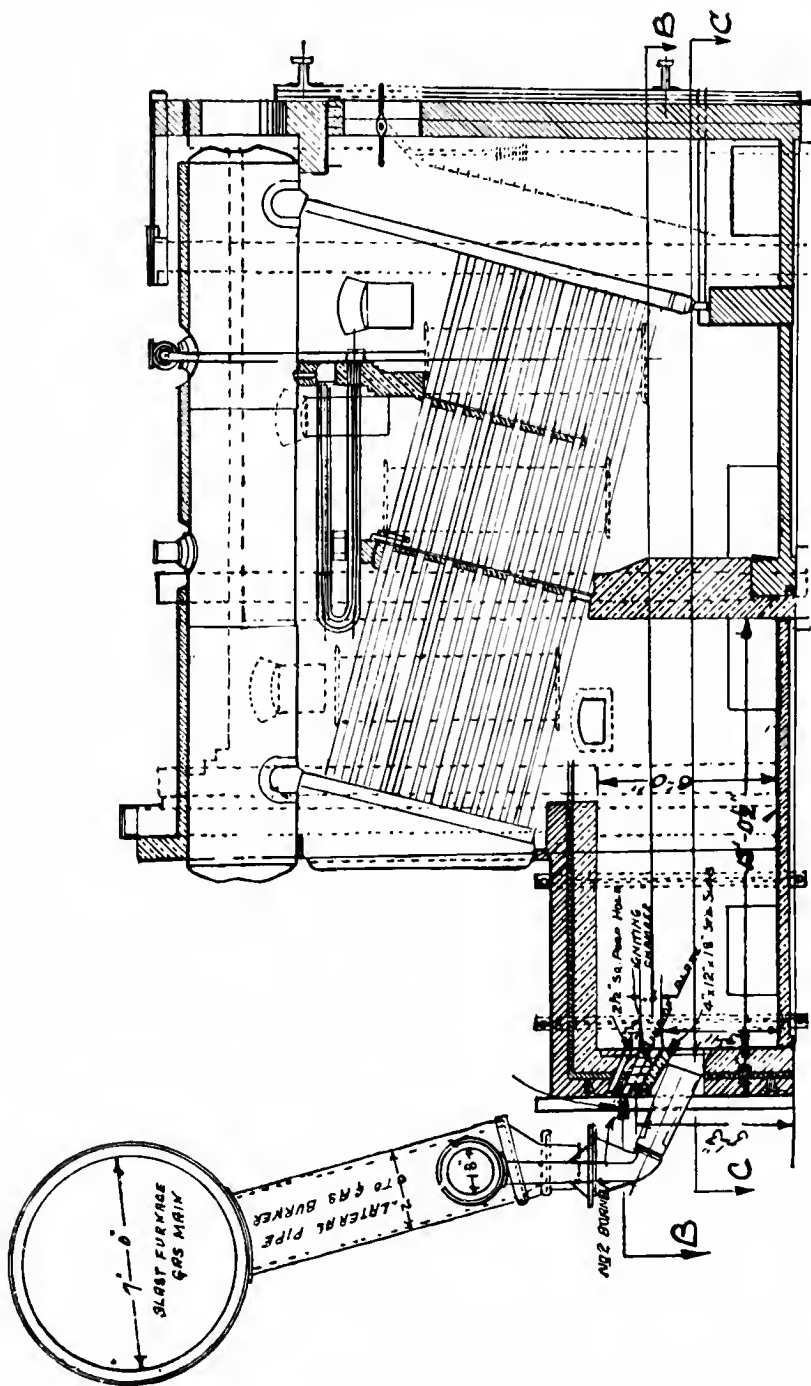

Fig. 103. Boiler equipped for the use of blast furnace gas, with an oil or tar burner above the gas burner.

in maintaining the rated horse-power of the boiler and to meet the fluctuating loads which the power plant of a works carries.

Fig. 103 shows a longitudinal mid-section of a boiler using blast furnace gas, and also the manner of installing an oil or tar burner above the gas burner by which excellent results are obtained.

Chapter VIII

LOW-PRESSURE BOILERS AND HOT AIR FURNACES

There are many different types of hot water boilers, hot air heaters and steam boilers carrying only from 2 to 10 pounds steam pressure, which are used for heating purposes. Some have cast iron elements while others have steel shells. That shown in Fig. 105 is a hot water boiler with a steel shell. You will note that there is an electric motor which drives a positive pressure blower, supplying air for atomization of the fuel. Also this motor operates a small oil pump.

Before attempting to make such an installation, it is advisable to take the matter up with the city authorities and the Underwriters in order to make sure that you can comply with their requirements. Ordinarily the oil tank should be five feet from any building and buried three feet underground. If no insurance is carried on the building or where such an equipment does not conflict with city ordinances, a gravity feed system may be used (see Fig. 109).

A low pressure burner such as is shown in Fig. 12, Page 36, is used in the installations shown in Fig. Nos. 105, 106 and 107 while the burner shown in Fig. 108 is of the high pressure type (see Fig. 10, Page 33) because high pressure air was available in this instance. Had high pressure air not been available, the same burner as used in Fig. 105 would have been required.

The burner shown in Fig. 109 is of the cascade type, generally known as an air carbureting burner. The oil flows down over the elements and is consumed as it flows. No atomizing agent is required but only very light oil which vaporizes readily can be used with this burner, such as kerosene, 36 gravity Beaume crude oil or No. 1, 2 or 3 distillates.

BURNING LIQUID FUEL

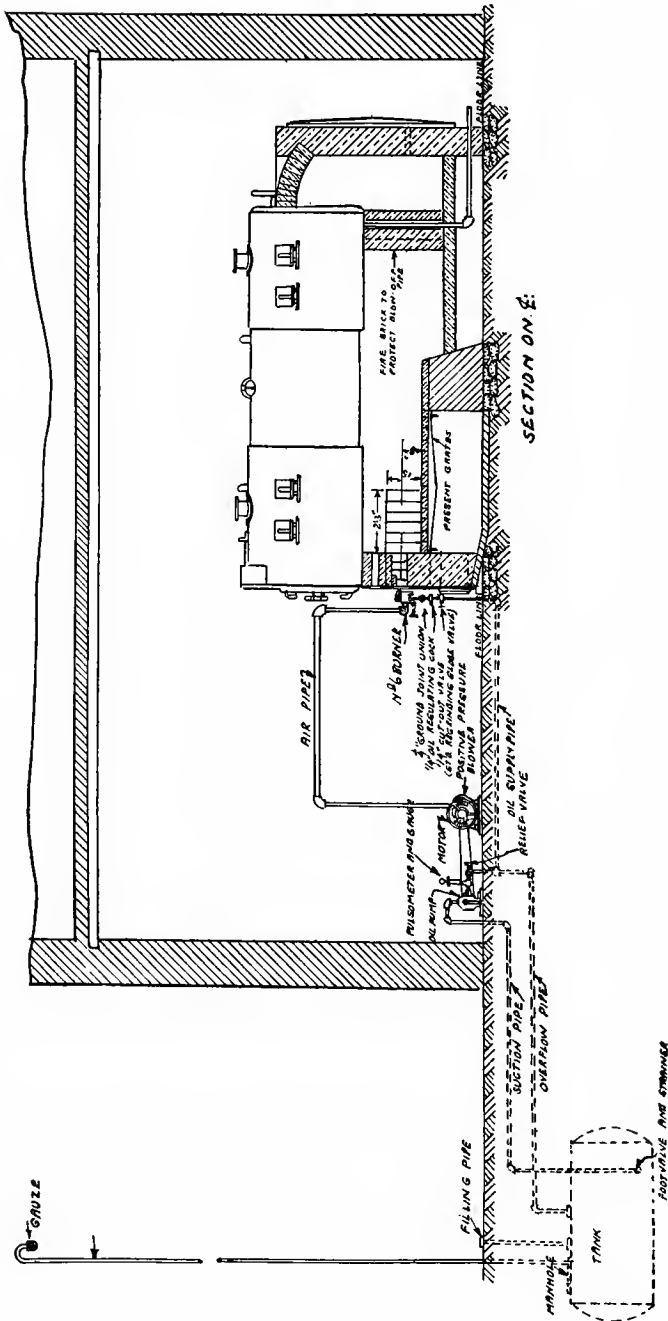

Fig. 105. Hot water boiler equipment.

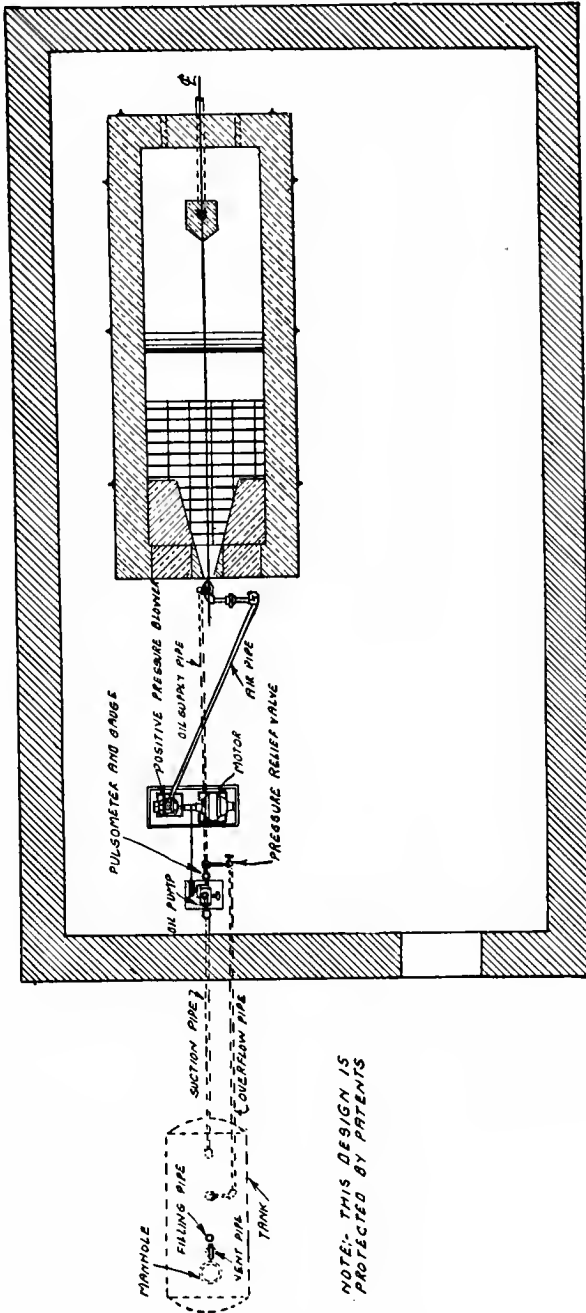

Fig. 106. Plan view of hot water boiler equipment.

BURNING LIQUID FUEL

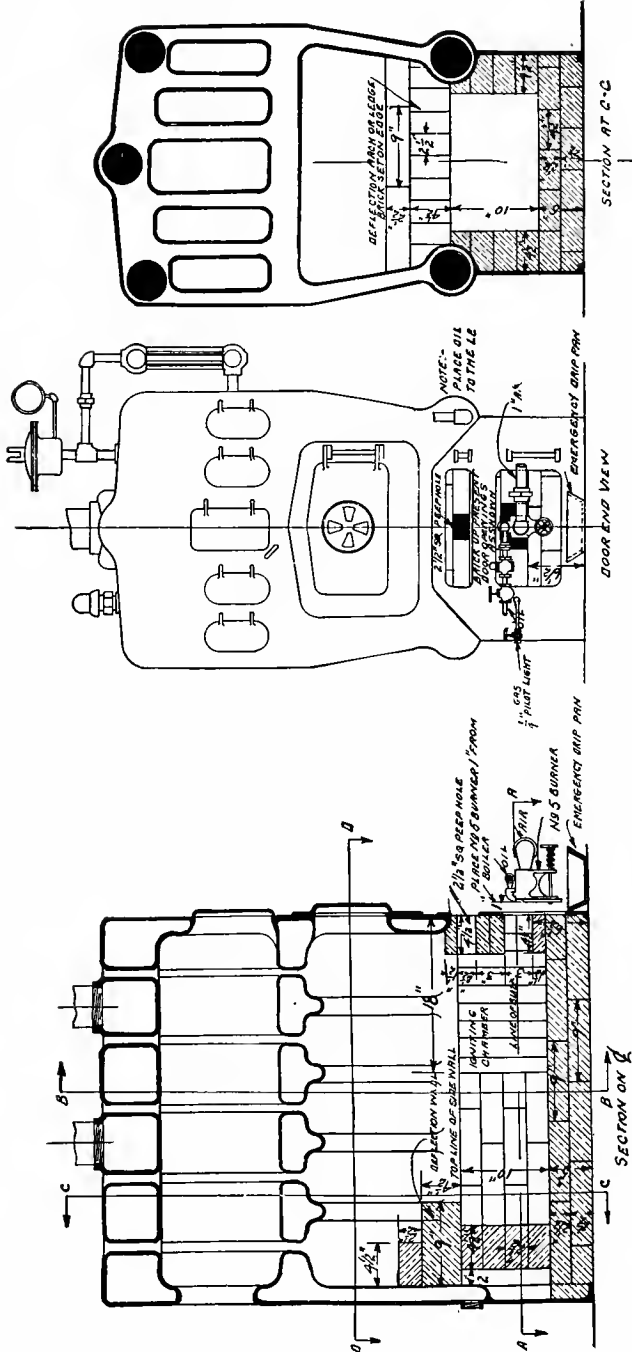

Fig. 107. Low pressure hot water boiler (cast iron elements) equipped with low pressure oil burner.

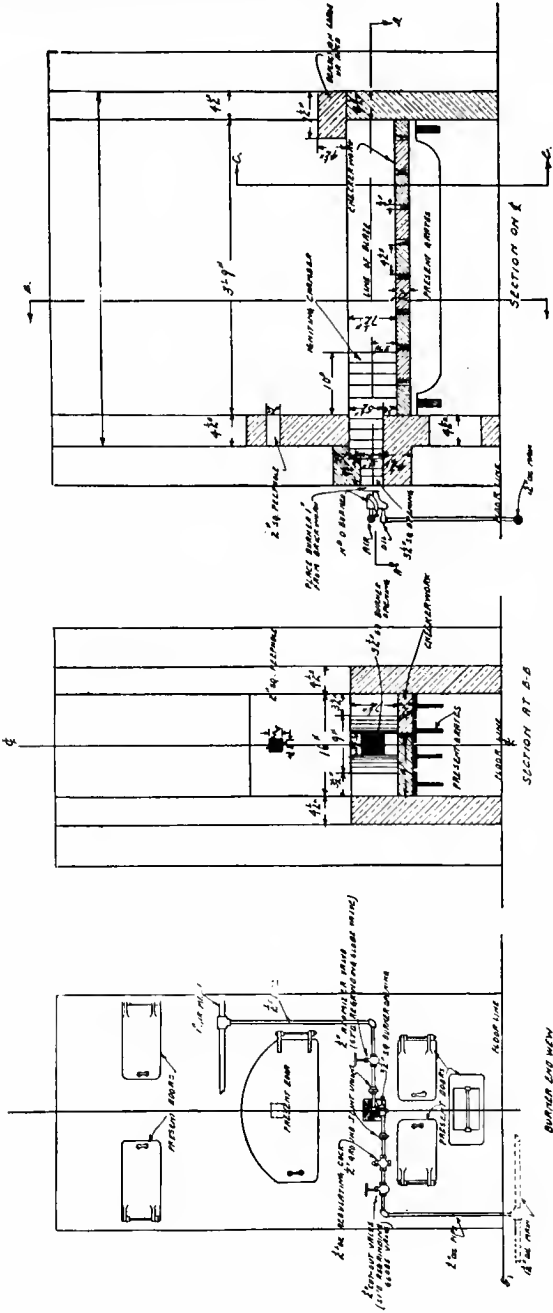

Fig. 108. Hot air furnace equipment.

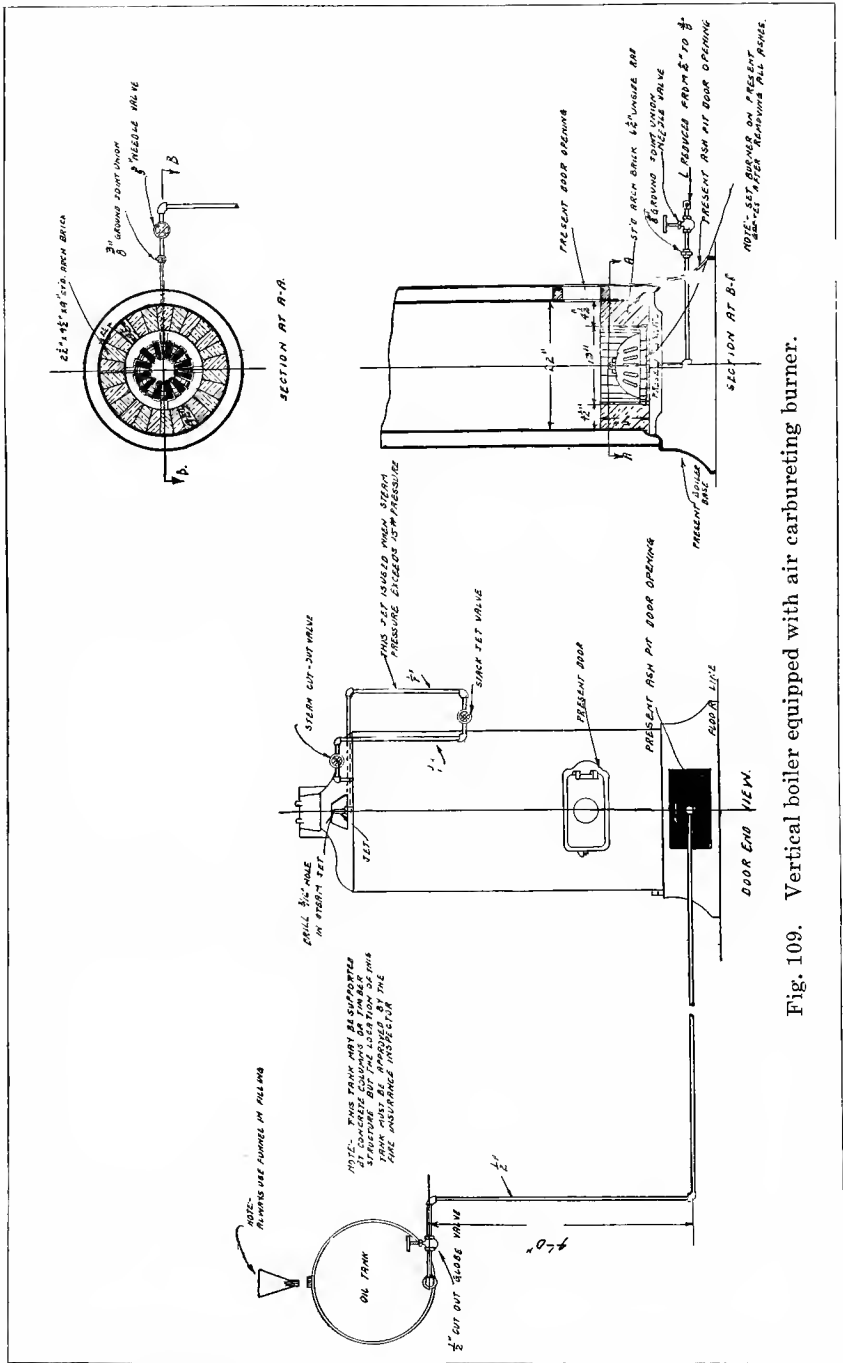

Fig. 109. Vertical boiler equipped with air carbureting burner.

Chapter IX

COMMERCIAL GAS INDUSTRY EQUIPMENT

Water gas tar is the by-product from the water gas works, and is of very high calorific value having 16,970 B.t.u. per pound which is equivalent to 161,200 B.t.u. per gallon, as it weighs $9\frac{1}{2}$ pounds per gallon. It has a higher calorific value per gallon than any other liquid fuel except coal tar. It is ordinarily used in boilers, either in combination with breeze or poor coal, using a swivel type of burner (Fig. 63, page 89), or with the liquid fuel injecting apparatus (Fig. 91, page 117) or it is used with the same type of boiler equipment as crude oil. If the liquid fuel injecting apparatus is placed mid-way between the front end of the boiler setting and the bridge wall as indicated in Fig. 111, either coal or oil water gas tar may be used exclusively as fuel or they can both be used in combination.

There is always more or less difficulty in separating the water from the water gas tar. This is done in two ways. One way is by the use of a separator made of steel, and in very large gas works this is about 17 feet wide x 34 feet long x 5 feet high. Baffle plates are placed in this separator 4 feet apart, so that the incoming tar and water must flow over the first baffle, then under the second baffle, then over the third baffle, under the fourth baffle, etc. These baffles may be used and yet success will not be obtained unless the water and tar are heated to approximately a temperature of 170 degrees F by a coil placed in the bottom of the separator. If the water and tar are heated to 190 degrees F, do not use a separator at all; or if it is only heated to 150 degrees F better not employ any means to separate the water from the tar. You will find having the accurate temperature and agitation to be very important factors in the separation of water and water gas tar. We have mentioned 170 degrees F as this is the temperature required when using crude oil of 30 gravity through the carburetors. Of course it is obvious that when oil above 30 degrees gravity Baume is used through the carburetors of the gas works the tar should be

BURNING LIQUID FUEL

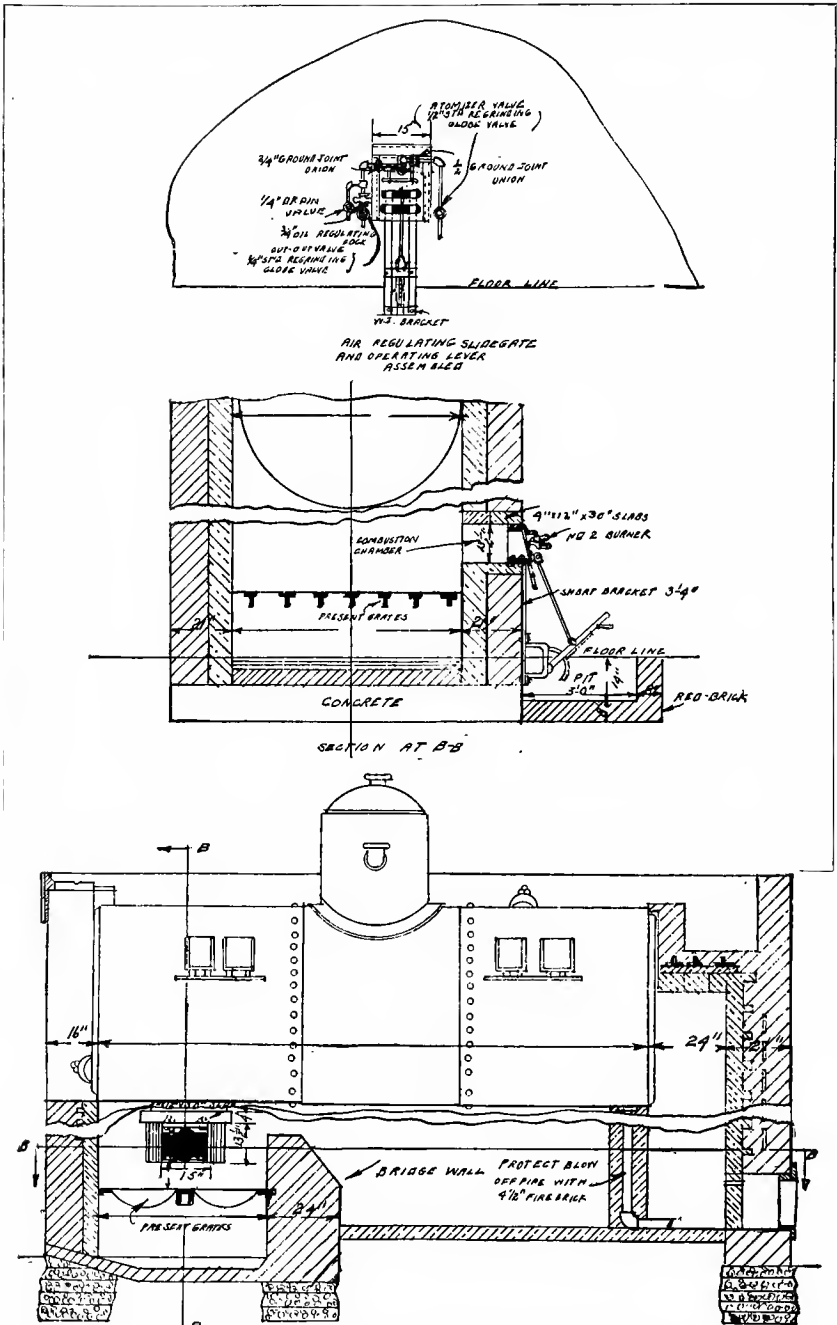

Fig. 111. Liquid fuel injecting apparatus applied to a horizontal return tubular boiler.



Fig. 112.
Separator
(shown
through
courtesy of
Sharples
Specialty Co.)

heated to a point proportionately lower than 170 degrees F, and when the oil used through the carburetors is of a lower gravity than 30 degrees gravity Baume the tar should be heated to a point higher than 170 degrees F. It can readily be understood that agitation and the proper temperature are required to separate the water from the tar, but this temperature will vary in accordance with the gravity of the oil used through the carburetors.

Another method that may be employed is by the use of the separator shown in Fig. 112 and described below:

The purpose of the Sharples Process for the dehydration of water gas tar is to recover a marketable product with less than 5 per cent moisture from water gas tar emulsions that cannot be resolved by ordinary measures.

In small gas plants where it is desired to burn water gas tar the gravity feed system is ordinarily used; that is, the bottom of the tar tank is placed about 4 feet above the burners and the water gas tar is allowed to flow by gravity to the burners. Gravity feed is ordinarily used even though the tank may be quite a distance from the building and the power plant on the opposite side of the street. We have noticed that sometimes the pipes will be so assembled as to make a vapor pocket. In case it is necessary to assemble the pipes so that the making of a vapor pocket is inevitable, be sure to vent the pipe in the manner shown in cut below.

Place the gauze over the return bend. Without a proper vent being placed upon this pipe you will always be troubled with an intermittent flame.

CAUTION:—

In pumping water gas tar or coal tar do not use brass lined or brass fitted pumps, such as are used in the pumping of oil, because of the fact that there is a chemical action which destroys their action in a very short time. Use iron lined pumps having iron pistons and other fittings for this purpose.

When burning water gas tar do not heat it as when burning oil below 20 gravity Baume or when burning coal tar, which must be heated in order to make it fluid. A circulating system should always be used with coal tar as it is high in free carbon.

Coke oven benches can be operated successfully by the use of water gas tar as a fuel, but do not try to use coal tar, as it has been found very unsatisfactory because the free carbon contents in the

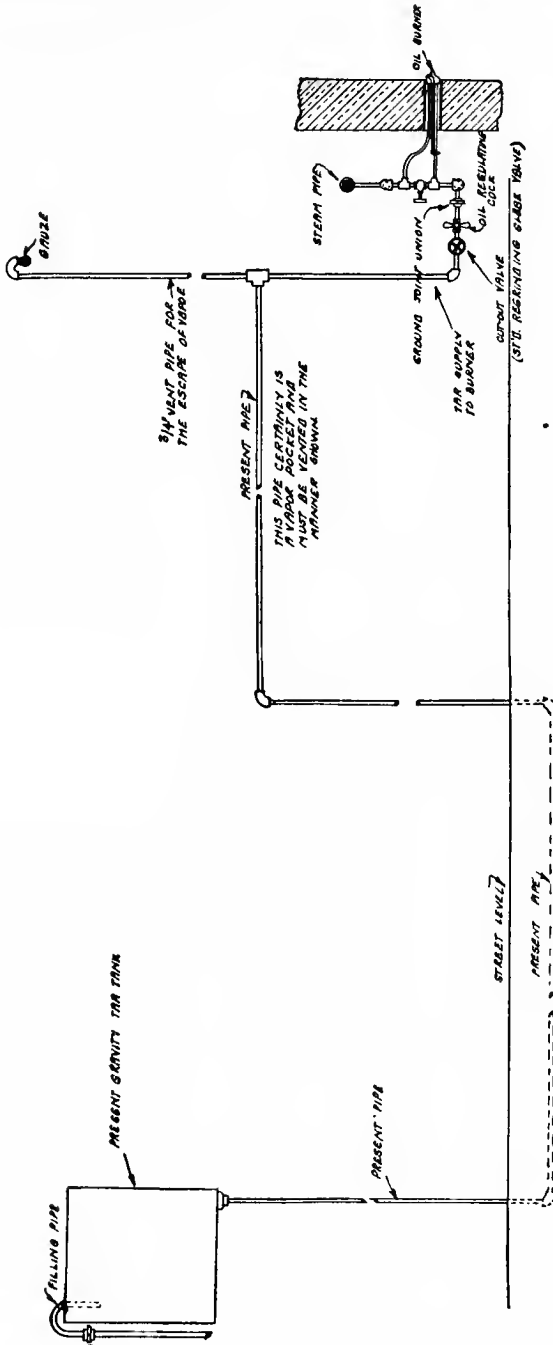

Fig. 113. Gravity feed ventage to prevent an intermittent fire.

tar stops the flow of oil to the burner in the oil-regulating cock. The stream or column of tar passing through the burner is not greater than $\frac{1}{32}$ inch in diameter, and hence the free carbon in a few minutes clogs the opening. Of course any grade of crude oil can be used in the operation of coke oven benches, a cut of which is shown on page 140.

Chapter X

SUGAR INDUSTRY EQUIPMENT

The use of bagasse as fuel is of course the common practice in all sugar centrales, and we take pleasure in showing several different forms of installations. Some centrales desire to heat the bagasse furnace by oil before the bagasse is charged, while others prefer to use wood for this purpose. The more modern practice is to use oil, but it is not good practice to use oil as fuel in the bagasse chamber along with the bagasse using both fuels at the same time, owing to the fact that the oil cannot secure sufficient oxygen to effect perfect combustion. If bagasse is used the oil burner should be installed in the side wall of the fire-box, or in the end wall, as shown in accompanying cuts.

We usually estimate that three gallons of oil are required per ton of bagasse burned in order to maintain the boiler rating. If, however, it is desired to raise the boiler rating with an oil burner or liquid fuel injecting apparatus, you can readily increase the horsepower of the boiler to 200 per cent rating. Some of the bagasse furnaces are now being built so large that the boiler rating can be attained and maintained without the use of oil fuel, but it is of course dangerous to depend wholly upon bagasse as fuel for there might be an accident which would delay its delivery. It is better practice to always be prepared to use oil if necessary, and thus insure the successful operation of the plant at all times.

We ordinarily figure on the calorific value of sugar containing 7120 B.t.u. as cellulose 7533 B.t.u. and glucose 6748 B.t.u. per pound. Taking these heats of combustion as a basis, and assuming that the fibre has the same fuel value as the cellulose, it is possible to calculate the thermal value of bagasse. Thus a bagasse of composition fibre 42 per cent and sugar 9.666 per cent will afford on complete combustion, $.42 \times 7533 - .0966 \times 7120$ or 3821 B.t.u. per pound for the fibre and sugar alone, to which must be added that due to the glucose and other organic matter. If this be taken as one-tenth that due to the sugar (the gross thermal value of the sugar), the gross thermal value of the bagasse will be 3920 B.t.u.

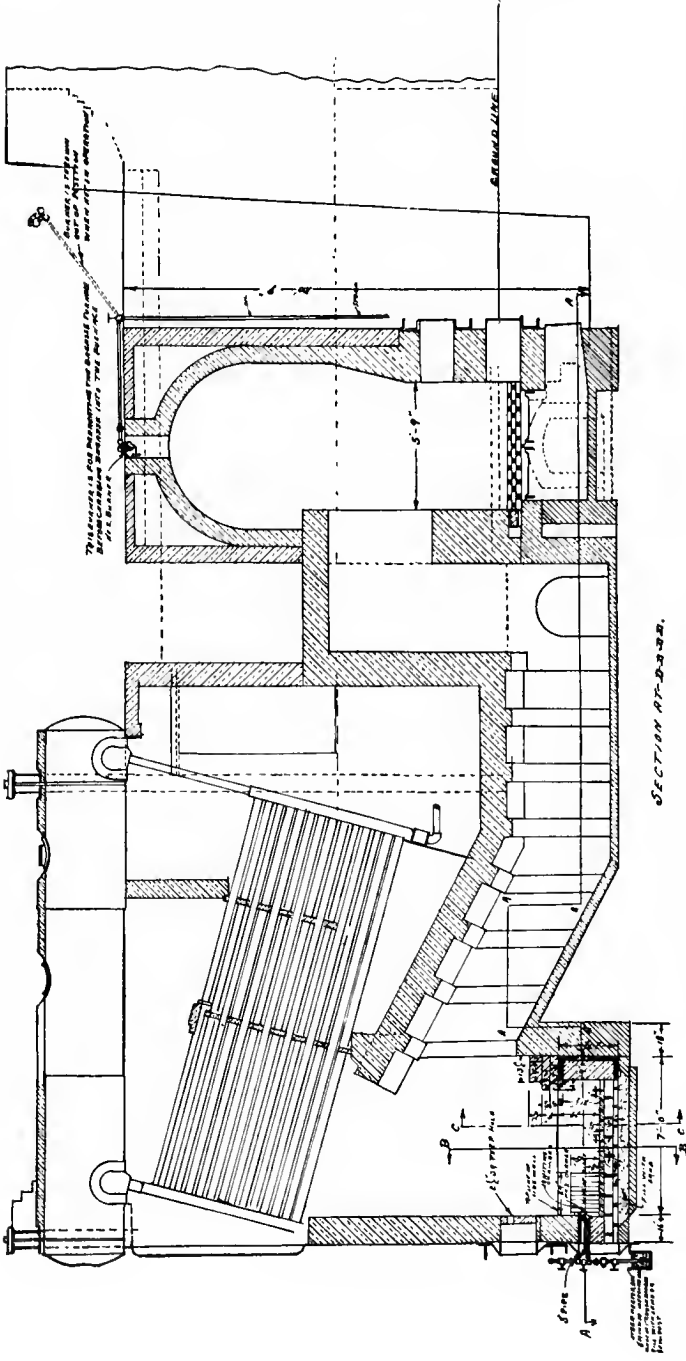

Fig. 117. Babcock & Wilcox boiler equipment, oil being burned in combination with bagasse. The bagasse furnace is not shown.

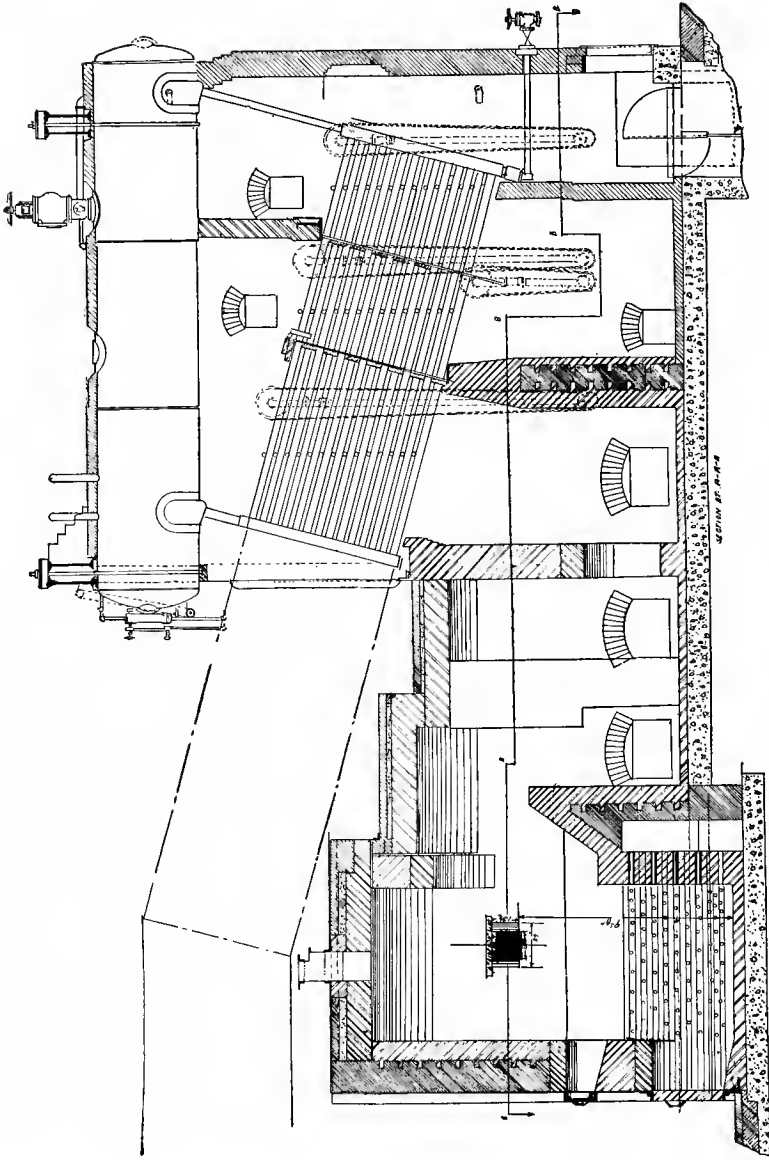

Fig. 118. Babcock & Wilcox boiler with very large bagasse furnace, the oil burner being installed in the side of fire-box in the opening shown.

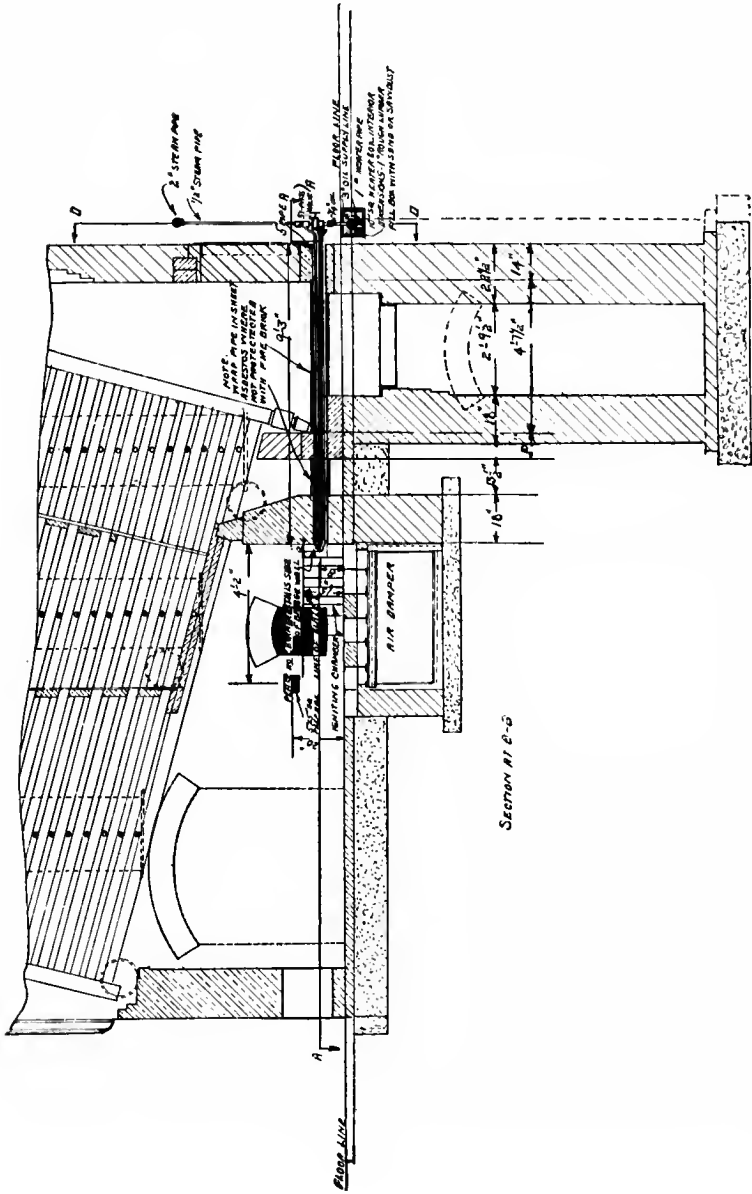

Fig. 119. Back-fired bagasse furnace (B. & W. boiler), the burner mounting being 9 ft. 3 in. long.

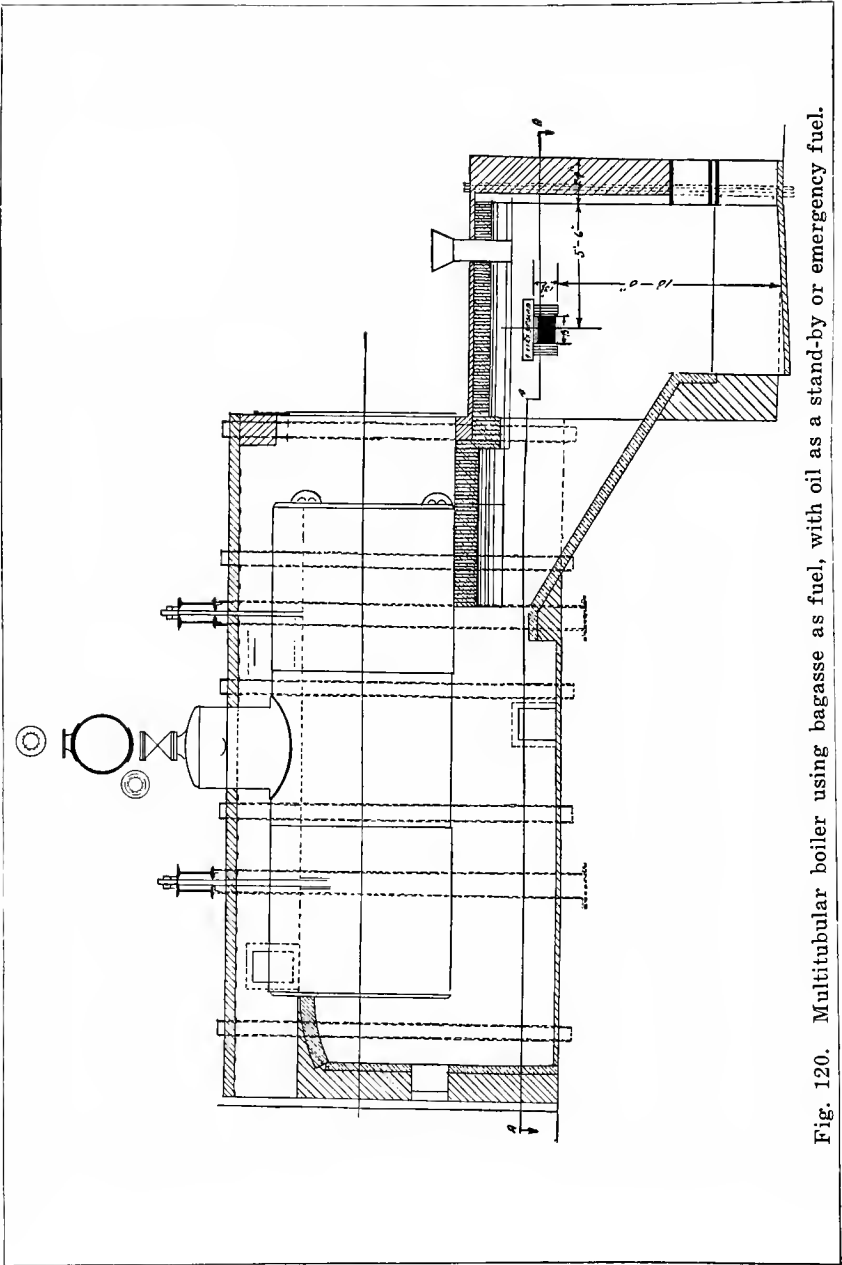

Fig. 120. Multitubular boiler using bagasse as fuel, with oil as a stand-by or emergency fuel.

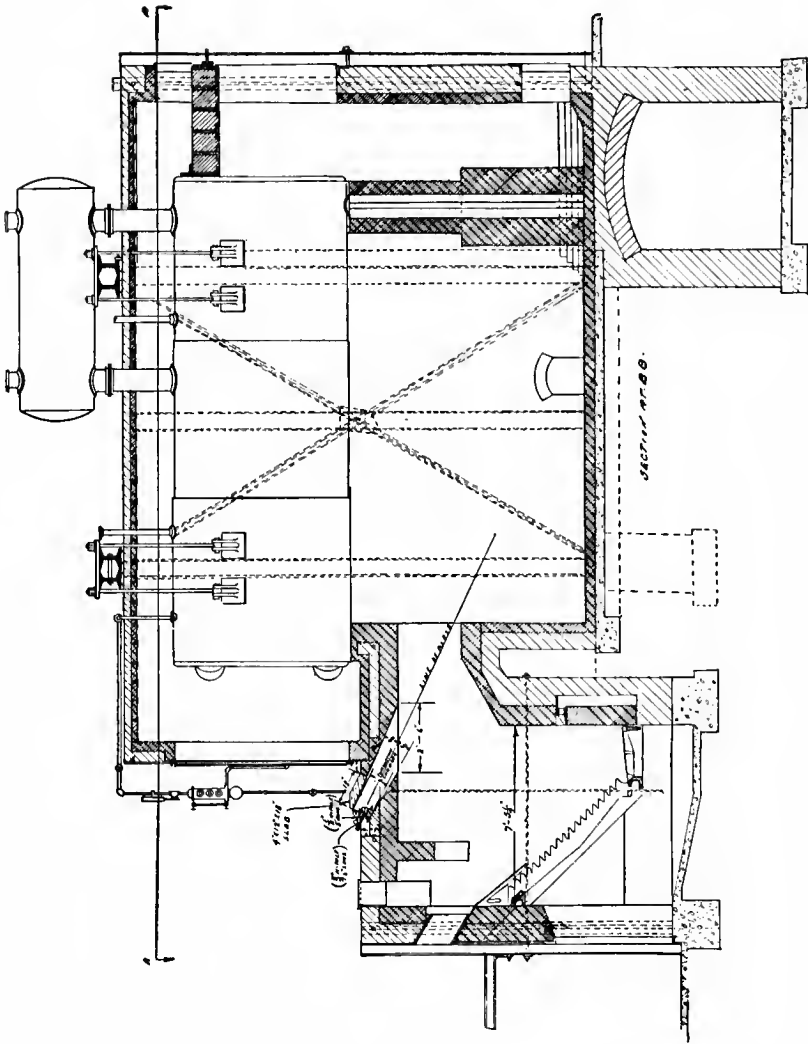

Fig. 121. Multitubular boiler in which oil burners are used in combination with bagasse, or alone.

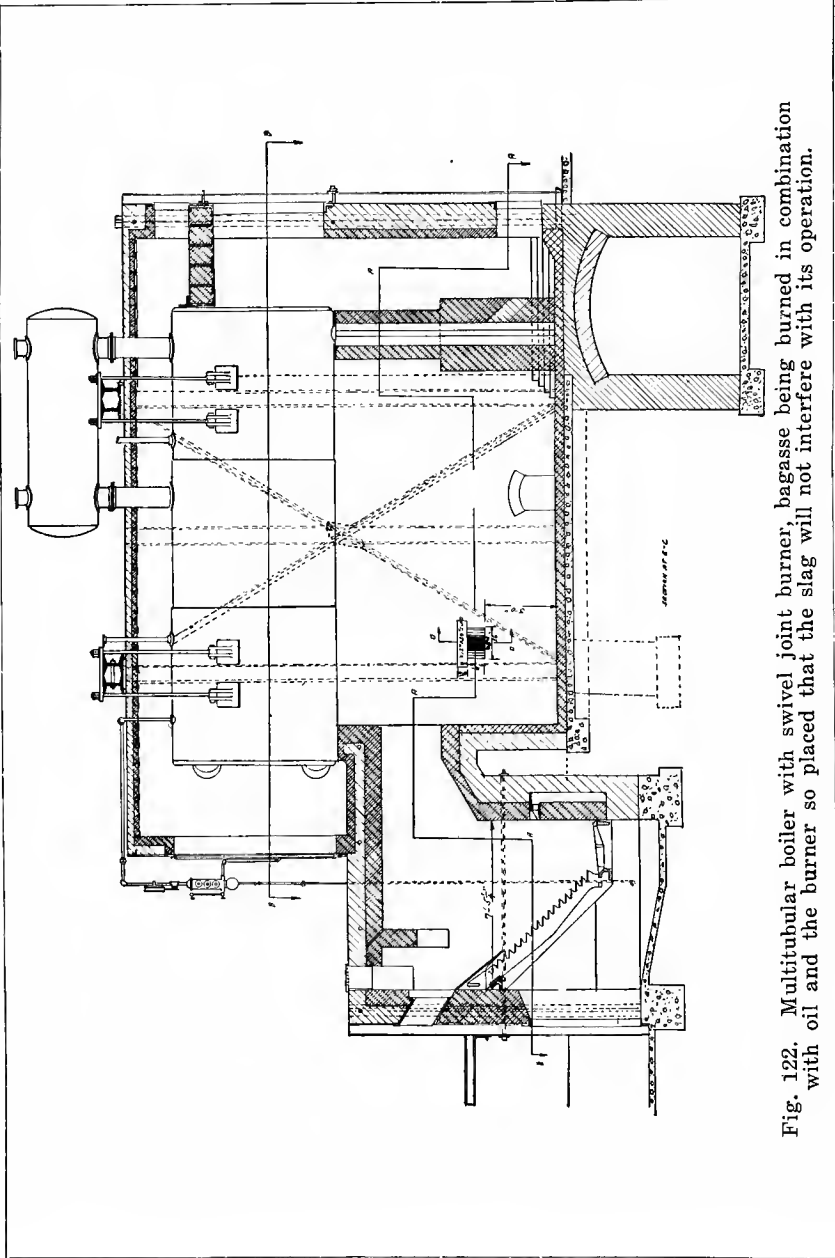

Fig. 122. Multitubular boiler with swivel joint burner, bagasse being burned in combination with oil and the burner so placed that the slag will not interfere with its operation.

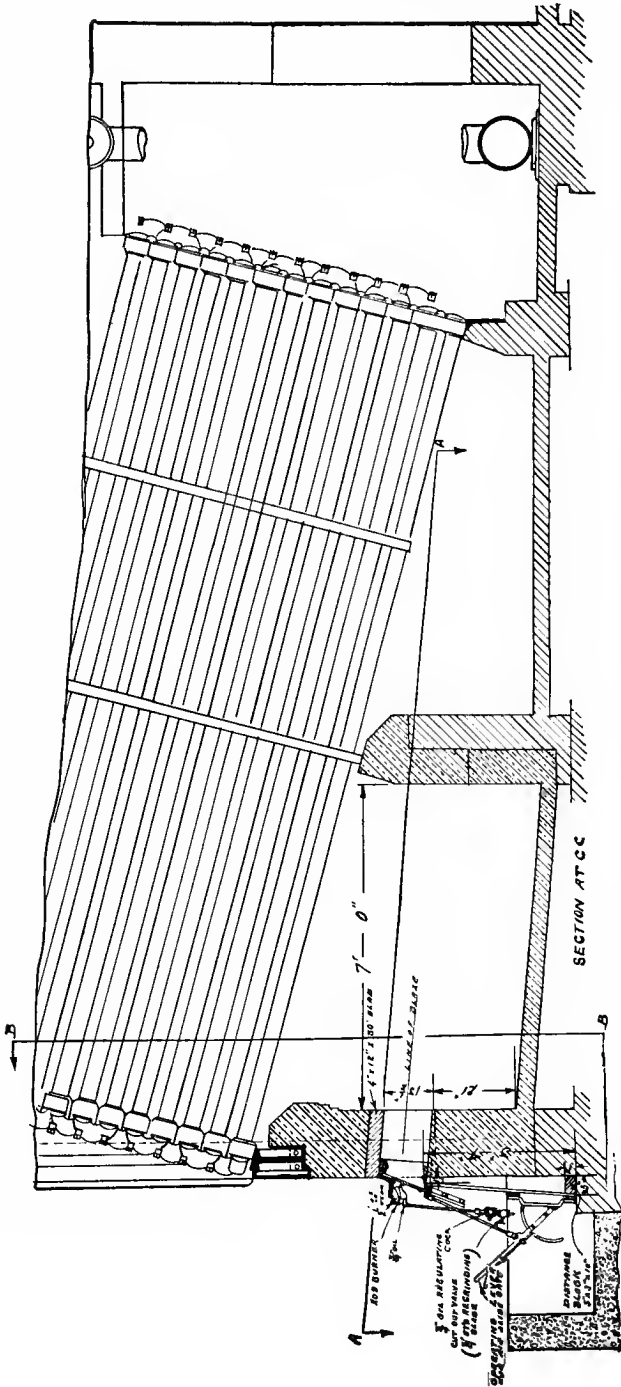

Fig. 123. Liquid fuel injecting apparatus applied to a Babcock & Wilcox boiler, bagasse furnace not shown.

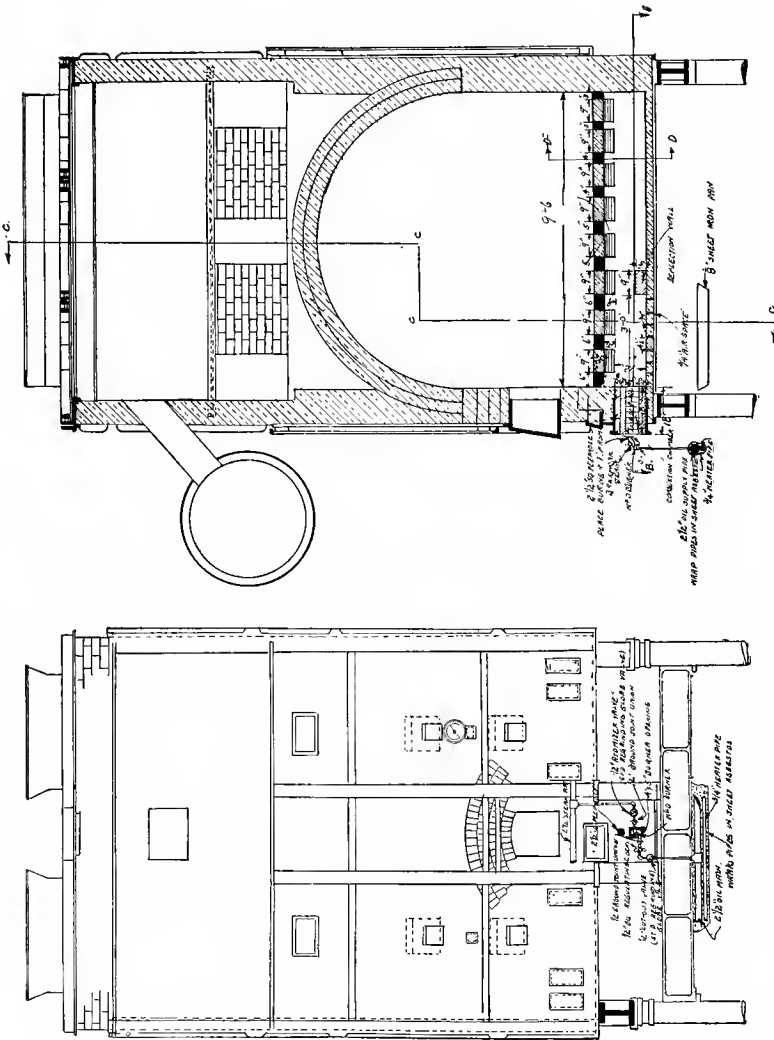

Fig. 124. Char kiln equipment.

per unit of dry matter, and supposing the bagasse contains 47 per cent water, 7396 B.t.u.

The refuse molasses of sugar works can be burned in combination with oil through a modern atomizing burner. This by-product

(molasses) is very low in its calorific value, not having more than 3.400 B.t.u. per pound.

In sugar refineries oil is also an ideal fuel for char kilns, for its use enables you to get a more even distribution of heat than you can with coal or coke.

Chapter XI

STEEL FOUNDRY PRACTICE

Oil is an ideal fuel in steel foundries because you can get the maximum output from the furnaces. In ordinary practice using producer gas but two heats a day can be obtained from the open hearth furnaces, while with oil three heats are the ordinary practice. Of course by the use of oil you can maintain better temperatures than you could hope to obtain from producer gas.

In changing an open hearth furnace in which originally either natural or producer gas has been used, it is necessary to close the original gas port at each end of the furnace and build up a dog-house of fire-brick.

The oil burners (if not water-jacketed) are mounted with swivel joints so that they can be swung back out of the furnace when not needed. The operating valves may be located close to the burner or wherever they are most convenient for the operator. When a water-cooled type of oil burner is used, it is not necessary to construct a dog-house on each end of the furnace nor is it necessary to remove the burner each time that the furnace is reversed.

Referring to Figs. 133 and 134 showing manner of applying oil to a gas-fired furnace, you will see that the gas regenerators are also used to preheat the air in conjunction with the air regenerators, the port leading to both regenerators. It is obvious that by utilizing both the air and the original gas regenerators, the slag will not injure the furnace draft conditions as quickly as when only using the air regenerators.

In a modern oil-fired open-hearth furnace the air is admitted immediately under the burner and the end of the furnace should be carefully constructed so that the flame made by the burner will fit it. (Fig. 135.)

By means of a small oil furnace, the large ladles used in steel foundries can readily be heated to the temperature at which the molten metal is poured. When the ladle is heated to the required temperature, the cover is removed, the ladle placed in position to receive the charge and the little heating furnace swung up out of

the way. This furnace is mounted with swivel joints and a counterweight. (See Fig. 138).

In a crucible steel melting furnace of the type shown in Fig. 141, the space occupied by the 6 pots at the burner end of the furnace is

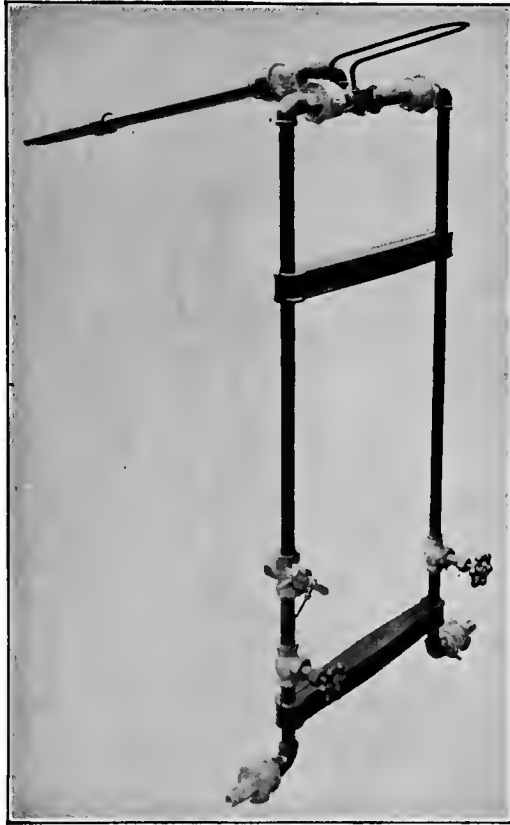

Fig. 126. Open hearth furnace burner. (See Fig. No. 131.)

termed the "melting zone," while the remaining charging space is called "preheating zone." When the metal in the first 6 pots is ready to pour, they are removed, poured, and refilled with steel punching, while the 8 remaining in the furnace are moved in their respective order into the "melting zone." The refilled 6 pots are

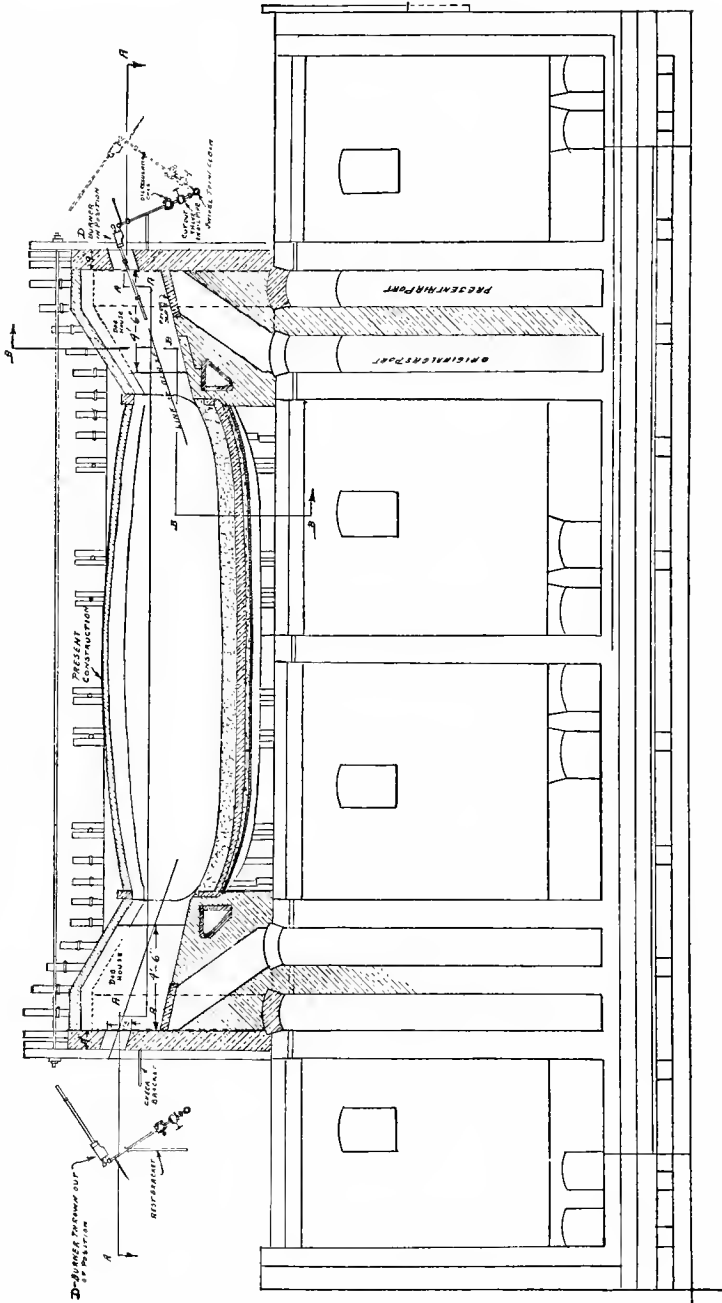

Fig. 127. Open hearth furnace changed from gas to liquid fuel.

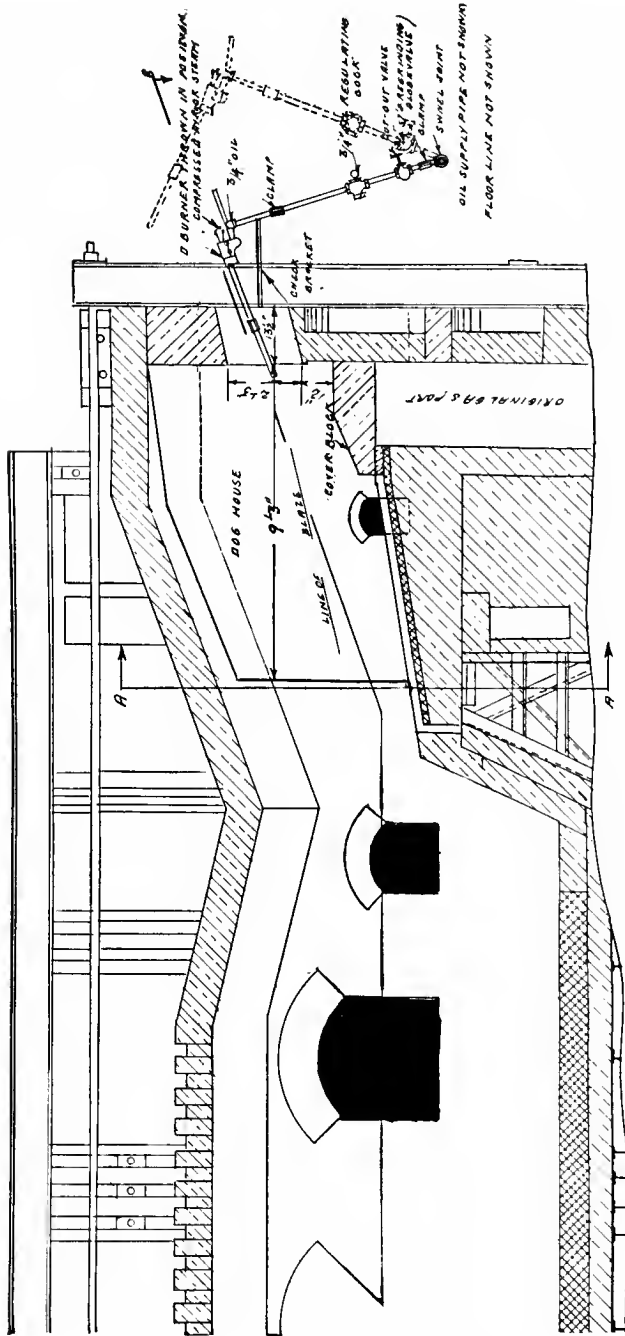

Fig. 128. Another form of open hearth furnace. Burner in position for operation.

BURNING LIQUID FUEL

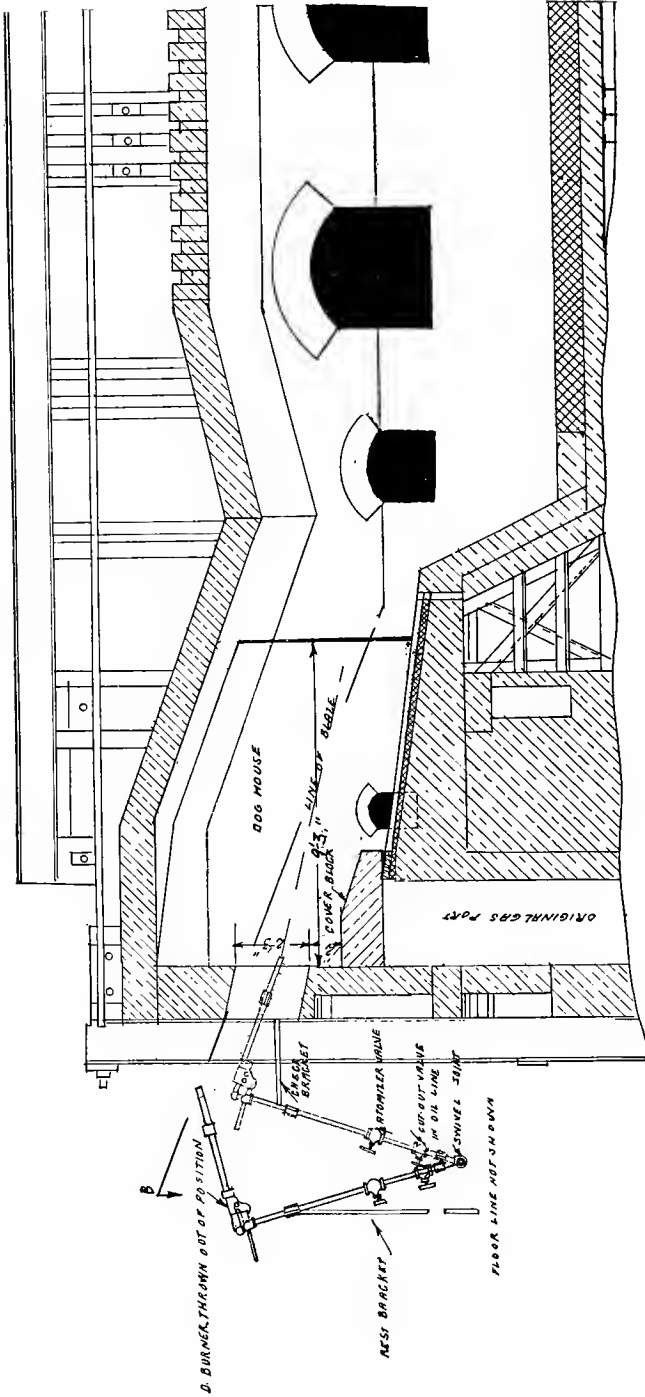

Fig. 129. View showing burner swung back out of position while not in operation.

then placed in the "preheating zone" of the furnace. This furnace is a vast improvement over the old style pan system which was used some years ago. Only one burner is required to atomize the oil and distribute the heat.

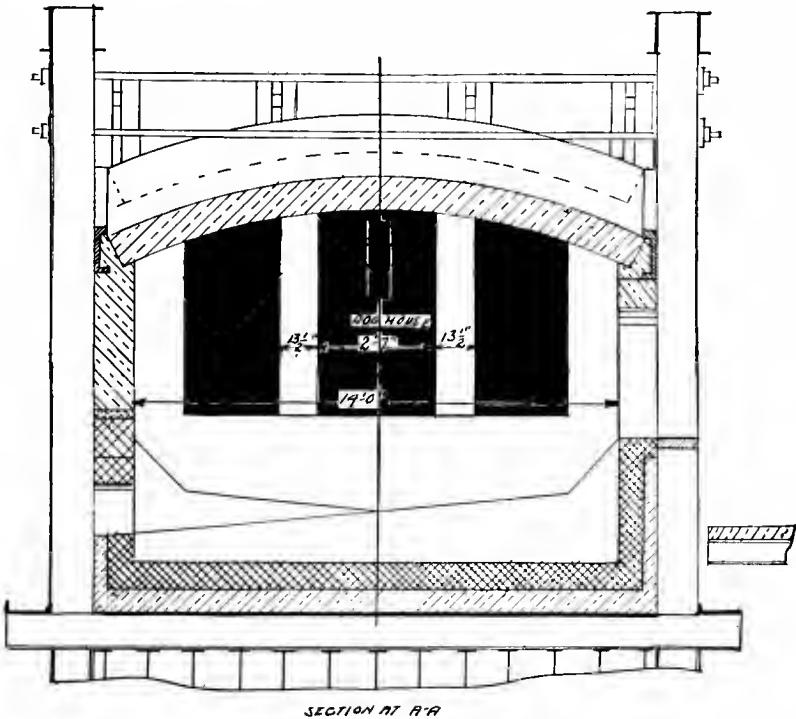

Fig. 130. "Dog house." View looking toward burner end.

Instead of closing off the draft in the neck of the furnace by the old fashioned refractory damper, you will note the flat damper shown which is moved horizontally and which simply allows the air to pass through an opening, thus retarding the draft in the furnace and at the same time the cold air admitted tends to reduce the temperature in the flue. This refractory damper can be moved so as to make the opening wide open, or just sufficiently to give a partial opening as necessity demands. This type of damper lasts indefinitely as it can

not burn away, and you have a much better control of the furnace.

It is not necessary to move the crucibles from the "preheating" to the "melting zone" if you use the form of furnace construction indicated in Fig. 142. This 8-pot furnace is therefore much more modern in its construction than the 14-pot furnace. (Fig. 141.)

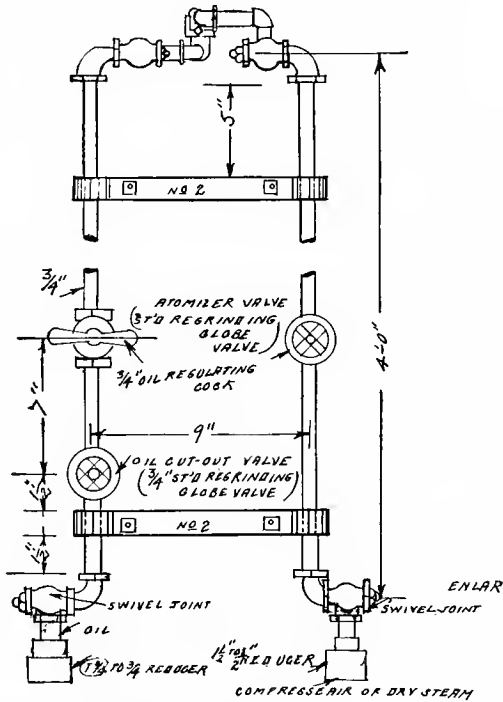
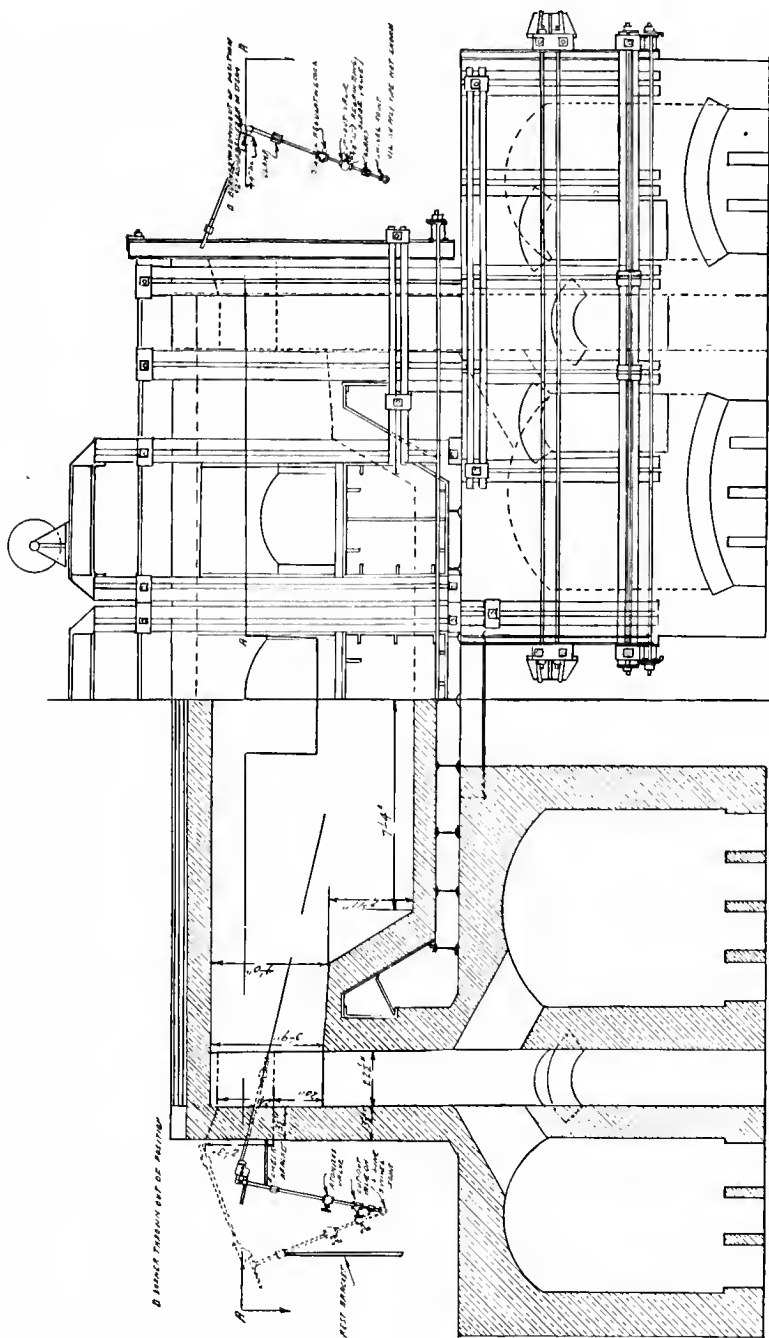

Fig. 131. Diagram showing burner piping, swivel joints, etc.

In steel foundries oil is especially attractive for large mould-drying ovens because of the fact that, if desired, the moulds can be dried 50 per cent quicker and more thoroughly than by the use of coal, coke or gas. I can almost hear my reader, who is the superintendent of a steel foundry and who has never used oil as fuel on his mould-drying ovens say: "I do not care to use a fuel that



VOL. SECTION AT 24-3

Fig. 132. Equipment of another type of open hearth furnace.

will heat so quickly, for it would simply ruin the moulds"; but my friend, coal or coke gives a localized heat, whereas by the use of the method of burning oil shown in Fig. 143 an absolutely even distribution of heat is obtained throughout the entire oven which

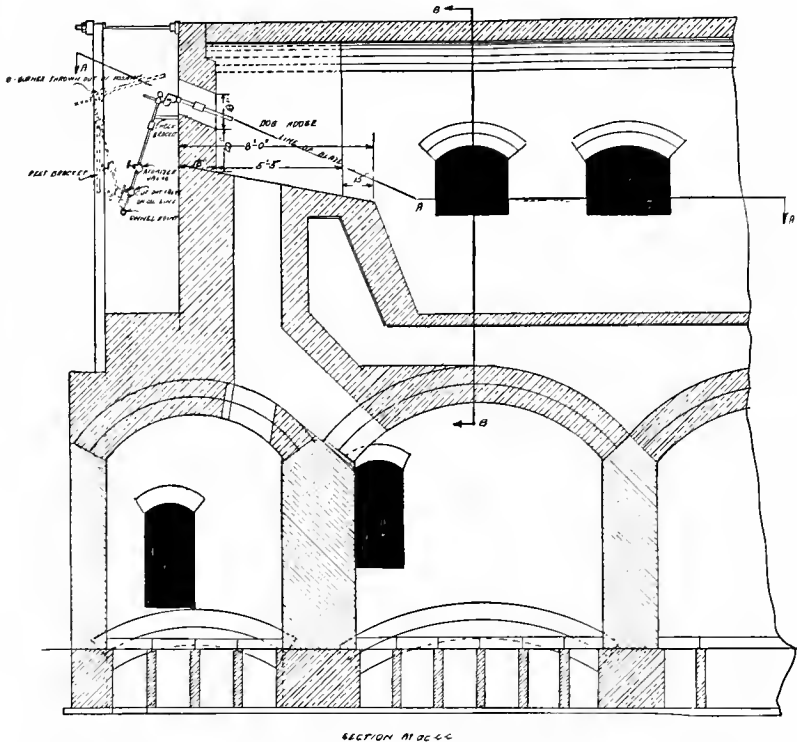

Fig. 133. Open hearth furnace, changed from gas-fired to oil.

in this case is 44 feet long, 20 feet wide and 12 feet high in the clear. This oven is operated with only one burner. In the combustion chamber, which runs through the center of the entire length of the oven, a temperature of 2000 degrees Fahrenheit is maintained, which insures your securing the highest possible efficiency from the fuel. You will note also that the combustion

chamber has heat ports of graduated size and such location as to insure an even distribution of heat. The heat ports at the farther end of the combustion chamber are smaller than those at the burner end. These openings must be carefully figured out, for the suc-

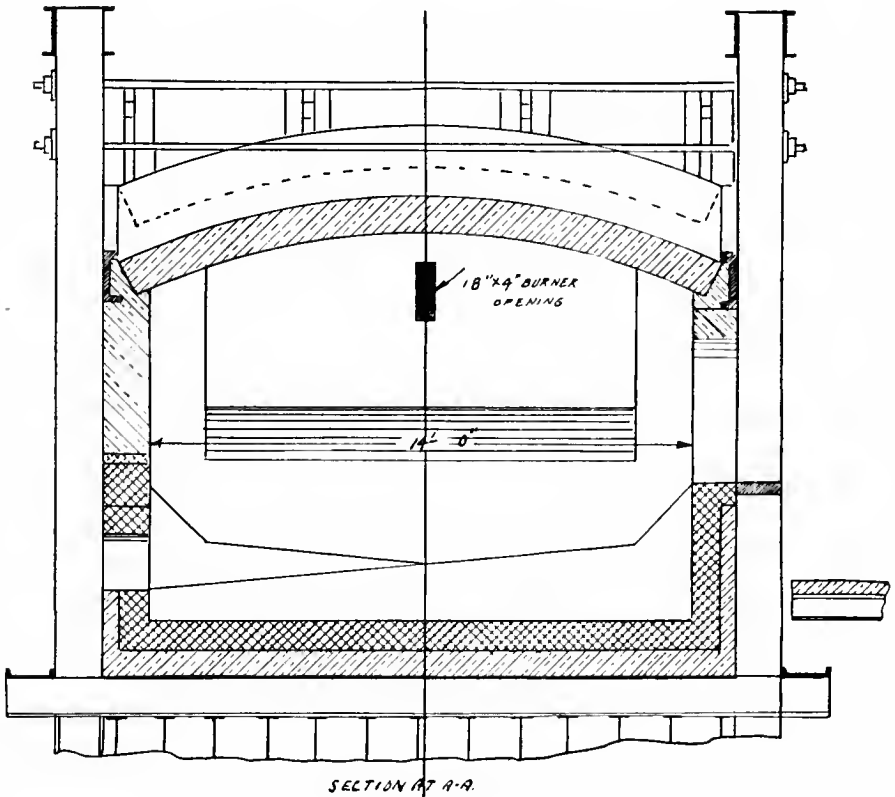

Fig. 134. View looking toward burner end of furnace.

cess or failure of the installation depends largely upon these ports.

The vents for the escape of moisture, also the consumed and inert gases, should always be located in the oven roof or arch. Never use the old stack method. Give the money ordinarily spent for the construction of a stack to the poor of the city or to some hospital, where it will be of some service to humanity.

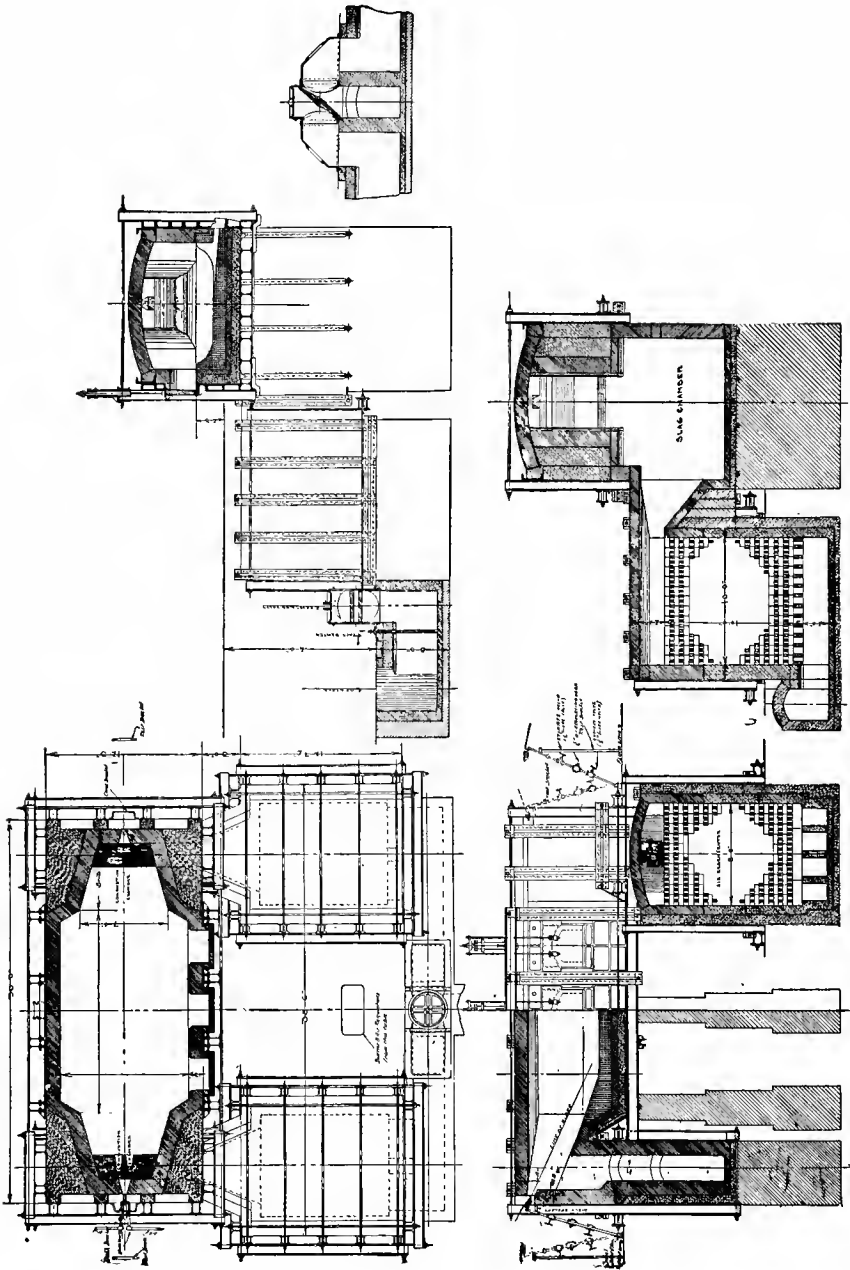

Fig. 135. A modern oil-fired open hearth furnace.

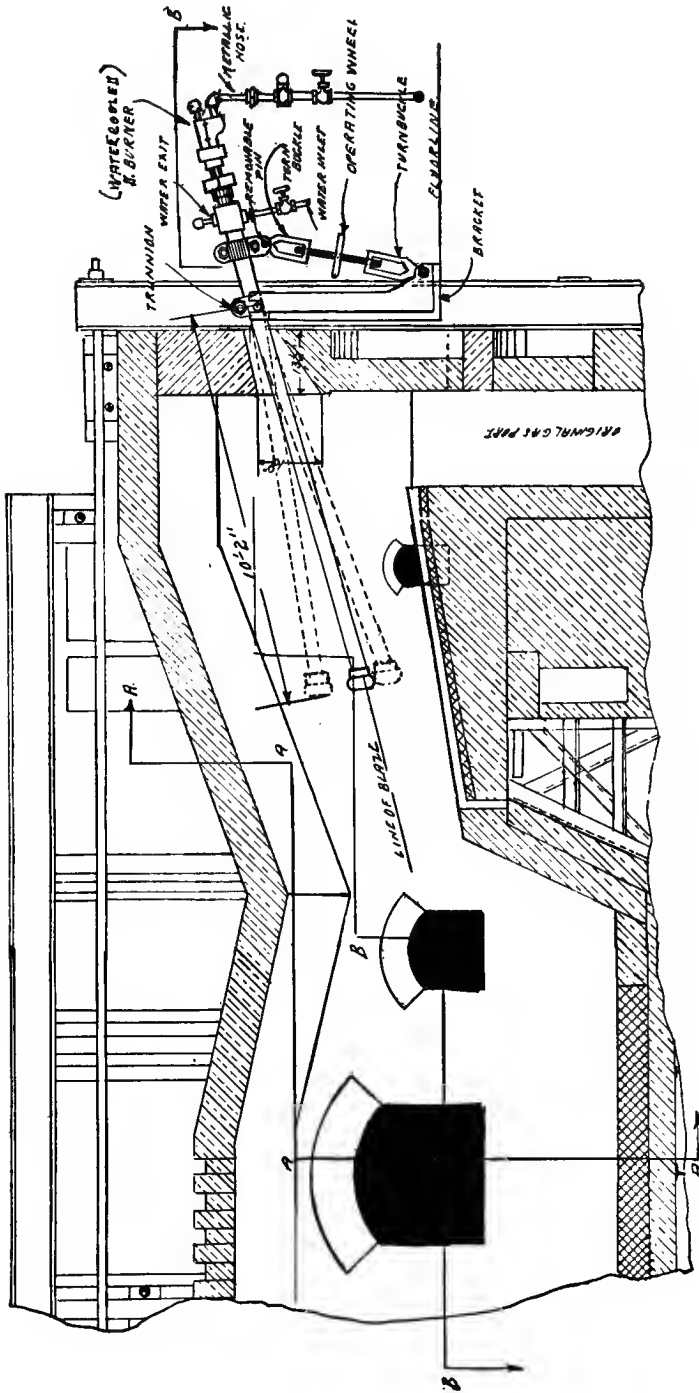

Fig. 136. Water-cooled oil burner for open hearth furnace.

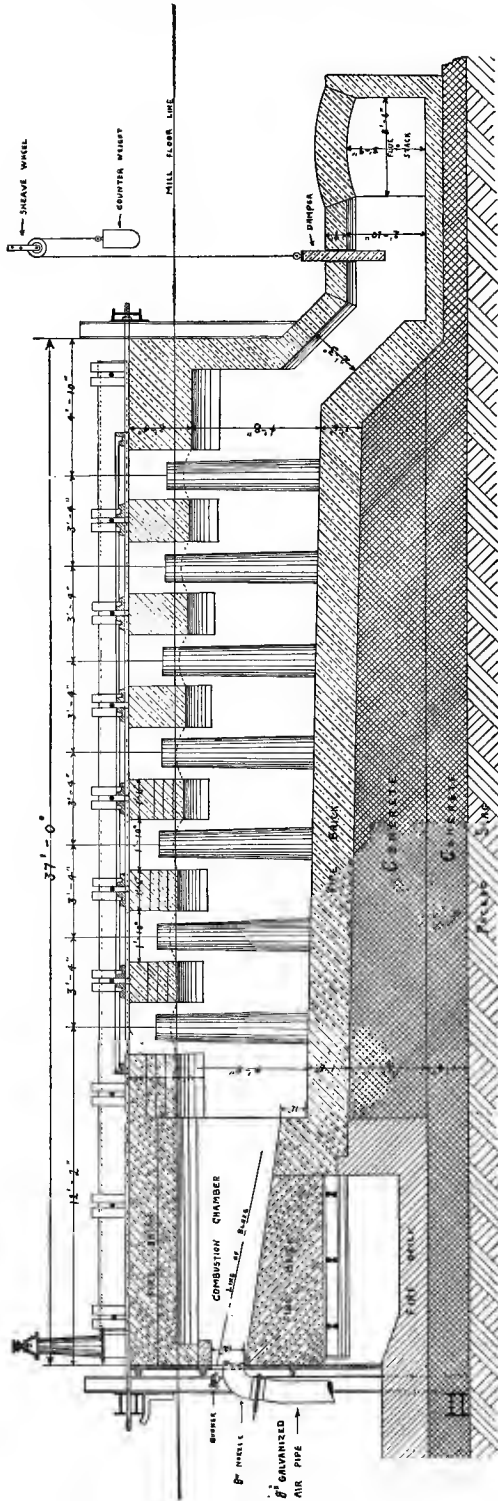

Fig. 137. Steel foundry soaking pits changed from coal to oil-fired.

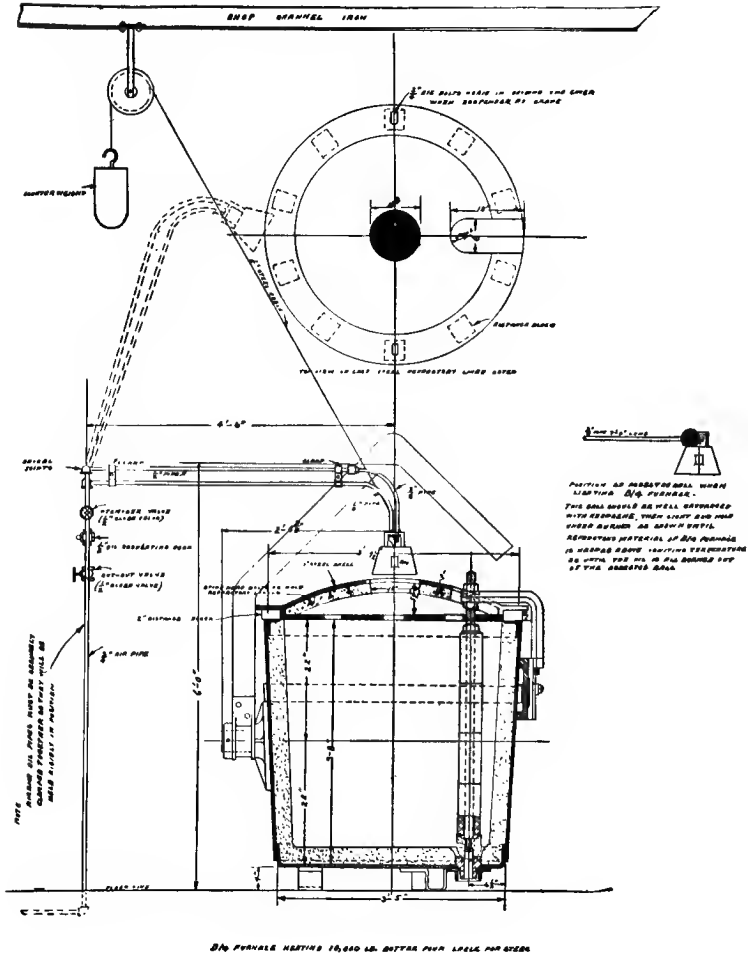

Fig. 138. Ten-ton bottom pour steel foundry ladle heated by a small oil furnace which can be swung aside when not needed.

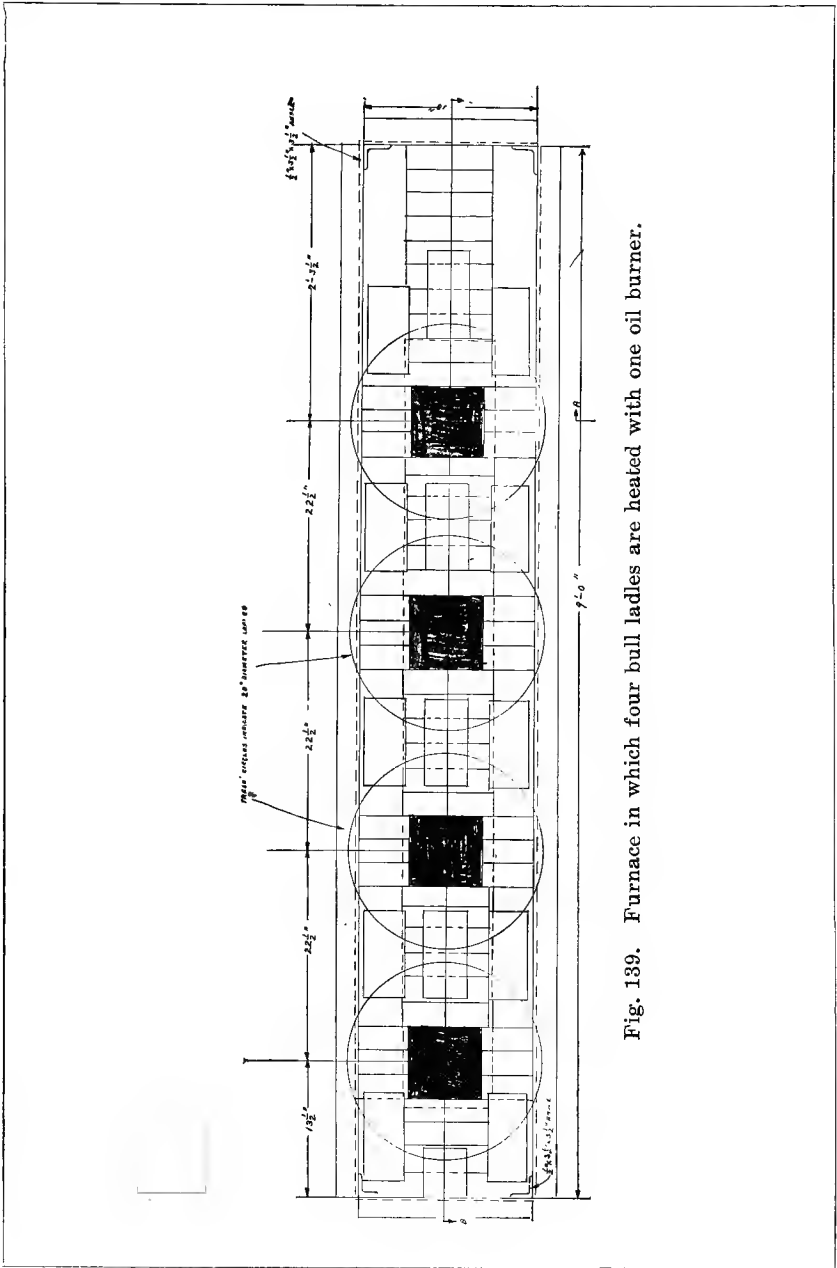
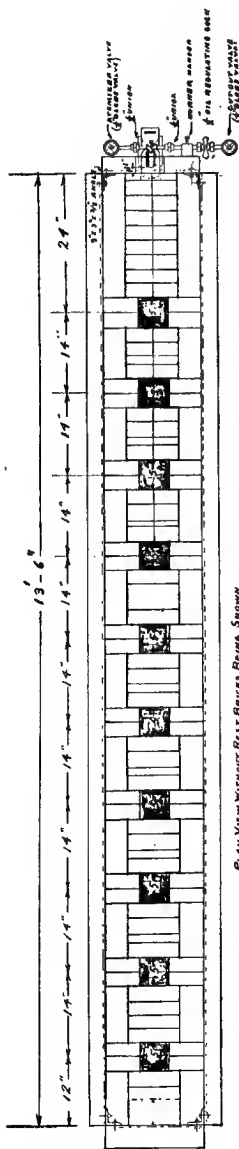

Fig. 139. Furnace in which four bull ladles are heated with one oil burner.



PLAN VIEW WITHOUT REST BRICKS BEING SHOWN
ALL TOP HEAR PARTS ARE 6" x 6"

Fig. 140. Multiple ladle heating furnace used for heating ten ladles at one time. Only one oil burner required.

BURNING LIQUID FUEL

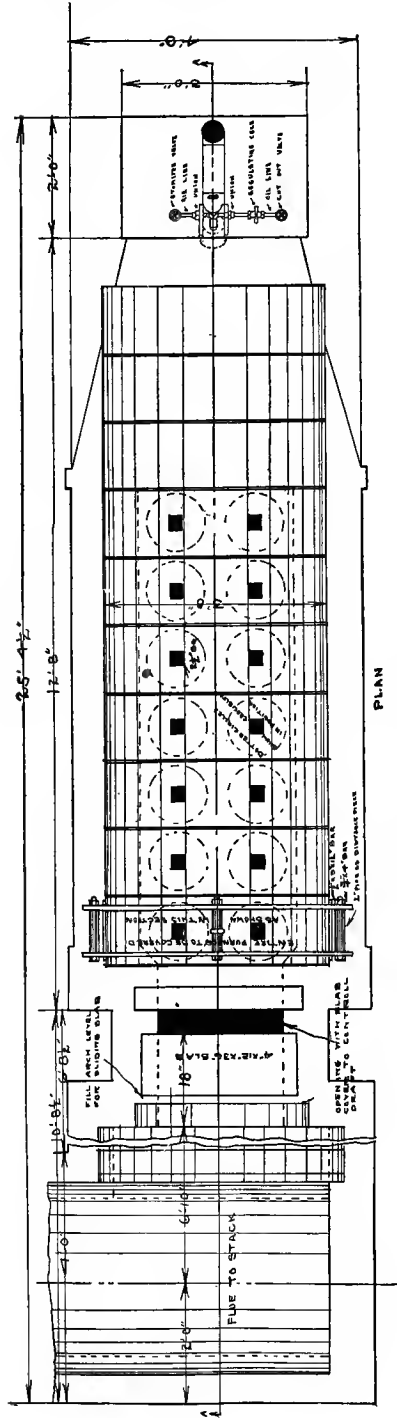

Fig. 141. Fourteen-pot crucible steel melting furnace.

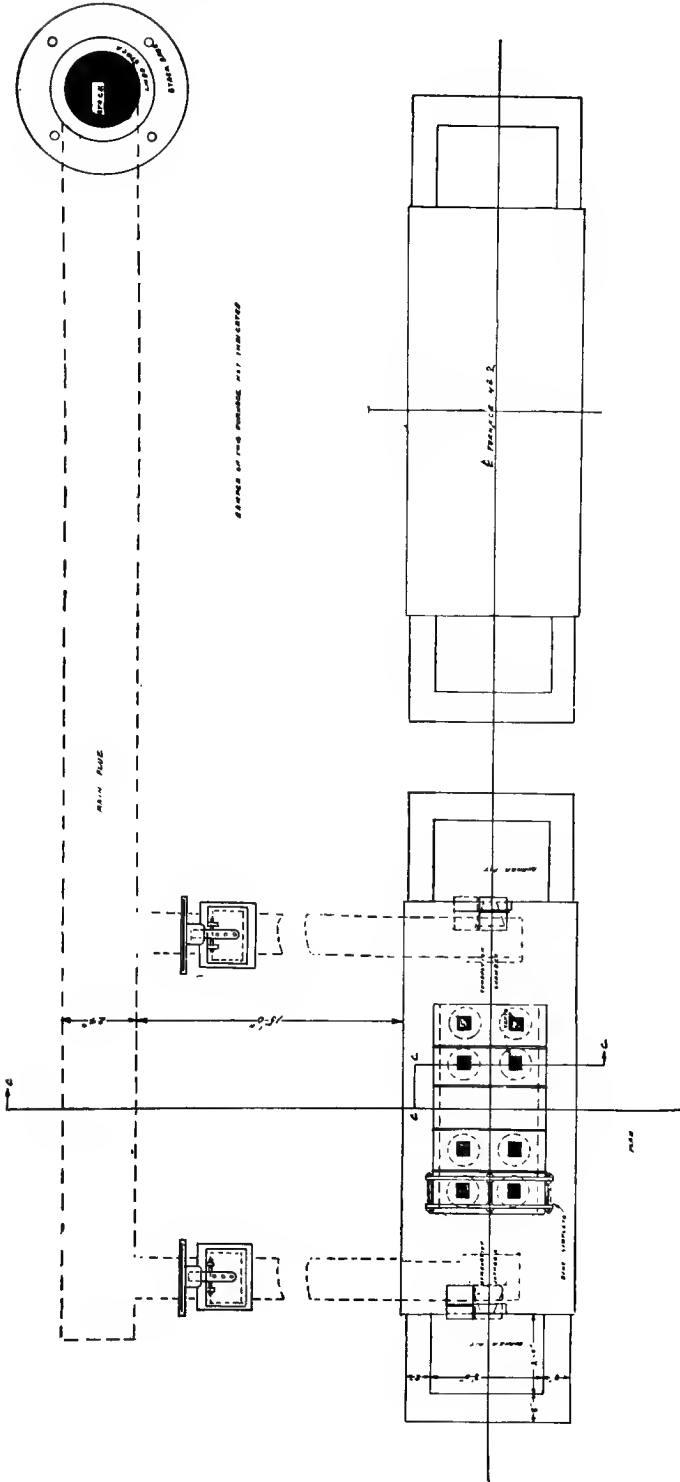

Fig. 142. Modern 8-pot furnace for melting crucible steel and other alloys.

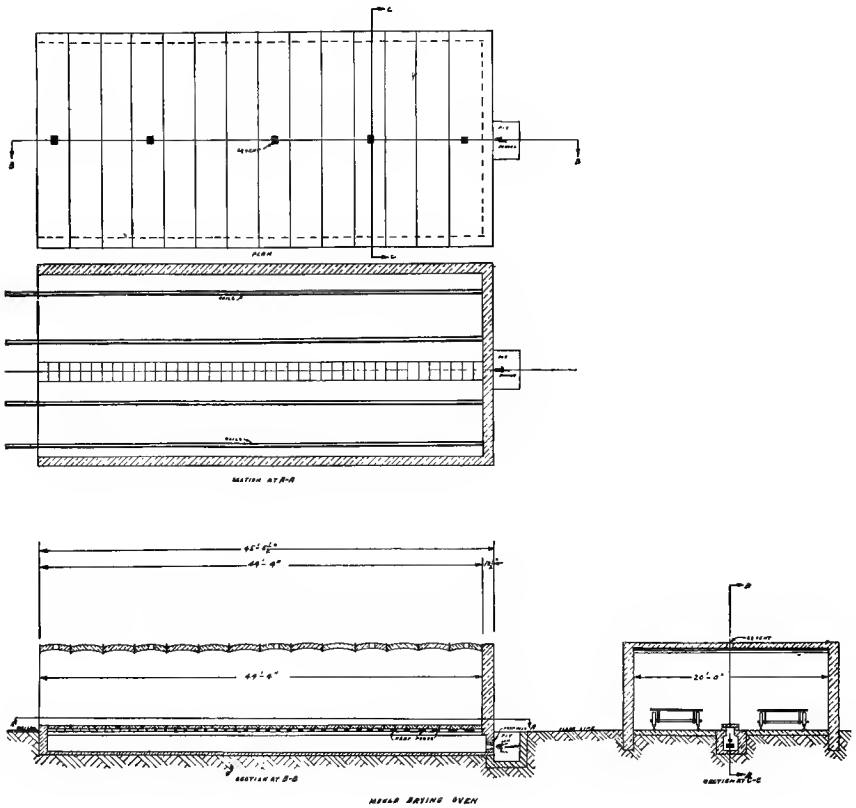

Fig. 143. Mould drying oven 44 feet long, 20 feet wide by 12 feet high in the clear, operated with one burner.

Chapter XII

HEAT-TREATING FURNACE PRACTICE

In the heat-treatment of steel we must remember that the value of the steel depends wholly upon the heat-treatment which it receives. Steel is not like copper, but is a very complex artificial

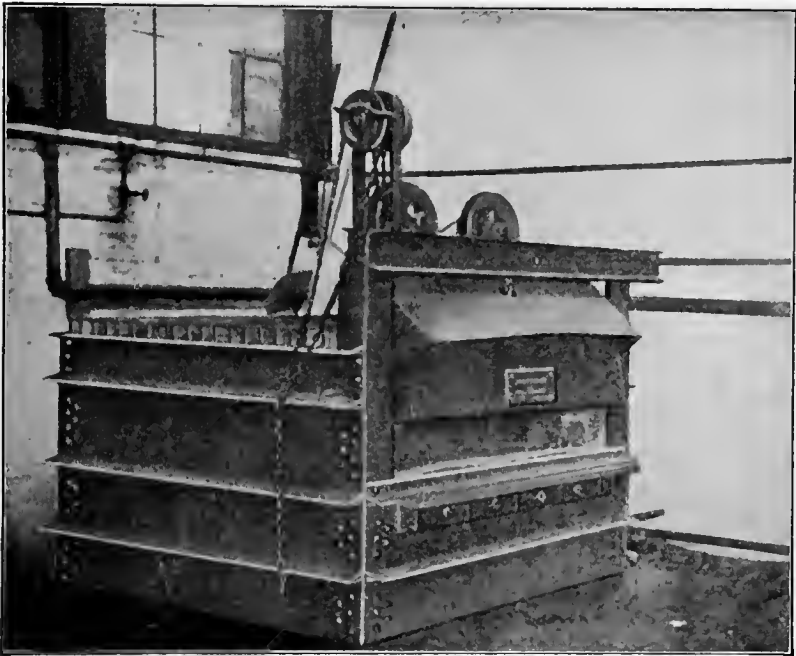

Fig. 146. An indirect-fired furnace.

product. In its annealed state a piece of .90 carbon tool steel is composed of ferrite and pearlite, but these minerals are decomposed when heated to certain temperatures and others formed. For example, in heat-treating this tool steel there is no perceptible

change until 1360 Fahrenheit is reached; but if the temperature is increased to 1460, ferrite and pearlite have been decomposed and martensite is formed. Quenching at this point preserves the martensitic condition and the metal is hard and brittle. In carbon steel, martensite is very sensitive to heat and decomposes readily, i. e., if the steel is heated sufficiently martensite disappears and



Fig. 147. View showing the heat in an indirect-fired furnace passes from the heat chamber through graduated heat ports.

ferrite and pearlite are again formed. For every variation of heat there is a variation in the grain of the metal. This steel anneals between 1300 and 1350 degrees Fahrenheit.

How important it is, therefore, to have a furnace of such construction that the temperature in any portion of the charging space does not vary more than 10 degrees Fahrenheit.

For the average size indirect-fired furnace only one burner should be used, but for a furnace approximately 18 feet wide, 22 feet long x 7 feet high (Fig. 151), two burners are required. More than two burners should not be used, for it is impossible to regulate a larger number of burners so as to have the heat as evenly distributed throughout the entire length and width of the furnace as it should be in order to perfectly heat-treat the metal. If this is important in the annealing or tempering of steel, it is equally as essential in the case-hardening of metals.

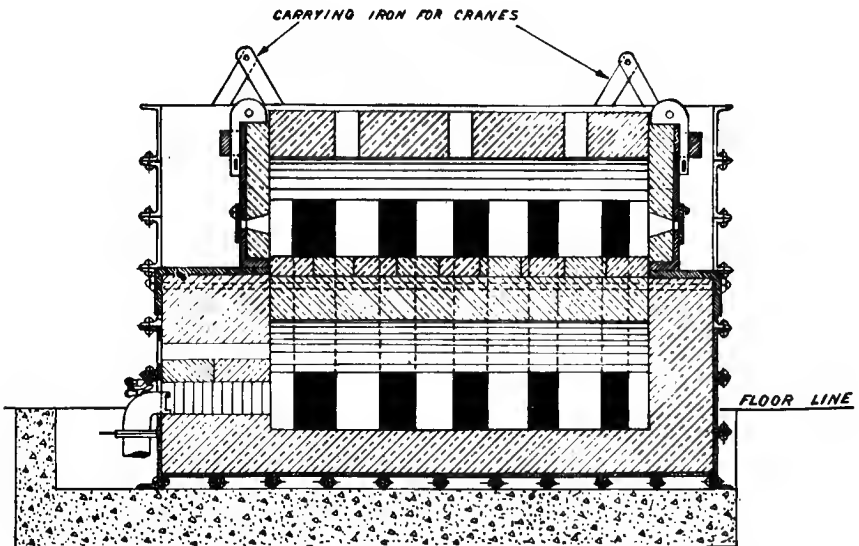

Fig. 148. View showing heat ports of an indirect-fired furnace.

An indirect-fired furnace is not suitable for the heat-treatment of high speed alloy steel, for this requires a much higher temperature than carbon steel. As the temperature should be above 2000 degrees Fahrenheit, I recommend a direct-fired furnace having combustion chamber of such form and proportions as to insure the ignition of the oxygen necessary for perfect combustion with the atomized fuel before it reaches the furnace proper, thereby reducing the oxidation of the metal to the minimum.

Since it is true that the value of steel depends wholly upon the

BURNING LIQUID FUEL

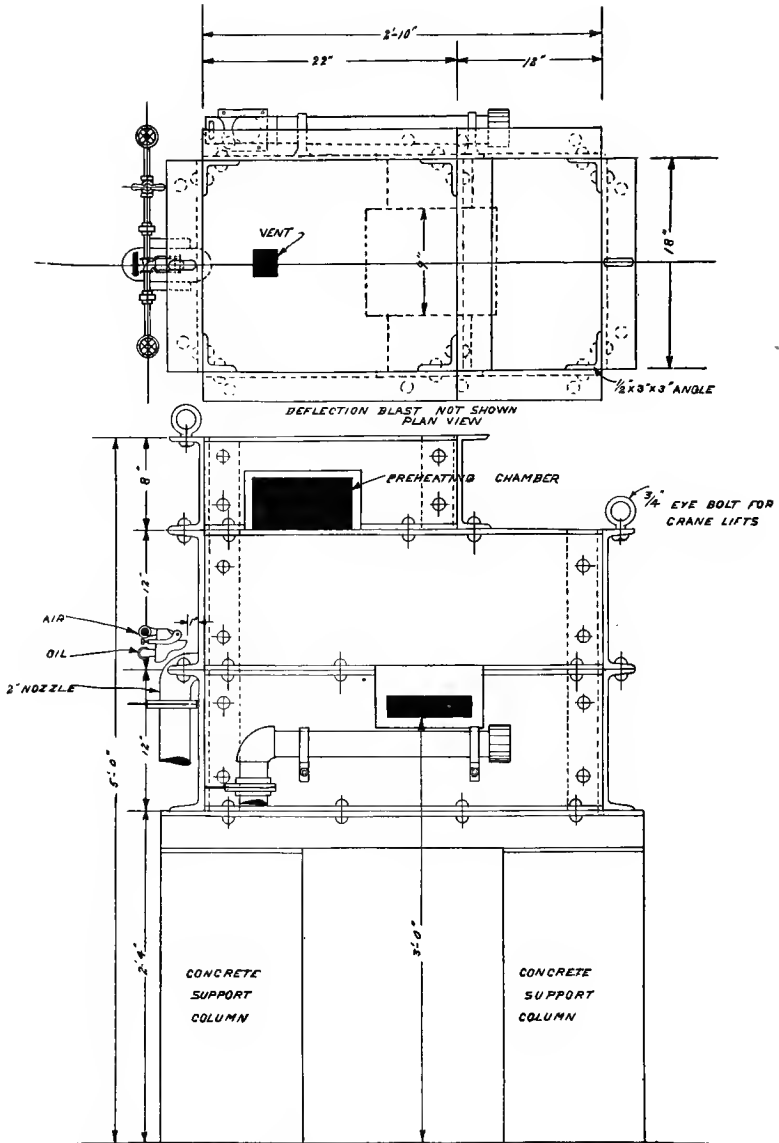

Fig. 149. Direct-fired furnace with preheating chamber for high-speed tool steel.

heat-treatment it receives, to obtain the desired results it is essential to establish and maintain an even temperature throughout the entire length and width of the furnace. For the heat-treatment of carbon steel, which requires an indirect-fired furnace, this can only be done by means of graduated heat ports. Only one burner

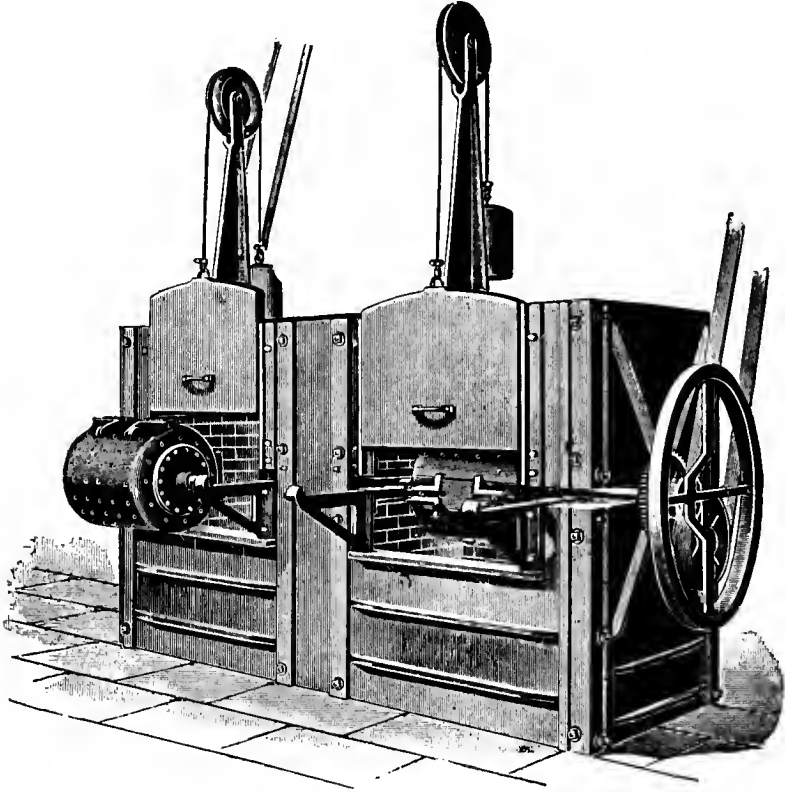

Fig. 150. Double shell annealing furnace.

should be used, the heat therefrom passing from the fire chamber into the charging space of the furnace through graduated heat ports substantially as shown in Fig. 148. As long as the fuel and atomizer supply remain constant, the burner, without any adjustment will operate without causing the slightest variation in the temperature of the charging space. This type of furnace should be

used for all classes of annealing, case-hardening and tempering where the metal must be kept away from the direct flame. The

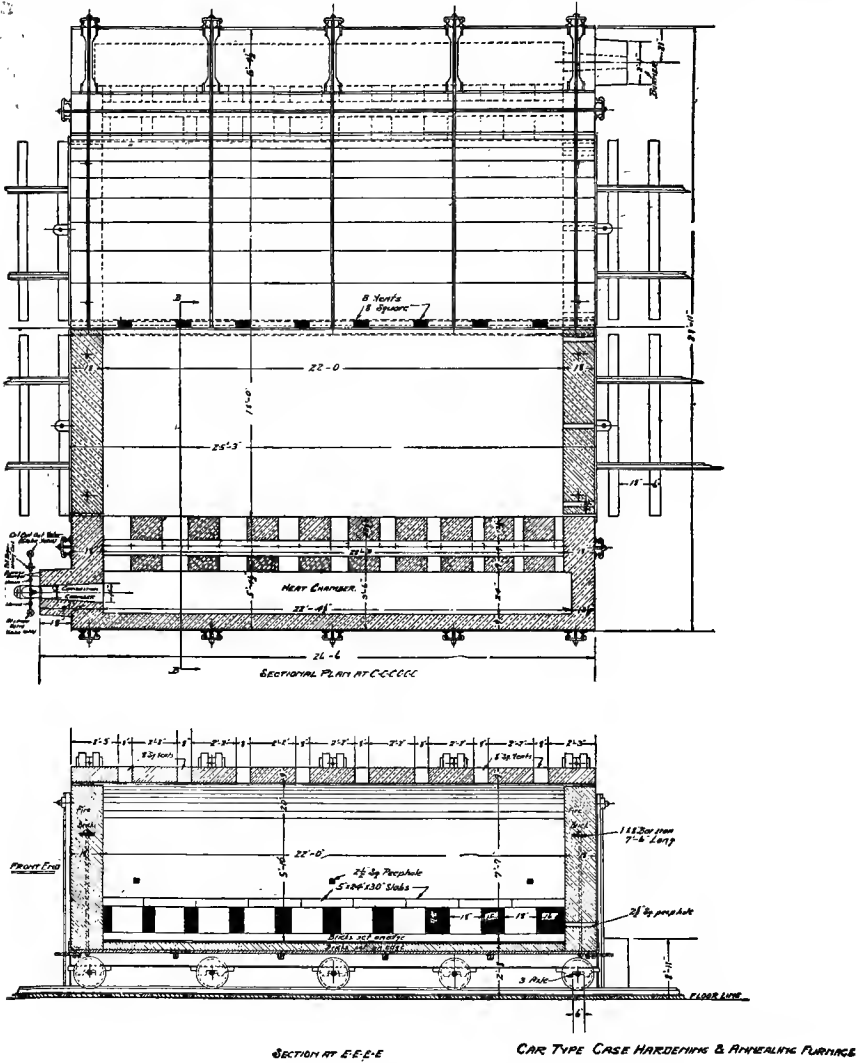

Fig. 151. Indirect-fired car annealing furnace.

size and the location of the heat ports is an engineering problem requiring most careful consideration. If they are not scientifically

and accurately proportioned the incoming air used for the atomization of the fuel or to support combustion will cause an excessive heat at the end of the furnace opposite the burner.

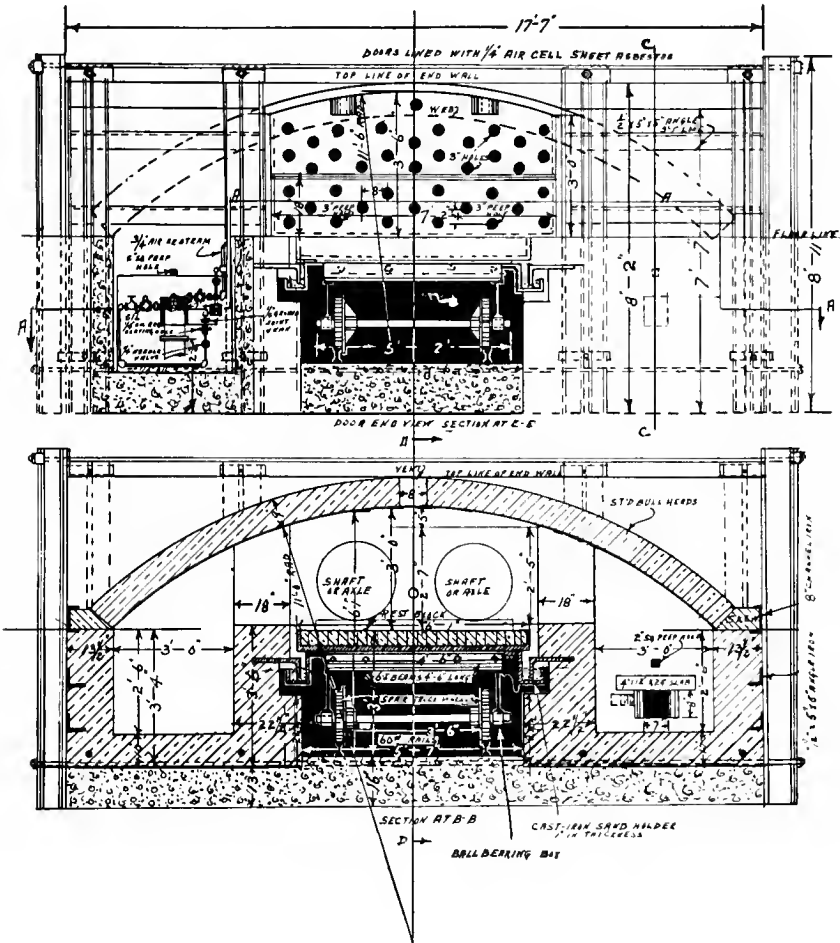

Fig. 152. Shaft annealing furnace, car type, modern construction.

For high-speed tool steel a direct-fired furnace is necessary. The more modern types have a preheating chamber above the charging space; the waste gases from the lower chamber passing up into the

preheating chamber slowly preheat the charge before it is passed into the furnace proper, thus preventing the too sudden expansion of the metal (see cut, Fig. 149).

Each of the two ovens of the double shell annealing furnace (Fig.

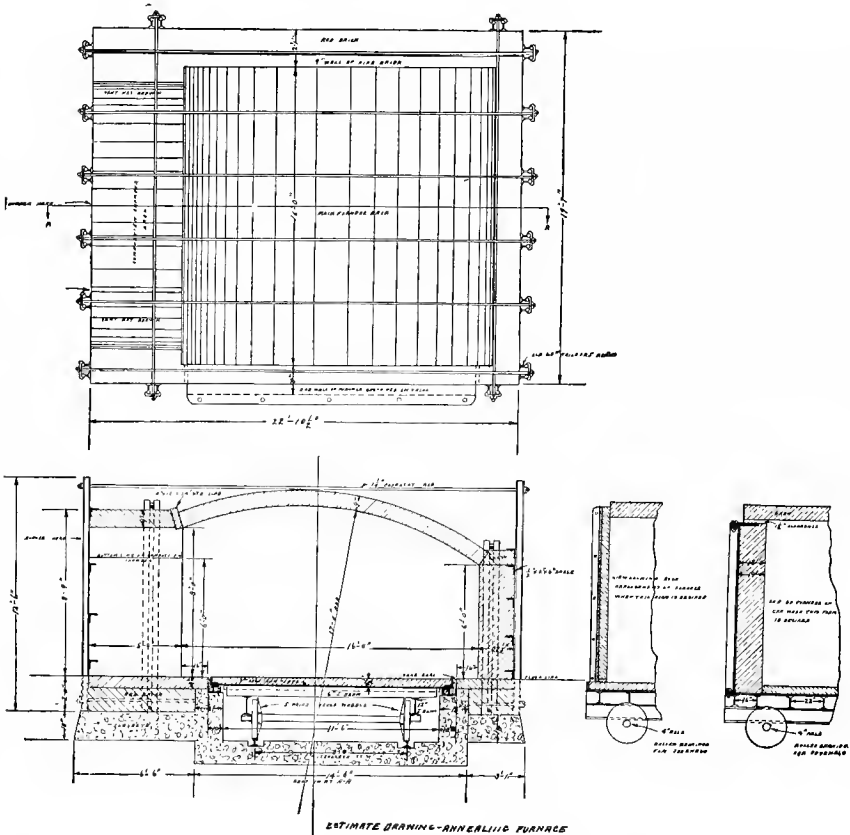

Fig. 153. Car annealing furnace, overhead oil-fired, operated with only one burner.

150) requires a burner. These ovens are heated from below and the perforated cast iron drums are revolved by power. The drums roll out on the brackets in front to charge or empty the shells.

The end walls of the double car annealing furnace shown in Fig. 151 are carried on the cars, so it is a very simple matter to pull

the cars in and out of the furnace. While two cars are being heat-treated, others are being filled and made ready for charging and in this way the furnace is operated continuously. This furnace requires two burners, one in each of the farther corners.

The car-type shaft annealing furnace (Fig. 152) is of most modern construction. It is so built that by means of the heat ports,

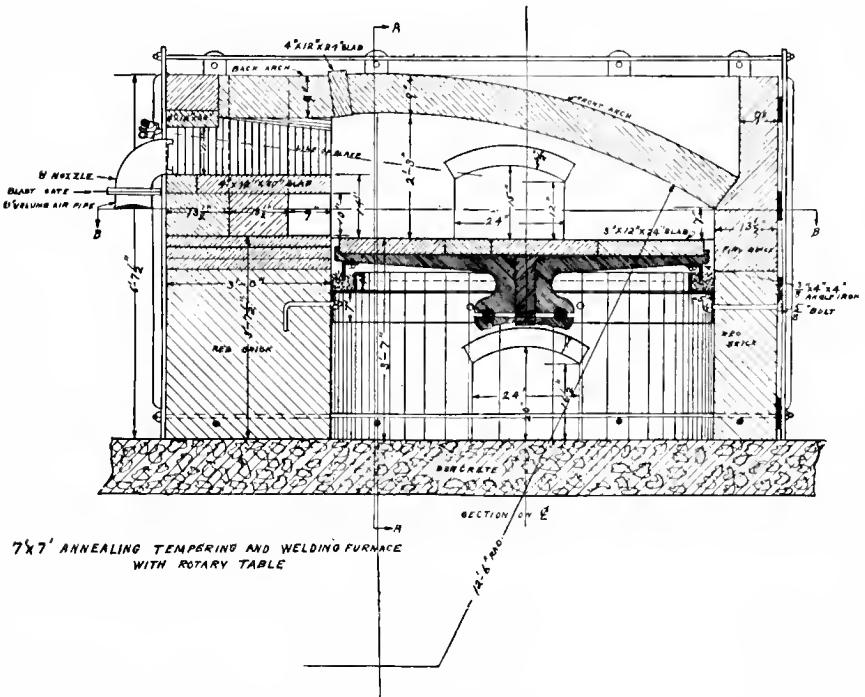

Fig. 154. Annealing furnace, 7 ft. square, with rotary table.

the heat is evenly distributed. It can be operated to maintain the temperature required at all times and that temperature will not vary more than ten degrees in any portion of the entire length and width of the charging space.

By means of differential gears the speed of the rotary table shown in Fig. 154 is regulated according to the size of the stock being

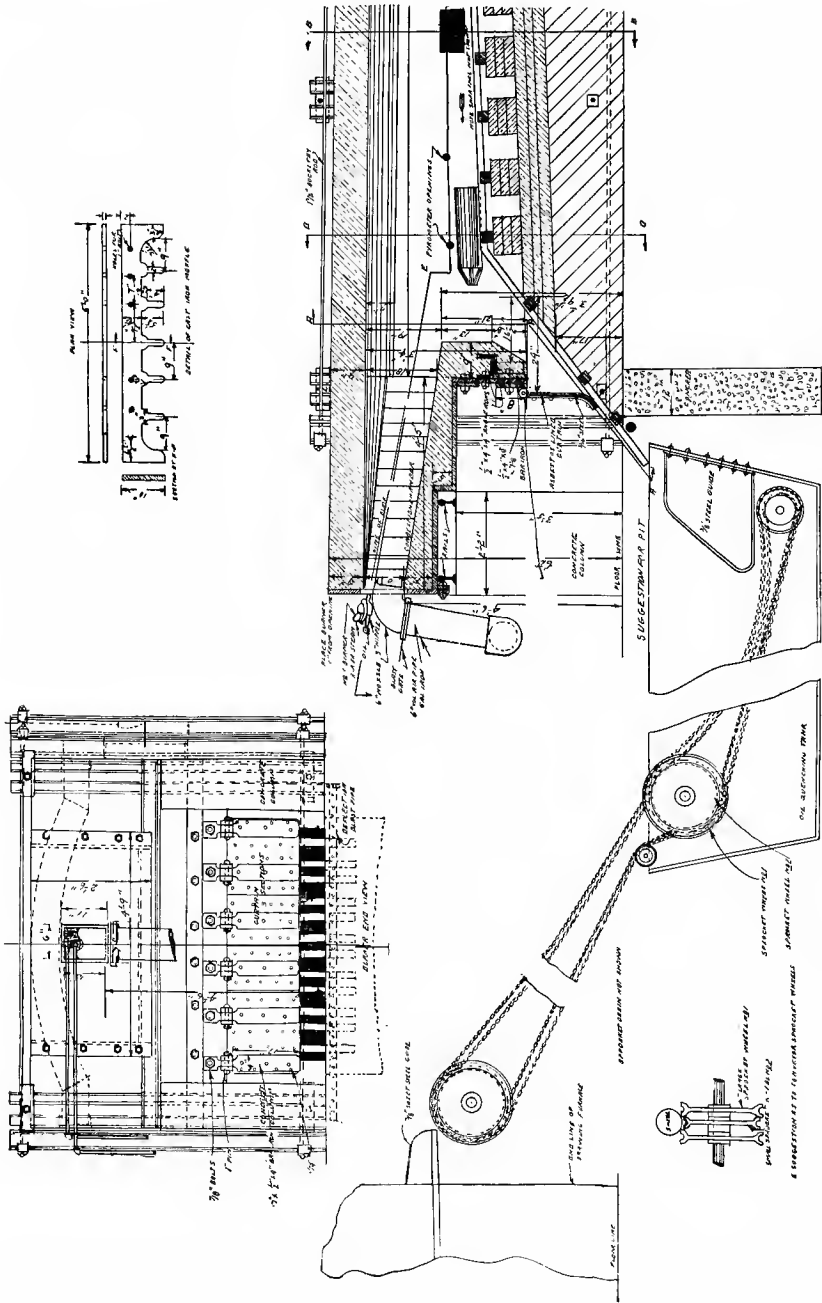

Fig. 155. Equipment of heat-treating furnace for 155mm. shells.

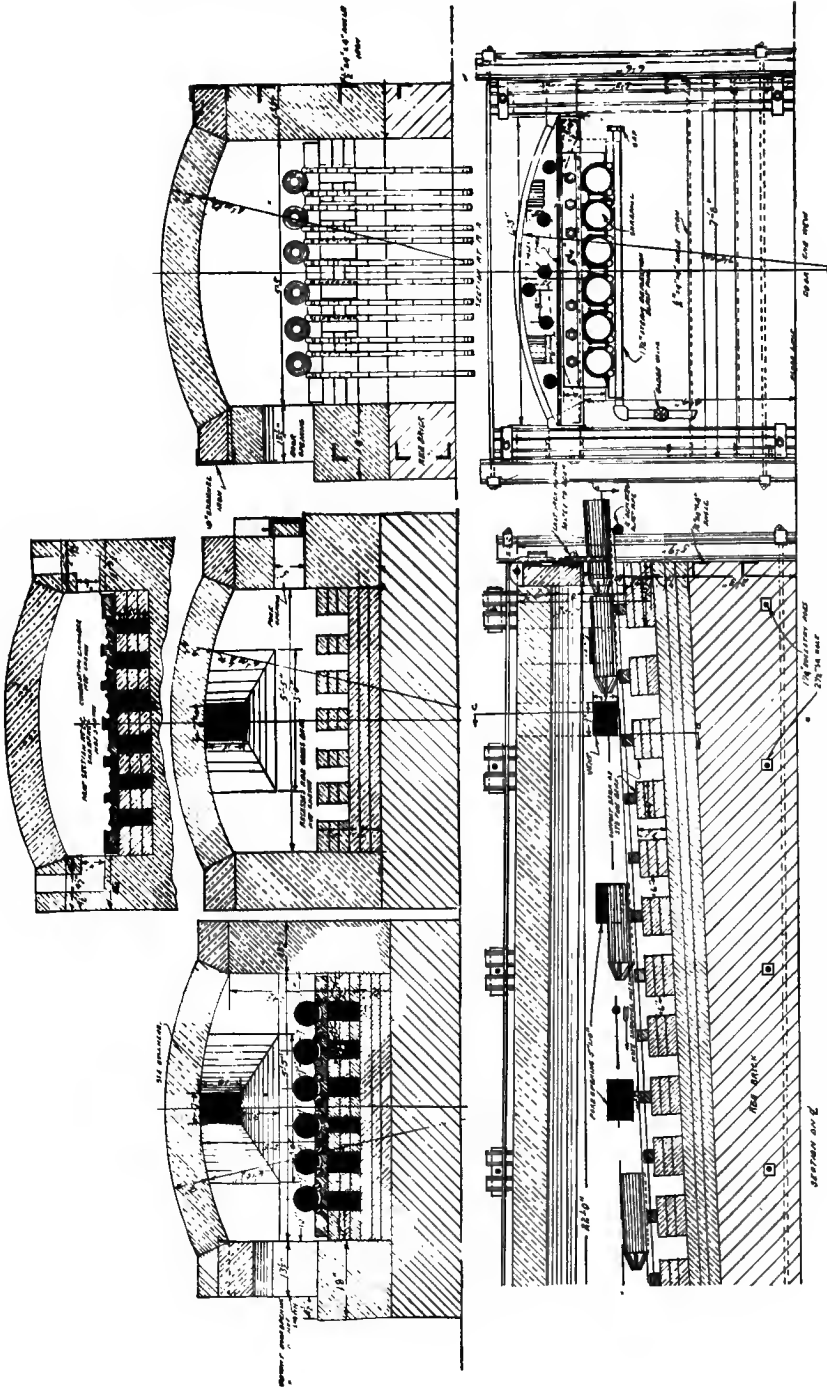
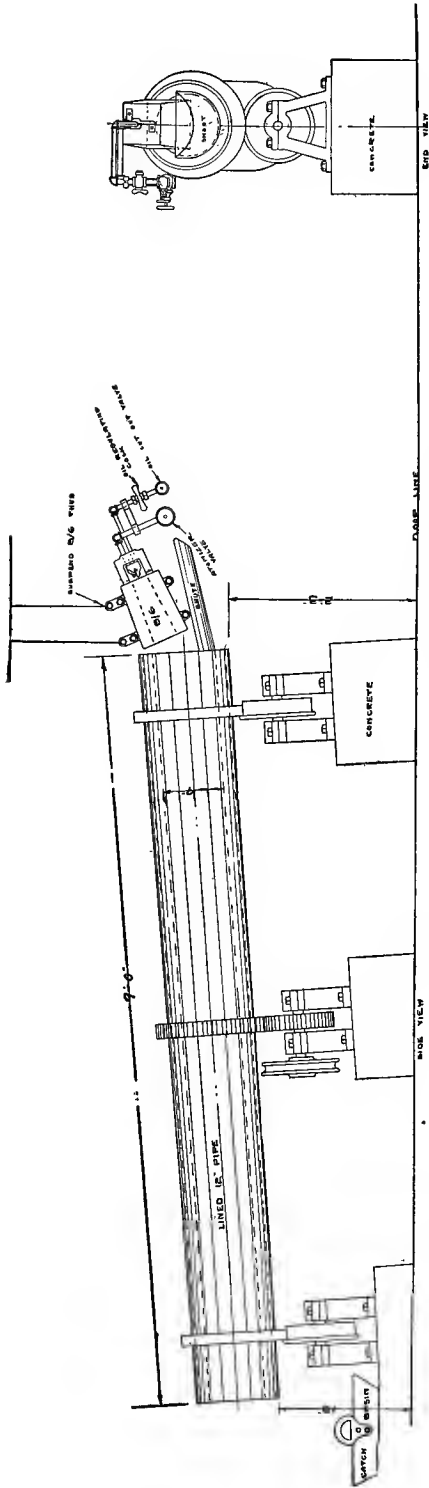

Fig. 156. Views showing how the shells are passed through the furnace.



EQUIPMENT ROTARY ANNEALING FURNACE

Fig. 157. Rotary furnace for annealing cold punched nuts or cold headed rivets and bolts.

heat-treated, so that when the table has made one revolution, the charge is ready to be removed from the furnace.

By means of either an air jack or a hydraulic ram, the 155mm. shells, placed one against the other, are forced down the ways as

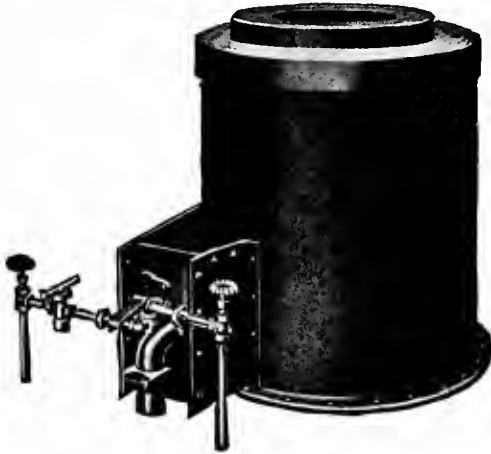

Fig. 158. Lead, oil or solution bath furnace.

indicated in Figs. 155 and 156. They are heated as they pass through the furnace and after attaining the required temperature, they automatically drop into the bath. From this bath they are carried into the drawing furnace, which is immediately opposite the heat-treating furnace in which they were subjected to the higher temperature. Only one burner is required on this heat-treating furnace, the combustion chamber being of adequate proportions for the consumption of the atomized fuel and the even distribution of the heat.

The cold punched nuts or cold headed rivets and bolts are charged into the chute at the burner end of the rotary furnace shown in Fig. 157 and annealed while passing through the revolving furnace. They then drop into the hopper, placed under the farther end of the furnace.

The type of furnace shown in Fig. 158 is used in the heat-treatment of steel because it reduces oxidization to the minimum. The

pot or receptacle used for the bath may be round or oblong or whatever shape and size is most desirable. The tangential flame encircles the pot so that the heat is evenly distributed. The operator has the fire under perfect control and can attain and maintain the temperature required to perfectly heat-treat the metal. After once being set, the burner will operate continuously without the slightest variation as long as the oil and air supply remain constant. The burner requires either crude or fuel oil and compressed air. Volume or fan air should be used through the volume air nozzle under the burner.

For temperatures up to 1600 deg. Fahrenheit, lead is sometimes used as the bath and it is also sometimes used in drawing steel at

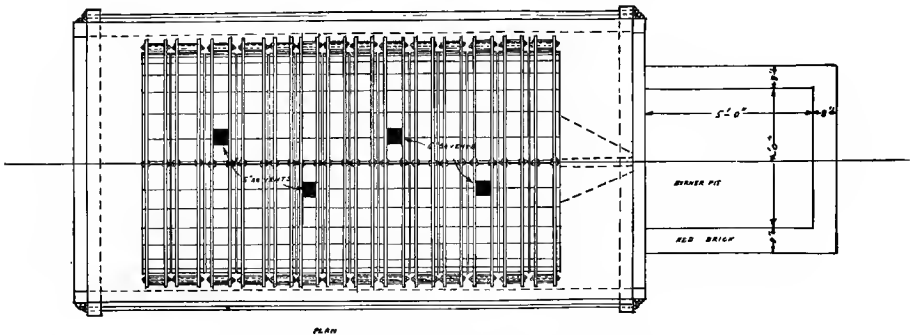

Fig. 159. Semi-pit furnace with bung arch for annealing, case-hardening or heat treating.

700 deg. For a solution bath for temperatures ranging from 1400 to 1600 deg. a good mixture is three parts Barium Chloride and two parts Potassium Carbonate. Where a very low temperature is required, Sodium Silicate is used as the melting point of this is 113 deg. Fahrenheit. Sodium melts at 572 deg. and Zinc at 504 deg. Fahrenheit.

The bung arch on the Semi-pit Furnace (Fig. 159) can be removed with a crane or an air hoist. The charging space of this furnace is twelve feet long by five feet wide and four feet high. It is operated with only one burner.

Many manufacturers prefer to have their furnaces constructed in their works by their own or a local mason. They usually pur-

chase the furnace designs, together with the oil burner equipment from engineer in that line of business. The small angle or heat-treating furnace of semi-

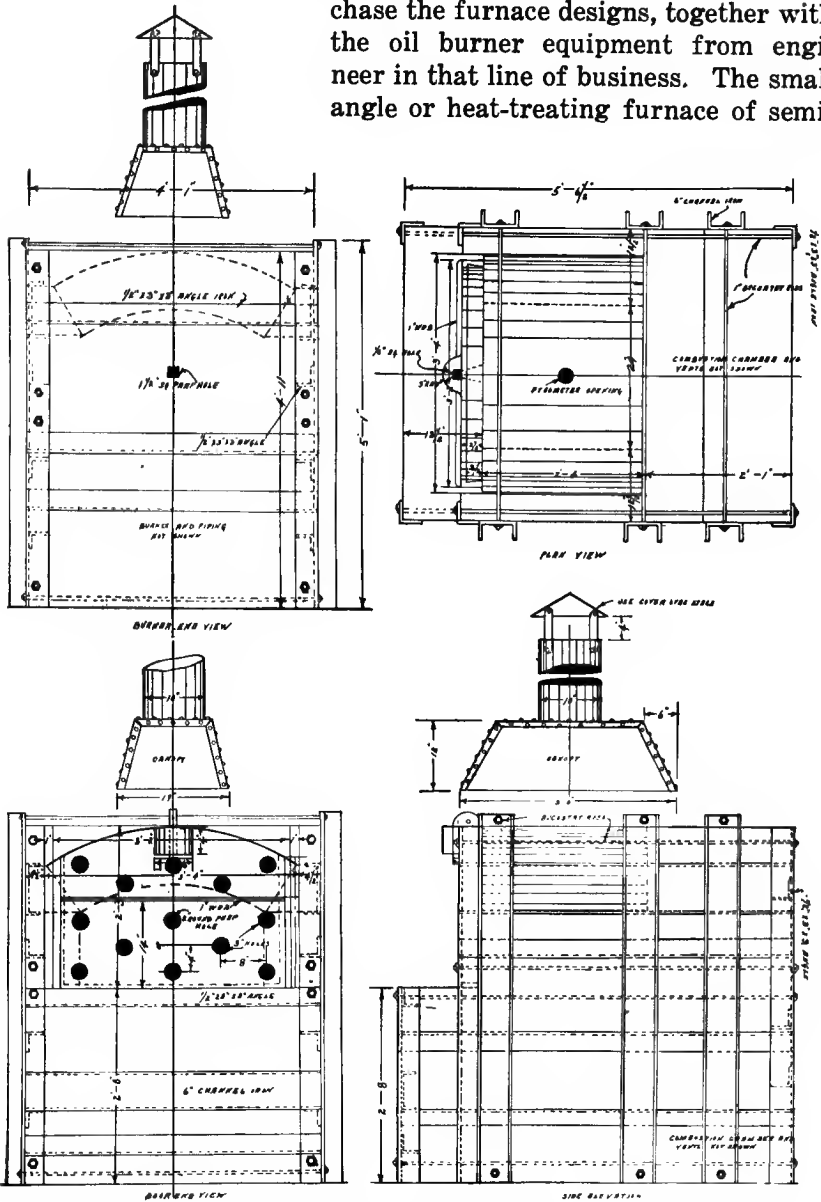

Fig. 160. Small angle or heat-treating furnace of semi-muffle type.

muffle type, shown in Fig. 160, is one which can readily be constructed in this manner and is a very well proportioned furnace for a small plant.

The pit type furnace for steel foundry castings (Fig. 161) is sixteen feet wide, twenty-four feet long and six feet four inches to the bung, is operated with only one burner and is of such construction that the waste gases pass out from the base of the furnace through vent ports.

It is often necessary to change a coal or coke-fired furnace to oil-fired. In many cases this can readily be done by simply constructing a combustion chamber in the firebox and bricking up the firing door as shown in Fig. 163.

A few years ago but little attention was paid to the annealing of grey iron castings. However, experience has taught us the necessity of removing as far as possible all strains from these castings. The declined hearth furnace (Fig. 164) has been constructed for the annealing of various sizes of cast iron pipe. The arch is provided with two doors (located, one on either side of the burner) which can be raised just sufficiently to admit the various sizes of pipe.

In Fig. 165, we have a battery of three furnaces for heat-treating automobile springs. First, there is the high temperature furnace in which the stock is charged before being bent. Number two is the heat-treating furnace in which the flat springs, after being bent, are charged and heated to approximately 1640 deg. Fahrenheit. The quenching tank is not shown, but after being quenched, the springs are charged into furnace number three where they are drawn to 680 deg. This battery of furnaces is ideal for a repair plant but of course it is at all times necessary for the plant metallurgist to determine the temperatures required as these will vary according to the carbon content of the steel.

The use of hot-air furnaces for drawing steel (Fig. 166) has had a remarkable growth during the past two years, because they are clean and admirably adapted for the distribution of heat. Moreover they can be located in a small building some distance from the factory if desired, or they can be installed in the basement or in any other portion of the building or factory. There is no fuel superior to oil for this class of service.

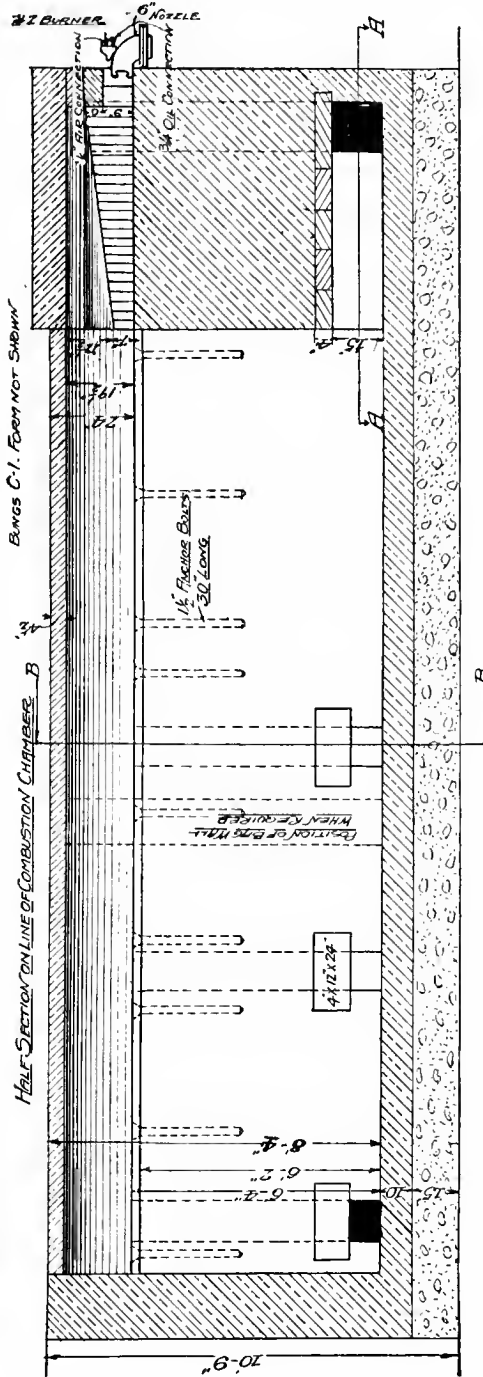

Fig. 161. Pit furnace for annealing steel foundry castings.

I hope I have made it clear in the heat-treatment of metals of the need of the following:

1st—The combustion chambers must be of adequate proportions to deliver the quantity of heat generated in them to the furnace

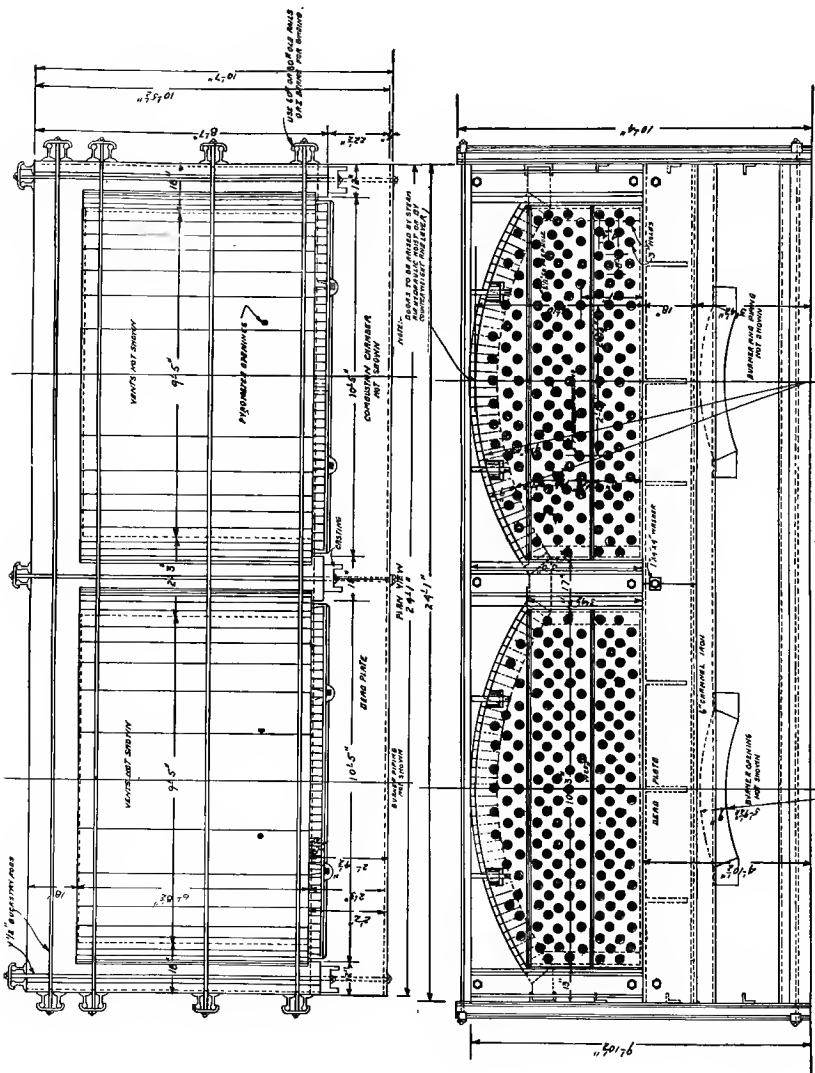

Fig. 162. Twin type, indirect-fired heat-treating furnace.

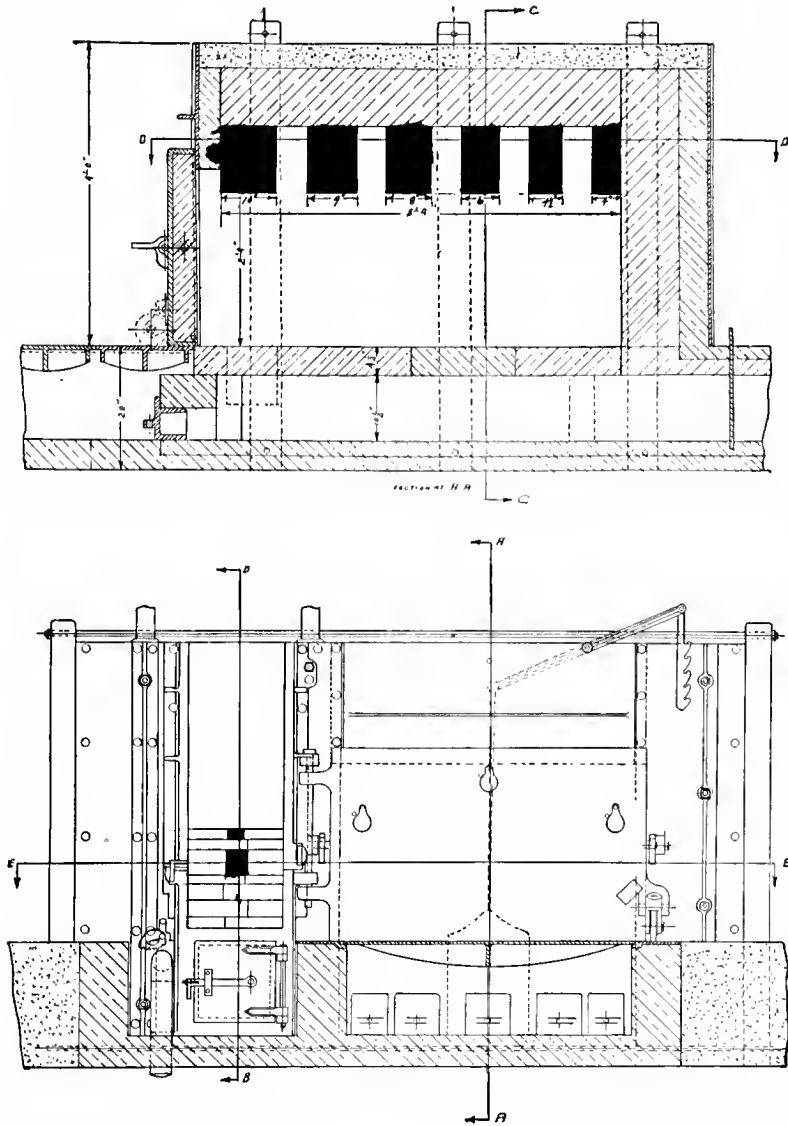

Fig. 163. Coal or coke-fired heat-treating furnace changed to oil-fired.

proper, and by the aid of the burner given even distribution of heat throughout the entire length and width of the furnace.

2nd—The burner must produce a flame which fits the combustion chamber perfectly, — as perfectly as a drawer fits its opening in a desk.

3rd—The use of the minimum number of burners in a furnace.

I have no patience with that type of engineering which will put say six burners on one side and eight burners on the other side of a furnace, and if that does not give the required temperature, put in some more burners. That is mere guesswork—not engineering at all!

The combustion engineer who, knowing the era of a heat-treating furnace, and who, after having been given information by the metallurgist of the plant as to the length of the metal to be charged into the furnace, weight of same, and the length of time this metal is to remain in the furnace, cannot figure the amount of oil and amount of air required to bring that metal to the required temperature within a given length of time, is not

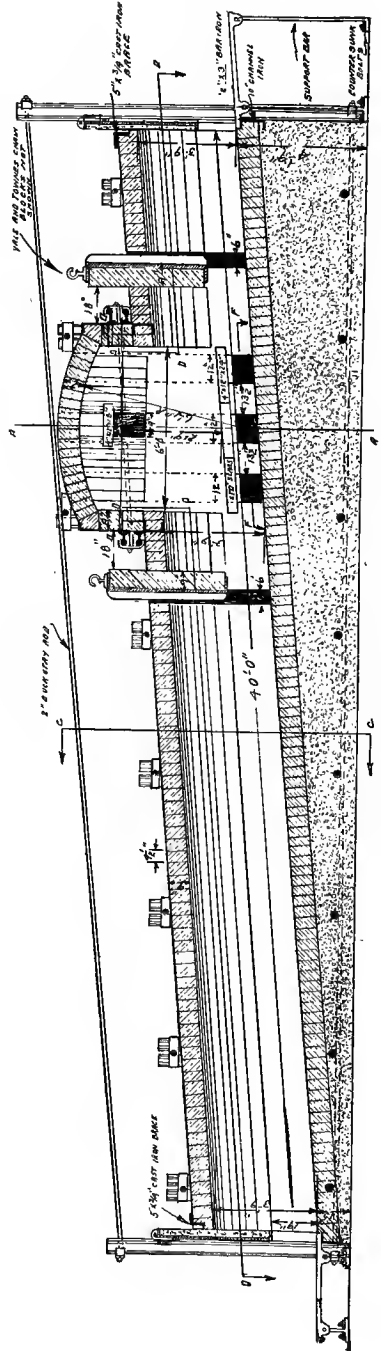

Fig. 164. Declined hearth annealing furnace for heat-treating various sizes of cast iron pipe.

worthy of the name of "combustion engineer". He is a leech, yes, an enemy of society. He is like the so-called engineers who strive to obtain a great deal of information from a practical engineer, and then sell that information to an unsuspecting client. I have no patience with such enemies of society, nor would I allow them their liberty in any State in the Union if I had my way.

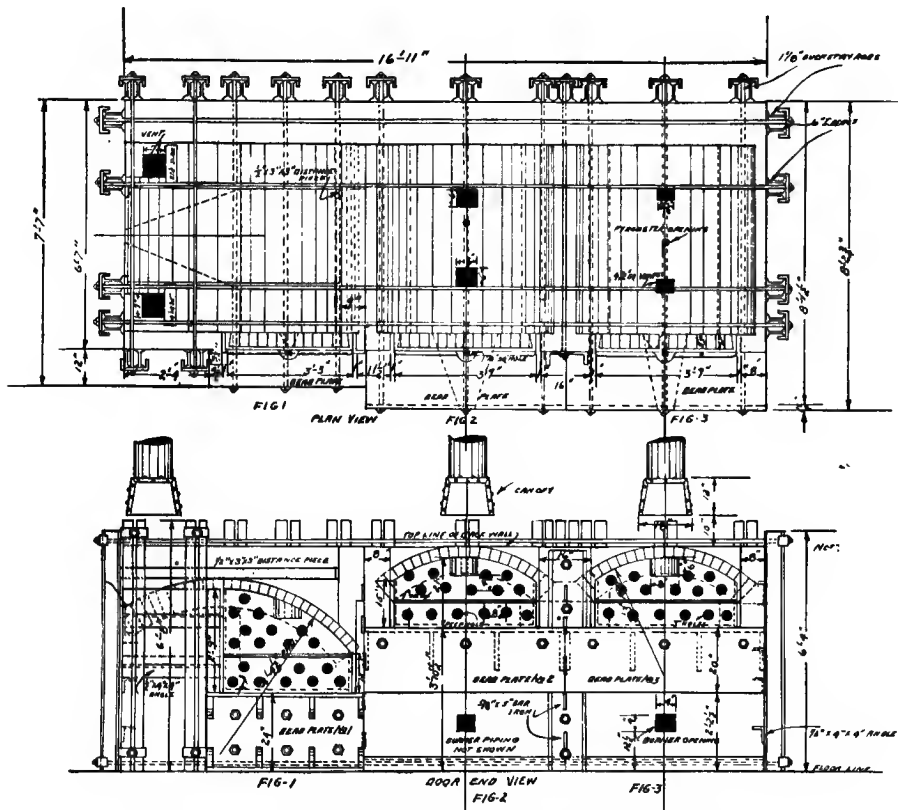

Fig. 165. Battery of three automobile spring heat-treating furnaces.

To-day an engineer must know his business. He cannot apologize for anything, for knowledge is power and his power depends upon his practical knowledge which he gives his client to benefit the world. The man who does not make his contribution honestly should not live. He should be a benefit to the world in his chosen profession,—not a curse.

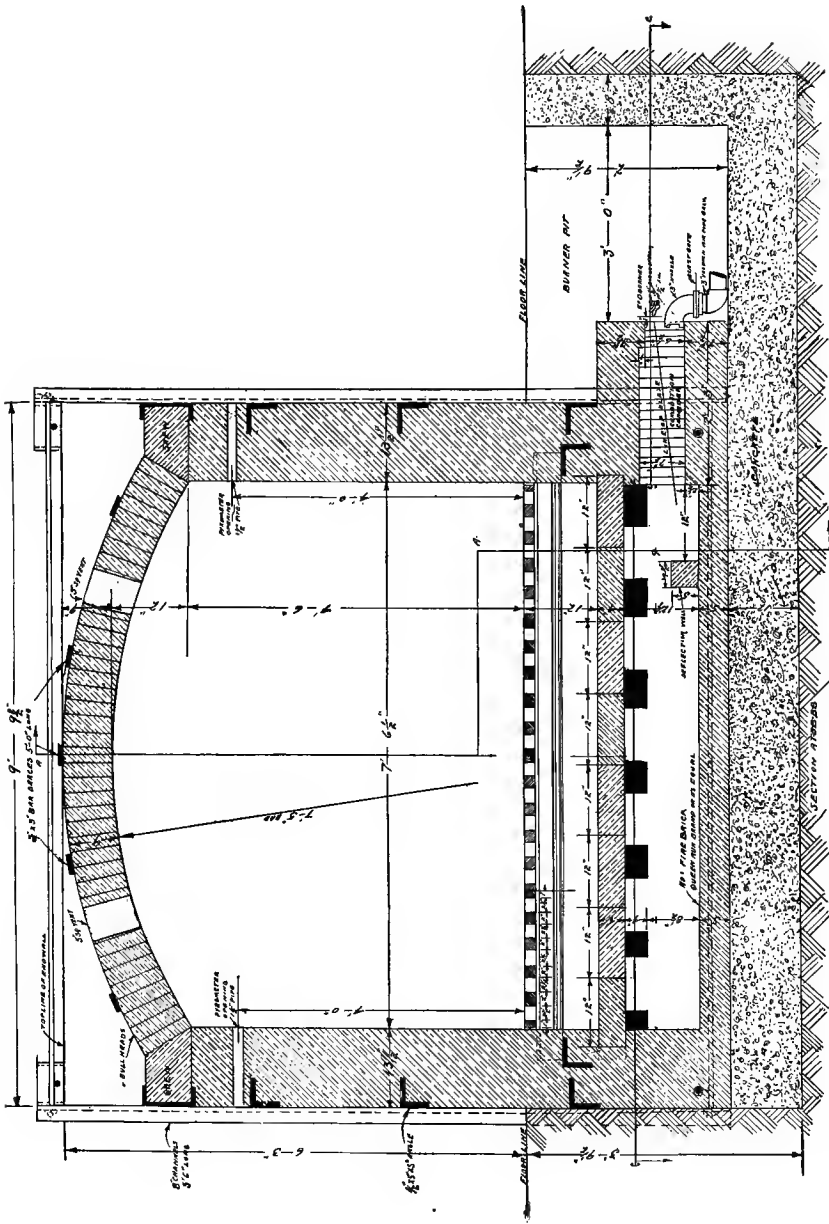

Fig. 166. Hot-air furnace for drawing steel.

There are a great many people who can write articles or treatises on how to weld two pieces of metal together, but were they asked by their clients to make a weld they would fail miserably. The average manufacturer who desires to remain in business for any length of time and who wants the assurance of being able to continue to prosper, needs men who can demonstrate the truth of their statements and who can prove their premises rather than merely give theories.

Chapter XIII

MALLEABLE IRON, GREY IRON AND BRASS FOUNDRY PRACTICE

Many attempts to burn liquid fuel in Air Furnaces have failed because of the operator not being able to melt the full charge or to get the metal as hot as when burning coal. Often the charge was oxidized to such extent that what metal did become molten was practically worthless. Usually a number of burners, each giving a round flame, have been placed in the side-wall of the furnace, and as the number of burners was increased the equipment became more and more intricate. Something had to take the blame for the wasted time, material and effort, so oil was condemned as being unworthy of further consideration.

As oil has a much higher calorific value than coal the natural conclusion is that it ought to be able to melt the metal in a much shorter period of time. Not only that, but it should also be able to bring the metal to the temperature required for even the smallest castings. It can do both if properly applied, and, furthermore, the quality of the metal is improved, for by chemical analysis and numerous tests it has been found that the castings contain no more sulphur than the metal did when charged into the furnace, and the tensile strength is consequently greater than that of metal melted by coal fire. As the melter has the furnace under perfect control the heats can be taken off much quicker than while burning coal and the temperature of the charge while being tapped can be maintained without varying more than 25 degrees Fahrenheit until all the charge has been run from the furnace. The operation of skimming is materially decreased—this is a very noticeable improvement which is especially appreciated by the melter. The high calorific value of oil also enables the melter to estimate within a few minutes the exact time when the charge will be ready to tap, which is a great contrast to conditions while burning coal, especially in rainy weather, when climatic conditions are unfavorable and the stack draft is materially affected.

The change from coal to oil is a very simple matter. In the

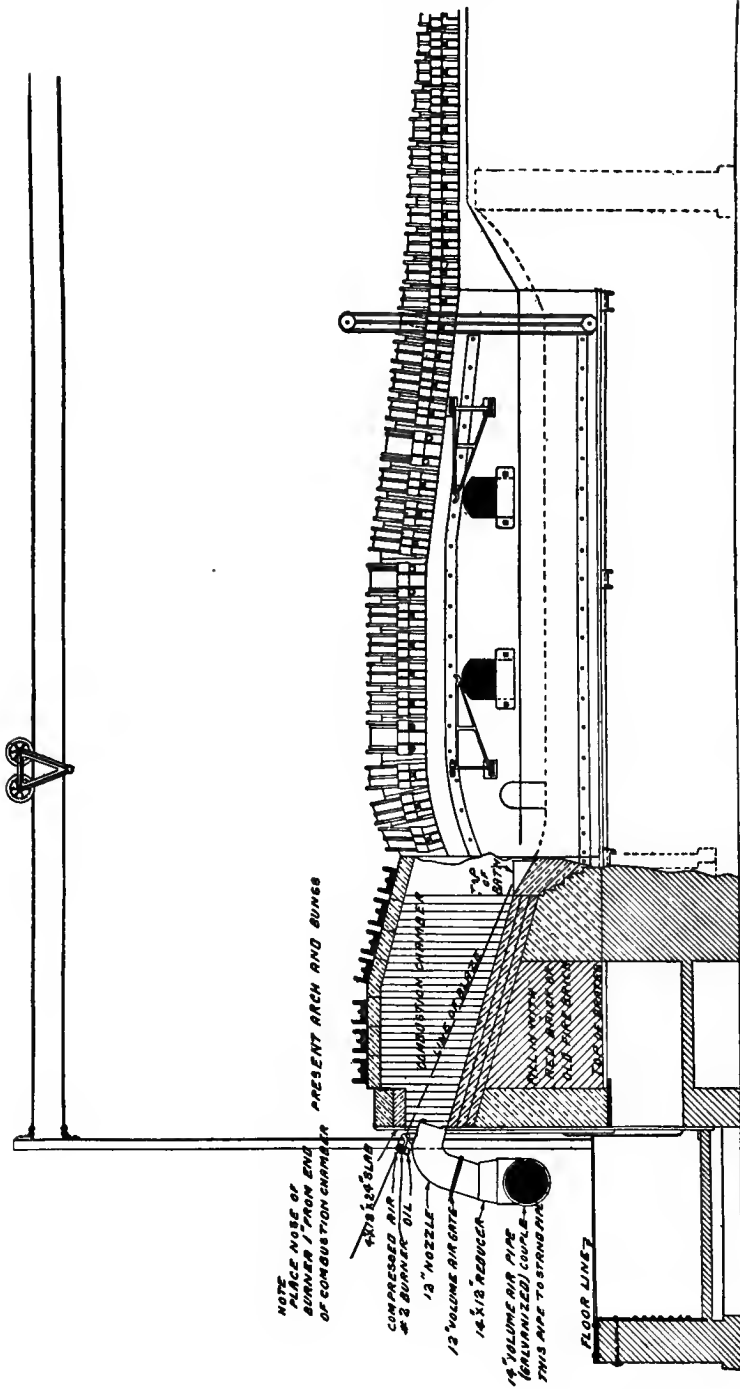

Fig. 169. Twelve-ton air furnace, changed from coal to oil-fired and operated with one burner.

BURNING LIQUID FUEL

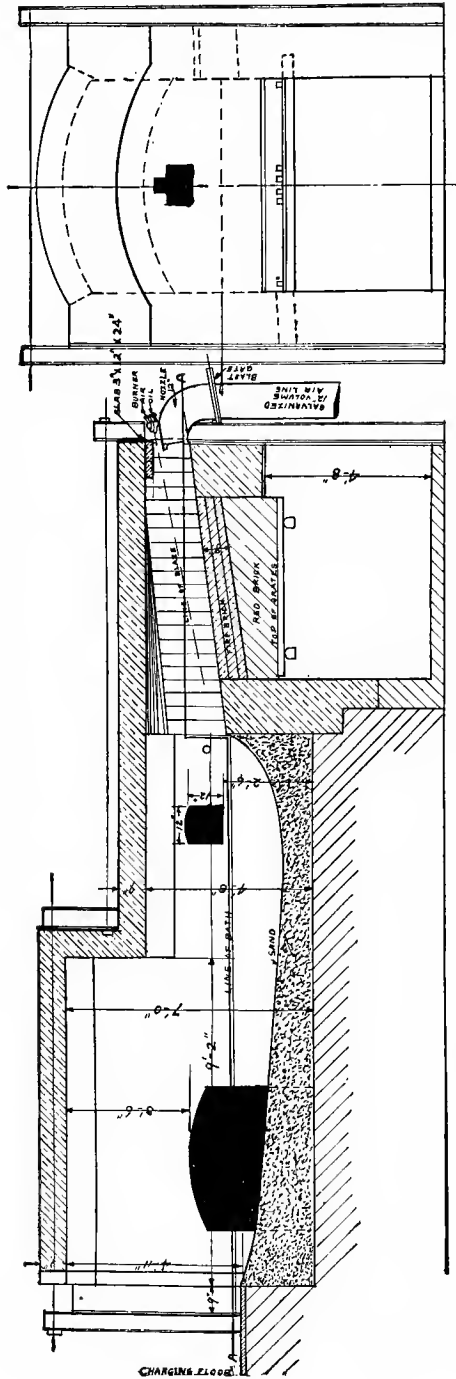

Fig. 170. Air furnace of the type used in foundries where rolls are made.

original fire-box I construct a combustion chamber of such form and proportions that the air necessary for perfect combustion can unite with the atomized fuel before it reaches the furnace, which prevents oxidization of the charge. Also this chamber causes the heat to be deflected upon the entire surface of the bath. In the end of the combustion chamber I place a hydro-carbon burner which makes a fan-shaped blaze, filling the entire chamber with flame. A very small quantity of compressed air is used through the burner to atomize the fuel and distribute the heat, while the balance of the air necessary for perfect combustion is supplied at from 3 to 6 ounce pressure through a volume air nozzle.

The furnace is charged in the usual manner. The burner is started by opening the air valve, holding a piece of burning waste (which has been well saturated with kerosene) by means of a pair of pick-up tongs under the burner and then turning on the oil. The operation is so very simple that one must see it in order to appreciate that you can get as intense heat with it in a few minutes as from burning coal for several hours.

The reduction in the time required to get the charge ready for tapping is not the only point wherein oil is more economical than coal. There is no handling of fuel and ashes, consequently the services of the fireman and coal passers are dispensed with. There is great saving in floor space, for the oil tank is placed underground and the former coal bins used for other purposes. The fire-brick lining of the furnace lasts 20 per cent longer than with coal. Poor castings or imperfect ones caused by the metal being cool or sluggish are obviated entirely, for with liquid fuel the question is not "How hot can you make the metal?" but "How hot do you wish it?" All these items should be taken into consideration when comparing the relative costs of using oil and coal in air furnaces.

During years of close observation I have particularly noticed one point in this class of service. It is this. Using the combustion chamber herein described, a burner giving a flame to fit this combustion chamber and admitting volume air through an air nozzle located below the burner insures not only the hottest portion of the furnace being where it is most needed, viz.: the bath or charging space, but also the elimination of the detrimental effect of any sulphur which may be in the oil or tar. This is accomplished with this construction for the following reason,—the air admitted between the flame and the bath or charge must pass through the

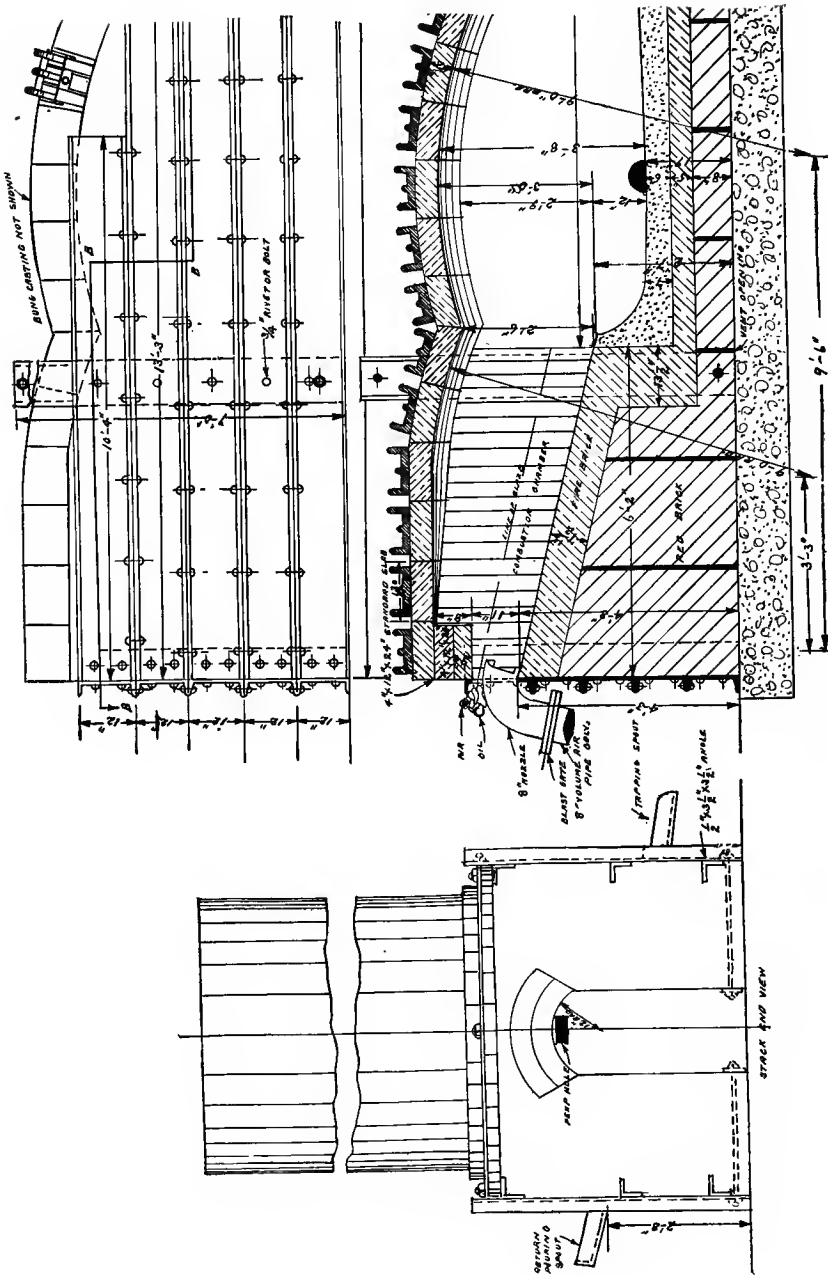

Fig. 171. Air furnace with bung top, used in the melting of grey iron.

atomized consuming fuel and thus the sulphur is consumed before it reaches the furnace proper. The gases rising therefrom being lighter quickly ascend to the arch of the furnace. If, however, the air is admitted around the burner or above the burner, and no combustion chamber is used, the sulphur is not consumed in the manner above described, but is absorbed by the metal.

Strange to relate, the first air furnace in which oil was successfully burned was located on the identical spot where the first malleable iron was made in the United States by Seth Boyden at 28 Orange Street, Newark, New Jersey.

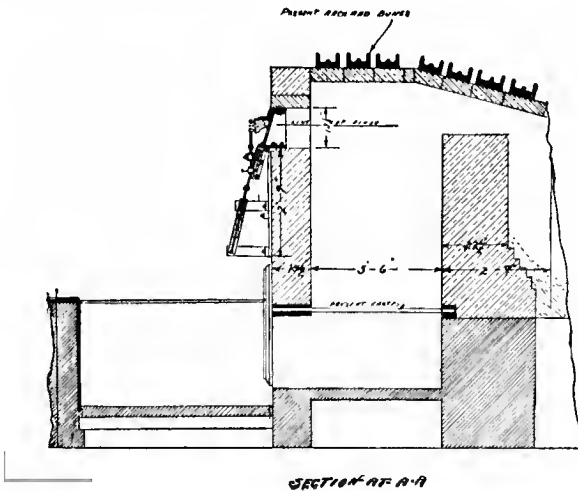

Fig. 172. Fire-box of air furnace equipped with liquid fuel injecting apparatus.

Figure 170 shows an air furnace such as is used in foundries in which rolls are made. The rolls are rolled in at the end door of the furnace when it is cold. The doors are then mudded up so that the furnace will be hermetically sealed, and the burner operated. Oil in this practice has many advantages over other fuels owing to the fact that the temperature of the metal may be maintained at all times, which is very important in this practice. Of course pyrometers should always be used on the furnaces, as it is very important that the metal does not become too hot before being poured into the molds.

Air furnace with bung top (Fig. 171) for melting grey iron. With this construction the oxidation of the metal is reduced to the minimum, and since it is a fact that variations of 400 to 500 degrees Fahrenheit make a different metal, it is very important to use an optical pyrometer upon these furnaces. It is a well-known fact that by varying the temperature of grey iron 200 degrees Fahrenheit you make a new metal. It is therefore important to have all portions of the bath at practically the same temperature. This can be effected in an air furnace because immediately after the metal has become molten it reverberates and is kept in a constant state of agitation until ready to pour.

Some day not far in the future oil will find its place in every grey-iron foundry in the United States. At present cupolas are used, but every one realizes that cast iron belongs to an unruly family and that it is materially affected by high or low temperatures. Again, the oxidation of the metal in coke-fired cupolas is excessive; but with an air furnace or other types of oil furnaces oxidation is reduced to a minimum; the temperature of metal desired can be attained and maintained without variation from day to day regardless of climatic conditions, etc. I have prophesied that there is a great future for oil in this particular service, but like every other new idea it takes time and thought to fully develop it.

The liquid fuel injecting apparatus is sometimes used in air furnaces in which coal is used as a fuel. The oil is used in combination with the coal in order to bring the temperature up as quickly as possible. The apparatus is placed on the end of the furnace, substantially as shown in Fig. 172.

In the design of a furnace for the melting of malleable iron it is absolutely essential to have the combustion chamber of certain proportions in order to insure the consumption of the atomized fuel before reaching the bath, for if any unmixed air is admitted into the melting zone of the furnace it means not only loss of metal by oxidation, but also the burning out of the silicon in the metal.

I know a great number of experiments have been made in the equipment of malleable iron furnaces using oil burners that make a round flame, and also using a number of these burners; but practice shows the fallacy of using such nefarious methods. If a man were to state to you that he could send you a round drawer that would fit an oblong opening in your desk, you would know he was lying to you, and such is the case if some one tells you that

he can make a round flame fit a flat surface. We have had a great deal of experience in this line. Also if the writer has ever learned anything after 30 years' experience in the burning of liquid fuel it is that it is absolutely essential to have a combustion chamber on a melting or heat-treating furnace. This is as necessary as it is to have an oil burner, and it is also absolutely necessary to have the flame of that burner fit the combustion chamber as perfectly as a drawer fits an opening in a desk.

If it is essential to use a superior quality of fuel for the melting of the metal for malleable iron castings, it is just as essential to have that metal properly annealed. The old-fashion coal-fired oven which often has a difference in temperature of from 350 degrees Fahrenheit to 400 degrees Fahrenheit between the top and bottom of the oven will soon have to be replaced by modern annealing equipment of such construction that the oven will not vary in temperature over 10 degrees Fahrenheit. The practice of striving to overcome the detrimental uneven temperature of the oven by placing a small casting in the lower box and gradually increasing the size so that the largest castings are placed in the upper box, should be discontinued. We all know that you cannot charge a furnace by this method and get desired results, for this practice is just as disappointing as it is to buy a box of strawberries and find the fine berries on the top while those at the bottom are small and green, or possibly decayed.

If any metal is to be heat-treated it should be heat-treated properly. This can only be done by having the proper temperatures. I am very well aware that many old style ovens have a number of tunnels below the charging space, but these are examined only once in every 3 or 4 years, and are often found to be clogged with broken refractory material which of course gives very disappointing results. I have often spoken with men who inform me that the ovens were heated at the bottom because the heat radiated from these gas flues upwardly through refractory material, and heated the bottom of the oven. This is impossible. Such statements are not rational if the oven has to come to temperature in a given length of time.

For a number of years oil has been used for the melting of brass and kindred alloys but unfortunately direct-fired oil furnaces were recommended for this purpose which resulted in the alloys, which melt at a lower temperature than copper, being sacrificed, thus

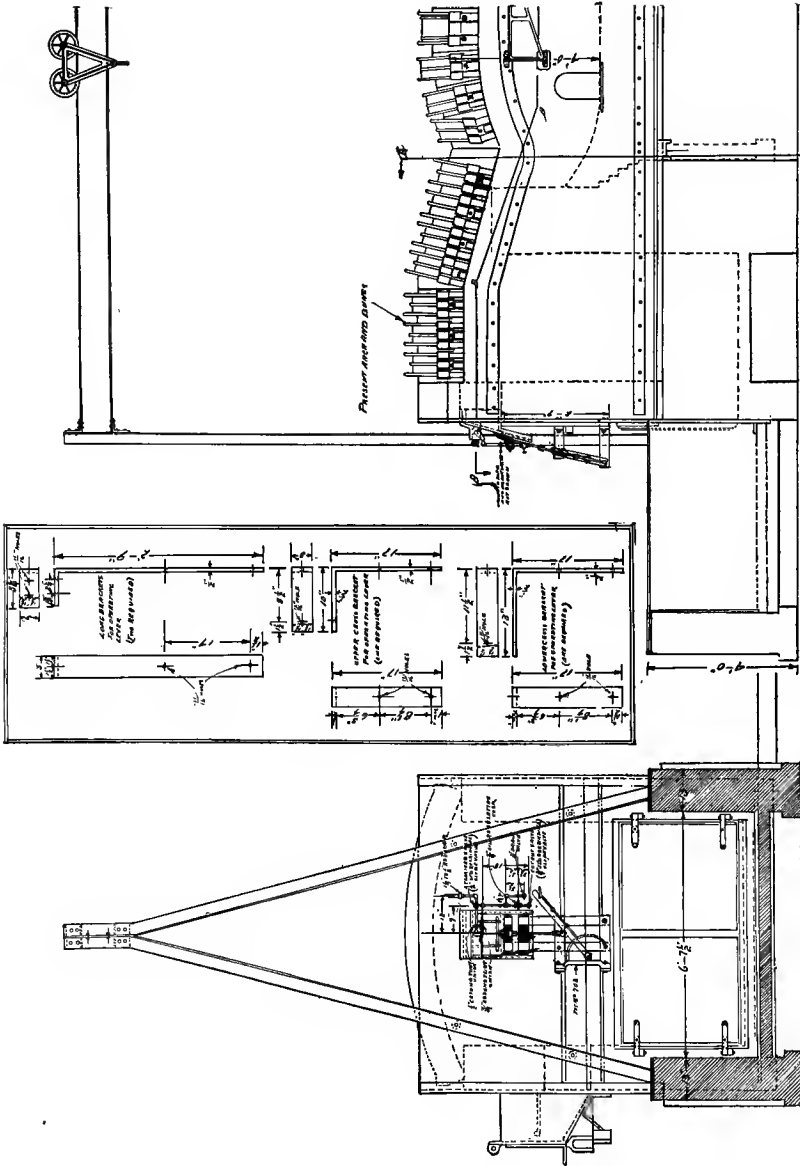

Fig. 173. Liquid fuel injecting apparatus applied to an air furnace

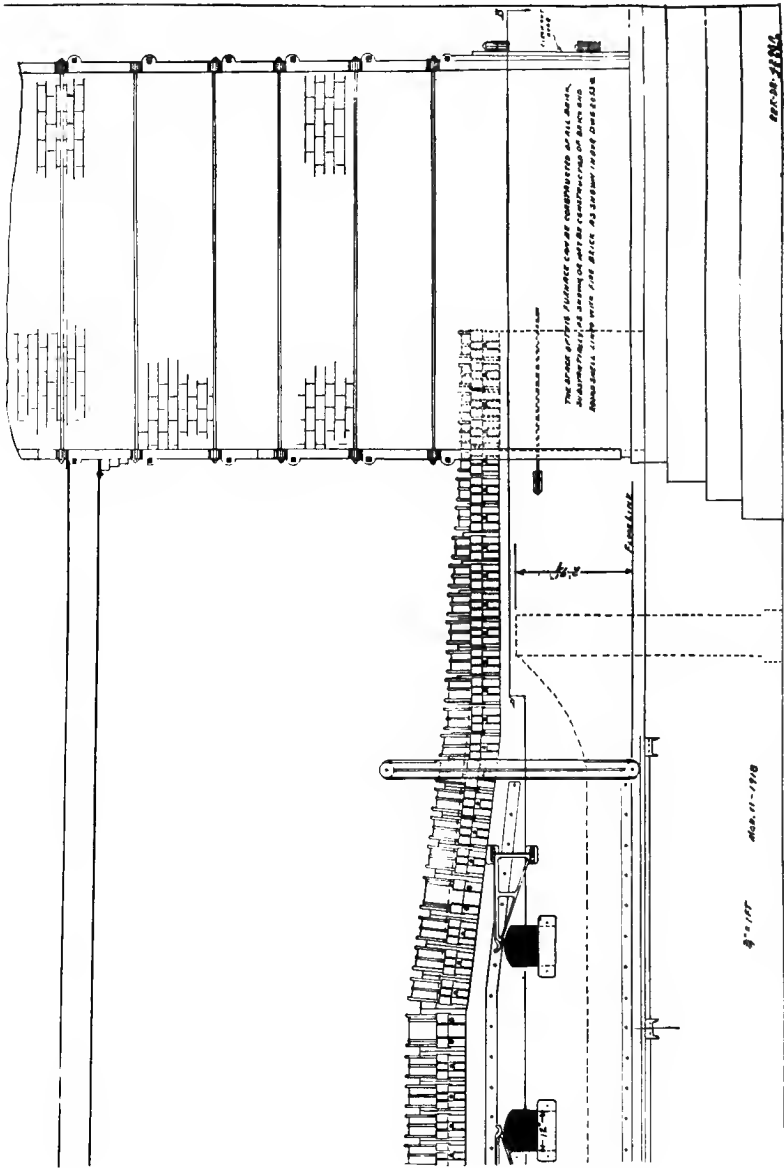

Fig. 174. View showing stack end of air furnace with liquid fuel injecting apparatus.

causing an irreparable loss in metal; to say nothing of the attendant change in the composition of the metal. It was indeed a sad day when crucible furnaces were discarded for the direct-fired oil furnace, but now, thanks to the ability and fighting qualities of young metallurgists in (or who should be in) every brass foundry, we are again returning to crucible melting furnaces. In Fig. 177 is shown a modern crucible brass melting furnace, six-pot capacity. You will note that the furnace is reversible. That is, one burner is in operation until the metal in the three crucibles in the first chamber is ready to pour, and during this time the waste gases passing in through the second chamber on their way to the stack

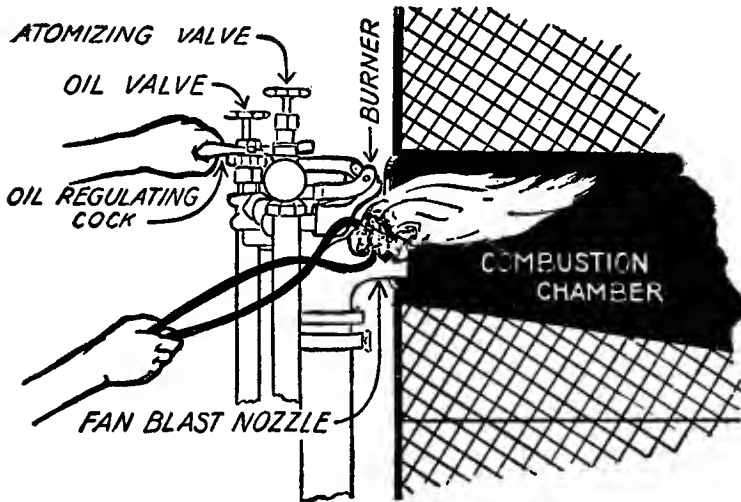

Fig. 175. View showing the proper place to hold the torch for lighting a furnace burner.

have preheated the metal in the second chamber, thus using the waste gases as much as possible. After the metal in the first chamber has been poured and the crucibles refilled, the dampers to stack are reversed, the plates over burner openings reversed and the second burner is started. The first chamber then becomes the pre-heating chamber. The heat in the flue to stack is utilized to pre-heat the incoming air. Note the combination of the damper or air opening in flue with the flue damper. The apparatus is so arranged that when the flue damper is closed a lug automatically

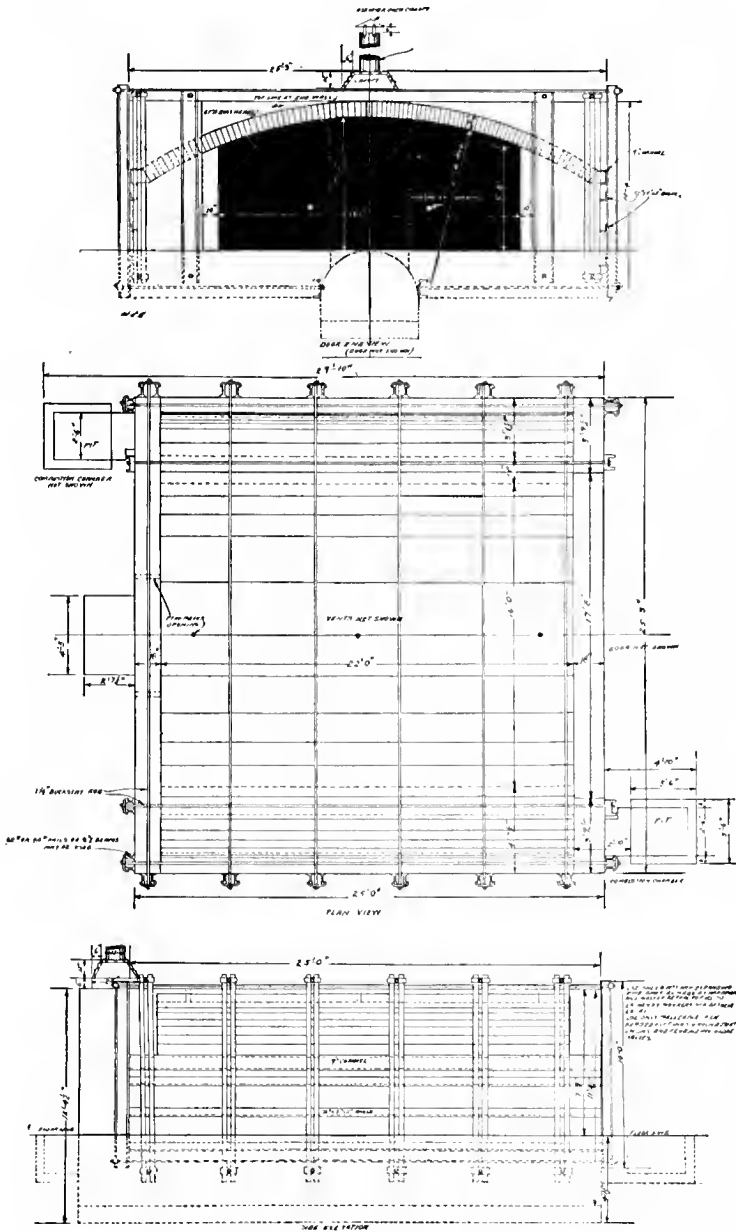

Fig. 176. Malleable iron annealing furnace.

raises the air damper on top of the flue so that the air is preheated while passing through the flue to burner end of furnace then in operation. By this means the air necessary for perfect combustion is preheated by heat which would simply have been wasted in the ordinary type of furnace construction. Convenient means are provided for operating both dampers and covers. This furnace

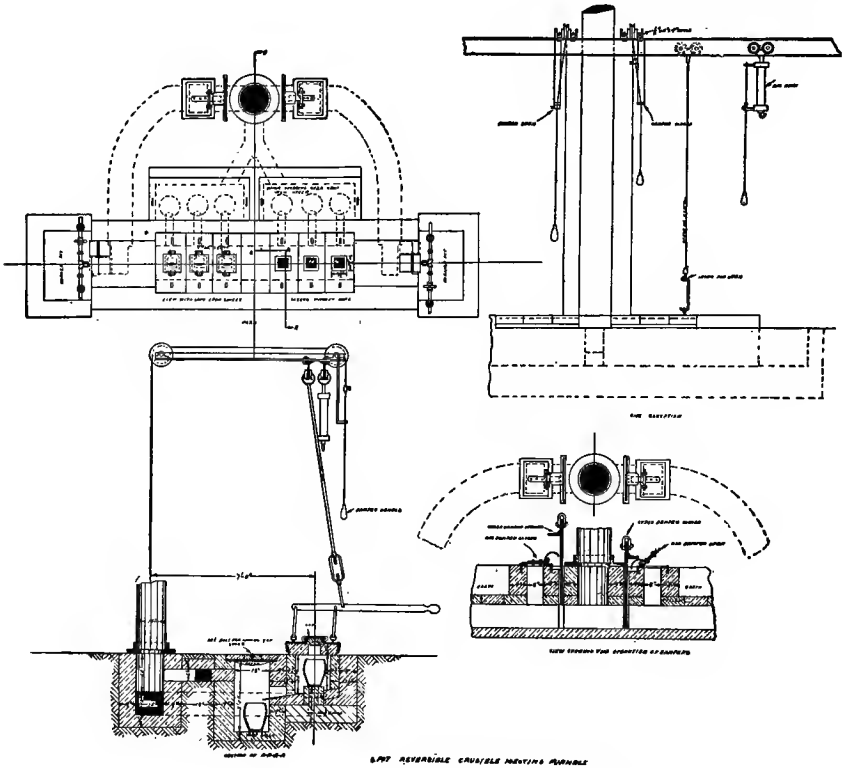
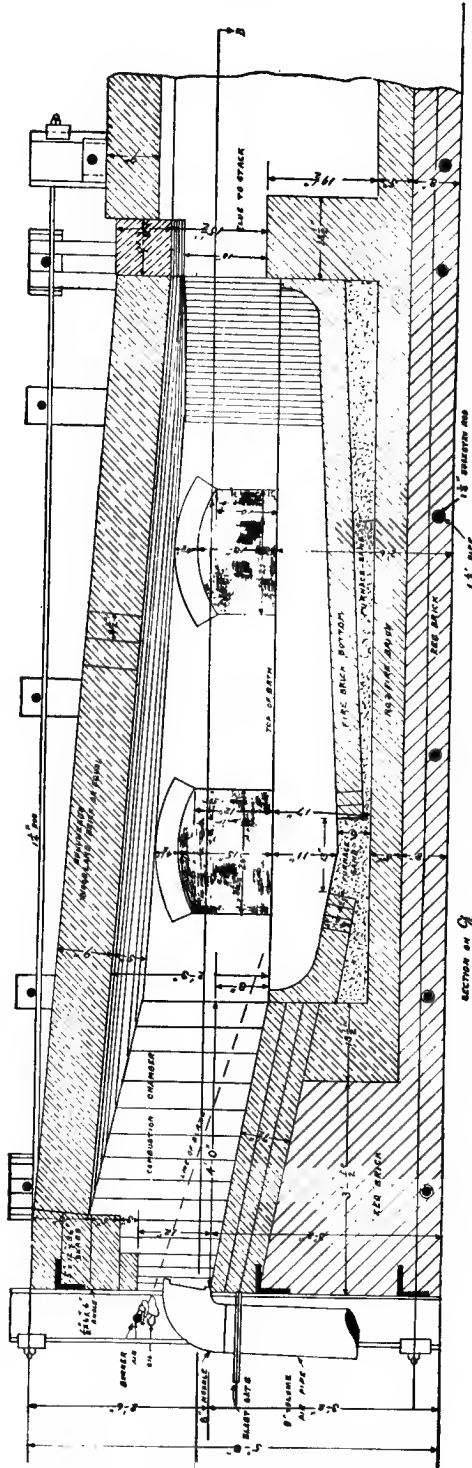

Fig. 177. A modern six-pot brass melting furnace.

is constructed for various sizes and numbers of crucibles and besides being efficient and economical it reduces the loss in metal to the minimum.

Scrap brass is charged into the four-ton melting furnace shown in Fig. 178, made molten by the heat from the one burner and poured into ingots. After being analyzed by the metallurgist, these



4 TON MELTING FURNACE

Fig. 178. Four-ton brass melting furnace.

BURNING LIQUID FUEL

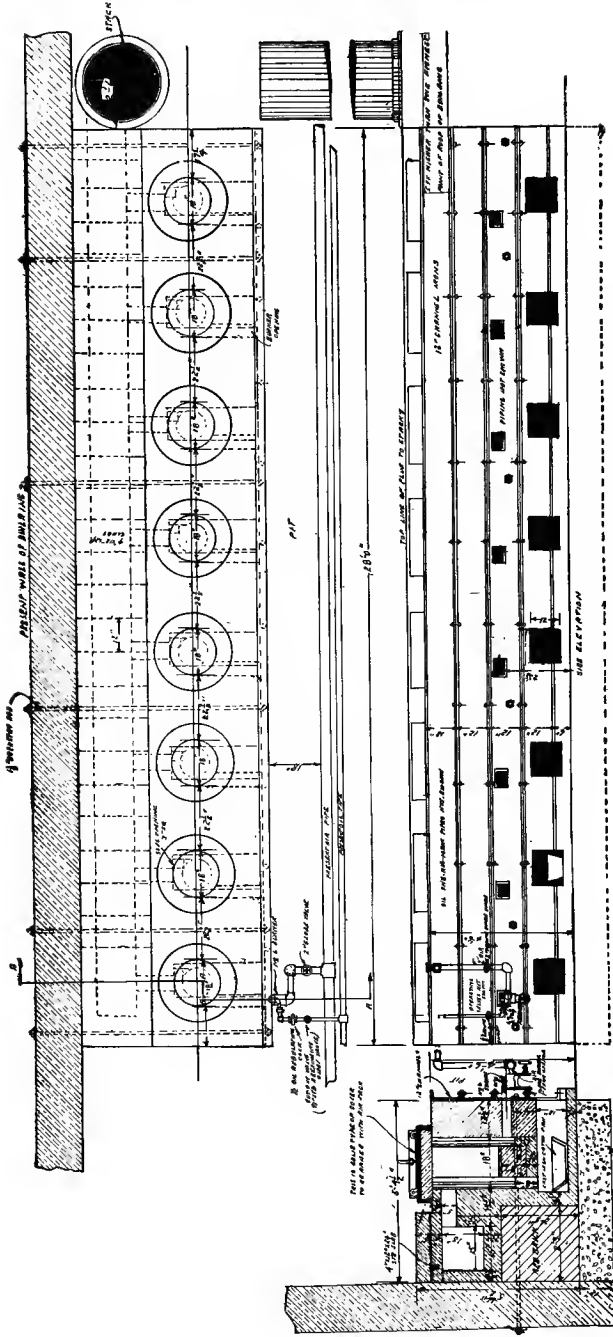

Fig. 179. Battery of crucible furnaces changed from coke to oil-fired.

ingots are stacked in their respective order ready to be melted in crucible furnaces. The combustion chamber, you will note, is of adequate proportions to reduce the loss of metal through oxidiza-

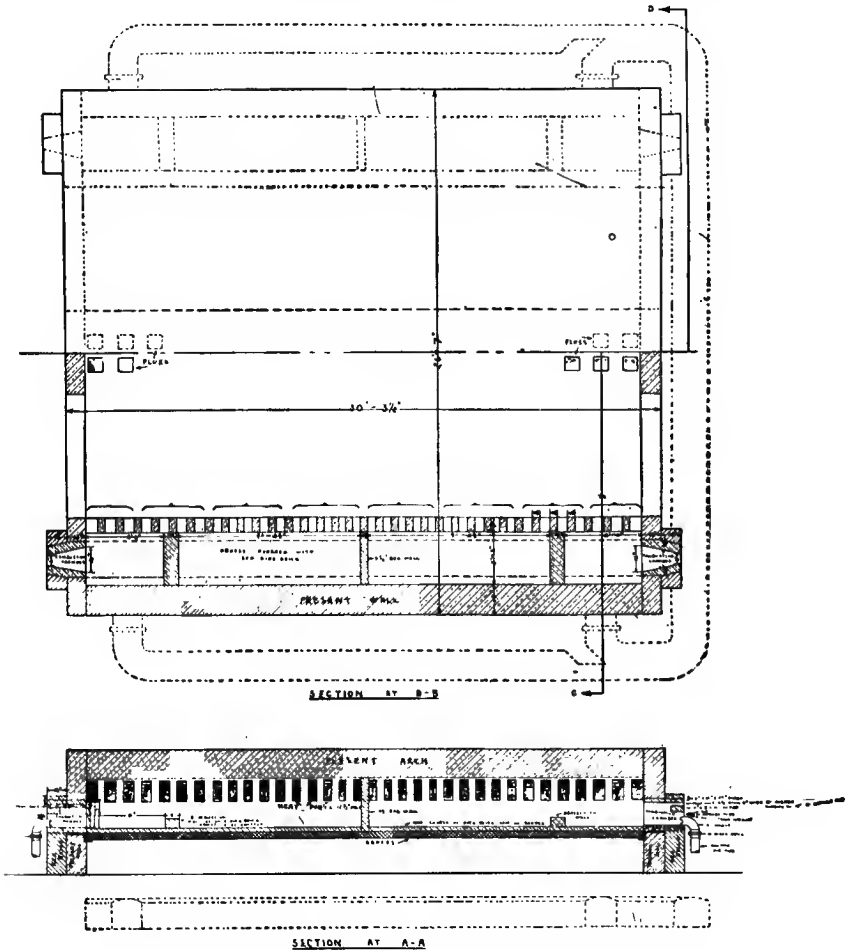

Fig. 180. Furnace for annealing or heat-treatment of sheet copper or brass

tion to the minimum. Yellow brass must be melted very carefully. To prevent excessive loss of metal, a neutral flame should be maintained at all times and this can only be done by using just one burner and a combustion chamber of adequate proportions.

In order to obtain the required alloy within one-half of one per centum, it is necessary to use crucible furnaces, of which a battery, changed from coke to oil-fired, is shown in Fig. 179.

In small foundries an oil-fired crucible furnace (Fig. 181), is used for melting brass, copper and other alloys. The capacity of this furnace is either a No. 60, No. 70 or No. 80 crucible. This furnace has a combustion chamber of such form and proportions that the tangential flame and heat encircles the crucible and is evenly distributed without any cutting effect upon the crucible. The air necessary for perfect combustion unites with the consum-

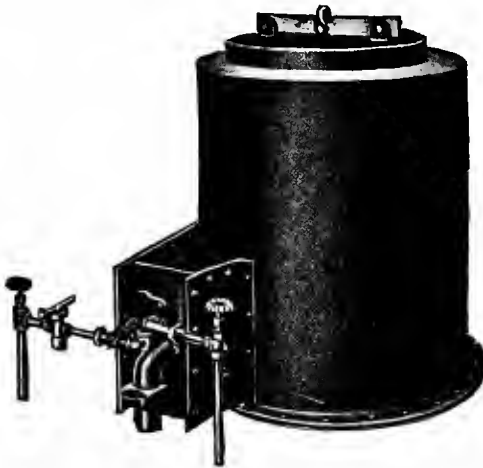

Fig. 181. Single oil-fired crucible furnace for brass melting, etc.

ing fuel in the combustion chamber before it reaches the crucible; thus the life of the crucible is prolonged because of oxidation being reduced to the minimum.

For the annealing or heat-treatment of sheet copper or brass in rolling mills it is essential that the furnace be accurately and evenly heated, and for this purpose oil, scientifically applied, is a fuel which cannot be surpassed. In a furnace about 8 feet 6 inches wide by 30 feet long two burners should be installed, while for a smaller furnace only one burner is required. I know some firms have equipped these furnaces by installing a large battery of burners, but the results have always been unsatisfactory as the complicated operation of all these burners is simply a source of worry to the operator.

Figure 182 illustrates manner of equipping an ordinary Core or Mold Drying oven in which coke or coal has heretofore been used. One burner is placed in the former ash pit of each fire-box, and the combustion of the fuel is so perfect that no soot ever settles on the cores. The Controlling Valves and Oil Regulating Cock, you will note, are placed in positions convenient for the operator. As the operator has the fire under perfect control, he can dry the material as quickly or as slowly as is desired. Liquid fuel gives a more penetrating heat than coal or coke, and it has been found, that, if desired, as many cores can be dried in twenty-five minutes as in

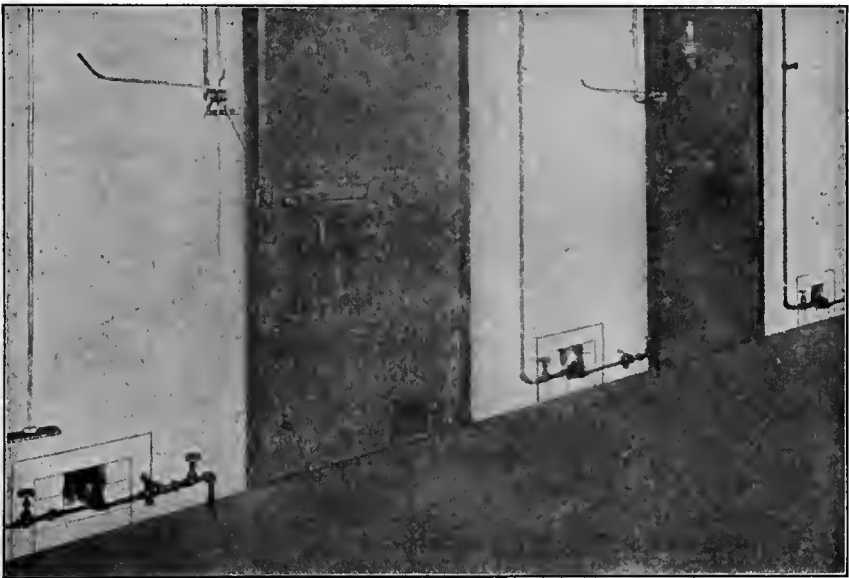

Fig. 182. Core or mold drying oven changed from coke or coal to oil-fired.

three hours while using coal as fuel. This shows an old fashion type of core oven in which coke or poor coal was originally used as a fuel. The fire-box is utilized as a heat chamber.

We always recommend the modern type of core oven where the combustion chamber runs longitudinally with the length of the oven and has graduated heat ports, as this insures an even heat at the base of the oven and distributes same from each side of the combustion chamber. The heat radiates upwardly and the oven is vented through the arch or roof of the oven as shown in Fig. 183.

In molding or core drying ovens it is absolutely necessary to use a recording instrument to record the temperature attained and

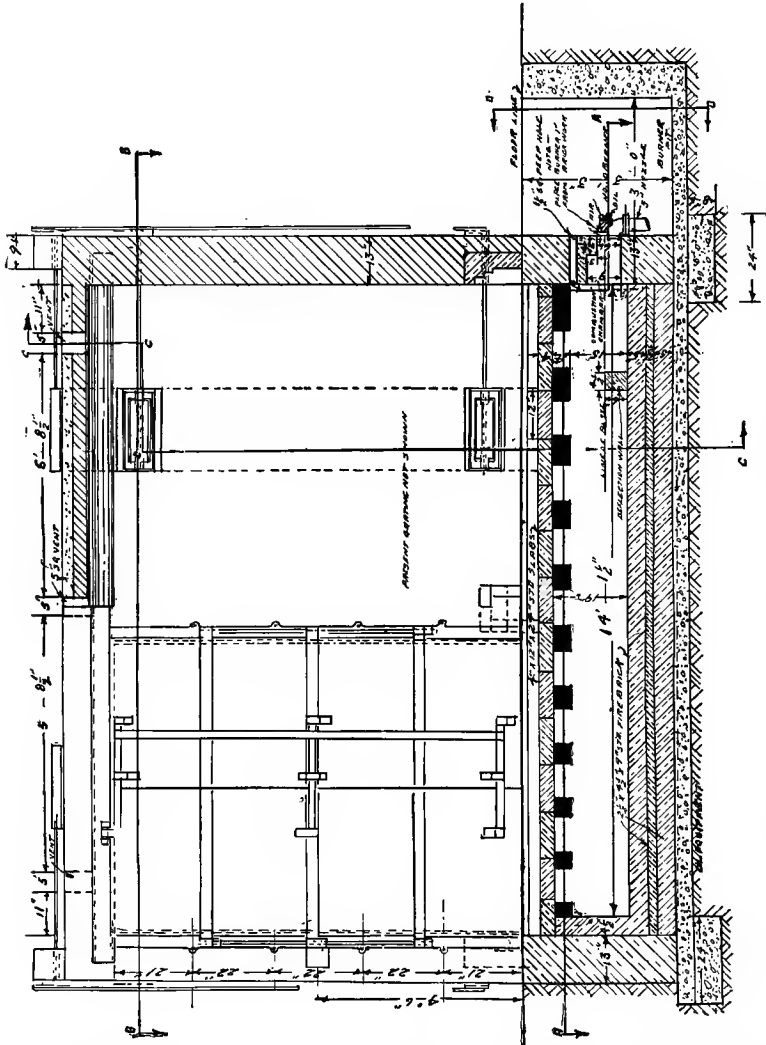

Fig. 183. A modern core oven. (Longitudinal mid-section.)

maintained in the oven. A great saving of fuel is thus effected and all guesswork eliminated. There should be dampers provided for the heat ports of the long battery of Millet Ovens shown in Fig. 185,

so that the supply of heat for each individual oven may be controlled according to requirements.

For ladle heating oil in steel foundries, grey-iron foundries,

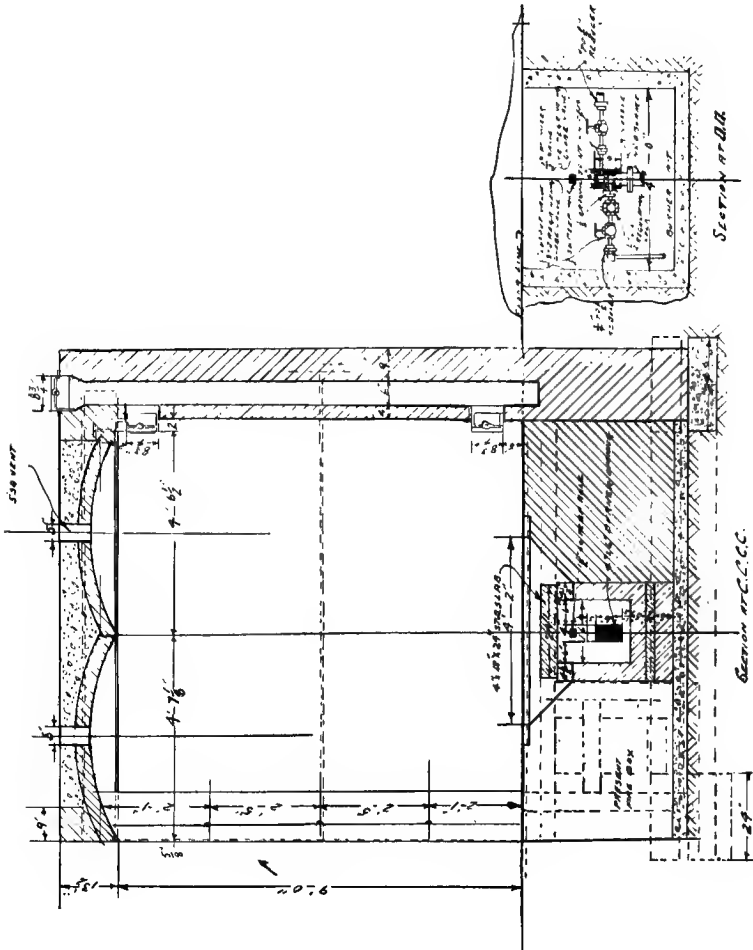

Fig. 184. A modern core oven. (Burner end.)

malleable iron foundries, brass foundries, etc., is far superior to all other fuels. The various metals must be heated to certain temperatures before being poured, and one of the new theories advanced during the past few years is that the ladles should be heated to approximately the temperature at which the metal is poured. This

sounds reasonable for if it is essential that the metal be at a certain temperature when poured, it is also equally important that it be not chilled while being poured into the ladles. Oil is the fuel whereby the ladles can be properly heated to the same temperature as the molten metal.

A ladle-heating furnace is shown in Fig. No. 138 of Chapter 11.

Chapter XIV

MODERN FORGE SHOP PRACTICE

The blacksmith requires more judgment than any other tradesman. He has always been known to history. In the Bible we are told of Tubal-Cain, that ancient forger of cutting instruments of brass and iron. He evidently was not only a man of brawn but also of brains, for he was the maker of articles having great tensile strength. He was a scientist who knew the value of heat and made his contribution to the world. His name has been immortalized because of his knowledge of heat and metals.

Heat is the most complex subject in the world we have to deal with, and our meager knowledge of it is the only thing that has separated us from the brute. "The Village Blacksmith," was the subject of a poem written by our great American poet, Henry W. Longfellow. It is a poetic gem, greatly admired by not only the members of this craft but also by all lovers of poetry. The blacksmith is found in every shop to-day where iron and steel are used. He has been one of the indispensable tradesmen in every clime and age until now he is a world-power and manufacturing genius. To-day a successful forgerman must have a practical knowledge of mechanics, for powerful machinery must be used in modern forge shops, and as the day of the Village Blacksmith has long since passed, he must also have a knowledge of metallurgy, of drop and steam hammering, forging machines, etc. He must also have a knowledge of instruments recording accurate temperatures as these instruments must be used in heat-treating furnaces, for the value of steel depends upon its heat-treatment. Also, the study of fuels and furnace construction is necessary for modern shop practice.

Various fuels demand different forms of furnace construction, and I am frank to say without fear of contradiction that more development has been made in furnace construction in the last five years than from the time of Tubal-Cain up to 1915. The metallurgist of a plant demands whatever improvements in furnace construction will produce the highest quality of metal, and perfect radiation of heat can only be accomplished by scientific furnace

construction and intelligent operation of same. The day of guess-work, such as heating metals to a cherry red or indigo blue, has vanished, having given place to recording pyrometers in order that the steel of certain alloys may have the proper heat treatment. The metallurgist is now an indispensable man in a modern forge shop.

The dominant fuel of the various ages has been used by the craftsmen of each generation, but to-day oil is accepted as the incomparable fuel for forging and heat-treating of metals.

Fuel from the beginning of civilization has been the developer of tribes and nations. In the more remote days when one tribe wished to overpower another their first effort was to destroy the fire of the other tribe, and after the destruction of the hearth fire the tribe sustaining the loss became enslaved to the victorious tribe. It is still true in national life that the nation which conserves its fuel is the dominant nation on earth. It always has been and always will be.

This is the petroleum age, and liquid fuel has been found to be superior to coal or other solid fuels. The nation which controls and intelligently conserves this, the world's greatest mineral resource, will be the most powerful nation on earth. Its people will be the most prosperous and happy. I hope that the heat from the fuel will be tempered by love so that it may be a nation which will use its power for good, governing with righteousness its people and bringing a reign of peace to the world.

Unfortunately the World War has created a great demand for this fuel in marine service and our Government has equipped many boilers on vessels without making any preparations for a change back from oil to coal. The result is that the makers of iron and steel forgings of all kinds are in great need of oil. Many forge plants have had to change back to coal, which, of course, meant a deterioration in the quality of their product. The United States of America is a great manufacturing country, and if it is to continue to hold its reputation as such the manufacturers must be given oil as fuel at reasonable prices even though the Navy Department has to return to coal. This is necessary in order that the manufacturers be able to put forth a maximum output of a quality superior to that produced by coal. A plant using oil in its forging and heat-treating furnaces can turn out 100 per cent. more work of a better quality than that of a plant using coal as a fuel. The United States produces 62 per cent. of the world's

oil production, and yet, strange to say, the manufacturers are in great need of this fuel. To change from coal to oil in a manufacturing plant is like changing a tallow candle for an incandescent light. The writer sees no reason why the Navy should use oil if this fuel is in such a demand by the manufacturers of our country, for in marine boiler service on ocean-going vessels it requires 180 gallons of oil to represent a long ton (2240 pounds) of coal having a calorific value of 14,000 B.t.u. per pound, while in forging furnaces it requires only 82 gallons of oil to represent a ton of this same grade of coal. In heat-treating furnaces from 62 to 68 gallons of oil represent a ton of coal of the calorific value above referred to. Of course labor is saved by the use of oil in the operation of marine boilers, but the saving does not begin to compare with that effected while operating furnaces with oil in forge shops.

The recent war has revealed to foreign nations the value of oil as fuel, and they are now making great efforts to secure this fuel. England is a great manufacturing country and has a grave responsibility in manufacturing goods for her colonial possessions. She is doing all in her power to secure as much of this fuel as possible, and will use it in her factories. The nations which conserve their oil and use it in the manufacture of metals will be the great manufacturing nations of the future owing to the fact that they will get the maximum quality and quantity of output. I believe that merit always tells. This is just as true as that a drop forging has a higher tensile strength than a casting of the same proportions. No nation using coal for manufacturing purposes can compare with a nation using oil. I want to make this very plain and record this in time to make history. Therefore I am sounding a note of warning at this particular time. To-day the watchwords of all forgemen are: first, **QUALITY**; second, **ACCURACY** of form; and third, **QUANTITY**. These three points merit the consideration of the purchaser, and firms using these as their motto will merit the kind consideration and patronage of those who desire such material.

I know it is the sincere wish of the manufacturers that the Government co-operate with them in procuring liquid fuel at reasonable rates so that the manufacturing interests of our country may be protected and a maximum output of superior quality produced, in order that our products may merit not only the attention

and consideration of the people of the United States but also that of the entire world. This can be accomplished only by giving manufacturers the fuel by which they can do this, and that is liquid fuel, although I prophesy that at no distant date a combination of coal and oil will be used in order to conserve both coal and oil and eliminate smoke in many practices at present unknown to the public. but we will not deal with this subject at great length here.

The manufacturers in that section of our country which is located along the Atlantic Coast will be compelled to use a low gravity oil, coming from Mexico, where it is produced in great quantities. This varies in gravity from 11 degrees to and including 16 degrees gravity Baume, but averages about 12 degrees. As this oil is high in sulphur contents combustion chambers must be used in order to eliminate the sulphur as much as possible. With the proper oil installations, or systems, this fuel is readily burned. It must be heated to reduce its viscosity. Topped Mexican oils of 14 to 16 degrees gravity vaporize at approximately 175 degrees Fahrenheit and should be heated to about 170 degrees Fahrenheit. The lower or bottom oils of 11 to 12 degrees gravity vaporize at from 205 to 210 degrees and should be heated to within five (5) degrees of the vaporizing point.

California oil of from 14 to 16 degrees gravity Baume vaporizes at 230 degrees Fahrenheit and should be heated to 225 degrees Fahrenheit.

Texas oil which is approximately 21 degrees gravity vaporizes at 142 degrees Fahrenheit and should be heated to 5 degrees less than the vaporizing point.

Oklahoma oil vaporizes at approximately 154 degrees Fahrenheit and should be heated to 149 degrees Fahrenheit.

We are often asked: "What is the vaporizing point of oil of from 21 to 23 degrees gravity?" This question cannot be answered without asking the question: "From what field is this oil taken?" because sometimes you get a mixed oil that is a 21 degree gravity oil. If mixed oil it would be 50 per cent. Mexican oil and 50 per cent. Pennsylvania oil, which is about 36 degrees gravity. This will make 21 degrees gravity Baume oil. Sometimes 23 degree gravity oil is made by mixing 40 per cent. of the Mexican oil and 60 per cent. of the Pennsylvania oil. These oils vaporize at approximately 140 degrees Fahrenheit.

BURNING LIQUID FUEL

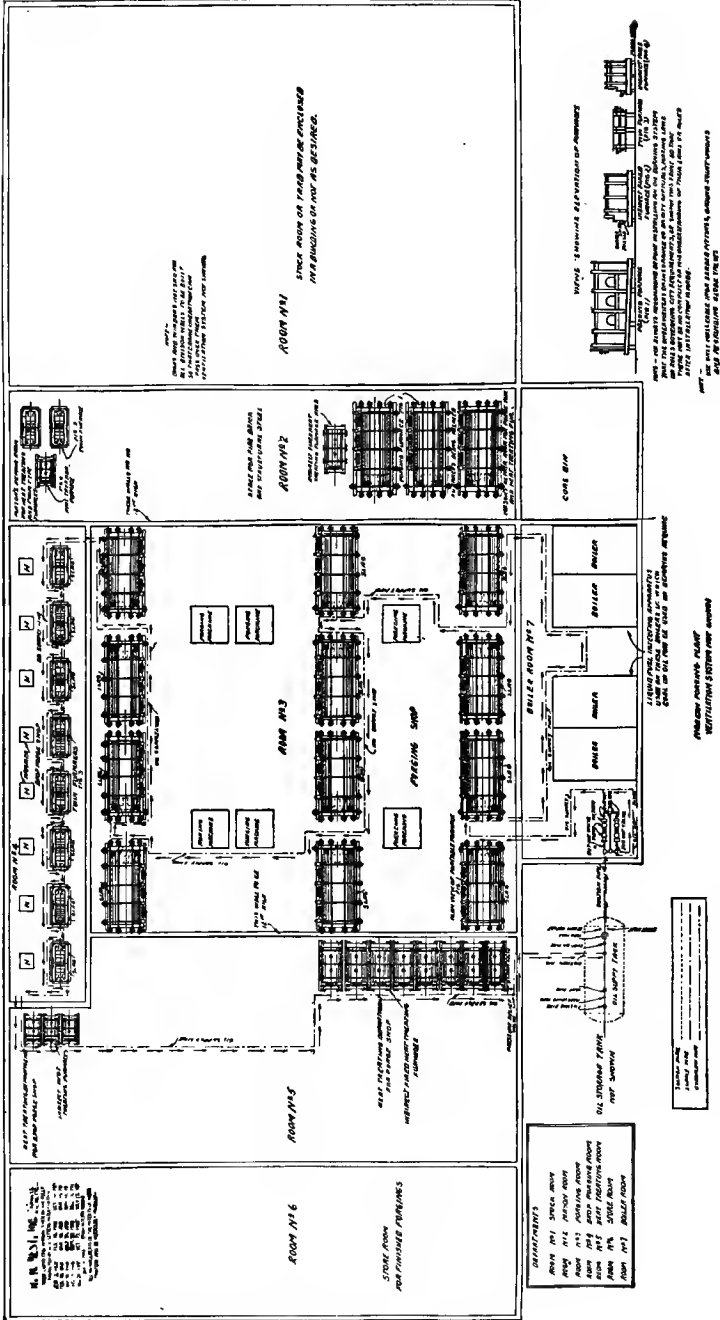

Fig. 188. Complete oil circulating system, as used in a modern forge shop for both large and small drop forgings.

There are a great number of oil systems, especially in manufacturing plants along the Atlantic Coast, which will have to be discarded before Mexican oil can be used because a circulating system, such as is shown (See Fig. 188), is absolutely essential. The practice of having one or two large mains and laterals leading from the mains to the furnaces, and having almost every lateral a "dead end" can never be successful when burning Mexican oils. Often heavy oil is condemned because manufacturers have tried it in their works and have, owing to improperly laid oil systems, failed. The failure is not the fault of the gravity of the oil, but is the fault of an imperfect oil system. Again, too, it is very essential to thoroughly atomize the heavy oil. Without having the heavy oil thoroughly atomized, it is impossible to get results, both as to output and economy in fuel. A few years ago we were burning oil of approximately 36 degrees gravity Baume which could be shoveled into a furnace with a small shovel, intermittently, and would heat up the furnace. You could even take two pieces of pipe and blow the oil with a quantity of low pressure air into the furnace and get fair results, or results equal to the conception of the operator, but this is impossible with heavy oil. Furthermore in the burning of the heavier Mexican oil (which has an asphaltum base) it is very necessary to use low pressure on the oil lines. It should not exceed 12 pounds, for to get an accurate control on the flow of oil to the burner the opening in the oil-regulating cock should be as large as possible. If 40 or 60 pounds oil pressure is carried upon the oil system it is difficult to keep the oil pipes tight, and again, too, you cannot get as accurate regulation of the flow of oil to the burner with a pressure of 40 to 60 pounds as with a pressure of 10 or 12 pounds.

Fig. 188 represents a modern forge shop for large and small drop forgings. Of course the furnace arrangements and forging machines are located in different positions, as necessity requires, but all the furnaces are of modern construction and are so arranged that they can be lifted up by the crane and placed in the masons' room for repairs. The dividing walls separating the rooms are approximately twelve (12) feet in height, but not too high for the convenient operation of the cranes.

The first room of the works is the stock yard. This is usually placed outside of the building, and may be covered if desired. The next (Room 2) is the masons' room, where all the various types

and sizes of furnaces are repaired or kept in repair by the mason, so that when the lining or arch of a furnace is almost ready to drop, the night shift carries that furnace into the masons' room and puts a newly re-lined furnace in place of the one having had the lining burned out, and then starts the burner so that the furnace is hot the following morning. By this method the output from the works remains at maximum, and machines which cost many thousands of dollars are not idle. Consequently there is no

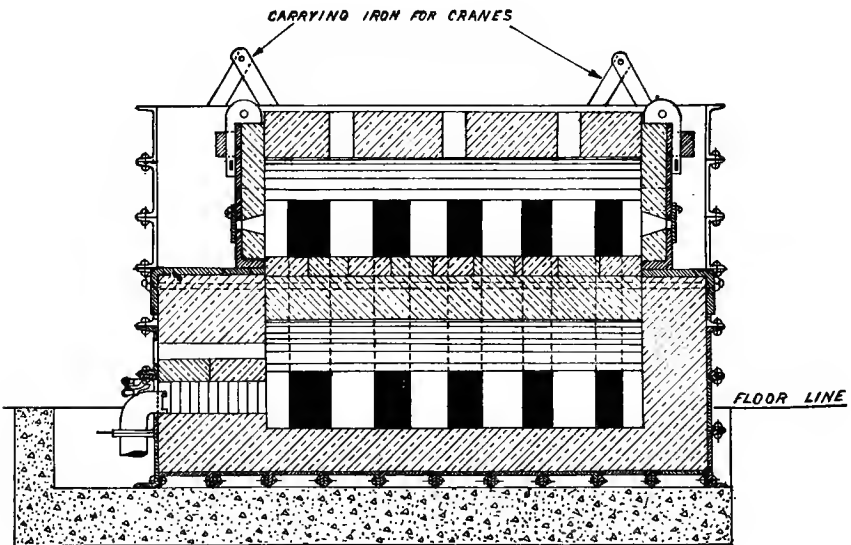

Fig. 189. Heat-treating furnace.

capital lying idle and the workmen are constantly employed. Room 3 is the large forging department, with its forge machines or piercing machines. Room 4 is a small drop forge plant in which board drops or steam drop hammers are used. These furnaces are of modern construction, usually twin-type. The object of this is obvious, for as a charge is put into one section of the furnace and heated, stock is being drawn and forged from the other. Room 5 is the heat-treating department, and the next (Room 6) is the store room for finished forgings. Room 7 is the boiler room. In

other words, the metal is charged at one end of the plant and reaches the store room as finished forgings, after being carefully heat-treated and inspected. In the construction of a forge shop, the first thing to do is to find the proper size of furnaces required for the forgings. Never build a building until you know the size of the furnaces required for maximum output.

You will notice that there is a circulating oil system extending to all the furnaces, and the main oil pipe also passes into the boiler room (No. 7) in order to protect the power plant against a shut-down in case there should be a coal strike or coal shortage, or a car shortage. It is poor business and poor shop practice to wait for the coal strike to come before procuring the necessary oil-burning equipment for the boilers. This should always be on hand if oil is used in any other portion of the works.

A heat-treating furnace, of course, should be of modern construction. We usually recommend a semi-muffle type, as shown in Fig. 190, having graduated heat ports, the heat being made in the lower chamber and delivered to the charging chamber of the furnace through these graduated heat ports. It is distributed in such a way as to insure an even distribution of heat through the entire length and width of the furnace. We have found this can only be done by graduated heat ports because the velocity of the atomized fuel from the burner would otherwise make the opposite end of the furnace two or three hundred degrees hotter if all the heat ports were made of the same proportions. The sulphur contents in the Mexican oil often run as high as 3.85 per cent. It therefore necessitates the use of a canopy so that all the obnoxious gases will be removed from the furnace or forge shop and not annoy the workmen nor cause them to become dissatisfied.

As before stated, the metallurgist is an indispensable man about the forge plant, for upon him devolves the responsibility of making the forgings of the tensile strength demanded by the users. He is a competitor of the iron and steel foundry, for he makes the forged product of the highest stability and at the same time prevents any waste of metal by not having the drop forgings larger than is absolutely necessary. Of course the tensile strength of the metal is increased by heat-treating, and it is this man who states the temperatures to the furnace operator which govern him in the operation of the furnace, and he in turn maintains the temperature specified by the metallurgist.

The die maker is another invaluable man and is a co-worker with the metallurgist. He is the man responsible for the accuracy of the shape and size of the drop forgings. He should be a man of excellent judgment and prevent waste of metal.

The plant superintendent is the man who demands a maximum output by developing team work in all the departments, and endeavors to have an important watchword such as: "WE LEAD ALL SHOPS IN EFFICIENCY, ECONOMY, MAXIMUM OUTPUT OF SUPERIOR QUALITY." The successful superintendent

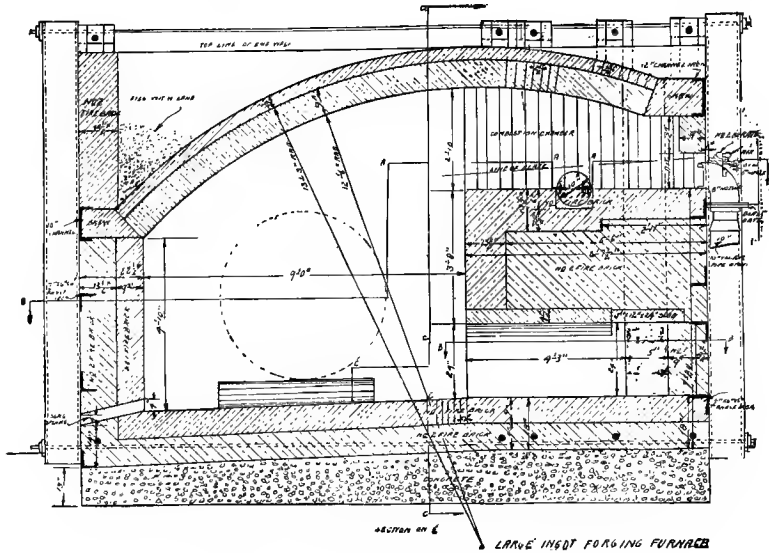

Fig. 190. Ingot heating furnace.

is the man who leads and never follows, a "progressive" in the true sense of that word,—not a dreamer—obtaining his knowledge and making improvements by best known modern practices. He should be like Columbus, who did not follow the ideas and ideals of other mariners of his day, but had a greater vision; otherwise America never would have been discovered. The superintendent who copies the furnace construction and methods of other companies cannot lead; he must necessarily follow. The man who imitates is never a very dependable official. He lacks the ability of an ex-

ecutive. Often we find men who try to copy the methods of others. The class of work, the construction of the furnaces, and the method of operating studied in another plant might be absolutely impractical in his plant, and the result is that the imitation ends in a miserable failure. It is all very well to investigate methods, but it is not always wise to copy them. There are so many things that enter into their practical use that one must be very guarded in striving to emulate the exact practice of another works.

I am well aware that oil, in marine service, is attractive because of the saving effected in labor, there being no discharging of ashes, as well as the time saved in charging the oil fuel on the vessel as against the time required for the loading of coal, and also the advantage of being able to increase the speed of the vessel, the cleanliness, and improved sanitary conditions as well as the fact that this fuel elevates the mind of the fireman as his duty does not require mere brawn but brains for the scientific burning of oil, and gives him the feeling that though he is housed up in a hot boiler room (much cooler because of the use of oil as fuel) he is a man "for a' that." In tug boat service oil is even more attractive as a fuel than it is for ocean-going vessels. In numerous tests it has been found that two oil-fired tug boats will take the place of three tugs of the same size and power, and having all other conditions the same as when using coal as fuel. Yet we must consider the use and the many advantages of this fuel for the manufacturers whose products must furnish at least a part of the cargo for these vessels or else these vessels will be operated at a loss.

For example, Fig. 190 shows a vertical mid-section view of an ingot-heating furnace operated with liquid fuel. The large ingot is brought to a forging heat in five (5) hours' time. The temperature in any portion of this furnace will not (while taking a 12-foot heat) vary more than 20 degrees Fahrenheit. The weight of that portion of the ingot that is heated is thirty-six (36) tons. You will note that there is a combustion chamber which is used to consume the atomized fuel before reaching the furnace proper, and it is so located as to insure a reverberation of the heat around the ingot. This gives an even distribution of heat, which is absorbed uniformly by the ingot, and the result is that the ingot does not require turning. One heater can operate six of such furnaces, and only eighty-two (82) gallons of oil are required to represent

a ton of coal, as before mentioned. Now, compare this with a coal-fired ingot-heating furnace, heating the same size ingot to the same temperature. It will require thirty (30) hours, instead

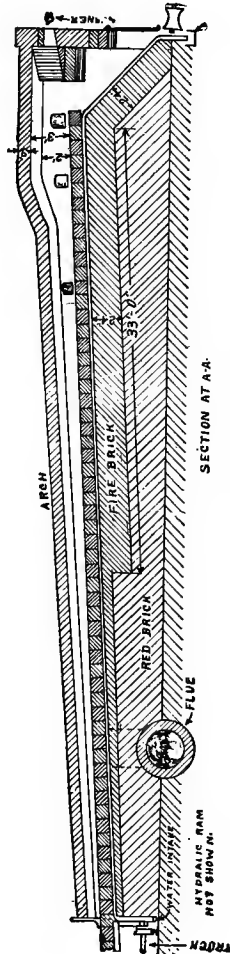

Fig. 191. Continuous furnace.

of five (5) hours to heat it, and owing to the variation of the temperature in the furnace (it is usually from 250 to 300 degrees hotter at the top of the furnace just past the bridge wall, than at

the base of the furnace) the ingot must be constantly turned in different positions so that the upper portion of the ingot will not become overheated. It requires at least six (6) men to turn and rebrick around the ingot. There is not a metallurgist in the world who will not agree with me in the statement that any furnace in which can be secured an even distribution of heat is attractive, as it means even absorption of heat. I am very sure that all forgers, also, will agree with me that forgings should be heated as evenly as possible in order to reduce to the minimum all strains caused by uneven temperatures while heating. The men in marine service will get a new vision also, and that is,—in the forging industry—oil is even more attractive than in marine boiler equipment on ocean-going vessels because a great deal more labor can be saved in a forge shop than in marine service, to say nothing of the increased output and superior quality of the product from the forge shop. In times of peace oil should be used only upon as few naval boats as possible. It should be used on some vessels, however, owing to the fact that men should be trained in the art of operating oil burners. It would be well to have the boilers of the vessels interchangeable so that they can readily be changed from coal to oil, and from oil back to coal, for in a case of war oil should be used if possible on naval vessels. I know that there are a large number of merchant vessels now being equipped with oil in order to save labor and avoid strikes. I believe that will only be used temporarily, but I am equally confident that the nation which conserves its oil and gives its manufacturers all the oil they require, will be the manufacturing nation of the future.

Continuous furnaces (Fig. 191), have either an inclined or declined hearth and are the most economical furnaces in use because with them you retain as much of the waste heat as is possible. Sometimes waste heat is carried to a boiler, while in other types of furnaces the waste heat is vented without the use of the stack. The latter form is preferable.

In drop forge practice the twin-type furnace as shown in Fig. 192 is always preferable to a furnace having only a single charging opening owing to the fact that you will get a more even heat on blanks or small billets charged, because often in actual practice with a single type furnace there is but a space of about the width of an ingot between the last blank charged and the one about to be drawn from the furnace. This practice produces an uneven

BURNING LIQUID FUEL

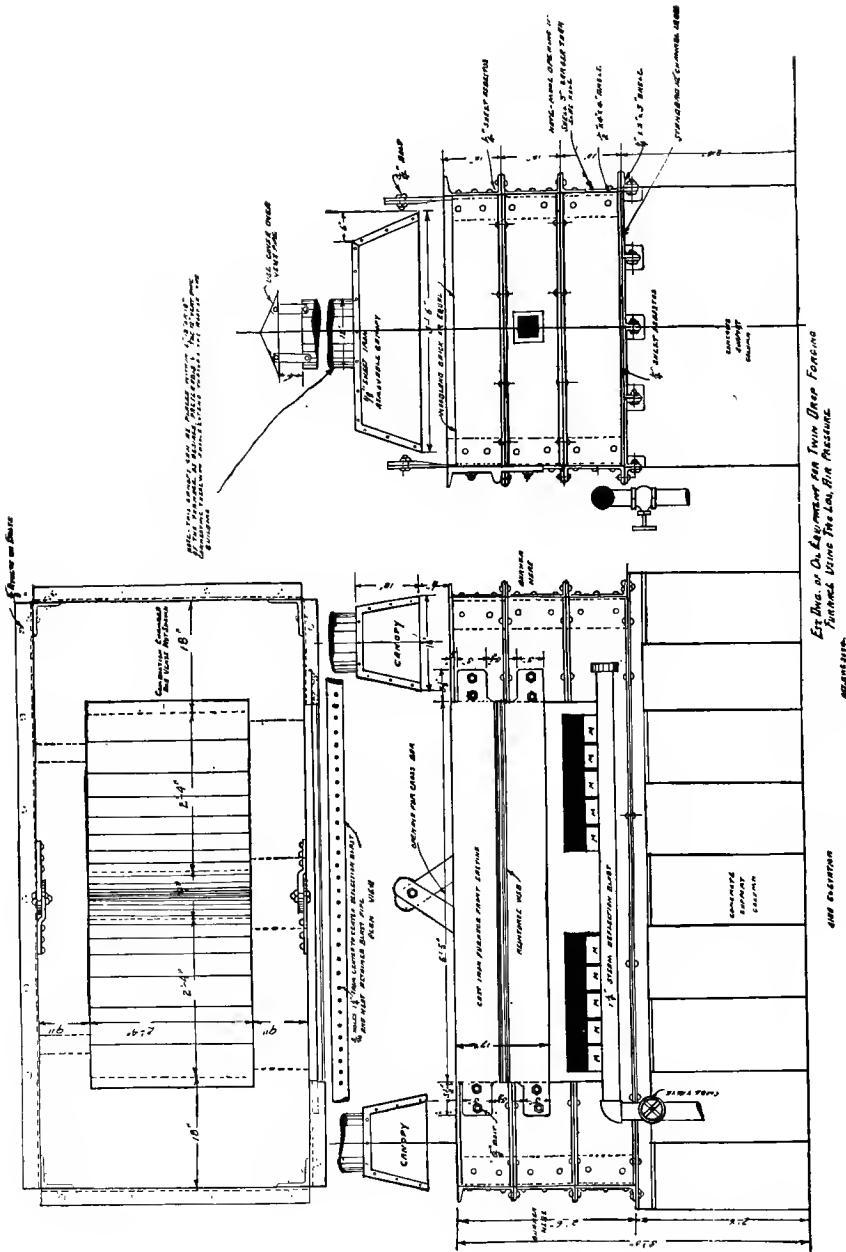

Fig. 192. Twin-type drop forge furnace.

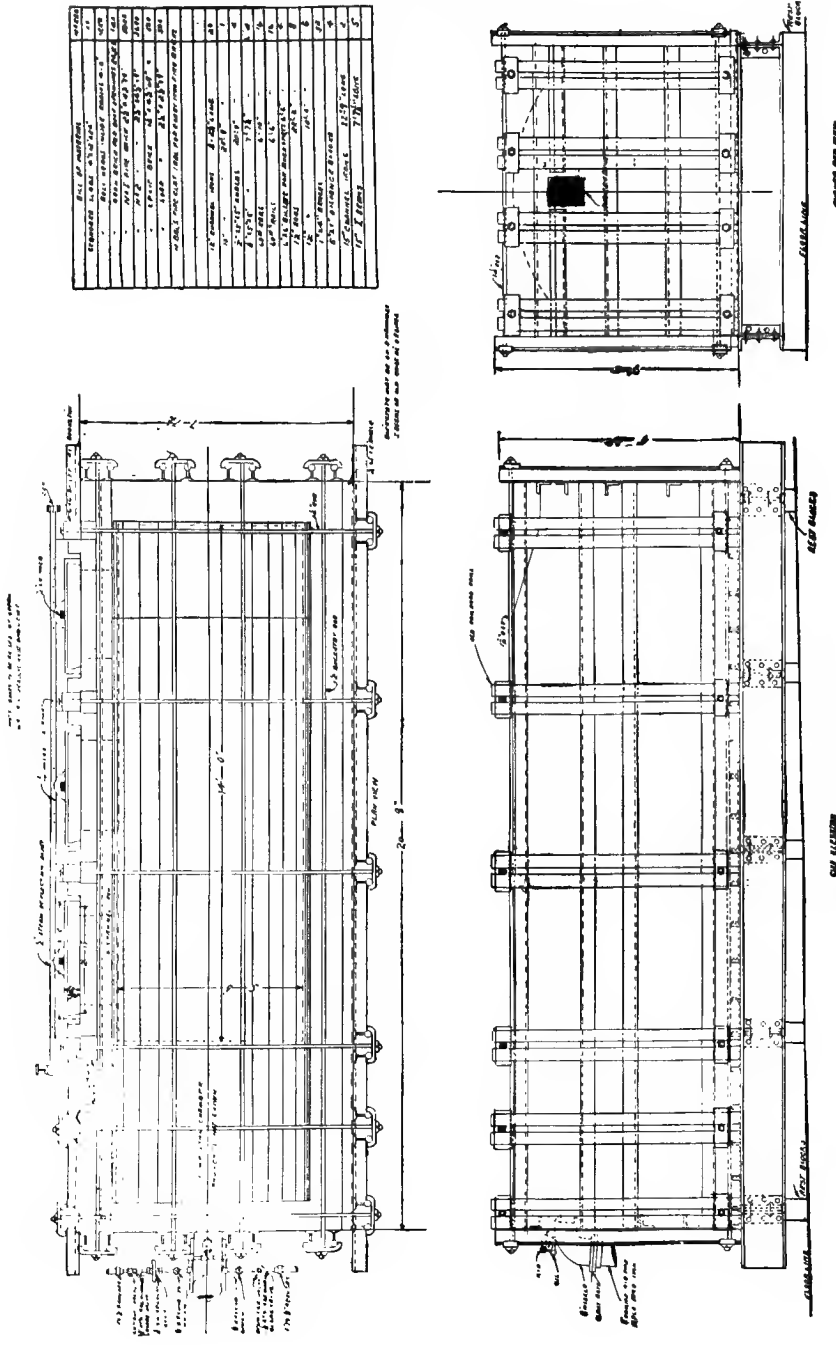

Fig. 193. A modern portable furnace.

temperature on the next blank that is to be drawn because the cold blank absorbs the heat more rapidly than the one that is almost the temperature required for forging, and this results in the uneven heating of the forging next to be drawn from the furnace. We have never known of any firm which, having used the twin-type furnace, has returned to the single opening type of furnace. Blanks are charged into one of the openings of the twin-type furnace and are brought to heat while the blanks of the other section of the twin-type furnace are being drawn and forged. This type of furnace occupies more room, but the output is greater and more even heats are obtained, which of course pleases the forgerman.

In the construction of furnaces always use the best non-expanding fire brick procurable that will withstand the temperature your work requires, remembering that it costs just as much to build or reline a furnace using poor brick as good brick, and some fire brick is not worth putting in at all.

Modern heat deflectors should be provided with which to deflect the heat from the furnace operator. This should be done in order to prevent the workman from being overheated and to enable the operator to obtain the maximum output with minimum fatigue.

Every furnace should be of the proportions required for the maximum output. It should be modern in every detail and should be so constructed that the upkeep of the furnaces will be reduced to the minimum. Construction along scientific lines is absolutely essential in order to get the maximum output, maintain the required temperature and an even distribution of heat. This is essential and must always be considered by the engineer designing the furnaces. A modern furnace is shown in Fig. 193.

Some firms desire to place their furnaces on concrete foundations such as are shown in Fig. 194. The furnace is made of channel iron and can be removed to the mason's room by the night force when repairs on the lining are necessary.

The furnace shown in Fig. 196 was originally fired with coal but it has been changed to oil-fired. The waste heat from this furnace passes up through the elements of the boiler and then out through the stack.

In Fig. 198 we have a furnace serving two bolt headers. (Note the absence of flame from the charging openings.) A furnace of this type is often placed between a bolt header and a rivet making

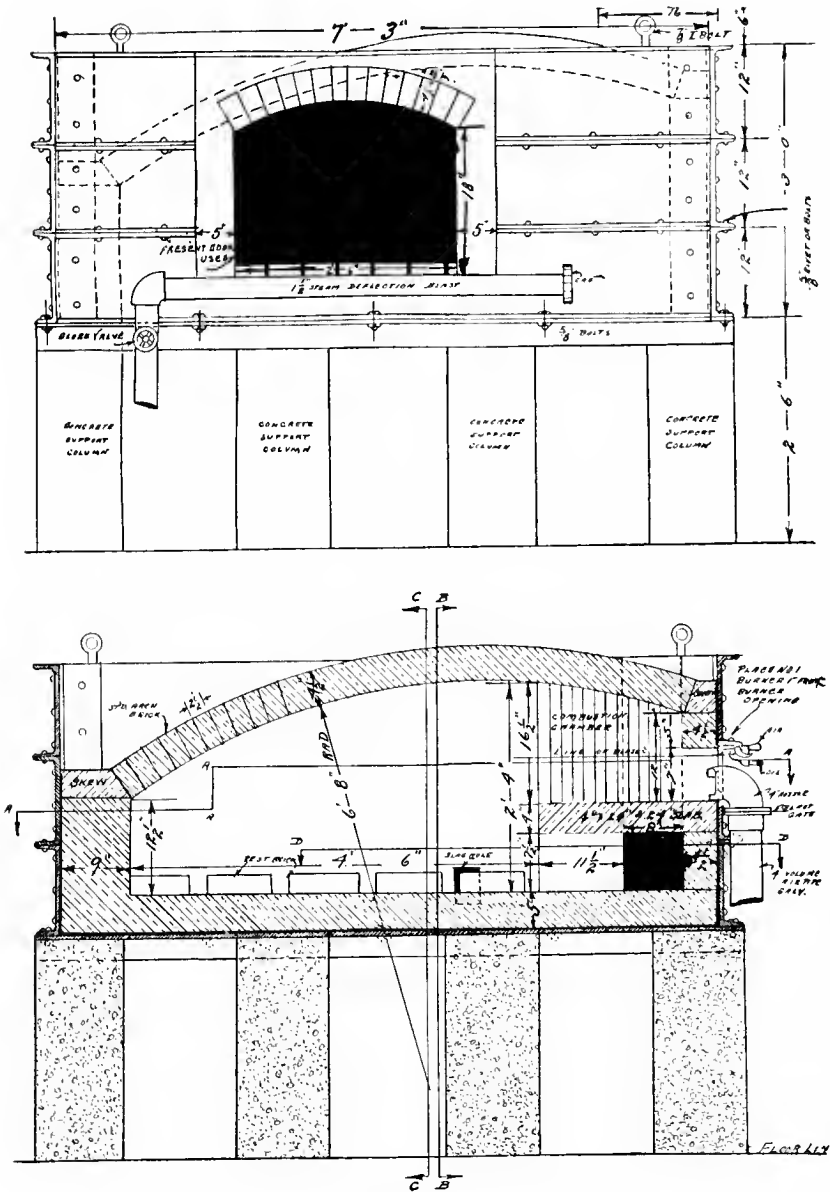

Fig. 194. Portable forge furnace.

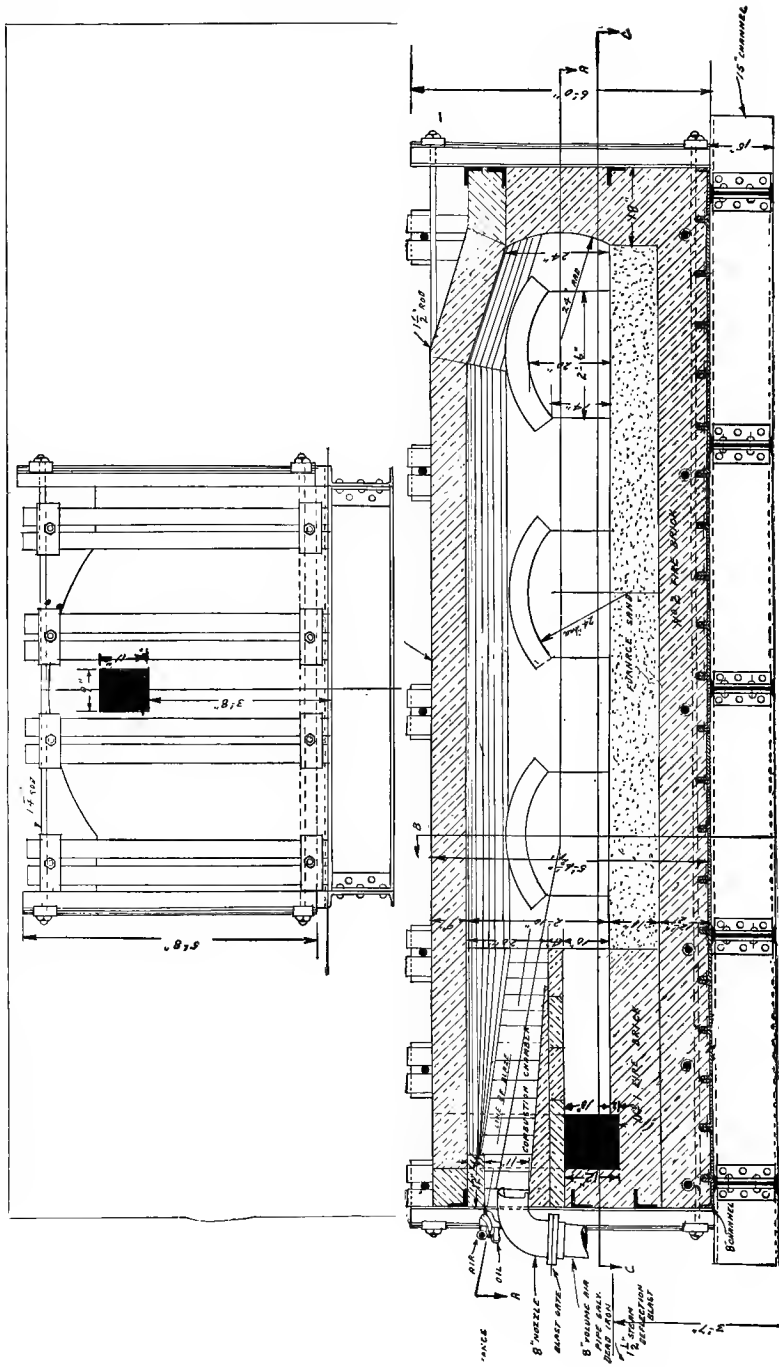

Fig. 195. Billet heating furnace—portable type.

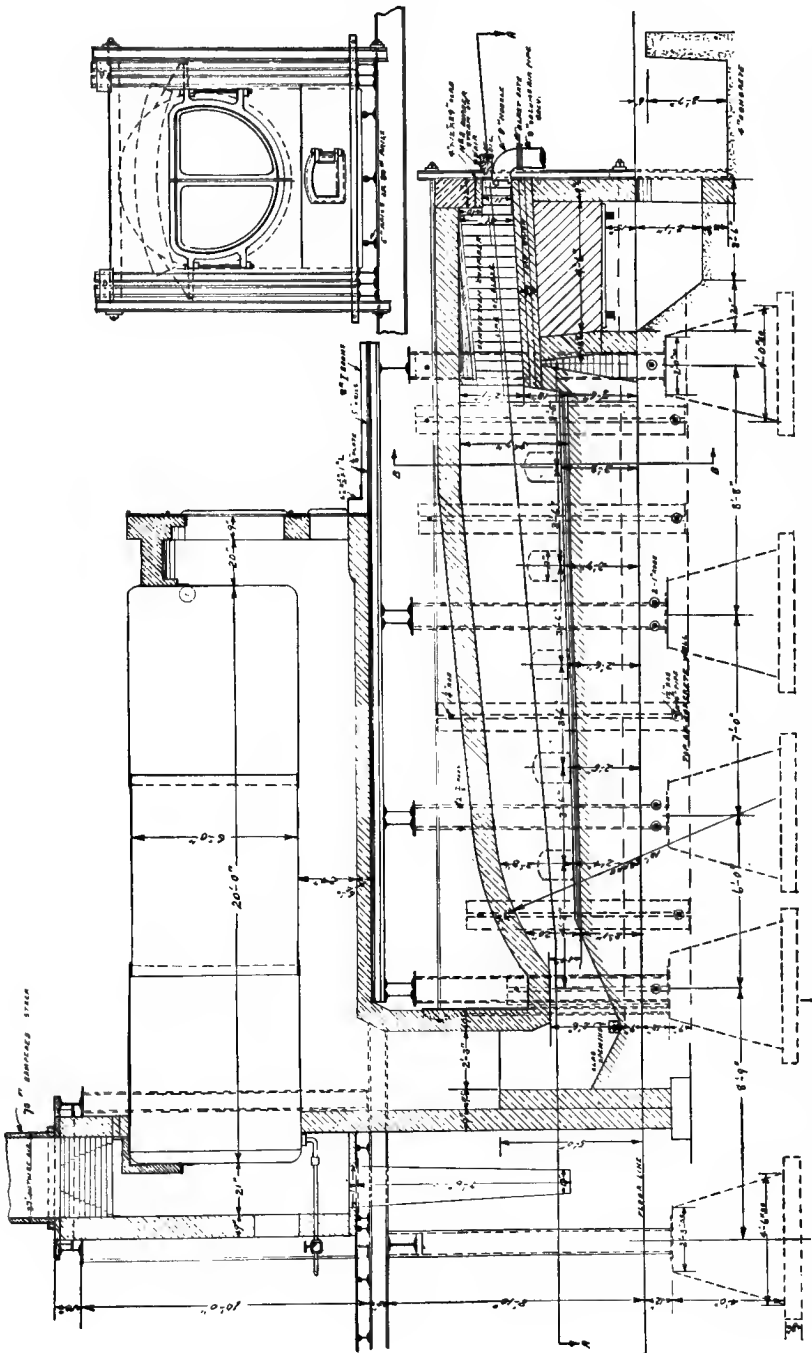

Fig. 196. Longitudinal mid-section of a furnace attached to a waste heat boiler, and changed from coal to oil-fired.

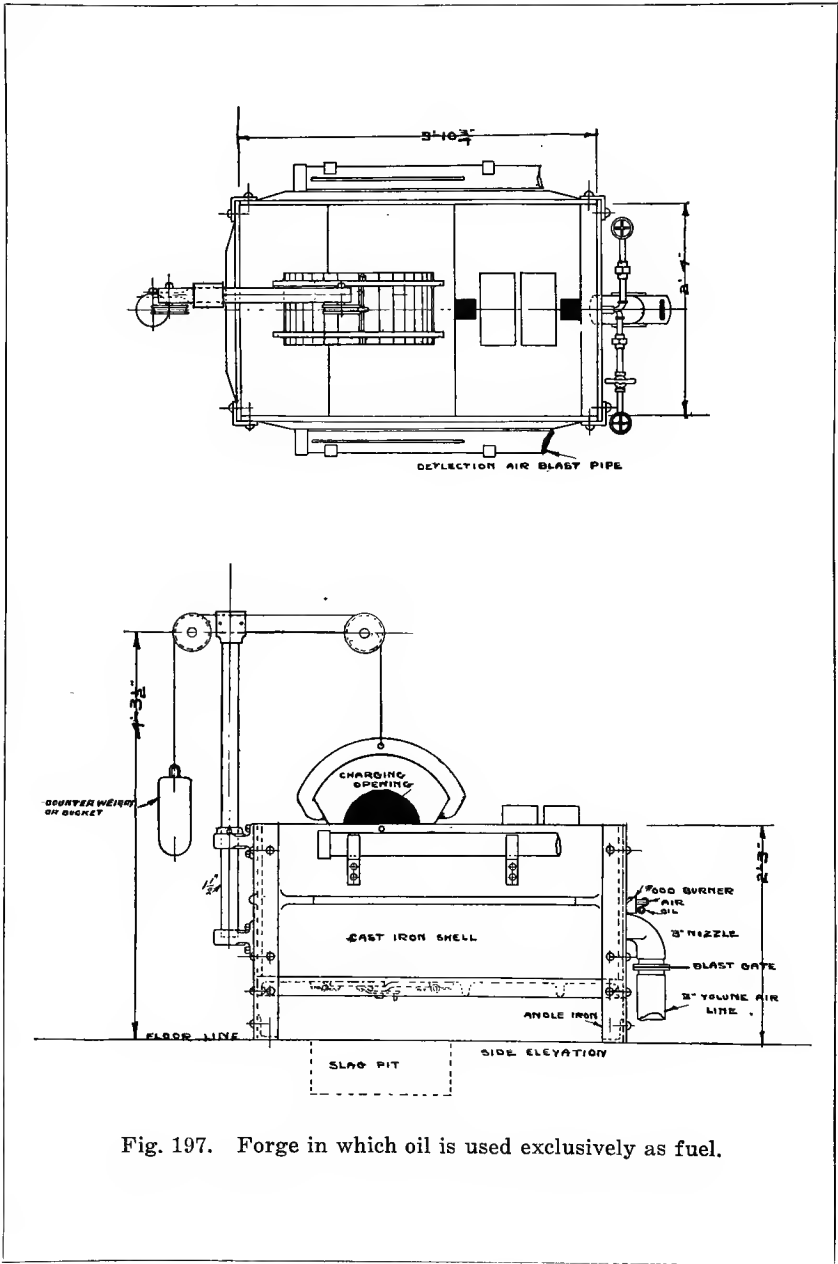

Fig. 197. Forge in which oil is used exclusively as fuel.

machine. In either case, it will serve both machines to the limit of the physical endurance of the operators. If desired for rivet heating in larger quantities, various sizes can be heated at one time.

A large coal-fired forging furnace is changed to oil fuel by simply building a combustion chamber of proper form and proportions in the former fire-box and placing a burner at the end of this combustion chamber. With this slight change the operator has now an oil furnace wherein the fire is under perfect control and from which he obtains a maximum quantity of output of superior quality. When a furnace of this type (Fig. 199) is changed from coal to oil, the operator almost invariably wishes to operate the furnace just the same as when burning coal. That is, by having an abundance of



Fig. 198. Furnace serving two bolt headers.

flame (about 2 ft. high) passing out of the door opening. You might thus run an oil-fired furnace for days without getting a welding heat, but when the oil is regulated so that only a greenish haze about 6 in. long passes out of the door, CO_2 is effected and in a few moments in the interior of the furnace can be seen a glow which insures a welding heat, thereby giving not only the highest efficiency from the fuel but also the greatest output from the furnace.

For dressing drills and other high speed steel tools it is convenient to have a furnace of the type shown in Fig. 200. This furnace is also valuable for a wide range of forging in smith shops, etc. Placed

between two bolt heaters, a furnace of this type with charging opening on each side, will serve both machines to the limit of the men's ability to handle the blanks. A furnace with two charging openings will produce double the output of the same size furnace with only one opening, with increase in oil consumption of less than 30 per cent.

The man or firm who intends to continue in business and compete with modern methods must of necessity use liquid fuel for the manufacture of drop forgings as with this can be produced the

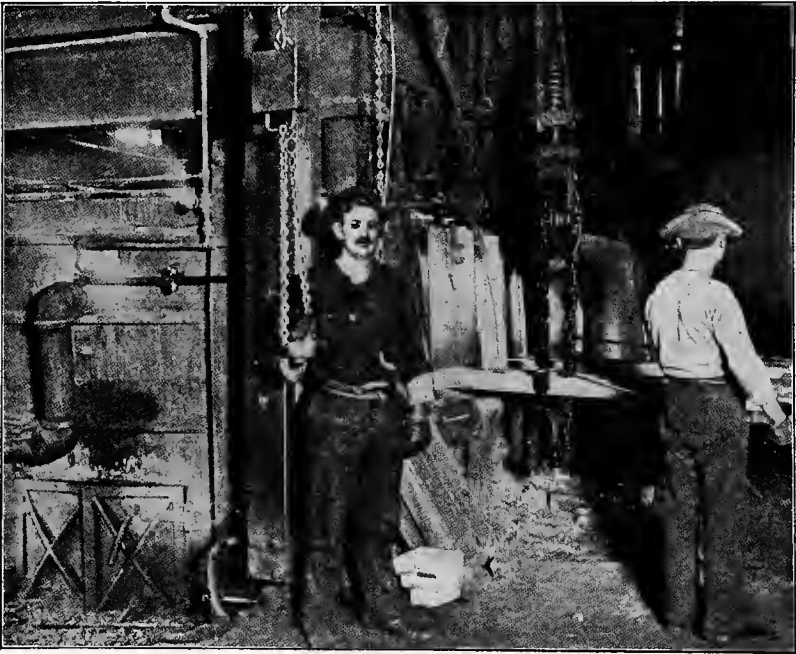

Fig. 199. Forging furnace changed from coal to oil-fired.

maximum quantity of output of superior quality in minimum time. Anyone who has used oil as fuel quickly notices the softness of the heat. That is, oil produces a penetrating heat so that the metal is thoroughly heated throughout its entirety, while that heated with coal, coke or gas is subjected to an abrasive heat so that the outside of the blank or forging is heated much hotter than the center. Because of the penetrating heat produced by liquid fuel, oil heated

blanks and forgings are forged quicker, with less power, and there is also a saving on the dies. Furnaces (Fig. 201) for this purpose should be of such design that the heat will be evenly distributed throughout the charging zone and a proper size combustion chamber used to reduce the oxidization of the metal to the minimum.

A 12-in. billet charged into the furnace shown in Fig. 202, after

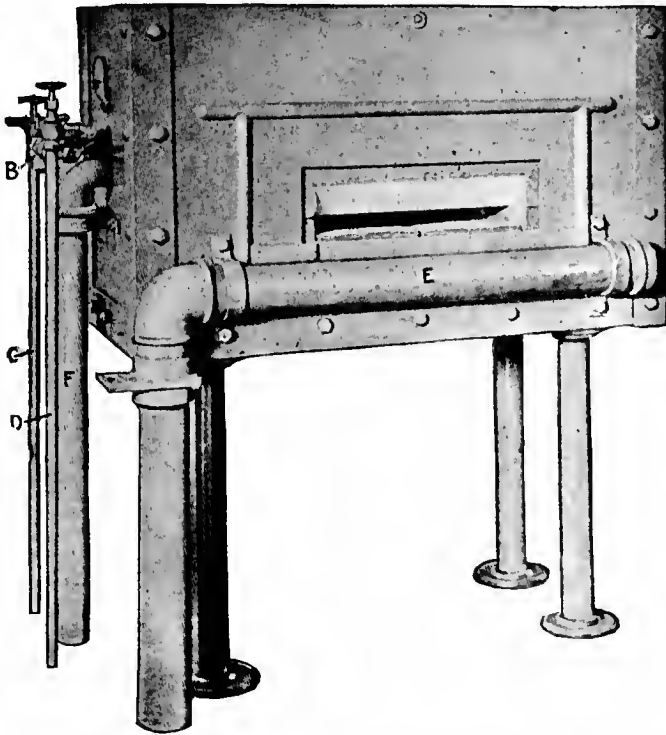

Fig. 200. Furnace for heating high speed steel, etc. A—Oil burner. B—Oil regulating cock. C—Air pipe. D—Oil pipe. E—Deflection blast pipe. F—Auxiliary blast.

it has been shut down over night can be brought to a forging heat in 45 minutes. A 10-in. square ingot or billet can then be brought to a forging heat in 32 minutes. This furnace is used for annealing, tempering, heating, forging and welding large billets, shafts, etc. As there are two charging openings opposite one another, heats can be taken on any portion of long shafts or billets. In many plants

this furnace is operated with compressed air as long as that is available. When the air is needed for pneumatic tools, etc., by simply opening a by-pass valve, steam at boiler pressure is used to atomize the fuel. Either steam or volume air (at from 3 to 5 oz. pressure) is used through the deflection blast in front of the charging opening to deflect the heat from the operator and retain it in the furnace.

In Fig. 203 we have an 8 ft. x 24 ft. furnace used for years in

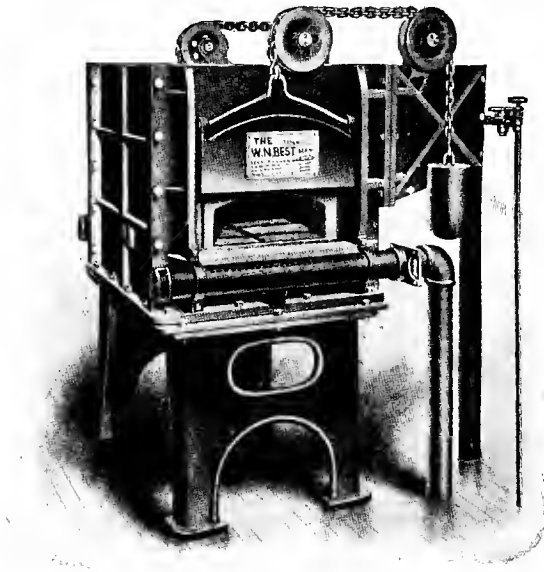

Fig. 201. Small drop forging furnace.

rolling mills or large blacksmith shops, where they have to use all kinds of scrap iron which must be brought up to a welding heat before passing through the rolls or forged under the steam hammer. Only one burner is used, but this, giving a fan-shaped flame and used in conjunction with a combustion chamber of proper size, causes an even distribution of heat throughout the entire length and width of the furnace. The waste gases, passing up through a 350 H. P. vertical water-tube boiler, are utilized for the generation of steam.

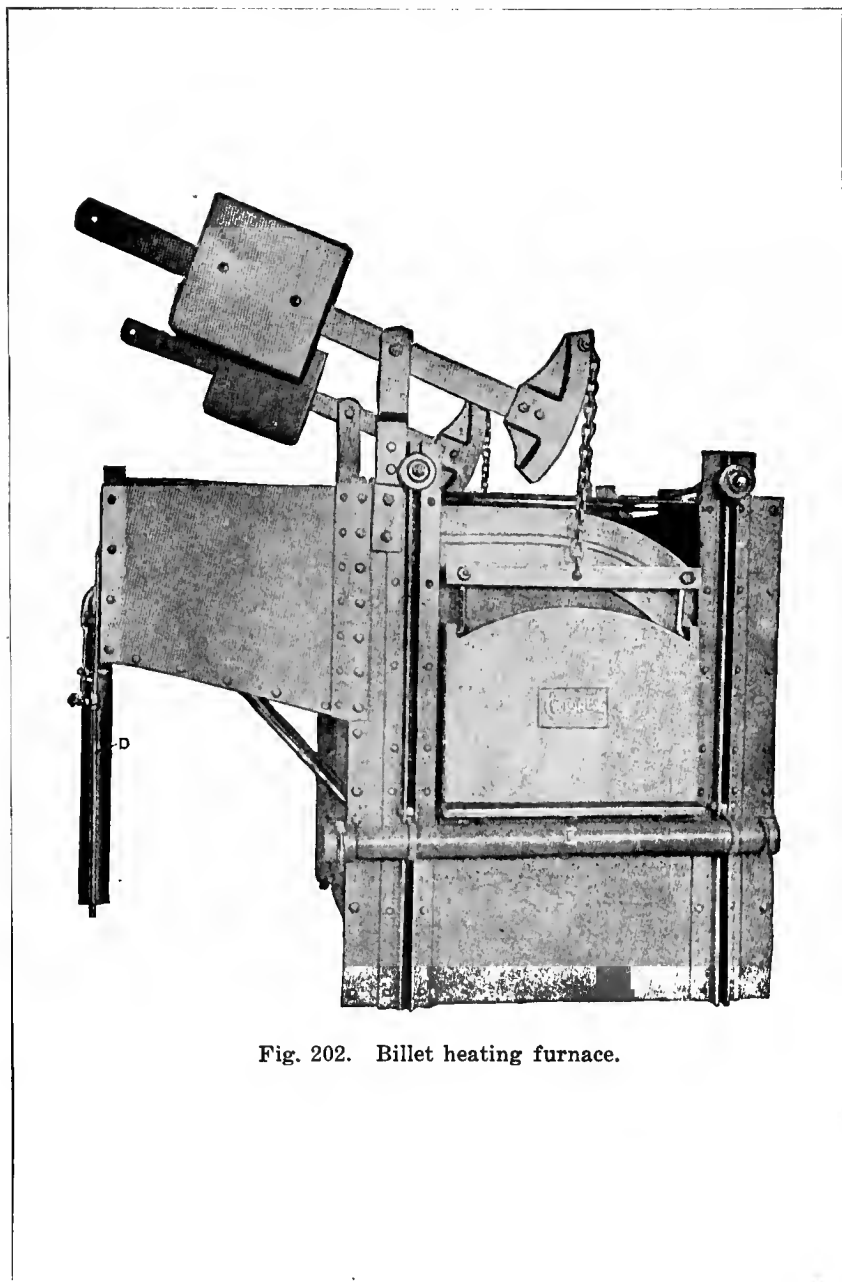

Fig. 202. Billet heating furnace.

BURNING LIQUID FUEL

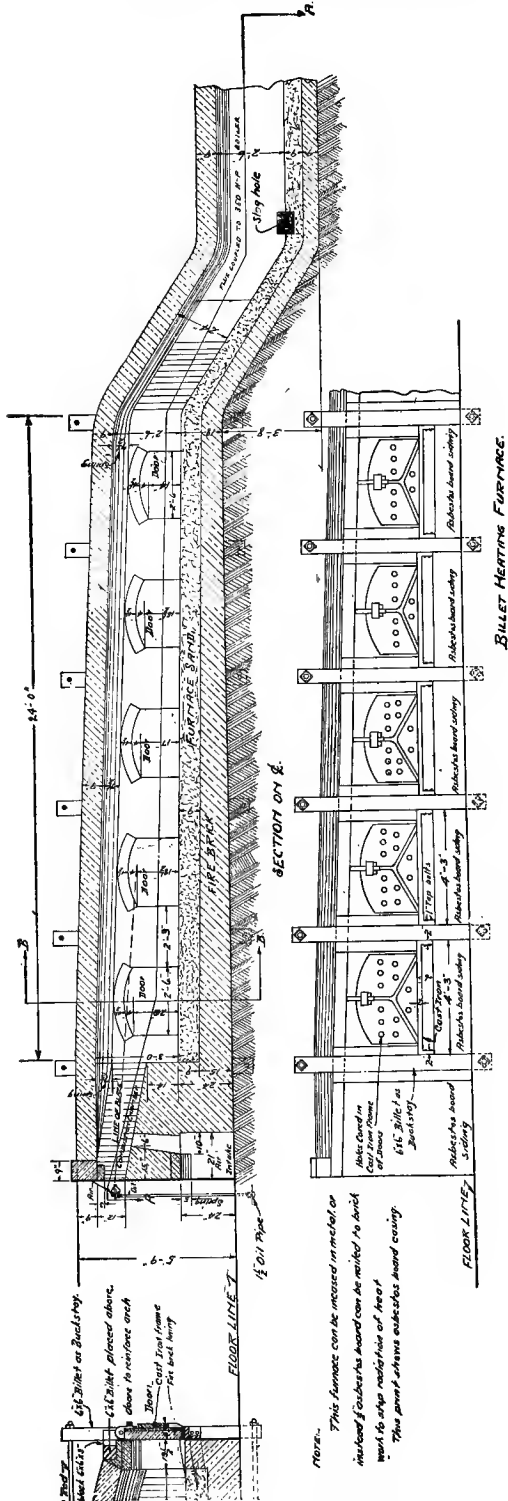

Fig. 203. Rolling mill billet heating furnace attached to waste heat boiler.

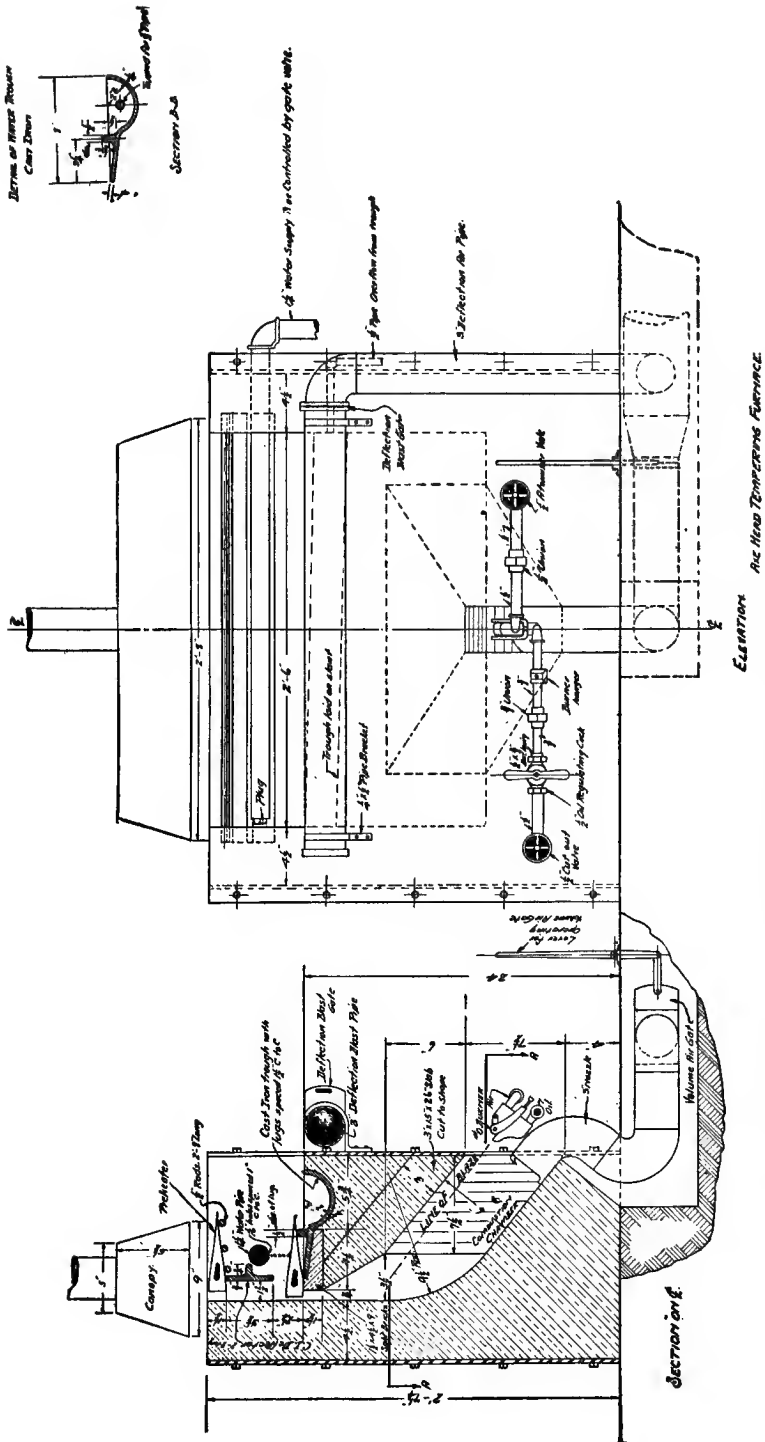

Fig. 204. Axle head tempering furnace, capacity 2,000 heads per day.

In many plants there is great need for a furnace designed for dressing and tempering high speed tools (60 carbon upwards), such as lathe, planer, shaper, slotters, chisels, flats, capes, etc. (Fig. 205.)

Instead of the blacksmith heating but one chisel at a time as is the case while using a coal forge, with this furnace seven chisels

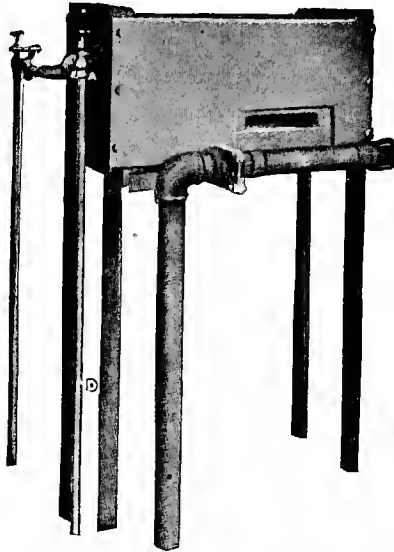

Fig. 205. Small tool dressing furnace.

can be heated at once without injury to the metal. The heat being held at the required temperature constantly, a much superior tool is produced than could possibly be made by the use of coal or coke. A forging heat can be obtained eight minutes after starting the cold furnace and it is not necessary to speak of the output as that is up to the endurance of the man operating the furnace. There is no waste of fuel while the furnace is not in use.

Chapter XV

BOILER MANUFACTURERS' FURNACE EQUIPMENT

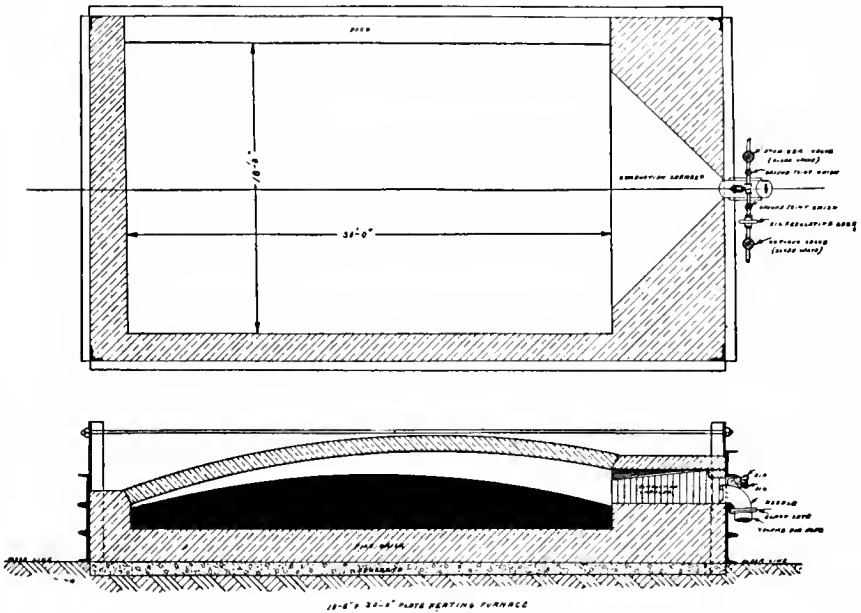

Fig. 208. Plate heating furnace, charging space 18 ft. x 30 ft.

Ordinarily only one burner should be installed in the average plate heating furnace if you want a good even heat, but this should be a burner giving a flat fan-shaped flame, which in conjunction with a combustion chamber of adequate proportions, distributes a blanket of flame and heat evenly throughout the entire length and width of the furnace. Sometimes, however, it is advantageous to have a furnace in which plates of various lengths can be heated. That shown in Fig. 209 has two bag-walls and for short heats only

the first burner is operated. For longer heats the first bag wall is removed and two burners used. For full length heats both bag walls are removed and all three burners operated.

In the furnace shown in Fig. 213, the bars are charged in at one end of the furnace and drawn out at the other end. For small rivets, some people prefer to cut the bars into lengths of eight or nine feet. The length of furnaces of this type will vary according to the sizes of the rivets to be made and the length of the bars to be heated as blanks for the rivets.

For a wide range of small work in a small shop, the little furnace shown in Fig. 214 is ideal. For instance, in many plants one

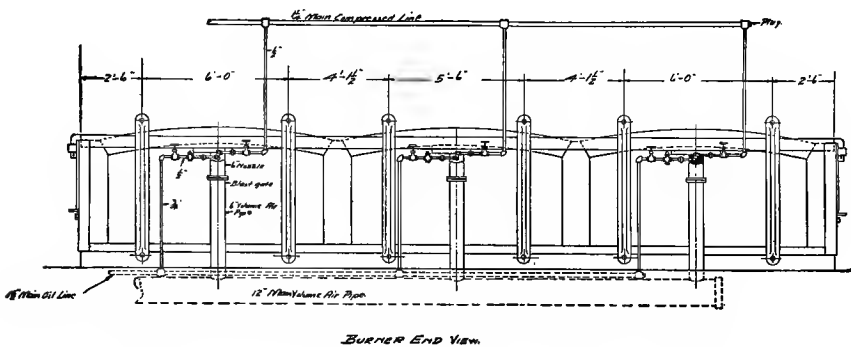

Fig. 209. Long plate heating furnace with two bag walls.

of these little furnaces is used for forging, rivet heating, annealing, hardening dies, dressing high speed steel tools, and by placing a muffle in the charging space it is used as a muffle annealing and tempering furnace. It heats rivets uniformly and on $2\frac{1}{2}$ gallons of oil per hour is equal to four coal forges, the maximum capacity being eight thousand $\frac{3}{4}$ -in. x 3-in. rivets per day (ten hours). Either compressed air or dry steam can be used to atomize the fuel. The burners on about 60% of these furnaces are operated with steam.

While a small furnace (Fig. 214) is ideal for heating small rivets, larger rivets should be heated in a larger furnace, preferably of the twin charging type (Fig. 215). Some rivets can in this type of furnace be shoveled in through one of the openings and while

that batch of rivets is being heated, others (which had been previously charged) are being withdrawn from the other opening. In using a bull riveter it is necessary to heat the rivets quickly and at the same time reduce the scale as much as possible. It is therefore essential to have a combustion chamber on the furnace so as to reduce the oxidization of the metal to the minimum.

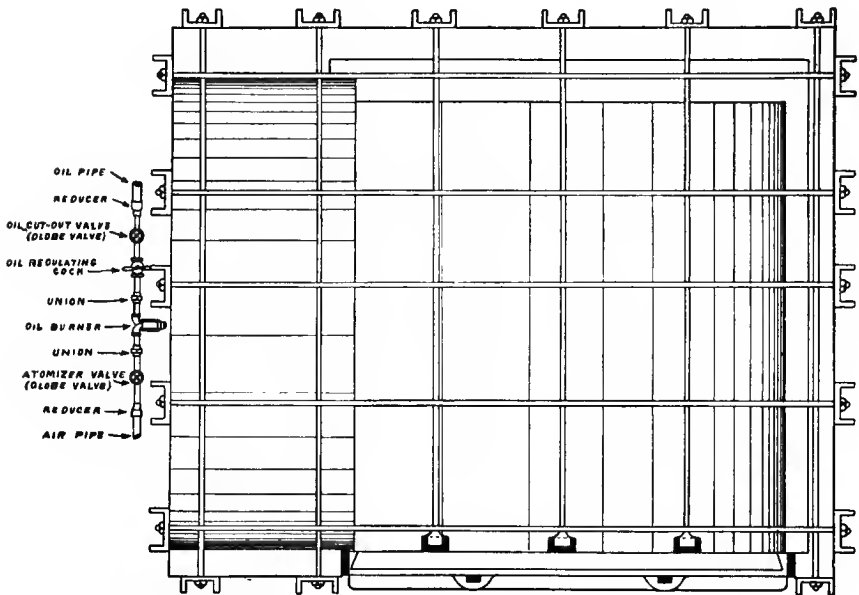

Fig. 210. Plate heating furnace, charging space 8 ft. x 9 ft.

Fig. 216. A self-contained portable outfit with 20 gallon oil tank, which can readily be moved around from place to place and which is used for heating rivets as well as for forging, tool dressing, etc. Very convenient for small work in shops not equipped with the regular oil system as well as for work where portable outfit is necessary. Compressed air at pneumatic tool pressure is used to operate this outfit. That is, the full pressure is used through the burner to atomize the fuel and distribute the heat, and through the deflection blast in front of the charging opening to deflect the heat from the operator and to retain it in the furnace, but the air used on the tank

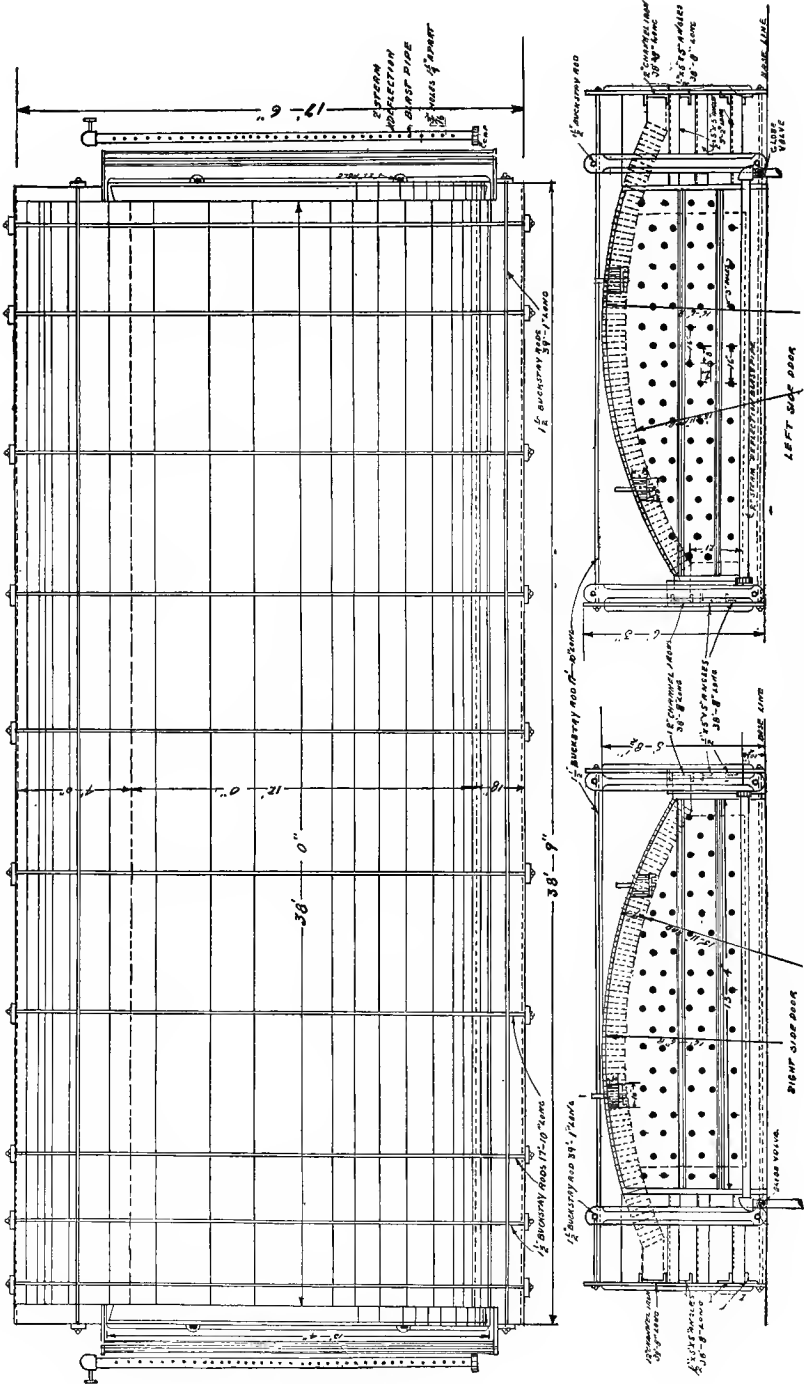

Fig. 211. Long plate heating furnace, charging space 12 ft. x 38 ft.

BOILER MANUFACTURERS' FURNACE EQUIPMENT 247

to force the oil to the burner is reduced from pneumatic tool pressure to 12 lbs. as it passes through a pressure reducing valve. This device is most essential to prevent excessive pressure on the oil tank and safeguard human life.

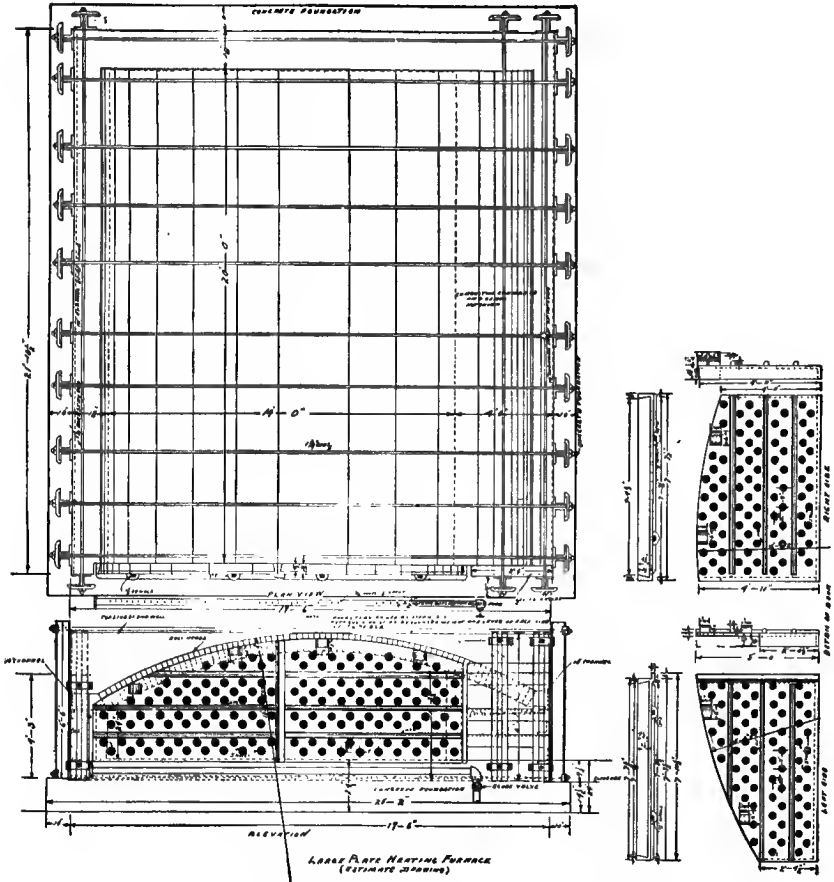

Fig. 212. Flange furnace, twin door type, charging space 14 ft. wide by 20 ft. long.

Angle heating furnaces are needed in boiler works, shipyards, etc. That shown (Figs. 217, 218, 219 and 220) is so constructed that you only operate as many burners as are actually required. In this

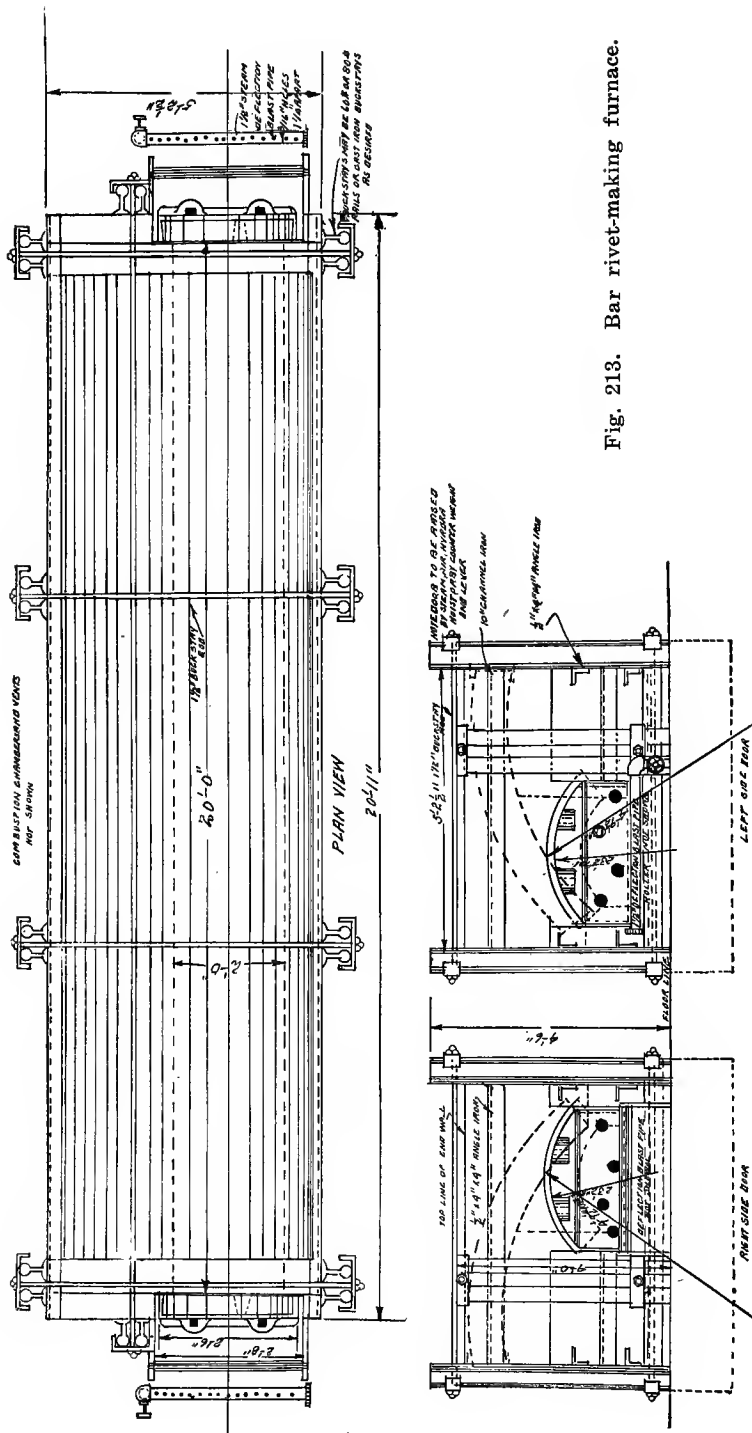

Fig. 213. Bar rivet-making furnace.

BOILER MANUFACTURERS' FURNACE EQUIPMENT 249

particular furnace heats varying in length from six to sixty-seven feet can be taken, but of course the furnace could have been constructed for taking heats one hundred feet long equally as well if desired. No stack is used upon this type of furnace.

Until quite recently wood was used for firing up boilers in boiler shops for testing purposes, or in locomotive works for rais-

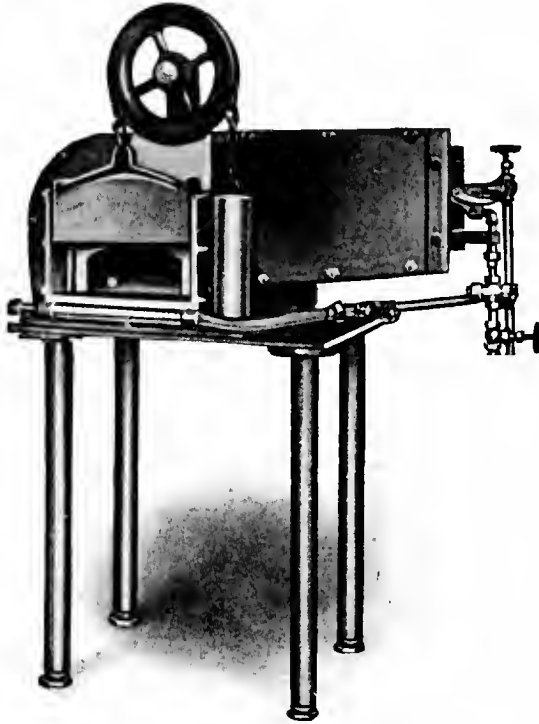

Fig. 214. Small forging furnace.

ing steam to set pops when the locomotive is completed. By using oil instead of wood for this purpose there is 50 per cent. saving in time and cost. With an apparatus such as shown in operation in Fig. 221 the operator has the fire under perfect control, and one man can look after 5 or 6 furnaces at a time. For the largest Mogul engine we use either one furnace, such as shown in Fig. 222 which gives a fan-shaped incandescent flame 18 inches to 10 feet

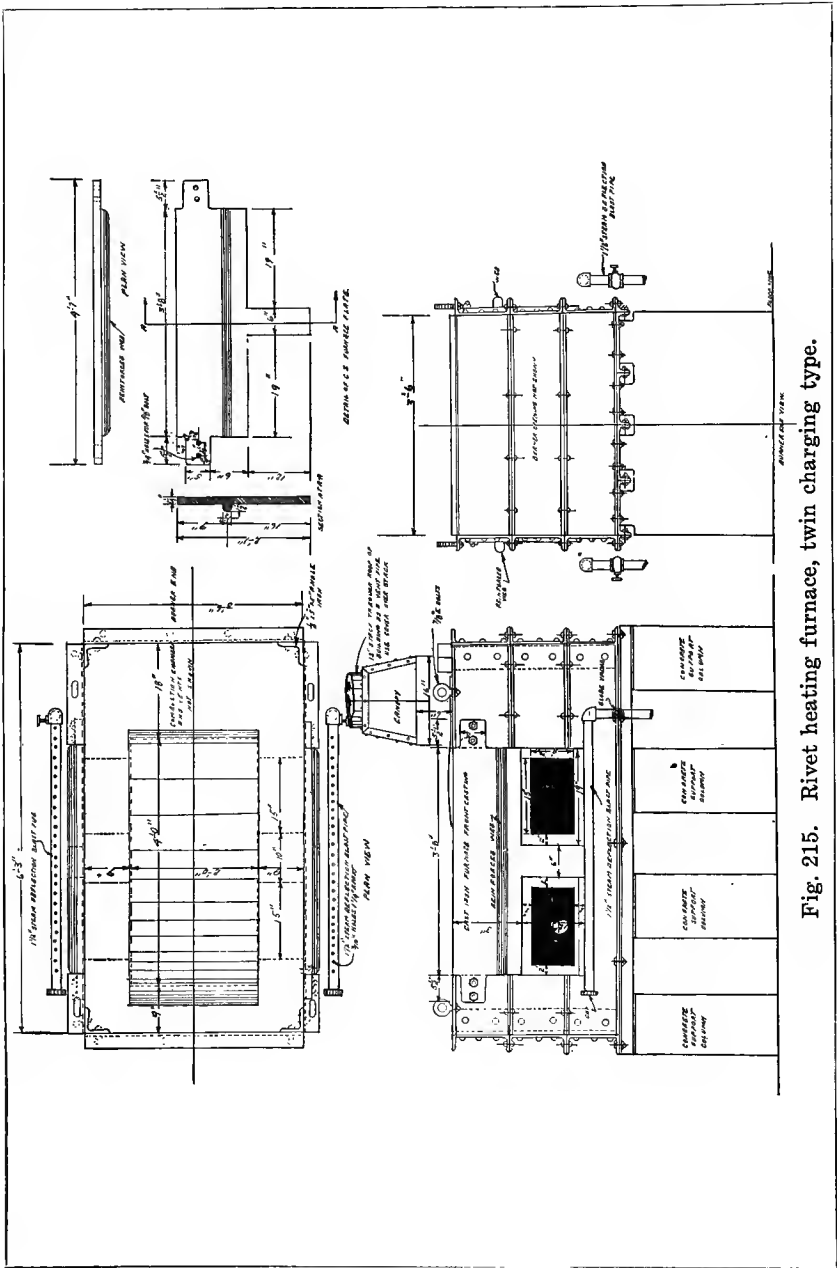

Fig. 215. Rivet heating furnace, twin charging type.

BOILER MANUFACTURERS' FURNACE EQUIPMENT 251

in length at a point 6 feet from the furnace, the flame being 4 feet wide, or two of the smaller portable furnaces shown in Fig. 223, which give a round incandescent flame 1 foot long, 3 inches in diameter to 6 feet long and about 10 inches in diameter. For a smaller size locomotive ordinarily one of the furnaces shown in Fig. 223 is used.

These furnaces are also used for a multitude of other purposes



Fig. 216. Portable, self-contained outfit for rivet heating, etc.

such as setting up corners of fire-box sheets to mud-rings; flanging, laying on patches, heating crown sheets, heating and welding band rings; bending pipe up to 16-inch diameter without sand filling; (straight pipe is laid on bending table with a shaper arranged to suit curve; one end of pipe is clamped, and pipe bent

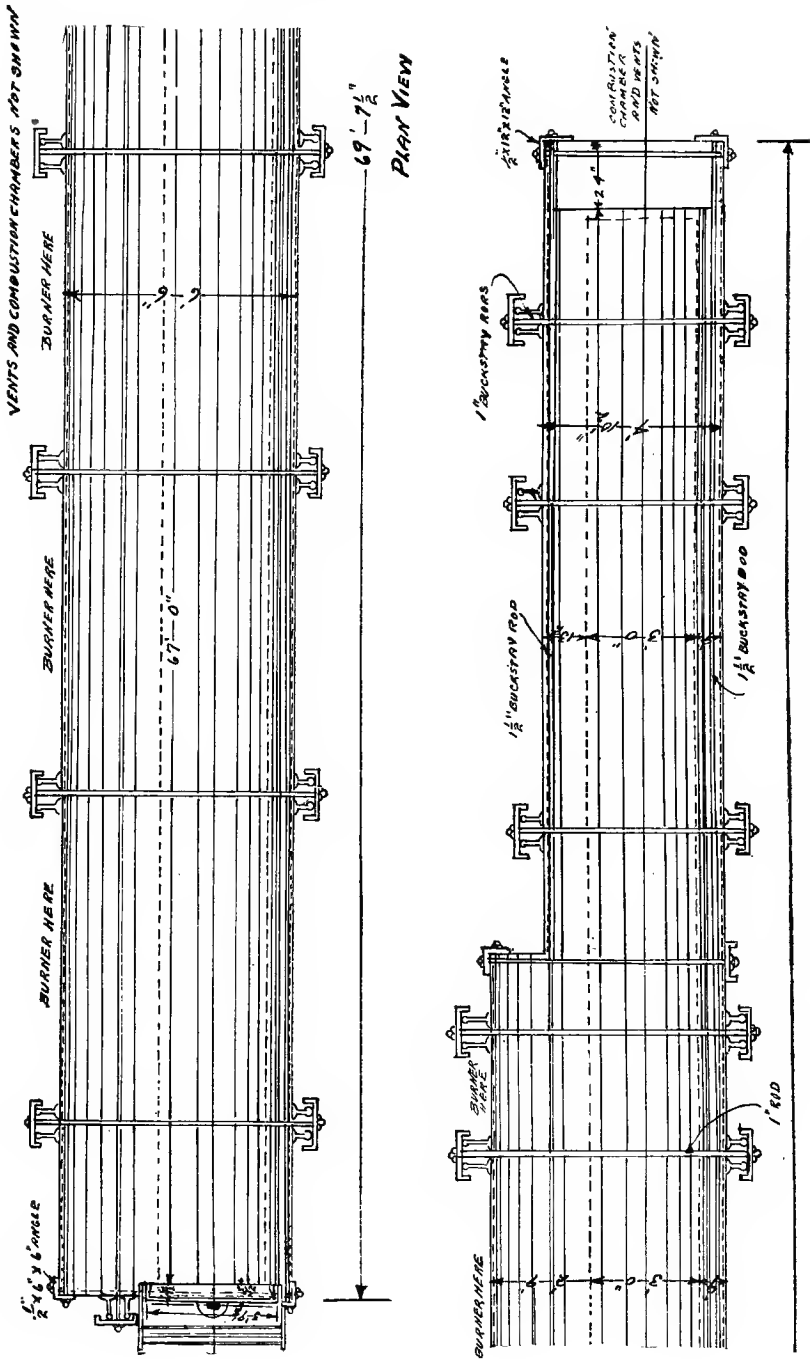

Fig. 217. Angle heating furnace—plan view, furnace cut into two sections.

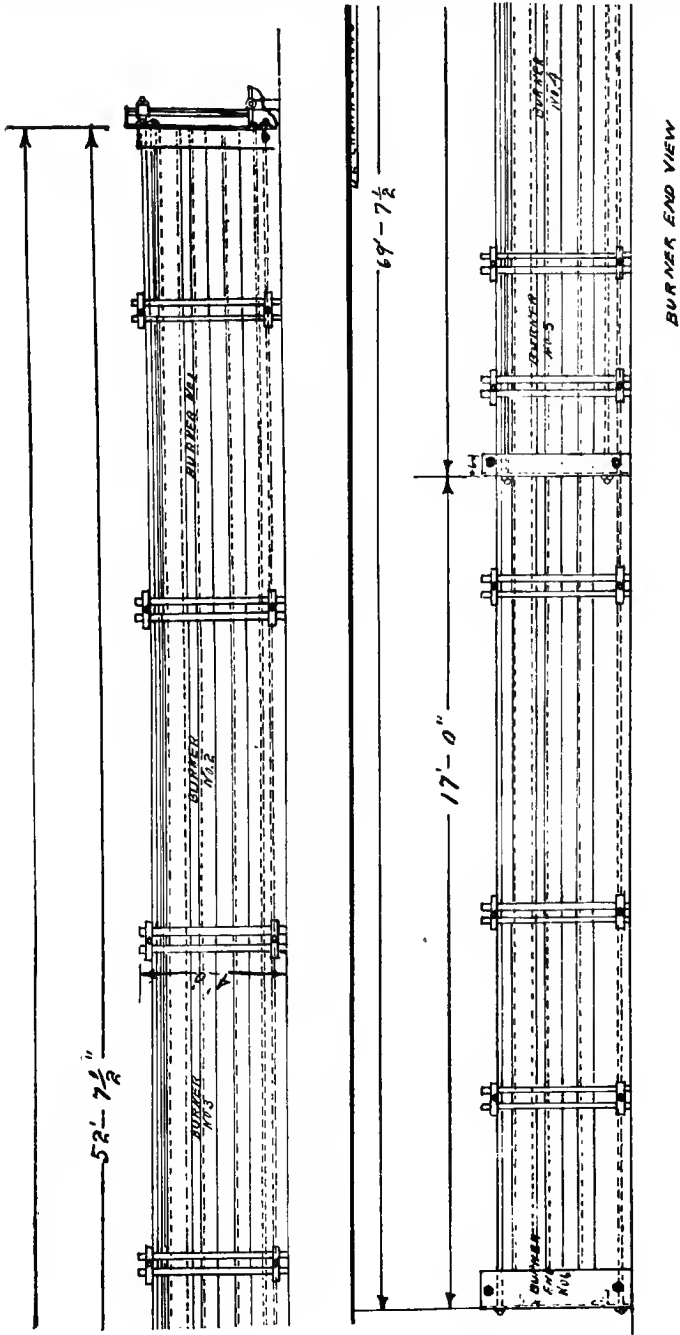

Fig. 218. View of angle heating furnace showing the six burners. (Furnace cut into two sections.)

after heat is applied to outside of bend, thus stretching metal on the outside, without buckling inside of bend); straightening bent frames after a wreck, etc., etc.

Referring to Fig. 223 you will note that compressed air (pneumatic tool pressure) is used to operate this equipment. The full pressure is used through the burner to atomize the fuel and distribute the heat, but the air used to force the fuel from the tank

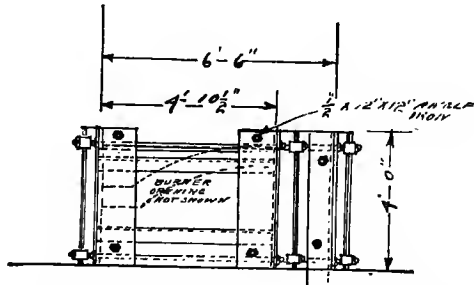

Fig. 219. End view of angle heating furnace, showing the location of the sixth burner.

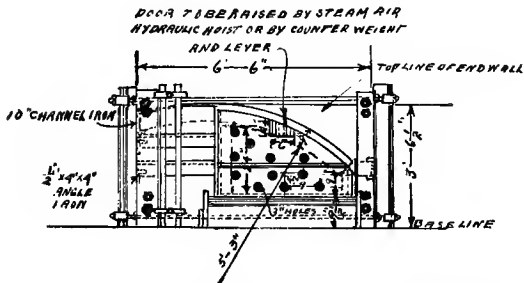

Fig. 220. Door end view of angle heating furnace.

to burner passes through a reducing valve which reduces it from pneumatic tool pressure to 10 pounds on the tank. To safeguard human life this pressure reducer is most essential.

The welding of the rudder of the "Brutus" in 1905 was considered a remarkable achievement at that time, for it was the first time in the history of any navy yard or private ship yard that a weld had

BOILER MANUFACTURERS' FURNACE EQUIPMENT 255

been successfully made under these conditions, using oil as fuel. The feat was accomplished with the author's equipment. It is possible with oil as fuel to make a better weld than can be made with any other fuel, for the metal is made more homogeneous.



Fig. 221. Portable furnace, resting in fire door opening, firing up a locomotive boiler.



Fig. 222. Portable furnace shown in operation in Fig. 221.

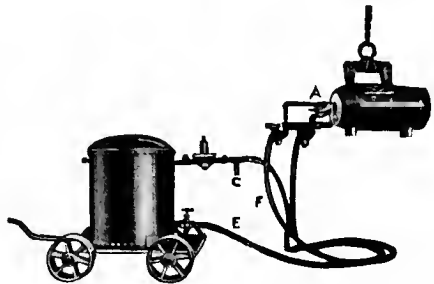

Fig. 223. Smaller portable furnace with hose and tank on truck.

There are three ways of welding locomotive frames. Thermit and oxy-acetylene are efficient but very costly, while with oil in about 40 minutes with a few gallons of oil a perfect weld is made.

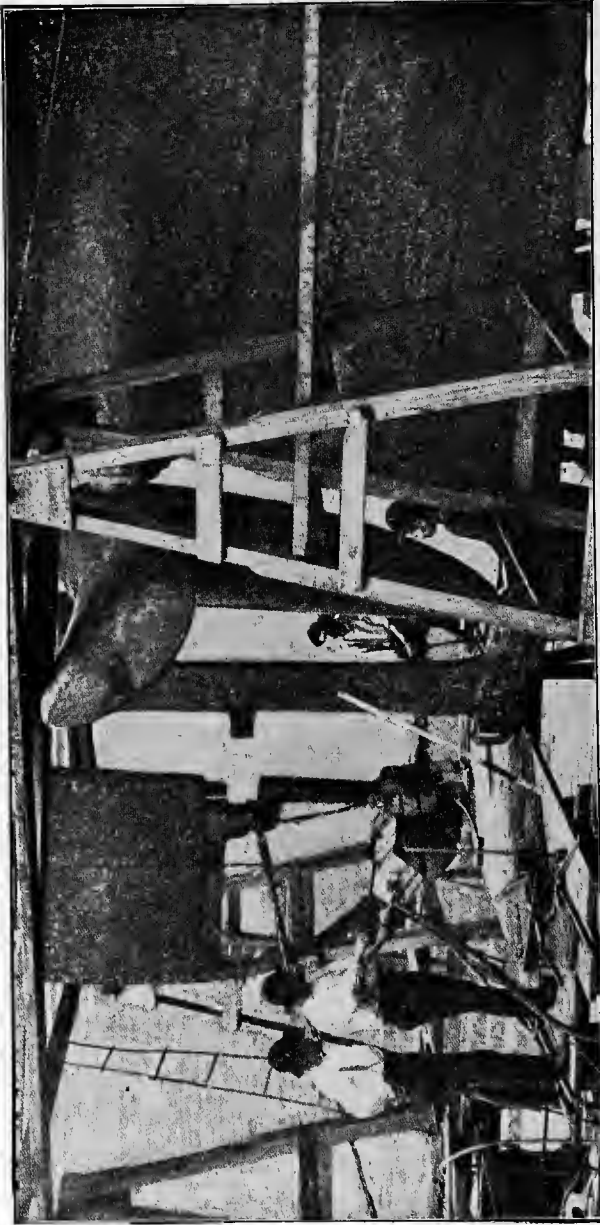
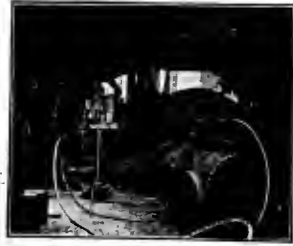

Fig. 224. This photograph was taken on August 10, 1905, while welding the rudder on the United States Collier "Brutus" without removing the rudder from the vessel.



1. A—The insert or Dutchman.



2. Furnace in operation.



3. Note the constancy of heat and perfect combustion.



4. A—The perfect weld.

Fig. 225. The welding of a locomotive frame with a small portable furnace.



Fig. 226. The little giant which did the trick shown in Fig. 225.

Of course the expense entailed for labor in making the weld is the same in either case. Complete story of perfect weld with oil is shown in Figs. 225 and 226.

The oil furnace shown in Fig. 226 is operated with a small quan-

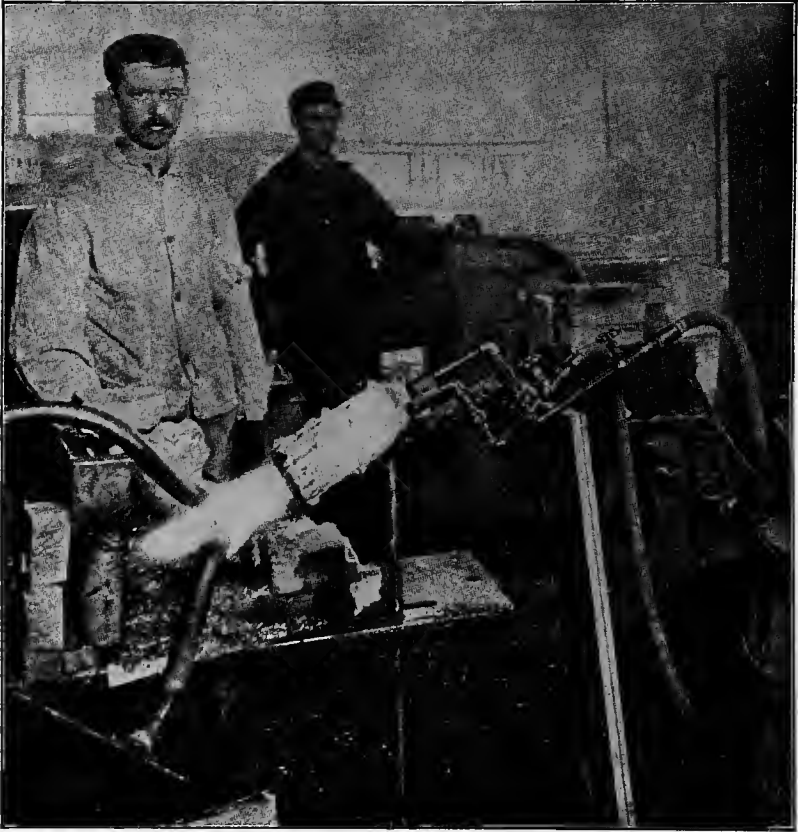

Fig. 227. Portable furnace brazing the exhaust pipe of an automobile engine.

tity of compressed air, and may be used for various other purposes such as flanging, laying on patches and laps, heating crown sheets, firing up and testing boilers in boiler shops; brazing and filling castings, ladle heating, melting or keeping metals hot in foundries; brazing, annealing and heating of all kinds in copper

shops; removing propeller wheels, straightening and bending on board vessel rudder frames, stern posts, keel, etc., pipe bending, etc.; melting metals in small quantities for laboratory tests, etc., heating rails for bending, etc.

Fig. 227. This furnace is mounted on a 5 ft. standard so that the apparatus can be adjusted to any height or angle needed for all kinds of heating purposes where it is desired to heat a small portion of the metal. The furnace may be removed from the stand and used



Fig. 228. A hand torch or very small portable furnace.

as a blow pipe for straightening or setting up work difficult of access. The tiny furnace is lined with refractory material. This becomes heated lily-white and insures a constant steady flame even when the oil supply is cut very low. With apparatus having a metal combustion chamber not lined with refractory material there is always more or less difficulty with the fire not burning steadily. The refractory material also aids combustion and prevents oil being thrown out with the flame.

Hand Torches (Fig. 228), made in various sizes, are very economical and efficient for all classes of light heating purposes, such

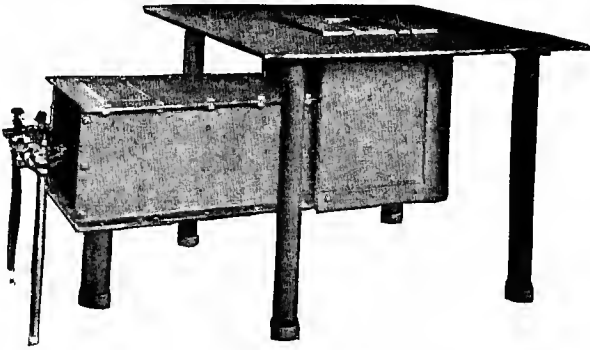

Fig. 229. Furnace for pipe bending, brazing, etc.

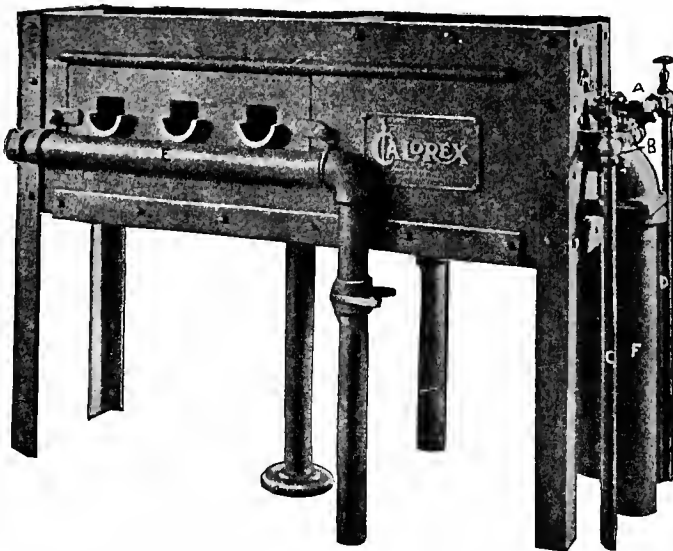

Fig. 230. Flue welding furnace.

as skin-drying moulds, lighting cupolas, heating tires, light brazing, burning paint off steel cars, etc.

With the furnace shown in Fig. 229 a five-inch copper pipe can be brazed in four minutes, starting with a cold furnace. This furnace is designed for pipe bending and brazing, but it is not advisable to use it for welding.

Fig. 230. A modern flue welding furnace, the capacity of which is 60 welds of safe ends on 2-in. or 2¼-in. locomotive boiler tubes per hour, while with a coal forge 16 flues per hour is considered

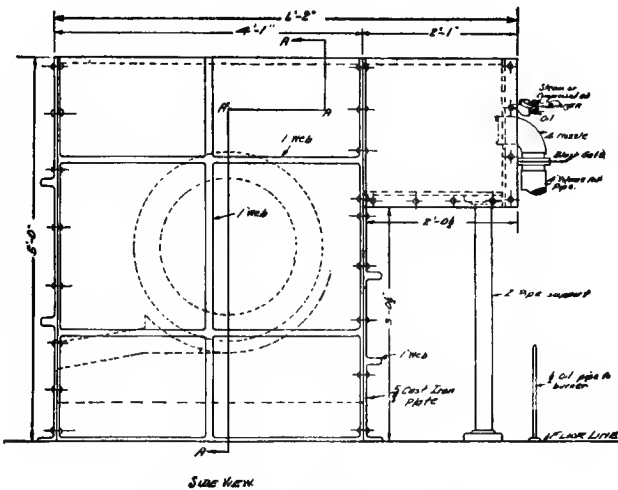

Fig. 231. Pipe welding furnace.

good practice. With either fuel the blacksmith requires two helpers, the difference being that with coal a blacksmith has to work much harder than his two helpers do, for he must keep turning the flue or he will burn a hole in it, and he must constantly be putting on borax and sand or other welding compounds, whereas in this modern oil furnace his helpers can charge and remove the flues, no welding compounds being necessary. Three flues (instead of only one) are charged at a time. Oil welded flues are not water-tested as the welds are all perfect, there being no corrosion or oxidation of the metal. No time lost while waiting to renew or coke the fire.

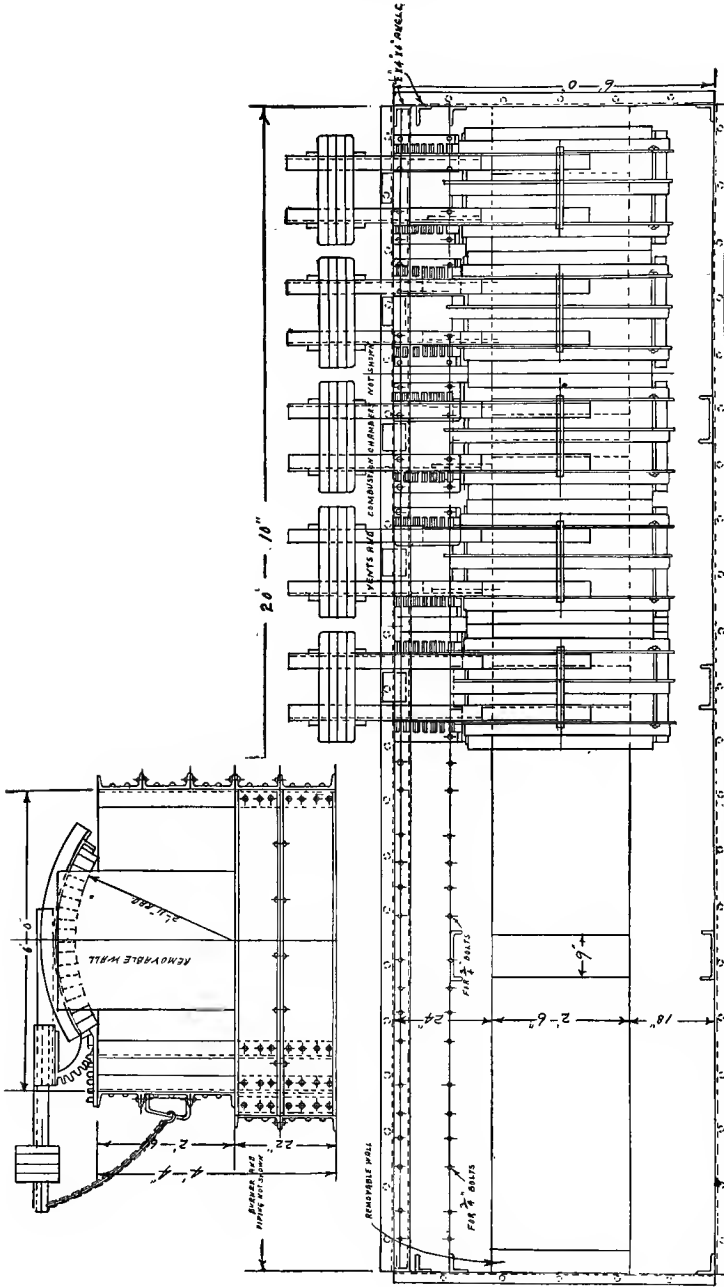

Fig. 282. Furnace for bending or annealing large pipe.

58 gallons of oil are equivalent to a ton of good bituminous coal in this class of service. When a smith, who all his life has been using coal for this class of work, discovers these facts, he concludes that oil is the marvel of the 20th century. A shop still using coal for this class of work is hopelessly behind the times and cannot expect to compete with its more modern neighbors. Flue welding furnaces are usually supplied with extra slide plates so that for welding larger size flues, the plates with the small openings can be removed, the plates for larger size flues put on and the openings in the brickwork cut to the required size. In handling 6-in. superheater flues ordinarily only two flues are welded at a time.

The furnace shown in Fig. 231 is operated with one burner and used for pipe welding, such as welding a flange on a 20-inch pipe, for van-stoning, etc.

The ends of the furnace shown in Fig. 232 can be removed so that a pipe of any length may be heated. This furnace is used also for annealing large pipe and for bending (after the pipes have been filled with sand).

Chapter XVI

COPPER INDUSTRY EQUIPMENT

A copper refining furnace must be so equipped that the operator has the fire under perfect control at all times. That is, at times a reducing flame is necessary, while at other times an oxidizing flame is required. Only one burner should be used in a 120-ton furnace, as shown in accompanying cut, but this must spread a blanket of flame over the entire surface of the bath or charging space, which in this case is 14 feet wide by 26 feet long. I am aware that attempts have been made to use a large number of burners, installed along the sides of the furnace, with operating valves for each burner, but the operation of the furnace under these conditions was so complicated the operator could not accurately regulate the flame, and if, during the refining process, the metal is oxidized, it becomes porous and when rolled into copper wire the porousness ruins the conductivity of the wire. With the one burner a small quantity of superheated steam or compressed air is used to atomize the fuel and distribute the heat in the furnace, but by far the greater portion of the air necessary for combustion is admitted through the volume air nozzle under the burner.

At the end of the furnace you will note the door used during the refining process for poling the charge (agitating the molten metal with a long wooden pole). In this door is a peep-hole through which the burner can be plainly seen at the opposite end of the furnace and all the operating valves are so placed that the operator, while viewing the burner, can quickly and accurately adjust the air and oil supply according to the requirements for the proper treatment of the metal.

Copper electrodes are charged into the refining furnace (Fig. 236) 90% pure and have to leave it at 99.60% or practically pure copper. After the metal has become molten, it is necessary to greenpole the charge until the state of purity required is obtained. During this time it is necessary to use an oxidizing flame, as an excess of oxygen is required in the furnace during this process; but

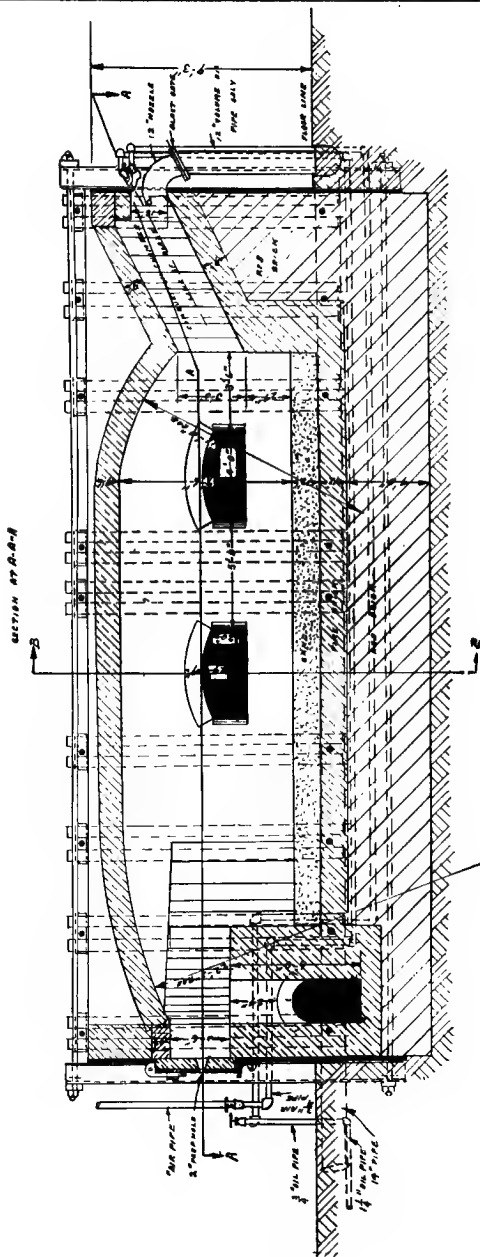

Fig. 235. 120-ton copper refining furnace.

after having obtained the proper refinement, it is necessary to at once change the flame of the burner from an oxidizing to a neutral flame, as otherwise it would oxidize the charge. After reaching the required state of refinement, if you were to run an oxidizing flame for twenty minutes in this furnace, the result would be that when the copper taken from this furnace is drawn into wire, it would be full of miniature openings which would ruin its conductivity for electrical purposes. The capacity of this furnace is 250 tons of metal. This furnace is equipped with only one burner and only one burner should be used, because you cannot obtain the desired results with more than one burner in this type of furnace. It is, however, an engineering feat to design a combustion chamber of adequate proportions to give the desired results.

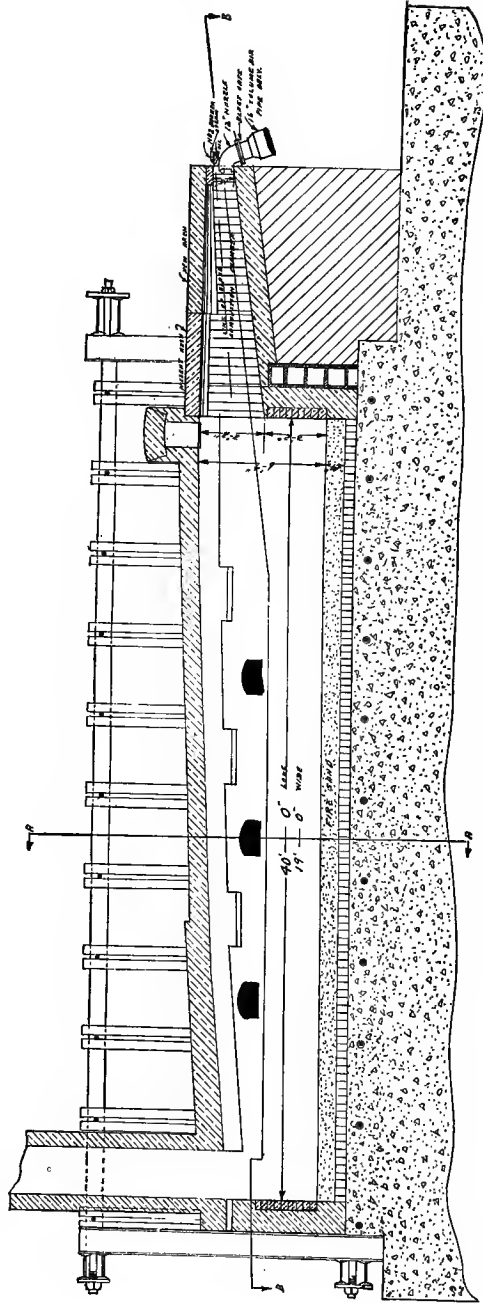

Fig. 236. Copper refining furnace—250-ton capacity.

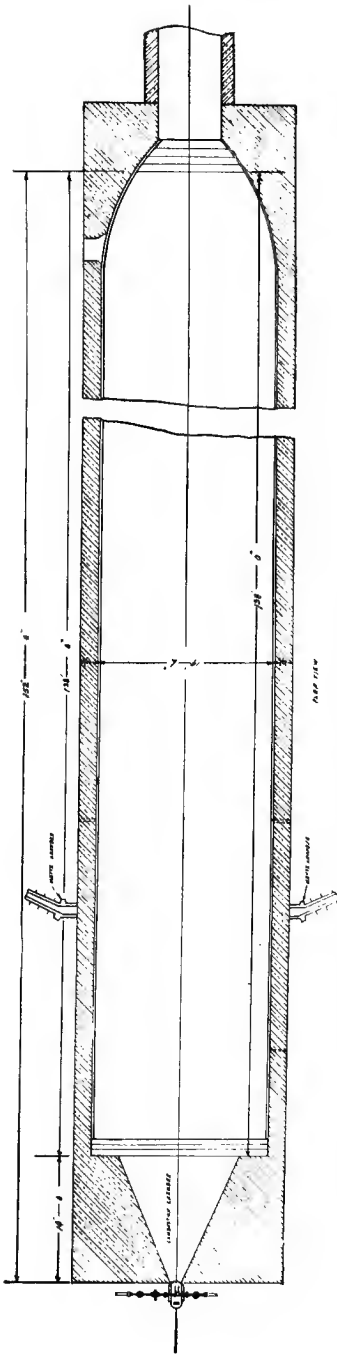

Fig. 237. Continuous copper mating furnace.

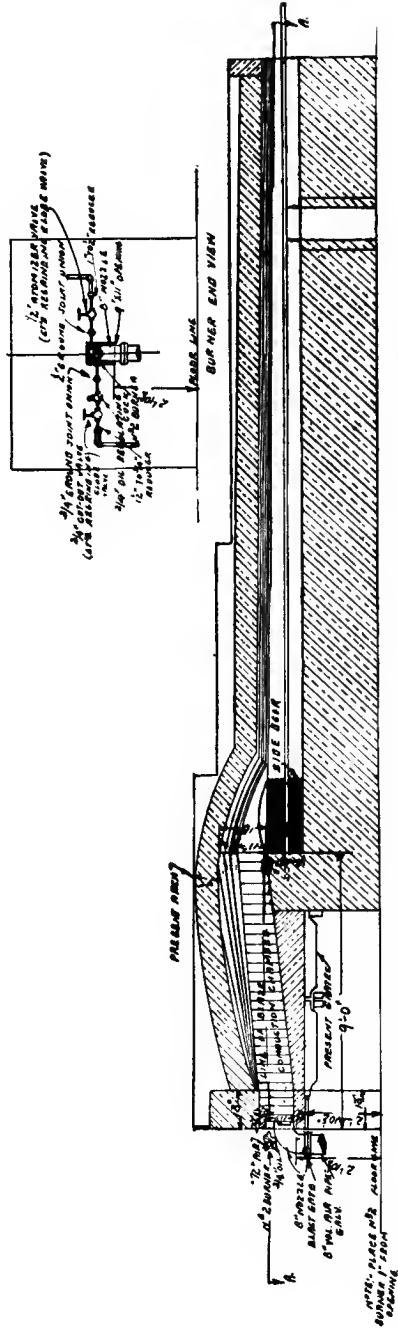

Fig. 238. Continuous copper billet heating furnace, changed from coal to oil-fired.

The continuous furnace used for copper matting (Fig. 237) has a bath nineteen feet wide, one hundred thirty-eight feet long. Only one burner is required, but this must be of adequate capacity to throw a flame which will cover the entire bath. Steam or compressed air is used through the burner for atomizing purposes and also volume air at three-ounce pressure is used through the volume air nozzle under the burner to aid the combustion of the atomized fuel. The copper is tapped out through the landers and the slag is hoed out of the slag door and hauled to the dump by a locomotive.

Chapter XVII

ENAMELING EQUIPMENT

There are two (2) forms of enameling furnaces, but these are of various sizes and types. In some classes of work it is absolutely essential to use the muffle type, such as shown in Fig. 240.

The direct-fired type of furnace is shown in Fig. 241 and 242. This furnace is heated to the required temperature, the burner shut off, the charging door raised and the charge placed in the fur-

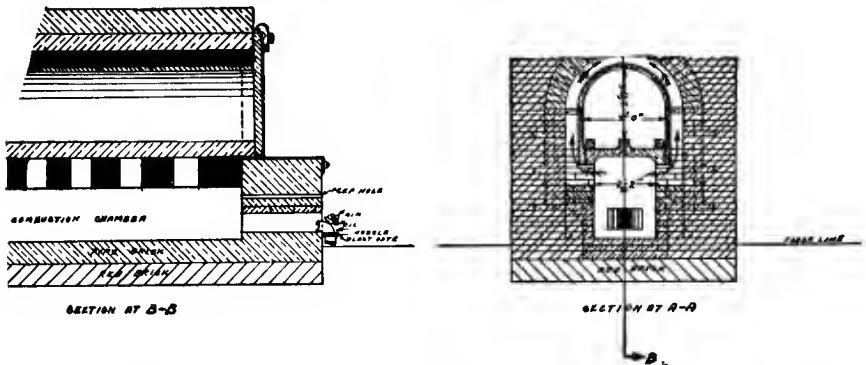

Fig. 240. Muffle furnace for baking enamel, annealing, etc.

nace for from six to eight minutes, or until the enamel is baked on to the ware, after which the charge is withdrawn and the burner again operated to bring the furnace up to the required heat for the second charge. As soon as a charge is baked, it is removed from the car or rack, and the rack refilled. Thus the furnace is operated continuously all the day.

Guessing at the temperature of an enameling oven is simply a waste of time, fuel and material. If a recording pyrometer is a necessity on a heat-treatment furnace, certainly it is equally as essential to use a recording heat gauge on these ovens so that the actual temperature may be a matter of daily record.

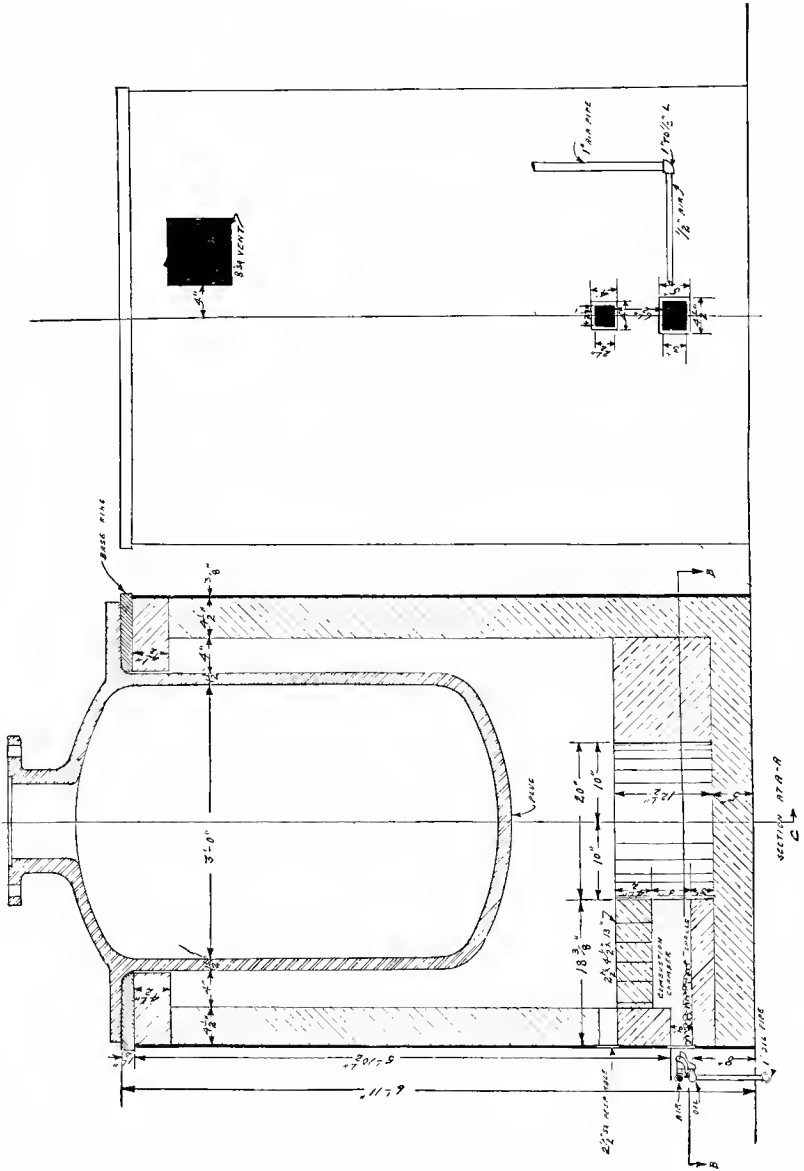

Fig. 247. Cylindrical chemical still. Tangential flame equipment.

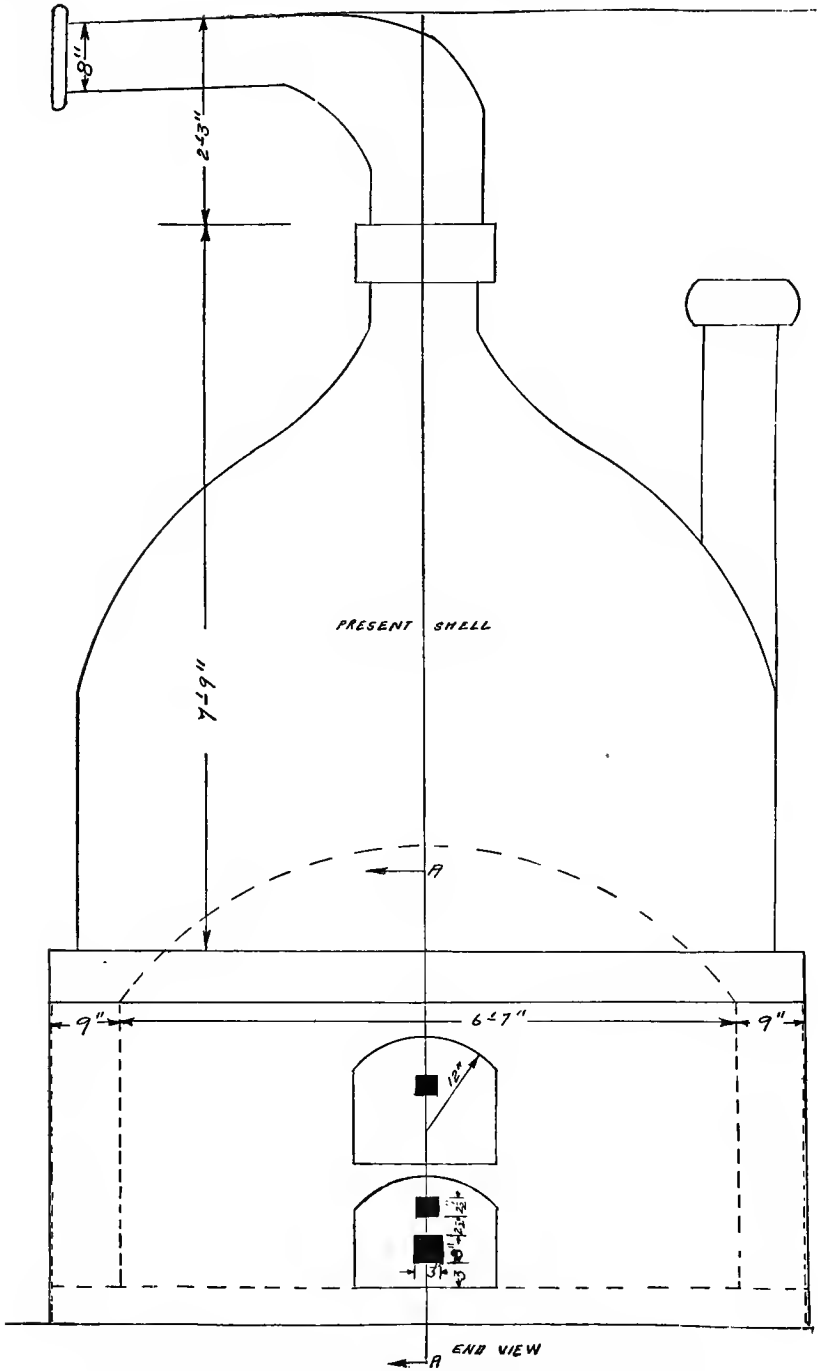

Fig. 249. Rosin still. View showing location of burner.

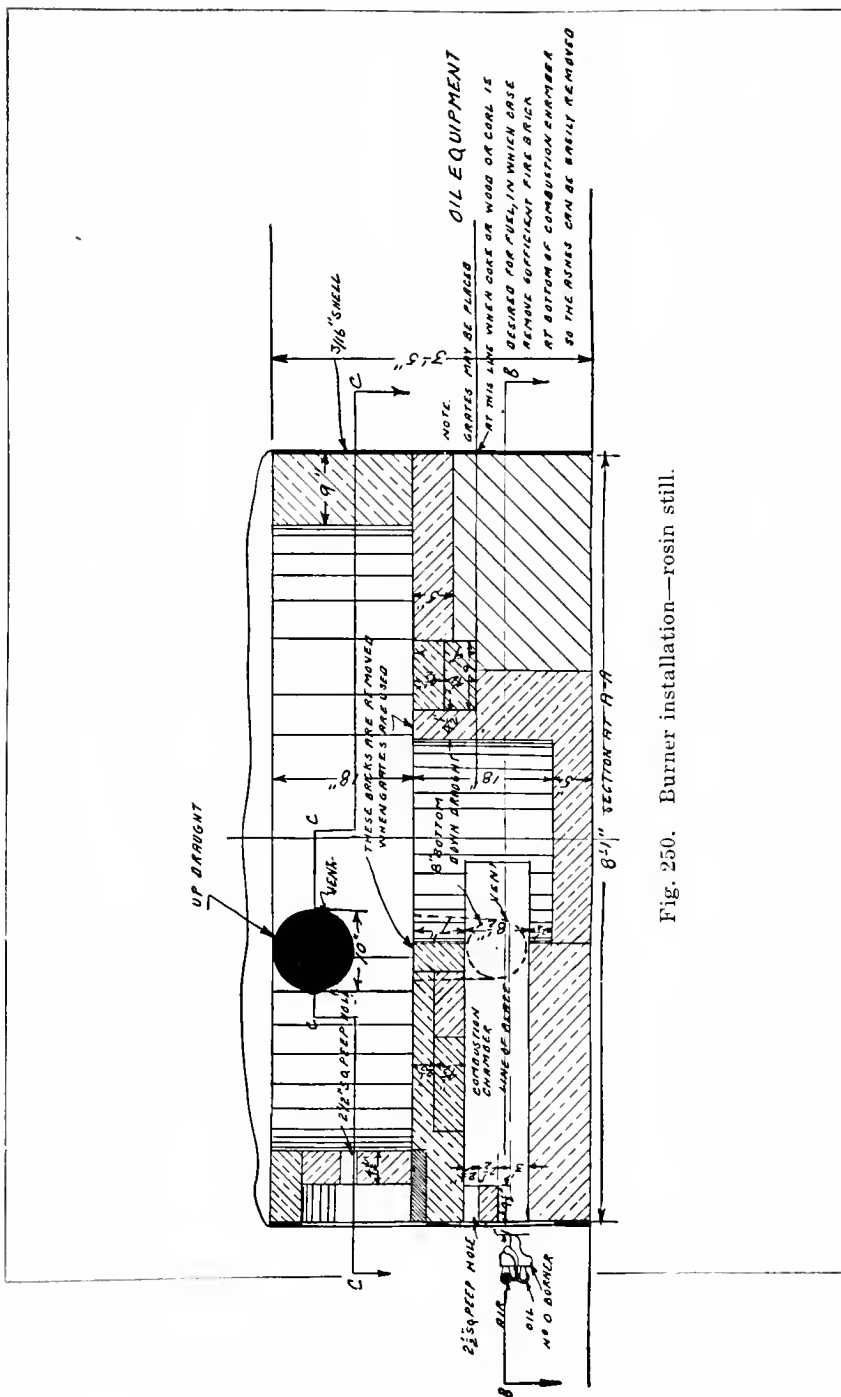
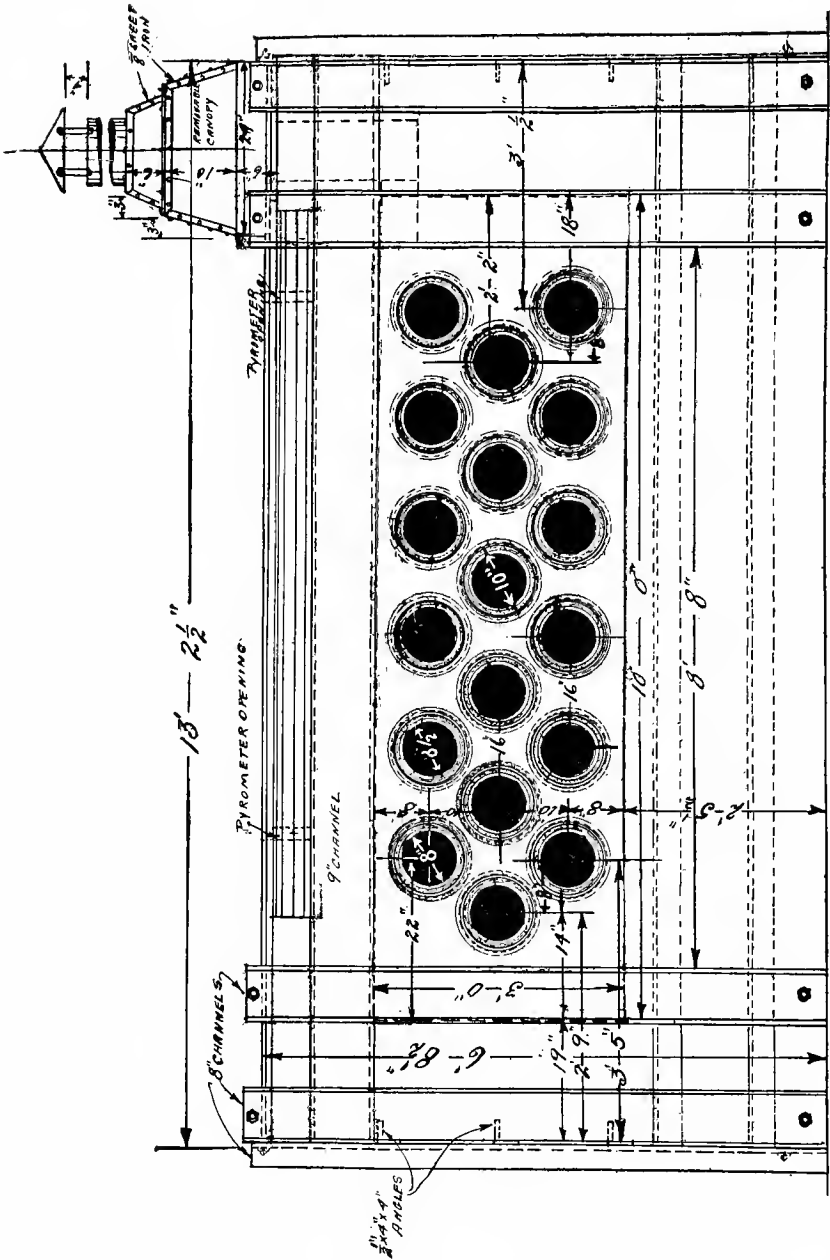

Fig. 250. Burner installation—rosin still.



SIDE ELEVATION.

Fig. 251. Chemical furnace. (Side elevation.)

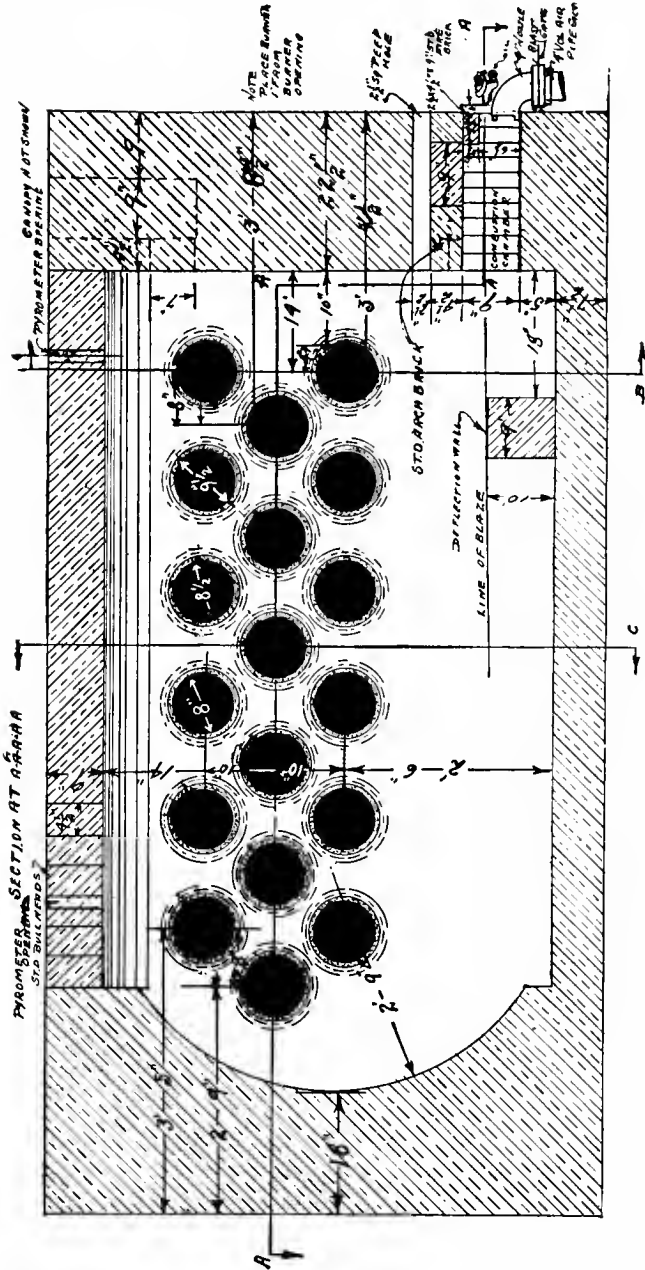

Fig. 252. Chemical furnace equipment.

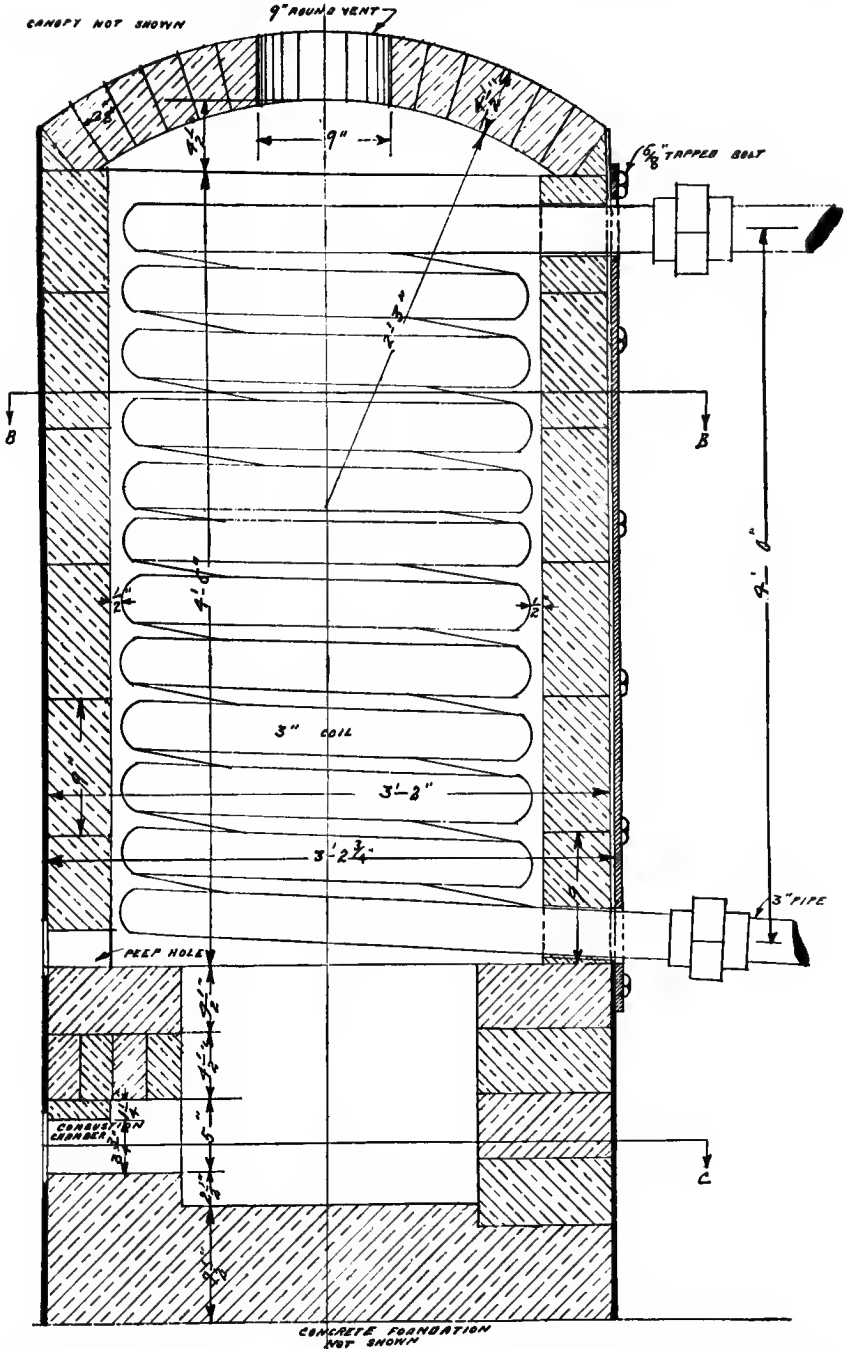

Fig. 254. Oil heating furnace, the hot oil being used to heat jacketed stills containing very inflammable chemicals.

tionate size, and the top of this cylindrical combustion chamber must also be a certain distance from the bottom of the kettle. These dimensions vary in proportion to the temperature required in the kettle and the quantity of chemicals charged. The cuts following show several different types.

Sometimes it is necessary in the manufacture of chemicals of a very inflammable nature to heat the stills with oil to a temperature of say 650 degrees Fahrenheit. The heating furnace is ordinarily placed outside of the building, and the stills are placed in the chemical room; the oil being distributed around the stills maintains the required temperature in the still for the length of time desired. This form of furnace is shown in Fig. 254.

Chapter XIX

CERAMIC EQUIPMENT

Oil is the most modern fuel for brick kilns, baking terra-cotta, pottery, etc.

Owing to the fact that the temperatures can be controlled so accurately; much more perfectly than with any other fuel. Before

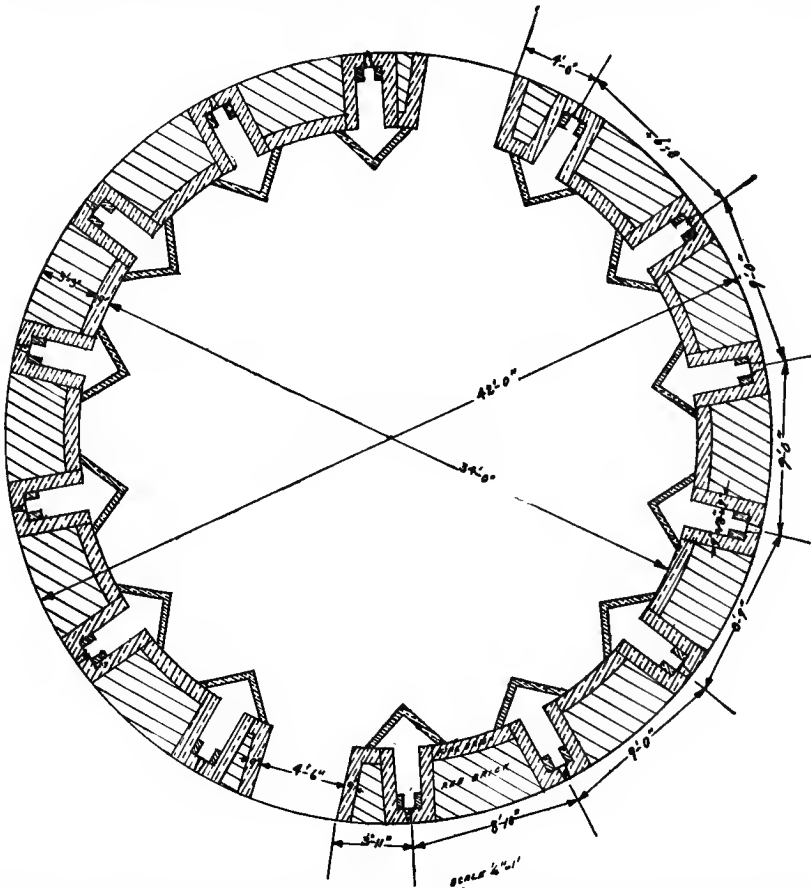

Fig. 257. Ordinary down-draft bee-hive kiln, requiring a burner for each eye.

high temperatures can be attained and maintained it is necessary to run a very light fire until all the moisture (what is technically termed 'water-smoke') has been removed. A small flame not exceeding 8 inches in length can be maintained for many hours until the desired results have been attained, after which the burner may be operated at its maximum capacity and the kiln brought to temperature as quickly as prudence will allow. Therefore a very superior product is produced by the use of oil as fuel.

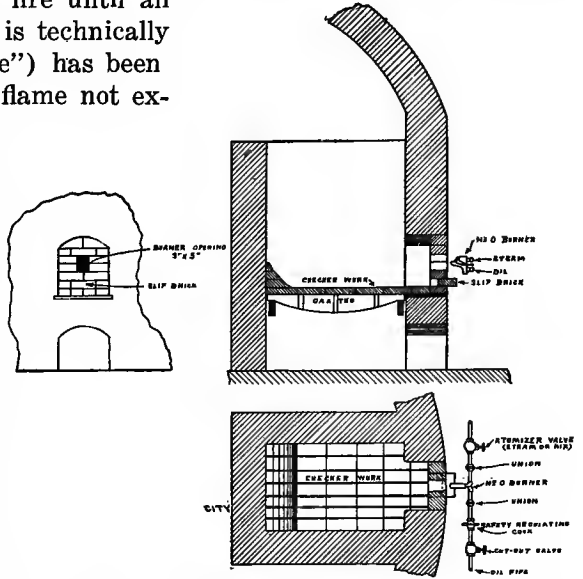

Fig. 258. Bee-hive kiln changed from coal to oil-fired by covering the grates with a fire-brick checkerwork and bricking up the firing door.

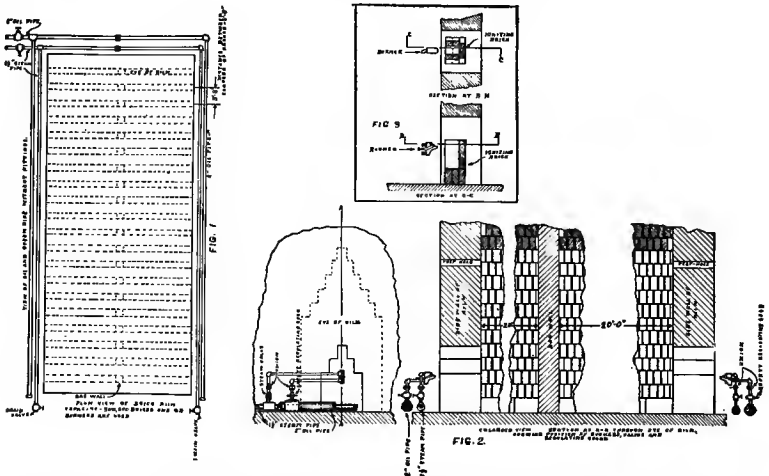
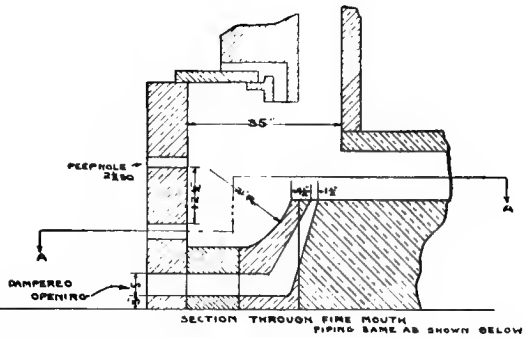
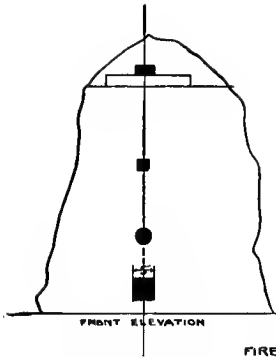
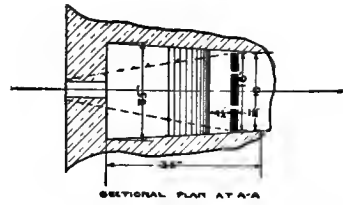

Fig. 259. An ordinary brick kiln, capacity 500,000 brick. Having forty eyes, it requires forty burners.



FIRE BOX EQUIPMENT WHICH I RECOMMEND

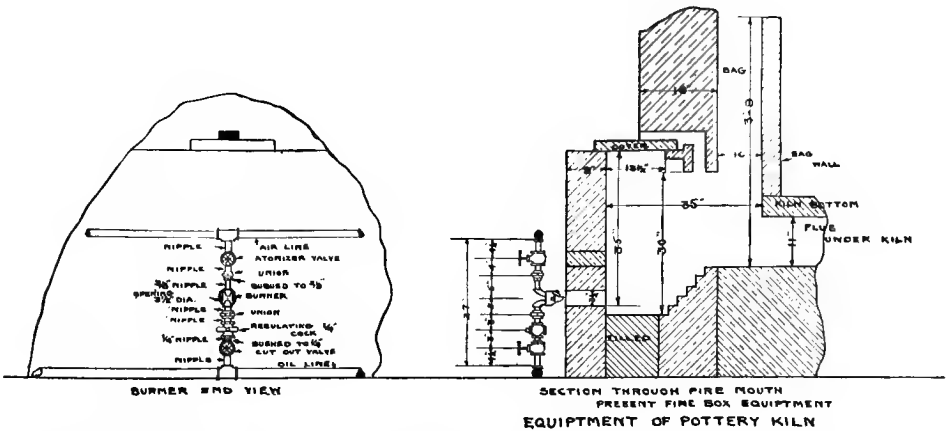

Fig. 260. Two ways of equipping a pottery kiln, the type of construction shown in the upper views being the most modern.

Chapter XX

LIME INDUSTRY EQUIPMENT

Oil is particularly adapted for lime kilns owing to the fact that the product is more evenly heated, as the required temperature can be attained and maintained within a few degrees variation. Should there be any sulphur in the oil, with the proper method of equipment, this will not in any way affect the lime. It is very essential that the operating valves be placed some distance from the burner opening, for sometimes the rock will not follow the discharge from the kiln, which results in its leaving a large opening in the base of the kiln and in fifteen or twenty minutes this column of rock falls to the base of the kiln, causing a blast of flame to be expelled from the burner opening which is liable to catch any one standing near the front of the kiln. The operating valves should be so placed that no harm can possibly befall the operator.

The most modern practice is to use a rotary kiln in which the air from the discharged lime is superheated and used in the kiln to aid combustion. In Fig. 263 the burner is so placed that the furnace is used for a combustion chamber, but it is better practice to build a combustion chamber on to the end wall as shown in Fig. 264.

The vertical line kiln equipment is illustrated in Figs. 265 and 266.

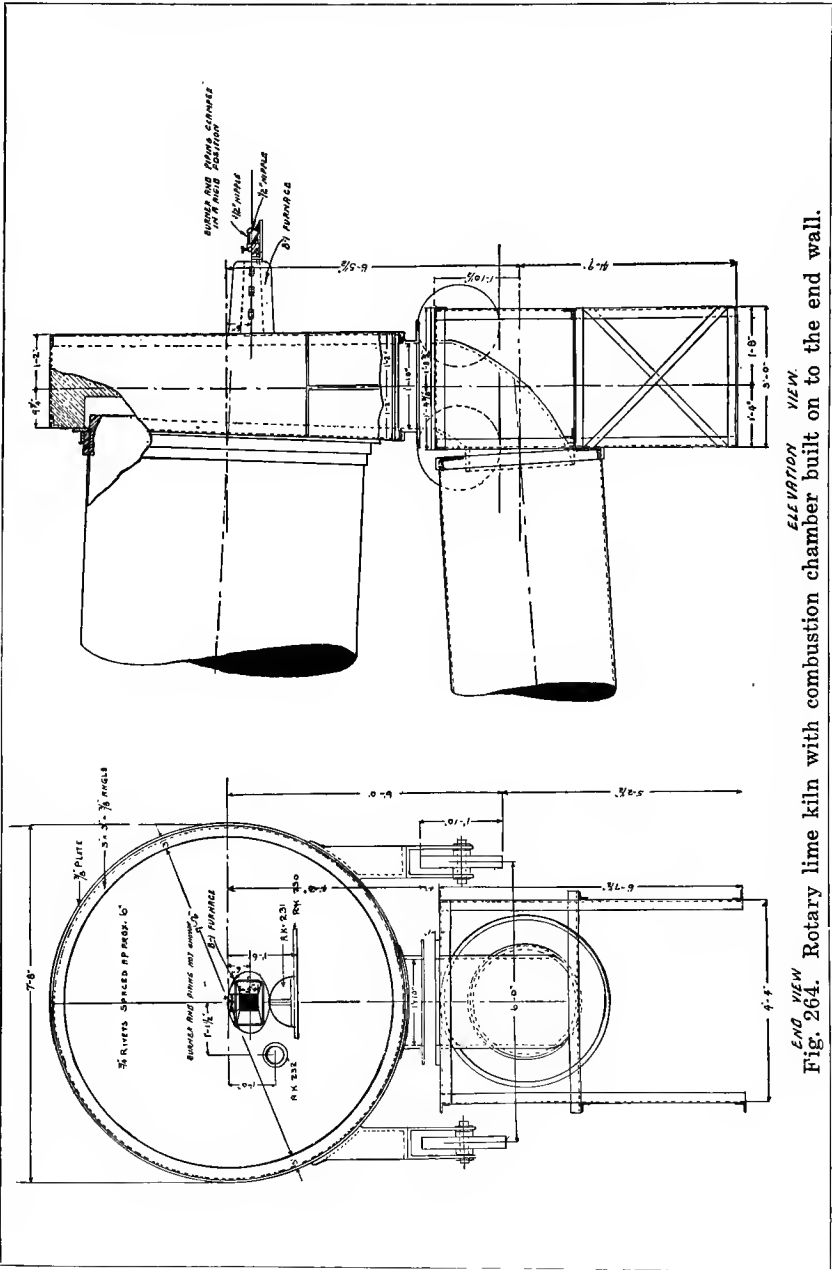

END VIEW
ELEVATION VIEW
Fig. 264. Rotary lime kiln with combustion chamber built on to the end wall.

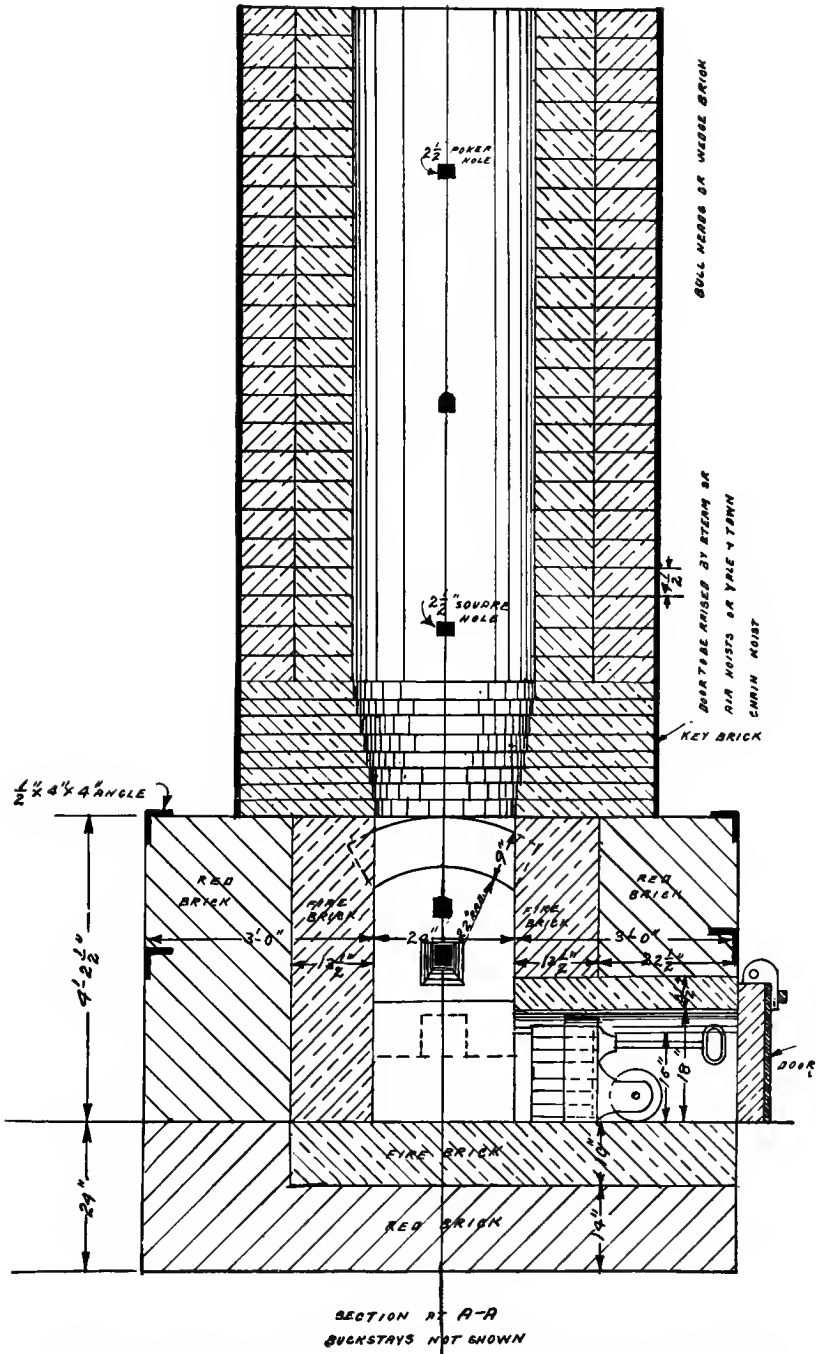

Fig. 265. Vertical lime kiln, requiring two burners, one on each side. (Burners not shown.)

BURNING LIQUID FUEL

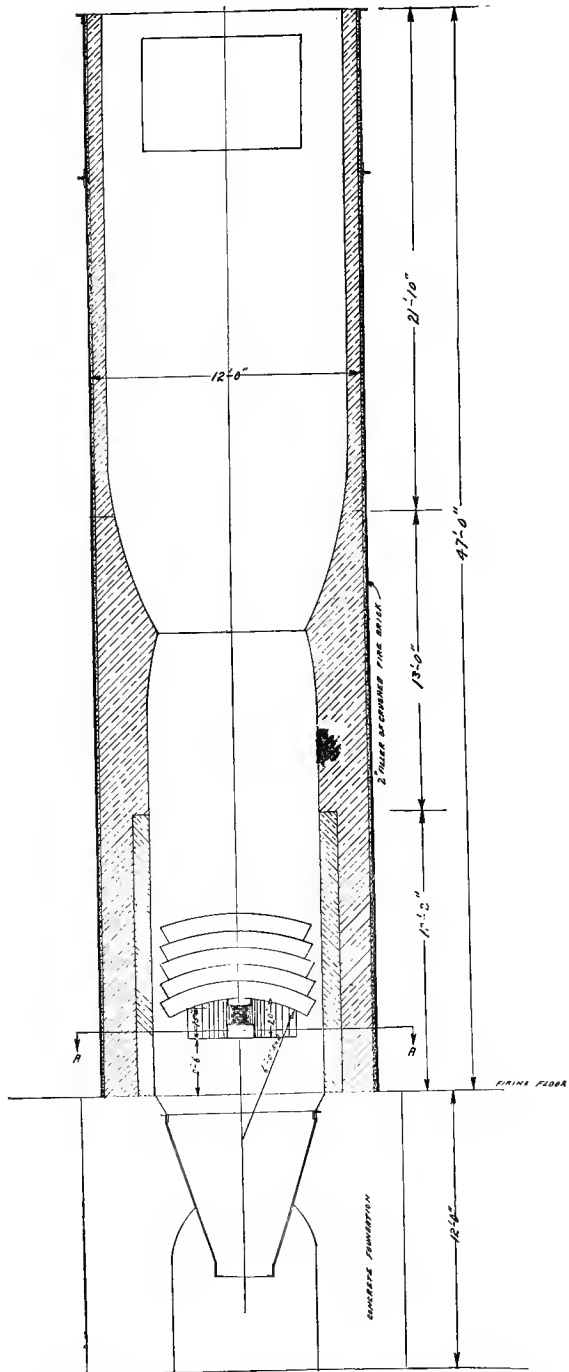

Fig. 266. Vertical lime kiln. (Combustion chamber shown, but not the burner.)

Chapter XXI

CEMENT INDUSTRY EQUIPMENT

Oil, when it can compete with pulverized coal, is an excellent fuel for rotary cement kilns. We always recommend the use of secondary air; that is, volume air, in order to obtain the maximum output from the kiln. Engineers always figure that every 20 feet

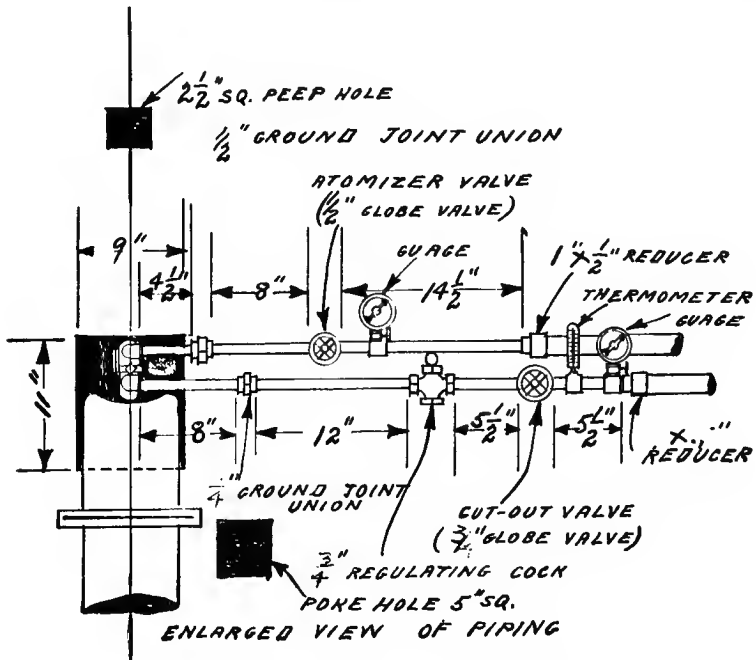

Fig. 269. Burner piping and volume air nozzle under the burner.

of stack is equal to 1/10 foot draft providing it is a clear day; but all days are not clear, and if you depend upon the stack to draw in the oxygen needed to give the required temperature on a rainy day the output is not as great as on a clear day. However with the aid of a volume air nozzle placed under the burner as

shown in Fig. 269 and volume air at 3 ounce pressure, you can get the maximum output from the kiln under all climatic conditions.

Only one burner is used, and the operating valves of same may be placed in whatever position is most convenient for the operator.

In Fig. Nos. 270 and 271 is shown the most modern way of equipping a cement kiln. It is always necessary to provide a combustion chamber of adequate proportions, and also to place the operating valves wherever most convenient to the operator. Same form of poke-hole and peep-hole is used as when burning other fuels.

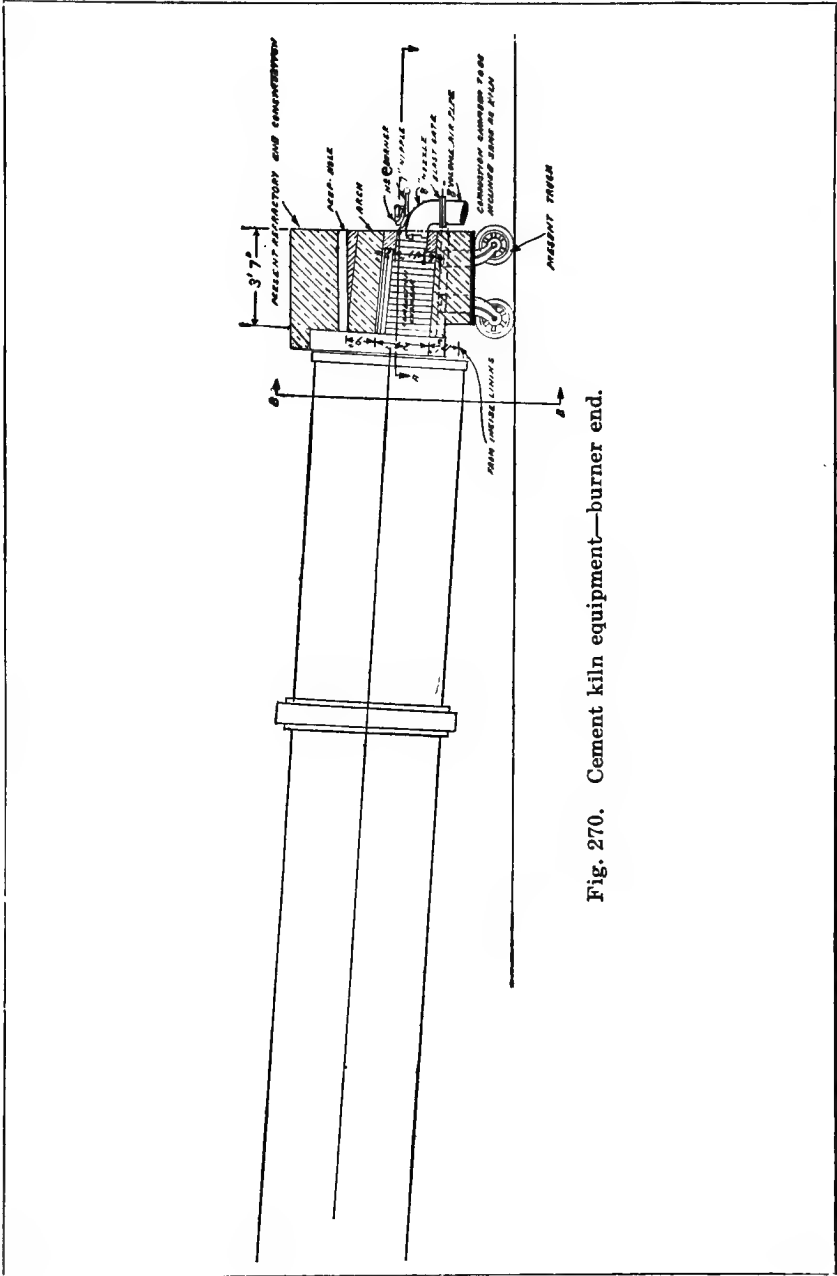

Fig. 270. Cement kiln equipment—burner end.

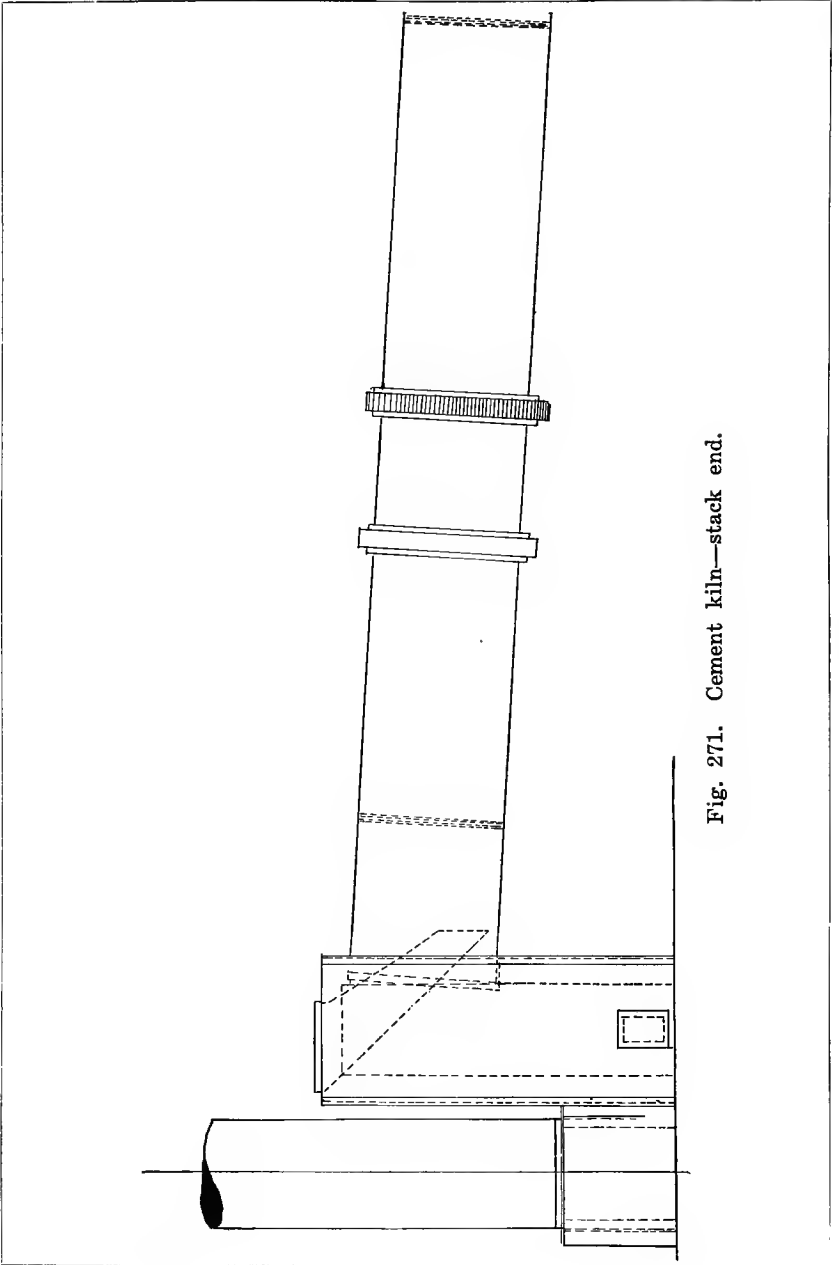

Fig. 271. Cement kiln—stack end.

Chapter XXII

DRYERS AND ORE ROASTERS

Asphaltum roads seem to be the demand of the hour, and if properly laid with the asphaltum 98 per cent. pure are excellent. Figure 275 shows a plant in which oil is used as fuel, not only for the boiler furnishing the steam to operate the machinery, but also for the sand dryer and the asphalt mixer, these oil burners being operated by the steam from the boiler. It is also used for melting the asphaltum in the large kettles.

Of course the product from these machines is doubled and often tripled by the use of oil as fuel instead of coal.

There are numerous types of dryers for drying sand, etc. One form is shown in Fig. 278. It is necessary to have a combustion chamber of adequate proportions to consume the oil before reaching the dryer proper. If this is constructed in the former coal firebox, the dryer can readily be changed from coal to oil-fired or back again to coal at a minimum expense.

Oil is particularly adapted for ore roasting, for it enables the operator to attain and maintain the temperature required at all times. It is especially valuable for desulphurizing ores. There are legions of different types of ore roasters. In the cylindrical oven shown in Fig. 282, the ore is dropped into the upper chamber and passes through several chambers before being discharged. The rappers revolve and keep the ore in a state of agitation, as well as conveying it from the upper chamber to the lowest one from which it is discharged. The various chambers each require a different temperature and therefore eight or ten burners are required, according to the number of chambers and the size of the roaster.

In some types of ore roasters, it is necessary to have the flame from the burner directed downwardly upon the charge, which is then carried along by a conveyor, substantially as indicated in Fig. 283.

For rotary dryers in either portable or stationary asphalt plants it is most essential that the burner be capable of atomizing any gravity of liquid fuel, for in some localities you can get fuel oil,

other places heavy crude oil, while in other localities nothing but oil tar from a gas works may be obtainable. Burning liquid fuel

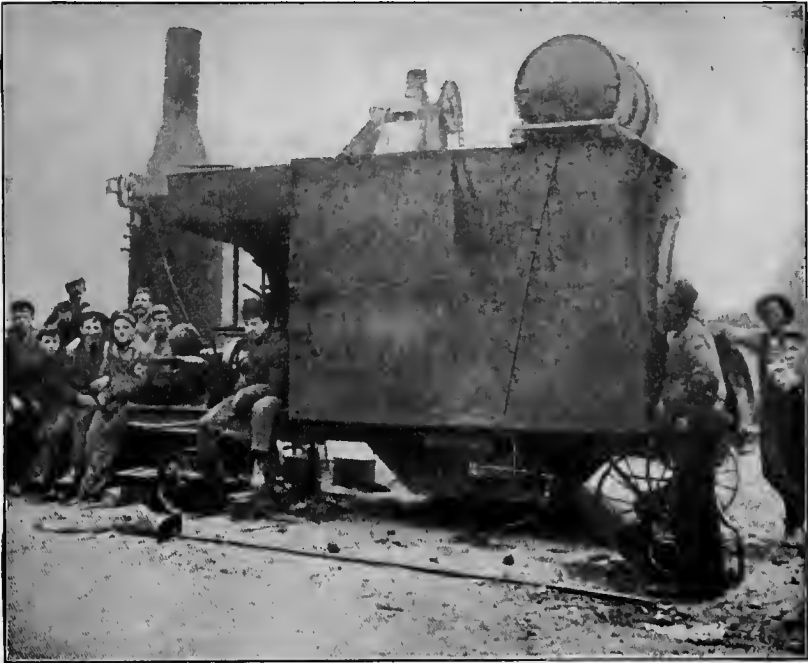

Fig. 275. Portable asphalt mixer equipped with oil burner.

in the vertical or other type of boiler used to operate a portable asphalt plant is a great convenience and it eliminates the smoke nuisance.

BURNING LIQUID FUEL

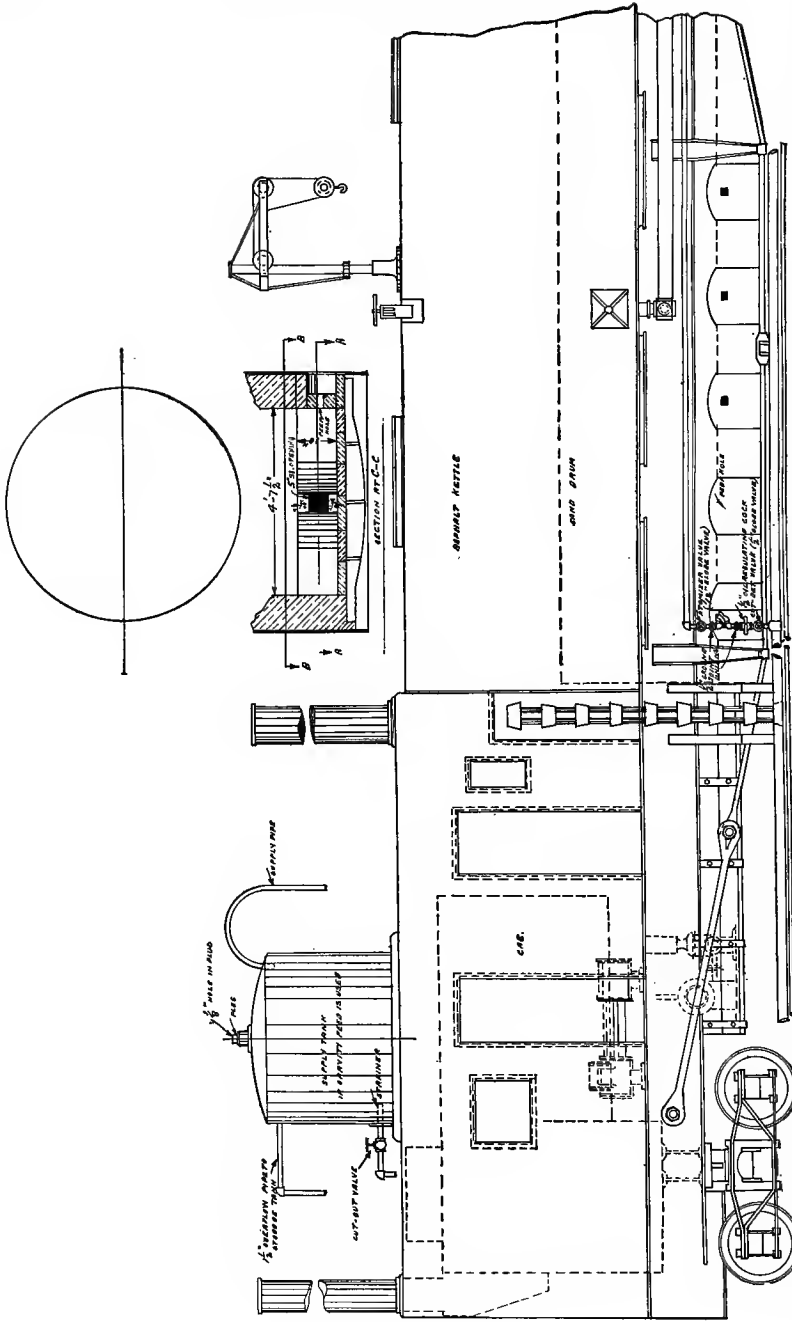

Fig. 276. Portable, self-contained asphalt rig, mounted upon a standard car, with gravity feed oil system and operated with only one oil burner.

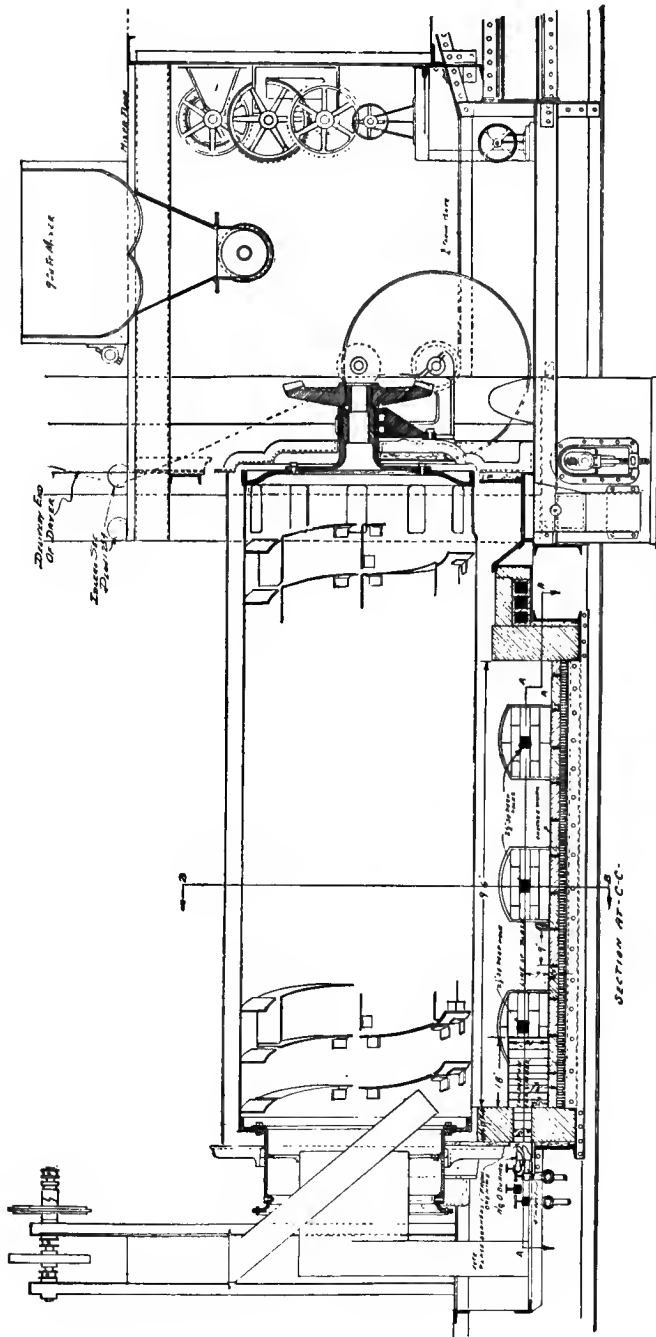

Fig. 277. Mid-sectional view of fire-box of asphaltum mixer, changed from coal to oil-fired.

BURNING LIQUID FUEL

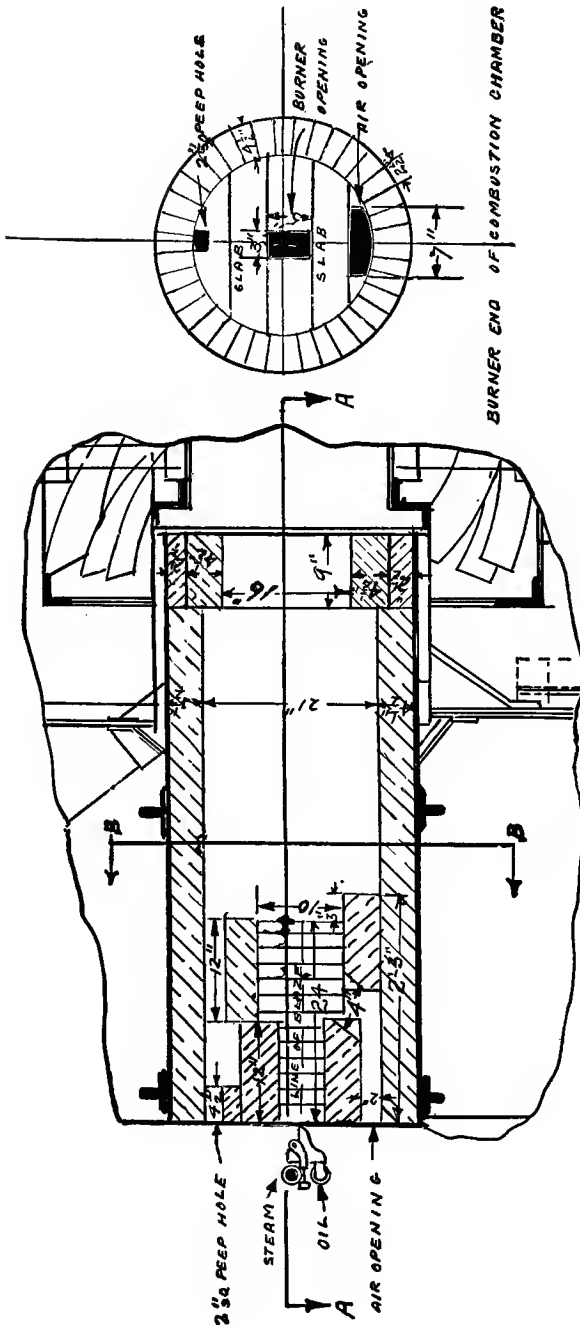

Fig. 278. Sand dryer equipment.

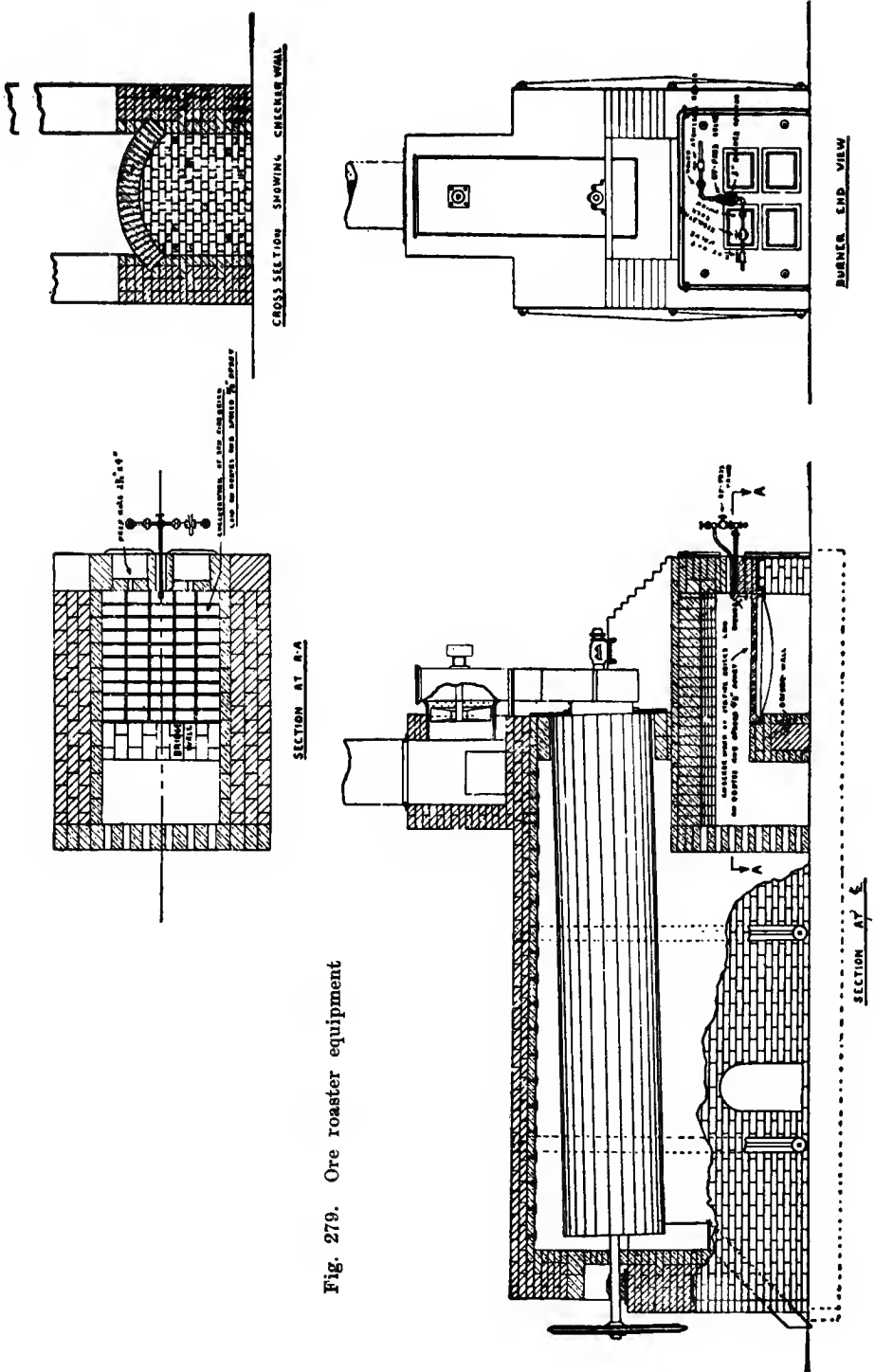

Fig. 279. Ore roaster equipment

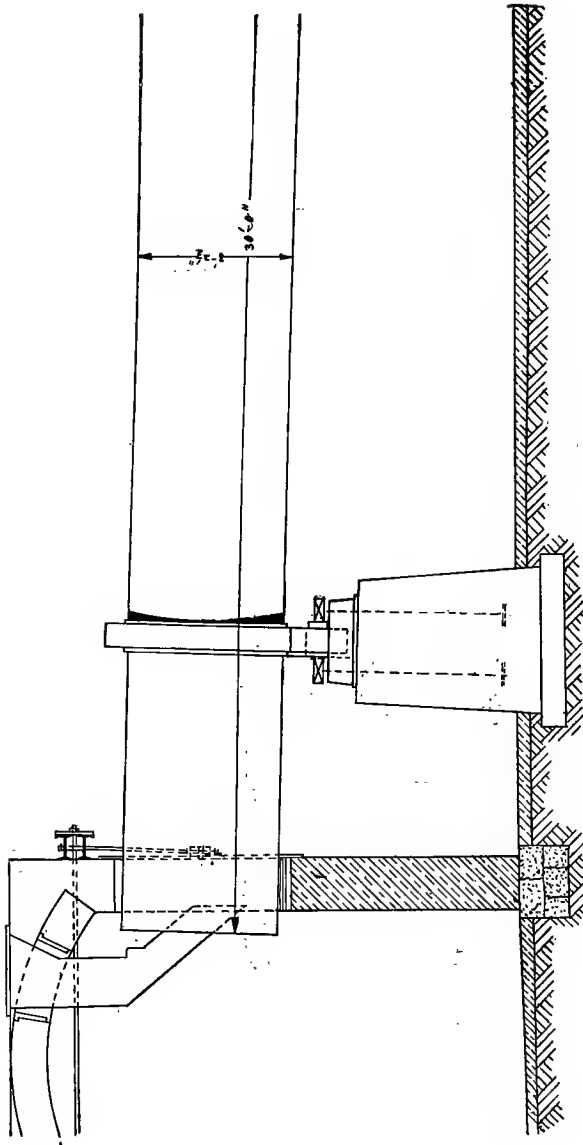

Fig. 280. Rotary dryer equipment, stack end view.

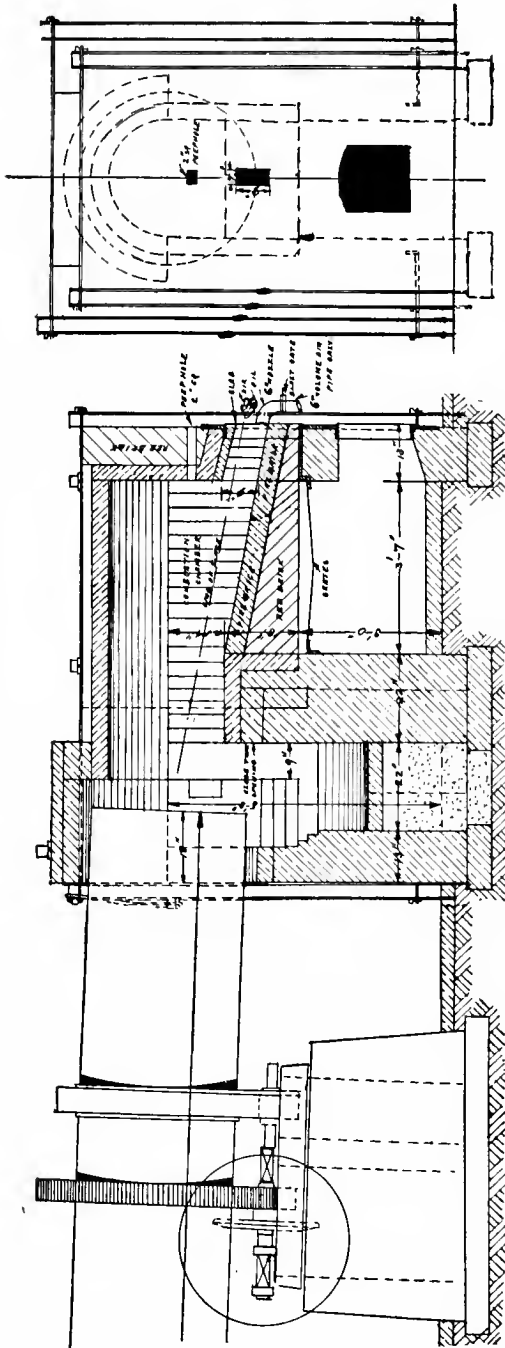

Fig. 281. Rotary dryer changed from coal to oil-fired. Bu rner end.

BURNING LIQUID FUEL

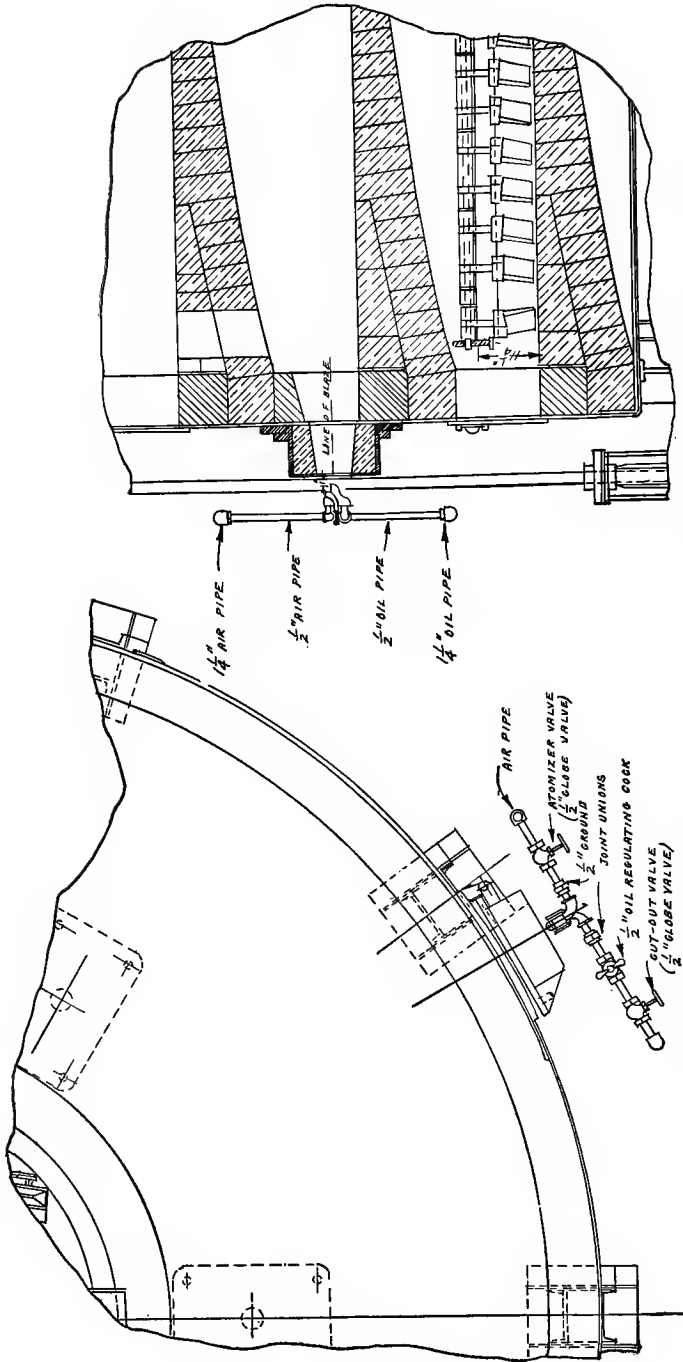

Fig. 282 Ore roaster. Cylindrical oven in which the rabblers revolve and keep the ore agitated.

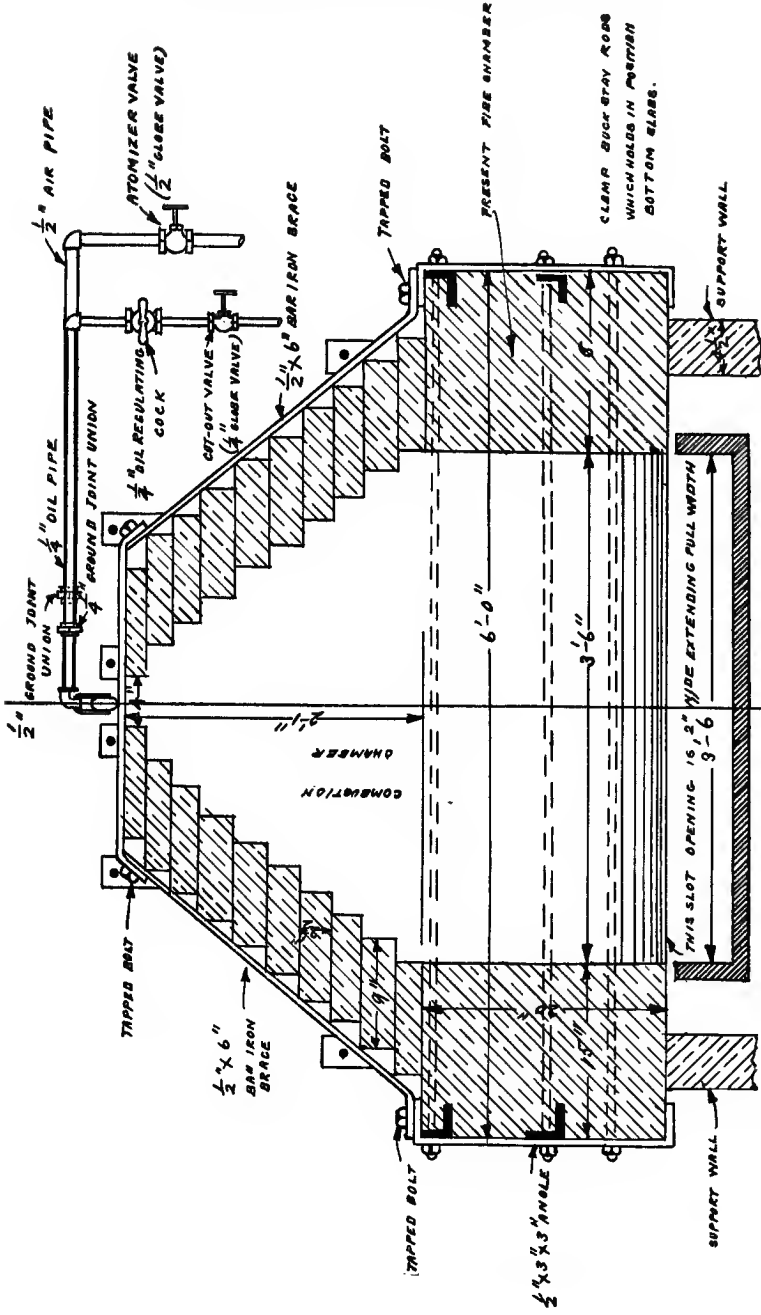

Fig. 283. Ore roaster equipment in which the burner discharges the flame down upon the charge. (Used for desulphurizing iron ore)

Chapter XXIII

BREAD AND CRACKER OVEN EQUIPMENT

Oil is an excellent fuel for bread ovens, and is applied in the same fire-box in which coal was formerly used. The cut given shows the manner of applying the burner. The grates are simply covered with fire-brick and an igniting chamber built in the doorway. Either steam or compressed air may be used for atomizing, or low pressure air may be used if the oil is of a light gravity. There should be one burner in each fire-box and the operating valves may be placed wherever most convenient for the operator. The installation is a very simple one and a very satisfactory one, for the baker can at all times regulate the fire as he wishes in order to bake the bread, etc. No smoke nor odor when the oil is properly handled.

The reel cracker oven (Fig. 287) has two combustion chambers, each having graduated heat ports which insure an even distribution of heat throughout the oven.

Oil is the ideal fuel for the ordinary kitchen ranges used in hotels, restaurants, etc. The manner of equipping a battery of French ranges is shown in Fig. 290.

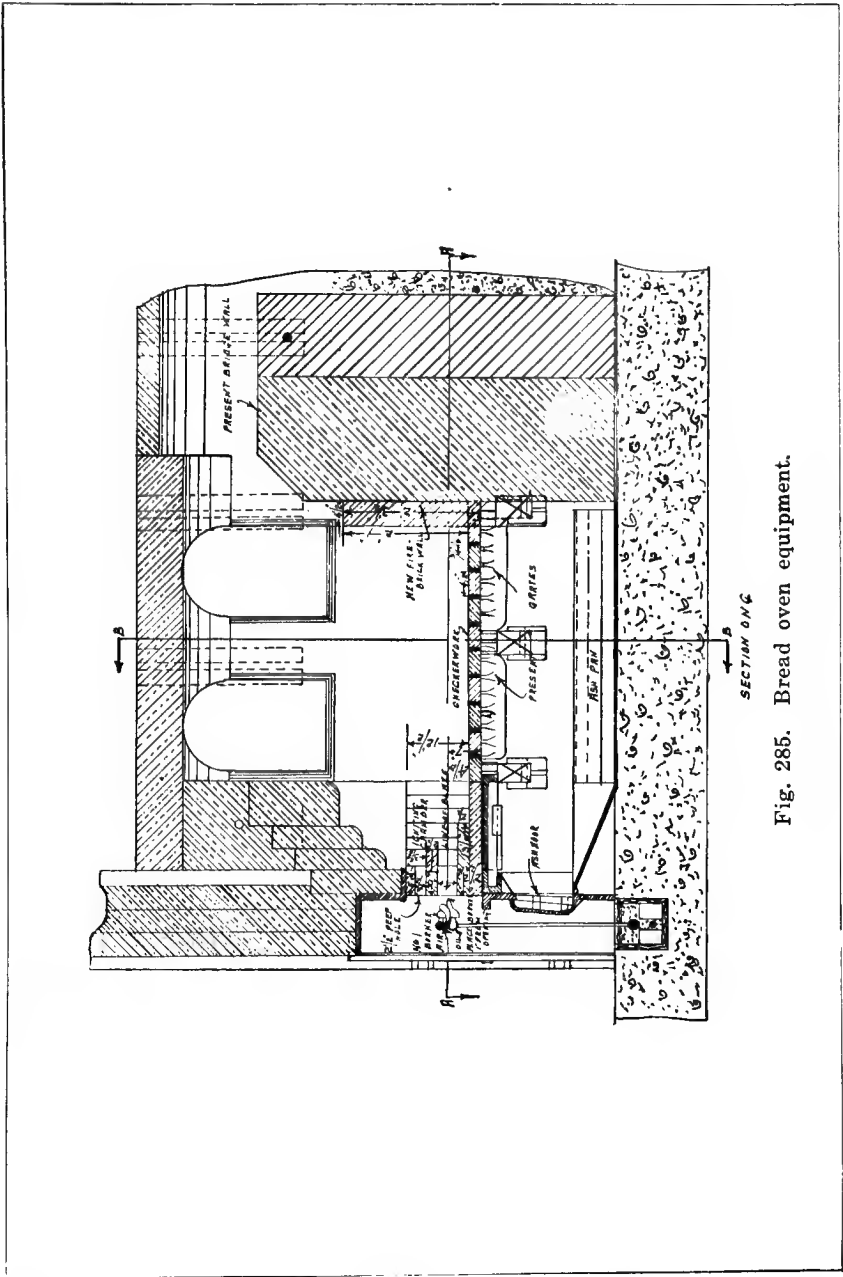

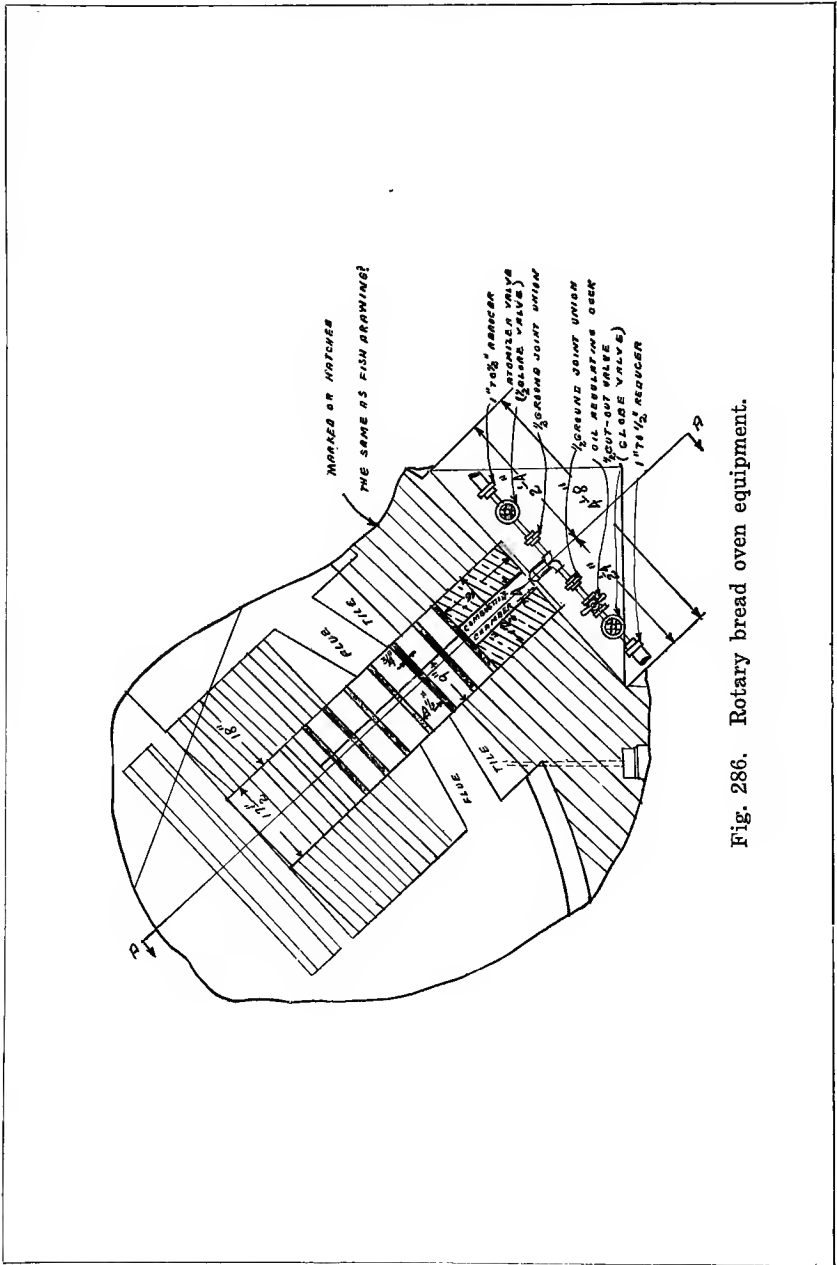

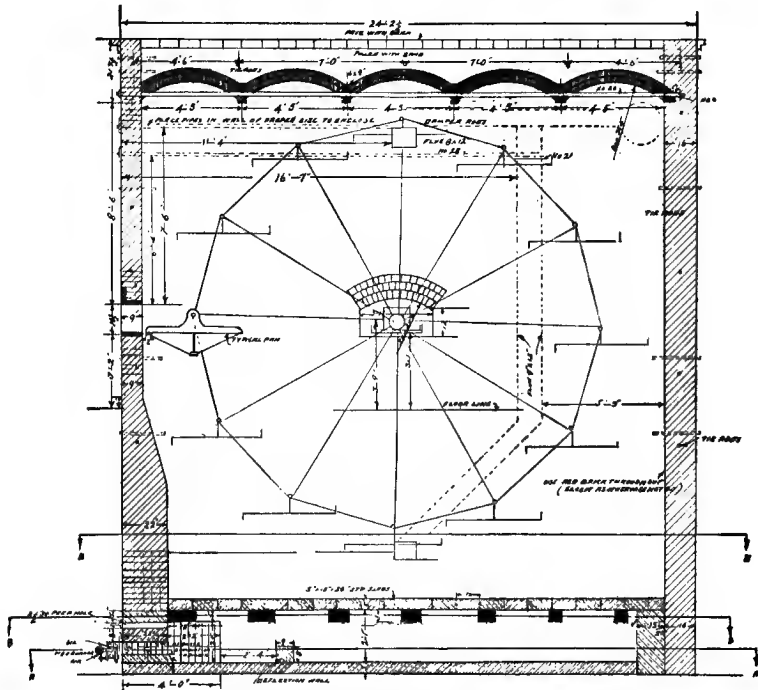

Fig. 287. Cracker baking oven of the reel type.

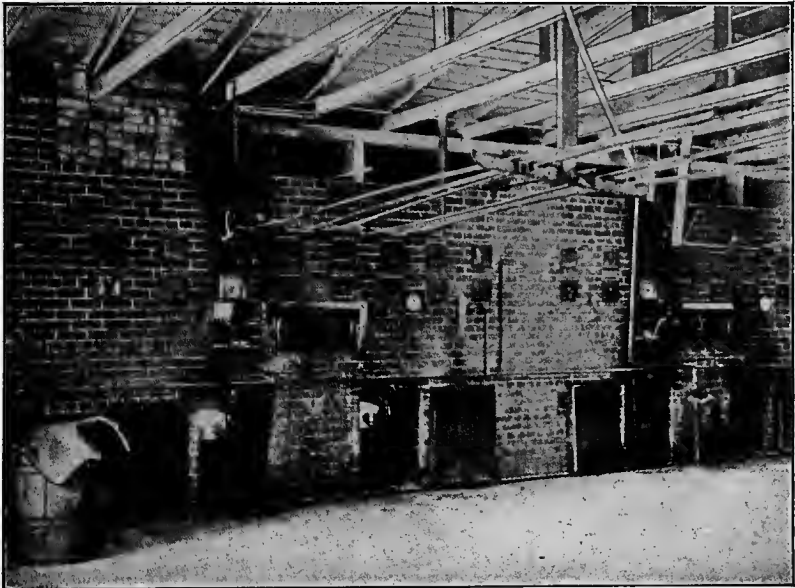

Fig. 288. Peterson oven.

BURNING LIQUID FUEL

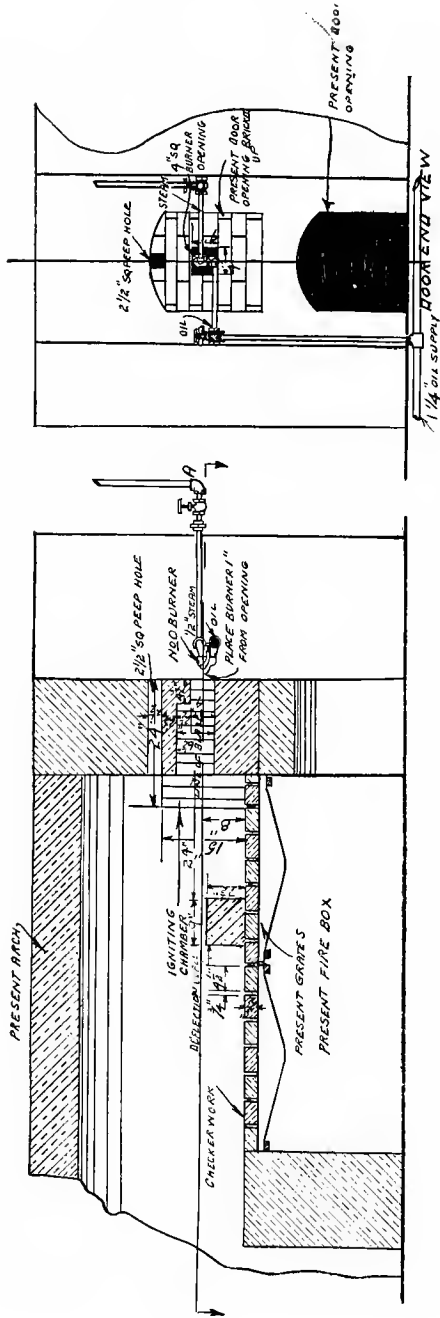

Fig. 289. Peterson oven equipment.

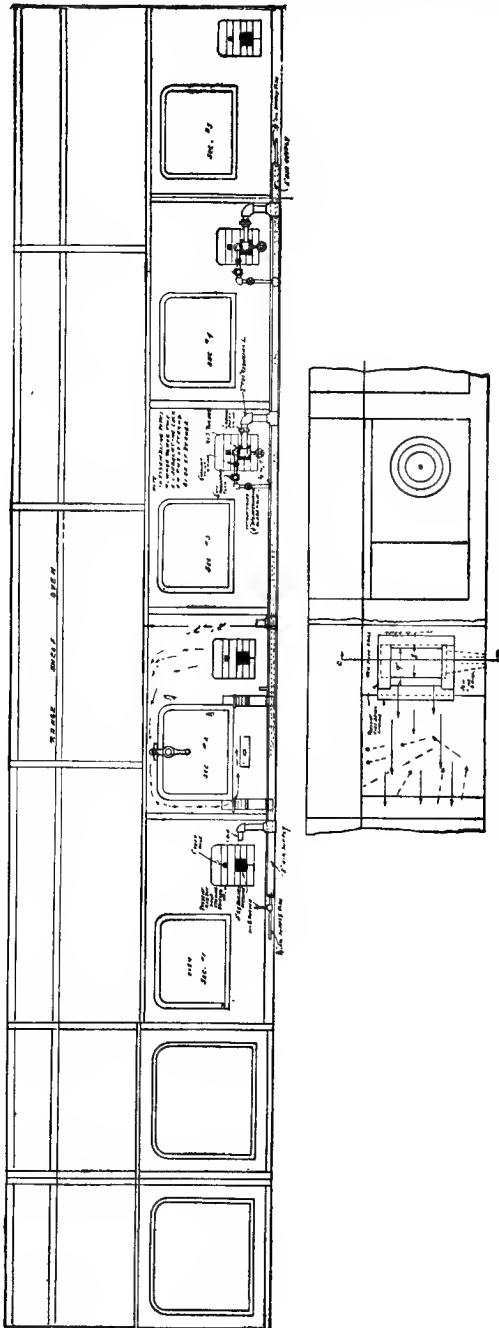

Fig. 290. French kitchen ranges.

Chapter XXIV.

CHOCOLATE INDUSTRY EQUIPMENT

This shows an oil-burner as applied to a cocoa bean roaster. Oil is especially adapted for this class of service owing to the fact that you have perfect control of the temperatures.

The baking of a cocoa bean requires a quick, hot fire at first,—then a light fire, and, during the last of the process, the fire is shut off entirely, the heat radiating from the fire brick being sufficient to finish the baking and put in the flavor. This manner of baking gives the bean a much better flavor than when coke is used as fuel, for coke produces a slow fire at first, which constantly increases so the process is just the reverse of what it should be in order to give the bean a fine flavor.

Chapter XXV

OIL AND TAR STILL EQUIPMENT

There are hundreds of different forms of oil stills. Some are of the tank type as shown in Fig. 296, others are of the boiler type, while others again are of the topping type where the elements of the still can quickly be removed when their operation is effected by carbon in the tubes of the still.

Oil is an ideal fuel for this class of service for with it you can obtain the varying temperatures required. The more volatile oils are taken off first and the heat in the furnace of the still is gradually raised to the temperatures required for the different distillations.

In order to obtain the various by-products from tar, it is necessary to distill same. This is ordinarily done by means of a horizontal still as shown in Fig. 297. You will note that the fire chamber is provided with an arch in order to protect the bottom of the still from the excessive heat. The heat ports in this arch vary in proportion to the size of the still. This form of construction in the firebox is most essential, as it prevents the excessive heat from impinging upon the bottom of the shell. Only the radiated heat passing upwardly and around the still, gives the required temperature.

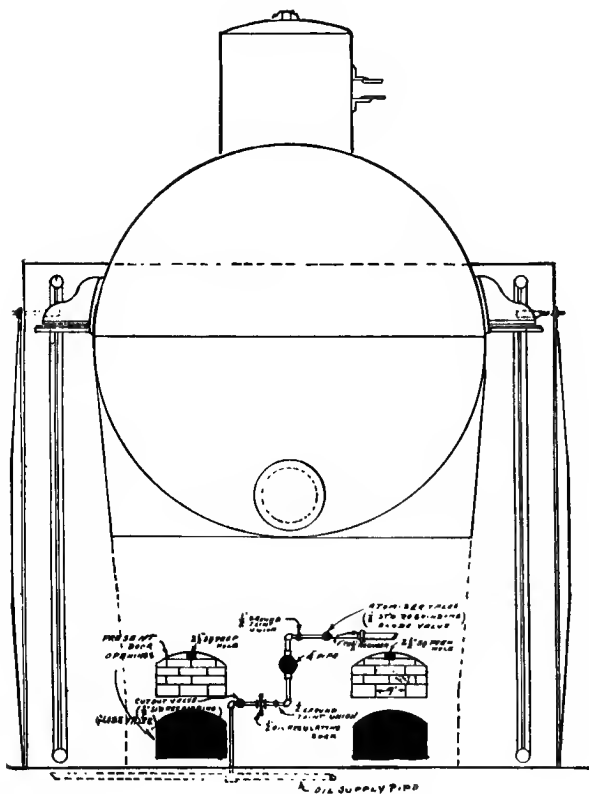

Fig. 295. Oil still. (Burner end view.)

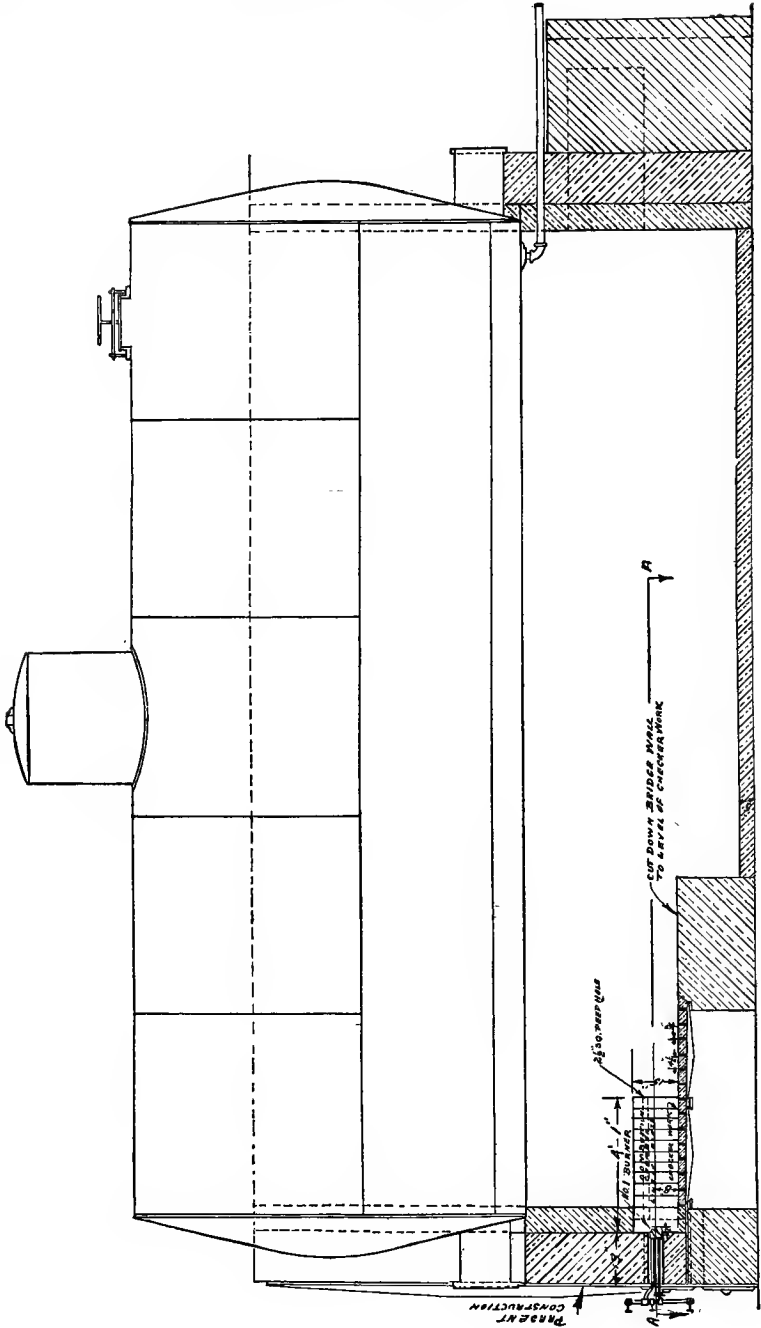

Fig. 296. Oil still equipment. (Longitudinal mid-section.)

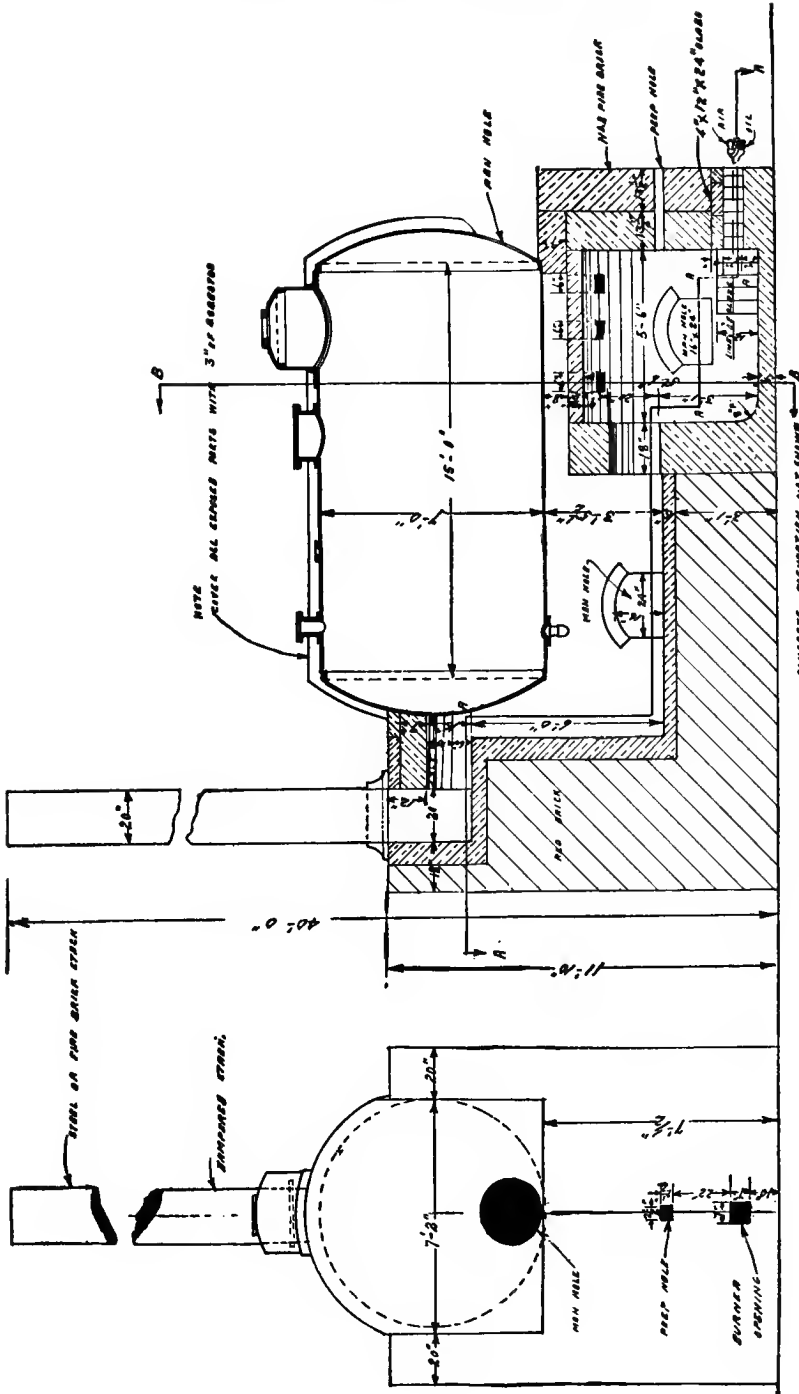

Fig. 297. Horizontal tar still.

Chapter XXVI
INCINERATOR EQUIPMENT

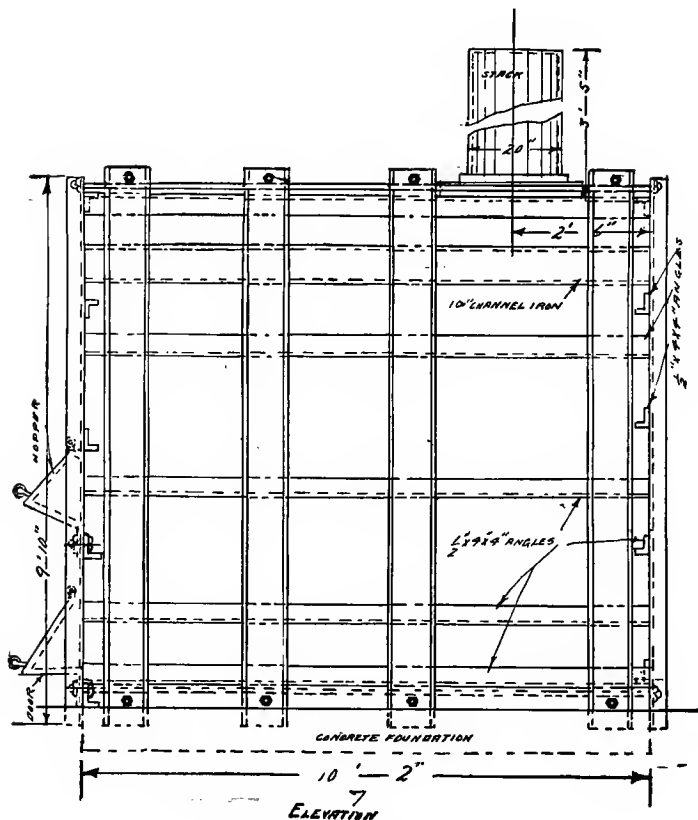

Fig. 300. Incinerator.

I believe that some day not far in the future incinerators will have to be used in manufacturing plants and aboard vessels to destroy the garbage. In fact, residences will in time employ this method to destroy vegetable matter, one incinerator being erected

for a group of houses. This form is absolutely sanitary, as it provides every means for the elimination of smoke.

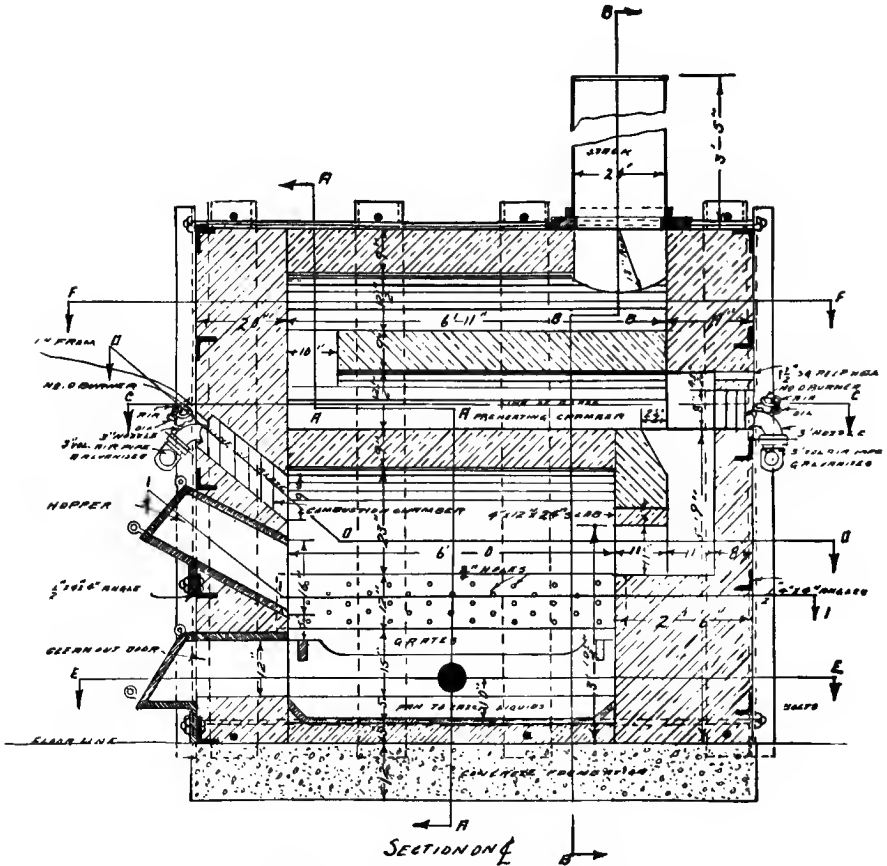

Fig. 301. Incinerator equipment.

You will notice a burner is used to consume the charge, and if smoke occurs this is consumed by burner No. 2 in the secondary or upper chamber.

Chapter XXVII

GLASS INDUSTRY EQUIPMENT

In the melting, bending and annealing of glass oil, if properly installed, is a fuel which insures success. There are many types of glass-melting furnaces: regenerative, recuperative and the ordinary tank type. The equipment of the latter is illustrated in Fig. 303.

In regenerative glass-melting furnaces about 12 feet by 20 feet (or larger or smaller) we use two burners placed in the manner shown in Fig. 304. Each burner is of capacity adequate for the entire operation. Of course in this type of furnace only one burner is used at any time, and the other burner is placed in operation when the first burner is shut off and the reversing valve is adjusted.

Oil is an ideal fuel for glass melting as the sulphur content of the oil does not in any way effect the molten glass.

In recuperative glass-melting furnaces (Fig 307) the burner is placed over the air opening, substantially as shown. The operating valves of the burner may be placed in any position convenient for the operator—near the burner or 50 feet from it.

There are two ways of equipping a glass lehr. Formerly we placed a burner on each side as indicated in the view marked "Fig. A," but the modern way is to place the burner immediately under the arch so that the flame passing from the combustion chamber runs along the upper portion of the lehr. This direct-fired installation is clearly shown in the lower view of Fig. 311. It is by far the most economical and modern method of equipment.

When using Mexican oil in lehrs the ware is sometimes effected by the sulphur in the oil settling down upon the ware, thereby discoloring it, which must of course be washed off. This is avoided by using a muffle furnace such as shown in Fig. 312. There are of course a great number of other types and forms of muffle lehrs.

There are numerous plate-glass industries that co-operate with architects in the bending of plate glass. Great care must be exercised in the heating of this glass as the plates are charged into



Fig. 303. Old type glass melting furnace, practically obsolete to-day. Size in the bath, 14 feet. by 18 ft.

this furnace when the furnace is cold, and the sheet steel form placed under the plate. The furnace is then operated very slowly as the heat must be very evenly distributed. When the plate has reached a certain temperature it gradually bends into the form provided for it and becomes of the radius required.

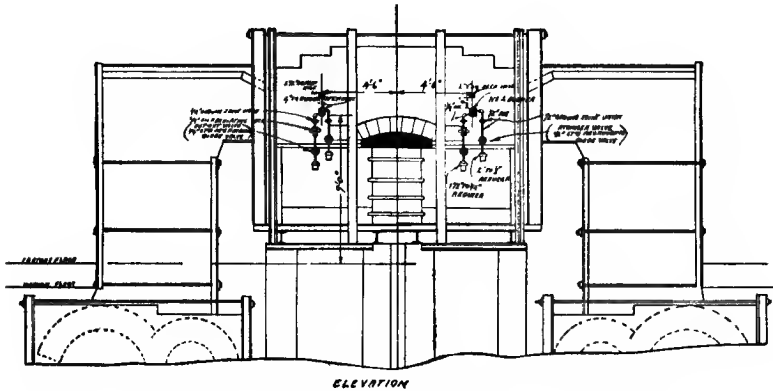

Fig. 305. Diagram showing the two burners and piping—regenerative glass melting furnace shown in Fig. 304.

Oil is an incomparable fuel for this class of work owing to the fact that the heat in this furnace is under perfect control.

Figures 313, 314 and 315 show a coke-fired furnace changed to oil-fired. The difference in the length of operation between coke and oil as fuel is that it only requires about one-quarter as long when oil is used as while using coke.

BURNING LIQUID FUEL

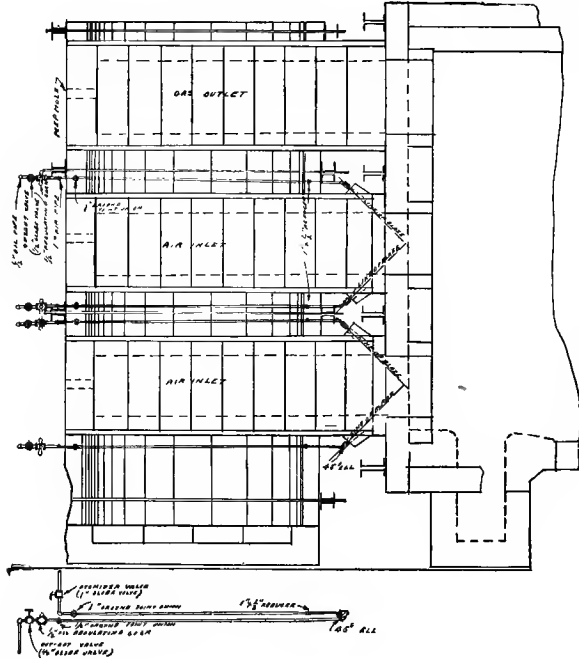
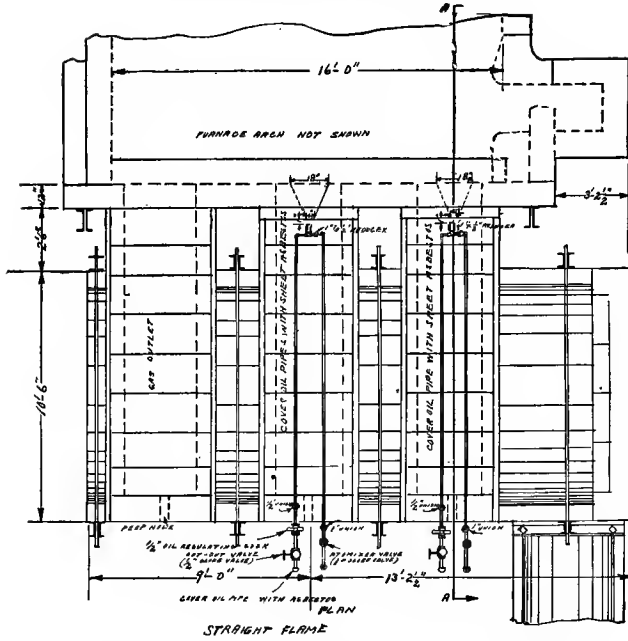

Fig. 308. Another glass furnace of the recuperative type.

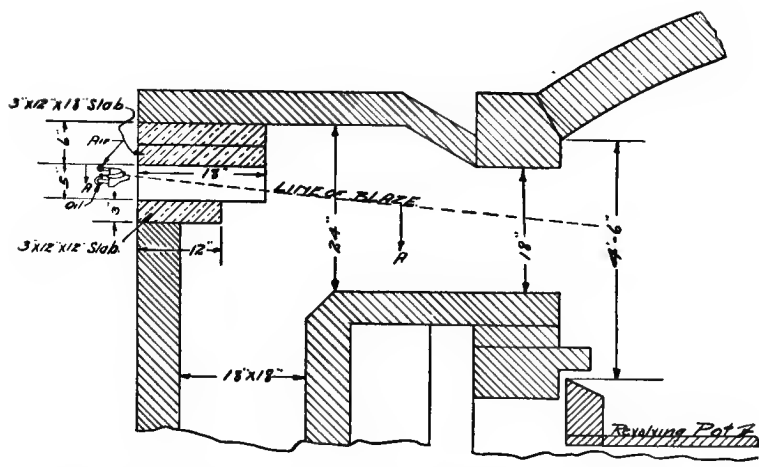
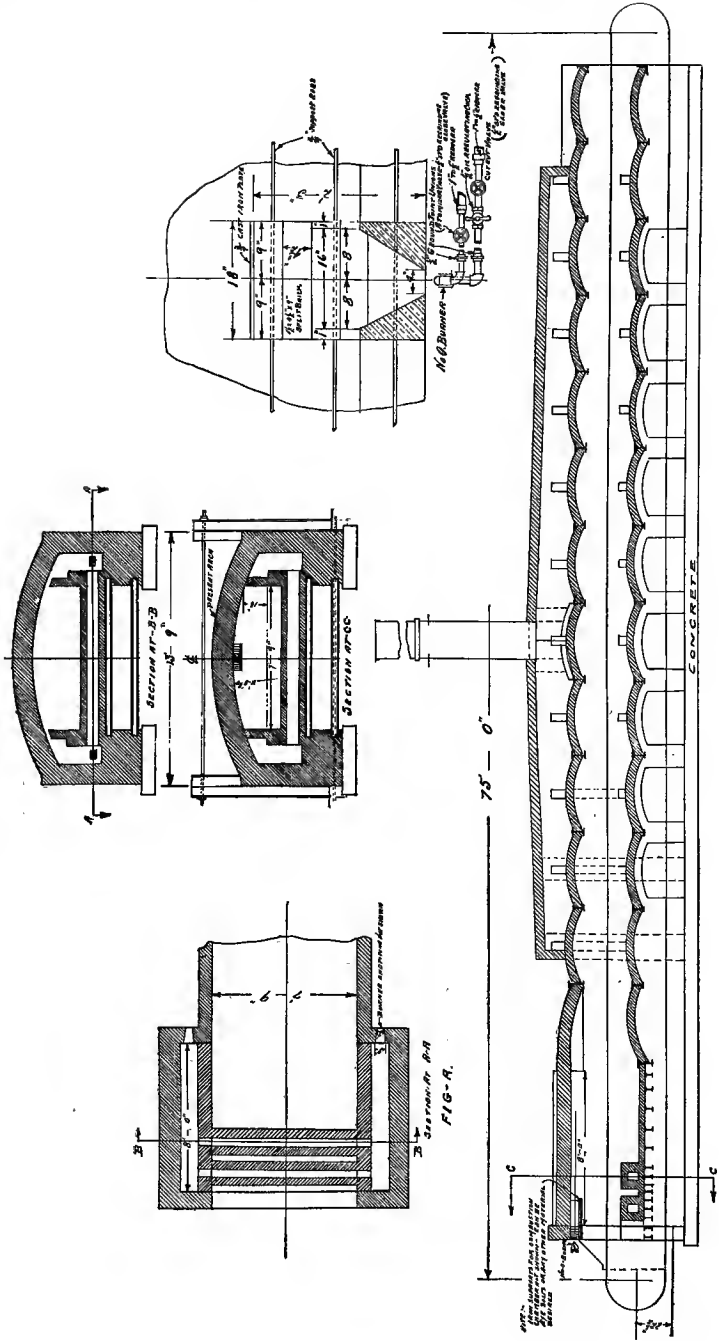
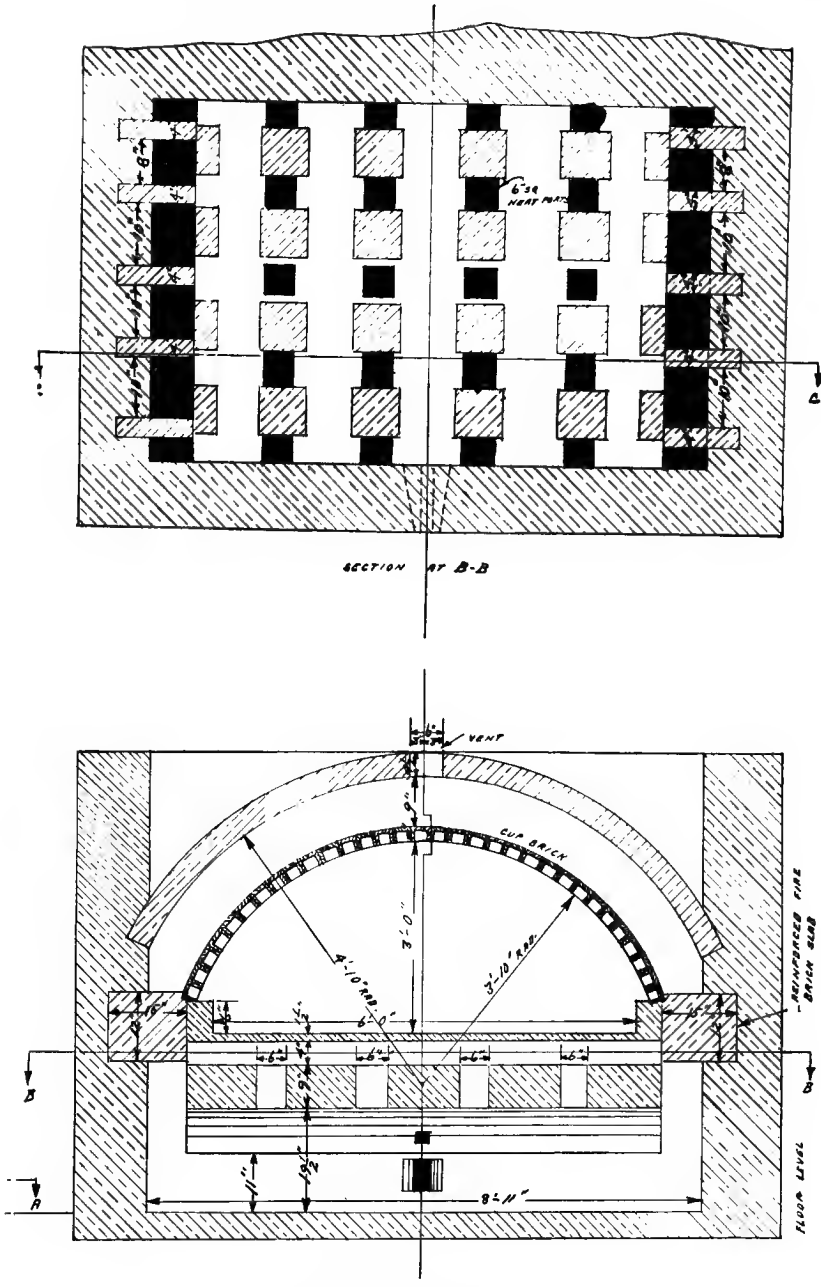

Fig. 309. Equipment of a glass furnace of the recuperative type.

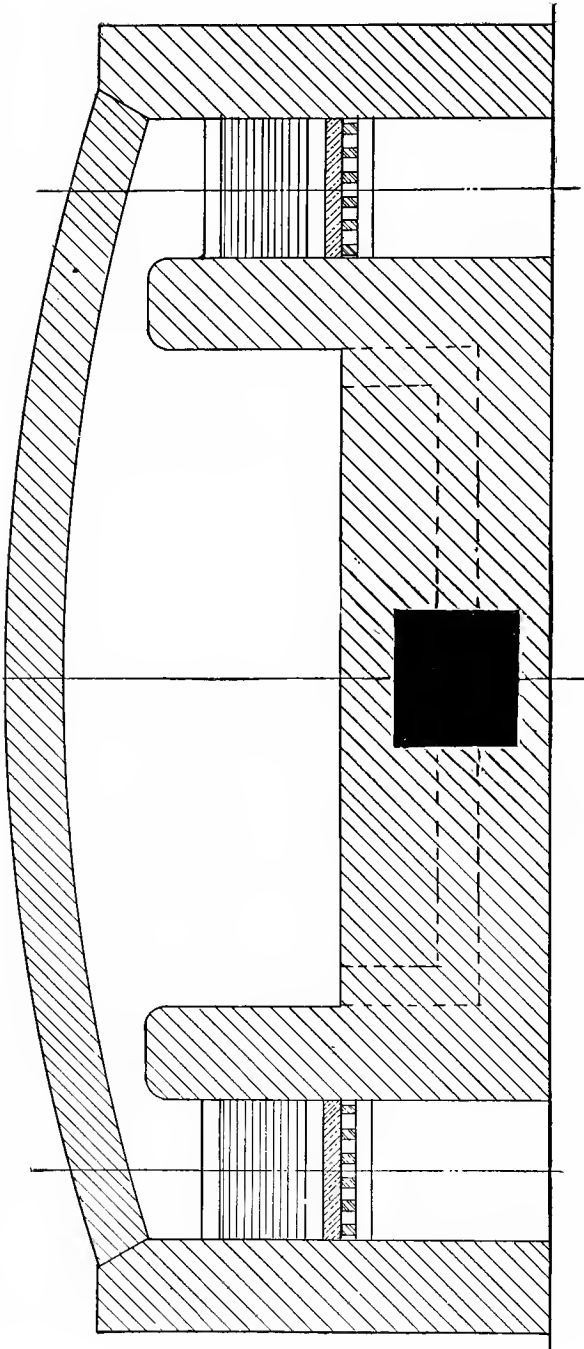

Fig. 310. Lehrs, 80 feet long equipped with only one burner.





SECTION AT C-C
 Fig. 312. Muffle Lehr.



SECTION B.B.

Fig. 313. Plate glass bending furnace, changed from coke to oil-fired.

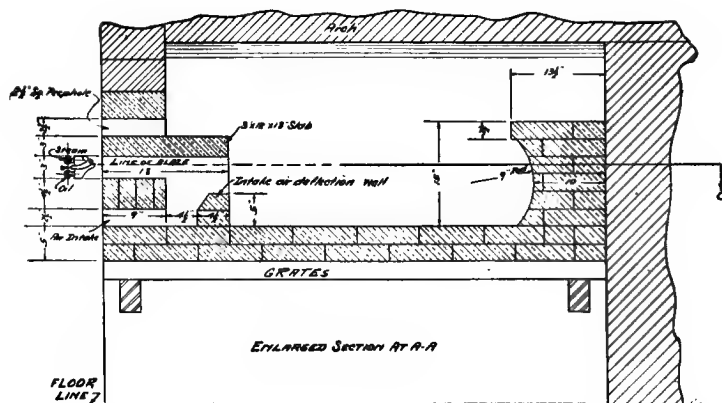

Fig. 314. Plate glass bending furnace. Cross sectional view showing flue in center and the grates covered with fire-brick on either side.

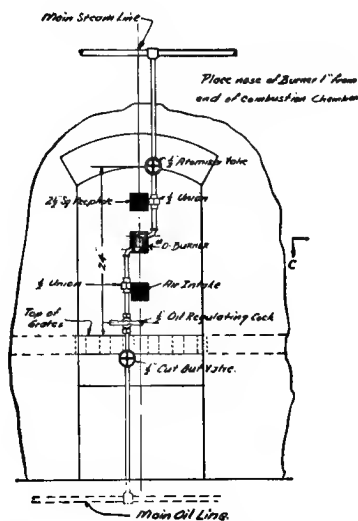

Fig. 315. Burner end view of plate glass bending furnace.

Chapter XXVIII

COMBUSTION ENGINEERING

As oil is now used in nearly every large works there is a great need to-day for the intelligent installation and operation of oil-burners and oil systems. The demand is increasing daily for real combustion engineers who have had experience in the operation of boilers, furnaces, etc.;—for those who can effect a saving in fuel in the average plant representing three or four times the amount of their salary. There are a few competent combustion engineers in this country, but the demand for men trained in the art of properly burning oil far exceeds the supply. It takes years of training to become competent, for in this calling theory must give way to practice. The engineer's superior knowledge as to how best to obtain results commands the respect of the men in charge of the furnaces and boilers.

There are many to-day who imagine that they are combustion engineers, but we find that these have had very little actual experience. For example, in large copper furnaces the charge is sometimes worth from \$50,000 to \$75,000, and of course experimenting cannot be permitted. Though the furnace may be properly designed, the burner of adequate capacity and the oil system perfectly installed, if the apparatus is operated by a novice everything will be condemned and the charge oxidized and ruined—possibly a total loss. I have seen oil as a fuel condemned in hundreds of plants simply because the operator claimed he had had experience in burning oil, but his operation of the burners plainly proved he had only seen oil-fired furnaces in operation and that he had never operated them before. Again, too, I have often seen furnaces the design of which reflected upon the designer and caused oil to be rejected for years in that plant until finally one of the officials, seeing it burned successfully in another plant manufacturing the same product, compels his works to again use liquid fuel for he feels that his works can certainly use oil as successfully as competing firms.

What we need is combustion engineers who can design furnaces

which will be a credit to both the engineer and the company with which he is connected. They must be men experienced in the burning of liquid fuel and the designing of furnaces, for experiments are costly, and no manufacturer desires to construct furnaces which may not prove efficient. If it is a heat-treating furnace for the heat-treatment of 20 tons of metal, the metallurgist will inform the designer as to the proportions of the sections of the charge, the length of time the metal should remain in the furnace and the temperature at which it should be heat-treated. If he cannot with this data before him calculate the quantity of liquid fuel and air required to bring the charge to a given temperature and maintain that temperature for the length of time required, he is a failure. He should have the data required for such calculations so that in 998 furnaces out of every 1,000 he will be successful. If he cannot do this he is a very dangerous man in any plant or office.

I know there are many designers who put six burners on one side and eight burners on the other side of a furnace, staggering their locations. Then, if this number of burners does not bring the furnace to temperature, they will put in some more burners. That is certainly not engineering; just merely guesswork and should not be permitted! By placing a large number of burners in a furnace it is impossible to control the temperature accurately. Some of the burners are operated at CO and others at CO₂, which makes it very perplexing for the operator in his endeavor to maintain an even distribution of heat in the furnace. The man who designs a combustion chamber of adequate proportions and then cannot chart off the radiation of heat in the furnace, cannot be considered a successful designer. This of course cannot be done if a large number of burners are used and their location staggered in the manner just mentioned. If we desire to sell our goods in foreign countries and tag them "Made in America," our product should be heat-treated properly in order to merit the name of our beloved country.

A college-trained man has many advantages over the mechanic who has not had the benefit of a college education, providing the college man after graduating uses his technical training as a foundation on which to place practical knowledge. This requires years of sacrifice and hard labor. He must begin at the very bottom, so to speak, and climb round by round to the top of the ladder.

When he has added practical knowledge to his technical education he can live a life worth while, and his services will always be in demand. If he is examining an oil pump which fails to operate he will then be capable of noting its defects, and will not have to depend upon the judgment of the stationary engineer or mechanic but upon his own knowledge based upon facts—not theory.

From time to time men claiming to be engineers come into my office and state that, according to certain figures which they have compiled, when using good coal one should get an evaporation of 16.3 pounds of water per pound of coal and using oil of 19.5 pounds of water per pound of oil. They do not specify the calorific value of the coal, which is of course very important. It might be Pocahontas coal of the Virginias which has a calorific value of 15,391 B.t.u. per pound, or it might be Illinois coal which has a calorific value of 10,500 B.t.u. per pound. I invariably inquire where they secure this data but have never been able to find out the name of any plant operating with such wonderful efficiency as they claim. When questioned as to their data, they invariably make the statement that figures do not lie; and yet every engineer knows that figures in the hands of a novice can be made to tell some terrible falsehoods. The safe man is the one who compiles his own figures, not using the exceptional cases, but the data secured from numerous tests. I always like to see a man who has genius enough to be daring, for that man is a leader among men if he has any real knowledge. I speak now of knowledge, not theory. I wish to emphasize this point, because these men are absolutely necessary if we are going to advance.

It is unfortunate that our universities, colleges and trade schools do not train their students in the burning of liquid fuel, because this in my judgment is absolutely essential at the present time. There are very few manufacturers who do not burn oil in some portion of their works. Oil is the fuel of the twentieth century. Imagine the thoughts of a graduate who has just received his diploma, and entered the employ of a plant where oil is used as fuel either in its power plant, heat-treating department, or some other department. I will give you a concrete example of such an occurrence.

About 12 years ago a young man after graduating from a technical school went to work in a large manufacturing plant. Knowing the need of obtaining a practical knowledge of the method of

manufacturing their various products, he began in the smith shop as a smith's helper, and went through all the various departments until he became thoroughly acquainted with the work in each department. At that time the fuels used in this plant were producer gas and coal. The president of the company watched this young man for three years and then determined to make him shop superintendent. This position he filled admirably for a year. Then he approached the president and stated he desired to install oil as fuel in the plant because he wished to modernize it. The president assented to his wishes, and oil was installed. This resulted in increasing the output of the plant approximately 100 per cent., reduced the cost of fuel, and vastly improved the quality of their product. He was later given an interest in the business, and made general superintendent of the entire plant, embracing all the different departments.

Shortly after that the new general superintendent's brother, who had just been graduated from the same technical school as he, was offered a position in the plant by his brother. The first job he got was to find out the quantity of oil required to forge and heat-treat a certain class of goods made in the works. The brother immediately went out to the shop and for the first time saw oil burned in furnaces. He returned to his brother and said: "Brother, I am sorry to have to fall down on the first job you have given me, but I myself must first learn the art of properly burning oil before I can make a correct report to you." The general superintendent clasped his brother's hands and stated: "That is just what I hoped you would say. I knew that you knew nothing about burning oil, and put you to the test to find out just what you would say. Had you made a bluff at it we would both have been disappointed, but since it is your desire to first learn how to burn oil, it will be a pleasure for me to aid you in every way possible." Suffice it to say that the young man for several years held a responsible position with this firm. Afterwards he became the works manager of a new plant.

I know of but one institution of learning in the world that is making an effort to instruct its students in the science of burning liquid fuel. Their new building has just been erected and their oil tanks, furnaces, etc., are being installed. I refer to the Lincoln Memorial University, Harrogate, Tenn. (near Cumberland Gap). The accompanying cut shows the plan lay-out of a school for the

BURNING LIQUID FUEL

instruction of students in the burning of liquid fuel for melting, forging and heat-treatment of metals.

It is always advisable to keep all patterns in a fire-proof building made of stone, brick or concrete. This building in the diagram is marked "No. 1" and is, as you will note, located some distance from the other building, which also is a precaution against fire. No. 2 is the boiler room, while Nos. 3 and 4 indicate the brass and grey iron foundries. No. 5 is the stock room for the forge drop and No. 6 is the mason's room wherein all furnaces are relined or repaired. No. 7 is the forge shop and the heat-treating room, No. 8, the machine shop; No. 9, the testing room, and No. 10 is the exhibition room.

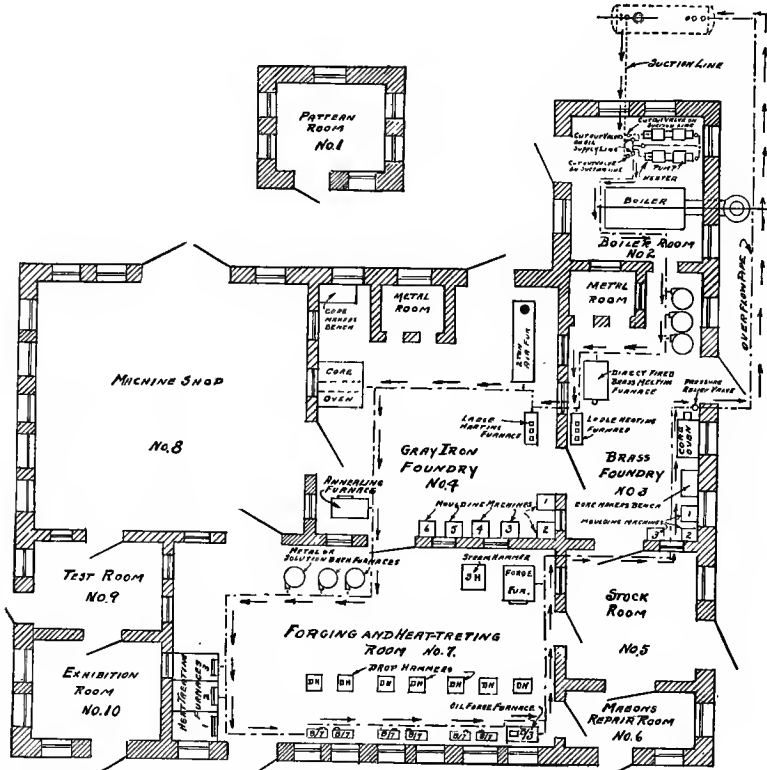

Fig. 316. Plan layout of building at Lincoln Memorial University, showing boiler room, foundries, machine shop, etc.

INDEX

	PAGE		PAGE
A		B	
Air, Auxiliary	35, 238	Bagasse, Calorific value	143
Furnaces	195	Oil required per ton	143
Quantity required for combustion	34	Bar Rivet—Making Furnaces	
Regulation	124	Billet Heating Furnaces	
Analysis, Air Furnace Bottom Sand	71	Coal to Oil-fired	230
Bagasse	143	Concrete Base	230
Beaumont (Texas) Crude Oil ..	25	Continuous	227
Brick for Crucible Furnaces	69	Copper	269
California Crude Oil	25	Modern	229, 237
Coal	88	Oil versus Coal	225
Fuel or Residium Oil	25	Portable	232
Mexican Topped Crude Oil (Tam- pico Fields)	25	With Waste Heat Boiler ..	233, 238
Tar, Coal	26, 27	Boilers: Apparatus for Firing Up and Testing	249
Dominion Coal	26	Babcock & Wilcox (Altman- Taylor)	57, 101, 142
London	26	Back-fired	93, 145
Oil	26	Blast Furnace Gas and Oil as Fuel	126
Angle Heating Furnaces	247	Burners	33, 85, 87, 134
Annealing and Tempering Furnaces		Coal and Oil or Tar Combination Equipment	85
Automobile Spring	186	(See Liquid Fuel Injecting Ap- paratus)	
Burners Required	173, 193	Differential Draft Gage	121
Car type	177, 179	Economic	89
Cast Iron Pipe	186	Electric Light Plants	86
Coal or Coke, fired changed to oil	186	Ferry Boats Tugs etc.	95
Combustions Chambers for	191	Firing up when Boiler is Cold.	89, 108
Declined Hearth	186	Fitzgibbons	114
Direct-fired	178, 237, 244	Heine	94
Direct versus Indirect-fired .	171, 173	Horse Power	126
High Speed Steel	173, 178, 237, 242, 244	Hot Water or Low Pressure Steam	129
Hot Air	186	Lancashire	97, 98
Indirect-fired	171, 175	Line of Blaze	94
Malleable Iron Castings	201	Liquid Fuel Injecting Apparatus	114
Muffle	244, 270	Locomotive Type—Stationary Service	88
Overhead-fired	178	Manner of Lighting Burner....	89
Pipe, large	263	Manning	113
Pit	186	Multitubular	146, 147, 148
Portable	245, 251, 258	Oil versus Coal	27, 85, 87
Preheating Chamber, with	178	Peak Loads	85
Rotary, Cold Pinched Nuts, etc..	184	Return Tubular	108, 136
Rotary Table	183	Scotch Marine: Dry-back	100
Semi-Muffle	186, 223	Wet-back	99
Semi-Pit	186	Settings: Grate versus Deep...	94
Shaft	179		
Sheet Copper and Brass	210		
Shell	179, 181		
Asphalt Melters and Mixers	296		
Axe Head Tempering Furnace	241		

	PAGE
Flue Welding Furnace.....	261
Foot Valve and Strainer.....	
Forge, Oil.....	234
Forge Shop—Modern.....	221
Forging Furnaces: Coal to Oil-fired	235
Concrete Foundations.....	230
Flame Required for Welding...	235
Portable.....	241, 245
Small.....	242, 244
Frame Welding (Locomotive).....	255
French Kitchen Ranges.....	311

G

Gas Burner (Natural or Commercial)	38
Gas and Oil—Boiler Service.....	109
Glass Melting, Bending and Annealing	321
Globe Valve versus Oil Regulating Cock	46
Graphitic Coal.....	28
Gravity Feed Oil Systems,	
40, 110, 122,	129
Grey Iron Castings: Annealing ..	186
Melting.....	200

H

Hand Torches.....	259
Hardening Dies.....	244
Heat.....	216
Heat Deflectors.....	230, 238
Heat Ports: Indirect-fired Furnaces	175, 223
Mould Drying Ovens.....	160
Heating Crown Sheets.....	251, 258
Heat-treating Furnaces: Coal versus Oil	27
(See Annealing Furnaces)	
High Pressure Burners.....	36
High Speed Steel Furnaces,	
173, 174, 235, 242,	244
Horse Power, Boiler.....	126
Hot Air Furnace.....	133, 186
Hydrometer Thermometer.....	32

I

Incinerator.....	319
Indirect-fired Furnaces (See Annealing):	
Burners Required.....	173
Cartype.....	179
Shell Annealing.....	179
Twin-type.....	188
Ingot Heating.....	225
Inverted Arches (Locomotive)....	73
Iron Ore Desulphurizing Furnace..	305

J

Japanning Oven.....	270
---------------------	-----

K

Kilns: Brick.....	284
Cement.....	292
Char.....	150
Lime.....	287
Ore Roaster.....	296
Pottery.....	286

L

Laboratory Furnace.....	259
Ladle Heating.....	152, 165, 215, 258
Lead Bath Furnace.....	183
Lehrs.....	327, 328
L'envoi.....	340
Lighting cupolas.....	261
Lime Kiln.....	287
Lincoln Memorial University.....	336
Line of Blaze—Boiler.s.....	94
Liquid Fuel Injecting Apparatus...	114
Air Furnaces.....	200
Bagasse, In Combination with..	149
Return Tubular Boiler.....	136
Stirling Boiler.....	118
Waste Heat Boiler, O. H. Furnace	117
Water Gas Tar, With.....	129
Wickes Boiler.....	119, 120
Locomotive: Boiler—Stationary	
Service.....	88
Burner.....	72
Damper Regulation.....	74
Duplex Oil System.....	80
Fireman's Regulating Quadrant.	74
First Electric.....	7
First Equipped by Author.....	9
Frame Welding.....	255
Inverted Arches.....	73
Oil Regulating Cock.....	75
Oil Superheater.....	76
Oil Tank.....	76
Oil versus Coal.....	26
Pilot Burner.....	80
Testing Apparatus.....	249
Tonnage—Coal versus Oil.....	72
Low Pressure Burner.....	38

M

Magnesite Brick.....	70
Malleable Iron Furnaces: Annealing	
First, where located.....	199
Modern Melting.....	197
Type of Burner Required.....	200

	PAGE		PAGE
Martinsite	172	Oil:	
Mechanical Burners	37	Versus Wood	27
Metallurgist	216, 223	Open Hearth: Burner with Swivel	
Melting Furnaces	201	Joints	152, 153, 158
Melting—Laboratory Tests	259	Burner, water-cooled	163
Meter, Steam Flow	121	Furnace, Gas to Oil-fired	152
Millet Ovens	215	Furnace, Modern	162
Molasses Refuse	151	Ore Roasters	295, 301, 304
Mould Drying	158, 211	Overhead Oil-fired Furnace	178
Moulds, Skin-drying	261		
Mounted Burner—Boilers	85	P	
Muffle Furnaces, annealing, baking		Pearlite	171
enamel, etc.	244, 269	Peterson Bread Oven	309, 310
Muffle Lehr	329	Pipe: Annealing, large Cast Iron. 186	
Multiple Ladle Heating Furnace,		Bending	251, 259, 261, 263
166, 167		Brazing	258, 261
O		Flange Welding	263
Oil: Analysis	See Heading	Joints, Paste to Prevent Leaking	40
Atomization	33	Plant Supt; The successful	224
Automatic Regulation	36	Plate Glass Bending	330, 331
Base	24	Plate Heating Furnaces	243
Bath Furnace	184	Portable Furnaces 245, 251, 256, 258, 259	
Chemical Furnace Heating, For. 281		Pottery Kiln	285
Discovery	18	Power Plants: Coal versus Oil ... 27	
Fluctuation, Cause of ... 42, 50, 138		Peak Loads	85
Foot Valve and Strainer	55	Preheating Air	
Forge	234	Preheating Chamber	178
Geological Formation	16	Pressure Reducing Valve	247, 254
Gusher—Spindletop	17	Pressure Relief Valve	55
Heaters	56, 76	Pulsometer	55
Heating—Temperature Required,		Pulverized Coal: Burner	38
42, 219		Method of Burning in Combina-	
Origin	15	tion with Oil	28
Piping, Fittings, etc.	40	Pumps	42, 138
Pressure Reducing Valve ... 247, 254		Pumping Systems	See Systems
Pressure Relief Valve	55	Pyrometers	67
Production: U. S. annual by			
states	19, 20	Q	
U. S. annual by fields ... 21, 22		Quadrant, Fireman's Regulating .. 74	
World	23, 24		
Pulsometer	55	R	
Pump Regulator	50, 54	Recuperative Furnaces—Glass 322, 325	
Pumps	42	Reel Oven—Cracker	309
Quantity Required in Various		Refuse—Incinerator	319
Services	26, 27	Regenerative Furnaces: Glass ... 323	
Regulating Cocks	46, 75	Open Hearth	152
Sand	16	Regulating Cocks	46, 75
Stand-pipe or Column	42	Return Tubular Boiler: Oil exclus-	
Still	315, 316	ively as fuel	108
Study of, at Lincoln Memorial		Oil in Combination with Coal or	
University	336	Breeze	86, 136
Superheater	76	Rivet Furnaces: Heating, Stationary 244	
Supply Systems	See Heading	Heating, Portable	245
Tanks	See Heading	Making	244
Testing Apparatus	31	Roasters: Cocoa Bean	313
Use of in Navy	217	Ore	296, 305, 306
Versus Coal in Various Services,		Rosin Still Equipment	276
26, 27			

	PAGE
Rotary Equipments: Bread Oven	308
Dryers	295, 300, 302
Furnaces	183, 184
Kilns, Cement	294
Kilns, Lime	288
Reel Oven, Crackers	307
Ore Roasters	304
Rudder Welding	254

S

Sand Dryer	300
Scotch Marine Boilers	99, 100
Scrap Brass Melting Furnace	206
Scrap Iron Welding	11, 238
Semi-foot, Bung Arch Annealing Furnace	186
Separator, Sharples	137
Shaft Furnaces: Annealing (car type)	179
Heating	237
Shell Annealing Furnaces: Direct fired	180
Indirect fired	175
Shingling Furnace	235
Soaking Pits	164
Solution Bath Furnace	184
Steam Flow Meter	121
Steam versus Compressed Air	36
Steel, Drawing	186
Steel Foundry Castings, Annealing	186
Steel Heat Treatment	171
Stills: Chemical	273
Oil, heated	281
Oil and Tar	315
Stokers and Oil Equipment	87
Sugar-Calorific Value	143
Sulphur, To eliminate Effects of	199, 219, 223
Sulphuric Acid Furnace	280
Superheater (Oil)	46, 76
Systems, Oil Supply: Boiler Testing	122, 123
Complete Circulating	223
Compressed Air	42
Gas Works	40, 138
Gravity Feed	40, 110, 129, 138
House Heating	42, 129
Imperfect	50, 221
Light Oil	40, 44
Marine Service	44
Pressure Recommended on	221
Proper, Modern	50, 56
Temporary	56, 63
Thermometers on	39
Valveless	42

T

	PAGE
Tangential Flame Equipment:	
Boilers	108
Crucibles	210
Furnaces	184
Stills	274, 275
Tanks: Care of	67
Capacity, To find	67
Concrete	66
Fire Prevention	40
Foot Valve and Strainer	55
Heating of	39, 67
Locomotive	76
Size Recommended for Oil Storage	42
Steel	56
Ventage	67
Tar: Analysis	26
Gravity Feed	40, 86, 138
Heating of	44, 46, 138
Stills	317
To Separate from Water	135
Valveless System	42
Testing Instruments	31
Thermometers	39
Tire-heating	261
Tool Dressing	235, 242, 244
Tubal Cain	216
Tug Boats: Increase in Service	26, 225
Boiler Equipment	95

V

Valveless Oil System	42
Vanstoning	263
Vaporizing Point: Retort for De- termining	30
Various Fuels	25, 219
Ventage: Oil Systems	55, 138
Furnaces	157, 223, 249
Vertical Boilers	108, 109, 113, 134
Volume Air: Burner	38
To Aid Combustion	35, 291

W

Waste Heat Boilers	233, 238
Water Gas Tar: Chemical Action	138
To Separate from Water	135
Uses	27, 29
Water-Smoke, To Remove	284
Welding: Flame Required for	235
Flues	261
Furnaces	225
Locomotive Frame	255
Pipe	263
Rudder	254
Scrap Iron	238

