

OUTLINES OF INDUSTRIAL CHEMISTRY

# AN INTRODUCTION TO THE STUDY OF FUEL

A TEXT BOOK FOR THOSE ENTERING THE  
ENGINEERING, CHEMICAL AND  
TECHNICAL INDUSTRIES

BY

F. J. BRISLEE, D.Sc.

CHIEF CHEMIST OF THE BRITISH INSULATED AND HELSBY CABLES, LTD  
LATE ASSISTANT LECTURER IN PHYSICAL AND ELECTRO-CHEMISTRY  
IN THE UNIVERSITY OF LIVERPOOL

*SECOND IMPRESSION*

LONDON  
CONSTABLE & COMPANY LTD  
10 & 12 ORANGE STREET LEICESTER SQUARE WC

1920

*Printed in Great Britain.*

**This Book is Dedicated**  
TO MY  
**FATHER AND MOTHER**  
IN  
**GRATITUDE AND AFFECTION.**



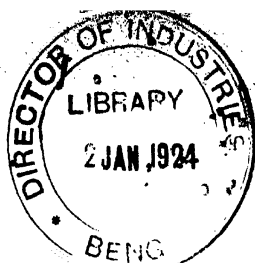

## GENERAL PREFACE TO THE SERIES

---

THE object of the series of volumes collected together under the general title "Outlines of Industrial Chemistry" is to provide students and persons employed on the technical side of any particular industry with a handbook explaining the chemical aspect of the operations carried on in that industry. It is hoped, too, that the series may be found useful and interesting to many business heads and subordinates who are employed mainly in the office, but who still take an interest in the processes by which their dividends or salaries are earned.

Only a slight acquaintance with chemistry is assumed on the part of the reader; in fact, a principal object of the series is to provide a link between the elementary chemistry taught in schools and institutions which provide instruction up to, say, the matriculation standard of a modern university, and the larger text-books dealing with the details of the separate industries. In most cases these large works are quite beyond the intellectual and financial reach of those who enter industrial employment, and the result is that a clear understanding of the essential processes of an industry can only be obtained by slow absorption from the busy senior members of the staff.

It is believed, moreover, that each volume in the series, though it deal with the chemistry of one industry only, will serve an educational as well as a purely utilitarian purpose. Examples which illustrate the general processes of deduction, and of the building up of an hypothesis or theory by the scientific method, may be drawn from the particular set of chemical facts to be met with in almost any one industry. Thus, while familiarising himself with just those phenomena which are of fundamental importance to him, the student will be learning how they may be correlated and welded together into a coherent scientific system.

## GENERAL PREFACE TO THE SERIES

The science of chemistry has grown so rapidly, in recent years, and such immense masses of knowledge have been accumulated, that no one man can hope to become even moderately conversant with every branch of the subject. A student possessing an elementary general knowledge of chemistry, and only a limited time for study, is therefore justified, even from an educational point of view, in spending that time in the study of the class of facts most intimately associated with his particular industry.

Such a course has the further advantage that it will stimulate the best intellects to seek for a deeper knowledge of pure chemistry. A thinking student will soon find that he has come face to face with phenomena which he cannot explain in the light of the knowledge he has already acquired. He will feel that progress in the chemical side of his industry may very possibly be obtained by careful investigation of the unexplained and unexpected anomalies that occur from time to time; or, perhaps, by the application or adaptation of principles or processes discovered by purely scientific workers in the laboratory. In this way he may be brought back to study more deeply the methods and principles of pure chemistry; such a study can but react to the benefit of the student, the employer and the industry concerned.

---

It is peculiarly fitting that the first volume of the series to be issued should be that on "Fuel." In this country, owing to a general lack of water-power, the combustion of fuel is the primary source of energy in almost every industry. The development of this energy is the special task of the engineer. It is hoped, therefore, that Dr. BRISLEE'S book may be found especially useful to engineering students and others concerned in the purchase, valuation and utilisation of fuel. Dr. BRISLEE'S acquaintance with these important practical matters is a wide one, and his pioneer research-work on combustion, especially in locomotive fireboxes, proves that he is equally familiar with the scientific aspects of the subject with which he deals.

GUY. D. BENGOUGH.

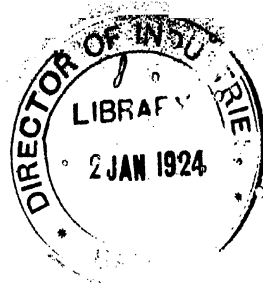

## PREFACE

---

THE following book is the outcome partly of teaching and partly of technical experience. In it I have attempted to bridge the gap that exists between the ordinary elementary text-books of chemistry, and the large treatises dealing with fuel which enter into minute details of the chemical composition of fuels, the design of coke ovens and producers, and other purely descriptive matter. To this end, I have described the principles of fuel analysis, and the methods of determining calorific power, and of high temperatures. The last subject has been treated with a fair amount of detail, particularly as regards the methods of calibrating a pyrometer, an operation which is rendered increasingly necessary owing to the exact regulation of temperature requisite in many processes. The reversibility of a chemical reaction and the conditions governing it have been indicated, and the ideas of chemical equilibrium and reaction velocity kept in prominence throughout the book. The reasons for non-attainment of equilibrium in technical practice have been outlined. In the discussion of solid fuels, I have given only a few salient points, since very full details are published in the larger text-books of fuel, and no gain would be realised by reproducing long lists of fuel analyses. Gaseous fuel has been treated at some length, and an attempt has here been made to introduce the calculations of Jüptner, since they show, in a very admirable way, the application of the modern methods of physical chemistry to technical problems. This chapter can be omitted by the student at the first reading. In it the notation of the infinitesimal calculus has been used, and

the fundamental formula derived from the Clapyron-Cläusius equation.

The descriptions of coke-making plant and gas producers have been kept within narrow limits, since these are excellently described in many treatises.

All calculations are made with the gram and litre or cubic metre, as units of weight and volume respectively, because of the simplicity thereby introduced into the calculation of reacting quantities from a chemical equation. The calorie is used as the unit of heat, and for the conversion of this and the units of weight and volume into other units, a simple conversion table has been given in Appendix V.

In Chap. XV. I have tried to show the various considerations which determine the selection of a fuel for a given purpose, and the chemistry of its economical combustion. The importance of utilising the waste heat contained in the products of combustion cannot be over-estimated, and the net gain effected by utilising some of this for heating the air supplied to the furnace, is strikingly shown in some figures kindly supplied by my friend Robert Bruce, Esq., M.I.M.E., which are given in Chap. XIV., p. 234 and f.

The book makes no pretensions to completeness, but deals with the main principles rather than full details; it is hoped that it may serve as a starting point for further study, and some useful text-books are mentioned in the Appendix. The excellent book of Jüptner, *Lehrbuch der Chemischen Technologie der Energie*, should be read by all who wish to follow the subject further.

I am greatly indebted to Mr. G. Nelson Holmes for the care and skill with which he prepared the drawings for this book, to the Cambridge Scientific Instrument Co., Ltd., Cambridge, and to Mr. Chas. W. Cook, Manchester, for the loan of blocks and illustrations on pyrometry and the bomb calorimeter; also to Messrs. Babcock and Wilcox for details of boiler performances and heat balances, which are given in Chap. XV. I am also



PREFACE

xiii

greatly indebted to my friends Mr. Robert Bruce, Mr. A. E. Bruce, and to my colleague Mr. R. P. Nash, for reading through the proofs, for kindly criticism and much useful information, the result of many years of technical experience; and to all I beg to express my gratitude and thanks.

PRESCOT, LANCs.,  
1911.

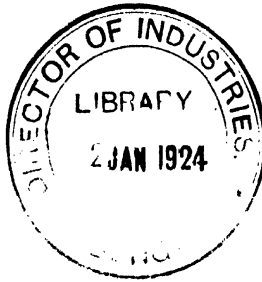



# CONTENTS.

## CHAPTER I

### GENERAL CHEMICAL PRINCIPLES

	PAGE
Combustion . . . . .	1
The Weight and Volume of Reacting Substances . . . . .	2
The Correction of Gas for Pressure and Temperature . . . . .	4
Reversible Reactions and Balanced Actions . . . . .	6
Reaction Velocity and Catalysis . . . . .	10
Dissociation . . . . .	14

## CHAPTER II

### WEIGHT AND VOLUME OF AIR REQUIRED FOR COMBUSTION

Weight of Air required for Combustion . . . . .	19
Volume of Air required for Combustion . . . . .	20
Combustion of 1 lb. of Carbon to $\text{CO}_2$ . . . . .	22
Combustion of 1 lb. of Hydrogen to $\text{H}_2\text{O}$ . . . . .	22
Weights and Volumes of Various Gases . . . . .	23
Weight and Volume of Air required for Complete Combustion. Weight and Volume of the Products . . . . .	24
Excess of Air . . . . .	26
Economical Combustion of Fuel . . . . .	28

## CHAPTER III

### ANALYSIS OF FUEL AND FLUE GASES

Determination of Moisture . . . . .	30
Determination of Volatile Matter . . . . .	31
Determination of Ash . . . . .	31
Determination of Carbon and Hydrogen . . . . .	32
Determination of Nitrogen . . . . .	33
Determination of Sulphur . . . . .	33
Analysis of Products of Combustion and Flue Gases . . . . .	36
Methods of Obtaining a Fair Sample of Gas . . . . .	37
Determination of Carbon Dioxide . . . . .	40

	PAGE
Determination of Oxygen . . . . .	41
Determination of Carbon Monoxide . . . . .	42
Estimation of Hydrogen, Methane and Nitrogen . . . . .	44
Method of Calculating the Results of an Explosion Analysis. . . . .	46
Orsat Gas Analysis Apparatus . . . . .	48

## CHAPTER IV

## CALORIMETRY AND DETERMINATION OF THE HEATING VALUE OF A FUEL

Units of Heat Defined . . . . .	51
Evaporative Power . . . . .	52
Formula for Calculating Calorific Power . . . . .	53
Berthier's Method for Determining Calorific Power . . . . .	54
Experimental Determination of Calorific Power . . . . .	55
The Lewis Thompson Calorimeter . . . . .	56
Typical Example of Calculation . . . . .	57
W. Thomson Calorimeter . . . . .	58
The Rosenhain Calorimeter . . . . .	60
F. Fischer's Calorimeter . . . . .	62
The Bomb Calorimeter . . . . .	63
The Berthelot-Mahler-Cook Bomb Calorimeter . . . . .	64
Calculation of Result of Experiment . . . . .	67
Calorimeter of S. W. Parr . . . . .	71
Calculation of Results obtained with Parr's Calorimeter . . . . .	73
Calorific Power of a Gas . . . . .	74
The Junker Calorimeter . . . . .	74
The Boys' Calorimeter . . . . .	77
Relation between Combustion at Constant Pressure and at Constant Volume . . . . .	78

## CHAPTER V

## MEASUREMENT OF HIGH TEMPERATURES—PYROMETRY

Classification of Pyrometers . . . . .	82
The Gas Thermometer . . . . .	83
Thermo-electric Pyrometers . . . . .	86
Thermo-electric Recording Pyrometers . . . . .	88
Resistance Pyrometers . . . . .	92
Recording Pyrometers Resistance Type . . . . .	93
Optical Pyrometers . . . . .	95
Féry Radiation Pyrometer . . . . .	95
Stefan-Boltzmann Radiation Law . . . . .	99
Féry Absorption Pyrometer . . . . .	102
The Wanner Pyrometer . . . . .	103
Heiborn and Kurlbaum Pyrometer . . . . .	105
Calorimetric Pyrometers . . . . .	107
Various Methods of Temperature Measurements . . . . .	109

## CONTENTS

xvii

	PAGE
Calibration of Pyrometers . . . . .	110
Standard Substances for Calibration . . . . .	110
Ice Point . . . . .	111
Boiling Point of Water . . . . .	112
Boiling Point of Sulphur . . . . .	113
Melting Point of a Metal . . . . .	114
Protection of Pyrometers . . . . .	114
Porcelain Tubes . . . . .	114
Quartz Tubes . . . . .	115
Graphite Tubes . . . . .	115
Metal Tubes . . . . .	115

### CHAPTER VI

#### CALCULATION OF COMBUSTION TEMPERATURES

Theoretical Maximum Temperature of Combustion . . . . .	116
Combustion Temperature of Solid Fuels . . . . .	122
Relationship between Heat of Combustion and Temperature of Combustion. Kirchoff's Law . . . . .	124

### CHAPTER VII

#### NATURAL SOLID FUELS

Classification of Fuels . . . . .	127
Natural Solid Fuels, Coal . . . . .	128
Natural Solid Fuels, Peat . . . . .	130
Natural Solid Fuels, Lignites . . . . .	131
Natural Solid Fuels, Bituminous Coals . . . . .	132
Grüner's Classification of Bituminous Coals . . . . .	132
Compositions of Various Bituminous Coals . . . . .	135
Test for Identifying Class to which a Coal belongs . . . . .	135
Wood . . . . .	137

### CHAPTER VIII

#### ARTIFICIAL SOLID FUELS

Dry Distillation of Peat, Coal, or Wood . . . . .	139
Advantages and Disadvantages of Carbonising . . . . .	139
Changes brought about in Coking . . . . .	140
Charcoal Burning . . . . .	140
Composition of Wood Charcoal . . . . .	143
Coke . . . . .	143
Influence of Temperature upon Coking . . . . .	144
Methods of Coking . . . . .	145
Coking in Piles, Heaps or Kilns . . . . .	146
Beehive Coke Oven . . . . .	146
Coke Making with Recovery of By-Products . . . . .	148

F.

	PAGE
Huessener Coke Oven . . . . .	149
Working of Huessener Coke Plant . . . . .	152
Thermo-chemical Changes in Coking . . . . .	155
Briquettes . . . . .	156
Locomotive Fuel Testing Plant at Altoona, Pa. . . . .	157
Results of Tests of Briquetted Fuel . . . . .	157

## CHAPTER IX

## GASEOUS FUEL

Advantages of Gaseous Fuel . . . . .	159
Natural Gas . . . . .	159
Producer Gas . . . . .	160
Partial Combustion of Carbon . . . . .	161
Le Chatelier's Theorem . . . . .	162
Jüptner's Calculations of Ideal Producer Gas . . . . .	162
Reasons for Non-attainment of Equilibrium in Technical Practice . . . . .	163
Combustion of Fuel in a Producer . . . . .	164
Boudouard's Experiments . . . . .	165
Compositions of Producer Gas . . . . .	167
Heat Production and Loss in Gas Producer . . . . .	167
Water Gas, Ideal Gas . . . . .	169
Thermo-chemistry of Water Gas . . . . .	170
Jüptner's Explanations for Non-attainment of Equilibrium . . . . .	172
Efficiency of Producer . . . . .	174
Dowson Gas or Mixed Gas . . . . .	176
Blast Furnace Gas . . . . .	177
Reactions in Blast Furnace . . . . .	178

## CHAPTER X

## THE MANUFACTURE OF PRODUCER GAS AND WATER GAS

Siemen's Producer . . . . .	179
Hopper for Producer . . . . .	180
Wilson Producer . . . . .	181
Water Gas Manufacture . . . . .	182
Water Gas Plant . . . . .	183
Suction Gas . . . . .	185
Suction Gas Producer . . . . .	186
Blast Furnace Gas . . . . .	187

## CHAPTER XI

## THEORY OF THE PRODUCER GAS AND WATER GAS REACTIONS

Cycle Performed in Evaporation of Water . . . . .	188
Derivation of Equation . . . . .	189
Equilibrium Constant from Boudouard's Experiments . . . . .	192
Calculated Values for Factors in Equilibrium Equation . . . . .	193
Calculation of Percentage of CO and CO <sub>2</sub> . . . . .	194

## CONTENTS

xix.

	PAGE
Combustion of Carbon in Producer with Air . . . . .	195
Water Gas Equilibrium . . . . .	197.
Hahn's Values for K . . . . .	198
Change of Equilibrium Constant with Temperature . . . . .	199

### CHAPTER XII

#### EXPLOSION AND THE EXPLOSION ENGINE

Explosion . . . . .	201
Ignition Temperatures . . . . .	202
Velocity of Propagation of Combustion . . . . .	202
Ignition Pressure . . . . .	203
Calculation of Pressure developed by Explosion . . . . .	205
Composition of Gases used for Explosion Engines . . . . .	205
Efficiency of Engines . . . . .	207
Maximum Work done by a Chemical Reaction . . . . .	208
Heat Losses in Explosion Motors . . . . .	209
Explosion Waves in Gas Mixtures . . . . .	211

### CHAPTER XIII

#### AIR SUPPLY AND MEASUREMENT OF DRAUGHT

Efficiency of Combustion of a Fuel . . . . .	215
Combustion in a Lancashire Boiler . . . . .	216
Combustion in a Locomotive Firebox . . . . .	217
Chimney Draught . . . . .	218
Variation of Draught with Height of Chimney . . . . .	219
Artificial Draught . . . . .	220
Measurement of Draught . . . . .	221
Lunge's Method for Calculating Volume of Flue Gases . . . . .	223
Seeger's Differential Manometer . . . . .	224
Fletcher's Anemometer . . . . .	226
" Rota Measuro " . . . . .	227

### CHAPTER XIV

#### FURNACE EFFICIENCY AND FUEL ECONOMY

Losses of Heat in Technical Processes . . . . .	228
CO and CO <sub>2</sub> in Flue Gases . . . . .	229
Loss of Carbon in Ashes and Smoke . . . . .	230
Radiation Losses . . . . .	231
Radiation and Conduction of Heat . . . . .	232
Loss of Heat in Products of Combustion . . . . .	233
Heat Economy and Utilisation of Waste Heat . . . . .	234

Loss of Heat in Working Substance . . . . .	235
Efficiency of Steam Boilers . . . . .	236
Equivalent Evaporation . . . . .	237
Heating of Air Supply to Furnaces . . . . .	238

## CHAPTER XV

## HEAT BALANCES, FURNACE AND BOILER TESTS

Data Necessary for Steam Boiler Test . . . . .	240
Example of Test on Babcock and Wilcox Boiler . . . . .	241
Heat at Low Temperatures . . . . .	246
Choice of Fuel for Industrial Operations . . . . .	247
Purchase of Coal . . . . .	249

## CHAPTER XVI

## LIQUID FUELS

Uses of Liquid Fuels . . . . .	252
Advantages and Disadvantages of Liquid Fuels . . . . .	252
Petroleum . . . . .	253
Composition and Calorific Powers of Liquid Fuels . . . . .	254
Shale Oil . . . . .	254
Masut . . . . .	255
Methods of Burning Liquid Fuels . . . . .	255
Comparison of Cost of Liquid Fuel and Coal . . . . .	257

## APPENDIX I

List of Books Suitable for Further Reading . . . . .	259
--	-----

## APPENDIX II

Comparison of Different Forms of Energy . . . . .	261
---	-----

## APPENDIX III

True and Mean Specific Heats . . . . .	262
--	-----

## APPENDIX IV

Furnace Control . . . . .	264
---------------------------	-----

## APPENDIX V

Table for Converting Weights and Measures . . . . .	265
---	-----

ALPHABETICAL INDEX . . . . .	267
------------------------------	-----



## LIST OF ILLUSTRATIONS

FIGURE	PAGE
Taking Temperature of a Gas Retort with a Féry Radiation Pyrometer. <span style="float: right;"><i>Montisfiece</i></span>	
1. Apparatus for Estimation of Carbon and Hydrogen in a Fuel	32
2. Apparatus for Estimation of Nitrogen by Combustion	34
3. Hempel Gas Burette and Pipette	35
4. Hempel Pipette for Liquid Reagents	36
5. Hempel Pipette for Solid Reagents	37
6. Aspirator for Sampling Flue Gases	38
7. Stead's Gas Sampler	39
8. Hempel Explosion Pipette	45
9. Orsat Gas Analysis Apparatus	48
10. Lewis Thompson's Calorimeter	56
11. William Thomson's Calorimeter	59
12. Rosenhain Calorimeter	61
13. F. Fischer's Calorimeter	63
14. Bomb Calorimeter, Section	64
15. Bomb Calorimeter Outfit	65
16. S. W. Parr's Calorimeter	71
17. "Patrono" Parr's Calorimeter	71
18. Junker Calorimeter	75
19. Boys' Calorimeter	77
20. Constant Pressure Air Thermometer; Constant Volume Air or Gas Thermometer	85
21. Wiborgh's Technical Form of Gas Thermometer	86
22. Thermo-electric Pyrometer	88
23. Millivoltmeter, Fixed Form	88
24. Millivoltmeter, Portable Form	88
25. "Thread Recorder"	89
26. "Thread Recorder." Recording Mechanism	90
27. Record of the Temperature of a Pottery "Biscuit" Kiln, obtained with a Féry Radiation Pyrometer and Patent Thread Recorder	90
28. Resistance Pyrometer	91
29. "Whipple Patent Temperature Indicator"	92
30. Callendar Recorder	94
31. Féry Radiation Pyrometer	96
32. Féry Radiation Pyrometer	96
33. Féry Radiation Pyrometer, Fixed in Position	97

FIGURE	PAGE
34. Féry Radiation Pyrometer, for taking Temperature of Pottery Kiln . . . . .	98
35. Sighting a Féry Radiation Pyrometer . . . . .	99
36. Féry Absorption Pyrometer . . . . .	102
37. Féry Absorption Pyrometer . . . . .	102
38. Wanner Pyrometer . . . . .	104
39. Holborn and Kurlbaum Pyrometer . . . . .	105
40. Fischer's Pyrometer . . . . .	107
41. Test Vessel . . . . .	112
42. Hypsometer . . . . .	112
43. Vessel for Boiling Sulphur . . . . .	113
44. Stall for Coke Making . . . . .	146
45. "Beehive" Coke Oven . . . . .	147
46. Beehive Coke Oven, Modified for Recovery of Bye-products . . . . .	148
47. Huessener Coke Oven, Section through Flues . . . . .	149
48. Huessener Coke Oven, Section through Oven . . . . .	150
49. Huessener Coke Oven . . . . .	152
50. Efficiency of Water Gas Producer . . . . .	175
51. Siemens' Producer . . . . .	179 <sup>c</sup>
52. Hopper on Producer . . . . .	180
53. Wilson Producer . . . . .	181
54. Water Gas Producer . . . . .	184
55. Suction Gas Producer . . . . .	186
56. P. V. Diagram . . . . .	189
57. Diagram showing Heat Losses in an Explosion Motor . . . . .	210
58. Diagram showing Heat Losses in an Explosion Motor . . . . .	211
59. Seger's Differential Manometer . . . . .	225
60. Fletcher's Anemometer . . . . .	226
61. Allday's Empire Oil Burner . . . . .	256

# AN INTRODUCTION TO THE STUDY OF FUEL

## CHAPTER I

### GENERAL CHEMICAL PRINCIPLES

THE phenomenon of combustion is one of the most frequent chemical reactions which takes place, and was one of the earliest to be investigated. The correct understanding of this phenomenon led to the foundation of modern chemistry.

Before proceeding with the systematic study of fuel, it is necessary to outline briefly some of the more important chemical and physico-chemical laws which are applied and used in the later chapters.

Combustion is the term usually applied to the combination of an element with oxygen, the combination being accompanied by the evolution of heat and light. In its widest sense, however, the term may be applied to many reactions which take place between two or more elements with the evolution of heat and light, and it is not necessary that one of the reacting elements should be oxygen. For example, hydrogen will burn in chlorine with a moderately bright flame, forming hydrochloric acid—

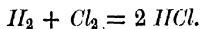

Many metals, such as antimony, copper, etc., will burn in chlorine, forming the respective chlorides.

In the following pages the term combustion is used in its restricted sense to denote the union of certain elements and compounds with oxygen. When the combination takes place with great rapidity and is accompanied by light and noise, it is spoken of as *explosion*. The slow process of decay is equally

## 2 AN INTRODUCTION TO THE STUDY OF FUEL

a case of combustion, differing only in the velocity with which the combination with oxygen occurs, the combination taking place with great rapidity in the one case, and with such slowness in the other that the heat is radiated away almost as fast as it is evolved, and does not make its presence visible as flame.

It is assumed that the reader is familiar with ordinary elementary chemical theory, such as the meaning of chemical symbols and equations, both qualitatively and quantitatively expressed; and only the more important points for the subject under consideration will be treated here. The illustrations and examples will, so far as possible, be selected from the point of view of the present subject, viz., fuel.

### (1) *The Weight and Volume of Reacting Substances.*

A chemical equation denotes not only the substances which react together, but also their weights, and in the case of gases their volumes. The units of weight and volume most convenient are the gram and litre respectively, and these units and their multiples will be used. They can readily be converted into pounds, gallons, or cubic feet, by multiplying by a factor (see Appendix). The unit of weight of a substance participating in a chemical reaction is the *gram molecule*, that is, the molecular weight of the substance expressed in grams. For example, the gram molecule of hydrogen is  $H_2 = 2$  grams, carbon dioxide  $CO_2 = 44$  grams, oxygen  $O_2 = 32$  grams, etc., and in the case of solid substances like carbon, where the number of atoms in the molecule is not known, the gram atom may be used,  $C = 12$  grams, in the case of carbon. The unit of volume in the case of gases is the volume occupied by one molecule. The molecular weight of any gas expressed in grams occupies 22.32 litres (or 22.4 litres in round numbers). Thus  $O_2 = 32$  grams = 22.4 litres,  $H_2 = 2$  grams = 22.4 litres,  $CO_2 = 44$  grams = 22.4 litres,  $CO = 28$  grams = 22.4 litres, all the gases being measured at a definite temperature and pressure, viz.,  $0^\circ$  C. and 760 mm. The weight and volume of the substances taking part in certain chemical reactions will now be calculated, so as to make the preceding paragraph clearer. Consider the combustion of carbon in air.

Air can be represented by  $(O_2 + 4 N_2)$ ; this gives the proportion of oxygen and nitrogen as 20.0 per cent. and 80.0 per cent. by volume respectively, whereas the correct figures are 20.8 per cent. and 79.2 per cent., but owing to the great simplification of calculations by this method, the slight error is unimportant for the present purpose. The combustion of carbon to form carbon dioxide is then represented by

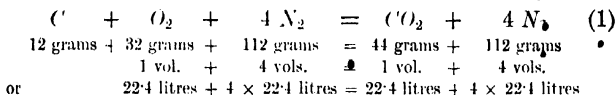

all measured at normal temperature and pressure (N.T.P.) = 0° C. and 760 mm. From this it follows that when carbon is burnt with the theoretical quantity of air, the products consist of

20 per cent. carbon dioxide.  
80 „ „ nitrogen.

A more complicated case is the combustion of a hydrocarbon-like marsh gas with the necessary amount of air.

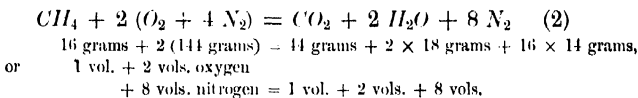

If the measurements are made at N.T.P. the water condenses and hence occupies no volume, or rather the volume occupied by the liquid is so small compared with the gas that it can be neglected. The composition of the products would then be one volume of carbon dioxide and eight volumes of nitrogen, or

Carbon dioxide	.	.	.	.	11.1 %
Nitrogen	.	.	.	.	88.9 %
					100.0
					100.0

From equation (1) it is evident that 12 grams of carbon require 144 grams of air for its complete combustion and form 156 grams of products. The products occupy 112 litres at N.T.P.

It frequently happens that gases cannot be measured at

#### 4 AN INTRODUCTION TO THE STUDY OF FULL

N.T.P., but the volume observed must be corrected for temperature and pressure.

(2) *The Correction of a Gas for Pressure and Temperature.*

(a) The relationship of the volume of a given mass of gas to the pressure is expressed by Boyle's law, which can be stated thus:—

“The volume of a given mass of any gas varies inversely as the pressure upon it if the temperature of the gas remains constant.”

If the volume of a given mass of gas is  $v_0$  at a pressure  $p_0$ , the volume at any other pressure  $P_1$  is given by the equation

$$\frac{p_0 v_0}{P_1} = V_1$$

The variation of the volume of any gas with the temperature is expressed in Gay-Lussac's law.

(b) “The volume of a given mass of gas varies directly as the absolute temperature of the gas if the pressure upon it remains constant”; and

(c) The pressure of a given mass of any gas varies directly as the absolute temperature if the volume remains constant.

These three laws can be combined together into the form of a single equation as follows. Let the temperature, pressure, and volume of a certain mass of gas all change, and let the original values be  $p_0$ ,  $v_0$ ,  $T_0$ , and the final values  $p_1$ ,  $v_1$ ,  $T_1$ . Suppose that the volume remains constant at  $v_0$  and the temperature of the gas reaches its final value  $T_1$ , the pressure will then be  $P$ , so that

$$\frac{p_0}{P} = \frac{T_0}{T_1} \quad (1)$$

Now let the gas expand from  $v_0$  to  $v_1$  at constant temperature  $T_1$ , then the pressure is given by the equation

$$Pv_0 = p_1 v_1$$

hence 
$$P = \frac{p_1 v_1}{v_0} \quad (2)$$

Substituting this value for  $P$  in equation (1) the expression

$$\frac{p_0 v_0}{p_1 v_1} = \frac{T_0}{T_1} \quad (3)$$

is obtained. This equation can be stated thus: The product of the pressure and volume of a gas is proportional to the absolute temperature.

Equation (3) may be written thus:—

$$\frac{p_0 v_0}{T_0} = \frac{p_1 v_1}{T_1} \quad (4)$$

or the expression  $\frac{p \cdot v}{T}$  for a given quantity of gas is always constant.

By Avogadro's law the gram molecular weight of all gases occupy the same volume under the same conditions of temperature and pressure; hence it follows that for this volume of any gas the expression will have a constant value, *i.e.*,

$$\frac{P \cdot V}{T} = \text{constant} = R \quad (5)$$

The value for  $R$  can be calculated thus: The volume occupied by one gram molecule of any gas is 22.32 litres at 0° C. and 760 m.m. pressure. The pressure of a column of mercury 76 c.m. high and 1 sq. c.m. cross section is the weight of 76 × 1 c.c. of mercury. The specific gravity of mercury is 13.59, and hence the weight of 76 c.c. is 76 × 13.59 = 1,033 grams, and the pressure is 76 × 13.59 = 1033 grams per square centimetre.

The absolute temperature is  $T = 273^\circ$ .

Substituting these values in equation (5)

$$R = \frac{1,033 \times 22,320}{273} = 84,456 \text{ gram centimetres}$$

is obtained; if this is divided by the mechanical equivalent of heat expressed in the same units, a value for  $R$  is obtained in calories, which will be used in subsequent calculations

$$R = \frac{1,033 \times 22,320}{273 \times 42,350} = \frac{84,456}{42,350} = 1.98,$$

or in round numbers

$$R = 2 \text{ gram calories,}$$

hence the equation may be written

$$P \cdot V = 2 T$$

when thermal units are employed. (See Appendix for values of  $R$  in other units.)

## • 6 AN INTRODUCTION TO THE STUDY OF FUEL

Equation (4) may be used for calculating the volume which a gas will occupy at N.T.P., when the volume has been measured at  $t^{\circ}$  C. and a pressure  $p_1$ , then since  $p_0 = 760$   $T_0 = 273$   $T_1 = (273 + t)$ , equation (4) becomes

$$\frac{760 \times v_0}{273} = \frac{p_1 v_1}{(273 + t)}$$

hence 
$$v_0 = \frac{p_1 v_1}{760} \cdot \frac{273}{(273 + t)}$$

and in this form it is in general use for correcting the volumes of gases for temperature and pressure.

### (3) *Reversible Reactions and Balanced Actions.*

There are a number of reactions known which under one set of conditions proceed in one direction and under another set of conditions proceed in the opposite direction. For example, if hydrogen be passed over red hot magnetic oxide of iron,  $Fe_3O_4$ , it is reduced to metallic iron and the hydrogen is oxidised to water:—



and if steam be passed over red-hot iron, the water vapour is decomposed, the iron oxidised to magnetic oxide and the hydrogen liberated:—



It is evident that the second reaction is the reverse of the first, and reactions of this type are known as "*reversible reactions*," and are usually written thus:—

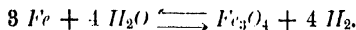

The two arrows pointing in opposite directions are used to indicate that the reaction can proceed in either direction. Now this reaction can be used for two different purposes, viz., (1) to prepare a small quantity of iron by the reduction of the oxide, and in this case hydrogen gas is passed over the heated oxide of iron; or (2) it may be employed as a method of preparing hydrogen gas, and in this case steam is passed over the red-hot iron. If the reaction is desired to proceed in the sense

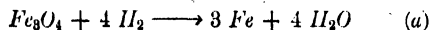



the current of hydrogen is so regulated that the water formed is carried away from the iron, or the water vapour condensed as rapidly as formed, so preventing the reverse reaction from taking place. On the other hand, if the reaction is to proceed in the sense

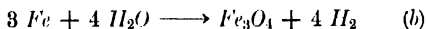

the steam must be sufficient in quantity to remove the hydrogen liberated and prevent the occurrence of the reaction (a).

The question now arises as to what will happen if all four substances, water vapour, red-hot iron, iron oxide, and hydrogen, are allowed to remain in contact with each other. This can be answered by considering an imaginary way of carrying out the experiment. Suppose that, on the one hand, iron oxide,  $Fe_3O_4$  and hydrogen are contained in a gas-tight box and heated for a considerable time to a constant temperature  $t_1$ , until no more interaction takes place. At the end of the heating it will be found that the four substances,  $Fe$ ,  $Fe_3O_4$ ,  $H_2$  and  $H_2O$  are present in the resulting mixture in certain definite proportions. If, on the other hand, iron and water vapour are enclosed in the box and heated to the same temperature  $t_1$  until no further reaction takes place, then at the end of the heating all four substances  $Fe$ ,  $Fe_3O_4$ ,  $H_2$  and  $H_2O$  will be found in the mixture, and the proportions of each will be in the same ratio as in the previous case. This means that the reaction

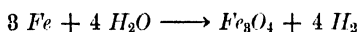

proceeds until a certain amount of iron oxide and hydrogen are formed and then stops, and that similarly the reverse reaction

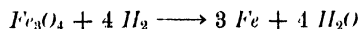

proceeds until a certain amount of metallic iron and water vapour are produced and then the reaction ceases. Expressed in other words, a condition of chemical equilibrium is established, and hence for each temperature the quantity of each of the four substances in equilibrium is constant. If  $C_1$ ,  $C_2$ ,  $C_3$ ,  $C_4$  are the quantities of water, iron, hydrogen and iron oxide in equilibrium in the reaction

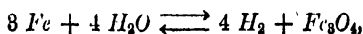

## 8 AN INTRODUCTION TO THE STUDY OF FUEL

then the expression,

$$\frac{C_1^4 \times C_2^3}{C_3^4 \times C_4} = K = \text{constant}$$

for each given temperature, and this has been proved to hold by a number of experiments. Since  $C_2$  and  $C_4$  refer to solid substances, which undergo very small change in concentration compared with gaseous substances, the above equation may be converted into

$$\frac{C_1^4}{C_3^4} = K_1 \quad \text{or} \quad \frac{C_1}{C_3} = K_2,$$

neglecting the terms referring to the solids. This last equation shows that at each given temperature the ratio of the concentrations of the water vapour and hydrogen in equilibrium with iron oxide and metallic iron is constant. The above can be put into the form of a general equation. Let the number of molecules  $n_1, n_2 \dots$  of the substances  $A_1, A_2 \dots$  react together and form  $p_1, p_2 \dots$  molecules of  $B_1, B_2 \dots$ . At equilibrium let each have the concentration  $a_1, a_2, p_1$  and  $p_2$  respectively,

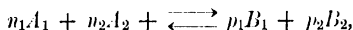

and hence

$$\frac{a_1^{n_1} \times a_2^{n_2}}{b_1^{p_1} \times b_2^{p_2}} = K.$$

The constant  $K$  is called the equilibrium constant, and the above equation is fundamental in all cases where chemical equilibrium is dealt with. Examples of equilibrium are very numerous, and it is now customary to view all reactions as reversible, although in many cases the reactions have proceeded almost, but not quite, completely in one direction. The theory of equilibrium is of great importance in the theory of the gas and water gas production, in high temperature combustion, and explosion combustion. Chemical equilibrium is influenced by temperature, pressure, and concentration of the reacting substances, and Le Chatelier has given a principle, or theorem, which indicates the effect of varying one or more of these factors, and can be stated thus: "Every change of one of the factors of equilibrium occasions such a change within the system as tends

to compensate the first change." This can be made clear by the following considerations. Let a chemical system consisting of  $n_1$  molecules of  $A$  and  $n_2$  molecules of  $B$  be in equilibrium with  $p_1$  molecules of  $C$

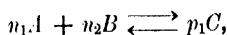

and let the reaction proceed from left to right with absorption of heat and with decrease of volume, then any change in the factors of equilibrium will produce effects which can be predicted by aid of the above theorem. For example, a rise of temperature, at constant volume, favours a change which will tend to lower the temperature, *i.e.*, favours the change which *absorbs* heat, hence the above reaction would proceed in the sense of the equation from left to right. Conversely a fall of temperature at constant volume would favour the reverse reaction. Similarly an increase of pressure, at constant temperature, favours the changes which take place with a diminution of volume, *i.e.*, which tend to reduce the pressure. The converse also holds. Finally, any increase of concentration of any of the substances present in the system, at constant temperature and pressure, produces such a change in the equilibrium conditions that as a result the concentration of this substance tends to decrease. In the above general reaction if, for example, the quantity of  $C$  is increased by some means, then the reaction will tend to go from right to left, some of  $C$  disappearing in the process. The concentration of the various substances present is most conveniently expressed in gram molecules for solids and in partial pressures or fractions of unit volume in case of gases. The number of gram molecules is found by dividing the weight of the substance in grams,  $g$ , by the molecular weight,  $M$ .

$$n = \frac{g}{M}.$$

On the other hand, if a gas has the composition

$CO$	= 33.0 %	by volume
$CO_2$	= 40.0 %	,,
$N_2$	= 27.0 %	,,
	<hr style="width: 100%; border: 0.5px solid black;"/>	
	100.0	
	<hr style="width: 100%; border: 0.5px solid black;"/>	

## 10 AN INTRODUCTION TO THE STUDY OF FUEL

at a pressure of one atmosphere, the composition may be expressed as

	Fraction of Unit Volume.	...	Partial Pressure in Atmospheres.
$CO$	$= 0.33$ volume.	...	$0.33$ atmosphere.
$CO_2$	$= 0.40$ „	...	$0.40$ „
$N_2$	$= 0.27$ „	...	$0.27$ „
	<u><math>1.00</math></u> „	...	<u><math>1.00</math></u> „

If the pressure is not 1 atmosphere, but  $p$  atmosphere, then the partial pressure of each of the constituents can be readily found by multiplying each by  $p$ , thus

$$\begin{aligned} \text{Total pressure } p &= p_{co} + p_{co_2} + p_{n_2} \\ p &= 0.33 p + 0.40 p + 0.27 p. \end{aligned}$$

This is based upon Dalton's law, that the total pressure of a gas is equal to the sum of the partial pressures of its constituents. The pressure of the atmosphere upon any given occasion is due to the partial pressure of the oxygen, plus the partial pressure of the nitrogen, and the partial pressures are directly proportional to the quantity of each present, *i.e.*, to the percentage volume of each constituent. So, for example, when the column of mercury in a barometer is 760 mm. high, the partial pressure of the oxygen is  $760 \times 0.21 = 159.6$  mm., and the nitrogen  $760 \times 0.79 = 600.4$  mm.

### (4) Reaction Velocity and Catalysis.

Chemical reactions exhibit striking differences in the *time* which they require for their completion. On the one hand there is the explosion of a mixture of hydrogen and oxygen, or carbon monoxide and oxygen, which is complete, practically instantaneous, while on the other hand the combination of carbon and oxygen to form carbon dioxide requires a considerable length of time for its completion.

The term "reaction velocity" means the ratio of the quantity of substance changed to the time required for that change. Thus the quantity of carbon converted into carbon dioxide, per hour or per day, can be used as a measure of the velocity of the reaction

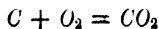

at a definite temperature and pressure. The velocity of many reactions has been measured, and the experimental methods employed for the measurements are very different, but these methods cannot be described here. It may be pointed out, however, that when a reaction takes place with a change of volume, the progress of the reaction can conveniently be followed by observing the change of pressure at definite intervals of time. Examples of reactions which can be followed in this way are the decomposition of carbon monoxide into carbon and carbon dioxide,

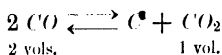

the reaction taking place with a decrease of volume, and therefore the rate of decrease of pressure can be used as a measure of the velocity of the reaction, and the dissociation of substances like peroxide of nitrogen  $\text{N}_2\text{O}_4$  and carbonates like calcium carbonate  $\text{CaCO}_3$

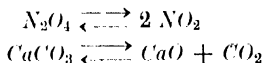

can be followed by the changes in pressure which occur as the reaction proceeds.

The velocities of reactions can be increased by two different methods, viz., rise of temperature and by a catalyst. All oxidisable substances undergo oxidation at all temperatures, but with very different velocities. The coal stored in a cellar undergoes oxidation just as surely as the coal which is burning in a furnace, and in some cases, where the conditions are such that the radiation of the heat evolved is prevented, the temperature rises, the velocity of oxidation is accelerated, and rapid combustion of the coal ensues. This is known as the spontaneous ignition of the coal. Again, by lowering the temperature the reaction velocity of all reactions can be reduced, and finally at absolute zero  $-273^\circ \text{C.}$ —all reaction is believed to cease. As a striking illustration of the effect of temperature upon the velocity of reaction, the combination of hydrogen and oxygen to form water will be considered. A mixture of hydrogen and oxygen in the proportions indicated by the equation



## 12 AN INTRODUCTION TO THE STUDY OF FUEL

were enclosed in a suitable vessel heated to different temperatures, and the following results were obtained:—

At 2:0° C. practically no combination, even after several months.

At 300° C. water was slowly formed, and after several weeks the containing vessel showed a deposit of dew when cooled.

At 450° C. the reaction proceeded more rapidly, a few days being sufficient, but the reaction was still incomplete.

At 600° C. ignition took place, and the reaction was complete in a few seconds.

At 2,000° C. the reaction was complete in less than  $1 \times 10^{-6}$  second.

A second method of increasing the velocity of reaction is by means of a catalyst or catalytic agent. The phenomenon is known as catalysis. A catalyst or catalytic agent increases the speed of a reaction without itself undergoing any permanent change. For example, hydrogen and oxygen may be kept in admixture, at room temperature, for an indefinite period without any combination taking place, but if a small quantity of spongy platinum (made by igniting ammonium chloro-platinate  $(NH_4)_2(PlCl_6)$ ) is introduced into the vessel containing the mixture, combination takes place rapidly and the progress of the combination can be followed by the diminution of volume. In some cases the platinum becomes so hot that the mixture is ignited and explosion takes place. Advantage has been taken of this property of platinum and also of palladium, and gas lighters have been constructed in which the gas and air impinging upon the platinum (or palladium), which becomes red- and then white-hot, is ignited. Many metals behave similarly, but as a rule they have to be at a higher temperature before they act as catalysts in the above reaction. Another example of catalysis is the decomposition of carbon monoxide into carbon and carbon dioxide,

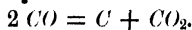

This reaction is accelerated by both nickel and iron, especially the former, when in a finely-divided state. Further, traces of water accelerate many reactions; for example, perfectly dry carbon, sulphur, and phosphorus will not burn in perfectly dry

oxygen, even when strongly heated, but when the slightest trace of moisture is introduced the combustion proceeds rapidly. Catalysts or catalysers can be defined as substances which accelerate the velocity of reactions that otherwise proceed slowly, the catalyst undergoing no permanent change. The catalyst does *not* make a reaction take place which would not otherwise occur, but only increases the velocity of a reaction which, in the absence of a catalyst, takes place with extreme slowness. Ostwald pictures the action of a catalyst in the following way: Imagine a wheel whose axis is rotating with great friction in consequence of the thick oil on the bearings, and hence is only revolving slowly. If fresh oil is introduced on to the bearings they begin to run more freely, although the driving power is not increased by the presence of the new oil. The action of the oil is comparable to that of the catalyst in so far as the oil is not used up in its working.

It will be seen later (Chapter III.) that every combustion process yields a finite quantity of heat. If this heat does nothing else than heat up the products of combustion, it will raise their temperature to certain degree which can be calculated (see p. 116 and f.). This temperature is known as the maximum combustion temperature, and is purely a theoretical temperature which is never attained in actual practice. The reason for this is that the heat evolved in the combustion has to heat up the surroundings in addition to the products of combustion. Thus, when coal or coke is burnt in a furnace, a certain amount of the heat is absorbed by the furnace walls and other furnace parts, a portion is radiated away, and another portion used for heating the excess of air, which is always necessary, it being not possible to ensure complete combustion when the theoretical quantity of air is used. The actual temperature is therefore always lower than the theoretical temperature. By increasing the velocity of combustion, by means of a forced or induced draught, the temperature of the fire is raised, since the production of heat by the combustion is faster than the loss of heat by the above causes. The action of the forced draught is that it raises the temperature by increasing the velocity of combustion and thus increases the quantity of fuel which can be burnt in a furnace in

## 14 AN INTRODUCTION TO THE STUDY OF FUEL

a given time. Certain attempts have been made to introduce "fuel economisers," which are really combustion catalysts. Their use is, however, by no means general, nor is their method of action certain. It is probable that they act by lowering the ignition temperature, and the following is a simple experiment which tends to support this view: A piece of lump sugar is broken in two so as to obtain two pieces as similar in composition as possible. One is introduced into the flame of a candle or paper and the time required for it to ignite is observed; the other portion is first touched with a trace of tobacco ash and then introduced into the flame, care being taken to keep about the same amount of sugar in the flame in each case, and the time for ignition again observed. The second time will be found to be very much less than the first, and the burning, when once started, proceeds more rapidly than in the first case. It is difficult to make the above experiment quantitative, but as a qualitative demonstration it is striking, and illustrates the reality of a combustion catalyst.

### (5) *Dissociation.*

A class of reactions which require mention here are those in which a single molecule is decomposed into two or more constituents, usually by the influence of heat, recombination taking place when the system is cooled down. Such reactions are termed dissociation, and they do not differ fundamentally from other balanced or reversible reactions, the laws which govern the one apply also to the other. Some typical cases of dissociation are:—

(a) The dissociation of water vapour;

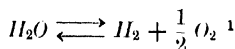

b) The dissociation of carbon dioxide,

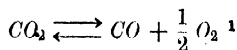

(c) The dissociation of nitrogen peroxide,

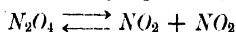

The expression " $\frac{1}{2} O_2$ " is frequently used to avoid doubling the expression throughout.



(d) The dissociation of calcium carbonate,

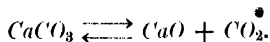

These reactions take place in the sense of the equation from left to right with rise of temperature and in the reverse direction with fall of temperature. In the case of water vapour and carbon dioxide the dissociation is only measurable at high temperatures and in the case of nitrogen peroxide the dissociation is complete at about 140° C. The experimental measurement of dissociation is frequently a matter of great difficulty, especially when the amount of dissociation is small, as in the case of water vapour and carbon dioxide. When the dissociation is accompanied by a large change of volume as in the dissociation of nitric peroxide and calcium carbonate,

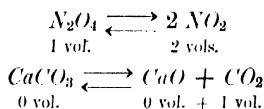

the dissociation can be measured by the change of pressure, the pressure being measured by a mercury gauge similar to a barometer.

In the case of solid substances which dissociate into a gaseous product, *e.g.*,  $CaCO_3$ , it follows that for every temperature there will be a definite pressure of the gas in equilibrium with the solid. This pressure is called the "dissociation pressure," and is characteristic for each solid substance at each temperature. Again, nitrogen peroxide decreases in density as dissociation progresses:—

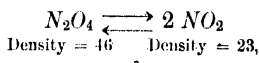

and here the dissociation can be followed by determining the density of the gas at different temperatures.

The degree of dissociation or the fraction of a gram molecule which is dissociated into the simpler bodies can readily be calculated. As an example the dissociation of nitrogen peroxide will be used.

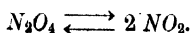

## 16 AN INTRODUCTION TO THE STUDY OF FUEL

Let one molecule of  $N_2O_4$  be present at the start, and at a certain temperature  $t^\circ C.$  let the fraction  $x$  of one gram molecule be dissociated. The undissociated fraction will be  $(1 - x)$  gram molecule, and the gas will now consist of

$$\begin{array}{rcl} N_2O_4 & (1 - x) & \text{gram molecule.} \\ NO_2 & 2x & \text{,, ,,} \\ \text{Total} & (1 + x) & \text{,, ,,} \end{array}$$

Let the density which is measured at  $t^\circ C.$  be  $D$ . The densities of  $N_2O_4$  and  $NO_2$  are 46 and 23 respectively. (The density of gases, compared with hydrogen, is one-half their molecular weights.) The ratio of the number of molecules at temperature  $t^\circ C.$ , to that initially present,  $\frac{1}{1+x}$  is the same as the ratio of the density of the dissociated gas to that of the gas when no dissociation has taken place, hence

$$\frac{1}{1+x} = \frac{D}{46}$$

and therefore

$$x = \frac{46 - D}{D}$$

This gives  $x$  as the fraction of one gram molecule which is dissociated into simpler bodies, and when multiplied by 100 it gives the percentage dissociation. Thus at  $60^\circ C.$  the density of the gas is 30, the percentage dissociation is therefore

$$x = \frac{46 - 30}{30} \times 100,$$

and

$$x = 53 \%$$

The gas, therefore, consists of a mixture of  $N_2O_4$  and  $NO_2$  in the proportions

$$\begin{array}{rcl} N_2O_4 & . & . & . & 47 \% \\ NO_2 & . & . & . & 53 \% \\ & & & & \hline & & & & 100 \end{array}$$

In most of the cases considered in the following pages dissociation of the products of combustion can be neglected. It is of

importance in the theory of explosion and explosion engines, and a knowledge of the degree of dissociation of

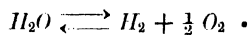

and

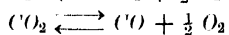

is necessary in order to calculate the maximum work which can theoretically be done by the above reactions when they are carried out in an explosion engine.

## CHAPTER II

### WEIGHT AND VOLUME OF AIR REQUIRED FOR COMBUSTION

PRACTICALLY all the energy utilised in the various industrial processes is gained by the combustion of fuel. The phenomenon of combustion is one of the most important to engineers and chemists alike, since, from a study of it, the earlier chemical investigators were able to deduce the nature of the changes involved and the composition of the products, and the engineers were able to utilise the energy liberated when these changes took place, and so to transform the chemical energy into mechanical, electrical, or other useful form.

There are certain combustible bodies which occur in nature in such large quantities as to render their use possible on a commercial scale as a means of converting chemical energy into some useful form of energy by means of combustion. Such substances are called fuels, and consist chiefly of carbon or compounds of carbon and hydrogen, and they may be either solid, liquid or gaseous.

By far the greater proportion of fuel utilised in industry is solid fuel, in the form of coal or coke. When carbon burns in air it combines with the oxygen of the air, producing carbon dioxide, a gas, and giving out a certain amount of energy in the form of heat.

This can be expressed in the form of an equation

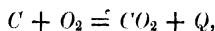

where  $Q$  is the so-called heat of reaction, which can be measured in a calorimeter of suitable design. Calorimeters will be discussed in a later chapter. It will be seen that this quantity of heat,  $Q$ , is definite for each combustible substance, with either element or compound, and when expressed in suitable units forms a useful aid to the valuation of a given fuel.

When coal, for example, is burnt in a suitable grate or furnace

## WEIGHT AND VOLUME OF AIR FOR COMBUSTION 19

with a sufficient supply of air, the products of combustion are carbon dioxide and water vapour which pass up the flue, together with the atmospheric nitrogen and a small quantity of nitrogen from the fuel. The heat which is generated by the chemical reactions is absorbed by the surrounding objects or is lost by radiation. Each furnace or grate is designed so as to gain the maximum quantity of this heat in a form available either for heating a metal smelting furnace, or for steam raising, or for some other useful purpose.

It has been already pointed out that fuels contain carbon and hydrogen as combustible constituents. Most solid fuels, such as wood, coal and coke contain also a certain quantity of mineral matter, which is left behind after combustion in the form of ash. The quantity of the ash must be taken into account when valuing a fuel for its heating effect. At present, however, for the sake of simplicity, a fuel consisting of hydrogen and carbon alone will be considered. When such a fuel is burned in a grate the products of combustion, carbon dioxide, water vapour, and nitrogen pass along the flues on their way to the chimney. In practice it is difficult to regulate the air supply so that complete combustion ensues and no excess air accompanies the products of combustion on the way to the chimney; hence a certain quantity of unused air is almost invariably found when chimney gases are analysed. If the chemical composition of the fuel is known the theoretical quantity of air necessary for its complete combustion can be calculated. The average composition of dry air free from carbon dioxide is—

Oxygen	. . .	21 % by volume	23 % by weight.
Nitrogen	. . .	79 % „	77 % „

### WEIGHT OF AIR REQUIRED FOR COMBUSTION.

To burn carbon to carbon dioxide, the oxygen required is—

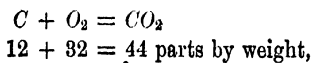

hence 1 part by weight of carbon requires 2.67 parts by weight of oxygen, and yields 3.67 parts by weight of carbon dioxide.

## 20 AN INTRODUCTION TO THE STUDY OF FUEL

Air contains 23 per cent. by weight of oxygen, therefore the weight of air containing 2.67 parts by weight of oxygen is

$$2.67 \times 100/23 = 11.61 \text{ parts.}$$

The products of combustion will consist, therefore, of 3.67 parts by weight of carbon dioxide and 8.94 of nitrogen.

If the unit of weight chosen be 1 lb., then 1 lb. of carbon requires 2.67 lbs. of oxygen, or 11.61 lbs. of air for complete combustion, and yields 12.61 lbs. of products, containing 3.67 lbs. of carbon dioxide and 8.94 lbs. of nitrogen.

The weight of air required to burn 1 part by weight of hydrogen may be calculated in a similar way—

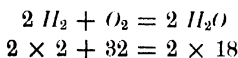

$$\therefore 1 + 8 = 9 \text{ parts by weight.}$$

The air containing 8 parts by weight of oxygen is,

$$8 \times 100/23 = 34.78 \text{ by weight,}$$

and the yield is 35.78 parts by weight of water and nitrogen in the proportion of 9 of water, 26.78 of nitrogen.

### VOLUME OF AIR REQUIRED FOR COMBUSTION.

One gram of carbon requires 1.86 litres of oxygen for complete combustion, and 1.86 litres of oxygen is contained in

$$1.86 \times 100/21 = 8.86 \text{ litres of air,}$$

and the volume of products will be 8.86 litres, consisting of 1.86 litres of carbon dioxide and 7 litres of nitrogen.

Taking the pound and cubic foot as the unit of weight and volume respectively, then 1 lb. of carbon requires  $454.5 \times 1.86$  litres of oxygen (1 lb. avoirdupois = 454.5 grams) = 845.5 litres (or since 1 litre = 0.035 cubic foot) = 29.6 cubic feet, and the volume of the product will be 29.6 cubic feet of carbon dioxide.

The volume of air will be

$$29.6 \times 100/21 = 141 \text{ cubic feet.}$$

Again, hydrogen requires 5.58 litres of oxygen per gram, or  $5.58 \times 454.5 = 2,536$  litres, or  $2,536 \times 0.035 = 88.78$  cubic feet of oxygen per pound of hydrogen.

## WEIGHT AND VOLUME OF AIR FOR COMBUSTION 21.

The volume of water formed is 177.56 cubic feet, assuming the water to remain in the gaseous state.

The volume of air required per pound of hydrogen is

$$88.78 \times 100/21 = 422.8 \text{ cubic feet.}$$

The volume of products will be as follows:—

1 lb. of carbon will yield 141 cubic feet, consisting of 29.6 cubic feet of carbon dioxide and 111.4 cubic feet of nitrogen.

1 lb. of hydrogen will produce 511.6 cubic feet, consisting of 177.6 cubic feet of water (in form of steam) and 334 cubic feet of nitrogen.

The volume of air, and oxygen and products (except the water)<sup>1</sup> are calculated at 0° C. and 760 mm. (32° F. and 29.92 inches). At other temperatures the volumes can be calculated in the usual way.

In the case of a fuel containing  $x$  per cent. of carbon and  $y$  per cent. of hydrogen, the weight and volume of air required for the complete combustion of 1 lb. of the fuel, and also the weight and volume of the products, can readily be calculated.

$$\begin{aligned} \text{Air required to burn } \frac{x}{100} \text{ lb. of carbon} \\ = \frac{x}{100} \times 11.61 \text{ lbs., or } \frac{x}{100} \times 29.6 \text{ cubic feet.} \end{aligned}$$

$$\begin{aligned} \text{Air required to burn } \frac{y}{100} \text{ lbs. of hydrogen} \\ = \frac{y}{100} \times 34.78 \text{ lbs., or } \frac{y}{100} \times 88.78 \text{ cubic feet.} \end{aligned}$$

∴ Total volume of air required is the sum of these

$$= \frac{x}{100} \times 29.6 + \frac{y}{100} \times 88.78 \text{ cubic feet.}$$

Total weight of air required

$$= \frac{1}{100} (11.61 x + 34.78 y) \text{ lbs.}$$

<sup>1</sup> The water is assumed to be in the form of vapour, and the volume it would occupy at 0° C. and 760 mm., if it could exist as a gas at that temperature, is calculated.

## 22 AN INTRODUCTION TO THE STUDY OF FUEL

The weight of carbon dioxide produced is

$$\frac{x}{100} \cdot 3.67 \text{ lbs.},$$

and the weight of carbon dioxide and nitrogen is

$$\frac{x}{100} \times 11.61 \text{ lbs.}$$

The weight of water produced is

$$\frac{y}{100} \times 9 \text{ lbs.}$$

The weight of water and nitrogen is

$$\frac{y}{100} \times 35.78 \text{ lbs.}$$

The more complex cases can be calculated by aid of these figures, and an example is given below.

### SUMMARY OF DATA FOR THE COMBUSTION OF 1 LB. OF CARBON TO $CO_2$ .

Oxygen required.		Air required.		$CO_2$ produced.		$CO_2$ + Nitrogen.	
Weight in lbs.	Volume in feet. <sup>3</sup>	Weight in lbs.	Volume in feet. <sup>3</sup>	Weight in lbs.	Volume in feet. <sup>3</sup>	Weight in lbs.	Volume in feet. <sup>3</sup>
2.67	29.6	11.61	141	3.67	29.6	12.61	141

### COMBUSTION OF 1 LB. OF HYDROGEN TO $H_2O$ .

Oxygen required.		Air required.		$H_2O$ produced.		$H_2O$ + Nitrogen.	
Weight in lbs.	Volume in feet. <sup>3</sup>	Weight in lbs.	Volume in feet. <sup>3</sup>	Weight in lbs.	Volume in feet. <sup>3</sup>	Weight in lbs.	Volume in feet. <sup>3</sup>
8.0	88.78	34.78	422.8	9.0	177.56	35.78	511.6



## WEIGHT AND VOLUME OF AIR FOR COMBUSTION 23

The following weights and volumes of various gases are useful in fuel calculations:—

	Weight of 1 litre in grams.		Volume of 1 gram in litres.
	Calculated.	Measured.	
Hydrogen . . . . .	0.0900	0.08998	14.12
Oxygen . . . . .	1.4278	1.4292	0.6997
Nitrogen . . . . .	1.2503	1.2505	0.7997
Air . . . . .	1.2928	(1.2928)	0.7736
Carbon dioxide, $CO_2$ . . . . .	1.9633	1.9768	0.5059
Carbon monoxide . . . . .	1.2494	1.2503	0.7999
Marsh gas, $CH_4$ . . . . .	0.7153	0.7168	1.3951
Ethylene, $C_2H_4$ . . . . .	1.2508	1.2737	0.7851
Acetylene, $C_2H_2$ . . . . .	1.1608	1.189	0.8410
Sulphur dioxide, $SO_2$ . . . . .	2.8588	2.9266	0.3417

	Weight of 1 cubic foot in lbs.	Volume of 1 lb. in cubic feet.
Hydrogen . . . . .	0.005616	178.0
Oxygen . . . . .	0.08922	11.18
Nitrogen . . . . .	0.07806	12.81
Air . . . . .	0.08070	12.39
Carbon dioxide . . . . .	0.1234	8.10
Carbon monoxide . . . . .	0.07805	12.81
Marsh gas, $CH_4$ . . . . .	0.04475	22.35
Ethylene, $C_2H_4$ . . . . .	0.07944	12.58
Acetylene, $C_2H_2$ . . . . .	0.07422	13.47
Sulphur dioxide . . . . .	0.1827	5.47

These are calculated at  $0^\circ C$  and 760 mm. pressure. For different temperatures and pressures the correction must be made in the usual way. The column under "measured" weight of 1 litre in grams are the figures obtained by direct determination of the various densities, and these figures have been used for calculating the remaining data. One litre is taken as 0.035315 cubic foot and 1 kilo. as 2.2 lbs. avoirdupois.

## 24 AN INTRODUCTION TO THE STUDY OF FUEL

REQUIRED TO FIND (a) THE WEIGHT AND VOLUME OF AIR NECESSARY FOR COMPLETE COMBUSTION; (b) THE WEIGHT AND COMPOSITION OF THE PRODUCTS.

Suppose that the fuel has the following composition :—

Carbon . . . . .	88.0 %
Hydrogen . . . . .	5.5 %
Oxygen . . . . .	6.0 %
Nitrogen . . . . .	0.5 %

The carbon will be burnt to carbon dioxide. The oxygen present in the fuel is assumed to be combined with its equivalent of hydrogen, *i.e.*, with 0.75 parts, and the remainder ( $5.5 - 0.75$ ) = 4.75 parts are burnt, forming water. The nitrogen does not burn, but is found in the products of combustion.

Let the quantity of fuel burnt be 1 kilo. = 2.2 lbs. This contains.

Carbon . . . . .	0.88 kilo.
Hydrogen available . . . . .	0.0475 "
Hydrogen and oxygen combined . . . . .	0.0675 "
Nitrogen . . . . .	0.0050 "
	<hr/>
	1.0000 kilo.

The quantity of fuel burnt is assumed to be 1 kilo.

The carbon requires

$$\frac{880 \times 32}{12} = 2,347 \text{ grams oxygen.}$$

$$\frac{880 \times 22.32}{12} = 1636.8 \text{ litres oxygen.}$$

The weight of air required for the carbon is

$$\frac{2,347 \times 100}{23} = 10204.3 \text{ grams.}$$

The requisite volume of air is therefore

$$\frac{1636.8 \times 100}{21} = 7794.3 \text{ litres.}$$

One gram of hydrogen requires 8 grams of oxygen; hence 47.5 grams need 380.0 grams of oxygen.

WEIGHT AND VOLUME OF AIR FOR COMBUSTION 25

∴ Weight of air containing this oxygen is

$$\frac{380 \times 100}{23} = 1652.2 \text{ grams,}$$

and the volume is

$$\frac{265.2 \times 100}{21} = 1262.7 \text{ litres.}$$

The remaining hydrogen and oxygen find their way as water vapour into the products, together with the nitrogen present in the fuel and in the air supplied.

The total weight and volume of oxygen required for the combustion of 1 kilo. of fuel is the sum of the above quantities, *i.e.*

	Weight in grams.	Volume in litres.
Oxygen . . . . .	2727.0	1,902

and corresponding to these we have :—

	Weight in grams.	Volume in litres.
Air . . . . .	11856.5	9,057

The products of combustion will be :—

	Weight in grams.	Volume in litres.
From the combustion of carbon . . . . .	$CO_2 = 3227$	1636.8
	$N_2 = 7857.3$	6157.5
From combustion of hydrogen . . . . .	$H_2O = 427.5$	530.4 (as vapour) <sup>1</sup>
	$N_2 = 1272.2$	997.5
Water from combined H and O in fuel . . . . .	$H_2O = 67.5$	84 (as vapour) <sup>1</sup>
Nitrogen from fuel . . . . .	5.0	4
Total . . . . .	12856.5	9410.2

The products of combustion consist of :—

	Weight.	Volume.
Carbon dioxide . . . . .	$3227.0 = 25.10\%$	$1636.8 = 17.4\%$
Water . . . . .	$495.0 = 3.85\%$	$614.4 = 6.5\%$
Nitrogen . . . . .	$9134.5 = 71.05\%$	$7159.0 = 76.1\%$
	$12856.5 \cdot 100.00$	$9410.2 \cdot 100.0$

<sup>1</sup> See note on p. 21.

## 26 AN INTRODUCTION TO THE STUDY OF FUEL

If the products of combustion are subjected to analysis, the water would be found to be condensed, and therefore could not be measured under the ordinary conditions of analysis.

The composition of the dry gas would thus be:—

	Weight.	Volume.
Carbon dioxide . . . . .	26·10 %	18·6
Nitrogen . . . . .	73·90 %	81·4
	100·00	100·0

The above calculation is for the theoretical quantity of air required for the combustion of one kilo. of the fuel. In practice there must always be an excess of air, since it is impossible to carry out the combustion of fuel on the large scale with exactly the theoretical quantity of air. If now  $A_t$  denotes the theoretical amount of air necessary for the combustion, and  $A_1$  the amount actually employed, then

$$A_1 = nA_t$$

where  $n$  denotes the excess of air, and is an unknown factor which must be determined by experiment.

A large excess of air must be avoided, or much heat will be carried off in the products of combustion. A certain degree of excess is, however, necessary as a means of ensuring sufficient contact between fuel and air, and also because it enables certain reactions to proceed to completion which would otherwise be only partly completed. It is also important to mix the partially burnt gases with air before they leave the combustion chamber, and so to avoid loss of combustible materials, such as hydrocarbons formed by the destructive distillation of the coal, and carbon monoxide formed by the incomplete combustion of carbon. The value of  $n$  varies considerably for different designs of furnaces. In cases of bad firing the value of  $n$  may be 4·5 or more, while for careful firing and good management of fire doors and dampers it may be as low as 1·5 – 2·5. It depends partly upon the character of the fuel used; for instance, fuel in lumps offers

a much readier passage for air than fine slack, and in the latter case  $n$  will be smaller than in the former.

Most fuels contain small amounts of sulphur, and this is burned to sulphur dioxide. Any moisture present is dried at the expense of some of the heat of the fuel. Any mineral matter forms ash, which remains on the grate, and has to be removed from time to time. The heating effect of the fuel is greatly influenced both by the quantity of moisture and by the amount of ash present.

The combustion of carbon is by no means always complete. It may result in the formation of a gaseous product which is still combustible. When carbon, or coal, or coke is burnt in a limited supply of air or oxygen, or when carbon dioxide is passed over strongly heated carbon, carbon monoxide is produced:—

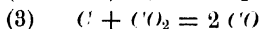
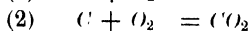
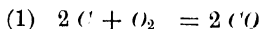

The carbon monoxide may result from either of the two reactions expressed in the above equations, *i.e.*, the carbon may burn directly to carbon monoxide as in (1), or carbon dioxide may be the first product (2), which in turn is reduced by the strongly heated carbon (3). Carbon monoxide can, under favourable conditions, decompose into carbon and carbon dioxide; hence equation (1) is better written as a reversible equation

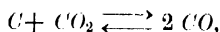

the sign  $\rightleftharpoons$  denoting that the reaction can take place in either direction, according to the conditions. This equation is of great importance in connection with the theory of the gas producer. The reaction

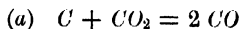

differs from the reaction

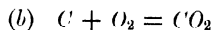

in the very important detail that whereas heat is evolved in (b) heat is absorbed in (a); hence the presence of carbon monoxide, in any considerable quantity, in the waste flue gases means a

considerable loss of heat in addition to the loss of fuel, due to combustible gases escaping up the chimney. The utilisation of fuel to the greatest advantage is an exceedingly important problem, and for its solution many factors must be considered.

When coal is burnt in a furnace, some of the air is supplied through the fire-bars at the bottom of the grate; as the gases rise through the heated layers of fuel, the air becomes used up and then the strongly heated fuel begins to reduce the carbon dioxide to monoxide.

The quantity of carbon dioxide reduced to monoxide depends upon the velocity with which the gases pass through the heated fuel. A second supply of air (secondary air) is admitted above the surface of the fire to consume any combustible gases that may be formed, such as carbon monoxide as described, or hydrocarbons resulting from the destructive distillation of the coal thrown on to the surface of the fire. If this secondary air is excessive in quantity, the furnace temperature is lowered and a great loss of effective heat results. Also, if the air and the gases are not efficiently mixed, or if the velocity of flow is so great that they are swept away into the flues before combustion can take place, loss of fuel will again result. Further, the gases must be deprived of their heat as far as possible before they escape up the chimney. In order to ensure the most economical combustion of a fuel the following points must be considered:—

(1) The design of the furnace, especially as regards the grate area, heating surface, and air supply.

(2) The chemical composition of the fuel employed. As a rule the determination of the (*a*) moisture, (*b*) volatile matter, (*c*) coke, and (*d*) ash, and occasionally sulphur, is sufficient in the case of solid fuel.

(3) The calorific power of the fuel.

(4) The composition of the waste flue gases.

(5) The temperature of the flue gases.

From the two latter and the weight of fuel burnt, the quantity of air used in burning unit weight of the fuel can be calculated, and hence the total volume of gases passing up the chimney. The heat loss, due to sensible heat carried off by these gases, can then be estimated.

## WEIGHT AND VOLUME OF AIR FOR COMBUSTION 29

Finally, if the heat be used for steam raising, and the weight of water evaporated be known, then, from the above data, the heat balance sheet of the furnace can be drawn up. The methods of determining and calculating the various factors will now be described, but for details of the requisite experiments larger works must be consulted, the exact description of these processes being outside the scope of the present book.

## CHAPTER III

### ANALYSIS OF FUEL AND FLUE GASES

THE analysis of fuel for engineering or other purposes usually resolves itself into the estimation of—

- (1) Moisture.
- (2) Volatile matter.
- (3) Coke.
- (4) Ash.

In some instances it is necessary to determine the composition of the fuel more exactly, *i.e.*, to estimate the carbon, hydrogen, oxygen, nitrogen, and sulphur, present in the fuel. Such a complete analysis involves the use of methods similar to those used in the analysis of organic compounds. The principle of the analysis of fuel only will be dealt with here.

#### (1) *Determination of Moisture.*

The coal is sampled in such a way as to obtain an average sample. The method of doing this differs in different cases, but in the case of a 10-ton waggon of coal the procedure is as follows: A quantity of the coal is shovelled from each end and the middle of the truck, part being taken from the top, middle, and bottom of the coal. As the coal is removed, a proportion, *e.g.*, a quarter, is put on one side. In amount this will be about 5 cwt. for a 10-ton load. The large pieces are then broken up and the whole thoroughly mixed and again divided into four quarters, one quarter being put aside. This is more finely divided and quartered again and the process of grinding and quartering repeated until a sample of the coal, 2 to 3 lbs. in weight is obtained. This is then used for analysis. When the sample is obtained it is best kept in tins with good fitting lids to prevent loss of moisture by evaporation.

About 50 or 100 grams of the coarse fuel are weighed out into a weighed porcelain dish and then heated in a steam or air bath



to 100° C., the heating being continued until the weight is constant. From the loss in weight the percentage of moisture present is obtained. The amount of moisture present must not be excessive, and should not be higher than 8 per cent. Any considerable amount of moisture results in a loss of heat when the fuel is introduced into the fire, since it has to be dried before it burns, and this will utilise some of the heat. Also the steam produced carries away "sensible" heat into the flue and chimney.

(2) *Determination of Volatile Matter.*

The fuel is next finely ground in a mortar and sifted through a 60-mesh sieve; 1 to 2 grams of this are weighed into a platinum crucible, which is covered by a lid. The crucible is now heated by a Bunsen burner with a long flame, the volatile matter is distilled off and burns round the loose-fitting cover. As soon as this flame drops the heating is discontinued and the mass allowed to cool somewhat. The cover is then removed and the soot on the sides of the crucible burnt, by cautiously heating with the burner for one minute, then it is allowed to cool in a desiccator and weighed, the loss of weight gives the volatile matter present; the residue represents the coke, or non-volatile carbon, and the mineral matter present in the sample.

(3) *Determination of Ash.*

From 2 to 5 grams of the finely-powdered coal are weighed out into a shallow porcelain dish and heated in a muffle to a dull-red heat until all the carbonaceous matter has been burnt. Care is necessary to avoid caking the coal or fusing the ash, but with a little experience concordant results can be obtained. After the combustion of the carbon is complete, *i.e.*, when no carbon particles can be seen in the ash, the dish is removed from the heat and allowed to cool in a desiccator. The weight of the residue is the weight of the ash of the fuel. The percentage of ash is then subtracted from the percentage of mineral matter and non-volatile carbon obtained from (2), and the percentage of coke thereby obtained. This calculation is not free from objection, since the ash is necessarily somewhat oxidised and may not represent the mineral matter originally

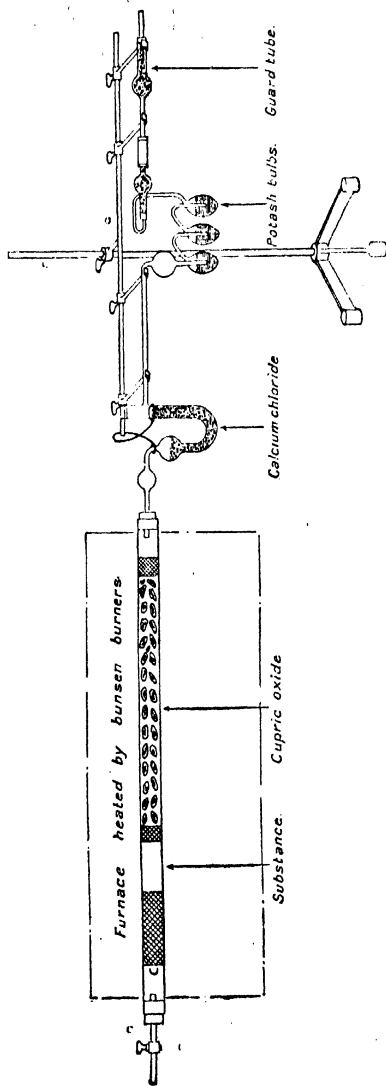

FIG. 1.—Apparatus for Estimation of Carbon and Hydrogen in a Fuel.

present in the coal. For example, sulphides might be converted into either sulphates or oxides, according to the condition of heating and the nature of the mineral matter present, but for ordinary technical purposes the ash may be taken as representing the mineral content of the coal. A high percentage of ash is very undesirable. Apart from the fact that it is incombustible, it may clog the fire by forming "clinker," and prevent free access of air to the fuel above, thus rendering the fire sluggish and necessitating frequent raking out of the fire bars. Further, it falls into the ash pit in a heated condition, and thus takes some of the heat of the fuel out of the furnace.

If it is necessary to determine the percentage of carbon, hydrogen, oxygen and nitrogen present in

the coal, the method of combustion used in the elementary analysis of organic compounds is employed. This consists of burning the substance in a supply of oxygen, whereby carbon dioxide and water are formed from the carbon, hydrogen, and oxygen of the fuel. These are absorbed in a suitable absorption apparatus, the water in a U tube containing dry granular calcium chloride, the carbon dioxide in a special set of bulbs containing a 30 per cent. solution of potassium hydrate. The calcium chloride tube and the potash bulbs are weighed separately, before and after the combustion, the increase in weight giving respectively the weight of water and carbon dioxide formed in the combustion; from these the percentages of carbon and hydrogen can be readily calculated. A diagram of that apparatus is given in Fig. 1.

The nitrogen is determined by combustion in the apparatus shown in Fig. 2, and combustion is effected by means of the oxygen contained in copper oxide. The air in the tube is previously removed by carbon dioxide supplied from a suitable generator, or made in the tube itself by heating magnesite,  $MgCO_3$ . All the products of combustion, except the nitrogen, are either condensed or absorbed in the collecting tube, which contains a strong solution of potassium hydrate. The nitrogen is collected and measured at the end of the experiment. From the volume of the nitrogen calculated at  $0^\circ C.$  and 760 mm., the weight, and hence the percentage, of the nitrogen can be obtained.

Sulphur can be estimated by burning a known weight of fuel in a good supply of oxygen and passing the products of combustion through a large U tube containing bromine and water. Any sulphur present forms sulphur dioxide, which is oxidised by the bromine, in presence of water, to sulphuric acid

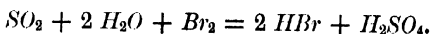

When the combustion is finished, the contents of the U tube are rinsed into a beaker, and boiled to remove the excess of bromine; barium chloride is then added, to convert the sulphuric acid present into insoluble barium sulphate. The barium sulphate is filtered off, dried, ignited, and weighed, and from its weight the percentage of sulphur is obtained. Oxygen cannot be estimated

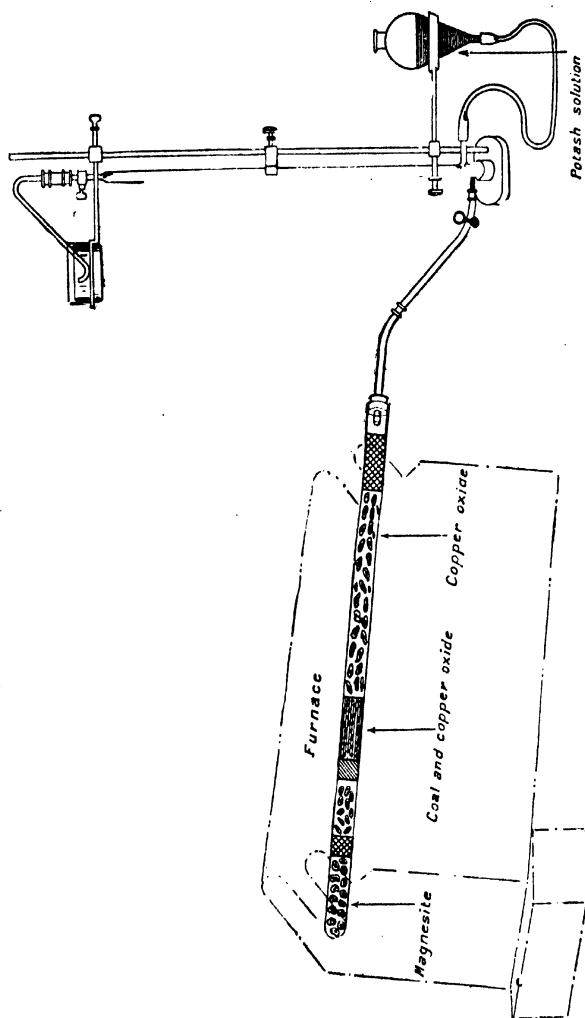

FIG. 2.—Apparatus for Estimation of Nitrogen by Combustion.

directly, but is usually taken by difference, after the estimation of all the other constituents of the coal.

The moisture, volatile matter, coke, and ash should be determined for each delivery of fuel received, since these factors serve as very valuable checks on the quality of the fuel supplied, and

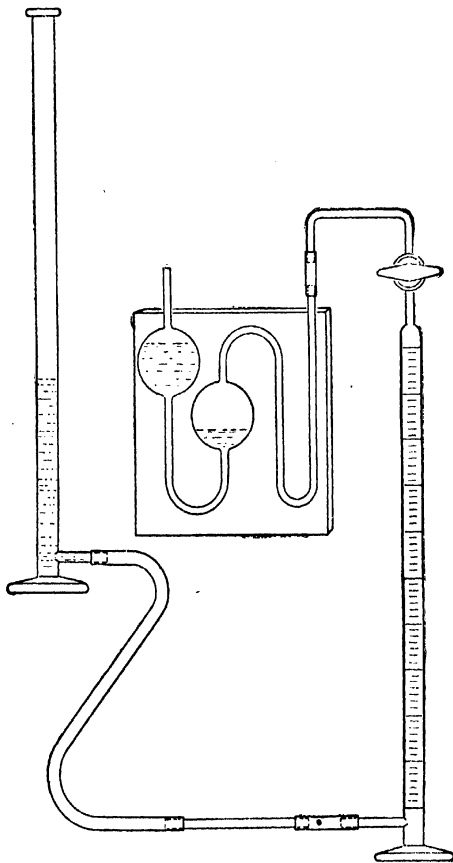

FIG. 3.—Hempel Gas Burette and Pipette.

also because from a knowledge of these factors the suitability of the fuel for the particular purpose in view can be judged. The calorific power, or heating power, can be calculated from the

percentage of carbon, hydrogen, etc., but it is usually determined directly by methods which will be described in the chapter on calorimetry.

#### ANALYSIS OF THE PRODUCTS OF COMBUSTION AND FLUE GASES.

For the proper control of fuel consumption a knowledge of the composition of the flue gases is necessary. The flue gases usually

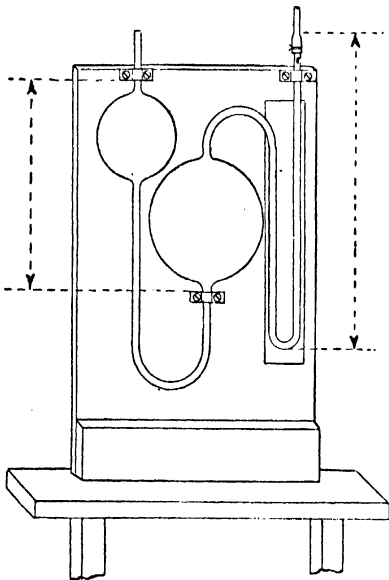

FIG. 4.—Hempel Pipette for Liquid Reagents.

consist of carbon dioxide, oxygen, and nitrogen, together with water vapour. Generally carbon monoxide and traces of hydro-carbons are found also, but the latter only in such small quantities that they cannot be estimated in the usual form of apparatus. For all ordinary purposes the estimation of the percentage by volume of carbon dioxide, oxygen, carbon monoxide and nitrogen is sufficient. The analysis of the waste gases is made in either a Hempel or Orsat apparatus. The former is more accurate than the

latter, but the Orsat apparatus has the advantage of being compact and easily portable. In addition to these there are more exact methods, such as the apparatus of Huntly or Bone and Wheeler, but the manipulation is more difficult, and the apparatus more complicated and more easily broken. The Hempel method of analysis will now be described for the analysis of waste gases and producer gas containing carbon dioxide, oxygen, carbon monoxide, hydrogen, marsh gas or methane, and hydrocarbons of the ethylene series.

In principle the analysis is effected by absorbing the various constituents in suitable reagents, the volume of the gas being measured before and after each absorption. The temperature and pressure must remain constant during the analysis, or they must be corrected for in the usual way. The analyses are carried out in a comparatively short time, so that the slight variation of the barometer, which is all that is likely to occur, has no influence upon the result, and the temperature can be kept

constant by means of a water jacket surrounding the measuring tube. The Hempel apparatus consists of a measuring tube (Fig. 3) holding 100 c.c. and graduated into 0.2 c.c., and capable of being read to 0.1 c.c. It is fitted with a three-way glass stopcock at top and bottom. The bottom stopcock is convenient when using the tube for sampling gases. The various reagents employed are contained in pipettes (Figs. 4 and 5) capable of holding either liquid (Fig. 4) or solid

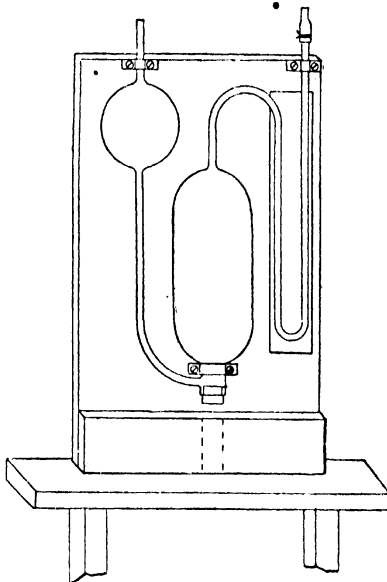

FIG. 5.—Hempel Pipette for Solid Reagents.

reagents (Fig. 5). Connection between the burette and pipette is made by a piece of very narrow bore glass tubing bent twice at right angles and joined on to the burette and pipette by stout rubber tubing which is wired on to prevent leakage (Fig. 3)

#### *Methods of obtaining a fair Sample of Gas.*

The gases are sampled so as to obtain a representative portion. If the gas is at a pressure higher than the atmosphere it is allowed to stream out through a T tube, and the gas burette

## 88 AN INTRODUCTION TO THE STUDY OF FUEL

filled with water or, better, strong brine solution, is attached to one limb of the T. The levelling tube is now lowered and the tap at the top turned on so that the water slowly runs out of the

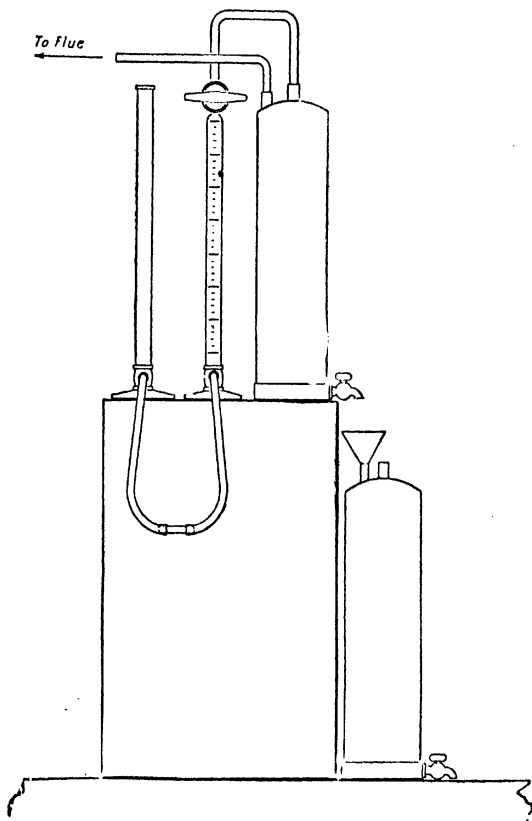

FIG. 6.—Aspirator for Sampling Flue Gases.

burette into the levelling tube, drawing in the same volume of gas. When the sample is small compared with the volume of gas flowing through the other limb of the T tube, and which adjusts the rate at which the sample is taken, a representative



sample is obtained. If the gases are at a lower pressure than the atmosphere, an aspirator must be employed. Fig. 6 shows the arrangement of an easily-constructed aspirator suitable for sampling flue gases. The gases are filtered through a plug of asbestos to remove dust. This is conveniently made by packing a U tube fitted with side tubes with asbestos fibres and then

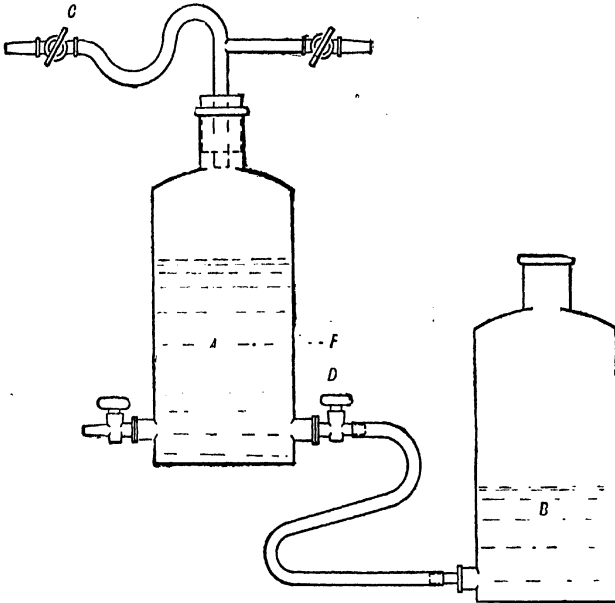

FIG. 7.—Stead's Gas Sampler.

sealing off the limbs of the U. This dust filter is interposed between the sampling apparatus and the tube leading to the flue, etc.

Another method of sampling is to aspirate the gases out of the flue into a special storing apparatus. Fig. 7 shows an apparatus for this purpose, and is known as Stead's gas sampler. The vessel A is filled with mercury and connected with the tube leading into the flue, etc. B is then lowered, the taps C and D opened, and as the mercury streams into B it draws the same volume of

gas into A. When filled with gas to about the level F, the taps are closed, and the apparatus removed to the laboratory, where the analysis is to be made. In order to get the gas from the sampler into the measuring burette the tap C is connected with the top tap of the burette, which is previously filled with water, B is raised, and the gas is driven out of A into the burette.

The gases may also be collected in tubes, fitted with taps at each end, by aspirating with a bellows aspirator, and this arrangement has the advantage of easy portability. The gas is subsequently forced out of the tubes by connecting with a mercury reservoir, as in the case of the Stead sampler.

The tube leading into the flue through which the gas sample is taken may conveniently be a  $\frac{3}{8}$ -inch gas pipe (unless the temperature is very high), and must be long enough to go through the masonry and extend into the middle of the flue. Connection between the iron and the glass sampling apparatus is made by well-fitting indiarubber corks.

#### *Determination of Carbon Dioxide.*

When the sample has been obtained and transferred to the burette it is allowed to stand, so as to attain the laboratory temperature. Then exactly 100 c.c. are measured off and the analysis proceeded with. The carbon dioxide is first removed by absorption in a solution of caustic potash containing 1 part of KOH to 2 of water. The solution is put into an absorption pipette (Fig. 4), and the capillary connecting tube is filled with the solution and connected to the measuring burette. By raising the levelling tube and opening the stopcock, the gas is completely transferred from the burette to the absorption pipette. When all the gas is transferred, the stopcock is closed, and the gas allowed to remain in contact with the absorbent for some minutes; the pipette should be shaken from time to time. After the absorption the gas is again drawn back into the measuring vessel and the volume noted. The transference of the gas to the absorption pipette is again carried out and repeated until no further contraction in volume takes place. The difference between the initial and final readings gives the percentage of carbon

dioxide contained in the gas. The absorp- tion by the caustic potash is due to the formation of potassium carbonate

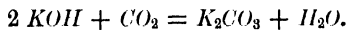

Potassium hydrate is employed in preference to sodium hydrate, owing to the fact that the carbonate is deliquescent and does not tend to crystallise out as sodium carbonate would do under the same circumstances. The volume percentage of carbon dioxide in flue gases depends upon very many factors. It can vary between the limits of 0 to 21 per cent., but, as a rule, it is seldom more than 3 to 8 per cent. in furnaces working under natural draught. With forced or induced draught, where the combustion is under greater control, it may be as high as 12 to 16 per cent., but the lower figure is more frequent than the higher.

#### *Determination of Oxygen.*

The oxygen is next determined. For this purpose phosphorus may be employed; it is used in the form of sticks, made by melting it under warm water, and drawing it up into narrow, well-wetted glass tubes by means of a filter pump. As soon as a tube is full the end is closed by the finger, and the tube plunged into cold water. When the phosphorus is set, it either falls out of the tube or can be easily pushed out with a thin glass rod. As an alternative to phosphorus an alkaline solution of pyrogallol (pyrogallie acid) may be used. It is made by dissolving 5 grams of pyrogallol in 15 c.c. of water and adding to it 120 grams of potassium hydrate dissolved in 80 c.c. of water. If the phosphorus is used, it is contained in the pipette, shown in Fig. 5; the cylindrical part is filled as completely as possible, and the entrance closed by a well-paraffined cork, or by a rubber stopper. The pipette contains water, to protect the phosphorus from oxidation when not in use. If pyro is used it is contained in a double pipette, the two additional bulbs containing water, which protects the alkaline pyro from absorbing oxygen from the air, a process which rapidly deteriorates it. The gas, after removal of the carbon dioxide, is brought into contact with the oxygen absorbing reagent, and the manipulation is the same as in the previous example. When phosphorus is used the gas is left in contact with it until the slight fume, which is first

## 42 AN INTRODUCTION TO THE STUDY OF FUEL

formed, has dissolved in the water; the remaining gas is then drawn back into the measuring vessel and the volume again noted. From the difference between the previous reading and this, the percentage of oxygen is obtained. The pipette containing phosphorus must not be kept in the light, as the phosphorus changes into the red modification, which does not react with oxygen. The pipette can be protected from light very conveniently by covering the bulb with a cardboard screen. Phosphorus has the advantage over pyro as an oxygen absorbent, that when once the pipette is filled the apparatus is ready for work, without refilling, and lasts indefinitely. Pyro, on the other hand, rapidly deteriorates in alkaline solution, owing to the ease with which it absorbs oxygen, and the pipette requires refilling at frequent intervals.

### *Determination of Carbon Monoxide.*

The carbon monoxide is next removed and estimated. For this purpose either an ammoniacal solution of cuprous chloride or a solution of cuprous chloride in hydrochloric acid, is employed. Either reagent absorbs oxygen, and therefore it must be kept in a compound pipette. Cuprous chloride can be readily purchased, or it can be prepared as required. Owing to the readiness with which the cuprous chloride passes into the cupric state, the material, either solid or in solution, must be kept in well-stoppered bottles. The cuprous chloride is prepared thus: 5 grams of metallic copper and 10 grams of copper oxide are digested with about 200 c.c. of concentrated hydrochloric acid. A dark-brown coloured solution is obtained, and when practically all of the copper and oxide have dissolved the solution is poured into an excess of cold water. The sparingly soluble cuprous chloride separates out as a white precipitate and rapidly settles at the bottom of the beaker, the clear liquid is decanted off, the precipitate washed twice or thrice, with water by decantation, and finally dissolved in hydrochloric acid of specific gravity 1.124, or ammonium hydrate of specific gravity 0.910. The solution is put into a compound pipette for solid reagents, a roll of copper gauze or wire being placed in the bulb to assist in keeping the solution in the cuprous state. The

absorption of the carbon monoxide is carried out in exactly the same way as in the case of the other gases. Owing to the unstable nature of the compound formed by the union of carbon monoxide and cuprous chloride,  $Cu_2Cl_2 \cdot nCO$ , it occasionally happens that the volume of gas is greater after contact with cuprous chloride than before. This is due to the dissociation of the unstable compound formed during a previous experiment, which gives up carbon monoxide. To obviate errors due to this cause it is better to employ two pipettes, one containing cuprous chloride which has been used, and the other containing a fresh solution. The gas is brought into contact with the used solution first, and then with the fresh solution, and in this way complete absorption of the carbon monoxide is ensured. The solutions must be freshly made, and require frequent renewal.

Carbon monoxide can also be determined by combustion, *i.e.*, an excess of oxygen can be added and the mixture exploded by means of an electric spark; the carbon dioxide so formed may then be determined by absorption with potassium hydrate, as described above. The calculation is as follows. Carbon monoxide, when burnt, forms its own volume of carbon dioxide—

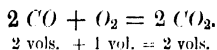

Hence the volume of carbon dioxide formed is equal to the volume of carbon monoxide originally present in the gas.

In most cases of the analysis of flue gases, the gas remaining after the foregoing estimations is taken as nitrogen and its percentage is obtained by difference, *i.e.*, by subtracting the sum of the percentages of the other constituents from one hundred. In the analysis of producer gas, water gas, carburetted water gas, and coal gas, the residual gas at this stage would contain hydrogen and hydrocarbons (chiefly marsh gas  $CH_4$ ) in addition to nitrogen, and their estimation is a matter of importance, since these constituents have a very great influence upon the heating value of the gas. In the analysis of gases containing heavy (illuminating) hydrocarbons, a pipette containing either a saturated solution of bromine in potassium bromide or a mixture of fuming sulphuric acid (Nordhausen sulphuric acid,  $H_2S_2O_7$ ) and ordinary sulphuric acid, sp. gr.

#### 44 AN INTRODUCTION TO THE STUDY OF FUEL

1.84, is used after the absorption of the carbon dioxide. These hydrocarbons belong to the unsaturated series, of which ethylene,  $C_2H_4$  is typical; they are absorbed by either of the reagents mentioned, and the absorption is followed by a second one in a pipette containing caustic potash, which is used to remove the bromine vapour or the sulphur trioxide fumes. Hydrocarbons of the marsh gas series and also hydrogen remain unabsorbed by all these reagents, and hence are left with the nitrogen at the end of the analysis.

##### *Estimation of Hydrogen, Methane, and Nitrogen.*

The methane, hydrogen, and nitrogen may be estimated in the following way: When marsh gas,  $CH_4$ , is exploded with an excess of oxygen, carbon dioxide and water are formed, and if the measurements of volume are carried out at ordinary temperatures, the extremely small volume occupied by the water can be neglected in comparison with that occupied by the gas. Thus:—

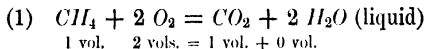

Similarly, in the case of hydrogen and oxygen:—

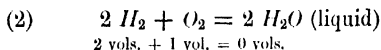

Hence in (1) there is a contraction from three volumes to one volume, and in (2) there is a contraction from three volumes to zero volume. If a mixture of marsh gas and hydrogen be exploded with a measured excess of oxygen, and the contraction and the volume of carbon dioxide formed be observed, the proportions of marsh gas and hydrogen present can be determined in the following way:—

Let the total contraction in volume after explosion with an excess of oxygen be  $n$  c.c., and let  $p$  c.c. be absorbed by caustic potash. From equation (1) it is evident that the volume of carbon dioxide formed is equal to the volume of marsh gas originally present. Therefore the marsh gas present was  $p$  c.c. Again, from equation (1) it is evident that the contraction is twice the volume of marsh gas; hence the contraction due to the marsh gas must be  $2p$ . From equation (2) it can be seen that two-thirds of the contraction is due to hydrogen; therefore,

since the total contraction is  $n$  and of this  $2p$  is due to marsh gas, the hydrogen present must have been

$$\frac{2}{3}(n - 2p).$$

The explosion is carried out in the pipette shown in Fig. 8. It is fitted with a stopcock at  $S_1$  and  $S_2$ ; platinum wires are

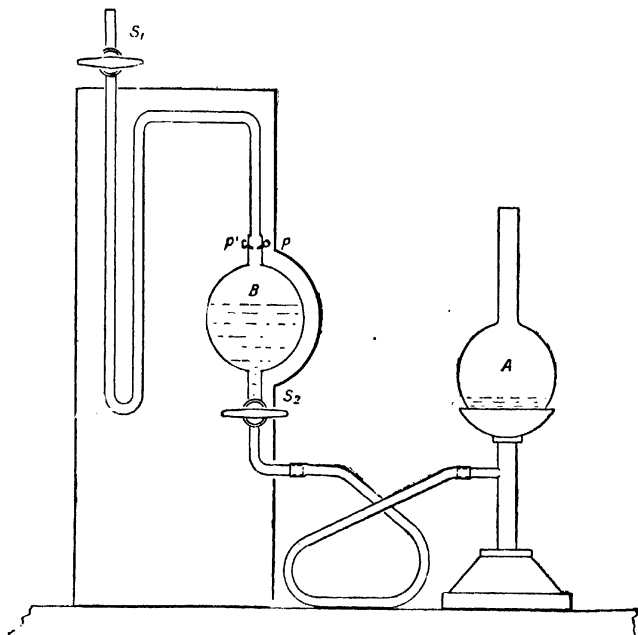

FIG. 8.—Hempel Explosion Pipette.

fused in the glass at  $p'.p.$  to enable the gas to be fired by the electric spark from a suitable Rhumkoff coil—one which will give about a quarter-inch spark is sufficient. The gas is confined over mercury in this pipette. It is transferred from the measuring burette to the pipette, and the tap  $S_1$  is closed; an excess of oxygen is then added, and the gases are mixed and drawn back into the measuring vessel and measured. They are again transferred to the pipette, the tap  $S_1$  is closed, and

## 46 AN INTRODUCTION TO THE STUDY OF FUEL

the bulb A lowered, so as to reduce the pressure; then the second tap  $S_2$  is closed, the platinum wires connected with the secondary terminals of a Ruhmkoff coil, and the gases fired. The explosion is perfectly quiet, a momentary bright flash in B being all that is seen. After the explosion the residual gas is allowed to cool down and the pressure is equalised in the bulb B. Finally the gas is transferred to the measuring burette and the contraction in volume noted. The carbon dioxide formed in the explosion is determined as before, and from the results the proportions of methane and hydrogen are calculated.

### *Method of Calculating the Results of an Explosion Analysis.*

A sample of illuminating gas consisted of coal gas, to which a certain proportion of carburetted water gas had been added. The results obtained in the course of an analysis were:—

Volume of gas taken for analysis	= 100.0 c.c.
Volume after absorption by $KOH$	= 100.0 „
∴ Carbon dioxide	= <u>0.0 %</u>
Volume after bromine followed by $KOH$	= 91.8 c.c.
∴ Heavy (illuminating) hydrocarbons	= <u>8.2 %</u>
Volume after phosphorus	= 91.2 c.c.
∴ Oxygen	= <u>0.6 %</u>
Volume after cuprous chloride	= 73.4 c.c.
∴ Carbon monoxide	= <u>17.8 %</u>

18.2 c.c. of the residual 73.4 c.c. were taken, mixed with an excess of oxygen and exploded, as described.

Volume before explosion	= 95.2 c.c.
Volume after explosion	= 73.2 „
Total contraction	= 22.0 „

The carbon dioxide formed by the explosion was then absorbed by  $KOH$ .

Volume after $KOH$	= 68.8
∴ Volume of $CO_2$ = volume of $CH_4$	= 4.4 c.c.



Contraction due to hydrogen is

$$22.0 - 2 \times 4.4 = 13.2 \text{ c.c.}$$

$$\text{Volume of hydrogen} = \frac{2}{3} \times 13.2 = 8.8 \text{ c.c.}$$

Now these represent the volumes of methane and hydrogen present in 13.2 c.c. of the residue; the percentages by volume will be therefore:—

$$\begin{aligned} \text{Methane} & \frac{4.4 \times 73.2}{13.2} = \underline{24.3} \% \\ \text{Hydrogen} & \frac{8.8 \times 73.2}{13.2} = \underline{48.8} \% \end{aligned}$$

The complete analysis is:—

Carbon dioxide . . . . .	0.0 %
Heavy hydrocarbons . . . . .	8.2 %
Oxygen . . . . .	0.6 %
Carbon monoxide . . . . .	17.8 %
Methane . . . . .	24.3 %
Hydrogen . . . . .	48.8 %
Nitrogen (by difference) . . . . .	0.3 %
	<hr/>
	100.0
	<hr/>

In addition to the above method there are a number of types of automatic gas analysis apparatus, especially designed for analysing flue gases—for example, the Ados  $CO_2$  recorder; for a description of these the larger works must be consulted.

The importance of the analysis of flue gases as a means of furnace control cannot be over-estimated. It is a check on the stoking, since it detects the presence of too great an excess of air on the one hand and the too limited supply due to insufficient admission of secondary air on the other. In the first case the oxygen would be high in the flue gases and the carbon dioxide correspondingly low; in the second case carbon monoxide in fair quantity would be found in the gases. This might also arise from too great thickness and density of the fire, which would thus become virtually a gas producer, the carbon being only burnt to carbon monoxide. Further, it enables the loss of heat, due to sensible heat remaining in the flue gases, to be

estimated if the flue temperature and volume of air passing along the flue are known.

For the purpose of checking the firing of boilers and furnaces

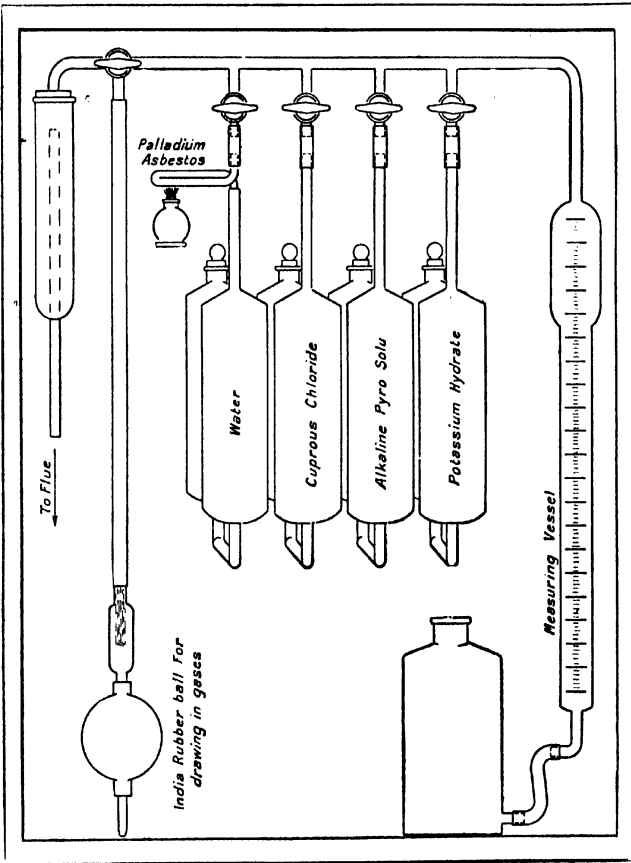

FIG. 9.—Orsat Gas Analysis Apparatus.

the analysis is frequently made in an Orsat apparatus, shown in Fig. 9. This apparatus is compact and fitted into a wooden case, which can be easily carried about, thus enabling the

analysis to be done immediately the sample is taken without waiting to return to the laboratory. The absorbents are the same as those used in the method described above, and the manipulation is similar; the chief difference is that the changing of pipettes necessary in the Hempel method is avoided. The apparatus is all permanently connected together by capillary tubing, and the various pipettes are closed by glass taps. In point of accuracy the Orsat is somewhat inferior to the Hempel, but owing to its compactness and portability it is largely used in works.

## CHAPTER IV

### CALORIMETRY AND DETERMINATION OF THE HEATING VALUE OF A FUEL

WHEN a chemical reaction takes place a change of energy takes place at the same time. This energy change is frequently evident to the senses as an evolution or absorption of heat. The quantity of heat depends only on the initial and final states of the materials taking part in the reaction; it is independent of the number of steps by which the action may be carried to completion. For example, when carbon is burnt directly to carbon dioxide the total quantity of heat evolved is the same as when the carbon is first burnt to carbon monoxide, and the carbon monoxide afterwards burnt to carbon dioxide. Expressing this in the form of a thermo-chemical equation, and indicating solids by square brackets and gases by round brackets, also the heat of reaction in gram calories (*i.e.*, the quantity of heat required to raise 1 gram of water 1° C.), we have:

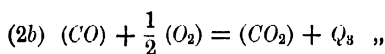
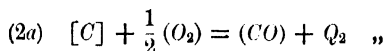
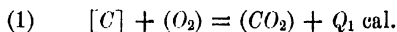

And

$$Q_1 = Q_2 + Q_3.$$

It is not possible to determine the heat of formation of carbon monoxide from solid carbon and gaseous oxygen (equation 2), but the heat of formation of carbon dioxide from solid carbon and gaseous oxygen can be determined, also the heat of combustion of carbon monoxide in oxygen; hence it follows from the above principle that the heat evolved by the second reaction can be calculated thus:—

$$Q_2 = Q_1 - Q_3, \text{ where } Q_2 \text{ is the heat of formation of } CO^c$$

In a similar way the heats of formation of other bodies can be obtained, even when they cannot be determined by a direct experience. The heats of formation and combustion of substances, either elements or compounds, are physical constants, the determination of which is of extreme importance. For the methods of determination and the numerical value of these results, text-books upon heat should be consulted.

It is, however, necessary for present purposes to know the heating value or *calorific power* of a fuel in order to arrive at a conclusion as to its suitability for a given purpose, and for subsequently determining the efficiency of the furnace or boiler in which it is used. The term calorific power must not be confused with the term *calorific intensity* or pyrometric heating value, that is, the maximum temperature theoretically attainable under the given conditions of combustion. The calorific power is measured by means of a suitable calorimeter, and is expressed in suitable heat units; the calorific intensity is a temperature and is expressed in degrees Centigrade or Fahrenheit.

Several units of heat are employed:—

(1) The “zero calorie,” or the quantity of heat required to raise 1 gram of water 1° C., viz., from 0° to 1° C.

(2) The “calorie,” or quantity of heat necessary to raise 1 gram of water at room temperature (15° to 20°) 1° C. This is equal to 0.994 zero calorie.

(3) The “mean calorie” is the one hundredth part of the heat required to raise 1 gram of water from 0° to 100° C. It is about the same as the zero calorie. To each of these “small calories” there is a corresponding “large calorie” which has a value of one thousand times that of the small calorie.

(4) The “British Thermal Unit” or heat required to raise 1 lb. of water 1° F. (from 60° to 61° F.). This unit, denoted by B.T.U., is used as the heat unit in this country.

(5) The “Pound Centigrade Unit” or the quantity of heat required to raise 1 lb. of water 1° C.

In order to convert lb. C. units into B.T.U.s. it is only necessary to multiply by 1.8, i.e., the ratio between the Centigrade and Fahrenheit degree.

For many engineering purposes it is customary to express the

## 52 AN INTRODUCTION TO THE STUDY OF FUEL

heating value of fuels in terms of the number of pounds of water at 212° F. (100° C.) which would be converted into steam by the combustion of 1 lb. of fuel. This is termed the "Evaporative Power"; it has the advantage of being independent of any particular thermometric scale. The latent heat of vaporisation of water is 537 Centigrade or 967 Fahrenheit units, hence

$$\text{E.P.} = \frac{\text{B.T.U.}}{967} = \frac{\text{C.P. in calories}}{537}$$

The combustion of hydrogen results in the formation of water, and hence in calculating the E.P. allowance must be made for the heat required to evaporate the water formed.

The calorific power or heating value of a fuel can be calculated from a knowledge of its composition and the heats of formation of the various products. The heats of formation of carbon dioxide, carbon monoxide and water, respectively, are

$$(1) [C] + (O_2) = (CO_2) + 97,000 \text{ cal., or } 174,600 \text{ B.T.U.}$$

12 grams + 32 grams = 44 grams.

$$\therefore 1 \text{ gram} + 2.67 \text{ grams} = 3.67 \text{ grams} + 8,083 \text{ cal., or } 14,550 \text{ B.T.U.}$$

$$(2) (CO) + \frac{1}{2}(O_2) = (CO_2) + 68,000 \text{ cal.} = 122,400 \text{ B.T.U.}$$

The heat of formation of carbon monoxide from carbon and oxygen is obtained by subtracting (2) from (1).

$$(3) [C] + \frac{1}{2}(O_2) = (CO) + 29,000 \text{ cal., or } 52,200 \text{ B.T.U.}$$

$$12 \text{ grams} + \frac{1}{2}(32) \text{ grams} = 28 \text{ grams.}$$

$$\therefore 1 \text{ gram} + 1.33 \text{ grams} = 2.33 \text{ grams} + 2,417 \text{ cal., or } 4,350 \text{ B.T.U.}$$

The heat of formation of water is:—

$$(4) (H_2) + \frac{1}{2}(O_2) = (H_2O) + 68,400 \text{ cal., or } 123,120 \text{ B.T.U.}$$

$$2 \text{ grams} + \frac{1}{2}(32) \text{ grams} = (18 \text{ grams}).$$

$$\therefore 1 \text{ gram} + 8 \text{ grams} = 9 \text{ grams} + 34,200 \text{ cal., or } 61,560 \text{ B.T.U.}$$

By substituting these values in an empirical formula originally devised by Dulong, the calorific power can be calculated. The formula for hard coal, *e.g.*, anthracite,

$$q = \frac{8,083 C + 34,200 (H - \frac{1}{8} O)}{100}$$

and for brown coal, turf, or peat and wood, the formula is

$$q = \frac{8,083 C + 29,633 H_1 - 637 (W' - W_1)}{100}$$

$C$  denotes the percentage of carbon.

$H$  " " hydrogen.

$O$  " " oxygen.

$H_1$  " " disposable hydrogen  
 $(H_1 = (H - \frac{1}{8} O))$ .

$W'$  " " chemically combined water,  
 $W' = \frac{9}{8} O$ .

$W_1$  denotes the percentage of hygroscopic water or moisture.

Heat of combustion of carbon to carbon dioxide . . . . . 8,083 cal., 14,550 B.T.U.

Heat of combustion of hydrogen to form liquid water . . . . . 34,200 ,, 61,560 ,,

Heat of combustion of hydrogen to form water vapour . . . . . 29,633 ,, 53,336 ,,

Heat of vaporisation of water . . . . . 637 ,, 1,147 ,,

If the coal contains sulphur in the form of sulphide or other combustible compound, a correction must be added to the above equations on account of the heat evolved by the combustion of the sulphur. If  $S$  denotes the percentage of sulphur present in the fuel, then the product

$$\frac{2,500 \cdot S}{100} \text{ cal., or } \frac{4,500 \cdot S}{100} \text{ B.T.U.,}$$

must be added to the above equations.

The results given by this formula are at least only approximate. This is due to many causes, such as uncertainty of the form in which the carbon is present; the value 8,083 cal. given above applies to wood charcoal and is always used in such calculations; uncertainty also exists as to the state of combination of the hydrogen, *i.e.*, whether it is present in saturated or unsaturated hydro-carbons. The calorific power of hydrogen used in the calculation, *viz.*, 34,200 cal., is that of gaseous hydrogen, and in solid fuels the hydrogen does not exist in this state, and heat

## 54 AN INTRODUCTION TO THE STUDY OF FUEL

is absorbed in converting it from the solid into the gaseous conditions.

Other formulae have been proposed. for example the formula of G. Arth:

$$q = \frac{34,500 (H - \frac{1}{8} O) + 8,083 C + 2,162 S}{100}$$

where  $S$  is the oxygen required to burn unit weight of the fuel. This is determined by Berthier's method, which consists of reducing litharge,  $PbO$  with a known weight of the fuel, and weighing the resulting lead. About 1 gram of the fuel in the finest state of division is mixed with 40 to 50 grams of carefully-sifted litharge, the mixing being done as thoroughly as possible. The mixture is put into a clay crucible and covered with another 20 to 25 grams of litharge. The crucible is placed in a furnace and heated to a good red heat for about one hour. The litharge is reduced according to the equations

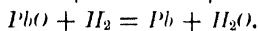
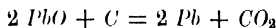

From the weight of the resulting lead, the oxygen removed by the fuel can be calculated. The crucible is removed from the furnace, tapped a few times to collect the metallic lead at the bottom, and then allowed to cool. When cool, the crucible is broken and the lead is collected and weighed. This method was originally proposed by Berthier as a method for determining the calorific power of fuels. It rested on the so-called Welter's law, which stated that when one and the same quantity of oxygen combined with any other element, the same quantity of heat was always evolved. This statement is absolutely untenable, as can be shown by considering the quantity of heat evolved when 1 gram of oxygen combines with carbon and hydrogen respectively, thus:

Carbon burning to form carbon dioxide evolves 3,081 cal.

Hydrogen burning to form liquid water „ 4,272 cal.

Hydrogen burning to form water vapour „ 4,192 cal.

This method is never used unless all other methods, such as elementary analysis, or direct estimation of the calorific power



in a calorimeter, are rendered impossible. The Association of German Engineers have adopted the formula—

$$q = \frac{8,000 C + 2,900 (H - \frac{1}{8} O) + 2,500 S + 600 W}{100}$$

to calculate the calorific power of fuels,  $W$  being the percentage of moisture present in the fuel.

*Experimental Determination of the Calorific Power of a Fuel.*

In the direct estimation of the calorific power of a fuel, the apparatus employed is such that a known weight of the fuel can be burnt under circumstances in which the heat evolved by the combustion can be absorbed by a known weight of water; the resulting rise in temperature of the water is then observed, and the amount of heat required to bring about this rise is easily calculated. Combustion calorimeters of this type are employed for either combustion at constant pressure or at constant volume, and the combustion may be effected by oxygen supplied from a cylinder of compressed gas or from an oxidising agent intimately mixed with the fuel and placed in the combustion vessel of the calorimeter. The best-known calorimeters in which the combustion takes place at atmospheric pressure are:—

Lewis Thompson's calorimeter.

William Thomson's calorimeter.

Rosenhain's calorimeter.

F. Fischer's calorimeter.

In another type of calorimeter the combustion is carried out at pressures greater than atmospheric; the best known of these are the Berthelot-Mahler Bomb calorimeter and the calorimeter of S. W. Parr.

In all these direct methods of determining the heat of combustion, the hydrogen present is burnt to water and the water is condensed to liquid water giving up its latent heat of vaporisation; hence the upper limit of the calorific power is obtained. The lower limit can be obtained by subtracting the latent heat of vaporisation of water, 10,800 cal. per molecule, from the value obtained experimentally. The various forms of calorimeters and the methods of using them will now be described.

*The Lewis Thompson Calorimeter.*

This instrument is extremely convenient for technical fuel testing, and has come into fairly general use. It consists of a tall glass cylinder (Fig. 10) graduated to hold 2,000 grams of

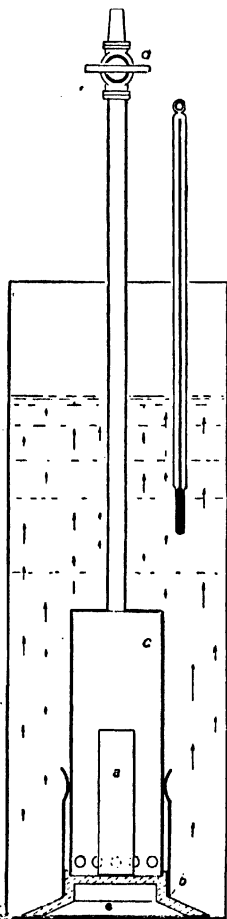

FIG. 10.—Lewis Thompson's Calorimeter.

water; a second mark is usually made at 1,932 grams. The fuel is dried, finely powdered, and mixed with an oxidising mixture which consists of three parts of potassium chlorate and one part of potassium nitrate (nitre). The quantity of oxidising agent to be used will vary with each fuel, but as a rule eight to twelve times the weight of the fuel is employed. About two grams of the finely-divided fuel are mixed with twenty grams of the oxidising mixture and placed in a suitable copper tube (Fig. 10, *a*), of which a number are provided with each instrument. A fuse, made by soaking Oxford cotton in lead nitrate solution and then allowing it to dry, is set in the mixture and the copper cylinder is then put into position on the copper base (Fig. 10, *b*) and covered with the wide copper cylinder (Fig. 10, *c*). This is fitted with a long narrow copper tube and stopcock and is perforated with holes at the bottom to allow the escape of the products of combustion. Just before this is clipped on to the base, the fuse is ignited, and as soon as the cover *c* is in position the whole is immersed in the water contained in the glass vessel. The temperature of the water has been observed previously. Combustion should proceed vigorously and be complete in about

a couple of minutes. The products of combustion escape through the holes at the bottom of the copper cylinder, and pass up through the water, giving up their heat to it. As soon as combustion is complete, the tap (Fig. 10 *W*) is opened so as to admit water into the interior of the cylinder. This is then raised and lowered a few times so as to thoroughly mix the water and ensure that the temperature shall be the same throughout the whole of the water in the calorimeter. The temperature is taken and the rise of temperature caused by the combustion of the fuel obtained. The rise in temperature in degrees Fahrenheit multiplied by the weight of water, and divided by the weight of fuel used, gives the B.T.U.s. absorbed by the water.

There are several sources of error in this method; the principal of these are the following:—

- (1) Heat absorbed by the apparatus;
- (2) Heat lost by radiation;
- (3) Heat of decomposition of the oxidising mixture;
- (4) Heat of solution of the substances remaining in the copper tube at the end of the combustion.

The radiation loss can be compensated for by making a trial experiment, and then a second experiment, in which the water is cooled as much below the atmosphere as it will be above when the combustion is over; or it can be corrected for by taking a number of time-temperature readings both before and after the determination. This method will be dealt more fully with under the Bomb calorimeter (*cf.* p. 63 and ff.). In order to allow for the other sources of error an addition of 10 per cent. is made, which is stated by the makers of the instrument to cover them.

If the vessel is only filled up to the 1,932 gram mark the rise of temperature during the experiment gives the evaporative power of the fuel. The example given below will show the reason of this.

*Typical Example.*

Two grams of fuel were burnt, and the rise of temperature observed was 14.6° F. Weight of water used, 2,000 grams. The calorific power of the fuel is therefore:

$$\bullet \text{ C.P.} = \frac{(14.60 + \frac{1}{10}(14.60)) \times 2,000}{2} = 16,060 \text{ B.T.U.}$$

## 58 AN INTRODUCTION TO THE STUDY OF FUEL

Supposing only 1,932 grams of water had been used, and the same rise of temperature obtained, viz., 16.06° F., then the evaporative power of the fuel is:

$$\frac{(14.6 + \frac{1}{10}(14.6)) \times 1,932}{2 \times 966}$$

where 966 is the latent heat of vaporisation of water at 212° F.

$$\therefore \text{E.P.} = 14.6 + 1.4 = 16.0.$$

Fuels like bituminous coal should be burnt in narrow, long cylinders, while charcoal, coke, anthracite and other difficultly combustible fuels should be burnt in short, wide cylinders or furnaces. The thermometers used are divided into  $\frac{1}{10}$ ° F., and are capable of being read to  $\frac{1}{100}$ ° F. by eye estimation.

### W. Thomson Calorimeter.

This apparatus is similar to the preceding one, but oxygen supplied from a cylinder of compressed gas is used for burning the fuel. The apparatus is shown diagrammatically in Fig. 11. It consists of a tall glass cylinder capable of holding 2,000 grams of water A; a platinum crucible for containing the fuel to be burnt; a cylindrical glass bell jar (B), which covers the crucible and contains oxygen for the combustion. This cylinder is provided with a long brass tube, fitted with a stopcock, through which oxygen can be supplied from the gas-holder. This tube is connected to the glass cylinder by means of a short piece of stout rubber tubing, and it can readily be raised or lowered during the experiment. The glass bell jar rests upon a perforated brass foot, which is fitted with a stand for the platinum crucible and with spring clips for holding it fast to the bell jar. The glass bell jar is surrounded with several rings of copper gauze, which serve to break up the current of products of combustion as they ascend, thus ensuring a more complete cooling of the gases. It is necessary to know the "water equivalent" of the calorimeter, i.e., the number of grams of water which would require the same amount of heat to raise it 1°, as does the calorimeter. It is best determined directly by burning a known quantity of some substance the heat of combustion of which has been accurately determined. Naphthaline is usually employed,

as it can be readily obtained pure, and it is known to evolve 9,668 calories per gram upon combustion.

The method of determining the water equivalent is the same as the determination of the calorific power of the fuel, as far as manipulation is concerned. About 1 gram of naphthaline is accurately weighed out and placed in the platinum crucible and a piece of fuse attached. 2,000 grams of water are placed in the glass vessel and allowed to take up the room temperature, or the temperature is corrected in the same way as in the case of the Bomb calorimeter, *q.v.* The brass tube is connected to the glass bell jar and also to the oxygen cylinder, the oxygen turned on and regulated so as to give a regular current of gas. The platinum crucible is placed in position on the foot, the fuse ignited, the bell jar slipped over the clips, and the whole rapidly transferred to the water before the naphthaline is ignited. As soon as the naphthaline commences to burn the brass tube is raised or lowered and the current of oxygen regulated so that the burning proceeds regularly and not too rapidly. As soon as the combustion is over, the oxygen

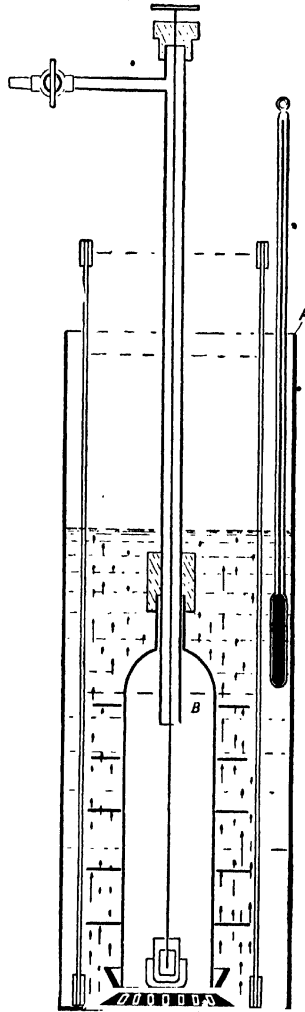

FIG. 11.—William Thomson's Calorimeter.

## 60 AN INTRODUCTION TO THE STUDY OF FUEL

is shut off, the oxygen cylinder is disconnected, and the stopcock opened so as to admit water into the bell jar. The bell jar is moved up and down several times in order to thoroughly mix the water. The temperature is then taken. The water equivalent is calculated in the following way:—

Suppose that 2,000 grams of water were used in the calorimeter and that one gram of naphthaline was burnt. The rise in temperature caused by the combustion of the naphthaline is  $4.37^{\circ}$  C. Let  $x$  denote the water equivalent of the calorimeter then

$$\begin{aligned} 9,668 &= (2,000 + x) 4.37 \\ x &= 210 \text{ grams.} \end{aligned}$$

Hence the apparatus requires the same amount of heat to raise its temperature  $1^{\circ}$  as 210 grams of water, and in calculating calorific powers of fuels determined in the calorimeter the water equivalent of the apparatus must be added on to the weight of water taken.

The determination of the calorific power of a fuel by means of this apparatus is the same as the determination of the water equivalent. A quantity of the fuel, in fine powder, is taken, sufficient to give a rise of  $2^{\circ}$  to  $3^{\circ}$  C.; 1 to 2 grams are required, as a rule. This is burnt in exactly the same manner as described in the above example. The temperature before and after the combustion is observed, and the calorific power of the fuel can then be calculated. Let the weight of fuel burnt be 1 gram, the weight of water in the calorimeter 2,000 grams, the water equivalent of the apparatus 210 grams, and the rise in temperature  $3.00^{\circ}$  C. The calorific power of the fuel is

$$C.P = 2,210 \times 3 = 6,630 \text{ calories}$$

$$\text{or} \quad 2,210 \times 3 \times \frac{9}{5} = 11,934 \text{ B.T.U.}$$

### *The Rosenhain Calorimeter.*

The Rosenhain calorimeter is an improved Thomson calorimeter. This calorimeter is illustrated in Fig. 12, and is designed for use with either solid or liquid fuels. If liquid fuels are used, standardised absorption pellets are employed, which are soaked in the liquid fuel and then burnt. Solid fuels are burnt in a

similar way to that described above. The fuse is dispensed with, an electrical ignition being employed instead. The advantages claimed are:—

*Accuracy.*—Complete combustion is secured; less than  $\frac{1}{2}$  per cent. of the sample escapes combustion, and if combustion is properly regulated no carbon monoxide is formed. Oils can be

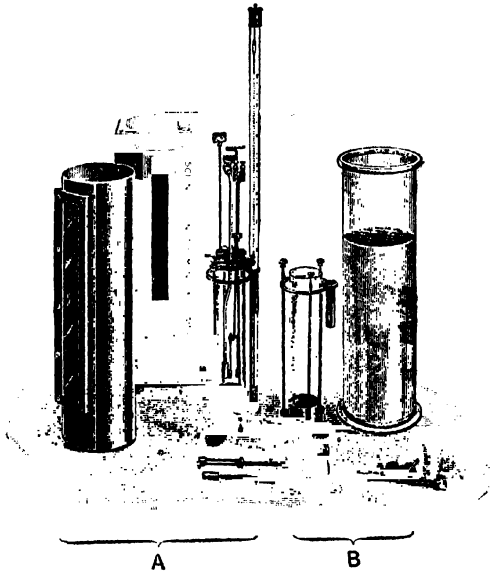

FIG. 12.—Rosenhain's Calorimeter.

burnt rapidly and completely with the standardised pellets, thus avoiding risk of oil remaining unburnt.

*Quickness.*—2 grams of coal of average quality can be burnt in ten minutes, the complete determination of the calorific power occupying half-an-hour.

*Safety.*—Risk of breakage is small, and no part of the apparatus is exposed to high pressures.

*Ease of observation.*—The progress of combustion can easily be watched, and its behaviour as regards caking or clinkering can be observed.

## 62 AN INTRODUCTION TO THE STUDY OF FUEL

*No stirring required*, as the water is sufficiently agitated by the passage of the gas through it.

*Small cost of each experiment.*—A relatively small quantity of oxygen is required, and the glass parts of the combustion chamber can readily be replaced by an incandescent gaslight chimney when broken.

The instrument is standardised by means of briquettes of standard coal, the calorific power of which has been accurately determined. The standardised absorption pellets, referred to above, for testing the calorific power of oils, absorb a considerable bulk of liquid, and burn completely and rapidly, leaving no residue. The calorific value of the pellets has been previously determined, and is subtracted from the total calorific power obtained as the result of the experiment.

The two latter calorimeters give excellent results, and the quality of fuel supplies can readily be checked by means of them, and the uniformity and suitability of the fuel can be judged.

### *F. Fischer's Calorimeter.*

F. Fischer's calorimeter is shown in Fig. 13, and is also designed for combustion with oxygen at atmospheric pressure. It consists of a strong silver combustion chamber (*a*), into which a platinum tube (*b*) is fitted by means of a piece of rubber tubing, and which reaches into the platinum crucible (*c*), which contains the fuel under test. The products make their escape through the tube (*d*). The platinum crucible is covered with a piece of platinum gauze, which collects any soot formed during the experiment. This soot is finally burnt there by the heat of the burning fuel. The calorimeter vessel is capable of containing 1,500 to 2,000 grams of water, and is well lagged with cotton wool, and fitted into a wooden case to reduce the loss of heat by radiation to a minimum. There are two thermometers, one (*f*) for measuring the temperature of the water, the other (*l*) for measuring the temperature of the escaping products of combustion. The combustion is started by dropping a fragment of glowing tinder or fuse through the tube (*b*) on to the finely-powdered fuel contained in the platinum crucible, the cap (*h*)



being quickly removed and replaced. The water is kept well stirred during the experiment by means of the stirrer (*s*); which can be worked by a small motor.

This form of apparatus is considerably more costly than the others described above, and for technical work presents no advantages.

*The Bomb Calorimeter.*

The Bomb calorimeter was first introduced by Berthelot, and was used by him for determining the heat of combustion of organic compounds. This calorimeter was modified by Mahler, who adapted it for general use. Further improvements and modifications were made by Cook, and in its present form it has proved very successful in the hands of both chemists and engineers for the control of fuel supplies.

It may be used for determining heats of combustion with sufficient accuracy to enable the heat balance sheet of a boiler or furnace to be drawn up. This form of calorimeter differs from the preceding ones in many ways, the combustion being

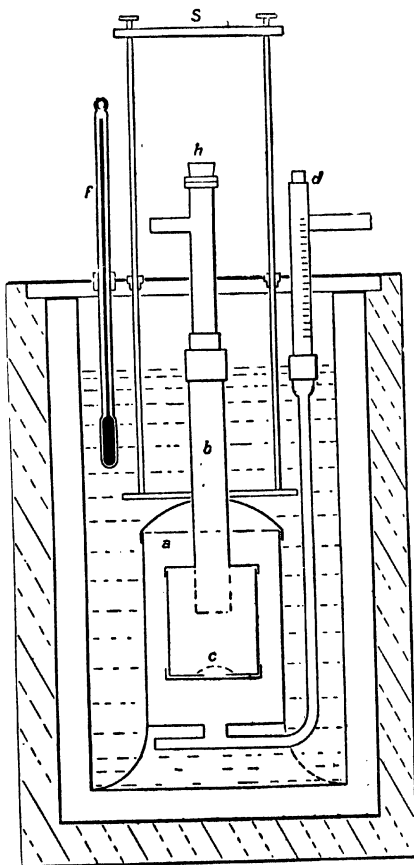

FIG. 13.—F. Fischer's Calorimeter.

carried out in a closed vessel at constant volume, and under considerable pressure. The oxygen is supplied from a cylinder of compressed gas, and the bomb is filled with oxygen under a pressure of 20 to 25 atmospheres before the combustion is started. A second form of bomb calorimeter is Parr's calorimeter, in which the coal is burnt by the oxygen of sodium peroxide  $\text{Na}_2\text{O}_2$ , the coal being finely powdered and mixed with the sodium peroxide.

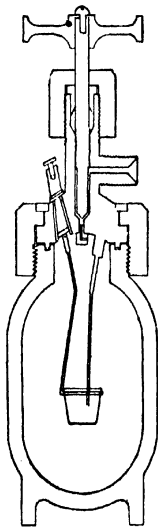

FIG. 14.—Bomb. Calorimeter section.

*The Berthelot-Mahler-Cook Bomb Calorimeter.*

The bomb as now made consists of an oval vessel of about 650 c.c. capacity. This vessel is made of mild forged steel, enamelled on the inside to prevent corrosion of the steel by the products of combustion, and especially by the small quantity of nitric acid formed during the experiment. It is heavily nickel-plated on the outside, to prevent rusting by the water of the calorimeter. The bomb is closed by a cover, which carries the valve through which the oxygen is introduced, and two terminals, one of which is insulated from the cover, for electrically igniting the fuel. This cover is thickly gilt on the inside and is connected to the bomb by a powerful hexagon nut and special spigot joint. The cover is made gas-tight by means of a lead washer. The two terminals are connected with two stout platinum wires, which serve for supporting the platinum crucible in which the fuel is burnt and for the support of the ignition wire (Fig. 14).

The calorimetric vessel consists of a double-walled insulating vessel, covered on the outside with a thick layer of felt to reduce radiation, and is surmounted by a framework holding the pulley for the stirring gear. The whole is covered completely by a lid. The water is contained in a copper vessel capable of containing about 3,500 c.c., and this is placed inside the above (Fig. 15).

The determination of the heat combustion of a fuel or other material is made in the following way:—

The bomb is carefully and thoroughly cleaned and dried, and the platinum crucible fixed firmly in the end of the thick platinum wire, and about 1 gram of the material, in the form of small cylinders made by compressing the finely-powdered material in a press, is accurately weighed and placed in the crucible. A coil of ignition wire, either iron or, preferably, platinum, is made by winding the wire round a thin glass rod, and is fixed to the two

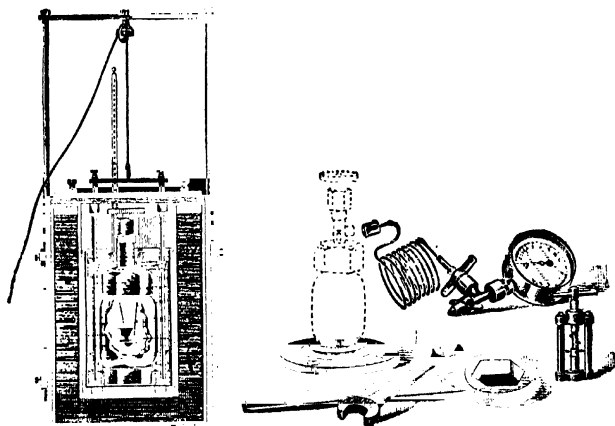

FIG. 15.—Bomb Calorimeter Outfit.

platinum wires and carefully arranged so that it comes into actual contact with the material to be ignited and burnt. The cover is then carefully placed on the bomb and the hexagon nut tightened up by a spanner provided for the purpose. Before placing the cover in position, the lead washer should be carefully trimmed of projecting pieces resulting from frequent compressions, and any grit or dirt removed. If this is not attended to, it is practically impossible to get a gas-tight connection. During the screwing up of the nut, the bomb is held in position in a cast-iron hexagon foot screwed to a bench, into which the base of the bomb fits.

The bomb is then connected to a pressure gauge and the

oxygen cylinder by means of a cone and nut. The valve on the bomb is closed and the valve on the oxygen cylinder slowly opened until the gauge shows that gas is being emitted from the cylinder; the bomb valve is then gradually opened so as to admit the gas into the bomb. Care must be taken that the gas does not rush into the bomb or some of the fuel will be blown out of the platinum crucible and the experiment spoiled through the material escaping combustion.

The pressure in the bomb is allowed to rise to 20 or 25 atmospheres and the cylinder valve closed. If the apparatus is gas-tight the pressure of the gas will remain constant. If on the other hand a slight leak is observed the various connections must be tightened in turn until the apparatus is practically gas-tight.

The calorimeter must be prepared before the experiment, and the temperature of the water allowed to become the same as that of the room in which the experiment is carried out. The outer vessel is filled with water and a quantity of water is accurately measured, or weighed, into the calorimeter vessel—about 2,500 grams are usually sufficient to cover the bomb and the hexagon nut. The quantity of water is kept constant in the preliminary experiments of calibration, and in all subsequent determinations of calorific power. The thermometer is next placed in position and the terminals connected with a battery, or to the electric light mains with a lamp (16 or 32 c.p.) and a switch or plug key in circuit, and the bomb then immersed in the water, the cover and stirring gear placed in their respective places, and the bomb allowed to gain the temperature of the water. After a few minutes the stirring gear is set in action and the thermometer read at half-minute intervals, so as to accurately determine the temperature before the experiment. The time is noted and the charge is fired by momentarily switching on the current which fuses the ignition wire and ignites the charge. Stirring is resumed and half-minute readings of the thermometer taken. The temperature will rise rapidly, attain a maximum value, and then slowly fall. When the fall has become quite regular the readings are stopped and the experiment is complete. The "corrected temperature" before firing

and the "corrected rise" must now be determined. They can be obtained either graphically by plotting time against temperature and extrapolating, or by use of the Regnault-Stohmann-Pfaundler formula. In order to make this method clear an example taken from "Jüptner, Lehrbuch der Chemischen Technologie der Energien," will now be given.

The heat of combustion of a fuel was determined in a bomb calorimeter, and the following data were obtained:—

Weight of water in calorimeter . . .	2,100 grams
Water equivalent of calorimeter . . .	340 „
Total weight of water . . .	2,440 „
Weight of coal cylinder. . . . .	1.0772 grams
Weight of ignition iron wire . . . . .	0.0187 gram

## THERMOMETER READINGS.

No.	Preliminary Experiment.		Main Experiment.		After Experiment.	
	Readings.	Difference.	Readings.	Difference.	Readings.	Difference.
	$t =$	$t =$	$t_n =$	$t_n =$	$t_n =$	$t_1$
1	18.750	+	18.759	18.759	21.744	—
2	18.753	0.003	19.170		21.742	0.002
3	18.753	0.000	20.530		21.739	0.003
4	18.756	0.003	21.240		21.729	0.010
5	18.756	0.000	21.590		21.720	0.009
6	18.757	0.001	21.723		21.713	0.007
7	18.758	0.001	21.749	21.749	21.707	0.006
8	18.758	0.000	Difference	2.990	21.704	0.003
9	18.759	0.001				
10	18.759	0.000				
Sum. .	187.559	0.009			173.798	0.040
Mean .	18.756	0.001			21.725	0.005

68 AN INTRODUCTION TO THE STUDY OF FUEL

The water in the calorimeter rose 2.990° C. The correction for temperature can be made by aid of the Regnault-Stohmann-Pfaundler formula.

$$\text{Correction}^\circ = \frac{r - r^1}{t_a - t} \left( \frac{t_2 - t_1}{9} + \frac{t_1 + t_n}{2} + \Sigma_1(t)^1 - nt \right) - (n - 1) v$$

where

$v$  = Mean temperature difference before firing.

$t$  = Mean temperature reading before firing.

$t_1, t_2 \dots t_n$  = Temperature readings in main series after firing.

$r^1$  = Mean temperature difference in after experiment.

$t_a$  = Mean temperature readings in after experiment.

$n$  = Number of readings in main series.

In the above example

$$v - v^1 = 0.001 + 0.005 = 0.006^\circ$$

$$t^1 - t = 21.725 - 18.756 = 2.969^\circ$$

$$\frac{t_2 - t_1}{9} = \frac{0.411}{9} = 0.046^\circ$$

$$\frac{t_1 + t_n}{2} = \frac{40.488}{2} = 20.244^\circ$$

$$\Sigma_1(t)^1 = 123.012^\circ$$

$$nt = 7 \times 18.756 = 131.292^\circ$$

$$(n - 1) v = 6 \times 0.001 = 0.006^\circ$$

Hence the temperature correction becomes:

$$\text{Correction}^\circ = \frac{0.006}{2.969} (0.046 + 20.244 + 123.012 - 131.292) - 0.006 = + 0.012^\circ$$

Corrected temperature rise is therefore

The cor

$$2.990 + 0.012 = 3.002^\circ$$

in the calorimeter is

Heat evolved  $0.2 \times 2,440 = 7,924.8$  calories.

3.0

Loss of the iron wire contributed 29.92

To this the comb

calories, and this must be subtracted from the above value and the calorific power of the fuel is then calculated.

$$\frac{7,324.8 - 29.92}{1.0772} = 6,772 \text{ calories.}$$

This value is too high, owing to a small quantity of nitric acid formed partly from the nitrogen in the fuel and partly from the nitrogen contained in the oxygen used. As a mean value 8 calories have been found, and this must be subtracted—

$$\frac{(7,324.8 - 29.92 - 8.00)}{1.0772} = 6,764 \text{ calories.}$$

This is a maximum value for the calorific power as it represents the available heat of combustion of the coal together with the heat of the condensation of the water present in the coal, both as moisture, and as water formed in the process of combustion. In order to correct for this the bomb, after the experiment already described, is heated in an oil bath to a temperature of 105° to 110° C.; the water in the bomb is thereby vaporised and the gases are allowed to slowly escape through a weighed U tube containing fused calcium chloride, which absorbs the water. The gain in weight of the U tube denotes the weight of water condensed. In the above example 0.5436 gram of water was collected, and from this 0.025 gram came from the compressed oxygen used and the remainder 0.5186 gram from the moisture contained in the coal and from the combustion of the hydrogen of the fuel. This amount of water is equal in weight to 48 per cent. of the fuel burnt.

The latent heat of vaporisation is

$$0.48 \times 600 = 288 \text{ calories,}$$

and hence the available heat of combustion or minimum value of the calorific power is :

$$6,764 - 288 = 6,476 \text{ calories.}$$

It is better, however, to determine the calorific power upon the dried sample of coal and to determine the hydrogen present in the fuel by combustion in the way previously described. In

ordinary practice it is sufficient to determine the upper limit and to neglect the correction for the water formed.

The determination of the water equivalent of the calorimeter is made in the way described previously, using a substance of accurately known heat of combustion, such as naphthaline  $C_{10}H_8$ .

*Calorimeter of S. W. Parr.*

Another form of calorimeter for determination of the calorific value of fuels is that due to S. W. Parr. In this calorimeter, as in the bomb, combustion takes place in an enclosed space, but the oxygen required is supplied by sodium peroxide. The oxygen is thus supplied in solid form, and the products of combustion are absorbed by the sodium oxide left after combustion. In this way high pressures are avoided, hence there is no necessity for an expensive bomb. The apparatus is shown in Fig. 16. The calorimeter proper consists of a nickel-plated copper vessel A, of about 2 litres capacity, which is placed in a wooden vessel C, which in turn is placed in another wooden vessel B. These two wooden vessels are closed by lids and form a very efficient heat insulator to the calorimeter, enabling the temperature of the water in the calorimeter to be maintained constant to within  $\frac{1}{1000}^{\circ}C$ . The reaction vessel D is a strong, nickel-plated brass cylinder of 35 c.c. capacity, closed at the top and bottom by screw caps and washers. The bottom cap J rests upon a conical bearing F, and the upper cap carries a tube H, which reaches through the lids of the calorimeter jackets B and C, and is fitted with a pulley P. Four vanes are fitted upon D, and the whole is rapidly revolved by means of a suitable motor—about 150 revolutions per minute are suitable for most purposes and sufficient to keep the temperature constant inside the calorimeter. The reaction vessel or patrone, which is shown in detail in Fig. 17, is fitted with a second tube inside the tube H, and this narrow tube ends below in the conical valve R. A spring K closes this valve until released by a pressure at N. The lids of the calorimeter are pierced by another hole through which a thermometer graduated in  $\frac{1}{10}^{\circ}$ , or, better, in  $\frac{1}{100}^{\circ}$ , passes. The thermometer has a range of from  $15^{\circ}$  to  $26^{\circ}$ , and is about 33 to 40 cm. long.



The method of using the calorimeter is as follows:—  
The calorimeter double vessels C and B are placed upon a solid

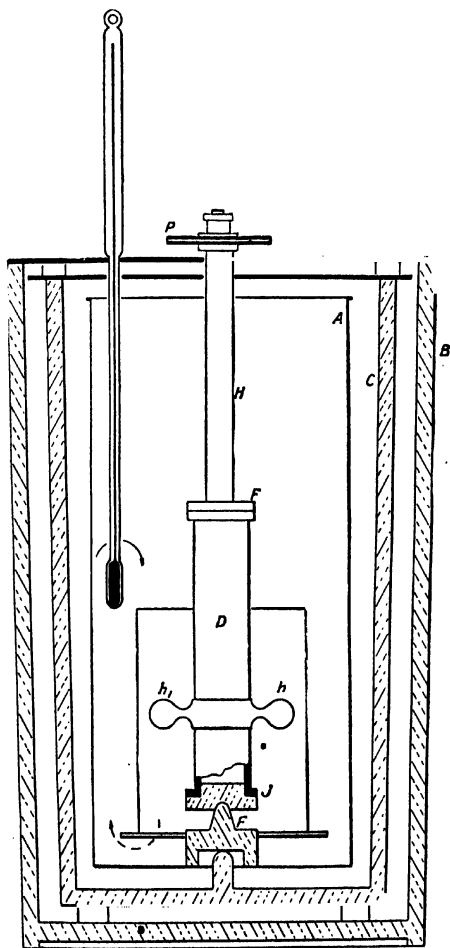

FIG. 16.—S. W. Parr's Calorimeter.

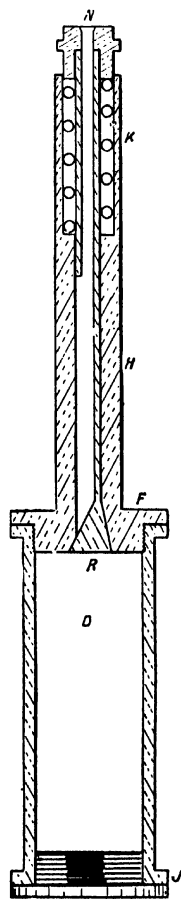

FIG. 17.—"Patrone" Parr's Calorimeter.

table, and the calorimeter vessel A is filled with exactly 2 litres of water, carefully dried externally, and then placed in position

## 72 AN INTRODUCTION TO THE STUDY OF FUEL

in C. The temperature should be about  $2^{\circ}$  below the room temperature. The reaction vessel has in the meantime been thoroughly dried on a sand bath, and the lower end tightly closed by the lid J. About 10 grams of finely-powdered, sieved, sodium peroxide is placed in the vessel D, and 0.5 to 1.0 grams of the fuel accurately weighed out is added to the sodium peroxide, and the two intimately mixed by shaking after screwing on the upper lid. The reaction vessel is then tapped so as to cause the material to collect together at the bottom, and the valve is tested in order to ensure its easy working. The paddles,  $h_1 h$  are fixed on to D, and the whole is placed in position in A. The lids are then put on, the pulley P fixed, the thermometer placed in position, and the stirring commenced. The stirring is continued until the calorimeter water has a constant temperature, about 3 to 4 minutes are required, and then the temperature is observed and noted. The stirring gear is kept going throughout the experiment. The fuel is fired by means of a piece of iron wire, which is grasped by a pair of iron forceps, heated to a good red heat in a Bunsen flame, and then dropped into D by pressing with the forceps at N and releasing the hold on the wire simultaneously. The iron falls into D through R, and in a few seconds the reaction is started. The thermometer rises, at first rapidly, then more slowly, and the experiment is complete in about five minutes. After the experiment, the motor is stopped, the apparatus taken apart and the cylinder D placed in a porcelain dish containing water, whereby its contents are dissolved with considerable evolution of heat. The solution is neutralised with hydrochloric acid, and it can then be ascertained whether or not the experiment has miscarried; the presence of unburnt particles of coal renders the experiment valueless. After thorough washing, the vessel D is dried so as to be ready for subsequent use.

It has been shown by many experiments that 73 per cent. of the total heat evolved in the experiment is generated by the combustion of the fuel and 27 per cent. by the reaction of the products of combustion with the  $Na_2O_2$  and  $Na_2O$ .

If  $g$  grams of fuel were burnt, and if  $W$  be the weight of water in the calorimeter and  $w$  the water equivalent of the apparatus,

$t_1$  and  $t_2$  the initial and final temperatures, then the number of calories evolved per gram of fuel are

$$\frac{0.73}{g} (W + w_1) (t_2 - t_1) \text{ calories.}$$

A correction must be introduced on account of the iron used for ignition. Suppose the iron used weighed 0.5 gram and suppose that this was heated to 750° C., then

$$0.5 \times 750 \times 0.12 = 45.0 \text{ calories}$$

were added to the calorimeter. Now suppose that the sum  $(W + w_1) = 2,250$  grams, then 45 cal. would account for a temperature rise of

$$\begin{aligned} 2,250 (t_2 - t_1) &= 45 \\ &= 0.02^\circ \end{aligned}$$

hence 0.02° must be subtracted from the total rise of temperature before the calorific power per gram of fuel is calculated.

The calorific power of the fuel would be

$$\frac{0.73 \times 2,250}{g} (t_2 - t_1 - 0.02^\circ) \text{ calories.}$$

Lignites can be burnt directly as above after drying at 105° to 110° C., about 1 gram being taken for each experiment.

Hard coal, 0.5 gram, is mixed with 0.5 gram of tartaric acid, and when these quantities and 0.4 gram iron at 700° C. have been used, 0.85° must be subtracted from the observed temperature rise.

Anthracite is mixed with 0.5 gram tartaric acid and 1.0 gram potassium persulphate previous to combustion. The 0.4 gram iron and the 1.0 gram of persulphate account for a rise of 0.155°, and the tartaric acid and 0.4 gram of iron as above a rise of 0.85°. As only one piece of iron is used, the correction is for 0.5 gram tartaric acid + 1.0 gram persulphate + 0.4 gram iron—

$$0.85 + 0.155 - 0.015 = 0.99^\circ.$$

The peroxide used in these experiments must be carefully protected from moisture as it is decomposed by water,

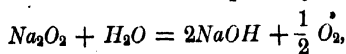

and also because the results obtained will be too high if much moisture is present. The peroxide is best kept in small tins closed by tightly-fitting lids, containing 50 to 100 grams each.

The greatest care must be exercised in bringing water into contact with any unburnt mixture of coal and sodium peroxide, owing to the risk of a reaction taking place with almost explosive violence.

The results obtained with the Parr calorimeter agree very well with those obtained in the bomb calorimeter, as a large series of experiments made by Lunge and Parr have shown.

#### *Calorific Power of a Gas.*

The calorific power of a gas can be calculated from a knowledge of its composition and the calorific power of each constituent. It is better, however, to measure its heating power directly in a suitable form of gas calorimeter. Two gas calorimeters, the Junker type and the Boys' type, will now be described.

#### *The Junker Calorimeter.*

The Junker calorimeter consists of an upright tubular vessel (Fig. 18). The gas is burnt by a large Bunsen burner and the products of combustion pass through the wide tube *a*, and down through the annular spaces *b* into the collecting box *c* finally escaping through *d* into the open air. Water is kept circulating through the jacket which surrounds the heating chamber of the calorimeter. The water is supplied under a constant head by means of the constant level apparatus *h*. The quantity of water flowing through the calorimeter is regulated by a fine tap *i*, and its temperature is measured by the thermometer *k*. The water flows through the apparatus and finds its way out through the number of baffle plates *m*, which serve to mix the water, so that the temperature measured by the thermometer *q* may be the correct temperature of the water, and thence through *z* where it is collected in a suitable measuring vessel.

The method of making a measurement of the calorific power of a gas is as follows: The apparatus is set in such a position that the two thermometers *k* and *q* can easily be read. The gasometer is also set in a position where it can readily be observed.

The constant level apparatus is connected to the water mains at *e*, and so arranged that the flow of water can be seen during the

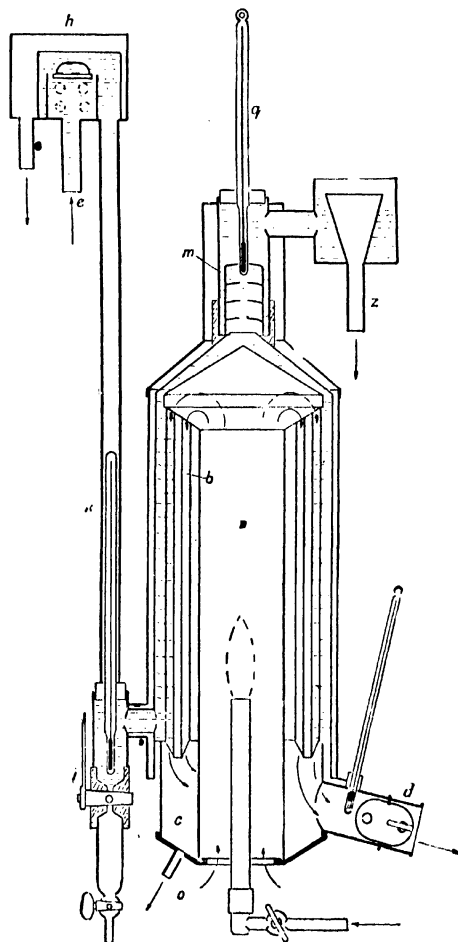

FIG. 18.—Junker Calorimeter.

experiment. A piece of rubber tubing is attached to *z* so that the water flowing from the calorimeter can be collected in a suitable

## 76 AN INTRODUCTION TO THE STUDY OF FUEL

vessel and no loss results from splashing. The apparatus is then tested to make sure that it is quite watertight. This is done by turning the water on, opening the tap *i*, and so allowing a good stream of water to flow through the apparatus and out at *z*. When the calorimeter is watertight no water escapes at *o*. The Bunsen burner is connected by a rubber tube to the gas supply, and according as the calorific power of the gas is high or low, a large or small jet is used. The Bunsen tap is then closed and the gas turned on, and if there is no leak of gas, the pointer of the gasometer remains stationary. The water is then turned on so that the overflow *e* works regularly and a steady stream of water escapes from *z*. Then, and not before, the lighted burner is introduced into the calorimeter. The burner is placed so that the end reaches to about 15 cm. into the calorimeter. By means of the butterfly valve *d* the excess of air used in the experiment is regulated; usually this is half or full open, as exact regulation is seldom necessary. A short time after the introduction of the burner the temperature of the outflowing water reaches a constant value. By means of the tap *i* the flow of water is so regulated that a difference of 10° to 20° C. between the in and out flow water, is maintained. The pointer of the gasometer is then observed, and as soon as it reaches zero the rubber tube connected to *z* is quickly moved into a graduated cylinder and the outflowing water is collected until the pointer indicates that a certain definite volume of gas has been burnt. The collection of the water, is then stopped by removing the rubber tube from the glass cylinder. During the collection of the water the thermometer *q* is observed at regular intervals, so as to obtain the mean temperature of the water flowing from the calorimeter. The volume of the water is finally measured and noted. Any water formed during the combustion of the gas condenses in the calorimeter and flows out at *o*, where it is collected in a small graduated cylinder. This is necessary when the lower limit of the calorific power is required.

The calorific power of the gas can now be calculated. Let  $C$  be the heat value of the gas, expressed in calories per litre of gas burnt; let  $t_1$  and  $t_2$  be the temperatures of the inflow and outflow water respectively, and suppose  $Vcc$  of

water to have been collected, the volume of gas burnt is  $M$  litres, then :

$$C = \frac{V(t_2 - t_1)}{M} \text{ calories per litre.}$$

*The Boys' Calorimeter.*

In the Boys' gas calorimeter a much smaller vessel is used which contains only about 300 c.c. against 2,000 c.c. in the Junker. The Boys' calorimeter is shown in Fig. 19. The two thermometers are in the same level. The water passes in at T, flowing through the copper spiral up to K, where it is mixed, and finally out at P. The water formed in the combustion of the gas condenses inside the calorimeter, flows out at O and is collected in a small graduated cylinder as above described. This is used for calculating the minimum or practical calorific power. This is of importance in all cases where the products of combustion escape at a temperature higher than 65° C., which is the case with most explosion engines, gas motors, etc. In the case of illuminating

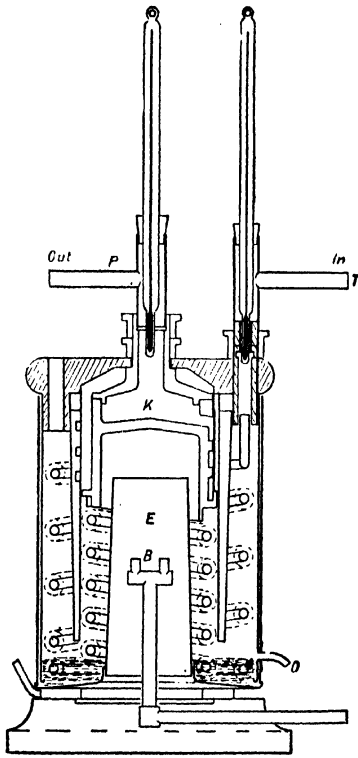

FIG. 19.—Boys' Calorimeter.

- gas the lower calorific power is about 10 per cent. less than the upper.

Other forms of gas calorimeters are the Simmance-Abady, and the Fischer; for a description of these larger works must be consulted.

In addition to these calorimetric methods of determining the heat value of fuels there is another method, namely, a practical test with an experimental steam boiler, in which the quantity of fuel burnt and the weight of water evaporated are measured and the quantity of ash obtained. For a complete test of the fuel it would be necessary to determine the composition of the products of combustion and their temperature, and to know the ultimate composition of the fuel as well as the above details. The practical test is probably the best way of obtaining the heating value of a fuel, but it has the disadvantage of requiring a large quantity of fuel.

On the other hand, if the sampling is carefully done, the determination of moisture, ash, volatile matter, coke, and calorific power by the methods described in this chapter forms a ready check on the quality of the fuel supply, and enables the chemist and engineer to judge as to the performances of the furnaces. Coupled with the analyses of the flue gases, interesting information can be obtained as to the way in which the firing of the furnaces is being carried on, and whether or not this is giving rise to undue consumption and waste of fuel.

In all determinations of calorific value, it must not be forgotten that the heat of combustion changes with both the pressure and temperature at which the combustion takes place. If the calorific value of a fuel has been determined in a bomb calorimeter (combustion at constant volume), and it is required to use the results for practical purposes where the combustion takes place at constant pressure, it will be necessary to introduce a correction.

*Relation Between Heat of Combustion at Constant Pressure and at Constant Volume.*

The heat of combustion at constant pressure is greater than at constant volume. The gas expands owing to the heat of combustion, which warms the gas; when cooling the volume again contracts, and the final volume is smaller than the initial



volume if the combustion has taken place in such a way that there is a diminution in the number of molecules. Thus, in the case of hydrogen and oxygen

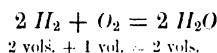

*i.e.*, the final volume is two-thirds of the initial volume; the contraction is, therefore, one-third of the initial volume—

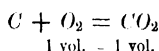

*i.e.*, there is no contraction.

If, on the other hand, carbon is burnt to carbon monoxide the volume is doubled:—

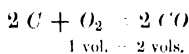

Now suppose, in the case of hydrogen, that the combustion takes place in an air-tight cylinder closed by a frictionless piston, and after the combustion is finished and the cylinder has attained the initial temperature, suppose that the piston be raised and the gas thereby expanded until the final volume is the same as the initial volume. A certain quantity of work has to be done in expanding the gas, and the work done is  $APV$  per molecule, where  $A$  is the mechanical equivalent of heat,  $P$  the pressure, and  $V$  the contraction in volume. Now, if the combustion takes place at constant volume, then the heat evolved,  $q$ , is:—

$$q = Q - APV.$$

where  $Q$  is the heat evolved at constant pressure.

Also from Boyle's Law,

$$PV = nRT,$$

where  $n$  is the number of molecules in the system,

$$R = \frac{P_0 V_0}{273} \text{ at a temperature of } 0^\circ \text{C}$$

where  $T = 273^\circ$  absolute, and  $n = 1$ .

Now  $P_0$ , *i.e.*, the pressure exerted on 1 gram molecular weight of any gas at 0° C. and 760 mm. of mercury.

$$= 1,033.3 \text{ grams per sq. cm.}$$

and  $V_0$ , *i.e.*, the volume of 1 gram molecular weight at 0° C.

$$= 22,420 \text{ cub. cms.}$$

$$\text{and } A = \frac{1}{42,800}$$

\* Substituting these values in the above equation,

$$\begin{aligned} q &= Q - n \frac{P_0 V_0}{273} T \\ &= Q - n \frac{1033.3 \times 22,420 \times 273}{273 \times 42,800} \\ &= Q - n 541.1 \text{ calories.} \end{aligned}$$

By means of this equation the results of heat of combustion determinations, made in the bomb calorimeter, can be converted into constant pressure results; thus, for example, in the case of the combustion of hydrogen.

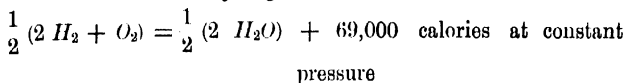

$$2 \text{ mols.} + 1 \text{ mol.} = 0 \text{ mol.}$$

The water is condensed to a liquid under the conditions of the experiment. The contraction per molecule of the substance burnt is 1.5 molecules, therefore the heat of combustion at constant volume becomes

$$\begin{aligned} q &= 69,000 - 1.5 \times 541.1 \text{ calories} \\ &= 69,000 - 812 \\ &= 68,188 \text{ calories.} \end{aligned}$$

Similarly for carbon monoxide

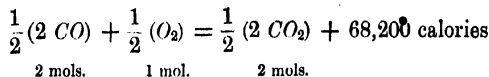

$$\therefore n = 0.5$$

and

$$q = 67,990 \text{ calories,}$$

and for marsh gas—

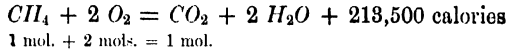

1 mol. + 2 mols. = 1 mol.

$$n = 2$$

whence  $q = 212,418$  calories.

In the above examples the water formed is condensed, hence the values for the heating effect are the upper limit; the lower limit can be obtained by subtracting the latent heat of vaporisation of water, 10,800 calories per molecule, from the above values.

## CHAPTER V

### MEASUREMENT OF HIGH TEMPERATURES—PYROMETRY

THE measurement of high temperatures is of the greatest importance in technical operations, both as a means of controlling such operations, and also as a means of checking fuel losses in furnaces. For instance, as already mentioned, a knowledge of the temperature of the flue gases is necessary in order to determine the amount of heat carried off by them up the chimney.

Technical pyrometry has been brought to a great degree of perfection, and many types of pyrometers are in use. For the present purpose, however, only those of importance for furnace control will be described.

Practically every property of matter which changes with temperature has, at one time or another, been utilised as a means of temperature measurement, but since many of these changes can only be accurately measured with great difficulty, especially at high temperatures, comparatively few have come into actual use. The principal pyrometers can be classified under six heads:—

(1) Expansion of a gas or of air; an example of this type of pyrometer is the gas thermometer, by means of which the gas scale of temperature is defined. All temperatures should be referred to the gas scale.<sup>1</sup>

(2) Thermo-electric pyrometers depending upon the current generated by heating the junction of two dissimilar metals. The current is measured by a suitable millivoltmeter.

(3) Resistance pyrometers, depending upon the change of resistance of a wire, usually platinum, with change of tempera-

<sup>1</sup> In the present discussion the mercury thermometer is not included, as the temperatures under consideration are higher than can be measured by its means. Modern mercury thermometers, especially those made of boro-silicate glass and filled with nitrogen under pressure, will register fairly high temperatures, *e.g.*, up to 500° C., but owing to their fragile nature other instruments are preferable.

ture. The change of resistance is measured by an instrument which is, in principle, a Wheatstone bridge.

(4) Radiation and optical pyrometers, depending upon the connection between the temperature and light emission of hot bodies.

(5) Calorimetric pyrometers, in which the heat is measured by means of the rise in temperature of a mass of water caused by immersing a piece of metal which has been brought into thermal equilibrium with the hot flue or furnace, in the water of the calorimeter. The metals used are platinum, nickel, iron or copper.

(6) Approximate methods, *e.g.*, by observation of the melting points of alloys previously standardised by one of the above methods, or of the softening points of Segar cones, the thermophone, and the measurement of the expansion of a porcelain metal or graphite rod or cylinder.

(1) *The Gas Thermometer.*

Owing to the great importance of the gas thermometer as a standard of temperature, this will be described first, although it is not used in general technical work.

The gas thermometer can be used to measure temperatures in two ways: (1) at constant pressure, (2) at constant volume. It consists in principle of a bulb of glass, porcelain or platinum according to the temperature to be measured, connected by a capillary tube to a pressure gauge. When used as a constant volume instrument the pressure required to maintain the volume constant is measured. When used as a constant pressure instrument the change of volume with the temperature is observed.

This thermometer is based upon the laws of Boyle and Gay-Lussac. Suppose that a volume  $v$  of a perfect gas, containing  $n$  molecules is at a temperature (absolute)  $T$  and pressure  $p$ , then

$$pv = nRT \quad (1)$$

where  $R$  is the gas constant.

Now if the gas is brought to another temperature  $T_1$  and if the volume is still kept constant, the pressure must be altered to  $p_1$  so that

$$p_1v = nRT_1 \quad (2)$$

Substituting  $v = \frac{nRT}{p}$  from (1) in equation (2) the expression obtained is—

$$\frac{p_1}{p} = \frac{T_1}{T} \quad (3)$$

or, by subtracting unity from each side of the equation,

$$\frac{T_1 - T}{T} = \frac{p_1 - p}{p} \quad (4)$$

*i.e.*, the change of temperature can be measured by means of the change of pressure.

If on the other hand the temperature of the gas changes and the pressure  $p$  is kept constant, then the volume of the gas changes to  $v_1$  so that

$$pv_1 = nRT_1, \quad (5)$$

whence, substituting  $p = \frac{nRT}{v}$  in (5),

$$\text{then} \quad \frac{v_1}{v} = \frac{T_1}{T}$$

$$\text{or} \quad \frac{v_1 - v}{v} = \frac{T_1 - T}{T},$$

hence the change of temperature is measured by the change in volume.

The gas thermometer may be filled with air, nitrogen or hydrogen, and the zero determined by immersion in melting ice. For the range of temperature  $0^\circ$  to  $500^\circ$  C. glass bulbs can be used, but for higher temperatures bulbs made of porcelain and glazed inside and out, must be used. As a rule, measurements between  $0^\circ$  to  $100^\circ$  are made with a constant volume thermometer and above with a constant pressure instrument, filled in both cases with hydrogen gas. Since platinum is permeable to this gas at high temperatures, it cannot be used for making the thermometer bulbs. Porcelain thermometers have the disadvantage of being extremely easily broken, but they can be used at temperatures above  $1,000^\circ$  C. without danger of softening. Fig. 20 shows two simple forms of gas thermometers, and Fig. 21 is a diagrammatic sketch of Wiborgh's gas thermometer designed for technical work.

A large number of precautions must be taken when using a gas thermometer, and several sources of error must be carefully guarded against. For example, the capillary tube connecting the bulb with the measuring gauge must be as fine as possible, since the temperature of the gas in this portion is uncertain. Again, the expansion of the bulb at high temperatures must be

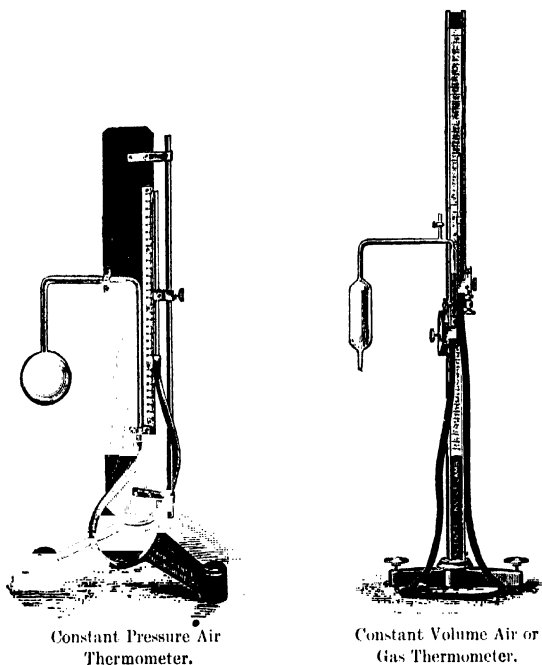

FIG. 20.

measured with the greatest accuracy possible, and this is a very difficult measurement to carry out. Also the readings of the gas thermometer can only be obtained as the result of elaborate calculations, and the process of carrying out even a single experiment is a lengthy one. This thermometer, therefore, though excellent as a standard of reference, is unsuitable for practical work. In technical work the pyrometers

in general use are either resistance, thermo-electric, or optical, pyrometers, and these are calibrated by means of standard substances, the melting or boiling points of which have been

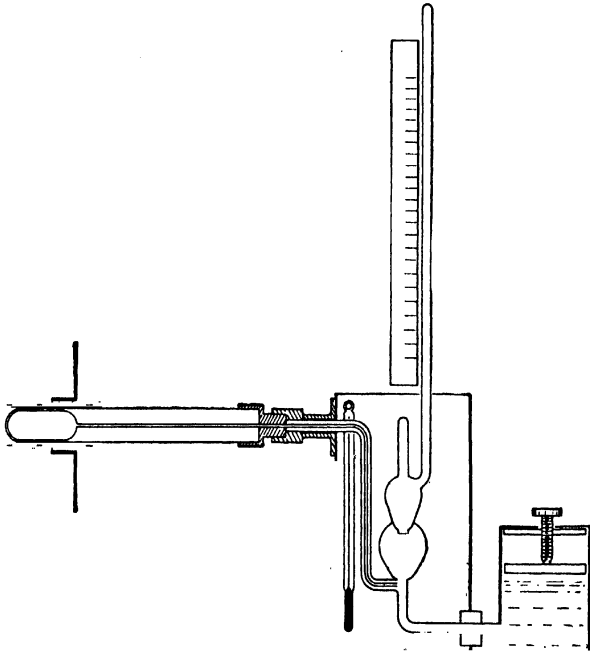

FIG. 21.—Wiborgh's Technical Form of Gas Thermometer.

determined with a satisfactory degree of accuracy on the gas thermometer scale.

(2) *Thermo-electric Pyrometers.*

This form of pyrometer was first introduced by the famous French scientist H. Le Chatelier. When a circuit is formed of wires of different metals, *e.g.*, iron and copper, twisted together at the two ends, and when one junction A is heated by a flame, and the other B is kept at the ordinary temperature, a current is produced so long as the temperature of A is below 550° C. Above



hat temperature the current flows in the reverse direction. Some other metals, however, do not exhibit the phenomenon of this reversal of the direction of the current, or thermo-electric inversion as it is called, and these metals are always used for instruments for practical use. Pairs of wires of this kind are known as "thermo-couples."

Thermo-couples should give a current which is proportional to the difference of temperature between the hot and cold junction, and as the cold junction is kept at a constant temperature, both during calibration and subsequent work, the strength of current varies with the temperature of the hot junction.

The E.M.F. of a thermo-element is most simply measured by a millivoltmeter or galvanometer, which can be calibrated so as to read directly in degrees Fahrenheit or Centigrade, or the galvanometer or millivoltmeter readings at several known temperatures can be determined and the results plotted on squared paper, and the unknown temperatures read off the curve.

The metals usually employed for thermo-electric pyrometers are (1) copper and constantan (copper 60 per cent., nickel 40 per cent.) for temperatures up to 500° C. and also for low temperatures; (2) platinum and platinum alloyed with 10 per cent. rhodium; (3) platinum and platinum with 10 per cent. iridium.

Now if  $E$  is the E.M.F. of a thermo-element in micro volts,<sup>1</sup>  $t$  the temperature of the hot junction in degrees Centigrade,  $A$  and  $B$  constants depending upon the wire used, then the relationship between temperature and E.M.F. produced when the cold junction is kept at 0° C. is

$$\log_{10} E = A \log_{10} t + B.$$

For copper-constantan the equation is approximately

$$\log_{10} E = 1.14 \log_{10} t + 1.34.$$

For platinum—platinum rhodium, approximately

$$\log_{10} E = 1.10 \log_{10} t + 0.89.$$

For platinum—platinum iridium, approximately

$$\log_{10} E = 1.19 \log_{10} t + 0.52.$$

<sup>1</sup> A micro volt is one millionth of a volt, i.e.,  $1 \times 10^{-6}$  volts.

88 AN INTRODUCTION TO THE STUDY OF FUEL

As a rule the makers of these instruments supply a table of constants for each instrument. Fig. 22 shows the general form of a thermo-electric pyrometer arranged for technical work. It

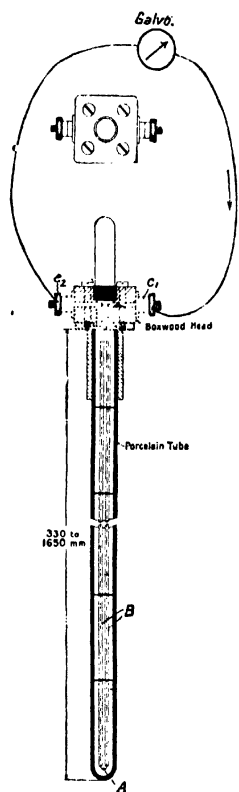

FIG. 22.—Thermo-electric Pyrometer.

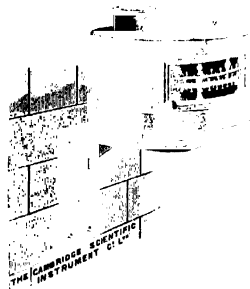

FIG. 23.—Millivoltmeter, Fixed Form.

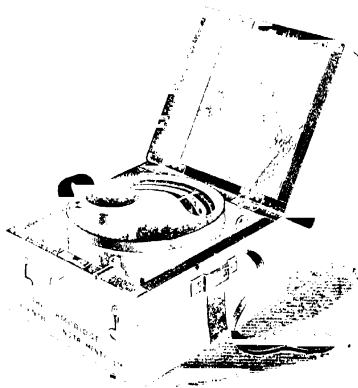

FIG. 24.—Millivoltmeter, Portable Form.

consists of two wires which are soldered together at A. They are separated by passing through the unglazed porcelain tubes B and terminate at C<sub>1</sub> and C<sub>2</sub> where they are joined to two brass terminals supported by a boxwood head. The lower portion is

again protected by a glazed porcelain tube, which in turn can be placed inside of an iron tube. The length of the instrument must be such that the junction  $C_1, C_2$  can be kept at constant temperature, or its temperature must be determined and the readings of the instrument itself corrected accordingly. The pyrometers are made from about 1 to 5 ft. long. The terminals  $C_1$  and  $C_2$  are connected by copper leads of low resistance

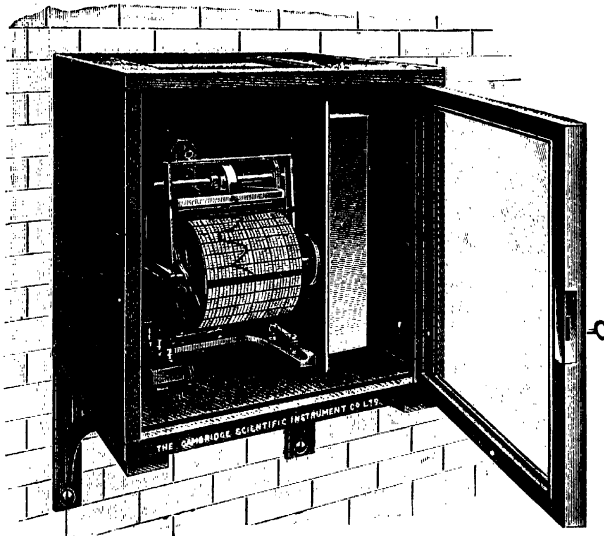

FIG. 25.—“Thread Recorder.”

to a suitable reading instrument such as a millivoltmeter, which can be either fixed in a suitable position or arranged to be portable (Figs. 23 and 24).

*Thermo-Electric Recording Pyrometers.*

The instruments can also be made to record the temperatures automatically and in this way the temperature readings can be obtained as a continuous curve. Such a recorder (made by the Cambridge Scientific Instrument Co.) is shown in Fig. 25, and is known as a “Thread Recorder.” The general appearance of this is shown in Fig. 25 and the salient features of the recording

90 AN INTRODUCTION TO THE STUDY OF FUEL

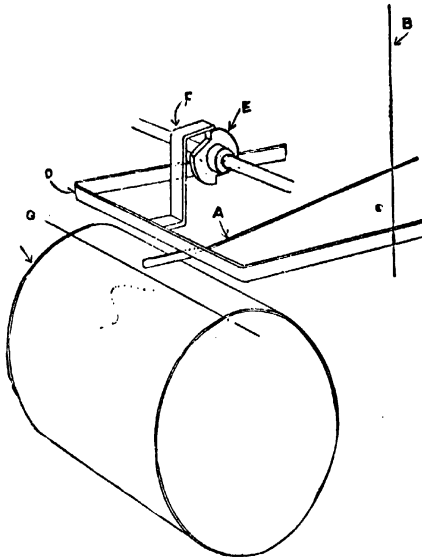
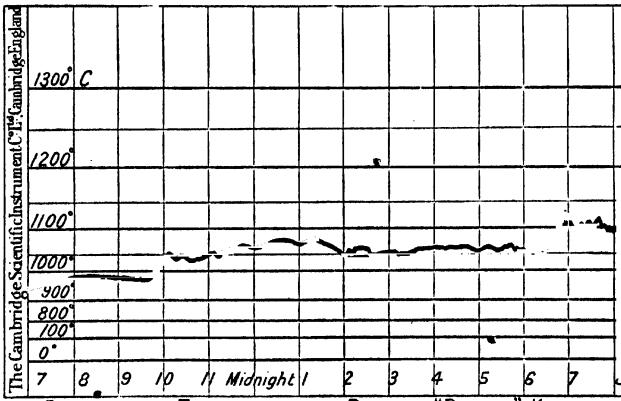

FIG. 26.—“Thread Recorder.” Recording Mechanism.



RECORD OF THE TEMPERATURE OF A POTTERY "BISCUIT" KILN, OBTAINED WITH A FÉRY RADIATION PYROMETER AND PATENT THREAD RECORDER

FIG. 27.

mechanism in Fig 26. The drum C carries the paper which is ruled with rectangular co-ordinates and is driven by clockwork. It can be regulated so as to revolve once in about two hours or once in twenty-five hours. The needle of the galvanometer A terminates in an ivory knife edge, and between this and the drum passes the inked thread G. Above the needle is the chopper bar D, which is depressed by the cam and arm E and F, which are worked by the clockwork driving the drum. This chopper bar descends and depresses the ivory knife edge on to the inked thread and so on to the paper, thereby making a small ink mark on the paper. At the same time the inked thread is moved along, so as to keep it thoroughly inked. The chopper bar can be depressed every minute or half-minute as desired, and as it carries a temperature scale, the instrument is direct reading as well as recording. The record obtained by this form of instrument is shown in Fig. 27. The thread recorder is a very convenient instrument for obtaining continuous records of furnace and flue temperatures and also for determining melting points of metals and alloys. The indications of the instrument can readily be checked from time to time by means of substances of known melting points or boiling points (see section on calibration).

The direct reading type requires no special skill to use, and can be placed in the hands of any intelligent workman, or the millivoltmeter with a temperature scale can be placed in a fixed position and used with a number of pyrometers, the pyrometers being connected with the millivoltmeter in turn, by means of a suitable switch.

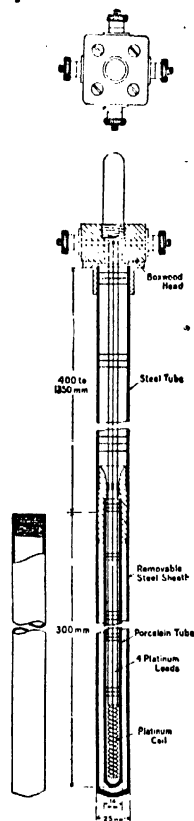

FIG. 28.—Resistance Pyrometer.

(3) *Resistance Pyrometers.*

This class of pyrometers depends upon the fact that the electrical resistance of metals, etc., varies with the temperature. The metal employed for these pyrometers is a coil of thin platinum wire, the resistance of which increases with rise of temperature.

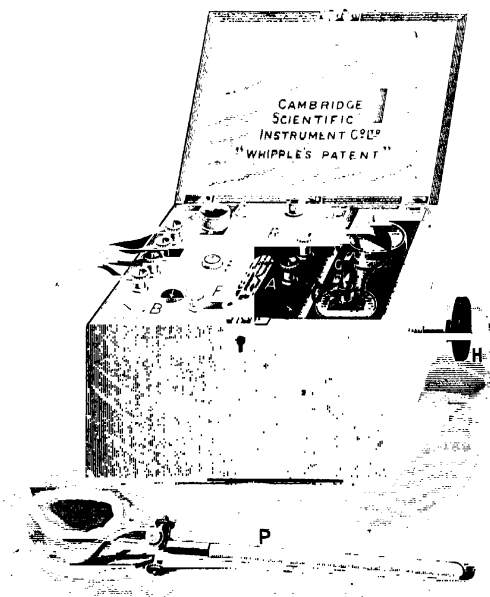

FIG. 29. "Whipple Patent Temperature Indicator."

In appearance the resistance pyrometers are similar to the thermo-electric pyrometers just described.

An instrument suitable for general work is shown in Fig. 28. It consists of a coil of fine platinum wire coiled upon mica supports. The coil is about 4 ins. in length, and is connected with platinum leads to the terminals at the top of the instrument, the terminals being carried by a hard wood head. An additional pair of leads are placed beside the first pair and connected to two other terminals on the head. In this way the error due to the

change of resistance of the leads with the temperature, is eliminated, so that the variation of resistance measured is only the variation of the pyrometer coil. The change of resistance is measured by some suitable form of Wheatstone bridge. A direct-reading instrument for use with this type of pyrometer is the "Whipple Patent Temperature Indicator," shown in Fig. 29. In order to take a reading the key F is depressed and the milled head H turned until the resistance of the indicator is equal to that of the pyrometer. This is shown by the galvanometer needle at B, which is not deflected when balance is obtained. The temperature is then read off in the scale A, in degrees Centigrade or Fahrenheit. The indicator is enclosed in a teak case, together with the battery necessary, and is provided with a strap for carrying about from place to place. The readings can be easily taken by any workman, no special electrical knowledge being necessary, and further, the indicator can be placed at a central station, and a number of pyrometers distributed over a large works, etc., can be read in turn, connection between pyrometers and indicator being made by means of a switch board.

*Recording Pyrometers (Resistance Type).*

One of the best known is due to Callendar, and is shown in Fig. 30. It is of the Wheatstone bridge type, and is adjusted for different ranges of temperature. The record is made by means of a travelling pen corresponding to the slider on a Wheatstone bridge, and the drum which carries the co-ordinate paper revolves once in 25 hours or once in 2 hours 5 minutes, the change being readily made by a simple speed gear. Such an instrument is fixed firmly in a position, best upon a stone bracket or pillar in a central office or station, and the pyrometers connected by suitable leads. The record can also be made to extend over one week, the readings being registered upon a continuous length of paper. The temperature scale can be varied by means of a number of coils; for example, suppose a recorder has a range of 500 Centigrade degrees, then by means of the auxiliary coils temperatures from 50° C. to 550° C., or from 0° C. to 500° C., or from 500° C. to 1,000° C., or

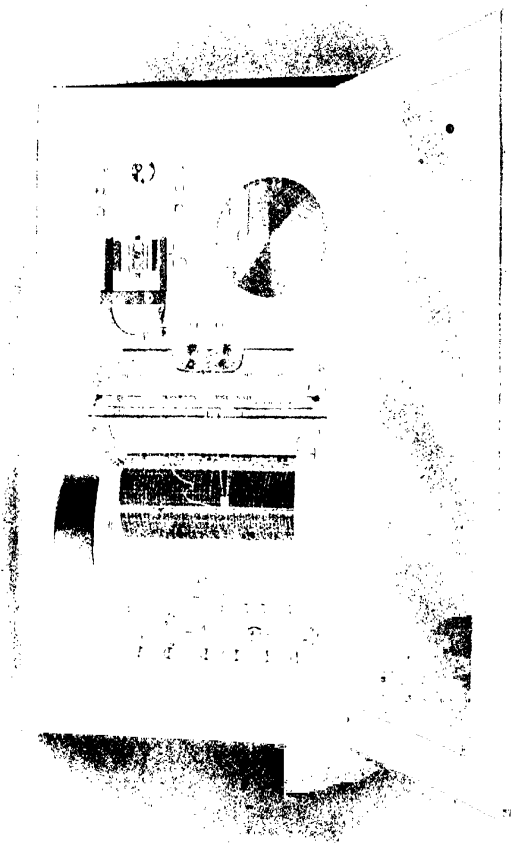

Fig. 30.—Calendar Recorder.



from 700° C. to 1,200° C. can be measured. The coils can readily be changed and the instrument so adjusted to give readings within the desired range.

The resistance pyrometers cannot work up to so high a temperature as the thermo-electric (1,200° C. (2,292° F.) against 1,600° C. (2,912° F.)). They are, however, more sensitive than the latter and respond very quickly to changes of temperature. Thermo-electric pyrometers require much less substance for a determination of, say, melting point, than the resistance thermometers, and are much less costly to replace, and they require no battery in their industrial form.

Both forms require calibration at intervals during their use, and the importance of checking pyrometric readings by means of standard substances (see below) cannot be over-estimated. The method of calibration is described later.

#### (4) *Optical Pyrometers.*

Many forms of optical pyrometers have been proposed employing different optical properties, which vary with the temperature, as a means of measuring high temperatures. In the pyrometers described above the sensitive part, bulb, thermo-junction, or resistance coil is brought into temperature equilibrium with the temperature to be measured, but in optical pyrometry, the pyrometers are entirely outside the heated space or furnace. There are four optical pyrometers which are now being used in technical work and which will be briefly described, viz., the Féry radiation pyrometer, the Féry absorption pyrometer, the Wanner pyrometer, and the Holborn and Kurlbaum pyrometer.

##### *Féry Radiation Pyrometer.*

The Féry radiation pyrometer is illustrated in Figs. 31 and 32, and consists of telescopic body fitted with an eyepiece O and concave mirror M. Inside the telescope, at a point on its optical axis, the junction of the copper constantan thermo-junction arranged in the form of a cross is fixed. This is connected to the brass strips R and D, which in turn are connected to the terminals *b* and *b'*. The radiations from the furnace or other hot body fall upon the concave mirror and are

brought to a focus. The mirror M is moved by means of the rack and pinion P until the thermo-junction is in this focus. The

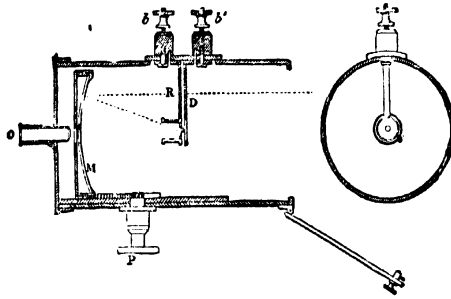

FIG. 31.—Fery Radiation Pyrometer.

radiations falling upon the thermo-junction raise its temperature, and the higher the temperature of the hot body the greater will be the rise of temperature of the couple. The terminals are connected by flexible leads to a specially calibrated galvanometer. The method of using this instrument for measuring

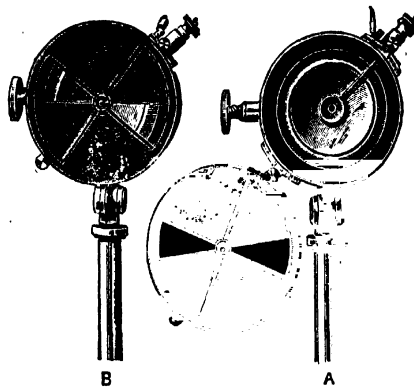

FIG. 32.—Fery Radiation Pyrometer.

furnace temperatures is as follows: The pyrometer is sighted through an observation hole cut in the wall of the furnace (Figs. 33 and 34), the image of this hole being brought into

coincidence with the thermo-junction. The thermo-junction appears as a black disc in the centre of the field of view, and it is essential that the image of the hole should overlap the thermo-junction. The image of the hole is reflected to the eyepiece O by two mirrors placed near to the couple, and these mirrors serve for the adjustment of the focus. If the focus is

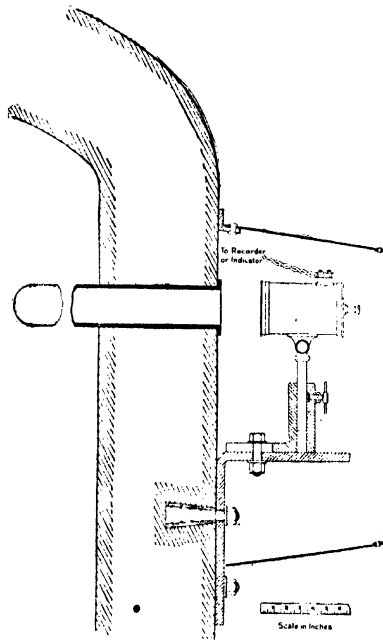

FIG. 33.—Pécory Radiation Pyrometer, Fixed in Position.

not correct, the image of the hole appears to be split into two parts, which coincide when the correct focus is obtained. By means of the adjustable diaphragm shown in Fig. 32 the amount of radiation falling upon the thermo-couple may be varied. When measuring very high temperatures the diaphragm partially covers the aperture of the telescope B, and the temperature is read upon a second scale on the galvanometer. The galvanometers are divided so as to read from about  $600^{\circ}\text{C}$  to

1,300° C. with open telescope, and from 1,000° C. to 2,000° C. by aid of the diaphragm. The galvanometers are divided into millivolts as well as degrees Centigrade. This instrument can be connected with a thread recorder (see p. 89, and Fig. 25), and so made into a temperature recorder.

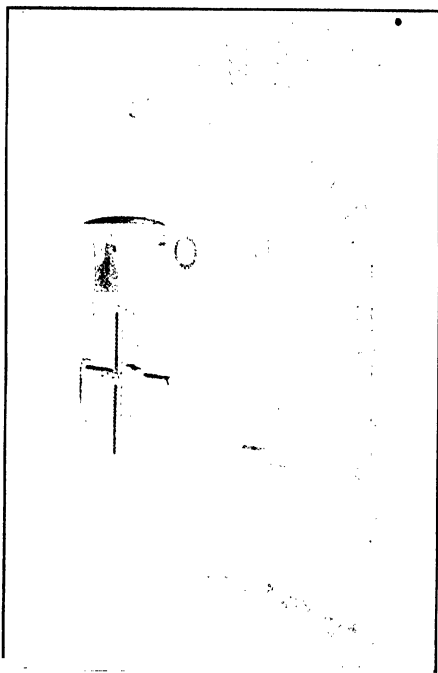

FIG. 34.—Féry Radiation Pyrometer, for taking Temperature of Pottery Kiln.

The Féry radiation pyrometer is specially useful for measuring higher temperatures than can be measured by electrical pyrometers similar to those previously described. (See frontispiece.) By means of this instrument the inventor, Professor Féry, measured the temperature of the sun and found it to be 7,800° C., and also of the iron in a thermite mould, which was found to be

2,500° C. As no part of the instrument comes into contact with the direct heat of the furnace or with the flue or other corrosive gases, it is free from the excessive wear and tear of other forms of

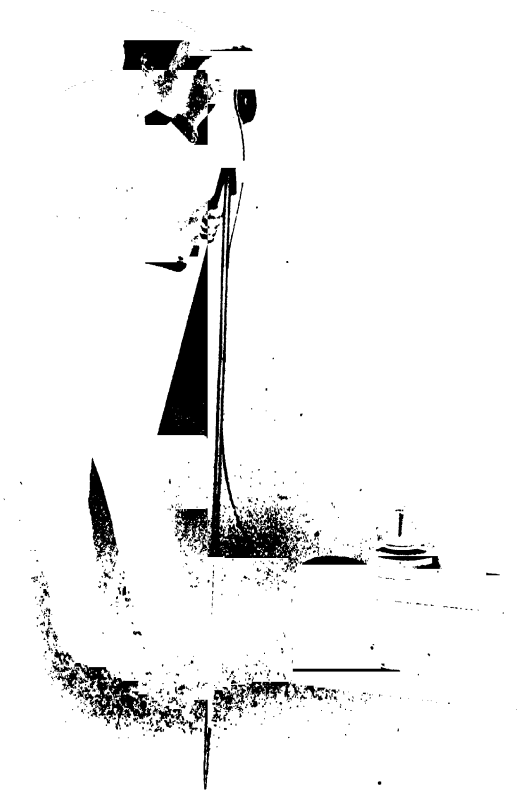

FIG. 35.—Sighting a Féry Radiation Pyrometer.

pyrometer and does not deteriorate with use, accidents and careless handling of course excepted. The thermo-couple is under no circumstances heated more than 80° C. above the surrounding atmosphere. The theoretical principle underlying this pyrometer is stated in the Stefan-Boltzmann radiation law, which

expresses the relationship between the temperature of a body and the amount of radiant energy emitted by that body. The law is this: "The radiant energy emitted by a black body is proportional to the fourth power of the absolute temperature of that body";

$$\text{or} \quad \xi = K (T^4 - T_0^4)$$

where  $\xi$  is the total energy radiated by the body,  $T$  its absolute temperature,  $T_0$  the absolute temperature of the surroundings, and  $K$  a constant depending upon the units employed. This law has been abundantly verified by many investigators and through wide ranges of temperature, and it is in accordance with this law that the galvanometer scales, either direct reading or recording, are graduated. The Stefan-Boltzmann law is strictly true only of the theoretical black body, *i.e.*, one which absorbs all the radiations falling upon it and which is destitute of reflecting power. Several substances conform so nearly to this that no appreciable error is caused by treating them as perfectly black bodies. Metals which yield black oxides (iron, copper, and nickel, for example) and coal and carbon are such substances. Again, enclosed furnaces, retorts, muffles, and combustion chambers furnish a large number of effectively black bodies, and when the same temperature prevails throughout and when the observation hole is small compared with the distance behind it, the radiation issuing from the hole is independent of the radiating surface and is the same as if the surfaces were perfectly black. If, however, the pyrometer is sighted upon a body which is neither black nor effectively black, the temperature observed will be lower than the true temperature. This observed temperature is called the "black body temperature," and a correction must be applied in order to obtain the true temperature. In practice advantage can be taken of the fact that for any given substance, with its surface in a given condition, the "black body temperature" defines its thermal state as definitely as the true temperature.

The Féry pyrometer has been tested by the inventor over a range of temperature which was measured at the same time by a thermo-couple. The results are quoted by Waidner and Burgess

## MEASUREMENT OF HIGH TEMPERATURES 101

in Bulletin No. 2, Bureau of Standards, Washington, U.S.A. The Stefan-Boltzmann law was assumed to hold in the form

$$CE = d = 7.66 T^4 10^{-12},$$

where  $E$  is the total energy of radiation,  $d$  the galvanometer deflection,  $T$  the absolute temperature and  $C$  a constant, and the following results were obtained:—

$d$ .	Temperature from Thermo-couple.	Temperature from Stefan's Law.	Percentage Difference.
11.0	844	660	1.85
14.0	914	925	1.18
17.7	990	990	0.0
21.5	1,054	1,160	0.60
26.0	1,120	1,120	0.0
32.2	1,192	1,190	0.17
38.7	1,260	1,250	0.80
45.7	1,328	1,320	0.60
52.5	1,385	1,380	0.36
62.2	1,458	1,450	0.50

From these results it will be seen that the maximum error is at the low temperatures. When the galvanometer used with this pyrometer has a uniformly graduated scale and when the temperature  $T_1$  corresponding to any one reading on the scale  $R_1$  is also known, then the temperature corresponding to any other scale reading  $R_2$  can be found from the relation

$$T_2 = T_1 \sqrt[4]{\frac{R_2}{R_1}}$$

The Féry pyrometer can be used to measure temperatures of furnaces, etc., provided that the hot body is large enough to give a real image formed by the mirror of sufficient size to overlap the thermo-junction on all sides. The temperature readings are independent of the distance of the pyrometer from the hot body within certain limits, and in general the diameter of the hot body, or furnace apertures, should measure as many inches in diameter as the distance from the hot body to the pyrometer measures

yards. This pyrometer is not suitable for measuring the temperatures of incandescent filaments and other *small* hot bodies; and for this purpose another pyrometer has been devised.

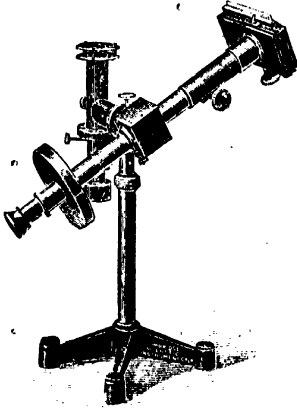

FIG. 36. Féry Absorption Pyrometer.

*Féry Absorption Pyrometer.*

This pyrometer is an improved form of the original optical pyrometer of Le Chatelier, and is useful for measuring the temperatures of incandescent filaments and very small and very hot bodies, which could not be measured by any of the methods previously described. It consists of a telescope D B, Figs. 36 and 37, which carries a comparison lamp laterally, E. A mirror F consisting of a glass silvered over a narrow vertical strip only and placed at the principal focus of the telescope at an angle of  $45^\circ$ . The image

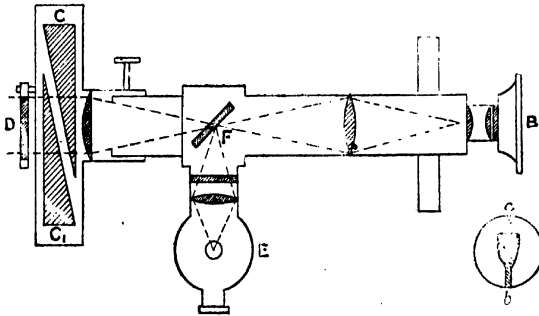

FIG. 37. Féry Absorption Pyrometer.

of the lamp flame is projected on to this mirror, and the telescope is focussed upon the object, the temperature of which it is desired to measure, the object being viewed upon either side of



## MEASUREMENT OF HIGH TEMPERATURES. 103

the silver strip. A pair of absorbing glass wedges  $C_1C_1$  are placed in front of the objective of the telescope and these wedges are moved laterally by means of a micrometer screw until the light from the hot body is made equal to that emitted by the standard lamp. A dark glass  $D$  is also fitted to enable the instrument to work over a higher range of temperature. The micrometer readings are converted into degrees Centigrade by means of a table provided with the instrument

### *The Wanner Pyrometer.*

The Wanner pyrometer is based upon the same principle as the Fery absorption pyrometer just described, viz., the comparison of the intensity of light emitted by a hot body with that of a standard source of light. If the light intensity is denoted by  $E$  and its wave length by  $\lambda$ , the absolute temperature by  $T$ , and if  $a$  and  $b$  are two empirical constants, then

$$E = \frac{a}{\lambda^5} e^{-\frac{b}{\lambda T}} \quad (1)$$

but since there is no means of measuring light in absolute units, it must be measured by comparison with another light, and for this

$$E_1 = \frac{a}{\lambda^5} e^{-\frac{b}{\lambda T_1}} \quad (2)$$

and dividing (1) by (2)

$$\frac{E}{E_1} = e^{-\frac{b}{\lambda} \left( \frac{1}{T} - \frac{1}{T_1} \right)}$$

an equation containing only one constant. This equation, derived by Wien, is only rigorously true for the absolutely black body, but it can be used for measuring temperatures under the same conditions of radiation from effectively black bodies as the Fery radiation pyrometer. The constant  $b$  can be calculated from the observations of Lummer and Pringsheim upon the relationship between intensity of light, its wave length and the absolute temperature. It is found to be about 14,600. The Wanner pyrometer, which is founded upon these considerations, is an extremely convenient and accurate instrument for measuring

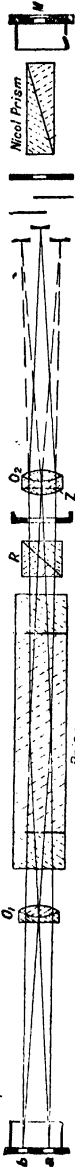

FIG. 38.—Wannier Pyrometer.

high temperatures. It is essentially a photometer, and is shown in Fig. 38. The light from the source, whose temperature is to be measured, passes through the slit *a*, into the instrument. It then passes through the lens *O*, and a direct vision prism *p*, where it is resolved into its spectra. The light is then shut out by means of a screen, until only the small part corresponding to the Fraunhofer line *C* passes through, and only red light can reach the eye at the eyepiece of the telescope tube *M*. The light from a second source, an electric incandescent lamp, passes through the second slit *b*, and is similarly resolved and cut off. In this way the field of vision seen by the eye at *M* consists of two halves, one illuminated by the source the temperature of which is to be measured, the other by the comparison lamp, usually a 6-volt electric lamp. A Nicol prism is placed in the eyepiece, and by rotating this the intensity of light in one half of the field of vision can be varied. The eyepiece is rotated until the intensity of colour in both halves is the same. Now, since the intensity of light and temperature of the incandescent lamp is known by comparison with a standard lamp, such as a Hefner amyli-acetate lamp, the rotation of the Nicol prism is a measure of the intensity of radiation from the black body. The eyepiece is provided with a scale and vernier, and the scale readings are converted into temperatures by reference to a table provided with the instrument, or the scale is divided directly into degrees Centigrade. For use the Wannier pyrometer can be held in the hand or by a suitable stand, sighted at the hot body and the eyepiece rotated until the field of vision is uniform in colour in both halves. The latest forms of this instrument are provided with an electric lamp, a galvanometer and regulating resistance, by means of which the intensity of the comparison light can always be brought to the

## MEASUREMENT OF HIGH TEMPERATURES ' 105

same degree, and so avoid the troublesome acetylene lamp. The Wanner pyrometers can be employed to measure temperatures from  $600^{\circ}$  to  $4,000^{\circ}$  C., and are extremely convenient in technical work.

### *Holborn and Kurlbaum Pyrometer.*

Another very compact and convenient optical pyrometer is that of Holborn and Kurlbaum. In this instrument the intensity of the comparison light is made equal to the light emitted by the hot source under observation. The instrument consists of a

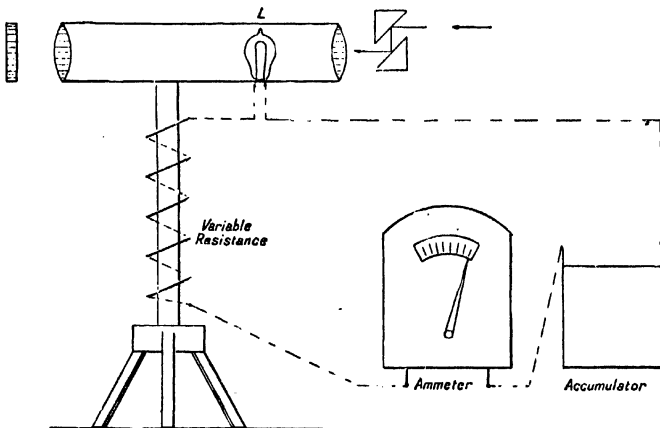

FIG. 39.--Holborn and Kurlbaum Pyrometer.

telescope body, fitted with lenses and provided with a red screen before the objective (Fig. 39). A small electric incandescent lamp is placed in the focal plane of the eyepiece (Fig. 39). A small electric incandescent lamp is placed in the focal plane of the eyepiece (Fig. 39) and connected to an accumulator through an accurate ammeter and a regulating resistance. The instrument is sighted on to the hot body and the eyepiece focussed on to the filament of the lamp. The resistance is then varied until the image of the filament just disappears. This occurs when the intensity of light received from the hot body is equal to that emitted by the electric lamp. The point of disappearance can be determined easily and with great accuracy. The current strength, indicated by the

## 106 · AN INTRODUCTION TO THE STUDY OF FUEL

ammeter used by the incandescent lamp, is a measure of the temperature of the filament, and the ammeter scale can be divided into degrees Centigrade, the instrument becoming a direct reading temperature indicator. This instrument has a range of temperature from 600° to 1,900° C.

The use of optical pyrometers is possible in all cases where the radiations are those of the effectively black body. This, as has been observed, is practically the case of enclosed furnaces, muffles, combustion chambers and the like, provided that they are at nearly the same temperature throughout and provided that the observation hole is of moderate dimensions compared with the distance behind it of the nearest furnace wall. The radiations then issuing through the hole are independent of the colour or quality of the radiating surfaces, and are the same as if those surfaces were perfectly black. Flames, if of the same temperature as the furnace, do not interfere when interposed between the hole and the furnace walls behind and, in many cases, flames, even when not of the same temperature as the furnace, do not absorb or emit any perceptible radiation and therefore the error caused by them can be neglected.

Temperatures are frequently judged by the eye from the colour, or in other words, the intensity of the light radiated to the eye is taken as a measure of the temperature. The following table gives the relation between light emission and temperature:—

	Temperature.	
	Centigrade.	Fahrenheit.
Visible dark red . . . . .	525	977
Dark red . . . . .	700	1,292
Cherry red . . . . .	850	1,562
Bright red . . . . .	950	1,742
Yellow . . . . .	1,100	2,012
White . . . . .	1,300	2,372
Dazzling white . . . . .	1,500	2,732

but the naked eye is not a reliable guide to the correct temperature of a body. In fact two muffles may appear to have the same

## MEASUREMENT OF HIGH TEMPERATURES · 107

temperature while an actual measurement with a pyrometer shows them to differ by  $100^{\circ}$  to  $200^{\circ}$  C.

### (5) *Calorimetric Pyrometers.*

One of the simplest and earliest of this class of pyrometers is due to C. W. Siemens. It consists of a copper calorimeter vessel, having a capacity of 500 to 600 cc. and fitted into two other vessels and the intervening spaces filled up with felt or wool to prevent loss of heat by radiation. A mercury thermometer passes through the lid and is protected from injury by a brass tube which is perforated at the lower end to allow the water to come into contact with the bulb of the thermometer. A scale, similar to a vernier, enables the temperature required to be read off directly without calculation. The method of using this pyrometer is as follows: The calorimeter vessel is filled with water, the thermometer placed in position, and the initial temperature measured. A cylinder of copper with a hole through the centre to enable it to rapidly give up its heat, is placed in the flue or furnace, the temperature of which it is desired to measure, and allowed to gain the same temperature. Ten to fifteen minutes are required for this. The cylinder is then brought as rapidly as possible into the water of the calorimeter, the water well stirred, and the rise of temperature observed or the furnace temperature read off on the scale. This instrument is simple to use but in this form incapable of any degree of accuracy.

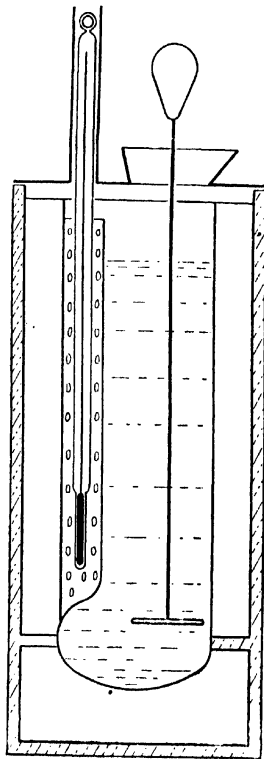

FIG. 10.—Fischer's Pyrometer.

## 108 · AN INTRODUCTION TO THE STUDY OF FUEL

A more accurate instrument is that due to F. Fischer (Fig. 40). A calorimeter vessel of thin copper sheet is placed inside a wooden case, the space between being filled with asbestos or glass or slag wool. The apparatus is closed by a lid, through which pass the thermometer and stirrer. The thermometer is protected from injury by the piece of copper. For measuring the temperature a hollow cylinder of platinum, wrought iron or nickel is used, and it is allowed to get into thermal equilibrium with the temperature it is desired to measure. It is then quickly dropped into the calorimeter and falls on to the stirrer, which is a round copper plate. The stirrer is raised and lowered so as to equalise the temperature of the calorimeter water, and the final temperature of the water is noted. Let the weight of the nickel cylinder be  $m$  grams and the weight of the water in the calorimeter  $W_1$  grams and the water equivalent of the calorimeter stirrer and thermometer  $W_2$ . Let the initial temperature of the water be  $t_1$  and the final  $t_2$ , then the quantity of heat given by the nickel cylinder to the calorimeter water is

$$(W_1 + W_2) (t_2 - t_1) \text{ calories.}$$

Now this quantity of heat is the heat given up by the nickel cylinder of mass  $m$  and specific heat  $\sigma$  in cooling down from the temperature of the furnace  $t$  to the final temperature  $t_2$  of the calorimeter water, *i.e.*,

$$m\sigma (t_f - t_2) \text{ calories.}$$

Equating these and solving for  $t$ ,

$$m\sigma (t_f - t_2) = (W_1 + W_2) (t_2 - t_1)$$

$$t_f = \frac{(W_1 + W_2) (t_2 - t_1)}{m\sigma} + t_2.$$

For any one apparatus the water equivalent, the mass of water in the calorimeter, the mass of nickel and its specific heat, are constant; therefore  $\frac{W_1 + W_2}{m\sigma}$  is a constant for the apparatus, so the equation becomes

$$t_f = \text{constant} (t_2 - t_1) + t_2.$$

The method can be refined still further and the same precautions taken and corrections made as in the calorimetric measurements of calorific power.

## MEASUREMENT OF HIGH TEMPERATURES 109

### (6) *Various Methods of Temperature Measurement.* J

A number of other methods of measuring high temperatures are sometimes employed. The melting points of certain substances are used to indicate the temperature of a furnace, flue, or muffle.

Seger cones are frequently used for this purpose. They are made out of a mixture of quartz  $SiO_2$ , kaolin or China clay, marble, and fluor spar. The ingredients are thoroughly mixed together in the requisite proportions and then formed into three-sided pyramids about 3 to 4 ins. high and  $\frac{1}{2}$ -in. sides. The proportions of the ingredients vary according to the melting point that is desired. The melting points of the cones are determined by a thermo-element or other pyrometer. In order to determine the temperature of a furnace, etc., by means of Seger cones a number of cones are placed upon a fire-clay tray in the furnace, etc., and their behaviour noted. Some will melt entirely, some remain unmelted, and some will just melt so as to curve under their own weight. The temperature of the position is taken as that of the cones which behave in the latter way. Seger cones are made in a series having melting points varying from about  $1,000^\circ C.$  to  $1,900^\circ C.$  at intervals of  $20^\circ$  at each step.

Another method of determining temperatures is by using alloys having definite known melting points. Alloys of silver and gold, gold and platinum, known as Princep's alloys, are employed. The silver-gold and gold-platinum alloys are prepared by carefully melting together the pure metals with a blowpipe. The silver-gold alloys have the following melting points:—

Silver	100 %	80 %	60 %	40 %	20 %	—
Gold	—	20 %	40 %	60 %	80 %	100 %
M.P.	$954^\circ C.$	$975^\circ C.$	$995^\circ C.$	$1,020^\circ C.$	$1,045^\circ C.$	$1,075^\circ C.$

and the gold-platinum alloys have melting points which are intermediate between the melting points of gold,  $1,075^\circ C.$ , and platinum,  $1,775^\circ C.$  If a temperature chart be constructed

by plotting composition and melting points, a straight line can be drawn through these points starting from the melting point of gold and rising to that of platinum. The melting points of intermediate mixtures can be read off the chart. The melting points of both the gold-silver and gold-platinum alloys have been measured by means of an air thermometer, and are probably correct to within 20° C. When these alloys are used to estimate furnace temperatures they must be supported in small capsules of fire-clay. If reducing gases are present a small capsule of magnesia or alumina, free from silica, must be employed, since in the presence of reducing gases, and at high temperatures, silicon is taken up by the alloy and too low a temperature is observed.

The expansion of metal rods or graphite rods (graphite pyrometers or metal pyrometers) and the diminution in volume of a clay cylinder (Wedgewood's pyrometer) have all been used to measure temperature, but owing to many serious disadvantages, the chief of which is their inconstancy of results, they have been displaced by more accurate and more convenient pyrometers.

#### *Calibration of Pyrometers.*

Pyrometers, both thermo-electric and resistance, require to have their indications checked from time to time. The calibration is effected by means of a number of substances having constant boiling or melting points. As a general rule the determination of three points is sufficient to calibrate the pyrometer. The following substances are used as standards, their melting or boiling points having been either determined by an air or gas thermometer, or by an instrument which has been calibrated with reference to a gas thermometer:—

	Centigrade.	Fahrenheit.
Melting ice* . . . . .	0	32
Boiling point of water* . . . . . at 760 mm.	100	212
„ „ naphthaline. . . . .	220	428
„ „ sulphur* . . . . .	445	833
„ „ zinc . . . . .	930	1,706



MEASUREMENT OF HIGH TEMPERATURES · 111

	Centigrade.	Fahrenheit.
Melting point of tin* . . . . . at 760 mm.	232	449
„ „ lead* . . . . . „	327	620
„ „ zinc* . . . . . „	419	786
„ „ antimony . . . . . „	632	1,169
„ „ aluminium* . . . . . „	657	1,214
„ „ sodium chloride . . . . . „	800	1,472
„ „ silver in air . . . . . „	955	1,751
„ „ „ reducing atmos. . . . . „	962	1,763
„ „ gold . . . . . „	1,064	1,947
„ „ copper in air* . . . . . „	1,062	1,943
„ „ potassium sulphate* . . . . . „	1,070	1,958
„ „ nickel . . . . . „	1,427	2,600
„ „ pure iron . . . . . „	1,503	2,737
„ „ platinum . . . . . „	1,775	3,227

The substances marked with an asterisk serve very well for the calibration of an ordinary technical instrument. They can all be readily obtained in a high degree of purity, and the constancy of their melting points can be relied upon. For an instrument measuring temperatures between 0° C. and 500° C. the melting point of ice, the boiling point of water, the melting point of lead, and the boiling point of sulphur, are sufficient; for temperatures up to about 1,100° C., and having a range of from 500° C. to 1,100° C., the boiling point of sulphur, melting points of aluminium, sodium chloride, and copper would be chosen.

The determination of the ice point, boiling point of water and sulphur, and melting point of a metal, for purposes of calibration, will now be described.

*Ice Point.*

A quantity of pure ice, broken up into small pieces, is placed in a double-walled vessel provided with a stopcock to allow the water formed by the ice melting to drain away. The pyrometer is placed with the "bulb," i.e., the thermo-junction or resistance coil, well surrounded by ice, and allowed to take up the temperature of the ice bath, and the readings on the

indicating instrument must be taken from time to time until a constant reading is obtained. The reading is then taken as the zero of the instrument. It is important that the ice shall be free from salts, etc., otherwise the melting point will be too low, and hence the zero incorrect. A copper vessel designed for this purpose is shown in Fig. 41, and is provided with a drain cock.

*Boiling Point of Water.*

This point is determined in some form of a hypsometer.

The well-known form of Regnault's hypsometer is shown in Fig. 42. It consists of a double-walled vessel so arranged as



FIG. 41.—Ice Vessel.

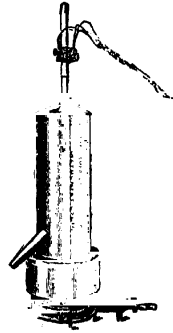

FIG. 42.—Hypsometer.

to allow the steam to circulate between the two walls, and so ensure that a uniform temperature prevails in the centre of the apparatus. The pyrometer passes through a cork at the top of the hypsometer, and is fixed so that the "bulb" is rather more than half-way down, but not immersed in the water. The water is heated to boiling by the ring burner and steam allowed to escape freely from the tube at the side. The constant reading of the indicating instrument is taken and the height of the barometer observed. If the barometer is lower or higher than 760 mm., the temperature will not be exactly 100° C., and for accurate work a correction must be applied. In round figures a difference of 25 mm. in the height of the

barometer causes a difference of  $1^{\circ}$  C. in the boiling point of water.

*Boiling Point of Sulphur.*

It is advisable to calibrate thermometers at fairly high temperatures, and the boiling point of sulphur,  $445^{\circ}$  C., forms a convenient standard. A quantity of flowers of sulphur is placed in either a large Jena glass flask or an iron tube, one end of which is welded up. The flask or tube is well lagged with asbestos to prevent too great a loss of heat through radiation. The pyrometer is fixed in the flask or tube in such a manner that the "bulb" is below the middle of the apparatus, so that it will be well surrounded by the sulphur vapour. A plug of asbestos is placed round the pyrometer stem at the mouth of the tube or flask. The sulphur is heated until it boils vigorously and the heating so regulated that the sulphur vapour condenses a short distance below the top of the neck of the flask or tube. The point of condensation can easily be seen owing to the dark reddish-brown colour of the molten sulphur. The constant reading is again taken as the boiling point. In very accurate work the barometric height must be observed at the time of the experiment and, if different from normal, a correction must be applied. A convenient form of apparatus for standardising pyrometers at the boiling point of sulphur is shown in Fig. 43.

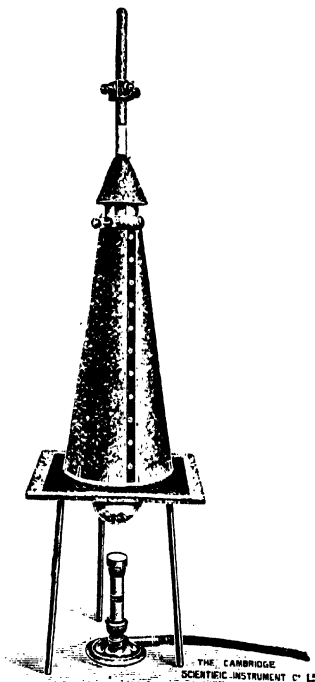

FIG. 43.—Vessel for Boiling Sulphur.

*Melting Point of a Metal.*

This calibration point is best determined by heating the metal in a crucible to a temperature considerably above its melting point, inserting the "bulb" of the pyrometer, which must be protected by a porcelain or iron tube, into the molten metal and allowing the metal to slowly cool. The fall of temperature is noted at definite intervals of time. When the solidifying point of the metal is reached the temperature remains constant for a time, which is longer or shorter according to the good or bad heat insulation of the crucible. This halt is due to the fact that at the melting point the metal absorbs heat in passing from the solid to the liquid state without altering its temperature, and hence, when a metal solidifies it surrenders this heat (latent heat of fusion) and the temperature remains constant. The metal should be stirred with the pyrometer from time to time during the cooling so as prevent supercooling. Small pieces of the solid metal may be added during the cooling for the same purpose. If, however, the cooling is very rapid, the halt point may not be evident. This is frequently the case when metals with high melting points are used to standardise a pyrometer. In such cases the rate of cooling is observed, *i.e.*, readings are taken every half minute or minute, according to the rate at which the temperature falls, the same precautions against supercooling being observed as above. The readings are then plotted on squared paper, plotting temperature ordinates and time abscissæ; the curve will show a break at the melting point, due to a change in the velocity of cooling taking place at that point. The use of some form of a recording pyrometer very greatly simplifies the work of calibration and, of course, of subsequent measurements.

The protection of pyrometers both during calibration and during use is a matter of extreme importance. They are protected by several different materials, and the following points can be noted:—

*Porcelain Tubes* can be used to protect pyrometers in hot-blast mains, annealing furnaces, pottery kilns, and also in steam boilers, economisers, and superheaters, and gasworks retorts. They can be used to a temperature considerably above 1,000° C.

(1,839° F.), but they must not be suddenly heated nor exposed to mechanical damage. Porcelain has the disadvantage of being easily broken. If the pyrometer is likely to receive blows or has to be moved about, the porcelain tube can in turn be protected by an iron tube.

*Quartz Tubes.*—Tubes made of quartz  $SiO_2$  are excellent for protecting pyrometers during work. They stand temperatures up to 1,600° C. without melting, and are not affected by extremely sudden temperature changes. They are, however, easily broken like the porcelain, but they can be mounted in an iron tube and so protected from shock and from flue dust, etc., which attack the quartz at high temperatures.

*Graphite Tubes* can also be used, especially when it is necessary to plunge the pyrometer into molten metals. The lower conductivity of graphite for heat renders the pyrometer so protected slower in indicating the correct temperature. As a rule it requires 5 to 8 minutes to attain the right temperature. This point must also be borne in mind if pyrometers with porcelain or quartz tubes are protected with iron tubes in addition. The pyrometers so protected are slower in indicating temperature changes, owing to the greater thickness through which the heat has to pass before reaching the thermometer proper. For ordinary technical work this lag is not serious, as most frequently comparative temperature readings only, and not measurements of the correct temperature, are desired.

*Metal Tubes*, such as iron, steel, and nickel, without a porcelain tube can be used, but their use is accompanied by several drawbacks. Owing to oxidation, even at comparatively low temperatures, they do not last for any considerable length of time. At higher temperatures they are permeable to furnace gases, some of which are injurious to the platinum or platinum alloy of the pyrometer, and this leads to serious errors in the indications of the instrument.

## CHAPTER VI

### CALCULATION OF COMBUSTION TEMPERATURES

THE maximum temperature of combustion is the highest temperature attainable by the combustion of a given fuel with the theoretical amount of air or oxygen. The combustion is assumed to take place completely and without any external loss of heat, all the heat generated remaining in the products of combustion. This maximum temperature is sometimes called the "Calorific Intensity" of a fuel, but must not be confused with the "Calorific Power" previously dealt with. The highest temperature attainable by the combustion of fuel under these conditions is the temperature to which the heat evolved in the combustion can raise the products of combustion. It therefore depends upon the heat evolved, *i.e.*, the calorific power of the fuel, the specific heats and quantities of the products of combustion. In the following examples the calorific power and the specific heats will be all expressed per gram molecule, the quantities of products in gram molecules.

Now if  $T_{max.}$  be the maximum temperature of combustion of a fuel,  $\sigma_1, \sigma_2, \dots$  the specific heats of the products at constant pressure per molecule,  $Q$  the quantity of heat evolved per gram molecule expressed in gram calories, and  $n_1, n_2 \dots$  the number of molecules of each of the products of combustion, then

$$T_{max.} = \frac{Q}{n_1\sigma_1 + n_2\sigma_2 + \dots} = \frac{Q}{\sum n\sigma}$$

The specific heat, however, changes with the temperature to an extent which is not negligible, and maximum temperatures calculated by the above simple formula are far too high. The variation of the specific heats with the temperature have been measured by Le Chatelier and Mallard, and they gave as the result of their investigations the rule that at absolute zero ( $-273^\circ \text{C.}$ ) the specific heats of all gases at constant pressure

## CALCULATION OF COMBUSTION TEMPERATURES 117

approximated to 6.5, and hence the specific heats of gases could be calculated from the formula

$$C_p = 6.5 + aT$$

at constant pressure

and

$$C_v = 4.5 + aT$$

at constant volume, where  $T$  is the absolute temperature.

The values for the constant  $a$  have the following values:—

For permanent gases, $H_2, O_2, N_2, CO$ .	$C_p = 6.5 + 0.0006 T$ .
,, water vapour	$C_p = 6.5 + 0.0029 T$ .
,, carbon dioxide	$C_p = 6.5 + 0.0037 T$ .
,, ethylene	$C_p = 6.5 + 0.0068 T$ .

By means of these values the change of specific heat with the temperature can be allowed for and more correct and more probable values for the maximum combustion temperature obtained. The temperature depends upon:—

- (1) The quantity of heat evolved by the combustion of the fuel.
- (2) The initial temperature of the fuel and air or oxygen supplied.
- (3) The amount of heat lost in the products of combustion.
- (4) The radiation from the walls of the furnace, etc.

The last factor cannot be accurately determined, but a value for it can be obtained in the course of work with each particular furnace used in any operation.

### CALCULATION OF THE THEORETICAL MAXIMUM TEMPERATURE OF COMBUSTION.

I. The combustion of hydrogen is assumed to take place in air, both gases being at  $0^\circ C.$ ; the theoretical amount of air is assumed to be used.

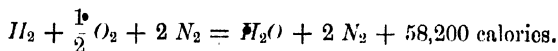

Air is taken as containing 1 molecule of oxygen to 4 molecules of nitrogen, which is approximately correct, and this proportion will be assumed in this and the following examples. The heat

of reaction is the heat of combustion of hydrogen at ordinary temperatures minus the latent heat of vaporisation of water, *i.e.*,

$$69,000 - 10,800 = 58,200 \text{ calories.}$$

Let the temperature attained be  $t^\circ \text{C.} = t + 273 = T$  absolute, and let the temperature of the surrounding air be  $0^\circ \text{C.} = 273$  absolute.

It can be shown that, when the specific heat is expressed as a temperature function, then the heat given up by a body or system cooling from  $t + 273$  to  $t$  is given by the equation

$$a t + \frac{\beta}{2} (t^2 + 2 \times 273 t).$$

In the case of water substitute the values given above

$$a = 6.5 \quad \beta = 0.0029,$$

and for nitrogen

$$a = 6.5 \quad \beta = 0.0006.$$

Then for one molecule of hydrogen burnt in air:—

Heat absorbed by water formed

$$= 6.5 t + \frac{0.0029}{2} (t^2 + 546 t);$$

Heat absorbed by nitrogen

$$= 2 \left( 6.5 t + \frac{0.0006}{2} (t^2 + 546 t) \right)$$

$$\text{Total} = 19.5 t + 0.00205 (t^2 + 546 t).$$

Now, upon the assumption that the whole of the heat of combustion is absorbed by the products in raising their temperature, then this must be equal to the above quantity, *i.e.*,

$$19.5 t + 0.00205 (t^2 + 546 t) = 58,200,$$

and

$$t = 2,298^\circ \text{C.}$$

II. The combustion of hydrogen is assumed to occur in air, both gases being at  $0^\circ \text{C.}$ , and twice the theoretical amount of air is used.

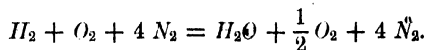

Then as above:—

Heat in 1 molecule of water vapour at  $t^\circ \text{C.}$

$$= 6.5 t + 0.00145 (t^2 + 546 t)$$



Heat in  $\frac{1}{2}$  molecule oxygen at  $t^\circ$  C.

$$\frac{1}{2} \{6.5 t + .0003 (t^2 + 546 t)\}$$

Heat in 4 molecules of nitrogen at  $t^\circ$  C.

$$4 \{6.5 t + 0.0003 (t^2 + 546 t)\}$$

$$\text{Total} = 35.75 t + 0.0028 (t^2 + 546 t).$$

Equating to the heat of combustion of hydrogen as before

$$35.75 t + 0.0028 (t^2 + 546 t) = 58,200$$

$$37.28 t + 0.0028 t^2 = 58,200$$

whence

$$t = 1,411^\circ \text{C.}$$

This result shows how great a loss of heat results from the employment of a large excess of air. If the gas or air or both are heated before combustion is allowed to take place, then the heat in them is added to the heat of combustion, and the quantity of heat available for raising the temperature of the products is therefore greater. As an example of this the combustion of carbon monoxide with twice its theoretical amount of air, both heated to  $500^\circ \text{C.}$ , will be considered. Required the maximum temperature attained

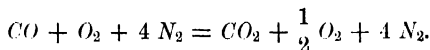

Heat brought in by  $CO$  at  $500^\circ \text{C.}$

$$= 500 \{6.5 + .0003 (500 + 546)\}$$

Heat brought in by  $O_2$  at  $500^\circ \text{C.}$

$$= 500 \{6.5 + .0003 (500 + 546)\}$$

Heat brought in by  $4 N_2$  at  $500^\circ \text{C.}$

$$= 500 \times 4 \{6.5 + .0003 (500 + 546)\}$$

Total available

$$= 3,000 \{6.5 + .0009 (1,046)\}$$

$$= 20,441 \text{ calories.}$$

Heat of combustion of carbon monoxide = 68,200

Heat brought in by gases . . . . . 20,441

Total heat available. . . . . 88,641 calories.

Heat products of combustion :—

$$\text{In } CO_2 \text{ at } t^\circ \text{ C.} = 6.5 t + .00185 (t^2 + 546 t)$$

$$\text{In } \frac{1}{2} O_2 \text{ at } t^\circ \text{ C.} = \frac{1}{2} \{6.5 t + .0003 (t^2 + 546 t)\}$$

$$\text{In } 4 N_2 \text{ at } t^\circ \text{ C.} = 4 \{6.5 t + .0003 (t^2 + 546 t)\}$$

$$\text{Total} = 35.75 t + .0032 (t^2 + 546 t).$$

Equating this to the total heat available

$$35.75 t + .0032 (t^2 + 546 t) = 88,641$$

$$37.5 t + .0032 t^2 = 88,611,$$

whence

$$t = 2,017^\circ \text{ C.}$$

On the other hand, if the combustion should take place with twice the theoretical amount of air, and both CO and air at 0° C., the last equation would become

$$37.5 t + 0.0032 t^2 = 68,200,$$

and

$$t = 1,601^\circ \text{ C.}$$

In the more complex cases of the combustion of producer or water gas, the maximum temperature theoretically attainable can be calculated in the same way. As an example, the theoretical combustion temperature of the ideal water gas and producer gas will be calculated.

Producer gas: In the ideal case this consists of a mixture of carbon monoxide and nitrogen, and is made by blowing air over heated carbon,

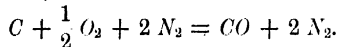

As before, assuming air to contain 1 molecule of oxygen to 4 molecules of nitrogen, then the ideal producer gas will have the composition

Carbon monoxide . . . . .	33.3 % by volume
Nitrogen . . . . .	66.7 % „
	100.0

and the products of combustion will be

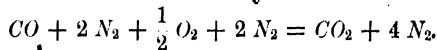

Carbon dioxide . . . . . 20 % by volume

Nitrogen . . . . . 80 % „

CALCULATION OF COMBUSTION TEMPERATURES 121

The reaction gives 68,200 calories per molecule of carbon monoxide burnt, *i.e.*,

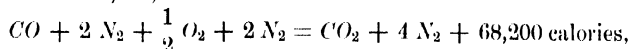

and the products of combustion are 1 molecule of carbon dioxide and 4 molecules of nitrogen, then

$$\begin{aligned} \text{Heat in } CO_2 \text{ at } t^\circ \text{ C.} &= 6.5 t + 0.00185 (t^2 + 546 t) \\ \text{,, } 4 N_2 \text{ ,,} &= 4\{6.5 t + 0.0003 (t^2 + 546 t)\} \\ \text{Total} &= 32.5 t + 0.00305 (t^2 + 546 t) \\ &= 34.2 t + 0.00305 t^2. \end{aligned}$$

Equating this to the heat of combustion and solving for  $t$ ,

$$\begin{aligned} 34.2 t + 0.00305 t^2 &= 68,200 \\ t &= 1,728^\circ \text{ C.} \end{aligned}$$

Combustion of ideal water gas. Ideal water gas has the composition



*i.e.*

Carbon monoxide	.	.	.	50 %	by volume
Hydrogen	.	.	.	50 %	„
				100.0	

Its theoretical heat of combustion is

$$\begin{aligned} 0.5 \times 68,200 &= 34,100 \text{ calories from } CO \\ 0.5 \times 58,200 &= 29,100 \text{ ,, ,, } H \\ \hline &63,200 \text{ ,, per molecule.} \end{aligned}$$

Upon combustion with air it yields

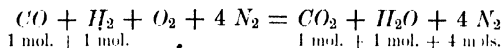

and hence the combustion of the 1 molecule of the mixed gases, *i.e.*, 0.5 molecule  $CO$  and 0.5 molecule  $H_2$  will yield as products 0.5 molecule  $CO_2$ , 0.5 molecule  $H_2O$  and 2 molecules  $N_2$ , and the heat generated by the combustion is assumed to heat up these products to  $t^\circ \text{ C.}$ , then

$$\begin{aligned} \text{Heat in } CO_2 &= 0.5 \{6.5 t + 0.00185 (t^2 + 546 t)\} \\ \text{,, } H_2O &= 0.5 \{6.5 t + 0.00145 (t^2 + 546 t)\} \\ \text{,, } N_2 &= 2.0 \{6.5 t + 0.0003 (t^2 + 546 t)\} \\ \text{Total} &= 19.5 t + 0.00225 (t^2 + 546 t) \\ &= 20.73 t + 0.00225 t^2, \end{aligned}$$

and equating this to the heat evolved by the combustion, and solving for  $t$ ,

$$20.73 t + 0.00225 t^2 = 63,200,$$

whence

$$t = 2,414^\circ \text{C.}$$

#### COMBUSTION TEMPERATURE OF SOLID FUELS.

The maximum temperature of combustion of solid fuels can be calculated in a similar manner to the above. The calculation is rendered much simpler if a quantity of fuel is taken which will give 22.32 litres of products of combustion at  $0^\circ \text{C.}$  and 760 mm., *i.e.*, 1 gram molecule, for then the percentage (by volume) composition of the products will give the number of molecules of each of the various constituents present. In order to illustrate this, an example will now be worked in detail. A coal has the following composition:—

Carbon . . . . .	73.36 %
Hydrogen . . . . .	4.32 %
Nitrogen. . . . .	1.10 %
Oxygen . . . . .	10.22 %
Sulphur . . . . .	0.41 %
Ash . . . . .	5.03 %
Moisture . . . . .	5.56 %

The combustion will now be assumed to take place with the theoretical quantity of air at  $0^\circ \text{C.}$  and 760 mm. pressure, and all the heat of combustion to be used up in raising the temperature of the products.

The composition of the products of combustion are calculated as follows: Let the unit of volume be the volume occupied by 1 gram molecule of the products, *i.e.*, 22.32 litres, then 1 vol. = 22.32 litres. Fuel and air are assumed to be at  $0^\circ \text{C.}$

$$\begin{array}{l} \text{Carbon dioxide . . . . .} = \frac{73.36}{12} = 6.113 \text{ vols.} \\ \text{Water from combustion of available} \\ \quad \text{hydrogen in coal . . . . .} = \frac{9.04}{2} = 1.02 \\ \text{Water from combined hydrogen} \\ \quad \text{and oxygen present in coal . . . . .} = \frac{11.50}{18} = 0.64 \end{array} \left. \vphantom{\begin{array}{l} \text{Carbon dioxide . . . . .} \\ \text{Water from combustion of available} \\ \quad \text{hydrogen in coal . . . . .} \\ \text{Water from combined hydrogen} \\ \quad \text{and oxygen present in coal . . . . .} \end{array}} \right\} = 1.660 \text{ ,,}$$

CALCULATION OF COMBUSTION TEMPERATURES 123

Sulphur dioxide $SO_2$ . . . . .	$= \frac{0.41}{32}$	= 0.013 vol.
Nitrogen from coal . . . . .	$= \frac{1.10}{28}$	= 0.400 „
Water from moisture in coal . . . . .	$= \frac{5.56}{18}$	= 0.310 „

Air required for the above:—

Carbon requires . . . . .	6.113 vols. oxygen
Hydrogen requires . . . . .	0.510 „ „
Sulphur requires . . . . .	0.013 „ „
	<u>6.636</u> „ „

Nitrogen corresponding to this =  $4 \times 6.636 = 26.544$

Total . . . . . = 35.04 vols.

The percentage composition will be:—

Carbon dioxide . . . . .	$\frac{6.113 \times 100}{35.04}$	= 17.44 %
Water . . . . .	$\frac{1.983 \times 100}{35.04}$	= 5.70 %
Sulphur dioxide . . . . .	$\frac{0.013 \times 100}{35.04}$	= 0.04 %
Nitrogen . . . . .	$\frac{26.944 \times 100}{35.04}$	= 76.82 %
	<u>100.00</u>	

Heat of combustion of the fuel = 9,500 calories.

Heat in  $CO_2$  =  $0.1744\{6.5 t + 0.00185 (t^2 + 546 t)\}$

„ water vapour =  $0.057\{6.5 t + 0.00145 (t^2 + 546 t)\}$

„ nitrogen =  $0.7682\{6.5 t + 0.0003 (t^2 + 546 t)\}$

Total =  $6.5 t + 0.000636 (t^2 + 546 t)$

=  $6.85 t + 0.000636 t^2 = 9,500$  calories

hence  $t = 1,244^\circ C.$ \*

In practice the theoretical maximum combustion temperature is never attained. The reasons for the discrepancy are:—

\* The amount of heat absorbed by the  $SO_2$  is so small that it can be neglected in this calculation.

(1) The combustion cannot be carried out with the exactly theoretical quantity of air. As already pointed out, an excess of air is necessary for the complete combustion of a fuel.

(2) There is a certain loss of heat through the falling of ash and hot cinders, frequently accompanied by a certain amount of unburnt fuel.

(3) The furnace in which the combustion takes place absorbs some of the heat, and therefore the whole of the heat of combustion does not pass into the products of production.

(4) An additional quantity of the heat is lost by radiation.

All these causes reduce the quantity of heat available for heating the products, and hence the maximum temperature attained falls considerably below the theoretical value.

*Relationship between heat of combustion and temperature of combustion.*

It has already been shown that the specific heats of gases, etc., change with the temperature to such an extent that this change cannot be neglected, when these specific heats are used in a calculation, without introducing a serious error. The heats of reaction, in general, change with the temperature, and the change depends upon the sign of the difference between the specific heats before and after the reaction. The following elementary considerations of the question are necessary: If a very small quantity of heat  $dQ$  be added to a system, then the energy of that system  $U$  is increased by the small increment  $dU$ , and if at the same time external work be done  $dA$ , then by the law of conservation of energy

$$dQ = dU + dA.$$

If the system consist of a gas contained in a cylinder closed by a movable frictionless piston, then by the addition of the small quantity of heat  $dQ$  the gas is expanded against the external pressure  $p$ . Let the change of volume be  $dv$ ,

$$dA = p dv.$$

Now any change in the energy content of a system does not depend upon the way in which the change is effected, but only depends upon the initial and final states of that system, and based upon this the change of heat of combustion (or in general,

a chemical reaction) with the temperature can be deduced. Let the reaction (or combustion) take place at constant temperature  $T$ , without altering the temperature of the system, whereby the quantity of heat  $Q$  is given up by the system to the surroundings. The temperature is now raised from  $T$  to  $T + dT$ , and in order to do this, a quantity of heat  $c_1dT$ , where  $c_1$  is the specific heat of the system after the completion of the reaction, must be added to the system. Assuming no external work to be done, the change of energy of the system is

$$Q - c_1dT \quad (1)$$

Denoting heat evolved by the system as positive and heat added to or absorbed by the system as negative, the same final condition can be attained in another way. Suppose that before the reaction is allowed to take place, the temperature of the system be raised from  $T$  to  $T + dT$ , and for this purpose the quantity of heat  $cdT$  be added to the system,  $c$  is the specific heat before the reaction takes place. The reaction is now allowed to proceed and the heat evolved is  $Q + dQ$ . The energy change in this case is

$$Q + dQ - cdT \quad (2)$$

and by the law of conservation of energy (1) and (2) are equal, hence

$$Q - c_1dT = Q + dQ - cdT,$$

and

$$dQ = (c - c_1) dT,$$

a result which is of great importance, since it enables the heat of reaction at different temperatures to be calculated when the specific heats of the initial and final states are known. This is known as Kirchoff's law. Let us now apply this to the case of the combustion of carbon monoxide in oxygen. Let the carbon monoxide or oxygen combine at  $0^\circ$ , then let the carbon dioxide be heated up to  $1,000^\circ \text{C}$ .

$$\begin{aligned} Q_0 - C_p(1,000) &= Q_0 - \{6.5 \times 1,000 + .00185(1,000^2 + 546 \times 1,000)\} \\ &= Q_0 - 9,360 \\ &= 68,200 - 9,360 = 58,840 \text{ calories.} \end{aligned}$$

Now let the carbon monoxide and the oxygen be heated up to  $1,000^\circ \text{C}$ , and then let combustion take place.

126. AN INTRODUCTION TO THE STUDY OF FUEL

Quantity of heat required for 1 molecule  
of CO

$$6.5 \times 1,000 + .0003 (1,000^2 + 546 \times 1,000) = 6,964 \text{ calories.}$$

Quantity of heat required for  $\frac{1}{2}$  molecule  
of oxygen

$$\frac{1}{2} \{6.5 \times 1,000 + .0003 (1,000^2 + 546 \times 1,000)\} = 3,482 \text{ ,,}$$

Total . . . . . 10,446 ,,

$$Q_{1,000} - 10,446 = 58,840 \text{ calories,}$$

$$\therefore Q_{1,000} = 69,286 \text{ ,,}$$

Kirchoff's law can then be put into the form

$$Qt_2 = Qt_1 + (c_1 - c_2) (t_2 - t_1),$$

where  $c_1$  and  $c_2$  are the specific heats in the initial and final states,  $t_1$  and  $t_2$  the initial and final temperatures.

By employing the specific heats at constant volume, the maximum temperature of an explosion taking place in a closed space can be calculated.



## CHAPTER VII

### NATURAL SOLID FUELS

FUELS can be defined for the present as materials consisting of carbon and hydrogen, which by union with oxygen generate heat in sufficient amount to render their use possible as sources of heat.

In the widest sense, however, fuels constitute a class of substances which combine with oxygen with the evolution of large quantities of heat which is utilised in different ways. For example, in the Bessemer converter it is through the combustion of the silicon present in the iron, by the oxygen of the blast, that the temperature of the molten metal is not only maintained, but even raised. Again, in roasting certain ores the combustion of the sulphur present, forming sulphur dioxide, is used to supply the heat necessary for the process. In the case of fuels for the production of heat for steam raising, metal work, and casting, and technical work of a similar nature, the definition given at the beginning of the chapter holds.

Fuels can be grouped into three great classes—solid, liquid, and gaseous fuels, and each great class can again be sub-divided into two subordinate classes, viz., natural and artificial. The chief fuels can be grouped under these heads. They are:—

#### SOLID FUELS.

Natural.	Artificial.*
Wood.	Charcoal.
Peat.	
Coal.	Coke.
Anthracite.	Briquettes.

\* The half coked material known as "Coalite" is not described, owing to the limited quantity used, and to the very open question as to its usefulness and advantages.

## LIQUID FUELS.

Natural.	Artificial.
Petroleum.	Tar.
	Oils, animal and vegetable.
	Alcohol and wood spirit.
	Coal tar oils.

## GASEOUS FUELS.

Natural gas.	Coal gas.
	Producer gas.
	Water gas.
	Dowson or mixed gas.

Coal and anthracite form by far the greater proportion of fuel used technically. In certain industries coke and charcoal are used, for example, in the production of iron in blast furnaces. Petroleum is used as a fuel chiefly in the neighbourhood of petroleum wells, and the use of tar and tar oils as fuel for steam raising and annealing of metals, is increasing. Similarly, natural gas is only used near its sources, *i.e.*, in petroleum districts, but artificial gas, such as producer gas, water gas, coal gas, and blast furnace gas are all being used for various heating operations and for the motive power of certain gas engines.

The characteristics of the more important fuels will now be considered.

(a) *Solid Natural Fuels.*—Coal has been formed by the decomposition of plants and trees through the agency of heat and pressure. The coal retains in some instances traces of its vegetable origin. Ferns are occasionally found embedded in the coal, while the fibrous structure of the wood is still visible in many varieties, and even the trunks of trees, now wholly converted into coal, may sometimes be met with. The conditions, of course, differed under which coals were formed, and therefore varieties of coal exist showing the degrees of conversion. Some coals, *e.g.*, the lignites, resemble wood in many particulars, and others, like anthracite, have lost practically all traces of their vegetable origin.

The passage from wood to coal is characterised by an increase

in the carbon content and a diminution in the amount of hydrogen and oxygen. This change is well shown when the composition is expressed, not in percentages, but as relative to 100 parts by weight of carbon.

	Carbon.	Hydrogen.	Oxygen.	Calorific Power.	
				Calories.	B.T.U.
Wood . . . . .	100	12.18	83.07	4,700	8,460
Peat . . . . .	100	9.85	55.67	5,900	10,620
Lignite . . . . .	100	8.37	42.42	6,500	11,700
Bituminous coal	100	6.12	21.23	7,200	12,960
Anthracite . . . . .	100	2.84	1.74	8,300	14,940

It is evident from this table that as the change from wood to coal progresses the value of the product as a fuel increases.

The formation of coal from wood has been made the subject of laboratory experiments by Stein. Wood and water were heated together in sealed glass tubes, to different temperatures, thereby subjecting the wood to both temperature and pressure. The heating was continued for different times. The material was then removed from the tubes and analysed, and the chief results obtained were in favour of the view that coal was formed by the slow decomposition of wood, under the joint action of temperature and pressure. The following table gives some of Stein's results and shows the influence of time upon the process :—

Temperature ° C.	Time of Heating.	Carbon.	Hydrogen.	Oxygen.
245	9 hours	100	8.6	47.12
250	6 "	100	7.4	37.14
255	6 "	100	7.0	34.85
265	5 "	100	6.5	30.91
275	5 "	100	6.1	29.01
280	5 "	100	5.8	28.58
290	5 "	100	4.7	18.32

In the natural process of coal formation the pressure is generated by the superincumbent earth and rock, and although the temperature was probably lower than in the above experiments, the longer time more than equalised the difference.

According to the geological period during which the coals were formed, the fossil coals can be classified as—

- (1) Recent fossil coal. Turf or peat and the lignites.
- (2) Older fossil coal. Bituminous coal and anthracite.

#### *Peat.*

Turf or peat is found in certain districts in layers of varying thickness, these layers being spread over a considerable area in localities known as peat bogs or peat moors. It is formed by the decay of plant life in the presence of moisture, and it is always found associated with a considerable quantity of water. The appearance of peat differs according to its age, the more recent peat being spongy and consisting of partially decomposed moss associated with roots, and in its structure seeds, etc., can be seen.

Older peat on the other hand has lost most, if not all, of the structure and has a more or less earthy appearance. The colour is brown to black, and the fracture is occasionally smooth like pitch, but more frequently rough and uneven. The specific gravity of peat varies from 0.113 to 1.039, and when freshly cut may contain 80 per cent. or 90 per cent. of moisture, which is reduced to 5 or 30 per cent. by air drying. The average composition of peat (air dried) is

Carbon . . . . .	49.6 to 63.9 %
Hydrogen . . . . .	4.7 „ 6.8 %
Oxygen . . . . .	25.3 „ 44.1 %
Nitrogen . . . . .	0 „ 2 %
Water . . . . .	10 „ 30 %
Ash . . . . .	5 „ 10 %

The calorific power of peat depends very greatly upon the amount of water and ash present; it varies from 2,090 calories (3,762 B.T.U.) to 5,250 calories (9,450 B.T.U.). The peat is cut from the peat bogs or mosses by hand, or by machines, into pieces resembling ordinary building bricks. These are piled up and

exposed to air in order to remove water, and occasionally the water is removed by pressure, a sort of moulding press being employed for this purpose. In consequence of the low specific gravity, its high ash and water content, and its low calorific power, its use is almost confined to the neighbourhood of the peat bogs, and does not find any great use in technical work as a fuel.

### *Lignites.*

Lignites are the next step in the formation of coal. They still retain traces of woody structure, have a brown colour, and hence are sometimes called "brown coal." The specific gravity is usually between 1.2 and 1.5, but in samples rich in ash it may be as high as 1.8. When exposed to the air, lignites undergo oxidation with the formation of carbon dioxide and consequent loss of carbon. Since the oxidation is accompanied by heat, cases of spontaneous combustion are common.

Several varieties of lignites are known, and they are named according to their appearance, structure and fracture. The varieties differ also in the amount of carbon, hydrogen and oxygen which they contain. The following table shows the composition of some lignites and also their calorific powers:—

COMPOSITION OF LIGNITES.

	Carbon.	Hydrogen.	Oxygen.	Calorific Power.	
				Calories.	B.T.U.
Fibrous .	57 to 67	5 to 6	28 to 37	5,000	9,000
Earthy .	45 ,, 70	5 ,, 6	25 ,, 30	5,700	10,260
Conchoidal	65 ,, 75	4 ,, 6	21 ,, 29	6,500	11,700
Bituminous	70 ,, 80	6 ,, 8	12 ,, 24	7,000	12,600

Lignite is found at Bovey Tracey, in Devonshire, and near Lancaster, in England, and in the neighbourhood of Lough Neagh, in Ireland. It is found in many parts of the continent, and is an important fuel in Germany and Austria. Lignite burns with a moderately long and intensely hot flame. It softens (sinters) during combustion, and cakes together. This

last property seriously interferes with the usefulness of lignites as fuels.

The chief varieties of lignite are (1) caking coal, (2) splint coal, (3) Cannel coal. These coals are employed for gas manufacture, as they yield a large quantity of gas and moderate quality of coke. The coke is a valuable heating agent and can be used for purposes for which the coal itself is unsuitable.

Jet is a species of lignite, which has a bright, pitch-like fracture and a black colour. It is much less brittle than other members of this species, and can be worked up into articles of ornament. The ash of lignites contains a large number of elements, the chief constituents being silica  $SiO_2$ , alumina  $Al_2O_3$ , ferric oxide  $Fe_2O_3$ , calcium oxide  $CaO$ , together with small quantities of magnesia  $MgO$ , sodium and potassium, sulphates, phosphates, and carbonates.

#### *Bituminous Coals.*

These belong to the older fossil coals, and constitute an extremely important class of fuels. They differ from the lignites in many important particulars, the fracture being different and no organic structure being apparent to the naked eye. They are not particularly hard, and, as a rule, are brittle. When subjected to dry distillation they yield a more or less hard coke, and the quantity of coke varies with the particular sample of coal. The ignition point of bituminous coals is higher than that of both peat and lignite. Bituminous coals burn with a white flame, and have been classified according to their flaming properties. This classification is due to Grüner, and is as follows:—

(1) Non-caking coals with long flame. These coals burn with a long, smoky flame. They crack and break in the fire and crumble into pieces. They contain—

Carbon	. . . . .	75 to 80	%
Hydrogen	. . . . .	4.5 „ 5.5	%
Oxygen and nitrogen	. . . . .	15 „ 19.5	%

Upon dry distillation they yield 55 to 60 per cent. of a pulverulent or slightly sintered coke. The calorific power is between 8,000 and 8,500 calories (14,400 and 15,300 B.T.U.).

(2) Caking coals, long flame, rich gas coals. These coals are most suitable for purposes where flame is required, such as heating reverberatory furnaces. They also yield quantities of gas upon dry distillation, but only a poor quality of coke. By the use of suitable coke ovens the quality of the coke can be improved. They burn with a long, smoky flame, soften and cake together during heating. The composition is—

Carbon . . . . .	80 to 85	%
Hydrogen . . . . .	5 „	5.8 %
Oxygen and nitrogen . . . . .	10 „	14.2 %

The calorific power is 8,500 to 8,800 calories (15,300 to 15,840 B.T.U.). The yield of caked and friable coke is 60 to 68 per cent. The volatile matter is 32 to 42 per cent., containing about 17 to 20 per cent. as gaseous products.

(3) Bituminous furnace coals. These are especially useful for gas coals, furnace coals, and for coke-making. They burn with a yellowish, slightly smoky flame, and melt when heated, caking together into compact masses. Upon destructive distillation they yield 68 to 74 per cent. of caked and swollen coke, and 15 to 16 per cent. gas. The composition of these coals is—

Carbon . . . . .	84 to 89	%
Hydrogen . . . . .	5 „	5.5 %
Oxygen and nitrogen . . . . .	5.5 „	11.0 %

and the calorific power 8,800 calories (15,840 B.T.U.) to 9,000 calories (16,200 B.T.U.), and evaporate 8 to 9 times their weight of water.

(4) Caking coals with short flames. These are also known as coking coals, or sinter coals. They are specially useful for boiler firing and for coke-making. They ignite with difficulty and burn with short luminous and slightly smoky flames; when heated they only slightly cake together. They yield a very compact and hard coke. Their composition is—

Carbon . . . . .	88 to 91	%
Hydrogen . . . . .	4.5 „	5.5 %
Oxygen and nitrogen . . . . .	5.5 „	6.5 %

## 134 AN INTRODUCTION TO THE STUDY OF FUEL

They yield about 74 to 82 per cent. of compact hard coke and 12 to 15 per cent. of gas upon dry distillation. The calorific power is 9,200 to 9,600 calories (16,560 to 17,280 B.T.U.) and evaporate 9 to 10 times their weight of water.

(5) Anthracitic coals. These coals form a transition stage between the above coals and the true anthracites. They do not crack and break up in the fire. They burn with short flames, almost without smoke, and show practically no tendency to cake when heated.

The composition is—

Carbon . . . . .	90 to 93	%
Hydrogen . . . . .	4 „	4.5 %
Oxygen and nitrogen . . . . .	3 „	3.5 %

Upon dry distillation they leave 82 to 92 per cent. of a very pulverulent and fritted coke, and yield only a little gas. The calorific power is 9,200 to 9,500 calories (16,560 to 17,100 B.T.U.). They evaporate 9 to 9.5 times their weight of water.

(6) Anthracites represent the last step in the formation of coal. They are hard, black in colour, and have a conchoidal fracture. The specific gravity is 1.40 to 1.80.

Anthracite burns without smoke and with very short hot flames, and does not melt or lose its appearance when heated. The composition of anthracite is:—

Carbon . . . . .	93 to 95	%
Hydrogen . . . . .	2 „	4 %
Oxygen and nitrogen . . . . .	3 „	1 %

The residue after dry distillation is 90 to 92 per cent. of pulverulent coke, the yield of gas is 8 to 10 per cent. Anthracite coal is used greatly in America for many industrial heating operations. It is also used for firing the boilers of steamships, especially warships, the absence of smoke being of great importance in the latter case.

The chief characteristics of these fuels are summarised in the following table:—



Name.	C %.	H <sub>2</sub> %.	O + N %.	Calorific Power.		Water Evaporated	Coke Yield %.
				Calories.	B.T.U.		
Non-caking coal with long flame.	75	4.5	15.0	8,000	14,400	6.7	55
	to	to	to	to	to	to	to
Caking coal with long flames, gas coal.	80	5.5	19.5	8,500	15,300	7.5	60
	to	to	to	to	to	to	to
Bituminous, furnace coal.	85	5.8	14.2	8,800	15,800	8.3	68
	to	to	to	to	to	to	to
Caking coal with short flame.	84	5	5.5	8,800	15,800	8	68
	to	to	to	to	to	to	to
Anthracitic coals	89	5.5	11	9,000	16,200	9	74
	to	to	to	to	to	to	to
True anthracite	88	4.5	5.5	9,200	16,560	9	74
	to	to	to	to	to	to	to
	91	5.5	6.5	9,600	17,280	10	82
	to	to	to	to	to	to	to
	90	4	3	9,200	16,560	9	82
	to	to	to	to	to	to	to
	93	4.5	3.5	9,500	17,100	9.5	92
	to	to	to	to	to	to	to
	93	2					90
	to	to	3.0	9,000	16,200	9	to
	95	4					92

The above figures give only the limits of composition of the various classes of fuels. It must be borne in mind that the coal seams are by no means uniform, but are subject to considerable variations, especially as regards ash, volatile matter and coke, which are usually determined in a proximate analysis of coal for control purposes.

The average composition of coals from different localities in Great Britain is given in the following table (Muspratt) :—

Locality.	Specific Gravity %.	C %.	H <sub>2</sub> %.	N <sub>2</sub> %.	S %.	O <sub>2</sub> %.	Ash %.	Coke %.
Average of—								
36 samples from Wales	1.315	83.78	4.79	0.98	1.13	4.15	4.91	72.60
18 " " Newcastle.	1.256	82.12	5.31	1.35	1.24	5.69	3.77	60.67
28 " " Lancashire	1.273	77.90	5.32	1.30	1.44	9.53	4.88	60.22
8 " " Scotland	1.259	78.53	5.61	1.00	1.11	9.69	4.03	54.22
7 " " Derbyshire	1.292	79.68	4.94	1.41	1.01	10.28	2.65	59.32

These coals are mainly bituminous coal ; but in the 36 Welsh coals there is included one sample of anthracite.

E. Muck has described a simple laboratory test for identifying the class to which the fuel belongs. A small quantity of the finely-powdered fuel is heated in a platinum crucible with the lid on until the flame which burns at the junction of lid and

## 136 AN INTRODUCTION TO THE STUDY OF FUEL

crucible is no longer visible. The residue is allowed to cool, and is then shaken out and examined. From the appearance and character of the coke the coal can be classified; for example:—

Residue in powder, almost as fine as original coal, denotes non-caking coal;

Residue somewhat fused (sintered), but not swollen, denotes caking coal or sinter coal;

Residue completely melted and swollen, caking coal.

By means of this test coals having intermediate properties can be identified and the suitability of the fuel for various purposes can be judged. The class of coal used in any particular process depends upon the nature of the available coal in the district. The coal is purchased from the nearest mines, so as to avoid expense of carriage. In the iron and steel industry it is of great importance that the ash of the coal burnt or made into coke should be as free as possible from sulphur and phosphorus, as these elements subsequently find their way into the iron. The same consideration holds in the case of copper refining; the fuel must be as free as possible from sulphur and arsenic especially, since both of these elements have an injurious effect upon copper intended for electrical purposes. For steam boilers, coals which are only slightly caking and which yield a high temperature upon combustion are used. Anthracites and anthracitic coal are very much used for steam-raising, especially on sea-going vessels. Where the boiler is working under constant load, *e.g.*, in the case of Lancashire, water tube boilers of various types, and other stationary boilers, the fuel chosen is frequently slack or small coal. Such fuel contains a fairly large quantity of ash and moisture. The proximate analysis of such a fuel used in a large works for firing steam boilers is given as the mean of 15 analyses:—

	Mean.	Extremes.
Moisture . . .	7·04 %	5·00—11·50 %
Ash . . . . .	16·00 %	9·30—22·27 %
Volatile matter .	25·00 %	21·75—27·20 %
Coke . . . . .	67·96 %	64·10—71·00 %
Calorific power .	6,600 calories	6,000—7,600 calories

Such fuel does not burn too rapidly, and when burnt under induced draught, and mechanically fed into the furnace, it gives a very uniform evolution of heat, and maintains the steam pressure.

Locomotives, on the other hand, are liable to have very sudden demands made upon their resources, due to the weight of train, the condition of the rails and weather, the changing gradients, starting and stopping, etc.; hence it is necessary to have a coal capable of burning sufficiently quickly to evolve the heat rapidly enough to raise the requisite steam. For this purpose coal of the bituminous variety is employed, and not the anthracitic coals, the latter burning too slowly for this purpose.

Fine coal, especially fine caking coal, is difficult to burn for two reasons. Firstly, because it is liable to cake together, thus retarding the combustion by preventing free access of the necessary air; and secondly, because it falls through the grate and into the ashpit, and thereby escapes combustion. Fine coal is utilised by briquetting, *i.e.*, mixing with some binding material such as tar or pitch, and pressing into blocks resembling bricks. These will be described under the chapter heading "Artificial Fuels."

#### *Wood.*

The natural solid fuel, wood, must be briefly mentioned. Wood is seldom employed as a fuel on an industrial scale, and then only in such localities where coal is scarce. As a fuel wood leaves much to be desired. It consists of about 1 part of woody fibre and 2 parts of sap. The woody fibres are composed mainly of cellulose  $C_6H_{10}O_5$ , having the composition:—

Carbon . . . . .	44.44 %
Hydrogen . . . . .	6.17 %
Oxygen . . . . .	49.39 %

In addition to woody fibre, wood contains a certain quantity of mineral matter, which is left as ash upon combustion, and resins. The sap contains a water solution of various organic substances, sugars, dye-stuffs, starch, ethereal oils, and organic acids, together with certain inorganic substances. When burnt, wood leaves an ash, the amount of which differs for different

varieties of wood. On an average the ash varies between 0·10 per cent. and 4·0 per cent. ; but, again, differences exist between the various parts of the tree, the amount of ash being different in the leaves, branches, stem, and root. Wood ashes consist of carbonates of calcium, sodium, potassium, and magnesia, with phosphates, chlorides and silicates.

Wood contains a large amount of water when in the freshly-cut state. The quantity of water varies with the time of year. The average content of water in freshly-fallen matured trees is :—

Hornbeam . . . . .	20 %
Maple, birch, ash . . . . .	25 to 30 %
Common oak, box, silver fir, pine	35 ,, 40 %
Elder, fir . . . . .	40 ,, 45 %
Poplar, larch, lime . . . . .	45 ,, 50 %

Before use as a fuel the wood must be dried by cutting it into logs, removing the bark and exposing it to the air. In this way the wood loses from 30 to 40 per cent. of its original weight ; but nevertheless it still contains up to 20 per cent. of moisture. For the more complete drying of wood a relatively high temperature must be used. The temperature at which it can be dried is limited by the temperature at which it begins to decompose, *i.e.*, dry distillation begins to take place. This temperature is about 200° C. Wood dried at high temperatures is very hygroscopic, and takes up moisture with great readiness, the amount of water taken up depending upon the state of the atmosphere to which it is exposed.

The value of wood as a fuel is poor, the calorific power being between 2,500 and 5,000 calories (4,500 and 9,000 B.T.U.), and it evaporates from 3·5 to 5·0 times its weight of water. The calorific power depends greatly upon the dryness of the wood and also upon the ash content.

## CHAPTER VIII

### ARTIFICIAL SOLID FUELS

WHEN wood, peat, or coal are subjected to dry distillation, *i.e.*, heated out of contact with the air to a high temperature, four main products are obtained, *viz.* :—

(1) Gas; (2) A watery liquid; (3) Tar; and (4) Carbonaceous residue.

This residue (known as charcoal or coke, according as its origin is wood or coal) is of great value as a fuel, and presents certain advantages as a fuel over the material from which it is made. The advantages gained by coking or carbonising a fuel are :—

(1) A fuel of higher calorific power is obtained because the resulting product is richer in carbon and also because the fuel has lost certain volatile constituents, which, although themselves partially combustible, require heat for their volatilisation, and hence utilise a portion of the heat of combustion and so diminish the quantity of heat available for other purposes.

(2) The bye-products, gas, tar, and watery fluid are commercially valuable, being sources of the supply of many important substances, such as benzene, carbolic acid, coal tar naphtha, etc., from coal tar.

(3) The carbonised fuel burns without smoke.

• (4) It does not fuse or sinter in the fire, and hence enables a free air supply to be maintained and consequently regular combustion.

(5) Sulphur is partially removed during carbonising or coking. The necessity for low sulphur content in fuels has already been mentioned.

On the other hand, there are certain disadvantages :—

(1) Coking or carbonising requires a special plant, and where the bye-products are recovered, a very elaborate plant is necessary.

## 140 AN INTRODUCTION TO THE STUDY OF FUEL

(2) It also requires labour and an expenditure of heat for the coking.

(3) The quantity of ash present in the fuel is increased by carbonising.

As an example of the changes brought about in coking, the following will indicate the difference between the original coal and the coke prepared from it.

	Water %	Ash %	Carbon %	Hydrogen %	Oxygen %	Nitrogen %	Sulphur %
Before coking	18.77	10.05	58.44	3.75	5.99	1.08	1.92
After coking .	—	19.77	75.10	0.49	2.39	0.58	2.63

In this case the content of sulphur is increased; this is probably due to the large quantity of mineral matter which remains as ash, the sulphur combining with this mineral matter, either as sulphides or sulphates.

The processes by which charcoal and coke are made will now be described.

### *Charcoal Burning.*

The methods by which wood is carbonised for the preparation of charcoal resolve themselves into two great classes.

(1) Those in which the carbonisation is effected without the recovery of the bye-products.

(2) Those in which the bye-products are recovered.

In the first case the heat necessary may be supplied by the combustion of a portion of the wood under carbonisation as in the old methods of carbonising wood in heaps or kilns; in the second case, the heat may be supplied from an external source, *i.e.*, the heating may be done in a suitable retort.

The operation of charcoal burning without the recovery of bye-products is done in kilns or piles.<sup>1</sup> The burning takes place in the neighbourhood of the forests from which the wood is obtained. A dry, sheltered locality is selected and the ground

<sup>1</sup> The German name "Meiler" = heap is often used to denote a charcoal kiln of this type.

levelled where the pile is to be burnt, and covered with a layer of small charcoal or wood ashes. A straight trunk is placed in the centre, and round this the wood is piled, part lying horizontal and part leaning towards the centre pole, a few pieces only round the centre pole being in a vertical position. The top of the pile consists of smaller pieces of wood, such as small branches. The pile is then covered over with leaves and turf and finally with earth, sand, or wood ashes. This covering does not at first reach to the bottom of the pole, but is kept in position by props and stays of wood. A channel is usually left at the bottom for the purposes of firing the pile. In other cases a sort of central chimney is formed by three long straight logs or planks placed together so as to form an equilateral triangle. This chimney serves as a position for firing the pile, and also for directing the progress of the combustion. The pile is fired by introducing into the channel or the central chimney wood shavings and pieces of dry wood and igniting. When the burning has started, it spreads upwards and outwards, and drying of the wood results. The hygroscopic water which is evaporated condenses on the surface of the pile, *i.e.*, the pile sweats. As the burning proceeds, acid vapours and combustible gases are formed below the covering of the pile, and as these become mixed with air and ignite, explosions take place, occasionally with sufficient force to displace a portion of the covering. When this occurs, the damage has to be made good as quickly as possible. This stage is known as the "striking" or "throwing" of the pile, and lasts from eighteen to twenty-four hours. When the centre shaft has been burnt out, the space so made is filled up again with wood, and the filling up repeated until the "sweating" ceases. The pile is then covered down to the bottom, and by making vents in suitable places the fire is worked downwards. This is known as the "driving" of the pile. When the thick yellow smoke which first escapes at the top of the pile changes to a light blue colour, the opening on the top of the pile is covered in, and as soon as flame appears at the bottom vents, they are closed also. It is necessary from time to time to consolidate the partially charred wood together, and for this purpose part of the covering is removed and the wood is raked together with a pole. The

covering is then replaced, the whole operation being conducted as expeditiously as possible, so as to avoid undue loss of charcoal by free burning of the wood. When the charcoal burner judges from the appearance of the smoke issuing from the lower vents, that the whole of the wood is completely carbonised, all the vents are closed and the covering of the pile made as impervious to air as possible. The pile is then left for several days until it is finally "drawn." For this purpose the covering is removed, the hot charcoal quenched with water or damp earth, and then taken from the pile and subsequently sorted. The main object of the charcoal burner is to conduct the process in such a manner as to ensure combustion proceeding from the centre to the circumference, and also from the top to the bottom of the pile. This is done by suitably regulating the air supply and by making good any hollow spaces, formed by the wood burning, as they occur. The time occupied in carbonising wood varies according to the size of the piles and the condition of the wood. Piles of 1,000 to 3,000 cubic feet capacity require eighteen to twenty days for completion of the process.

Charcoal is also made in rectangular heaps or piles, having a length of 10 to 14 yards and a width of 2 to 4 yards. The air-dried logs are laid at right angles to the long axis of the pile and covered on the outside by planks or lattice work, held in position by posts. Ignition and draft flues are left in the pile and the intermediate spaces filled up with small pieces of wood. The pile is sloped in the direction of its long axis, and the height is about 2 ft. at the lower end and 3 ft. at the higher end. The pile is covered with earth and turf on the upper surface, and is ignited at the lower end. When the burning has commenced, the fire is controlled so that burning proceeds slowly along the length of the pile.

By a modification of the above process the tar formed during the destructive distillation of the wood is recovered. The base of the pile consists of a brickwork hearth which slopes towards the centre. A canal or drain leads from the centre, sloping downwards to a suitable tar vessel. The tar formed during the process runs down this drain and collects in the tar vessel. In this way up to 20 per cent. of tar can be collected from some



varieties of wood. The yield of charcoal varies with the species of wood carbonised, from 30 per cent. to 60 per cent. of the dry wood. Wood is also carbonised in closed retorts, the heat being supplied from external sources, and the bye-products, gas, wood spirit, and tar recovered. The gas is frequently used for burning under the retorts, the tar is used for various purposes, and the wood spirit is worked up for acetic acid, acetone, and methyl alcohol. The charcoal resulting from any of the carbonisation processes is by no means pure carbon, but contains, in addition, hydrogen, oxygen, ash, and unless artificially dried, hygroscopic water. An analysis of wood charcoal gave the following figures:—

	Air Dried %.	Completely Dried %.
Carbon . . . . .	75.5	83.0
Hydrogen . . . . .	2.5	2.7
Oxygen . . . . .	12.0	13.2
Ash . . . . .	1.0	1.1
Moisture . . . . .	9.0	0.0
	100.0	100.0

The calorific power of an average sample of wood charcoal of good quality is 6,000 to 7,000 calories (10,800 to 12,600 B.T.U.).

Charcoal is used in blast furnaces in Sweden for making certain qualities of iron, known as charcoal iron. This variety of iron is particularly pure, and is free from sulphur and phosphorus to a much greater extent than iron made with coke.

#### *Coke.*

The destructive distillation of coal is carried on for the production of illuminating gas on the one hand and for the production of coke on the other. In the first case, the gas is the important product, and the coke is secondary in importance to the gas. In the second case, coke is made on the large scale for iron and steel works, and foundry purposes, and the gas forms a product of secondary importance, the quality of the coke being

## 144 AN INTRODUCTION TO THE STUDY OF FUEL

the chief object aimed at. The dry distillation of coal yields four products, viz. :—

(1) A gas of a greater or lesser illuminating power according to the coal used.

(2) Gas liquor, a watery fluid, which contains a large amount of ammonia in the form of salts, and constitutes the most important source of ammonia and its compounds. This liquor is known as ammoniacal gas liquor or ammoniacal liquor of gas works.

(3) Tar.

(4) Coke.

The composition of the products of distillation vary with the composition of the fuel and also with the temperature of distillation. The influence of temperature upon the composition of the products has been investigated by L. T. Wright, who distilled a coal of the following composition.

Ash.	Carbon.	Hydrogen.	Sulphur.	Nitrogen.	Oxygen.
2·99 %	75·71 %	6·27 %	1·72 %	1·72 %	11·59 %

The dry distillation of 100 kilos. of this coal at 800° and 1,100° C. yielded :—

	At 800°		At 1,100° C.	
	Kilos.	Litres.	Kilos.	Litres.
Coke . . . . .	64·97		64·10	
Tar . . . . .	7·28 =	6·43	6·47 =	5·97
Gas liquor . . . . .	9·78 =	9·78	9·78 =	9·66
Gas . . . . .	12·23 =	21,140·00	15·11 =	3,120

The composition of each of these constituents was from 100 kilos. at 800° C.

	Carbon %.	Hydrogen %.	Sulphur %.	Nitrogen %.	Oxygen %.	Ash %.
Coke . . . . .	57·38	1·24	1·05	1·06	1·28	2·96
Tar . . . . .	6·11	0·46	0·05	0·06	0·60	—
Gas liquor . . . . .	0·08	1·06	0·12	0·22	8·30	—
Gas . . . . .	7·56	2·85	trace	0·36	1·46	—
Remaining in purifiers	0·22	0·02	0·39	0·56	0·56	—
Total . . . . .	71·35	5·63	1·61	1·71	12·20	2·96

When the same fuel is coked at 1,100° C. the composition of the products from 100 kilos. of coal was :—

	Carbon %	Hydrogen %	Sulphur %	Nitrogen %	Oxygen %	Ash %
Coke . . . . .	57.95	0.70	0.77	0.47	1.21	2.97
Tar . . . . .	4.78	0.38	0.06	0.05	1.18	—
Gas liquor . . . . .	0.08	1.06	0.13	0.21	8.30	—
Gas . . . . .	8.53	3.42	trace	0.86	2.30	—
Remaining in purifiers	0.38	0.04	0.74	0.02	0.93	—
Total . . . . .	71.73	5.61	1.70	1.61	13.95	2.97

Although the quantity of gas was increased at the higher temperature, the illuminating power of the gas had fallen from 18 c.p. to 15 c.p. The proportion of gas is increased by the addition of lime and silica to the coal before distillation, but its illuminating power is reduced. The yield of coke is also somewhat greater, but at the same time the ash is also increased, as the lime and silica remain with the ash.

Two periods have been recognised in the coking of coal. The first at 500° to 600° C., when a strongly illuminating gas, water vapour, and tar are evolved. The coal swells and forms coke. The second period at a much higher temperature, viz., 800° to 1,000° C., another evolution of gas occurs and the coke contracts in volume. It has been proposed to distil coal in two retorts, one at 600° C., which serves to distil off the gas and tar, and the second heated to a full white heat, to complete the decomposition of the coal, leaving the coke as residue. Experiments upon a small scale have shown that the ammonia is obtained at the second stage in the greatest quantity, but so far this process does not appear to have been used upon a large scale.

#### *Methods of Coking.*

Coal is converted into coke by methods somewhat similar to those employed in charcoal burning, viz., with and without the recovery of bye-products.

(1) *Coking without recovery of Bye-products.*

This is effected in piles, kilns and heaps. The coal is piled up round a number of posts, similar to those used in charcoal burning, which form chimneys and vents for the subsequent direction of the burning. In some cases a loose brickwork chimney is built in the middle of the pile instead of the wooden poles. The coal is

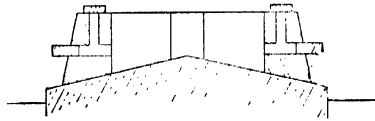

covered up with small coal, earth and turf, so as to keep the air from it during coking. During the coking the heat is supplied by the combustion of a portion of the coal, and the bye-products, tar and gas, are either burnt or lost. The process is extremely wasteful, but yields a fair quality of coke.

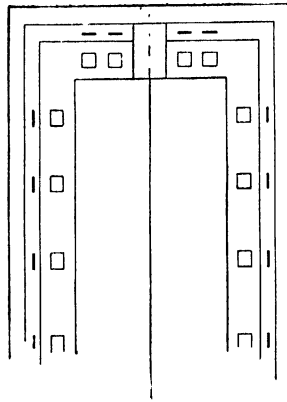

FIG. 44.—Stall for Coke Making.

The hearth of the stall slopes from the centre to the sides so as to drain away some of the watery liquor and tar formed during the burning. The air channels run in vertically and horizontally, and the burning of the coke is regulated by opening or shutting these air channels by a stopper or brick laid over the opening (Fig. 44).

One of the oldest methods of making coke of a very high quality, especially suitable for metallurgical purposes, is in the "Beehive" coke oven (Fig. 45). This form of coke oven is usually erected in a battery consisting of four or more ovens.

The horizontal section is square and the vertical section is like a beehive, whence the name. The ovens have charging doors at the side and an opening at the top which is sometimes used for charging, but mainly for the escape of the smoke, etc., during working. The heat is supplied, as in the preceding instances, by the combustion of a portion of the charge, the air supply being regulated by opening or closing the working doors. The charge is introduced either through the door or through the orifice at the top of the oven. It is stated that coke made from a charge introduced through the top opening is inferior in quality to that made from coal introduced through the working door. It is difficult to see why this should be, but a probable reason is that when the charge is introduced from the top the mass is much denser, and hence the middle portion does not become so thoroughly coked.

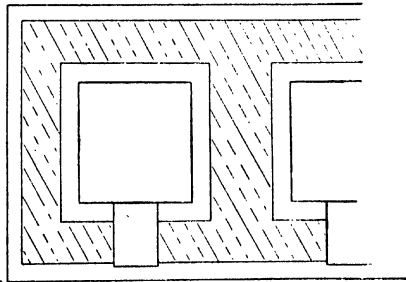
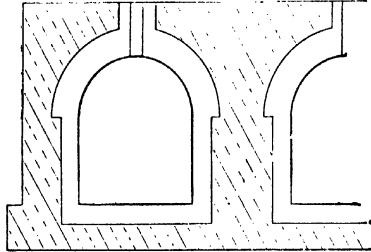

FIG. 45.—"Beehive" Coke Oven.

Owing to the greater density the gases do not have such free access through the mass, and the coking lacks uniformity. The method of working the ovens is as follows: Before the charge is introduced, a fire is lighted in the oven to heat it up. This is unnecessary if the oven has been working, but is necessary in starting up a fresh oven. Coal is then introduced and the oven fully charged. The working door and the top door are kept open and dense volumes of smoke are evolved. As soon as the smoke ceases the doors are closed and the oven allowed

to cool. After about 12 hours, or longer according to circumstances, the doors are opened and the coke raked out and quenched with water. The first batch or two of coke after the oven has been put into campaign is not of such good quality as that produced after the oven has been working for some time. The reason for this is probably that the heating is by no means uniform. After a few charges have been coked, the oven gets thoroughly heated up, and the coke produced is not so spongy as that produced at first, and the time of coking is shortened. No fire need be

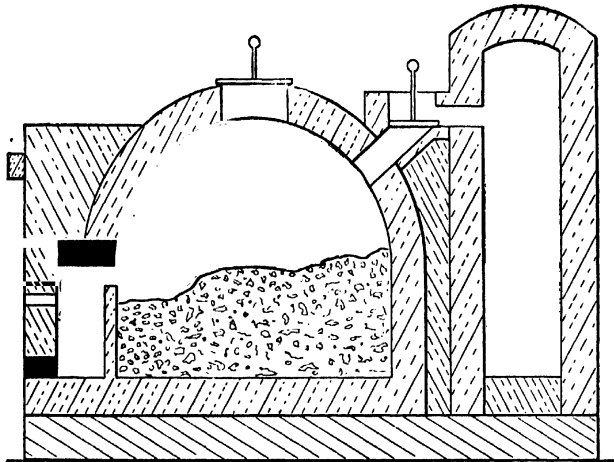

FIG. 46.—"Beehive" Coke Oven, Modified for Recovery of Bye-products.

kindled as at first, but the walls of the oven are sufficiently hot to ignite the coal, thereby starting the process of coking. This type of coke oven was a favourite for a long period, especially with ironmasters. It has been modified in several ways, and beehive ovens adapted for the recovery of bye-products have been erected (Fig. 46).

#### (2) *Coke Making with recovery of Bye-products.*

Owing to the great value of the bye-products obtained in the destructive distillation of coal, the number of ovens with a bye-product recovery plant increases yearly. These ovens are

essentially retorts which are heated externally, frequently by burning the gas generated in the coking operations, underneath

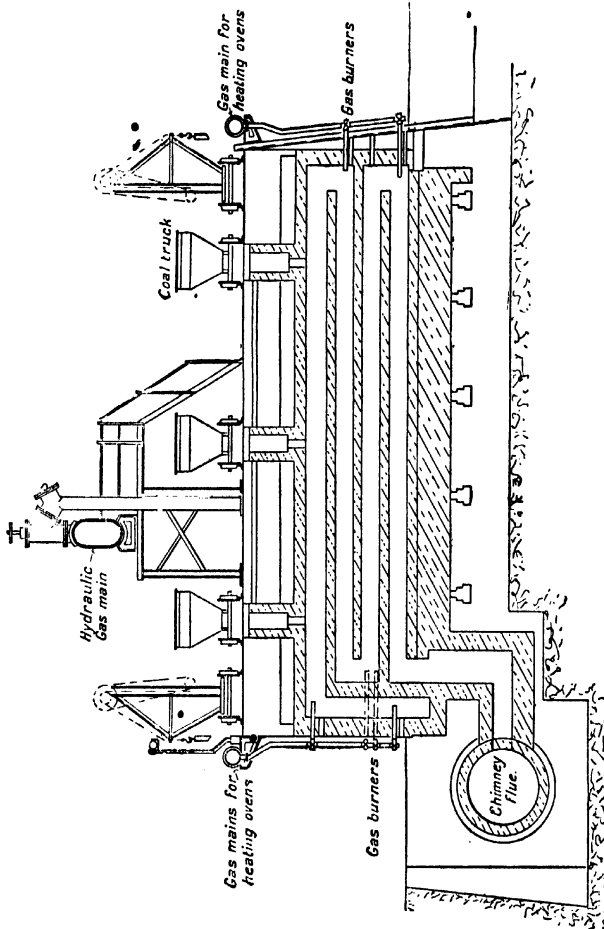

FIG. 47.—Huessener Coke Oven, Section through Flues.

the ovens. Ovens of this type are the Otto and the Huessener ovens. The Huessener will be described as typical of this class. The coking chamber is in section like an elongated  $\Omega$ , and has

openings at the top through which the charge of coal is introduced (Figs. 47, 48 and 49). The coal is carried in small trucks

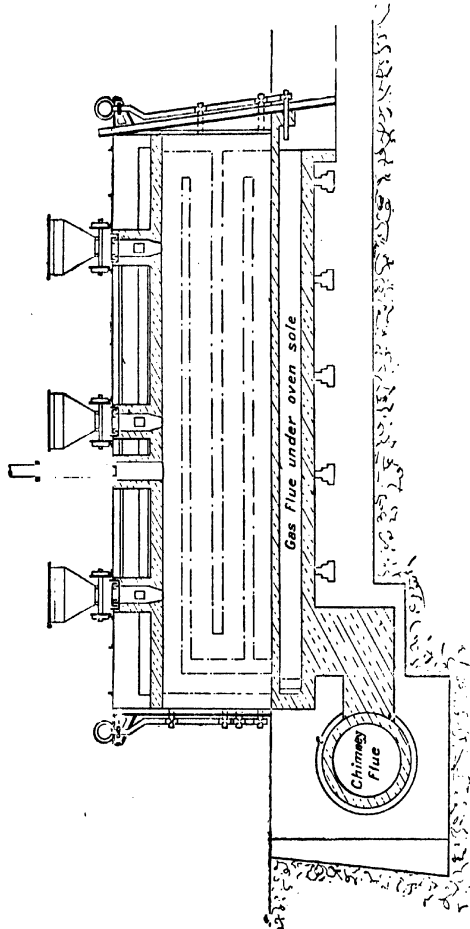

FIG. 48.—Huessener Coke Oven, Section through Oven.

which run on lines along the top of the coke ovens in a direction at right angles to their long axis. The coal is generally washed, so as to remove heavy mineral matter, thereby removing sulphur



present as iron pyrites,  $FeS_2$ , and reducing the ash. It then comes to the coke ovens in a very wet condition, for owing to it being finely powdered it holds a lot of water. The coal is dropped into the coking chamber through the charging doors, the bottom of the truck opening to discharge its contents. The coal is levelled with a rake put through a hole at the end of the chamber, and more coal charged in, until the oven is full. The charging doors and the end doors are then closed up and made gas-tight with a cement or fire-clay. The distillation products rise to the highest point of the oven and pass out through the tube provided to the hydraulic main, and there deposit out some of their tar. The gases then pass on to condensers and purifiers where they are deprived of their tar, ammonia, benzene and many other valuable products which are subsequently recovered. The gas, which has lost practically all its illuminating power, now passes back to the coke ovens where it is burnt in a combustion chamber with a regulated supply of air. The flame and heated gases pass underneath and around the sides of the ovens on the way to the chimney flue. The first period in the coking is the drying of the coal. During this period the temperature, actually measured with a recording thermo-electric pyrometer, does not rise above  $100^\circ C.$  ( $212^\circ F.$ ). This period lasts for about 10 hours in an oven holding 5 to 6 tons of coal. When the coal has been dried the distillation commences, and the temperature gradually rises until the maximum temperature is attained. This temperature is maintained until the coking is complete. When the coking is completed, about 32 hours from the commencement, the ends of the coking chamber are opened and the glowing mass of coke is pushed out by a ram which is worked by a steam engine running on rails by the coke ovens. The coke is quenched with a powerful jet of water from a hydrant, as it is pushed out, so that loss of coke by combustion is avoided. As soon as the coke has been removed from the coking chamber, a fresh charge of coal is introduced and the whole operation repeated, the process working continuously until the ovens require repairs. Coke ovens of this class are erected in batteries of 60 and upwards. The quality of coke prepared in these ovens is very high. It is hard enough for use

in iron blast furnaces where it has to stand the grinding weight of the furnace charge. It has a bright steel-grey appearance, and is at least equal to the best coke prepared by the older methods without the recovery of bye-products. For a long time it was believed that coke suitable for iron smelting in

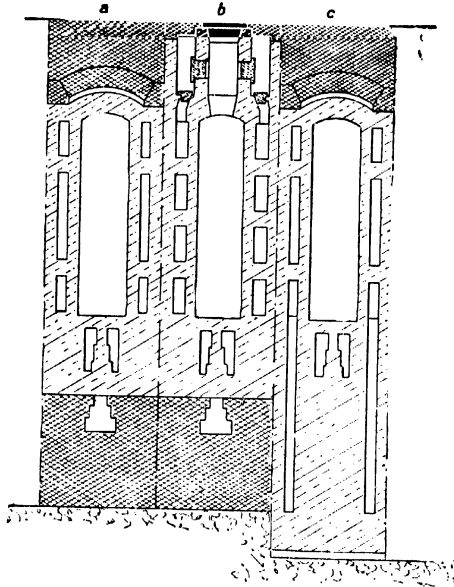

FIG. 49.—Huessener Coke Oven.

- a* Section through oven, rain side.  
*b* " " middle of oven.  
*c* " " oven, coke bench side.

blast furnaces could not be made in ovens with bye-product recovery plants, but this view has been exploded, and the use of this class of coke is steadily increasing in iron and steel works.

The following are a few actual details of the working of a Huessener coke oven plant, working at the Clarence Iron and Steel Works, Middlesbrough. The details were published by

C. Lowthian Bell in the *Journal of the Iron and Steel Institute*, No. 1, 1904.

The coal was finely ground so as to pass through a  $\frac{3}{16}$ -in. sieve and then washed. The change effected by washing is seen from the following figures, which are the mean of a year's analyses:—

	Before Washing.	After Washing.
Ash . . . . .	10·42	6·42
Sulphur . . . . .	1·71	1·30
Volatile matter . . . . .	28·67	29·47
Fixed carbon . . . . .	59·20	62·81

The coke made from this washed coal contained 8·18 per cent. ash, whereas if unwashed coal were used, the coke would contain 13·26 per cent.

After washing, the coal was allowed to drain for 48 hours before going to the ovens, when it contained 10·60 per cent. of water on the average. This is believed to have a good effect upon the quality of the coke, as it causes the coking to proceed more slowly, and hence the coke becomes denser and harder, an important consideration for blast-furnace coke.

The temperature in the mass of coal remains fairly constant at 212° F. during the first 10 or 12 hours of the coking; it then gradually rises up to 1,200 to 1,400° F. before the end of the coking, which occupies 32 hours. About 70 per cent. of the gas made by the ovens, 60 in number, is used for heating the ovens, being burnt in the heating flues. The products of combustion leave the oven flues at a temperature of about 1,500° F. and are then used for steam raising. For this purpose, boilers are placed in a suitable position and the hot gases passed under them. In this way 9 boilers, 30 ft. long by 8 ft. diameter, were heated by the hot gases, raising sufficient steam to work the exhausters and bye-product plant and then leave two-thirds of the steam available for other purposes. The remaining 30 per cent. of gas coming from the ovens is available

## 154 AN INTRODUCTION TO THE STUDY OF FUEL

for other purposes, such as illuminating. The gases coming from the ovens have, as an average composition—

Carbon dioxide . . . . .	1·2 %	by volume.
Carbon monoxide . . . . .	3·6 %	„
Marsh gas . . . . .	31·5 %	„
Ethylene . . . . .	1·5 %	„
Hydrogen . . . . .	55·5 %	„
Oxygen . . . . .	0·1 %	„
Nitrogen . . . . .	6·6 %	„
	<u>100·0</u>	

Its calorific power is 571·2 B.T.U.s. per cubic foot measured at 0° and 760 mm., or 5,079·7 calories per cubic metre at 0° C. and 760 mm. The gases leaving the heating chambers of the ovens consist of—

Carbon dioxide . . . . .	7·9 %
Oxygen . . . . .	3·5 %
Nitrogen . . . . .	88·6 %
	<u>100·0</u>

The yield of coke, calculated on dry coal—

Good quality coke . . . . .	72·04 %
Breeze (small coke) . . . . .	2·41 %

The analysis of the coke, on an average—

Moisture . . . . .	3·97 %
Ash . . . . .	8·18 %
Sulphur . . . . .	1·03 %
Volatile matter . . . . .	0·82 %
Fixed carbon . . . . .	86·00 %
	<u>100·00</u>

and all tests carried out on the coke in blast furnaces showed that the coke made in the ovens was equal, and even superior, to that made in the old, beehive process.

*Thermo-chemical Changes in Coking.*

Jüptner has made a number of calculations of the heat changes which take place in coking and gas-making processes, and as the results are important, they will be given briefly here. The heat of formation of a fuel is defined as the number of calories which are evolved when unit weight of the substance is formed from its elements, or conversely, the quantity of heat which must be absorbed in order to decompose it into its elements.

Two coals had the composition:—

	i.	ii.
Carbon . . . . .	73.55 %	60.91 %
Hydrogen . . . . .	4.54 %	4.22 %
Oxygen . . . . .	11.38 %	17.99 %
Nitrogen . . . . .	0.46 %	0.71 %
Moisture . . . . .	2.44 %	9.92 %
Sulphur . . . . .	0.60 %	0.52 %
Ash . . . . .	5.63 %	6.25 %
Calorific power determined in calorimeter . . . . .	7,493 cal.	6,013 cal.

The heats of combustion calculated from the composition are:—

$$\begin{aligned}
 \text{(i.) } & 0.7355 \times 8,080 = 5,942.84 \text{ calories from carbon.} \\
 & 0.0454 \times 29,600 = 1,343.84 \text{ „ „ hydrogen.} \\
 & 0.0060 \times 2,500 = 15.00 \text{ „ „ sulphur.} \\
 & \text{Total . . . } \underline{6,301.68} \text{ calories.}
 \end{aligned}$$

$$\begin{aligned}
 \text{and (ii.) } & 0.6091 \times 8,080 = 4,921.53 \text{ calories from carbon.} \\
 & 0.0422 \times 29,600 = 1,249.12 \text{ „ „ hydrogen.} \\
 & 0.0052 \times 2,500 = 13.00 \text{ „ „ sulphur.} \\
 & \text{Total . . . } \underline{6,183.65} \text{ calories.}
 \end{aligned}$$

Now the difference between the heat evolved in the combustion and that calculated from the composition is the heat

## 156 AN INTRODUCTION TO THE STUDY OF FUEL

absorbed or evolved in the formation of the fuel from its elements.

	I.	II.
Heat of combustion calculated . . .	6,301.68	6,183.65
"    "    measured . . .	7,433.00	6,013.00
Heat of formation of 1 gram coal . . .	-1,131.32	+ 170.65

The heat required to convert the coal into gas and coke depends upon the method of distillation and upon the nature of the products of distillation. For example, when coal is dry-distilled, the heat necessary for the "gasifying" of the coal is equal to the difference between the heat of formation of the coal and the heat of formation of the products of distillation from their elements.

### *Briquettes.*

The use of low grade fine coal in fires where any degree of heat is required is attended with many difficulties. The chief difficulties met with are the tendency of the fine coal to fall through the grate and escape combustion or to cake together and so clog the grate, allowing insufficient air to find its way into the furnace, thereby causing a poor, smoky fire and lack of heat. Attempts have been made to compress the fine coal by mixing with some suitable binding material and making into blocks like bricks. Various classes of coal, both bituminous and lignite, are used for this purpose, and the binding materials employed vary in different cases. Tar, pitch, asphalt, clay, plaster of Paris, molasses residues, starch paste, etc., have all been used. Briquettes have the disadvantages that they evolve a considerable quantity of smoke, and leave a large residue of ash when burnt. Briquettes are used on the Continent for domestic purposes, and also upon the railways. The calorific power varies from 2,800 to 3,300, calories 4,940 to 5,940 B.T.U.s. Recently (1908) the United States Geological Survey have made a series of

very complete tests upon the comparative values of briquetted coal and ordinary coal as a heating agent, especially for locomotive firing. The tests were carried out upon the locomotive fuel-testing plant at Altoona, Pa. This testing plant is a very complete one, and furnishes actual results, and allows careful comparative tests as to the heating value of different fuels to be made. The full description of this plant is published by the Pennsylvania Railroad system, and for the present purpose a brief description is all that is necessary. The locomotive used was a simple Atlantic 4—4—2 type passenger locomotive of the Pennsylvania Railroad Company. The firebox was of the Belpair type, 9 ft. 6 ins. long by 5 ft. 8 ins. wide, inside measurement. The grate area was 55·5 sq. ft., and the total heating surface 2,319·26 sq. ft. The grate was of the rocking Singer type. The boiler was about 15 ft. long, and was fitted with 315 tubes of 2 ins. diameter. The working pressure was 205 lbs., cylinders 20·5 ins. diameter, and 26 ins. stroke. The locomotive was held in position with the driving wheels resting upon supporting wheels, which allowed the machine to be running without travelling forward. The funnel passed into a shaft, so that the fuel ejected by the blast-pipe during working could be collected and measured. The temperatures in smokebox and firebox were measured by electric pyrometers, and the smokebox gases were analysed. The draught in firebox, smokebox, and ashpan were also measured. The coal or briquettes fired were weighed, and the weight of water evaporated also measured. By means of indicators and dynamometers the horse-power developed was measured, and so a very complete comparison of the locomotive performance was obtained. The conclusions deduced from these tests were:—

(1) The evaporation per pound of fuel is greater for the briquetted coal than for the coal in its natural state. This advantage is maintained at all rates of evaporation;

(2) The capacity of the boiler is considerably increased by the use of briquetted coal;

(3) Briquetting appears to have little effect in reducing the quantity of cinders and sparks; the calorific value of these, however, is less in the briquetted than in the natural coal;

## 158 AN INTRODUCTION TO THE STUDY OF FUEL

(4) The density of the smoke is less with briquetted than with natural coal;

(5) The percentage of binding material in the briquette has little influence upon the density of the smoke;

(6) The percentage of binder for the range tested, 5, 7, and 8 per cent., appears to have little or no influence on the evaporative efficiency;

(7) Briquettes, when carefully fired, can be used at railway termini with a considerable decrease of smoke;

(8) The briquettes appear to withstand exposure to the weather and do not suffer much deterioration from handling;

(9) The cost of briquetting under the conditions of the experiments added \$1 = 4s. 2d. per ton to the price of the fuel, and this increase does not seem to be warranted by the increase of evaporative efficiency gained by the briquetting.

Briquettes are used for locomotive firing upon most of the Continental railways, about one-half of the fuel in the tender of the locomotives consisting of briquettes, although on fast services the proportion of briquettes used was much less, about one-fourth only being employed. The locomotive requires careful management of fires, owing to the variation in demands made upon the engine, and also owing to the nature of the blast which supplies the air. This point will be discussed in a later chapter when considering forced and natural draught.



## CHAPTER IX

### GASEOUS FUEL

GASEOUS fuels have many advantages over solid and liquid fuels. For example, they can be much more easily brought to the furnace; they burn completely, without leaving a mineral residue; they burn with a flame which can be easily regulated, and by regulating the air and gas supply, the temperature can be kept under exact control, and the atmosphere within the furnace can be neutral, reducing or oxidising as may be required. This last point is of the greatest importance to metallurgists, and especially in the iron and steel industries. It is frequently advantageous to employ gaseous fuel for heating purposes, steam raising, smelting, and other operations; and the manufacture of heating gases is a question of the greatest importance to engineers and chemists alike.

*Natural Gas* is found in certain parts of the world, where it streams out of boreholes and is collected in suitable gasometers and utilised. The average composition of a number of samples of natural gas occurring in Pennsylvania, U.S.A., is as follows:—

Methane, Marsh Gas, $CH_4$	.67 %	}	Combustible.
Hydrogen, $H_2$	.22 %		
Ethane, $C_2H_6$	.5 %		
Ethylene, $C_2H_4$	.1 %		
Carbon Monoxide, $CO$	0.6 %		
Carbon Dioxide, $CO_2$	0.6 %	}	Incombustible.
Nitrogen	3.8 %		

Such a gas would be an extremely valuable fuel, since the combustible portion constitutes 95.6 per cent. of the total, and owing to the high percentage of methane and hydrogen would have a high calorific power. Natural gas, however, only occurs

in a few localities, and hence it is necessary to prepare heating gases by artificial means.

Gas for heating purposes is prepared by:—

- 1A. Dry distillation of coal, coal gas, or illuminating gas;
- 1B. Dry distillation of petroleum residues, oil gas, also dry distillation of various substances, such as wood, peat, etc.
2. The incomplete combustion of some form of carbon, *e.g.*, coal, coke, by air alone or with air and steam, as in the gas producer and water gas producer respectively.
3. For certain technical purposes quantities of acetylene, by the reaction of water upon carbide of calcium—

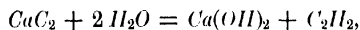

and hydrogen, by the action of hydrochloric acid upon zinc, are prepared chiefly for enriching illuminating gas or for the auto-genous welding of iron and steel. For the present, however, the important gases are producer gas and water gas, and these will now be discussed.

*Producer Gas* is strictly the gas obtained by the incomplete combustion of coke or charcoal in a current of air. It should therefore consist of a mixture of carbon monoxide and nitrogen, containing, when the reaction has been carried out to completion—

Carbon Monoxide	.	.	34·8	%	by volume.
Nitrogen	.	.	65·2	%	„

This is calculated as follows:—Air contains 21 per cent. oxygen and 79 per cent. nitrogen, by volume. When carbon is burnt in oxygen the volume of carbon monoxide is double that of the oxygen—

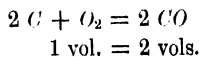

Therefore 100 parts by volume of air would yield 42 parts by volume of carbon monoxide, and 79 parts by volume of nitrogen, in all 121 parts, or 34·8 per cent. *CO* and 65·2 per cent. *N*<sub>2</sub>.

The gas actually obtained in a gas producer differs considerably from the above theoretical composition. If air in limited amount

is passed over strongly-heated coke or charcoal the carbon is partially burnt, forming carbon monoxide—

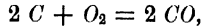

or representing the nitrogen upon both sides of the equation, it becomes—

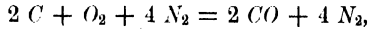

since the proportion of oxygen to nitrogen in air is very nearly one molecule of oxygen to four molecules of nitrogen. On the other hand, if the temperature is comparatively low, the carbon is burnt to carbon dioxide—

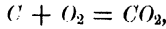

or

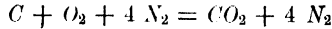

Again, carbon dioxide can react with strongly-heated carbon yielding carbon monoxide—

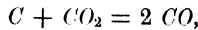

and under certain conditions of temperature carbon monoxide is decomposed into carbon and carbon dioxide :—

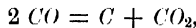

and hence this reaction can proceed in either direction according to conditions. Such a reaction is termed *reversible*, and is written thus :—

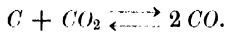

Within a certain range of temperature carbon monoxide can decompose into carbon and carbon dioxide, and above that temperature range carbon dioxide can burn carbon with the formation of carbon monoxide. It follows, therefore, that at each particular temperature and pressure the ratio of carbon monoxide to carbon dioxide concentrations will be constant, or—

$$\frac{C_{CO}}{C_{CO_2}} = K \text{ at constant temperature and pressure,}$$

where  $C_{CO}$  and  $C_{CO_2}$  are the concentrations of the carbon monoxide and carbon dioxide respectively. Expressed in other words, there will be a condition of equilibrium existing. The

effect of pressure upon the reaction can be deduced thus: The reaction—

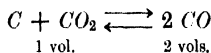

proceeds from left to right with an increase of volume; now from the theorem of Le Chatelier it follows that a rise of external pressure causes a change in the equilibrium conditions, as a result of which the pressure will be diminished, and conversely, a decrease in external pressure will cause such a change in the equilibrium conditions that the pressure will tend to increase; therefore a *reduction* of pressure favours the formation of carbon monoxide, and an *increase* of pressure favours the formation of carbon dioxide. An important practical point arises out of these considerations, viz., that the gas producer which is to produce the maximum of carbon monoxide should not be worked with a very high blast pressure. It further follows from the same theorem that every rise of temperature causes such a change within the system as tends to lower the temperature, *i.e.*, favours a change which absorbs heat. The converse is also true. For example, the reaction

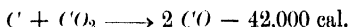

is favoured by rise of temperature, or, expressed otherwise, carbon monoxide is more stable at high temperatures than at lower.

Hence it follows that the composition of the producer gas is determined by the temperature and pressure at its formation and also upon certain other factors, such as size of coal, etc., inside of the producer, quantity of moisture in air, the thickness of the layer of fuel, and its porosity or density, and the velocity at which the air is blown through.

Jüptner has made a number of interesting calculations of the ideal composition of producer gas working with (1) atmospheric air and (2) air containing 50 per cent. of oxygen. The wind pressure was from 1 to 4 atmospheres. The chief deductions which can be made from the results obtained are:—

(1) In all cases the content of carbon dioxide in the ideal generator gas, at low temperature, is a maximum, and this remains constant to 400° C.;

(2) With rise of temperature the carbon dioxide content falls, and at 800° to 1000° C. is practically nil ;

(3) The content of carbon monoxide at 400° C. is practically nil ;

(4) The content of carbon monoxide has reached a maximum at 800° to 1000° ;

(5) The carbon dioxide content increases, at constant temperature, with the pressure, and hence with the oxygen content of the primary air ;

(6) The carbon monoxide content decreases, at constant temperature, with the pressure, and therefore with the oxygen content of the primary air ;

(7) At low temperatures the absolute content of carbon dioxide increases with the oxygen content of the primary air ;

(8) At high temperatures the absolute content of carbon monoxide increases with the oxygen content of the primary air.

In order, therefore, to obtain producer gas of the greatest possible heating value, and hence of the highest possible carbon monoxide content, it is necessary to have as high a temperature as possible in the generator. As a rule from 700° to 900° C. is sufficient, since the maximum content of carbon monoxide has been practically reached at this temperature. Again, at a high temperature of gas making, the yield of the generator increases with the content of oxygen in the primary air ; and, finally, high wind pressure is unfavourable to the production of producer gas containing the maximum content of carbon monoxide, as it favours the formation of carbon dioxide. The same conditions of temperature, etc., as above are assumed to hold here also.

It has already been pointed out that in practice the ideal composition is never attained. This arises from several causes. In the first case the air employed contains a certain amount of moisture, the quantity depending upon the atmospheric conditions. The carbon reacts with the water at a high temperature

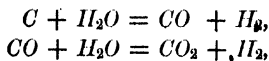

and in most gas producers a certain quantity of steam is blown

in with the air. These two reactions are extremely important, and will be considered when discussing water gas.

The combustion of fuel in a gas producer has been explained in the following way (Jüptner and Strache). Every layer of coal or coke consists of pieces of material of varying sizes, and between them are the air spaces. When the coal or coke is in pieces about as big as a fist, these air spaces will constitute from one quarter to one-fifth of the total cross section. These spaces allow the air to pass through the generator, and hence each piece of fuel is in contact with a layer of air only a few millimetres thick in some instances and several centimetres thick in others. Reaction between the fuel and air can only take place at the contact surfaces, and hence the question arises as to which reaction takes place first. It has been shown that when several reactions are possible the one that takes place first leads to the least stable product, the second reaction forming a more stable product, and so on until finally the most stable product is formed. Carbon monoxide is less stable at low temperatures than carbon dioxide, while at high temperatures the reverse is the case, and therefore at low temperatures carbon monoxide, at high temperatures carbon dioxide, will be first formed. These products will react with the air in the free spaces between the fuel and with the fuel itself as they pass up the producer. That is to say, that the carbon monoxide will be burnt to carbon dioxide by the oxygen of the air in the interspaces, and the carbon dioxide, if first formed, will react with the carbon and be reduced to carbon monoxide. The reactions are rendered possible partly by diffusion of the gases mixing them together, and partly by the mechanical mixing due to the passage of the gases through the fuel. At low temperatures, then, assuming that carbon monoxide is the first product formed, the reactions are: decomposition of the carbon monoxide into carbon and carbon dioxide

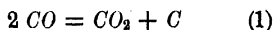

and combustion of the carbon monoxide by the oxygen of the air in the spaces between the fuel

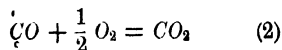

At higher temperatures, assuming that carbon dioxide is the first product formed, the reactions will be: combustion of some of the carbon by the carbon dioxide resulting in the reduction of the latter and the combustion of the carbon monoxide by the oxygen of the air in the interspaces

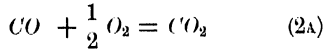
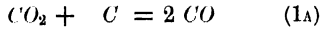

There are, therefore, two opposite reactions taking place, one at lower temperatures tending to prevent the attainment of equilibrium and at higher temperatures the reaction favours the attainment of equilibrium. Now, as the gases pass up the producer, the oxygen in the interspaces will be gradually used up, so that a point will be reached when there is no more oxygen and reactions (2 and 2A) are no longer possible, and hence the dominating reaction is:—

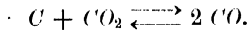

If, however, the current of gas through the producer is very rapid, then it follows that some of the oxygen in the interspaces will neither come into contact with the fuel nor be mixed with the carbon monoxide, and hence some oxygen will be found in the producer gas.

In order to study the reactions occurring in the gas producer, Boudouard passed air at different velocities through a tube filled with pieces of wood charcoal and heated to 800° C. and found:—

Velocity in litres per minute.	Composition of Products.			
	Vol. per cent.			
	CO <sub>2</sub> .	CO	O <sub>2</sub>	N <sub>2</sub>
0·10	18·5	5·2	—	76·6
0·27	18·43	3·8	0·47	77·30
1·30	18·92	1·88	0·94	78·26
1·4655	19·9	1·83	—	78·27
3·2	19·4	0·93	0·93	78·74

## 166 AN INTRODUCTION TO THE STUDY OF FUEL

At 800° C. the composition at equilibrium would be:—

Carbon dioxide . . . . .	0·92 %
Carbon monoxide . . . . .	34·82 %
Nitrogen . . . . .	64·76 %
	100·00

It is evident from these figures that equilibrium was not attained in Boudouard's experiment. The large proportion of carbon dioxide and comparatively small proportion of carbon monoxide favours the view that carbon dioxide is first formed, and owing to the rate at which the gases passed over the carbon, the reduction of the carbon dioxide to carbon monoxide had no time to take place. This raises another point in connection with the reactions in the producer, viz., rate of reaction. Reaction velocity can be defined as the change in concentration of a given constituent in unit time; for example, if carbon is burnt in air, then the quantity of carbon dioxide formed per minute is a measure of the velocity of the reaction.<sup>1</sup> Suppose that the formation of carbon dioxide from carbon and oxygen takes place more rapidly than the reduction of carbon dioxide to monoxide, then at high velocities of flow the amount of carbon monoxide should diminish, because the carbon dioxide which is first formed is swept over the carbon at such a rate that the reduction to monoxide has no time to occur. Again, the presence of oxygen together with carbon monoxide in the products can be explained on the grounds that either the reaction

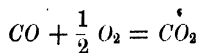

had no time to occur, or that, owing to the rapid flow of the gases, very imperfect admixture took place and the oxygen and carbon monoxide did not come into contact under suitable conditions for their combustion, and hence pass out and are cooled down to a temperature at which no combustion can take place. This happens also in cases where a furnace is carelessly worked with too strong a draught and with imperfect mixing

<sup>1</sup> See Chap. I, p. 10.



of the secondary air and products of combustion. When the producer is worked with coal instead of coke, in addition to the above changes, a partial distillation of the coal takes place, especially in the top layers of the producer. The gas made in such a producer will contain some products of dry distillation of the coal, especially just after fresh fuel has been introduced. As an illustration of the difference in composition of producer gas, caused by the difference in variety of fuel used, the following figures may be taken :—

	Wood %	Peat %	Coal %	Charcoal %	Coke %
<i>CO</i> . . . . .	29·8	26·2	28·7	34·1	33·8
<i>C<sub>2</sub>H<sub>4</sub></i> . . . . .	0·3	0·4	0·3	—	—
<i>CH<sub>4</sub></i> . . . . .	6·9	3·7	5·5	—	—
<i>H<sub>2</sub></i> . . . . .	6·5	13·5	9·0	0·2	0·1
<i>CO<sub>2</sub></i> . . . . .	6·0	7·4	2·5	0·8	1·3
<i>N<sub>2</sub></i> . . . . .	50·5	48·8	54·0	64·9	64·8
	100·0	100·0	100·0	100·0	100·0

The distribution of heat production and heat loss in a producer can be seen from the following table :—

## HEAT PRODUCED.

	Calories.	Per cent.
(1) Heat produced by chemical reactions in generator . . . . .	179666·4	26·67
(2) Heat brought in by fuel and air . . . . .	3397·9	0·49
(3) Heating value of the producer gas . . . . .	364028·0	54·05
(4) Heat in fuel and ash falling through grate . . . . .	126618·6	18·79
Total . . . . .	678645·9	100·00

168 AN INTRODUCTION TO THE STUDY OF FUEL

HEAT LOST.

	Calories.	Per cent.
(1) Heat lost through grate . . . . .	2316·1	0·34
(2) Heat lost in gases leaving the producer	28282·0	4·20
(3) Heat carried off in water in the producer gases . . . . .	12346·3	1·83
(4) Heat used in decomposing water in blast, etc. . . . .	8615·5	1·28
(5) Radiation loss and heat of vaporisation of coal . . . . .	94890·7 36553·5	14·09 5·42
Total . . . . .	183004·1	27·16

TOTAL HEAT LOSS.

	Calories.	Per cent.
Heat accounted for as above . . . . .	183004·1	27·16
Heat loss on fuel and ash falling through grate . . . . .	126613·6	18·79
Total . . . . .	309617·7	45·95

Heat gained and available for heating purposes = 364,028·0 calories = 54·05 %.

From these figures it is evident that a very considerable heat loss occurs by radiation and by the ashes and clinker falling through the grate. This loss is made up partly by the heat remaining in the ashes, etc., and partly by the unburnt fuel, which falls out with the ashes, etc.

An outline of the thermodynamit theory of the gas producer will be found in Chap. XI.

The producer plant will be described with the water gas plant after a discussion of the main reactions occurring in the manufacture of water gas.

*Water Gas*, as already mentioned, consists of a mixture of carbon monoxide and hydrogen, and is made by blowing steam over strongly heated carbon, usually coke. At high temperatures the reaction taking place is:—

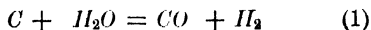

at lower temperatures

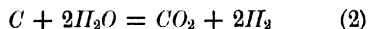

and hence these two reactions form, as products, a mixture of gases containing

Carbon monoxide	. . .	50	%	by vol.	}	I.
Hydrogen	. . .	50	%	„		

and

Carbon dioxide	. . .	33.3	%	„	}	II.
Hydrogen	. . .	66.7	%	„		
		100.0				

In order to arrive at a clearer understanding of the difference between producer gas and water gas it is necessary to consider the thermal as well as the chemical changes involved in the main reactions which occur. In the case of the producer the chief reaction is the formation of carbon monoxide from carbon and oxygen

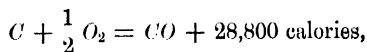

a reaction which takes place with the evolution of heat. In the combustion of carbon by steam as in the reactions

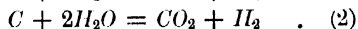
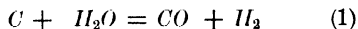

the thermal value of the reaction is the difference between the heat evolved in the formation of carbon monoxide in (1) or the heat evolved in the formation of carbon dioxide in (2) and the heat required to decompose the water. The heat of formation of carbon monoxide from amorphous carbon and gaseous oxygen is

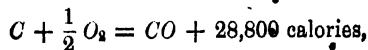

## 170 AN INTRODUCTION TO THE STUDY OF FUEL

the heat of formation of carbon dioxide from amorphous carbon and gaseous oxygen is

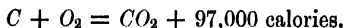

and the heat of formation of water from hydrogen and oxygen both gaseous is

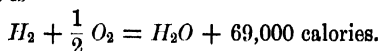

All the heats of reaction are expressed per molecule of the substance formed.

For reaction (1) the heat change is

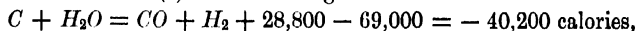

and for reaction (2) the heat change is

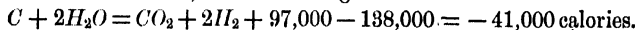

In both reactions heat is absorbed, and therefore heat must be supplied from without if the reaction is to progress, or, in other words, the temperature of the mass of carbon falls during the water gas formation, and unless the temperature is kept up, the reaction stops. This is a point of fundamental difference between the water gas formation and producer gas formation. The latter is formed with an evolution of heat, and hence the temperature of the producer is maintained during working without heat being supplied from external sources; while in the former case heat is absorbed during working, and hence the temperature of the water gas producer must be maintained by a supply of external heat. The manufacture of water gas thus resolves itself into two operations, one to get the mass of fuel to the correct temperature, and one to form the water gas. These are known as the hot blowing and gassing or steam blowing respectively. The process is therefore intermittent, and if the gas is to be used direct from the producer without the intervention of a gasometer, at least two producers must be employed so that one is heating up while the other is producing gas, and consequently being cooled down. The heating values of the three gases formed in the three reactions

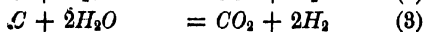
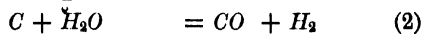
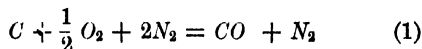

assuming the combustion to take place in air at constant pressure, are

$$\begin{array}{l}
 (1) \text{ CO} + 2\text{N}_2 = \text{CO } 33.3\% = 333 \times 68,200 = 22,710 \text{ calories.} \\
 \qquad \qquad \qquad \text{N}_2 66.7\% \\
 \qquad \qquad \qquad \hline
 \qquad \qquad \qquad 100.0 \qquad \qquad \qquad 22,710 \text{ ,,} \\
 \\
 (2) \text{ CO} + \text{H}_2 = \text{CO } 50\% = 0.5 \times 68,200 = 34,100 \text{ ,,} \\
 \qquad \qquad \qquad \text{H}_2 50\% = 0.5 \times 69,000 = 34,500 \text{ ,,} \\
 \qquad \qquad \qquad \hline
 \qquad \qquad \qquad 100 \qquad \qquad \qquad 68,600 \text{ ,,} \\
 \\
 (3) \text{ CO}_2 + 2\text{H}_2 = 33.3\% \text{ CO}_2 \\
 \qquad \qquad \qquad 66.7\% \text{ H}_2 = 667 \times 69,000 = 46,033 \text{ ,,} \\
 \qquad \qquad \qquad \hline
 \qquad \qquad \qquad 100.0
 \end{array}$$

It is evident from these figures that water gas has the advantage as a heating agent over producer gas. This is accounted for partly by the high proportion of combustible gas, 66.7 per cent. in (3) against 33.3 per cent. in producer gas, and partly by the fact that this gas is hydrogen, which possesses a high calorific power.

The above reactions have been considered on the presumption that they proceed completely in the sense of the equation, from left to right; reactions (2) and (3), however (like the producer gas reaction) do not go to completion, but reach a condition of chemical equilibrium which is defined by temperature and pressure. Thus from the two equations

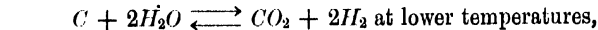
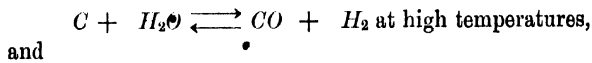

the equation

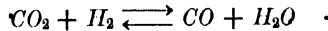

is obtained, in which one volume of carbon dioxide and one volume of hydrogen yield one volume of carbon monoxide and one volume of water vapour.

Then by the law of Mass Action

$$\frac{C_{\text{CO}} \times C_{\text{H}_2\text{O}}}{C_{\text{CO}_2} \cdot C_{\text{H}_2}} = K$$

at constant temperature and pressure, and, just as in the case of producer gas, the composition of water gas is definite for every temperature and pressure, if the reacting substances have been in contact for sufficient time for the equilibrium to be established. By means of certain thermodynamic equations the composition of ideal water gas at different temperatures and pressures can be calculated (see Chap. XI.).

In practice, equilibrium is seldom if ever attained. The reason for this can be explained in a similar way to that given in the case of producer gas. Jüptner gives the following explanation for the non-attainment of equilibrium in the technical water gas production. When steam is blown over a layer of incandescent carbon, a reaction takes place at the surface of the carbon, between the carbon and the water vapour, and it can be imagined that at this stage equilibrium is reached. The equilibrium is disturbed by the movement of the gases to other parts of the producer. This takes place partly by diffusion and partly by mechanical mixing of the gases, rich in water vapour with those from the outer layers where equilibrium has been reached. On the other hand, these gases also undergo change as they come into contact with more heated layers of carbon. If the current of the gases is from the cooler to the hotter layers of carbon, the carbon dioxide formed in the cooler portions of the generator will be reduced to carbon monoxide and the gas will become richer in carbon monoxide. If the current flows in the reverse direction, from the hotter to the cooler portions, then the carbon monoxide will decrease and the carbon dioxide increase in the resulting gas.

The composition of the water gas formed in any given process will depend upon the thickness of the layer of fuel and the velocity of the current of air in the heating stage, and of the current of steam in the gas-making stage, in addition to the factors considered above. Jüptner has shown that the composition of water gas depends upon :

(1) The time of contact of steam and carbon, and hence upon the velocity of the blast of steam and upon the thickness of the layer of fuel.

(2) The ratio of the surface of the carbon to the volume of the interspaces.

(3) The reaction velocity, and therefore upon the temperature of the producer.

It follows from this that the composition of the water gas obtained will approximate more nearly to the equilibrium composition :—

(1) The smaller and more porous the carbon used, that is, the greater the ratio of the surface of the carbon to the volume of the interspaces.

(2) The thicker the layer of carbon.

(3) The more slowly the current of steam is blown into the generator.

(4) The higher the temperature.

Two investigators, Strache and Jahode, made a careful study of the effects of thickness of fuel, air and steam velocities, upon the production of water gas, both in the hot blow or heating and in the gas-making stages. They found that in the heating-up stage, when the temperature was comparatively low, carbon dioxide was the chief product, and practically no carbon monoxide, but as the temperature rose, more and more carbon monoxide was produced, and hence in the first stages of the "blow" less fuel was consumed and more heat evolved for a given volume of air than in the later stage, where carbon monoxide is formed.

This can be shown by considering the two reactions which take place. Assuming air to consist of one molecule of oxygen and four molecules of nitrogen, and assuming a volume of air indicated by the equations :—

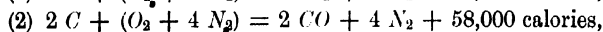
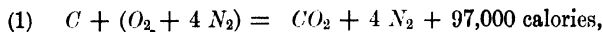

then it is evident in (1) that for a consumption of twelve parts by weight of carbon the heat evolved is 97,000 calories, while in the second case, (2), for twice the quantity of carbon consumed the heat evolved is 58,000 calories, or only about two-thirds of that evolved in the first case.

The gases leave the producer at a high temperature, and hence this occasions a very considerable loss of heat. The heat stored up in the producer by the "blow" is the difference between the heat evolved in the combustion and the heat lost. The heat

174. AN INTRODUCTION TO THE STUDY OF FUEL

lost in the hot gases of course increases with the temperature. Strache called the ratio

$$\frac{\text{Heat stored in producer}}{\text{Quantity of carbon used}}$$

the "efficiency by the hot blow," and from what has already been said, this will be high at the beginning, when the temperature is comparatively low, and will gradually decrease as the temperature and fuel consumption increase. The efficiency of the hot blow and the percentage of carbon dioxide at different temperatures are as an average:—

Temp. C°.	625°.	672°.	920°.	1,300°.
Efficiency % . . .	80 %	70 %	40 %	30 %
CO <sub>2</sub> vol. % . . .	18 %	16 %	7.6 %	4.6 %

The efficiency falls rapidly between 650 and 900° and hence it is important that the temperature of the producer should not rise above 900°. During the gas-making period the loss of heat depends upon the velocity of the steam blast, and also upon the temperature of the producer. When the steam blast is too rapid, steam passes through the producer without undergoing decomposition, and owing to its high specific heat carries away a large quantity of heat from the producer. Again, when the current of steam is too slow, the yield of gas is poor and the losses due to radiation are relatively increased.

Hence the following relationships hold:—  
For a definite temperature in the producer:

Increase of velocity of steam blast results in increase of carbon dioxide and undecomposed water vapour in gases.

For a definite velocity of steam blast:

Rise of temperature results in decrease of carbon dioxide and undecomposed water vapour in the gases. At lower temperatures and lower velocity of steam blast carbon dioxide and water vapour content reaches a minimum.

The efficiency in the gas-making stage is calculated from the



heating value of the water gas made, the heat losses of the producer, and the fuel consumption. The heat losses of the producer are the sum of the heat lost in the hot gases, by radiation, and in the undecomposed water vapour. A maximum velocity of steam blast exists for every temperature at which the

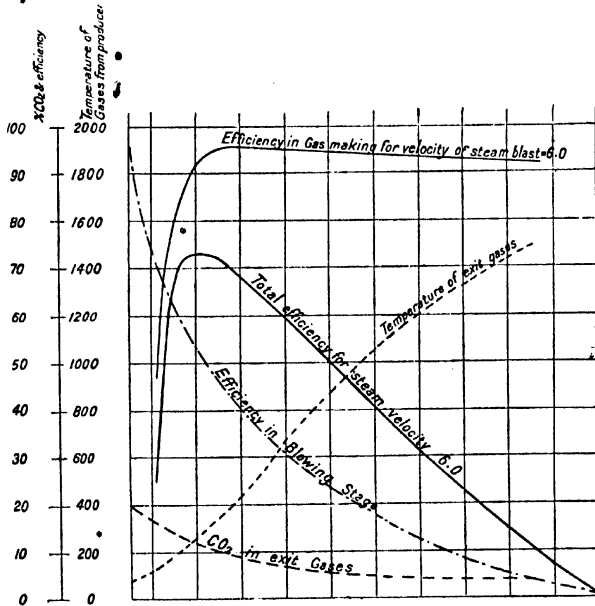

FIG. 50.—Efficiency of Water Gas Producer.

efficiency of the producer is a maximum. This efficiency is from 87 per cent. to 93 per cent.

From the efficiency in the "hot blow" process, and in the gas making, the total efficiency of the producer can be calculated. The total efficiency of the producer, working with a definite steam supply, is between 70 per cent. to 80 per cent.

Fig. 50 gives the various efficiencies of a producer, working with a definite steam supply, in the form of curves which show the relationship of temperature and efficiency in hot blow and gas making, temperature of producer and temperature of gases

leaving producer, carbon dioxide in gases leaving producer, and temperature of producer.

*Dowson Gas or Mixed Gas, and Blast Furnace Gas.*

The two processes of making combustible gas already considered involve the partial combustion of the carbon of coal or coke by the oxygen of the air or of water vapour, i.e. :

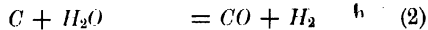
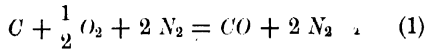

The gas resulting from (1) is of comparatively poor calorific power, but the process of manufacture is relatively easy to carry out, the process being continuous and in one operation. The gas resulting from (2) is of high calorific power, but since the reaction proceeds with absorption of heat it has to be carried out in two stages, and hence the process is intermittent. The heat evolved in reaction (1) is 29,000 calories, and the heat absorbed in (2) is 40,200 calories; and hence the production of a gas consisting of a mixture of water gas and producer gas in one operation is possible by so arranging the process that sufficient heat is evolved by reaction (1) to keep the temperature of the generator sufficiently high for (2) to take place. In order to effect this, two atoms of carbon must be burnt to carbon monoxide by the air blast for every one atom of carbon converted into gas by the water vapour.

The reaction is represented by the equation

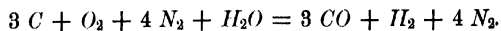

The composition of the gas resulting from this reaction is

Carbon monoxide . . . . .	37.5 %	by volume.
Hydrogen . . . . .	12.5 %	,,
Nitrogen . . . . .	50.0 %	,,
	<hr style="width: 100%; border: 0.5px solid black;"/>	
	100.0	

The heating value of this gas per molecule will be

$\cdot 375 \times 68,400 =$	25,575	calories, by combustion of $CO$ .
$\cdot 125 \times 69,000 =$	8,625	,, ,, $H_2$ .
Total . . . . .	<hr style="width: 100%; border: 0.5px solid black;"/> <u>34,200</u>	,,

On the other hand, the second reaction may take place viz :

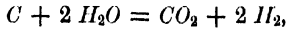

and hence the composition of the gas resulting from this reaction

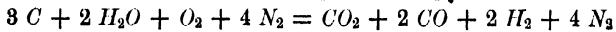

will be

Carbon monoxide . . .	22.2 % by volume.
Hydrogen . . .	22.2 % „
Carbon dioxide . . .	11.1 % „
Nitrogen . . .	44.5 % „
	100.0

The calorific power per molecule will be

$$0.222 \times 68,400 = 15,200 \text{ calories.}$$

$$0.221 \times 69,000 = 15,333 \text{ „}$$

$$\text{Total . . . } \underline{30,533} \text{ „}$$

There is a very considerable lowering of the calorific power of the water gas by the apparent gain in simplicity. The above examples are the ideal cases of the two varieties of Dowson or "mixed" gas. In practice it is not possible to carry out the process, so that for every atom of carbon converted into gas by the steam, two are burnt by the air blast; in fact, it is frequently the case that three and even five atoms of carbon are converted into producer gas for every atom of carbon converted into water gas. The gaseous mixtures obtained in these cases would contain three or five volumes of producer gas to every one volume of water gas, and consequently the heating value of the mixed gas is still further reduced.

*Blast Furnace Gas* was, practically the first gas to be used as a fuel on a large scale. The gases escaping at the top of an iron blast furnace contain a considerable proportion of combustible gases, and these are collected and burnt in stoves used for heating the blast, and under boilers for steam raising, and also in explosion motors. For the last purpose they have to be freed from the dust which they contain much more completely than in the other instances. The blast furnace acts as a gas producer owing to the peculiar conditions which prevail in it. The chief reactions and conditions which lead to the formation of the combustible gas are as follows.

The charge of the blast furnace consists of limestone  $CaCO_3$ , coke, and ferric oxide  $Fe_2O_3$ , and these are introduced into the furnace through the top, which is fitted with an arrangement for closing the furnace and enabling the gases to be collected. The air is blown in, under considerable pressure, near the bottom of the furnace, and this portion is at the highest temperature. The iron is fully melted at this point, and as the temperature is high and the velocity of the blast is also high, the carbon is burnt to carbon dioxide. As this passes up the furnace, the carbon dioxide reacts with more carbon, and is reduced to carbon monoxide, which in turn reduces some ferric oxide,

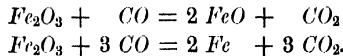

Further, the carbon monoxide is decomposed by spongy iron, into carbon and carbon dioxide,

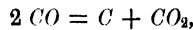

and the limestone is decomposed into lime and carbon dioxide,

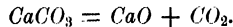

All these reactions are reversible, and hence reach equilibrium if in contact for sufficient time. The gases which make their way up the blast furnace consist of a mixture of carbon monoxide, carbon dioxide, and nitrogen, accompanied by small quantities of hydrogen and methane, which are formed by the decomposition of the water vapour in the blast or in the <sup>iron</sup> etc., and the methane from the volatile matter contained in <sup>the</sup> etc.

The average composition of blast furnace gas varies between the following approximate limits:—

Carbon monoxide	. 20 to 33	% by volume.
Hydrogen . . . .	. 0.1 ,, 5.0	% ,,
Methane . . . .	. 0.1 ,, 2.5	% ,,
Carbon dioxide . .	. 4.0 ,, 17.0	% ,,
Nitrogen . . . .	. 56 ,, 63	% ,,

The heating value of this gas is fairly high, and as enormous quantities are produced during the working of a blast furnace, it forms a very valuable fuel in an ironworks, for the two purposes already mentioned.

## CHAPTER X

### THE MANUFACTURE OF PRODUCER GAS AND WATER GAS

THE appliances used in making producer gas are of very various design, but in principle they are similar to a blast furnace. They consist essentially of a shaft which is filled with the fuel and fitted with a suitable arrangement for blowing in the air, (or in

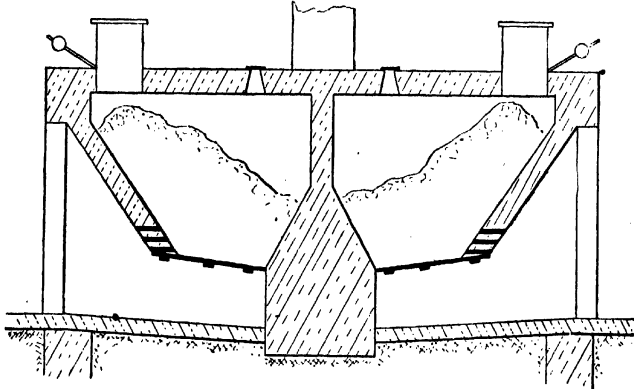

FIG. 51.—Siemens' Producer.

most cases, air and steam) and a pipe for leading the gas to where it is to be used.

One of the simplest types of gas producer is the Siemens gas producer. This consists of a rectangular chamber with one side sloping down to the grate and the bottom closed by a plate. The outline of a Siemens producer is shown in Fig. 51. The producer is built with a common wall which separates it from the next producer. The sloping side reaches to the fire bars, and the closing plate closes the bottom of the producer. The fuel is introduced through the hopper, and forms a sloping layer on the side and bottom. The air is blown in through

the fire bars at the base of the producer. The gas is taken off through the gas main and led to the places where it is required. The small holes serve for introducing a poker to stir the fuel when it does not allow the air to pass freely through owing to fuel caking or sintering. A number of such producers are placed together and the gas collected in a common gas main. The hopper for filling the producer is seen in Fig. 52 in greater detail. The hopper consists of two parts, the lid, which is sealed by a trap containing sand or tar during working, and the trap-door, which can be opened and shut by the balanced lever. The hopper is worked in the following way: The trap is closed and the lid removed. The fuel is introduced into the hopper until full, when the lid is replaced. The trap-door is then

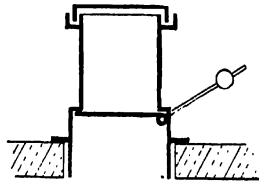

Fig. 52.—Hopper on Producer.

opened and the fuel drops into the producer, the trap-door again closed and the operations repeated. In this way fuel can be introduced into the producer without the gas escaping through the hopper. On account of the poisonous nature of carbon monoxide great care

must be exercised in all cases where producer or water gas is used. The tar, etc., pass down to the more strongly-heated portion of the producer and there undergo decomposition and partial combustion, and hence, even when coal is used, comparatively little tar is formed. In certain forms of Siemens producers the middle dividing wall is removed and a double producer is thereby formed. The gas passes into a common gas-main, and each double producer is provided with its own valve so that each can be cut off for repairs, etc., without interfering with the working of the remainder. The ashpit of the producer contains some water for quenching the ashes and clinkers which fall or which are raked out from time to time. The steam evolved passes into the producer and improves the quality of the gas, owing to the formation of a small proportion of mixed gas. These producers are known as step-producers.

The gas producers most generally used are shaft producers,

## MANUFACTURE OF PRODUCER AND WATER GAS 181

and consist of an upright shaft provided with a hopper at the top for introducing the fuel, a gas flue, and an arrangement for blowing air or air and steam into the producer at the bottom. These producers have an ashpit in some cases, in others the bottom is closed by a water seal. They are called dry and wet bottom producers respectively.

Many producers are in principle similar to a blast furnace and are worked with small coal or slack. The blast consists of air

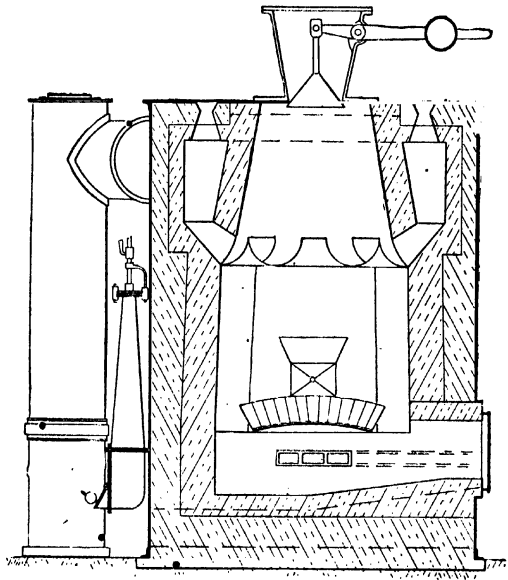

FIG. 53.—Wilson Producer.

with a certain proportion of steam, which not only improves the quality of the gas, but renders the clinkers which are formed to be more easily removed. Shaft producers are also worked by chimney draught and are frequently built close to where the gas is to be burnt. The Wilson producer is greatly used and consists of a cylindrical body built out of boiler plate and lined inside with refractory fire bricks. The top is closed by a cone which fits into the hopper. The hopper is in turn closed by a lid in a similar

manner to that shown in Fig. 53, so that fresh fuel can be introduced into the producer from time to time without interrupting the working, and without allowing the gas to escape into the air. The gas is collected in the annular space at the top of the producer and led away through the gas flue to the position where it is required. The blast is blown in through a blast pipe or tuyère together with a little steam, or in some cases the bottom is water sealed and the clinker and hot ashes falling into this water provide a supply of steam for the process. The gas formed in these producers, when coal is used as a fuel, contains in addition to carbon monoxide and nitrogen, small and varying quantities of hydrocarbons from the destructive distillation of the coal, and hydrogen from the decomposition of the steam by heated carbon. These additional constituents tend to increase the value of the gas as a heating agent. When the quantity of steam blown into the producer is relatively large the gas formed is mixed gas or Dowson gas.

*Water Gas.*—Water gas is used as a heating agent on account of its high calorific power and in admixture with coal gas and with certain hydrocarbons of the ethylene series ( $C_nH_{2n}$ ) as an illuminant. Water gas enriched with illuminating hydrocarbons, prepared by “cracking” oils, is known as carburetted water gas, and this gas is added to ordinary coal gas for increasing its illuminating power, but unfortunately it increases its poisonous nature at the same time, owing to the carbon monoxide present. It has already been pointed out that the decomposition of steam by strongly heated carbon is an “endothermic” reaction, *i.e.*, a reaction which absorbs heat, and hence the temperature of the carbon falls during the operation. For the process to continue the temperature of the coal or carbon must be maintained, and for this purpose three methods are possible.

(1) The air and steam are blown through alternately. The air blast generates either carbon monoxide as the chief product when run according to Humphrey and Glasgow’s method, or carbon dioxide when run according to the Dellwick-Fleischer method. The steam blast is then turned on, water gas is formed, and the temperature falls as the reaction uses up the



heat. The steam blast is kept on until the temperature reaches a certain limit, which is shown by the flame of water gas exhibiting the characteristics of a flame fed by poor gas. The steam blast is then cut off and the air blast turned on until the temperature is sufficiently high, when the cycle of operations is repeated.

The advantage of the Dellwick-Fleischer method is that the quantity of heat evolved in the reaction

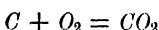

is nearly four times the heat evolved in the reaction

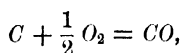

and thus the time necessary to raise the temperature to the required degree is shortened. On the other hand, the carbon monoxide formed in the first method can be used for heating purposes, such as steam raising or superheating the steam for the blast.

(2) The steam blast can be superheated. This method does not enable the temperature of the producer to be kept constant, and hence is not used in practice.

(3) The air and steam can be blown in together, so forming a mixture of producer and water gas. By suitably regulating the air and steam supply the temperature can be maintained constant and the process worked continuously (*cf.* p. 170 and *ff.*). This gas is known as Dowson gas or mixed gas, and the disadvantage of this method of working compared with (1) is that the heating value of the gas is very considerably reduced (*cf.* p. 176 and *f.*).

The water gas manufacture resolves itself into two main operations, the blowing in of air to raise the temperature of the fuel to the required degree, and the blowing in of steam for the production of water gas.

The producer used for the manufacture of water gas is shown in Fig. 54. The apparatus is designed for the production of water gas from coke or anthracite. It consists of a cylindrical body made out of boiler plate and lined with refractory fire bricks. The hopper H is for charging fresh fuel into the producer. The steam is blown in at the top through S, the air through

the bottom, via the valve. This valve is so arranged that the air can be admitted for "hot blowing" or it can be changed over to allow the gas to pass to the mains during "gas-making." During hot blowing, the waste gases pass along the flue F, which is fitted with a hydraulic valve for closing, this passage during gas-making. The gas made in the producer is subjected to a

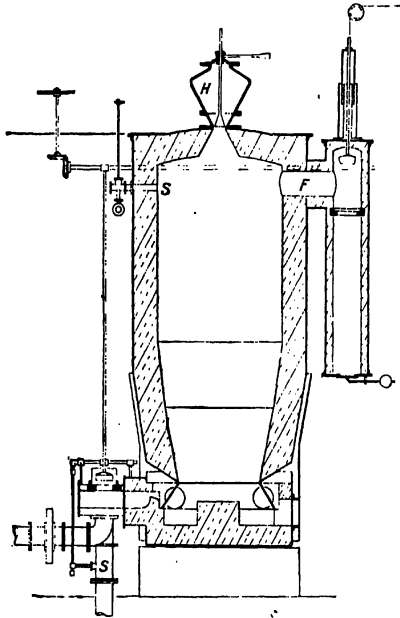

FIG. 54.—Water Gas Producer.

purification by passing through "scrubbers." These serve to remove sulphur compounds, especially sulphuretted hydrogen,  $H_2S$ , and also iron carbonyl,  $Fe(CO)_5$ . This latter impurity is especially injurious to incandescent mantles, as it is decomposed into iron and carbon monoxide by heat; the carbon monoxide is burnt and the iron deposits upon the mantle in the form of oxide and reduces the illuminating power of the mantle very rapidly. One method of removing iron carbonyl from water gas is to

wash the gas with concentrated sulphuric acid, whereby it is decomposed. Since water gas is practically odourless, an escape of gas could not be detected by smell, and poisoning by the CO and possibly explosion of the air gas mixture would result. In order to render it easy of detection in case of a leak, the gas is usually "perfumed" by the addition of some strong-smelling material. Carbylamine is frequently employed for this purpose, and when the "perfuming" is properly done, the escape of water gas can be easily detected, and its use is as safe as ordinary coal gas.

The heat evolved in the "blowing" process is very considerable, and the gases leave the producer at a high temperature. These gases contain a quantity of carbon monoxide which can be burnt and so made to yield up its heat. The loss of heat due to both causes is minimised by using it for various purposes. In the English system, the Humphrey and Glasgow system, the hot gases are passed through a regenerator, *i.e.*, an apparatus capable of being heated by the gases evolved in the blowing process, and the heat is utilised for some purpose connected with the process, such as superheating the steam, carburetting the water gas, or heating the air of the blast. In the regenerator the carbon monoxide present in the gases is burnt by secondary air, the supply of which is under control. In Humphrey and Glasgow's system this heat is usually employed for carburetting, by making oil gas, a gas rich in illuminating hydrocarbons, which is added to the water gas to supply its deficiency in this respect. In the Dellwick-Fleischer or Swedish System, where the blowing process is so conducted that the greatest possible quantity of carbon dioxide is formed, the heat loss is relatively small and the recovery of this quantity of heat is not feasible. If it is necessary to carburette the water gas, it has to be done by a cold process, *e.g.*, with benzene vapour. In Strache's system, where the blowing period is only from 1 to 2 minutes and the gas-making period relatively long (5 to 10 minutes), the waste heat is utilised either for carburetting or for superheating the steam according to the subsequent use of the water gas and method of manufacture.

*Suction Gas.*—Certain explosion gas engines are run on

producer gas made by the partial combustion of small coal. Instead of the air being supplied by a special blowing engine, the driving of which requires an expenditure of energy and,

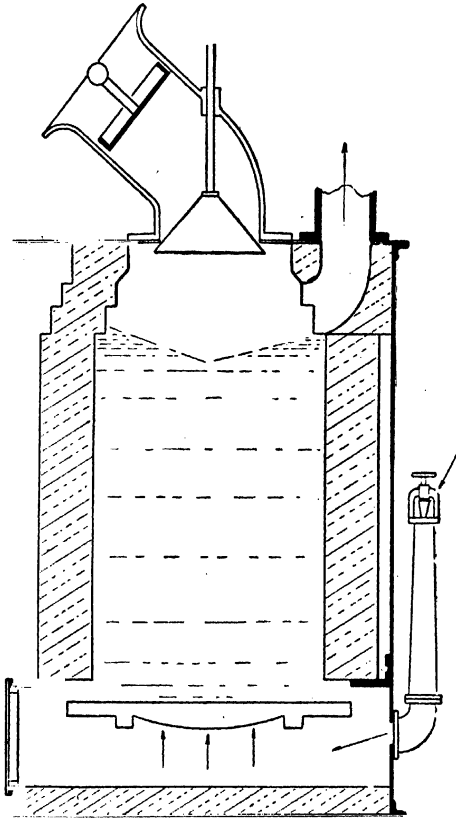

FIG. 55.—Suction Gas Producer.

therefore, of fuel, the air is supplied by the suction of the forward stroke of the piston. The section of a suction gas producer is shown in Fig. 55. These producers are so designed that the tar which is formed by the destructive distillation of the

## MANUFACTURE OF PRODUCER AND WATER GAS 187

coal passes from the cooler to the hotter parts of the producer where it is decomposed into a stable gas. The air is admitted into the producer from below the grate in the direction shown by the arrows, and in some forms of producer at the top and at the sides as well, whereby three strongly-heated zones are formed which serve for the decomposition of the tar.

*Blast Furnace Gas* is also used for driving explosion engines, but before use it must be purified from dust and tar, by passing through a suitable scrubber.

## CHAPTER XI

### THEORY OF THE PRODUCER GAS AND WATER GAS REACTIONS

It has been already pointed out in Chap. IX. that the reactions taking place in both the gas producer and water gas producer lead to a product, the composition of which depends upon several factors, and primarily upon temperature and pressure. Further, that if the gases and carbon (or coal) are in contact for a sufficient length of time, a condition of equilibrium is established and the composition of the gas is definite for every temperature and pressure. By means of the laws of thermodynamics it is possible to deduce an equation which enables the ideal composition of water and producer gas, made under any given conditions of temperature and pressure, to be calculated. This method of calculation is extremely important in the theory of gas producers and also for dealing with gas reactions as a whole. It serves as a means for checking the working of a producer, by enabling a comparison to be made between the theoretical composition and that actually obtained. Jüptner has made extensive calculations upon the theoretical composition of producer and water gas which are published in a monograph upon the subject, and this can be consulted for additional details. A brief outline of the salient points of the theory is all that will be given here (see Appendix).

The following cycle of operations are carried out when water, for example, is evaporated:—

(1) Let a quantity of water be evaporated at an absolute temperature  $T$ , ( $T = t^{\circ}\text{C.} + 273$ ) and at constant pressure  $P$ . The water is assumed to be contained in a cylinder closed with a frictionless, air-tight piston. A quantity of heat  $Q$  is absorbed by the water and the volume is increased from  $V_0$  to  $V_1$ .

(2) Now let the vapour expand adiabatically, *i.e.*, without the

aid of heat from external sources. The temperature of the system falls from  $T$  to  $T - dT$ , where  $dT$  is an infinitely small change of temperature and the pressure falls from  $P$  to  $P - dP$ , where  $dP$  denotes a small change of pressure.

(3) The vapour is now condensed at the constant temperature  $T - dT$ , and pressure  $P - dP$ , whereby a quantity of heat  $Q$  is liberated.

(4) The vapour is finally adiabatically compressed, whereby the temperature is raised to  $T$ , the pressure to  $P$ , and the volume is again  $V_0$ , hence the original condition of things are restored. This cycle of operations is graphically shown in Fig. 56.

The work done during this cycle is denoted by the area  $ABCD = AB \times AF$ .

Now  $AB = V_1 - V_0$  and  $AF = dP$ , and hence the work done is

$$W = dP (V_1 - V_0),$$

or expressed in heat units

$$W = \frac{dP (V_1 - V_0)}{J}$$

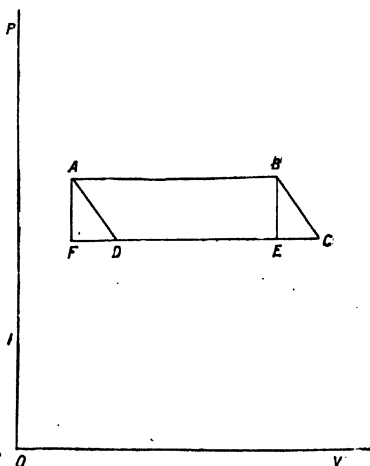

FIG. 56.—P. V. diagram.

where  $J$  is the mechanical equivalent of heat. The work done can also be expressed by aid of the second law of thermodynamics. The heat absorbed in the change denoted by  $AB$  in Fig. 56 is  $-Q$  calories, and that evolved in the change  $CD$ , is  $+Q$  calories, *i.e.*, the same quantity of heat, but in the first case the temperature was  $T$  and in the second  $T - dT$ . The work has been done by the quantity of heat  $Q$  falling from the temperature  $T$  to  $T - dT$ , and by the second law of thermodynamics the maximum work which this change can do is given by the equation

$$W = -Q \frac{dT}{T}$$

(minus sign because the heat is assumed to be absorbed by the system).

These two values for the work done in the cycle are equal, and hence

$$-Q \frac{dT}{T} = \frac{dP(V_1 - V)}{J},$$

or

$$Q \frac{dT}{T} + \frac{dP(V_1 - V)}{J} = 0 \quad (1).$$

Now from Boyle's law

$$PV = nRT$$

$$PV_1 = n_1RT,$$

where  $n$  and  $n_1$  are the number of molecules in the initial and final states respectively, hence

$$(V_1 - V) = (n_1 - n) \frac{RT}{P}$$

which can be substituted in (1)

$$Q \frac{dT}{T} + (n_1 - n) RT \frac{dP}{P} = 0 \quad (2)$$

$J$  disappears as the gas constant  $R$  is expressed in calories.

The law of mass action can be expressed thus for a general reaction :—

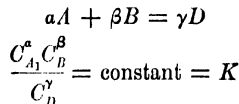

where  $C_A$ ,  $C_B$ ,  $C_D$ , are the concentrations of the reactants  $A$  and  $B$  and the resultants  $C_D$ , or it can be written :—

$$a \log C_A + \beta \log C_B - \gamma \log C_D = \log K,$$

or

$$\Sigma n \log C = \log K,$$

when this is differentiated,

$$d \ln K = d [\Sigma n \ln C] = 0,$$

and multiplying by  $RT$ ,

$$RT d \Sigma n \ln C = 0$$

is obtained. This can be added to (2) when the equation

$$Q \frac{dT}{T} + (n_1 - n) RT \frac{dP}{P} + RT d \Sigma n \log C = 0$$



is obtained, which can be written

$$Q \frac{dT}{T^2} + (n_1 - n) \frac{dP}{P} + d\Sigma n \log C = 0.$$

This equation can be integrated, when it becomes

$$\frac{1}{R} \int Q \frac{dT}{T^2} + (n_1 - n) \log P + \Sigma n \log C = \text{constant} \quad (3).$$

Applying this equation to the reaction

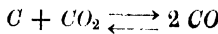

the values of the various factors are

$$R = 2.0$$

$$n_1 = 2$$

$$n = 1$$

$$(n_1 - n) = + 1$$

$$\Sigma n \log_e C = \log_e K = \log_e \frac{C^2_{CO}}{C_{CO_2}}$$

Equation (3) then becomes

$$0.5 \int Q \frac{dT}{T^2} + \log_e P + \log_e \frac{C^2_{CO}}{C_{CO_2}} = \text{constant} \quad (4).$$

The heat of reaction changes with the temperature and therefore  $Q$  must be expressed as a function of the temperature. The heat of reaction of

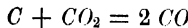

can be obtained from the heats of the two reactions

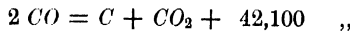
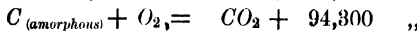
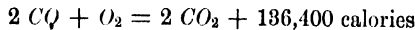

or  $C + CO_2 = 2 CO - 42,100$  at ordinary temperatures.

The reaction takes place, not at ordinary temperatures, but at a high temperature  $T$  absolute, and hence the heat of reaction must be corrected for this temperature by Kirchoff's law (see p. 124).

For this purpose the specific heats of the reactants and the resultants are required (specific heats at constant pressure are used) and expressed per molecule.

192 AN INTRODUCTION TO THE STUDY OF FUEL

$$C_p \text{ for carbon} = 2.87 + 0.0246 T$$

$$C_p \text{ for } CO_2 = 6.5 + 0.037 T$$

$$\text{Sum} = 9.37 + 0.0616 T$$

$$C_p \text{ for } 2 CO = 13.0 + 0.012 T$$

subtracting  $3.63 - 0.0496 T$

This gives the values for  $Q$  at temperature  $T$

$$Q_T = -42,100 + 3.63 T - 0.0496 T^2$$

and substituting this for  $Q$  in equation (4)

$$0.5 \int (-42,100 + 3.63 T - 0.0496 T^2) \frac{dT}{T^2} + \log_e P + \log_e \frac{C_{CO}^2}{C_{CO_2}} = \text{constant},$$

and upon integration this becomes

$$\frac{21,050}{T} + 1.82 \log_e T - 0.025 T + \log_e P + \log_e \frac{C_{CO}^2}{C_{CO_2}} = \text{constant}.$$

Converting the  $\log_e$  into  $\log_{10}$ , by multiplying by 2.3026, the expression becomes

$$\frac{21,050}{T} + 4.191 \log_{10} T - 0.025 T + 2.3026 \left( \log_{10} P + \log_{10} \frac{C_{CO}^2}{C_{CO_2}} \right) = \text{constant} \quad (5).$$

If the value of this constant is known, then the composition of producer gas, obtained under known conditions of temperature and pressure, can be calculated. The value of this constant has been calculated from Boudouard's measurements of the equilibrium

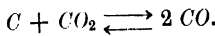

For this purpose Boudouard passed pure carbon monoxide over a suitable catalytic agent at constant temperature and pressure until equilibrium was reached; the composition of the gaseous mixture was then determined by analysis. The figures obtained were:—

° C.	T absolute.	CO %		Pressure in atmospheres.
		CO %	CO <sub>2</sub> %	
550	823	10.7	89.3	0.6
650	925	39.0	61.0	0.8
800	1,073	93.0	7.0	1.0
925	1,198	96	4.0	1.0

PRODUCER GAS AND WATER GAS REACTIONS 103

The value of the integration constant can be calculated by substituting these values in equation (5). The calculated values of the various factors are given in the table below. The pressures are expressed in atmospheres, but strictly they should have been expressed in grams per sq. centimetre, since  $K$  has been expressed in gram calories. This leads to a different value for the constant, but gives the correct value for the composition of the gas when used to calculate

$$\frac{C_{CO}^2}{C_{CO_2}} = K.$$

$t^\circ \text{C}$ . . . . .	550	650	800	925
$T$ absolute . . . . .	823	923	1,073	1,198
$\frac{21,050}{T}$ . . . . .	25.53	22.80	19.62	17.57
+ $4.191 \log_{10} T$ . . . . .	12.22	12.43	12.70	12.90
- $0.0025 T$ . . . . .	- 2.06	- 2.31	- 2.68	- 2.99
+ $2.3026 \log_{10} P$ . . . . .	- 0.51	- 0.22	—	—
+ $2.3026 \log_{10} \frac{C_{CO}^2}{C_{CO_2}}$ . . . . .	- 4.36	- 1.39	+ 2.51	+ 3.14
Constant . . . . .	30.82	31.31	32.05	30.62
Mean . . . . .	—	31.06	—	—

The composition of producer gas made by a producer working under known conditions of pressure and temperature can be calculated by substituting this value for the constant in equation (5), and solving it for

$$\log \frac{C_{CO}^2}{C_{CO_2}} = \log K.$$

$$\frac{21,050}{T} + 4.191 \log_{10} T - 0.0025 T + 2.3026 \log_{10} P + 2.3026 \log K = 31.06,$$

whence

$$\log K = \frac{31.06}{2.3026} - \frac{21,050}{2.3026 T} - \frac{4.191}{2.3026} \log_{10} T + \frac{0.0025 T}{2.3026} - \log_{10} P$$

$$\text{or } \log_{10} K = 13.49 - \frac{9,141}{T} - 1.82 \log_{10} T + 0.001086 T - \log_{10} P \quad (6).$$

194 AN INTRODUCTION TO THE STUDY OF FUEL

As an example the composition of producer gas made by the partial combustion of carbon with pure oxygen at a pressure of one atmosphere and the temperatures, 527°, 627°, 727°, 827° C., will be calculated. The values for log  $K$  and  $K$  are obtained by substituting the above temperatures expressed on the absolute scale, in equation (6) and solving. The values obtained are:—

$T$ absolute.	$\log K$ .	$K$ .
800	3·9283	$8·478 \times 10^{-3}$
900	1·1958	·1570
1,000	0·2221	·1667
1,100	1·0747	11·88

To calculate the volume percentage of  $CO$  and  $CO_2$  from these results, it is necessary to consider the significance of  $K$ . Thus

$$K = \frac{C_{CO}^2}{C_{CO_2}}$$

where  $C_{CO}$  and  $C_{CO_2}$  are the concentrations of the carbon monoxide and dioxide respectively, expressed as the amounts in unit volume of the mixture

and since

$$C_{CO}^2 = KC_{CO_2}$$

$$C_{CO_2} = 1 - C_{CO}$$

$$C_{CO}^2 = K(1 - C_{CO})$$

$$C_{CO}^2 + KC_{CO} = K$$

whence

$$C_{CO} = \frac{-K \pm \sqrt{K^2 + 4K}}{2}$$

and this result multiplied by 100 gives the volume percentage of carbon monoxide. For the above temperatures the composition is

$T$ absolute.	$CO$ % by volume.	$CO_2$ % by volume.
800	8·3	91·2
900	32·5	67·5
1,000	70·5	29·5
1,100	92·8	7·2

PRODUCER GAS AND WATER GAS REACTIONS 193

When the combustion is carried out with atmospheric air containing 21 per cent. of oxygen, the calculation is somewhat different, since the pressure changes during the reaction, according to the proportion of carbon monoxide and carbon dioxide formed. This can be arrived at in the following way: In air at atmospheric pressure the partial pressure of the oxygen and nitrogen is 0.21 and 0.79 atmosphere respectively. When the oxygen combines with carbon to form carbon dioxide the volume of the carbon dioxide is the same as the volume of oxygen, and its partial pressure is the same, viz., 0.21 atmosphere, but if carbon monoxide is formed the volume is doubled, and hence 100 volumes of air become 121 volumes of nitrogen and carbon monoxide, and the partial pressure of the carbon monoxide is

$$P = \frac{42}{121} = 0.347 \text{ atmosphere.}$$

The partial pressures of the carbon dioxide and monoxide in the generator gas can vary between the limits of 0.21 and 0.347 atmosphere.

In order to calculate the composition of producer gas for any value of  $P$ , the following considerations must be made. One volume of air contains 0.21 volume of oxygen and 0.79 volume of nitrogen. When air is passed over strongly heated carbon, let  $x$  be the quantity of carbon dioxide formed. Now carbon dioxide contains its own volume of oxygen, i.e.,

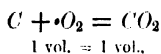

hence the quantity of oxygen remaining is

$$0.21 - x,$$

and this will yield 2 (0.21 -  $x$ ) volume of carbon monoxide, since

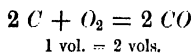

So when equilibrium is reached, the gases present are

Carbon dioxide	.	.	.	.	.	$x$	volume
Carbon monoxide	.	.	.	.	.	$0.42 - 2x$	„
Nitrogen	.	.	.	.	.	$0.79$	„
Total	.	.	.	.	.	<u><math>1.21 - x</math></u>	volume
						0 2	

196 AN INTRODUCTION TO THE STUDY OF FUEL

If the total pressure of the gas is 1 atmosphere, then the partial pressures of the three gases present will be

$$P_{CO_2} = \frac{x}{1.21 - x}$$

$$P_{CO} = \frac{0.42 - 2x}{1.21 - x}$$

$$P_{N_2} = \frac{0.79}{1.21 - x}$$

or if

$$P = p_{CO} + p_{CO_2}$$

then

$$P = \frac{0.42 - x}{1.21 - x}$$

$$x = \frac{0.42 - 1.21P}{1 - P}$$

and the volume percentage composition of the gas is

Carbon dioxide %

$$= \frac{x}{1.21 - x} \times 100 = \frac{0.42 - 1.21P}{0.79} \times 100.$$

Carbon monoxide %

$$= \left( P - \frac{x}{1.21 - x} \right) \times 100 = \left( \frac{2P - 0.42}{0.79} \right) 100.$$

Nitrogen % =  $(1 - P) 100$ .

The values so obtained are:—

$P$	.	.	0.21	0.25	0.30	0.32	0.3471
$CO$ %	.	.	—	10.1	22.8	27.8	34.7
$CO_2$ %	.	.	21.0	14.9	7.2	4.2	—
$N_2$ %	.	.	79.0	75.0	70.0	68.0	65.3

By means of these figures, the equilibrium constant  $K$  can be calculated and substituted in the equation

$$31.06 - 2.3026 [\log P + \log K] = \frac{1}{R} \int_0^T \frac{Q_T dT}{T^2} \quad (7),$$

and the value for the expression  $\frac{1}{R} \int_0^T \frac{Q_T dT}{T^2}$  obtained.

Again,

$$\frac{1}{R} \int_0^T \frac{Q_T dT}{T^2} = \frac{21,050}{T} + 4.191 \log T = 0.0025 T \quad (8),$$

PRODUCER GAS AND WATER GAS REACTIONS 197

and so a value for  $\frac{1}{R} \int_0^T Q_T \frac{dT}{T^2}$  can be calculated for every temperature or for the temperatures under consideration.

By means of a graph, made by plotting the values for  $\frac{1}{R} \int_0^T Q_T \frac{dT}{T^2}$  obtained from equation (7) against the pressures, the values of  $P$  corresponding to the values of  $\frac{1}{R} \int_0^T Q_T \frac{dT}{T^2}$  obtained from equation (8) can be read off. Then the figures obtained above are finally used to calculate first  $\log K$  and  $K$ , and then the percentage by volume of each of the constituents present. The values obtained for a pressure of 1 atmosphere as total pressure and different temperatures, are :—

$t^\circ \text{C.}$	527	627	727	827
$T^\circ \text{ absolute.}$	800	900	1,000	1,100
$\text{CO}$	5.8	17.1	29.6	33.7
$\text{CO}_2$	17.5	10.7	3.1	0.6
$\text{N}_2$	76.7	72.2	67.3	65.7

*Water Gas.*—The water gas equilibrium can be similarly treated, but the case is much more complicated. The equilibrium is indicated by the equation

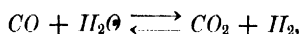

and is accompanied by an evolution of heat of 10,100 calories at ordinary temperatures.

Since this reaction is unaccompanied by change of volume, it is independent of pressure.

A great number of determinations of the ratio

$$\frac{C_{\text{CO}} \cdot C_{\text{H}_2\text{O}}}{C_{\text{CO}_2} \cdot C_{\text{H}_2}} = K$$

have been made, by Harries, Boudonard, Hahn and others, but owing to uncertainty as to the values of the difference between the specific heats of water vapour and carbon dioxide, the value for the indeterminate integration constant is not decided. As

198 AN INTRODUCTION TO THE STUDY OF FUEL

an approximation the specific heats of Mallard and Le Chatelier will be used, viz. :—

$$6.59 + 0.00387 t \text{ for carbon dioxide,}$$

$$5.78 + 0.00286 t \text{ for water vapour,}$$

for the calculation of the constant.

Hahn made a careful study of the reaction, and on the one hand passed a mixture of carbon dioxide and hydrogen over platinum as a contact substance, and on the other water vapour and carbon monoxide; after equilibrium was reached, the composition of the gas mixture was determined by analysis. The values which he obtained by the first way are given under (a) and those by the second way under (b). It will be noticed that the agreement between the two sets of figures is not all that could be desired.

$t^{\circ} \text{C.}$	686	786	886	986	1,005	1,086	1,205	1,405
$T \text{ abs.}$	959	1,059	1,159	1,259	1,278	1,359	1,478	1,678
$a$	0.534	0.872	1.208	1.596	1.62	—	2.126	2.49
$b$	—	0.808	1.186	1.545	—	1.96	—	—

The constant for the equation will be calculated for  $T = 1259$ , using equation (4) which now becomes

$$0.5 \int Q_T \frac{dT}{T^2} + \log \frac{C_{H_2O} \cdot C_{CO}}{C_{CO_2} \cdot C_{H_2}} = \text{constant.}$$

The heat of reaction in the sense

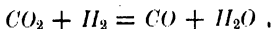

is — 10,100 calories at ordinary temperatures, the heat of reaction at 1,259 absolute must first be obtained by aid of Kirchoff's law (see p. 124).

$$Q_0 = -10,100 - (1685 \times 290 + 0.00101 \cdot 290^2)$$

$$Q_0 = -10,232 \text{ calories}$$

$$\text{and } Q_{1259} = -10,232 (+ 0.1685 \times 1,259 + 0.00101 \times 1,259^2)$$

$$= -10,232 + 212.1 + 1,601$$

$$= -8,419$$

$$0.5 \int_0^{1259} -8,419 \frac{dT}{T^2} + 0.1685 \frac{dT}{T} + 0.00101 dT + \log K = \text{constant.}$$



PRODUCER GAS AND WATER GAS REACTIONS 199

Substituting for  $K$  the mean of the two given under  $a$  and  $b$ , viz., 1.57 and converting into ordinary logarithms,

$$\begin{aligned}
 &+ \frac{4,220}{T} + \frac{0.0843}{0.4343} \log T + 0.00055 T + \frac{1}{0.4343} \log 1.57 = \text{constant} \\
 &= \frac{4,220}{1,259} + 0.1945 \log 1259 + 0.00055 \times 1,259 + 2.3026 \log \\
 &1.57 = \text{constant} = 3.352 + 0.603 + 0.692 + 0.450 = \text{constant} \\
 &= 5.097.
 \end{aligned}$$

Hahn found also that the equilibrium constant became equal to unity at 830° C. = 1,103 absolute, and calculating the constant in the same way as above,

$$\frac{4,220}{1,103} + 0.1945 \log 1,103 + 0.00055 \times 1,103 = \text{constant} = 5.216.$$

Owing, however, to the uncertainties above referred to, it is of little value to use this constant for calculating the composition of water gas at any temperature. Such calculations have been made by Jüptner (see Appendix).

There is one interesting theoretical consideration which can be made before concluding this brief account of the theory of producers. It follows from the equation

$$Q_T = - 10,232 + 0.1685 T + 0.00101 T^2$$

that at some particular temperature

$$Q_T = 0.$$

This temperature can readily be found by solving the equation, and it is 2,825° C. or 3,098° absolute. Again, it is seen from the figures given on p. 198,  $a$  and  $b$ , that the equilibrium constant

$$\frac{C_{H_2O} C_{CO}}{C_{CO_2} C_{H_2}} = K$$

changes with the temperature. This change can in general be represented by

$$\frac{d \log K}{dT} = - \frac{Q}{RT^2}$$

According to this equation an increase of  $d \log K$  will accompany an increase of temperature  $dT$  when  $Q$  has a negative value, but when  $Q$  has acquired a positive value  $d \log K$  will become negative. This means that the equilibrium constant reaches a

maximum value at some temperature. The determination of this maximum value was made by exploding a mixture of carbon monoxide and hydrogen with insufficient oxygen to completely burn both gases.<sup>4</sup> The ratio of the composition of the mixture after explosion was found to be

$$\frac{C_{CO} \cdot C_{H_2O}}{C_{CO_2} \cdot C_{H_2}} = 6.25.$$

If the temperature of gases in the explosion is calculated by aid of the specific heats given above and of the known heats of combustion of hydrogen and carbon monoxide, it will be found that the temperature must have been 2,973 absolute 2,700° C., which is very near to 2,825° obtained above.

The complete theoretical elucidation of the water gas equilibrium necessitates the determination of the specific heats of the reacting and resulting gases with considerable accuracy, and by aid of them and the heat of reaction it is possible to calculate the composition of the gases in equilibrium at any given temperature. From a technical standpoint, however, these calculations are at present of little value as equilibrium is certainly not reached in the production of either water gas or producer gas. The reasons for the non-attainment of equilibrium have already been discussed.

## CHAPTER XII

### EXPLOSION AND THE EXPLOSION ENGINE

EXPLOSION may arise from two causes, it may on the one hand result from the combination of two or more substances, such as the formation of water from hydrogen and oxygen, or carbon dioxide and water from the combustion of methane,

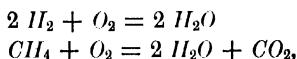

or, on the other hand, it may arise from the decomposition of a compound into its constituent elements, for example, the decomposition of nitrogen chloride into nitrogen and chlorine,

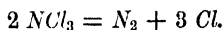

These reactions are accompanied by a great evolution of heat and owing to the rapidity with which the reactions take place, the heat remains in the products, causing a great expansion of volume. If the explosion takes place in a closed space at constant volume, the pressure is enormously increased, and unless the surroundings are strong enough to withstand the pressure, the containing vessel will be burst, and may be blown into fragments. If the explosion takes place in a cylinder fitted with a piston, the piston will be driven forwards by the explosion and can do mechanical work. The explosion of an explosive mixture is started by ignition (or detonation in cases of certain explosives), and for every mixture there is a definite ignition temperature, and this temperature is attained either by an electric spark, flame, or by adiabatic compression. The ignition temperature of combustible gases mixed with oxygen varies not only with the nature of the gas but also with the quantity of gas

202 AN INTRODUCTION TO THE STUDY OF FUEL

and oxygen or air present. The following table of ignition temperatures will illustrate this point:—

	In Oxygen.	In Air.
Hydrogen . . . . .	580°—590° C.	580°—590° C.
Carbon monoxide . . . . .	637°—658° C.	644°—658° C.
Ethylene . . . . .	500°—519° C.	542°—547° C.
Acetylene . . . . .	416—440° C.	406—440° C.
Methane . . . . .	556—700° C.	659—750° C.

The difference of the ignition temperature for different gas oxygen or air mixtures are, for hydrogen and oxygen:—

	Ignition Temperature.
4 H <sub>2</sub> + O <sub>2</sub> . . . . .	605° C.
H <sub>2</sub> + O <sub>2</sub> . . . . .	514° C.
H <sub>2</sub> + 4 O <sub>2</sub> . . . . .	571° C.

For carbon monoxide and oxygen:—

	Ignition Temperature.
6 CO + O <sub>2</sub> . . . . .	721° C.
2 CO + O <sub>2</sub> . . . . .	601° C.
CO + O <sub>2</sub> . . . . .	631° C.

When once the gas mixture is ignited the combustion progresses with great rapidity, and measurements have been made of the velocity of propagation of the combustion. One method by which such measurements may be made is by burning the gas at the end of a long glass tube and determining the rate at which the gas must be supplied, so as to just keep the flame stationary, that is, to prevent the flame from either being blown out or travelling down the tube. If  $V$  is the volume of gas supplied per second, expressed in cubic centimetres,  $S$  the cross-section of the glass tube in square centimetres, then the velocity of propagation of the ignition is given by the equation

$$u \text{ in c.m. per sec.} = \frac{V}{S}$$

For carbon monoxide, the velocities are:—

Percentage of CO . . . . .	25	35	45	55	65	70	75	85	95
Velocity in c.m. per sec. . . . .	30	49	66	80	88	91	91	70	20

A maximum exists at 70 to 75 per cent.  $CO$ , that is, at a point where the composition is different from that required by the equation for complete combustion,

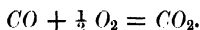

A similar maximum exists for hydrogen, oxygen mixtures at 83.8 per cent. hydrogen.

The ignition of an explosive gas mixture may also be effected by a sudden compression, which must be extensive enough to raise the gas to the ignition temperature. This pressure is given by the equation

$$\frac{T}{T_1} = \left(\frac{V_1}{V}\right)^{\kappa-1}$$

where  $T$  is the ignition temperature,  $T_1$  the initial temperature of the gaseous mixture,  $V_1$  the initial, and  $V$  the final volumes, and  $\kappa$  the ratio of the specific heat at constant pressure  $c_p$  to the specific heat at constant volume  $c_v$

$$\frac{c_p}{c_v} = \kappa.$$

Now since

$$\frac{V_1}{V} = \frac{P}{P_1}$$

the above equation can be written

$$\frac{T}{T_1} = \left(\frac{P}{P_1}\right)^{\kappa-1}$$

The compression necessary to raise a mixture of hydrogen and air to its ignition temperature,  $580^\circ C.$  to  $590^\circ C.$  can now be calculated. Let the initial temperature be  $0^\circ C. = 273$ , the required temperature  $585^\circ C. = 858$  absolute,  $\kappa = 1.41$  for diatomic gases, *e.g.*,  $H_2$ ,  $N_2$ ,  $CO$ ,  $O_2$ , and let the initial pressure be 1 atmosphere, then

$$\frac{858}{273} = P^{0.41}$$

whence  $P = 15.9$  atmosphere.

The pressure caused by the explosion can also be calculated, by first calculating the temperature produced by the explosion. This is done in the same way as described in Chapter VI., p. 116, but since the explosion takes place in an enclosed space, the

specific heats at constant volume must be used. The specific heats at constant volume per molecule are

$$\begin{aligned} C_v &= 4.8 + 0.0006 t^\circ \text{ for permanent gases,} \\ C_v &= 5.9 + 0.00215 t^\circ \text{ for water vapour,} \\ C_v &= 6.7 + 0.0026 t^\circ \text{ for carbon dioxide.} \end{aligned}$$

Or expressed for absolute temperature  $T = t^\circ + 273$ ,

$$\begin{aligned} C_v &= 4.5 + 0.0006 T \text{ for permanent gases,} \\ C_v &= 4.73 + 0.00215 T \text{ for water vapour,} \\ C_v &= 5.28 + 0.0026 T \text{ for carbon dioxide.} \end{aligned}$$

(See Appendix III. for method of calculation.)

Calculating the temperature and pressure generated by the explosion of carbon monoxide and air

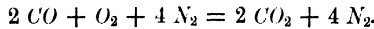

The heat of reaction at constant volume is 67,900 calories, and since the reaction is practically instantaneous, this heat remains in the products of combustion and raises their temperature, so increasing the pressure. Assuming the initial temperature to be  $0^\circ$  C. and the final temperature to be  $t^\circ$  C, then

$$\int_0^t (6.7 + 0.0026 t) dt + 2 \int_0^t (4.8 + 0.0006 t) dt = 67,900$$

for the combustion of one molecule of carbon monoxide with the theoretical amount of air. Upon integration this becomes

$$\begin{aligned} 6.7 t + 0.0013 t^2 + 9.6 t + 0.0006 t^2 &= 67,900, \\ 16.3 t + 0.0019 t^2 &= 67,900. \end{aligned}$$

Solving for  $t$ , it is found that

$$t = 3,069^\circ \text{ C.} = 3,342^\circ \text{ absolute.}$$

From Boyle's law, it follows that if a volume of gas  $V$  at pressure  $P_1$  and temperature  $T_1$  is heated at constant volume to a temperature  $T_2$ , then the pressure changes to  $P_2$  and

$$P_1 V = R T_1,$$

and

$$P_2 V = R T_2,$$

whence

$$\frac{P_1}{P_2} = \frac{T_1}{T_2}.$$

## EXPLOSION AND THE EXPLOSION ENGINE • 205

$T$  being the absolute temperature. If the initial pressure were 1 atmosphere, and the initial temperature  $0^{\circ}\text{C.} = 273$  absolute, the pressure developed by the explosion will be

$$\frac{6}{7} \left( \frac{3,342}{273} \right) = 10.5 \text{ atmospheres.}$$

The  $6/7$  is introduced for this reason. The reaction

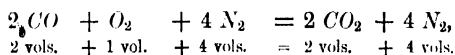

takes place with diminution of volume, seven volumes becoming six, hence if the initial pressure were 1 atmosphere, the expected final pressure would be  $\frac{6}{7}$  of an atmosphere, under the same conditions of temperature.

The power fuels in explosion motors can be either gases or liquids. The former are mixed with air and exploded, the latter must be vaporised or sprayed into the cylinder together with the air necessary for the combustion. This is known as carbureting. The carbureting is effected by passing air through the liquid, on the way to the cylinder, if the liquid has a low boiling point, or the liquid is sprayed into the cylinder by the air necessary for the combustion. Carbureting with high boiling liquids is effected by employing the hot cylinder end to heat the liquid or by using a specially heated carburetter. The ignition of the explosive mixture is effected by an electric spark or by a heated ignition plug.

The gas employed for explosion engines can be any of the following compositions in per cents. by volume

—	CO%	H <sub>2</sub> %	CH <sub>4</sub> %	C <sub>2</sub> H <sub>2</sub> %	C <sub>4</sub> H <sub>6</sub> %	CO <sub>2</sub> %	N <sub>2</sub> %	H <sub>2</sub> O%	H <sub>2</sub> %
Coal gas	10.0	45.0	35.0	4.0	—	3.0	3.0	—	—
Dowson gas	25.0	18.0	3.0	—	—	7.0	47.0	—	—
Water gas	40.0	50.0	5.5	—	—	4.5	—	—	—
Dellwik. Blast-furnace gas	27.5	3.0	—	—	—	10.0	44.5	5.0	—
Coke oven gas	6.4	52.7	35.7	1.6	0.6	1.2	—	1.2	0.4

The compositions of some of the liquids used are by weight:—

	C%	H%	O%
Benzene . . . . .	84.3	15.7	—
Russian petroleum . . . . .	83.5	14.0	0.5
90% crude spirits . . . . .	41.5	13.0	45.5

The gases used for explosion engines must be as free from tar and dust as possible since both of these interfere with the working of the engine. This causes a difficulty in using gas made from bituminous coal on account of the tar, and in using blast furnace gas on account of the dust. Many methods have been proposed for removing these impurities. The principle upon which these depend is chiefly the washing of the gas by means of a suitable washer, the water being sprayed into a rapidly-revolving cylinder carrying vanes. The gas is passed into the apparatus, and owing to the wind caused by the vanes, the gas is blown against the moist sides of the cylinder which covers the revolving cylinder. The washed gas passes on and the water flows out of the washer continuously. The tar, formed when most varieties of coal are used in producers for gas making, is removed with difficulty, the removal of the last quantities of tar vapour requiring extensive purifying plant, which is not possible on economical grounds. To avoid the trouble with the tar and also to avoid extensive purifiers, producers are so designed that the distillation products of the coal must pass through the most strongly heated zones, where they undergo decomposition into gaseous products and the gas making its exit from the producer is practically tar free.

The theory of the combustion processes taking place in the explosion engine has been treated from a physico-chemical standpoint by Nernst (see Appendix I.). An elementary outline of his theory will now be given, since it is extremely important and raises the question as to the *maximum work which can be effected in a given machine, by the ideal utilisation of the energy of the combustion processes, which take place,*

It has already been abundantly emphasised, that the heat



generated by a given reaction has a definite value, but the question is still open as to how much of that heat can be converted into work, under ideal conditions. In the steam engine, for example, if the measure of the work done is the quantity of water evaporated by the fuel, then the ratio

$$\frac{\text{Heat absorbed by boiler}}{\text{Heat evolved in furnace}}$$

gives the efficiency of the boiler as a steam-raising machine. Again if the ratio

$$\frac{\text{Indicated horse-power}}{\text{Heat evolved in furnace}}$$

both expressed in the same units is taken as the efficiency, the value of the second will be different from the first. From thermodynamic considerations the efficiency of an engine is given by

$$E = \frac{Q_1 - Q_2}{Q_1} = \frac{T_1 - T_2}{T_1},$$

where  $Q_1$  = heat absorbed by working substance at absolute temperature  $T_1$ ,

and  $Q_2$  = heat rejected by the working substance at absolute temperature  $T_2$ .

Expressed in another way,

$$E = \frac{T_1 - T_2}{T_1},$$

where  $T_1$  = absolute temperature of boiler,  
 $T_2$  = absolute temperature of condenser.

Supposing the temperature of the boiler to be 150° C. and the condenser 40° C., then the efficiency

$$E = \frac{423 - 313}{423} = 0.26,$$

or 26 per cent. of the heat is converted into work. The heat here indicated is the heat absorbed by the working substance, *i.e.* the water in the boiler, but the source of this heat is the combustion of coal, etc., in the furnace and how much of this, can be, or is converted into useful work depends upon many factors, such as loss by radiation, loss by imperfect combustion or loss of heat in products of combustion, all of which can be reduced to a

minimum, but never completely eliminated. The consideration resolves itself into two divisions, firstly, what proportion of the heat evolved by the combustion of a given material can theoretically be converted into useful work in the ideal case, and secondly, what proportion of this heat can be practically utilised. The former problem is treated by Nernst in the following way.

The maximum work which can be effected by a chemical reaction that takes place reversibly and isothermally is given by the equation

$$A = RT \log_e K,$$

where  $K$  is the equilibrium constant,  $T$  the absolute temperature and  $R$  the gas constant. The solution of this equation involves the knowledge of the equilibrium constant  $K$ . In order to arrive at the maximum work that can be done by the reversible combination of hydrogen and oxygen and of carbon and oxygen it is necessary to know the value of  $K$  for

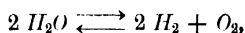

and for

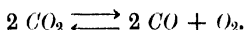

The values for these reactions have been determined at different temperatures and pressures. The values for water vapour are:—

Temp. abs.	10 atmos.	1 atmos.	0.1 atmos.	0.01 atmos.
1,000	$1.39 \times 10^{-5}$	$3.00 \times 10^{-5}$	$6.40 \times 10^{-5}$	$1.39 \times 10^{-4}$
1,500	$1.03 \times 10^{-2}$	$2.21 \times 10^{-2}$	$4.76 \times 10^{-2}$	0.103
2,000	0.273	0.588	1.26	2.70
2,500	1.98	3.98	8.16	16.6

and for carbon dioxide:—

Temp. abs.	10 atmos.	1 atmos.	0.1 atmos.	0.01 atmos.
1,000	$7.31 \times 10^{-6}$	$1.58 \times 10^{-5}$	$3.40 \times 10^{-5}$	$7.31 \times 10^{-5}$
1,500	$1.88 \times 10^{-2}$	$4.06 \times 10^{-2}$	$8.72 \times 10^{-2}$	0.188
2,000	0.818	1.77	3.73	7.88
2,500	7.08	15.8	30.7	53

Thus at a temperature of 2,500 absolute = 2,227° C. and at a pressure of 1 atmosphere, carbon dioxide is 15.8 per cent. dissociated with carbon monoxide and oxygen, the concentrations of each being—

Carbon dioxide . . . . .	0.942
Carbon monoxide . . . . .	0.158
Oxygen . . . . .	0.074

By means of the above data, Nernst has calculated  $A$  for a number of reactions, the values obtained for the two reactions under consideration

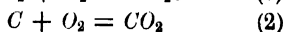
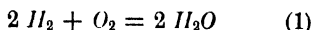

are—

for  $H_2O$ ,  $A = 54,050$  calories,  $Q = 57,650$ ,

for  $CO_2$ ,  $A = 96,650$  ,,  $Q = 97,650$ .

Under these conditions about 99 per cent. of the heat of the reaction is theoretically convertible into external work, and therefore the ideal engine which will convert the heat energy of coal into mechanical, external work is at least theoretically possible. For a large number of combustibles employed in explosion motors such as alcohol, benzene, petrol, the value for  $K$  is not known with sufficient accuracy to enable conclusions to be drawn as to the maximum work, theoretically possible, by their explosion with air or oxygen. In general, the work gained from an explosion motor is very much less than that ideally possible, while the steam engine uses a comparatively large amount of the available heat of the fuel. The boiler of the steam engine absorbs the heat of combustion of the fuel fairly completely, and frequently uses 60 to 80 per cent. of the heat of the fuel for converting water into steam. The work that is done by the machine ultimately involves a number of heat losses, so that a comparatively small proportion of the heat energy of the fuel is finally converted into useful work. One of the most serious sources of loss of heat in the explosion engine is due to the high temperature at which the gases leave the exhaust, it being impossible to cool the gases, by adiabatic expansion, to ordinary temperatures. One method by which the quantity of heat utilised may theoretically be increased is to employ as great a degree of compression as possible. If, for example, the gases

were compressed to  $\frac{1}{40}$  or  $\frac{1}{60}$  of their volume before explosion, that is, if the combustion space were only  $\frac{1}{40}$  to  $\frac{1}{60}$  of the volume of the cylinder, then by avoiding the other sources of heat loss, incomplete combustion; etc., about 70 to 80 per cent. of the heat could be converted into work. On economical and practical grounds such a degree of compression is not possible since it would require the machine to be built very strong to resist the enormous pressure of both the compression and explosion. This would necessitate such heavy construction of the various parts that the engine would not be a satisfactory power machine. Another danger of

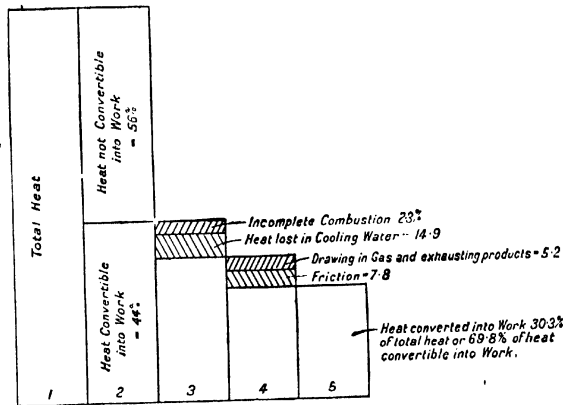

FIG. 57.—Diagram showing Heat Losses in an Explosion Motor.

a high degree of compression is the high temperature developed by adiabatic compression which causes the gas to ignite too soon. On this account the compression usually employed is 6 to 7 for easily ignited gases, *i.e.*, those rich in hydrogen, and 8 to 9 for those ignited with difficulty, *i.e.* gases poor in hydrogen.

E. Meyer has determined the various losses in two explosion engines, one working with a compression of 3.8 and the other with a compression of 8.0. The results are given graphically in Figs. 57 and 58. The rectangles 1, 2, 3, 4 and 5 show the reduction in the heat available for doing work by the various sources of loss. These losses are:—

(1) A quantity of heat is inconvertible in work since the

gases leave the machine at a high temperature. This loss reaches 67 per cent. in one case and 56 per cent. in the other.

(2) Of the remainders, 33 per cent. and 44 per cent. respectively, 39.8 per cent. and 30.2 per cent. are lost through incomplete combustion, heat in cooling water, work done in drawing in the gases and pushing out the products of combustion, and through friction of the working parts, only 19.9 per cent. and 30.3 per cent. of the total heat being converted into useful work in the two engines under consideration.

The extremely high temperatures developed during explosion in

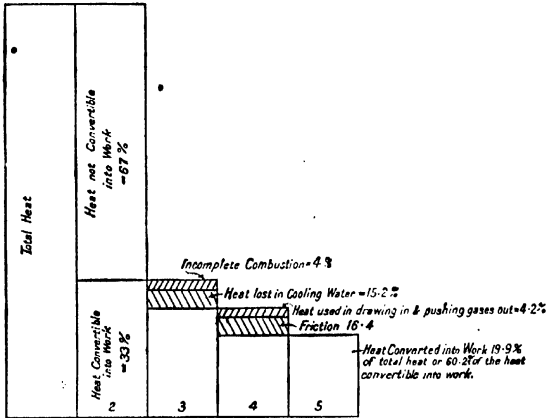

FIG. 58.—Diagram showing Heat Losses in an Explosion Motor.

a closed space gives rise to the formation of other compounds in addition to the ordinary expected products of combustion. When atmospheric air is used a small quantity of nitric peroxide is formed, during the explosion of the air-hydrogen mixture. When hydrogen is exploded with an excess of oxygen a measurable quantity of hydrogen peroxide  $H_2O_2$  is produced, which decomposes into water and oxygen as the temperature falls. Nitric peroxide undergoes no such decomposition, but can be estimated at the end of the explosion.

The combustion of an explosive gas mixture can take place in two ways according to the composition of the mixture and other conditions under which the explosion takes place.

## 212 AN INTRODUCTION TO THE STUDY OF FUEL

(1) Slow combustion, the heat being carried forward by conduction, and so advancing the ignition of the mixture.

(2) Rapid combustion in which the ignition of the mixture is advanced by the explosion wave. This latter method is characterised by a great increase of pressure at the point of ignition and the consequently great force of the explosion, which may be sufficient to shatter the containing vessel. After the explosion the gases remaining are at a high temperature, and these cool partly by convection and radiation and partly by conduction.

Nernst has shown that at high temperatures the rate of cooling is proportional to the fourth power of the absolute temperature, and hence it is probable that the cooling takes place by radiation, since the cooling obeys the radiation law. At the lower temperatures the cooling takes place by convection and conduction, and the rate of cooling is proportional to the difference of temperature between the gas and the walls of the containing vessel (cylinder), that is, the rate of cooling is in accordance with the law of cooling enunciated by Newton.

Nernst draws the following conclusions from his theoretical treatment of the explosion engine:—

(1) The maximum work which can be obtained by the combustion of a given material can in some cases be calculated exactly, in others, at least approximately.

(2) The maximum pressure developed during the explosion of a gas mixture in a closed space has been investigated by a number of experimenters. It can also be calculated from a knowledge of the heat of combustion and specific heat of the gas mixture, if the rise of temperature is not too great. "For high temperatures during explosion the observed pressures are below the calculated, probably in consequence of the explosion waves set up in the gas."

(3) At the highest temperature of the explosion, chemical equilibrium is attained owing to the great reaction velocity at that temperature. Compounds, which are unstable at lower temperatures (such as ozone, hydrogen peroxide, and oxides of nitrogen), are formed during explosion. In some cases the equilibrium can be measured.

(4) The propagation of the ignition in an explosive gas mixture takes place partly by means of slow combustion produced by the conduction of heat, and partly by the spontaneous ignition caused by the compression wave consequent upon the change of pressure. The mechanism of both varieties of ignition can be explained as in the present discussion.

(5) In extremely fast-burning gas mixtures complications arise owing to the explosion waves colliding with the reflected waves, and the propagation of the explosion by slow combustion merges finally into the explosion wave, after it has advanced a greater or lesser distance.

(6) The cooling of a highly-heated mass of gas takes place at the higher temperatures chiefly by radiation, at the lower by conduction and convection.

The high temperatures and pressures developed in the explosion engines, and the high speeds attained, cause several difficulties. In the first place there is very serious wear and tear of the moving parts in a high speed explosion engine. In the second place, if the admixture of gas and air is not perfect, some of the gas will remain unburnt, since the combustion has no time to proceed through the whole of the mixture, or if it burns it is too late to be of use in driving the piston. Losses due to this cause vary from 0 to 20 per cent.

Again, owing to the high temperature developed, the cylinders have to be cooled. Water jackets are employed for this purpose, and this absorbs some of the heat. The amount of heat absorbed by the cooling water varies from 10 to 18 per cent.

Finally a point in explosion cylinder construction is brought out when the mechanism of the explosion itself is considered. Imagine the gas-mixture in the cylinder to consist of an infinite number of layers at right angles to the axis of the cylinder. The piston moves inwards and compresses the gas, and when the compression is complete the gas is ignited. Explosion in one layer takes place and further compresses the next layers. The compression is adiabatic, and therefore the temperature rises. This favours the advance of the explosion and increases as the explosion progresses. As this proceeds a point will be reached when the adiabatic compression produces sufficient heat to ignite

the gas mixture and cause explosion, setting up an *explosion wave* which spreads through the whole mass of gas with enormous velocity. It frequently happens that glass tubes will stand the force of explosion in which the ignition proceeds from layer to layer of gas by conduction of heat, but are shattered to dust when an explosion wave is set up. It is of the highest importance in the construction of explosion engines that the method of ignition and dimensions of the explosion cylinders are so designed that the gas mixture will be completely burnt before the formation of an explosion wave is possible. This avoids putting an undue strain on the piston packing and movable parts of the machine.



## CHAPTER XIII

### AIR SUPPLY AND MEASUREMENT OF DRAUGHT

THE reactions which have been considered in the previous chapter represent the partial combustion of a fuel, viz., carbon, by a limited supply of air or by water vapour, and these reactions can take place in furnaces to a greater or lesser extent, and result in a loss of combustible material. When fuel is burnt in any grate or furnace for the production of heat, the completeness of the combustion is extremely important if the full heating value of the fuel is to be obtained. The efficient combustion of a fuel depends upon—

- (1) The design of the grate or furnace;
- (2) The proper regulation of the supply of primary and secondary air.

Efficiency of combustion in this case means the avoidance of loss of combustible material as either :

- (a) Gaseous products, carbon as smoke, or hydrocarbons, and carbon monoxide.
- (b) Solid products, combustible material remaining in ash.

The efficiency of heating, that is, the proportion of the total heat evolved by the combustion of the fuel which is converted into some useful form, depends upon the above, and in addition, upon the provision made for abstracting the heat from the products of combustion. The subject of the design of the furnace or grate cannot be entered upon here; suffice it to point out that the furnace must be so designed as to facilitate the burning of the quantity of fuel required to give the necessary amount of heat for the operations, and so arranged as to abstract the maximum quantity of sensible heat from the products of combustion and to minimise the formation of half-burnt, and therefore combustible, products.

The air supply to a furnace requires proper control, if efficient

combustion is to be obtained. The methods of supplying air to the furnace are:—

- (1) The utilisation of the difference of density between the warm products of combustion and the external air—natural draught, and chimney draught.
- (2) Mechanical draught.
  - (a) Forced draught, blast.
  - (b) Induced draught, exhaust pumps, or steam blast in chimney or flue.

The draught serves two purposes, viz., the supplying of the air to the furnace and the removal of the products of combustion. In the first place, it is necessary to consider the combustion of coal as it takes place in (for example) the firegrate of a steam boiler, and in the firebox of a locomotive. These two differ in the very important detail that the fire in the case of a Lancashire boiler is relatively thin, and in the case of a locomotive much thicker, and, owing to the shaking during running, may become very dense.

A boiler, such as a Lancashire boiler, is fitted with two long firetubes, and the firegrate is at one end of each tube. The air is admitted from below the firebars (primary air), and also through the firedoors (secondary air). When the fire is burning properly, the reactions which occur are as follow:—

The air entering from below comes into contact with strongly-heated carbon, carbon dioxide is formed, and if the draught is sluggish a partial reduction of this to carbon monoxide may ensue as it passes through the heated layers of fuel. Fresh coal is introduced into the furnace on to the strongly-heated surface of the fire, a process of dry distillation of the coal commences and the coal becomes partially coked. Hence the gases which escape at the free surface of the fire will contain varying proportions of carbon monoxide and products of dry distillation of the coal. The air necessary for their combustion is admitted through the firedoor, and the flame plays along the heating surface of the firetube, the hot products of combustion passing out of the firetube into the chimney flues. The excess of air employed must not be indefinitely great; as a rule it is from 2 to 3 times the amount necessary for complete combustion of the fuel. A large

excess of air causes a double loss of heat, as it lowers the temperature in the furnace and carries away a large proportion of the sensible heat into the flues. Again, as already referred to in Chap. IX., p. 166, high velocity of draught may carry away combustible gases into the flues before they have time to burn, and so cause a loss of heat. In a Lancashire boiler, especially when carelessly fired, a very considerable loss of heat results from the passage of cold air through the firebars and also through the door.

The fire in a locomotive firebox varies in depth, from the firedoor to the front ashpan. In some cases the fire is about 3 ft. deep at the door and 18 ins. at the front; in other cases the depth is only one half of the above figures. The reactions which occur are similar to those occurring in the Lancashire boiler, but the tendency of the firebox to act as a producer is greater, and owing to the strength of the induced draught caused by the steam blast, the fire frequently gets broken into holes, through which the cold air rushes with great velocity. The main reactions occurring in a locomotive firebox are:—

(1) Combustion of the carbon of the fuel in the lower layers of the fire by the primary air to  $CO_2$ .

(2) Reduction of the  $CO_2$  to carbon monoxide by the upper layers of strongly-heated fuel, the reduction taking place to a greater or lesser extent, the extent depending upon the temperature of the fire and the velocity with which the gases are swept through the fire.

(3) Dry distillation of the fresh coal introduced on to the free surface of the fire, resulting in the production of hydrocarbons and smoke.

(4) Combustion of the carbon monoxide and the products of dry distillation by the secondary air, admitted through the fire-door.

The complete combustion of these gases depends upon the thoroughness with which the gases are mixed and the speed at which they are swept through the firetubes. The flue gases frequently contain carbon monoxide and more than sufficient oxygen for its combustion. This is probably due to bad admixture of the gases and also to the fact that they are removed

from the heated space before combustion can take place and cooled down to a temperature at which combustion does not take place. The air necessary for the combustion is supplied by the escape of the exhaust steam up the funnel, which produces a reduction of pressure in the smokebox. The air then passes either through the firebox via the dampers, from below, or via the firedoors from above the fire. Every fire requires a quantity of air, which depends upon the weight of fuel to be burnt in unit time. The rate of combustion varies in every case; a stationary boiler, for example, has a much slower rate of combustion than a locomotive.

The question of draughts, natural and artificial, will now be considered.

The natural draught, or chimney draught, depends for its action upon the difference of density between the warm products of combustion and the cold air outside. The weight of air  $W$  which is drawn through a given furnace in unit time by a chimney of cross-section  $s$  is given by the equation

$$W = v_1 s d_1,$$

where  $v$  is the velocity of the gas in the chimney, and  $d$  the density of the gases at the chimney temperature. The velocity  $v$  is given by the equation

$$v = \sqrt{2gh}$$

where  $g$  is the acceleration of gravity and  $h$  is the working pressure, *i.e.*, the difference in height between that of a column of air at external temperature  $t_1$  and height  $L$ , the height of the chimney, and the same column when heated up to chimney temperature  $t_2$ . This change can be calculated in the following way: Let  $H_0$  be to height of a column of air equal to the height of the chimney at  $0^\circ \text{C.}$ , then the height at a temperature  $t_1$ , the temperature of the external air will be

$$H_{t_1} = \frac{273 + t_1}{273} H_0 \quad (1),$$

and the height of the air column at the chimney temperature  $t_2^\circ \text{C.}$  will be

$$H_{t_2} = \frac{273 + t_2}{273} H_0 \quad (2),$$

the difference in height  $Ht_2 - Ht_1 = h$  is

$$h = \frac{t_2 - t_1}{273} H_0 \quad (3),$$

and substituting

$$H_0 = \frac{273}{273 + t_1} Ht_1$$

in equation (3) the expression

$$h = \frac{Ht_1 (t_2 - t_1)}{273 + t_1}$$

is obtained. This value for  $h$  can now be substituted in the equation for the velocity, hence

$$v = \sqrt{2g \frac{Ht_1 (t_2 - t_1)}{273 + t_1}},$$

and the quantity of gas drawn through the furnace in unit time is

$$W = s \cdot d_1 \sqrt{2g \frac{Ht_1 (t_2 - t_1)}{273 + t_1}},$$

and from this it follows that the quantity of gas drawn by a chimney increases in proportion to the square root of the height of the chimney.

Weight of Gases Drawn by Chimney.	Height of Chimney.
$Q$	$H$
$Q\sqrt{2}$	$2 H$
$Q\sqrt{3}$	$3 H$
$2 Q$	$4 H$
$3 Q$	$9 H$

The increase in the height of the chimney produces only a comparatively small change in the quantity of gases carried off by it. The expression

$$\frac{\sqrt{t_2 - t_1}}{273 + t_2}$$

reaches a maximum value when  $t_2 = 273 + t_1$ , and hence the chimney gives the best draught when the internal and external temperatures differ by 273° C. For  $t_1 = 0^\circ$  C. the expression has the value,

$t_2^\circ$ C.	= 0°	200°	273°	300°	500°	800°	1,000°
$\frac{\sqrt{t_2 - t_1}}{273}$	= 0°	0.029°	0.0303°	0.030°	0.029°	0.027°	0.025°

and therefore, when the gases pass into the chimney at a temperature higher than  $273^{\circ}$  C. above the external atmosphere, the chimney does not draw so well, and a greater proportion of heat is lost in the gases. Each chimney can therefore carry a certain quantity of gas, and consequently this limits the amount of fuel which can be burnt in unit time. If the gases to be carried off by the chimney are denser than air, a correction must be introduced into the above equations, and the greater the density of the gases carried by the chimney, the smaller is the draught produced. The heat of the gases escaping into the chimney is not all lost, since where natural draught is employed, a certain temperature is necessary to actuate the draught.

Artificial draught is employed on an increasing scale instead of natural draught. The means of producing "artificial draught are :—

(1) Pumps, which force the air into the fire from below the fire bars or through suitable jets (twyers), as in the iron and other forms of blast furnaces (forced draught).

(2) The reduction of pressure in the chimney by a jet of live steam, the escape of exhaust steam, or a blower which acts as an exhaustor.

The chief advantages of mechanical draught are :—

(1) Complete control of air supply, enabling the quantity of air supplied to the furnace to be regulated according to the needs of the occasion.

(2) Diminution of the tendency to allow the escape of dense black smoke, owing to more complete combustion of the fuel.

(3) In a steam boiler, the rate of steam production can be greatly increased.

(4) Economy of fuel, since the fuel is burnt more efficiently.

(5) The draught is independent of atmospheric conditions.

(6) The flue gases can be very completely deprived of their sensible heat.

(7) Lower class fuels can be employed.

(8) The air can be heated before reaching the fire. This heating can be done by utilising the heat in the products of combustion. This heat can also be used for superheating the steam (in case of a steam boiler).

## AIR SUPPLY AND MEASUREMENT OF DRAUGHT. 221

(9) The space occupied by the fans, etc., for producing mechanical draught is small, and the installation and upkeep are also very moderate.

A very important point in favour of mechanical draught is that the draught can be varied so as to enable different classes of fuel to be burnt in a given furnace, and that the draught can be increased or decreased as the thickness or density of the fire is varied.

*Measurement of Draught.*—The direct measurement of the quantity of air supplied to a furnace, or the quantity of products of combustion, is by no means an easy matter. This is because of the enormous volume of air used and the high temperature of the products, both factors rendering direct measurement difficult. By means of a knowledge of the temperature, the composition of the air and the flue gases, and of the fuel used, the quantity of air and products can be calculated. The following example will illustrate this method of calculation.

In an actual test of a fuel for boiler heating, 500 kilograms of dry coke, having the composition

Carbon	. . . . .	87.3	%
Hydrogen	. . . . .	0.78	%
Oxygen	. . . . .	2.36	%
Ash	. . . . .	9.56	%
		100.00	%

were burnt per hour. The weight and volume of air necessary for the complete combustion of 1 kilo. of this fuel will be:—

		Weight of Oxygen.	Volume of Oxygen.
Carbon,	873 gms. require	2,328 gms.	1,624 litres.
Hydrogen,	4.8 „ „	38.4 „	26.8 „
Combined H & O,	26.6 „ „	— „	— „
Ash,	95.6 „ „	— „	— „
	1,000.0	2,366.4	1,650.8

Air required for 1,000 grams of fuel (1 kilo.):—

$$\text{By weight } \frac{2,366.4 \times 100}{23} = 10,289 \text{ gms.}$$

$$\text{By volume } \frac{1,650.8 \times 100}{21} = 7,861 \text{ litres.}$$

## 222 AN INTRODUCTION TO THE STUDY OF FUEL

The composition of the products will then be:—

	Weight.	Volume.	Volume %.
Carbon dioxide . . .	3,201 gms.	1,624 litres.	20.5 %
Water (burning of <i>H</i> ) .	43.2 "	} 86.5 "	} 1.1 %
Water (from combined <i>H</i> & <i>O</i> ) . . . . .	26.6 "		
Nitrogen . . . . .	7,922.6 "	6,210.2 "	78.4 %
	<u>11,193.4</u> "	<u>7,920.7</u> "	<u>100.0</u>

If the products were analysed in a Hemple or Orsat apparatus (*cf.* p. 36 and *f.*), the water would be condensed, and hence the composition

Carbon dioxide . . .	20.7 %	} (since no excess air is assumed to be used)
Oxygen . . . . .	<i>nil</i>	
Nitrogen . . . . .	79.3 %	
	<u>100.0</u>	

The composition of the gases determined were:—

Carbon dioxide . . . . .	9.9 %
Oxygen . . . . .	9.9 %
Carbon monoxide . . . . .	<i>nil</i>
Nitrogen . . . . .	80.2 %
	<u>100.0</u>

It is evident that a large excess of air has been used. The excess of air can be calculated thus: The oxygen unused 9.9 per cent. would correspond to  $9.9 \times \frac{79}{21}$  parts by volume of nitrogen = 37.6, and the remainder,  $80.2 - 37.6 = 42.6$ , corresponds to the oxygen used in burning the fuel. The ratio of the air which actually passes through the fire to that used for burning the fuel is in the ratio of  $80.2 : 37.6 = 2.1$ , that is, 2.1 times the air theoretically necessary for combustion of the fuel has been employed. In the above example, therefore, the air used is

$$7,861 \times 2.1 = 16,508 \text{ litres.}$$



## AIR SUPPLY AND MEASUREMENT OF DRAUGHT • 223

The weight and volume of the products are:—

	Weight.	Volume.
Carbon dioxide . . . . .	3,201 gms.	1,624 litres.
Water vapour . . . . .	69·8 „	86·5 „
Oxygen . . . . .	2,603·0 „	1,816·0 „
Nitrogen . . . . .	16,638 „	13,041·0 „
	22,511·8 „	16,567·5 „

This gives as the composition of the water-free gas—

	Volume %.
Carbon dioxide . . . . .	9·9 %
Oxygen . . . . .	10·0 %
Nitrogen . . . . .	80·1 %
	100·0

which agrees with the composition determined by analysis. The weight and volume of the products to be removed by the chimney when 2·1 times the air theoretically required for combustion is used are, 22·512 kilos. or 16·675 cub. metres for every kilogram of fuel burnt. If the chimney temperature is 273° C., the temperature at which the draught is greatest, the outside temperature remaining at 0° C., then the volume of the products will be doubled, viz., 33·1350 cub. metres. Since 500 kilos. of fuel are burnt per hour, the weight and volume of products carried off are 11,256 kilos. or 16,567·5 cub. metres per hour.

This method of calculating the quantity of air employed involves a knowledge of the ultimate composition of the fuel, and in practice it is difficult to obtain a sample of the fuel sufficiently representative of the composition of the bulk to enable a very exact estimate of the quantity of air to be made.

Lunge has developed a formula by aid of which the volume of flue gases can be calculated. From 10 to 15 determinations of the carbon dioxide content of the flue gases are made, so as to obtain a mean value for the percentage of  $CO_2$ . If this be denoted by  $n$ , then the total volume of products carried by the chimney per kilo. of carbon burnt is given by the formula

$$V = 1·854 \left( \frac{100 - n}{n} \right) \text{ cubic metres.}$$

## 224. AN INTRODUCTION TO THE STUDY OF FUEL

Applying this to the above example where  $n = 9.9$ , the total volume of products is

$$V = 1.854 \left( \frac{100 - 9.9}{9.9} \right) \\ = 16.8714 \text{ cubic metres,}$$

which agrees fairly well with the value found above. This formula is used also to calculate the heat lost in the exit gases for every kilogram of carbon burnt (see Appendix IV.).

The reduction of pressure due to the chimney draught or induced draught can most simply be measured by a U tube filled with water coloured with an aniline dye. The U tube is fixed in an upright position, and a tube bent at right angles is fixed on to one limb. This tube passes through a cork or stopper which fits into a hole in the chimney or flue wall so as to make an airtight joint. The tube extends into the chimney or flue, and the end is at right angles to the direction of flow of the gases. The difference of level of the liquid in the two limbs of the U tube can be read off by means of a sliding scale divided into inches or millimetres.

For the measurement of draught with any degree of accuracy for determining the velocity of flow of the gases the above simple apparatus is too rough. In order to gain greater delicacy the apparatus shown in Fig. 59 has been designed. This is known as Seger's Differential Manometer. It consists of two wide glass tubes B and C connected together by the U tube A which has been carefully calibrated. The scale D can be moved to enable the zero to be adjusted. The apparatus is filled with two non-miscible liquids of nearly the same specific gravity, so that the point of contact of the two liquids is practically at the zero of the scale. Liquids suitable for filling the apparatus are water and aniline, solar oil and dilute alcohol, and to render the reading easier one of the liquids can be coloured. The apparatus is mounted on a board, which enables it to be carried about and hung near the place where the observation is to be made. If the pressure to be measured is greater than that of the atmosphere, B, i.e. connected by means of a cork and glass tube and rubber tube to the space where that pressure prevails; if it is below atmospheric pressure the connection is made to C,

one limb in each case remaining open to the atmosphere. An increase of pressure at B or a decrease at C causes a change in levels of the two surfaces

at B and C. This is marked by a much greater change in position of the contact surfaces of the two non-miscible liquids in the narrow tube A, and this movement takes place in the ratio of the cross-sections of the wide tubes and the narrow tube A. For example, if the ratio of the cross-section of the narrow tube A to that of the wider one B and C is  $1 : 30$  then a movement of 1 mm. of the surface in B will produce a movement of 30 mm. of the contact surface in A and hence very small movements can be measured. The scale can be divided into inches or millimetres or in any arbitrary scale which may be desirable. The delicacy of the apparatus can be enhanced by increasing the ratio of the narrow tube to the

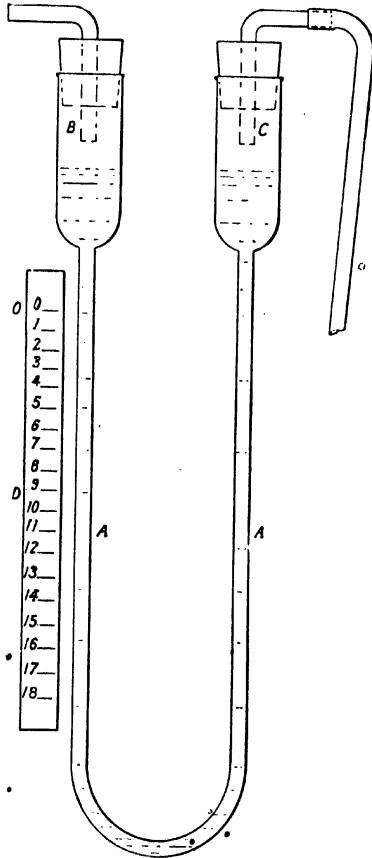

FIG. 59.—Seger's Differential Manometer.

wider one and by employing two non-miscible liquids of as near the same specific gravity as possible. Several instruments of practically the same principle have been proposed. Instruments like the above measure the difference between the atmospheric

pressure and the pressure in the space in question, and are called manometers.

*Anemometers* are instruments which measure the dynamic difference of pressure and give the velocity of gas flow directly. A simple and fairly extensively used anemometer is that due to Fletcher and modified by Lunge, and this is shown in Fig. 60. In this instrument, both limbs of the U tube *a* and *b* in figure, are brought into communication with the current of gas. The two tubes which reach into the gas current pass through a cork or rubber bung which fits tightly into a hole in the chimney or

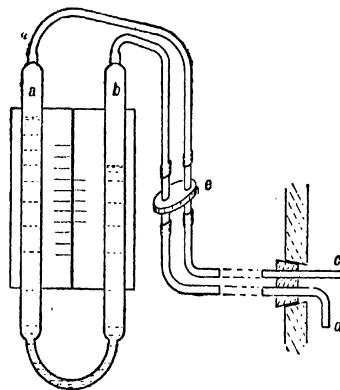

FIG. 60.—Fletcher's Anemometer.

flue wall. One of these tubes has its open end parallel to the direction of flow of the gases, the other at right angles to this direction (*c* and *d* respectively in figure).

It is extremely important that these tubes should reach well into the chimney or flue, and that the bent tube *d* should be at right angles to the direction of flow, so that the gases blow directly into this tube. These

tubes are connected with the U tube by means of stout rubber tubing *via* the arrangement *c*, by means of which *c* and *d* can be put into communication with *a* and *b*, or *b* and *a* at will, so enabling a check to be obtained on the observations. The U tube is filled with ether to the zero of the vernier scale. The current of air passing *c* produces a diminution of pressure, and hence the ether rises in *a*; and the air blowing in *d* produces an increase of pressure in *d* and hence the ether sinks in *b*. The difference between the levels of the liquid in *a* and *b* is read off on the millimetre scale which is provided with a vernier. A table is supplied with each instrument, which gives (in feet or metres per second),

the velocity of flow corresponding to the differences of level observed.

Recently another form of gas measurer has been proposed, known as a "Rota Measure." This consists of a vertical glass tube which contains a float. When the current of gas passes up the tube the float rotates and rises to a height which varies with the velocity of the current of gas. The float does not come into contact with the walls of the glass tube, and hence is very sensitive to changes of velocity. The glass tube is graduated either into inches, millimetres, or into divisions corresponding to a definite velocity of gas current. This instrument is said to be extremely accurate, and the makers assert that it can be used for both large and small quantities of gas, for 1 or 2 litres per hour or for many thousands. It is difficult to see how this instrument could be used to measure the quantity of gas carried by a chimney unless the gases be cooled to a temperature not much above ordinary atmospheric temperature.

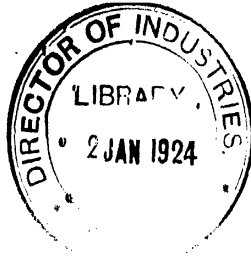

## CHAPTER XIV

### FURNACE EFFICIENCY AND FUEL ECONOMY

THE question of efficiency of combustion has been dealt with in a previous chapter (*cf.* Chap. XII.). It is now necessary to consider the various heat losses which accompany all technical uses of fuel, and where possible to indicate where a measure or estimate of the amount of each loss may be arrived at.

The losses can be classified as:—

(1) Combustion losses:

(a) Incomplete combustion of carbon forming  $CO$ , or the formation of dense smoke, or the loss of combustible gases, hydrogen and hydrocarbons, in the flue gases.

(b) Incomplete combustion of the fuel owing to the combustible material falling with the ash into the ashpit.

(2) Radiation losses: losses of heat by radiation and conduction from the furnace walls, etc.

(3) Loss of heat in the products of combustion.

(4) Loss of heat in the working substance, such as fluid metal or molten slag, which are run out of the furnace.

(5) Loss of heat in the hot ashes, which fall out of the furnace into the ashpit.

These losses will now be briefly discussed.

(1) Combustion losses:

(a) The formation of carbon monoxide in a furnace indicates either careless firing or improper air supply, except in cases like the iron blast furnace, where the reactions tend to produce  $CO$ . When carbon monoxide is formed and escapes combustion the loss is a twofold one—carbon is lost as monoxide, and carbon burning to carbon monoxide evolves less heat than carbon

burning to carbon dioxide. This can be emphasised by comparing the two thermo-chemical equations

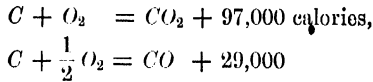

and hence it is seen that when carbon burns to carbon monoxide only about 0.3 of the heat obtainable by complete combustion is evolved. The other combustible gases, hydrogen and hydrocarbons, are only found in traces in products of combustion, but they may be found in considerable quantities in products of combustion from explosion engines, or from furnaces fired by gas or oil. The analysis of flue gases, when regularly made, forms a means of checking both firing and air supply.

The two ratios

$$\frac{[CO]}{[CO_2]} \text{ and } \frac{[CO]}{[CO] + [CO_2]}$$

$[CO]$  and  $[CO_2]$  denoting the percentage by volume of carbon monoxide and carbon dioxide respectively, are extremely important. The ratio  $\frac{[CO]}{[CO_2]}$  gives the ratio of the quantity of carbon burnt to carbon monoxide to that burnt to carbon dioxide, while the ratio  $\frac{[CO]}{[CO] + [CO_2]}$  gives the ratio of the quantity of carbon burnt to carbon monoxide to the total carbon burnt. These two ratios can vary within limits,  $\frac{[CO]}{[CO_2]}$  from 0 to infinity and  $\frac{[CO]}{[CO] + [CO_2]}$  from 0 to 1, since the quantity of  $CO$  can vary from 0 to 34.7 per cent. and the  $CO_2$  from 0 to 21 per cent. by volume. The percentage of carbon dioxide in the flue gases from a furnace depends upon the form of the furnace. The furnaces are constructed so as to give complete combustion with the least possible excess of air. In boilers which are mechanically stoked the percentage of carbon dioxide is from 10 to 12 per cent.; hand-stoked boilers give lower  $CO_2$  figures than the above, while in certain smelting furnaces, such as reverberatory furnaces, the  $CO_2$  may fall as low as 4 to 6 per cent. owing to the admission of

large quantities of air through the working doors. The carbon monoxide in these cases is usually a mere trace, if not *nil*. It is frequently more advantageous in practice to allow a small quantity of combustible gas (*CO*, etc.), to escape, rather than to ensure complete combustion by employing a large excess of air.

(b) The loss of fuel caused by the ashes carrying more or less unburnt fuel into the ashpit varies greatly with the nature of the fuel. It has already been pointed out that coals behave differently when heated (*cf.* p. 135). In some cases they sinter or cake, forming a more or less compact mass, and in other cases they break up and decrepitate in the fire, flying into small fragments which subsequently easily fall through the bars into the ashpit. If the ash melts and tends to form "clinker" the semi-fused product readily entraps pieces of coal or coke, prevents its combustion, and carries it finally into the ashpit. In the same way, when fine coal or slack is used, it finds its way through the firebars with the ashes or clinkers which are periodically removed. This source of loss can be greatly reduced by suitable design of grate and by careful selection of the class of fuel for the particular purpose in view.

The loss of carbon in the form of smoke is not so serious as might be supposed. When a chimney is emitting dense black smoke the proportion of carbon lost is not very considerable, and if it were not for the fouling of the atmosphere and, in many cases, the injury to vegetation, it might be neglected. When a chimney is emitting dense black smoke it is a sign that very incomplete combustion is taking place in the furnace. Many devices have been proposed for smoke prevention, such as causing the products of combustion to pass through a strongly-heated space, or through the more strongly-heated zones of the fire. The smoke deposits soot in the flues through which it passes and thereby reduces the effective area of the flues, and hence reduces the draught. Soot is by no means pure carbon, but contains, in addition to carbon, hydrogen in small quantity; soot may be a highly polymerised hydrocarbon, and it is difficult to remove the hydrogen completely from it. As a general rule, the greatest quantity of smoke is evolved immediately after fresh coal has been introduced into the furnace, and it is accompanied by a greater or lesser proportion



of distillation products of the coal, such as the volatile hydrocarbons. Thus the emission of dense smoke into the atmosphere, apart from its injurious properties, is objectionable because it is a sign of incomplete combustion, and because with it unburnt gases may be escaping, entailing a considerable loss of fuel.

(2) When a furnace is lighted up, a certain quantity of heat is absorbed by the walls, firebars, brickwork and other parts. This occasions a considerable consumption of fuel for "heating up" when the furnace is used intermittently, but when it is used continuously these sources of loss become negligible.

A very considerable loss is occasioned by the conduction and radiation of heat by the walls of the furnace, the free surface of the fire, or the surface of a steam boiler. These losses can be greatly reduced by surrounding the various parts with some heat-insulating material, such as slag wool, fossil meal, or asbestos. The non-conducting properties of many of the substances employed for this purpose depend upon their cellular nature, the cells being filled with air, which is a bad conductor of heat.

The conduction and radiation losses are also reduced by building the boilers or furnaces in batteries, thereby reducing the number of walls exposed to the atmosphere.

In some cases the radiation and conduction losses are purposely increased by cooling the walls of the furnace or other heated part by a water jacket through which cold water is kept flowing. This is frequently done in certain metal smelting furnaces and in gas engines, the reason being that the various parts last longer and repairs can be more easily effected when they are necessary. It is, in fact, a balancing of the heat loss against gain in life of the apparatus, and convenience, and from an economic standpoint the advantage is on the side of the longer life, etc. The loss of heat due to these two causes varies very greatly in different cases, and it is difficult to obtain a reliable measurement of it. It is usually taken as the difference between the total heat introduced into the furnace (*i.e.*, the heat evolved by the combustion of the fuel and the heat brought in by the air, if heated) and the heat converted into work plus the heat losses which can be accounted for in the other ways here mentioned. These losses in general vary from 6 to 15 per cent. for steam boilers, and are very much higher

## 292 AN INTRODUCTION TO THE STUDY OF FUEL

in metallurgical furnaces, reaching 50 to 60 per cent. in the case of Siemens steel furnaces. Blast furnaces differ from each other according to the method of construction, but 15 to 25 per cent. can be taken as an average figure.

There is no method of measuring these losses directly, but it can be pointed out here that the quantity of heat which passes through a given cross-section of material in a given time can be calculated by means of the formula

$$Q = K \cdot z \frac{t_2 - t_1}{d} q,$$

where  $K$  is the coefficient of heat conductivity, that is, the quantity of heat which passes through each square millimetre of surface of a plate 1 mm. thick per second when there is a difference of temperature of  $1^\circ$  C. between the two faces of the plate.

$t_2$  and  $t_1$  are the temperatures of the two sides of the plate.

$z$  = the time in seconds.

$q$  = the cross-section in square millimetres.

$d$  = the thickness of the plate in millimetres.

$K$  varies with each material and also with the temperature.

The radiation of heat follows the Stefan Boltzmann law already referred to on p. 99. The quantity of heat radiated can be calculated from the equation

$$Q = \frac{C_1 q z}{10,000} [T_2^4 - T_1^4],$$

where  $Q$  is the quantity of heat radiated by one square metre of surface per hour.

$C_1$  = a constant depending upon the nature of the substance or material.

$T_2$  = the absolute temperature of the radiating body.

$T_1$  = the absolute temperature of the body which receives the radiations.

$z$  = the time in hours.

$q$  = the area of the radiating surfaces in square metres.

The above formula is only rigorously true for the theoretical black body.

At present these equations cannot be modified so as to enable

a reliable measure of the heat lost by radiation and conduction to be made.

(3) Loss of heat in products of combustion.

The products of combustion pass into the chimney flues at high temperatures. They carry away a large quantity of sensible heat, the amount of which varies with the composition of the exit gases. It depends primarily upon the composition and specific heats of the product and upon their temperature. In order to calculate the heat lost in the products, an analysis must be made of the flue gases, so as to ascertain their average composition during a considerable period of working—an hour, shift, or day. The quantity of coal burnt during that time, its calorific power, and the temperature and volume of the products must be known. The magnitude of these losses is different in different operations. For example, in a carefully fired steam boiler, working with no great excess of air, and with the gases entering the chimney flue at a temperature of  $200^{\circ}$  to  $300^{\circ}$  C. above the surrounding atmosphere, the loss is about 15 to 25 per cent. In smelting furnaces, where the gases enter the flues at a very much higher temperature, the loss is correspondingly greater, and may reach 60 to 70 per cent. The whole of the heat passing into the chimney flues must not be reckoned as loss, for, as already pointed out on p. 218, a temperature difference between the gases in the chimney and the outside air is necessary to actuate the draught. If the gases were cooled to the same temperature as the air outside, the chimney would no longer draw, and mechanical draught would have to be employed. The mechanical draught requires power to drive it, and hence, in the end, requires a certain consumption of fuel. It is important to control the temperature at which the gases enter the chimney, since there is a temperature at which the chimney draws best, and, as already shown, this is about  $273^{\circ}$  C. above the surrounding air, but at temperatures considerably below this the draught is still good enough for supplying the air necessary for combustion and removing the products.

When mechanical draught is employed, the products may be cooled down to any extent. This is effected by employing the heat in the products of combustion to superheat the steam, to heat the air supplied to the furnace, or to heat the feed water

234 AN INTRODUCTION TO THE STUDY OF FUEL

supplied to the boiler. In practice it is not possible on economical grounds to cool the products down to ordinary air temperatures, and so obtain nearly all their sensible heat. The reason of this is that below a certain temperature gases give up their heat very slowly, and hence the rate of flow through the flues would be slow and the heat economisers would be very long and difficult to construct, and the small gain of heat more than outweighed by the expense of construction.

A very successful method of economising heat in products of combustion has been used in an electrical supply station in London, and the author is indebted to the designer and engineer for the following details. The steam boilers were altered from natural to induced draught, worked by a fan. The heated products of combustion were passed through a main air heater, an economiser, and a preliminary air heater. The air required by the furnaces for combustion of the fuel passed first through the preliminary air heater, where its temperature was raised; it then passed to the main air heater, from which it issued at a relatively high temperature and passed to the furnaces. The temperature changes, measured during actual test, are as follows:—

—	1.	2.	3.
Gases leaving main heater	( 284° C. 542° F.	284° C. 542° F.	284° C. 542° F.
Gases entering economiser	( 254° C. 488° F.	219° C. 425° F.	204° C. 398° F.
Gases leaving economiser	( 197° C. 377° F.	not taken	149° C. 300° F.
Gases leaving preliminary heater on way to chimney	( 155° C. 311° F.	139° C. 281° F.	133° C. 271° F.
Temperature of atmosphere	( 11° C. 51° F.	10° C. 50° F.	40° C. 102° F.
Air entering main heater	( 65° C. 146° F.	not taken	65° C. 146° F.
Air entering furnaces	( 137° C. 278° F.	115° C. 239° F.	130° C. 262° F.

## FURNACE EFFICIENCY AND FUEL ECONOMY 235

The effect of heating the air supplied to the furnaces was that a great increase in economy of fuel was effected, and the output of steam from the boilers greatly increased.

The enormous increase in the amount of water evaporated per hour when heated air is employed can be seen from the following figures. The tests were made upon two boilers, viz., a Stirling and a Babcock. The coal used was small Welsh coal, having a calorific power of 13,500 B.T.U. per lb. as worked.

	Stirling.		Babcock.	
	Cold Air.	Hot Air.	Cold Air.	Hot Air.
Weight of water evaporated. Lbs. of water per hour	22,910	40,966	15,800	24,600

These enormous increases are due to, first, the extra heat brought into the furnace by the hot air, and, second, the increased rate of combustion of the fuel, so that a greater quantity of coal can be burnt per unit of grate area. The economical combustion of fuel depends very largely upon the solution of the problem of utilising waste heat, and one of the most serious losses occurs in the heated exit gases.

#### (4) Loss of heat in the working substance.

A certain quantity of heat is carried away in the working substance. In a steam boiler a loss of heat is experienced in the exhaust steam; in metal smelting furnaces, the hot metal and the slag which are run out from time to time, or, in some cases, continuously, constitute a very considerable heat loss. The exhaust steam from steam engines is condensed, so that the resulting water is at a fairly high temperature, 50° to 90° C., and this is returned to the boiler, thereby effecting a very considerable economy. Again, in many metallurgical operations, the hot metal is transferred from one furnace to the other, without allowing it to solidify, thereby avoiding the necessity of re-melting, and consequently reducing the consumption of fuel and reducing the loss of heat. An example of this is the direct conversion of iron into steel by the Bessemer and Siemens-

Martin processes, in which the iron is conveyed in a molten state directly from the blast furnace to the Bessemer converter or Siemens furnace.

Slags, which are tapped out of furnaces periodically, or, as in the iron blast furnace, run out continuously, are sometimes used for heating the air supplied to workshops.

(5) Loss of heat in falling ashes.

The ash which remains after combustion of the fuel has to be removed from the furnace from time to time, and since this is raked out in a strongly heated condition, it constitutes a source of loss of heat. When the ash is easily fusible, and forms clinker, particles of unburnt fuel are readily trapped, and are removed from the furnace with the ashes. This source of loss is closely connected with that described in (2) (b) above. When the draught is very fierce, heated ashes and unburnt coal are ejected through the chimney or funnel.

Locomotives, especially when working heavily, *i.e.*, drawing a heavy train or ascending a steep gradient, throw out showers of sparks and, according to observations made, these sparks account for a loss of about 10 per cent. of the fuel, and this loss was increased under certain conditions of working to 20 per cent.

The ashes removed from furnaces should be regularly examined and tested for unburnt fuel, and if this is considerable, the calorific power must be determined in a calorimeter, as described for fuel in Chap. IV., and from the results obtained and from a knowledge of the calorific power of the original fuel, the percentage loss of heat due to this cause can be estimated.

The amount of heat usefully employed depends upon the extent to which the above losses are avoided.

The measure of efficiency of a steam boiler is practically universally conceded to be the amount of water evaporated per unit weight of fuel burnt, *i.e.*, lbs. of water evaporated per lb. of fuel burnt. A difficulty here arises, since, in order to make a comparison of different boilers, equally good coal should be used, the feed water supplied at the same temperature, and the steam raised to the same pressure. As this is impossible in making tests, a standard has been adopted, and all tests are

brought to this standard for comparison. This is called the "Equivalent evaporation from and at 100° C. (212° F.) per lb. of combustible," or the evaporation if the coal used had been without ash, the feed water supplied at boiling point, and the steam delivered at atmospheric pressure. The equivalent evaporation is calculated from the formula

$$E = P \left( \frac{1 + 0.3 (t_2 - 212) + (212 - t_1)}{966} \right),$$

where

$P$  = evaporation observed per pound of combustible,

$t_2$  = temperature of the steam at observed pressure,

$t_1$  = temperature of feed water.

The efficiency of a smelting furnace can be expressed as the quantity of metal melted or reduced from its ore per unit weight of fuel burnt; and that of an annealing furnace can, in a similar way, be expressed as the weight of metal annealed per unit weight of fuel burnt.

The heat given up both to the working substance and to the surrounding objects takes place in accordance with the same laws. This depends upon several factors, namely:—

(1) *The heating surface*, and consequently the heating surface in boilers, for example, is increased by the employment of water tubes and fire tubes, so exposing the maximum surface possible to the heat of the furnace and of the hot products.

(2) *The difference of temperature* between the furnace and working substance should be as high as possible.

This follows directly from a consideration of the equation for the conduction of heat given on p. 232, since it is evident that the greater the difference ( $t_2 - t_1$ ), the greater is the magnitude of  $Q$ .

(3) The products should have as great a specific heat as possible.

It has already been pointed out that the air supply should not be excessively great, but must be so regulated as to give the most complete combustion with the minimum excess of air.

The specific heat of the products is greatest when they contain a large proportion of carbon dioxide and water vapour, and hence

## 238. AN INTRODUCTION TO THE STUDY OF FUEL

fuels rich in carbon and hydrogen are employed. It has already been shown that water gas is a more efficient heating agent than Dowson or producer gas, which contain large proportions of nitrogen. The specific heats of carbon dioxide and water vapour are not only higher than that of nitrogen, but they change considerably with the temperature. For this reason, the content of carbon dioxide is kept as high as possible in exit gases, 12 per cent. by volume being a fair average figure for carefully fired boilers, and this can easily be maintained when working under constant load, and especially when mechanical stokers are employed.

(4) Time of contact between heating substance and working substance.

This follows from (1) above, and hence the velocity of flow of the gases through the furnace must not be too great. The velocity is, however, limited by the quantity of fuel which has to be burnt in a given time in order to produce the desired effect, and hence it may be more economical to burn a larger quantity of fuel and shorten the time required to complete the work than to economise fuel and to lengthen the time of work. As pointed out above, the heating apparatus might be very considerably lengthened, so increasing the time of contact with the heating substance. Here again economical and practical grounds set a limit, and when the apparatus exceeds this, the small heat gain is more than outweighed by difficulty of construction, space occupied, and cost of maintenance.

The increase in economy effected by utilising waste heat for heating the feed water and the air supplied to the furnace is very strikingly illustrated by some figures of costs, supplied to the author by a prominent London engineer in connection with

	Units to Mains.	Cost of Coal Used.	Cost of Coal per Unit.
Natural draught . . . . .	77,240	£ 114	d. 0.358
$\frac{2}{3}$ two-stage air heating and $\frac{2}{3}$ natural draught . . . . .	86,093	124	0.347
Two-stage air heating . . . . .	83,497	115	0.332



## FURNACE EFFICIENCY AND FUEL ECONOMY'299

certain tests on the two-stage air-heating system previously mentioned. The boilers were run for three successive weeks and the steam employed for generating electricity. The coal consumed and the units of electricity supplied to the mains were measured, and the cost per unit calculated on the coal burnt.

By employing air heating and forced draught, the quantity of steam per boiler was greatly increased, and apart from the very considerable economy in fuel, a saving in outlay of capital was effected, owing to the increase of output per boiler, reducing the number of boilers necessary to cope with the work.

## CHAPTER XV

### HEAT BALANCES, FURNACE AND BOILER TESTS

THE actual working of steam boilers and furnaces with various classes of fuel has to be tested and compared with working which is theoretically possible, and with the results obtained in practice: the actual testing of a steam boiler necessitates a large number of observations and measurements. In general, it is necessary to observe or determine—

- (1) The weight of fuel burnt in a given time.
- (2) The composition of the fuel, and its calorific power.
- (3) The quantity of ash collected in the ash pit.
- (4) The quantity of water evaporated in a given time.
- (5) The temperature and composition of the exit gases.
- (6) The pressure, and hence the temperature of the steam.
- (7) The temperature of the feed water supplied to boiler.
- (8) The temperature of the air supplied to the furnace.
- (9) The barometric pressure and the draught (natural or artificial).

Further, if the trials are made in order to compare one boiler with another, care must be taken that the conditions are as nearly as possible the same at the time of starting and stopping each trial. From the above data, the performance of the boiler can be judged, and a comparison made with other boilers of different design. A conclusion can thus be arrived at as to the suitability of the equipment in question.

From a knowledge of the quantity of fuel burnt, its calorific power, the temperature and quantity of the air supplied to the furnace, the total heat generated can be calculated.

From the quantity of water evaporated, and the temperature of feed water and steam, the quantity of heat converted into a useful form can be obtained, since it is almost universally conceded that this factor constitutes a measure of the efficiency of

the boiler. This is usually expressed as the equivalent evaporation from and at 212° F. (see p. 237). From the temperature, composition, quantity, and specific heats of the products of combustion, the quantity of heat lost in the exit gases can be calculated.

From the quantity of ash and its calorific power when it contains any considerable quantity of combustible material, and the quantity of carbon monoxide in the exit gases, the loss due to incomplete combustion can be calculated, and the heat lost in the hot ashes can also be estimated.

The difference between the total heat generated in the furnace and the heat usefully employed plus the sum of the above losses, gives the heat lost by conduction and radiation or otherwise unaccounted for.

In cases of a blast furnace, the heat usefully employed is calculated from the weight of iron reduced, and the heat required for its reduction, and the heat in the iron when run out of the furnace.

The working of a gas producer is judged from the temperature, composition, calorific power, and quantity of the gas. A smelting furnace or annealing furnace is judged by the quantity, temperature, and specific heat of the metal melted or annealed. It is customary in this country to employ the Fahrenheit degree, the British Thermal Unit per lb. of fuel, the pound as unit of weight, and the cubic foot as unit of volume. (For the relationship between these and the metric weights and measures used in the foregoing chapters, see Appendix V.)

As an example of the results obtained in an actual test of a steam boiler, which is typical of such trials, the following figures supplied by Messrs. Babcock and Wilcox will serve.

The boilers tested were two of Babcock and Wilcox's well-known water tube type and provided with separate grates 4 ft. 10 ins. in width by 6 ft. in length. The firebars were  $\frac{1}{8}$  in. thick, and the spaces between the bars constituted 27.5 per cent. of the total grate area.

The boilers were worked for 60 per cent. of the time of trial by natural draught and for the remainder of the time the air was supplied by injectors. A feed water heater and an economiser

## 242 AN INTRODUCTION TO THE STUDY OF FUEL

were used for heating the water previously to entrance into the boiler. The complete data of the test are as follows:—

(1) *Fuel.* The fuel consisted of good gas coke having the composition, when free from moisture which can be removed by drying at 100° C. (212° F.)—

Carbon . . . . .	87·30 %
Hydrogen . . . . .	0·78 %
Oxygen . . . . .	2·36 %
Nitrogen . . . . .	0·00 %
Sulphur . . . . .	1·29 %
Ash . . . . .	8·27 %
	<u>100·00</u>

Loss of weight of coke when dried at 212° F. = 2·9 per cent.  
 Calorific power directly measured in calorimeter = 12,831 B.T.U. per lb. fuel.

Total weight of fuel fired in 7½ hours . . . . .	8,640 lbs.
„ „ dry fuel fired in 7½ hours . . . . .	8,369 „
„ „ ash and unconsumed carbon rejected . . . . .	709 „
„ „ combustible burnt . . . . .	7,680 „
„ „ coke fired per hour . . . . .	1,152 „
„ „ dry coke fired per hour . . . . .	1,118 „
Combustible burnt per hour . . . . .	1,024 „

(2) *Gases and air. Temperatures—*

Temperature of external air (mean) . . . . .	63·2° F.
„ „ stokehold . . . . .	71·3° F.
Average temperature of products leaving boilers . . . . .	561·5° F.
Average temperature of products leaving economisers . . . . .	361·4° F.

(3) *Composition of products—*

	Before Economiser.	After Economiser.
Carbon dioxide . . . . .	9·88 % by vol.	8·79 % by vol.
Carbon monoxide . . . . .	0·05 %	0·05 %
Oxygen . . . . .	9·82 %	10·89 %
Nitrogen . . . . .	80·25 %	80·27 %
	<u>100·00</u>	<u>100·00</u>



244 AN INTRODUCTION TO THE STUDY OF FUEL

	B.T.U.	
<i>(7) Heat carried away in—</i>		
(a) Products of combustion . . .	1,039	= 8.0%
(b) Surplus air (nitrogen and oxygen)	971	= 7.5%
(c) Water vapour contained in air . .	42	= 0.3%
(d) „ „ from moisture in coke . . . . .	39	= 0.3%
Total loss in products . . .	2,091	= 16.1%
 <i>(8) Heat loss due to—</i>		
(a) Imperfect combustion . . .	9	= 0.1%
(b) Unburnt carbon in ashes . . .	26	= 0.2%
(c) Ashes drawn from furnace . . .	40	= 0.3%
(d) Radiation, conduction, etc. . .	898	= 6.9%
Total sundry losses . . .	973	= 7.5%

Hence, the final balance of heat per lb. dry coke burnt is:—

	B.T.U.	
Total heat usefully employed . . .	9,903	= 76.4%
Total heat lost . . . . .	3,064	= 23.6%
Total heat produced per lb. of dry coke burnt . . . . .	12,967	100.0

The result can also be considered from the standpoint of the boilers only, leaving out the performance of the economiser, or separating the two. If this is done for the above trial the heat balance becomes:—

BOILERS ONLY.

(1) Total heat produced in furnace per lb. of dry coke . . . . .	12,813	B.T.U.
Heat brought in by air, moisture, and coke . .	154	
	12,967	
(2) Heat appropriated by water in boiler . . .		
	9,147	70.5%

## HEAT BALANCES, FURNACE AND BOILER TESTS 245

(3) Heat carried away in—	B.T.U.	
(a) Products of combustion . . .	1,591	= 12.3 %
(b) Surplus air (nitrogen and oxygen)	1,254	= 9.7 %
(c) Water vapour in air . . .	61	= 0.5 %
(d) Water vapour from moisture in coke . . . . .	42	= 0.3 %
Total loss in products . . .	2,948	22.8 %
(4) Heat loss due to—		
(a) Imperfect combustion . . .	9	= 0.1 %
(b) Unburnt carbon in ashes . . .	26	= 0.2 %
(c) Ashes drawn from furnace . . .	40	= 0.3 %
(d) Radiation, conduction, etc. . .	797	= 6.1 %
Total sundry losses . . .	872	6.7 %

For the boilers, therefore, the balance is—

	B.T.U.	
Total heat usefully employed . . .	9,147	= 70.5 %
Total heat lost when no economiser is used . . . . .	3,820	= 29.5 %
	12,967	100.0

### ECONOMISER ONLY.

The heat available for heating the economiser per lb. of coke burnt is 2,948, and this heat is contained in the hot gases leaving the boilers.

The heat utilised by the economiser per lb. of dry coke burnt is:

	B.T.U.	
Heat absorbed by water in economiser	756	= 25.7 %
Heat lost in gases, excess air, water vapour . . . . .	2,091	= 70.9 %
Heat lost by radiation conduction . . .	101	= 3.4 %
Total heat available for economiser	2,948	100.0

The relatively large proportion of the heat available for heating the economiser which is lost in the products of combustion

is due to the fact that the heat is contained in a large volume of gas and the temperature comparatively low. In order to abstract more of this heat the size of the economisers would have to be greatly increased, and then the initial cost and the interest on capital would outweigh the gain in heat and the resulting fuel economy.

The efficiency of the boilers, etc., from the above trial can be stated thus:—

Efficiency of boilers and economisers . . . . .	76·4 %
„ „ alone . . . . .	70·5 %
„ economiser alone . . . . .	25·7 %

The efficiency in each case refers to the heat *available* for heating at each particular stage. Thus the boilers alone absorb 70·5 per cent. of the total heat evolved in the furnaces, and the economisers 5·9 per cent., but the economisers have only a portion of the total heat evolved in the furnaces available for heating them, and they employ 25·7 per cent. of this heat. In practice it is frequently the case that vast quantities of heat are lost, owing to that heat being at a low temperature, and in some respects is like the water which has driven a water-wheel, and consequently has sunk to a lower level. The quantity of water is the same, but it is at a lower level and hence cannot economically do further work. Heat can be resolved into a capacity factor and an intensity factor; the capacity factor  $S$  is termed the entropy, and the intensity factor  $T$  is the temperature, and hence if a quantity of heat  $q$  is available for doing work it can be written

$$-q = T.S.,$$

— $q$  because the heat is absorbed by the working substance and therefore disappears. Now a moment's consideration of this relationship will show that for any value of  $q$  there are an infinitely large number of values for  $T$  and  $S$  respectively, and that for small values of  $T$  the values for  $S$  are correspondingly large; in other words, low temperature means high entropy. It therefore follows that the *quantity* of heat contained in a given mass of material may be infinitely great, but the temperature difference is such that in the present state of knowledge the heat cannot



be utilised. The work done by heat is dependent upon a difference of temperature. The transformation of heat into mechanical energy (work) requires an intermediate substance or a working substance (water in the steam engine, the products of combustion in the explosion engine) which will absorb the heat at one temperature and reject it at a lower temperature. Owing, however, to the imperfect means of utilising the heat and transferring it to the working substance, the employment of heat at a low temperature is not possible on economic grounds. For example, 1,000 gallons of sea-water at 60° F. contain 600,000 B.T.U., and in order to produce this quantity of heat nearly half a hundred-weight of high-class steam coal would have to be burnt; but there are no means available by which the former heat energy can be converted into mechanical work. The heat balances of practically all heating processes show that a very large proportion of the heat generated is lost. In the above example the efficiency of the boilers is 76·4 per cent., which means that 76·4 per cent. of the heat of the fuel is transferred to the working substance. When this is converted into work it has to pass to the cylinders of the engine, where the steam expands from the boiler pressure to that of the atmosphere and performs work during its expansion. The steam leaves the cylinders at a fairly high temperature, and a large number of heat losses again accompany the transformation of the energy of the steam into work, so that finally only a small fraction of the total heat evolved in the furnace is converted into work. In many cases the exhaust steam from reciprocating steam engines is employed to drive a turbine, and a large amount of power is developed in this way, and the heat losses due to this cause reduced to a very considerable extent. The efficiency of a turbine is much greater than that of a reciprocating steam engine, but the problem of the most complete transformation of the heat energy of coal or fuel generally, is still unsolved. The fewer the number of steps required to convert the heat of combustion of fuel into work the greater the efficiency of the transformation, and in the ideal case the transference would probably be direct, without the intervention of a working substance.

The choice of fuels for any particular industrial operation depends upon a number of considerations which can only be indicated

here. Many metallurgical operations, such as the manufacture of iron and steel, of bronze, the refining of copper for subsequent drawing into wire, etc., for electrical purposes, require that the fuel used should be as low as possible in sulphur and arsenic. Sulphur is injurious to the iron, and both sulphur and arsenic are injurious and even ruinous from a standpoint of electrical conductivity tests, for copper. Again, in the case of iron, where the fuel comes into contact with the reduced metal, the composition and quantity of the ash is extremely important: firstly, because certain constituents of the ash, sulphur, phosphorus and silicon (as silica) readily find their way into the iron which is produced; and secondly, because the ash has to be removed from the furnace by means of the slag, and the charge of the furnace has to be arranged so as to allow sufficient flux for the removal of the slag-forming ingredients of the ash, as well as those present in the ore itself. For steam-raising purposes, the conditions under which the boilers work largely determine the quality of the fuel employed. Where a boiler is subject to a fairly constant demand and where the boiler capacity is ample, a relatively low quality fuel may be used. Thus in many cases refuse of various kinds is burnt and the heat generated used for heating boilers. Refuse, such as domestic refuse, the refuse from the crushing of the sugar cane (which is known as "bagasse" or "megasse"), and rice husks, in rice-producing countries, are burnt and the heat is used for raising steam. The destruction of town refuse by fire and the utilisation of the heat so generated for raising steam and production of electricity is now done in most large towns in destructor works, and this marks a very important advance in sanitary and engineering science. In order to burn such low-class fuels to the best advantage specially designed grates must be used. The area of the grate must be larger, since a larger quantity of fuel has to be burnt in order to produce a given effect than when high-class fuels are employed. In stationary boilers the space at disposal is usually fairly considerable, and by increasing the size of the grate fuels of poor quality can be used with advantage. Where the space is strictly limited, as in the locomotive, especially, and to a lesser degree in the steamship, fuels of a high quality must

be employed. The locomotive, owing to the comparatively small space available for both boiler and firebox, and owing to the variable demands made upon the steam supply, requires fuel which will burn with sufficient rapidity to raise the steam as quickly as possible, and hence the coal used is good quality bituminous coal, which ignites readily, burns rapidly with luminous flames and large evolution of heat. In sea-going steamships, where the necessity for extremely rapid combustion does not prevail, anthracitic coals of great calorific power, but more difficult to burn, are employed, and when the rate of combustion has to be increased, forced draught is employed, whereby both the furnace temperature and the rate of combustion are raised. Coke is utilised where absence of smoke and a high temperature are required, if sufficient draught is available.

In addition to the above general considerations, the conditions which may be termed "local conditions" also determine the class of fuel used for any particular purpose. Thus the question of the fuel available in the district or neighbourhood has to be considered, and the disadvantages or advantages of its use weighed against its price, easy supply and low rate of carriage, as compared with fuel of perhaps higher quality and greater suitability which could be obtained from a distance, thereby entailing greater carriage costs and more difficult supply.

Many attempts have been made to introduce the system of buying coal upon the basis of the heating value, and very different opinions are held as to the suitability of calorimetric tests of coal for determining the quality of the fuel and its applicability for any purpose. It has been urged that since the determination of the calorific power has to be done on a very small quantity, 1 to 2 grammes, the results so obtained would not be representative of the whole bulk. Again, the objection has been raised that the calorific power of a fuel does not give a reliable indication of the suitability of a given fuel, since the quantity and nature of the ash are not unimportant in many operations, and also that calorimetric control of fuel supplies is too costly for technical practice, owing to the apparatus required for the determination. A little consideration will show that these objections are much less serious than at first sight they appear to be. The determination

does greatly depend upon the sample being representative of the whole bulk, and it must be taken with due care. There is, however, no ground for believing that a carefully taken sample does not represent the average composition of a particular delivery. Large quantities of ores, pig iron, metals, etc., are bought and sold upon the results of analysis made upon a small sample, and there is no reason why the sample should be more representative in one case than in the other, assuming, of course, that equal care is taken in sampling in each case. The objection that the calorific power of a fuel alone is no indication of its suitability for a given purpose is valid, but, when the class of fuel suitable for the purpose in view has been selected, and when the method of firing has been decided upon, the value of that fuel depends upon its calorific power. The regular determination of the calorific power of the fuel then forms a ready check on the different deliveries and a valuable indication of the heating qualities of the fuel. Further, without a knowledge of the calorific power of a fuel the performances of a furnace under test or in regular work cannot be judged; but when this factor is known the value of the installation can be deduced from the results of a practical trial, similar to that recorded in this chapter. The question of the cost of testing the fuel has been raised, but in reality the cost is insignificant, especially where large quantities of fuel are employed, necessitating the placing of contracts for coal to be delivered over a period of six or twelve months. Certainly the initial cost of an apparatus for determining the heating power of a fuel, such as a bomb calorimeter, is fairly high; but when carefully used the apparatus lasts for a very long period, and hundreds of tests can be made before the apparatus requires to be repaired. The initial cost of an apparatus such as a William Thomson or Rosenbain calorimeter is very much less than the bomb calorimeter; the breakable parts of these instruments can be renewed for a few pence when necessary, and the cost per test of the fuel delivered is extremely small, and need not be considered. In spite of the objections raised against it, the calorimetric testing of fuel is very extensively employed by those who use large quantities of coal. In some cases firms buy their coal upon a basis of its calorific power, while in other cases

the calorific power is determined as a check upon the supplies and as a means of judging furnace and boiler efficiencies. The tendency of opinion among large fuel consumers is surely setting in the direction of the purchase of fuel upon a heating basis, and the proper use of a knowledge of the calorific power of the fuel certainly enables both the chemist and the engineer to utilise that fuel to the best advantage.

## CHAPTER XVI

### LIQUID FUELS

Liquid fuels have been successfully employed for firing metallurgical furnaces, locomotives, marine and stationary boilers, but owing to the small supply of oil available, compared with the enormous output of coal, their use is by no means general. The cost of the oil compared with the cost of coal necessary to give the same heating effect prevents it from competing with the coal as a fuel for general use. A brief discussion of liquid fuel is, however, necessary, since it is in use to a certain limited extent.

The liquid fuels most frequently employed are :—

(1) Petroleum as pumped up from the wells, raw petroleum, and the residues from the refining of this petroleum.

(2) Shale oil, the oil which is obtained in the destructive distillation of shale.

(3) Tar, from the dry distillation of coal and wood and the tar oils obtained by the distillation of coal tar. For heating purposes, vegetable oils, raw spirits (crude alcohol and methylated spirits), turpentine and benzine are used, but in much smaller quantities than the above-mentioned liquids.

The advantages of liquid fuels are :—

(1) They burn practically without residue.

(2) The combustion can easily be regulated so as to take place without the formation of smoke.

(3) The supply of fuel can be controlled, and hence the temperature of the furnace can be regulated.

(4) Liquid fuels have, as a rule, a high calorific power.

Against these advantages, the following disadvantages have to be balanced :—

(1) The high cost of the liquid fuels compared with solid fuels.

(2) The liquid fuels must be burnt in specially constructed burners, which have to be carefully tested.

(3) In order to ensure combustion taking place without a deposit of solid carbon being formed, the liquid fuel must be sprayed or "atomised," so as to enable thorough admixture with the necessary air to be effected. When some liquid fuels pass through a heated supply tube they are partially decomposed, and deposit solid carbon which blocks up the tubes and prevents continuous working.

The facts that petroleum forms the starting-point for obtaining many valuable products, such as vaseline, petrol, lubricating oils, and that tar is the source of benzene, naphthalene, etc., all militate against their general use as fuels and tend to maintain the high price of these materials.

*Petroleum or Rock Oil* is found in parts of America and also in Russia, especially at Baku. Oil wells also are extensively worked in Burmah, India. The liquid is known as naphtha, and has a tarry smell and dark colour; it consists of a mixture of various hydrocarbons, and its density, appearance and other properties vary with the amount of the different hydrocarbons which it contains. Petroleum is obtained by sinking wells and deep bore holes in those localities where it occurs, the oil being frequently thrown up to a great height.

The crude petroleum is refined by distillation, whereby it is resolved into a number of fractions which are technically important. The distillation is continued up to about  $350^{\circ}$  C. The lower boiling liquids, up to about  $130^{\circ}$  C., are known as benzoline, petrol, gasoline, and ligroin; the higher boiling fraction,  $130^{\circ}$  C. to  $275^{\circ}$  C., is the kerosine or paraffin oil used for illuminating and heating purposes. The specific gravity of kerosine varies from 0.78 to 0.84, while the lower boiling fractions have a specific gravity below 0.75. The high boiling fractions and the thick residues are used as lubricants. The American petroleum have in general a lower specific gravity than the Caucasian (Baku) petroleum, and contain a greater proportion of the light volatile constituents. The following table shows the specific gravity, elementary composition, heating

254 AN INTRODUCTION TO THE STUDY OF FUEL

value and the weight of water evaporated per unit weight of the fuel:—

	Specific Gravity.	C.	H.	O.	Heating Effect in Calories.	Weight of Water Evaporated per Unit Weight of Fuel.
Heavy naphtha, Pennsylvania . . . . .	0·866	84·9	13·7	1·04	10,672	15·30
Light naphtha, Pennsylvania . . . . .	0·816	82·0	14·8	1·2	9,963	14·05
Refined petroleum, America . . . . .	—	85·5	14·2	0·3	11,086	—
Heavy naphtha, Baku . . . . .	0·938	86·6	12·3	1·1	10,800	15·55
Light " " . . . . .	0·884	86·3	13·6	0·1	11,160	16·40
Heavy coal-tar oil . . . . .	1·044	82·0	7·6	10·4	8,916	12·77
Coal tar . . . . .	—	90·0	5·0	5·0	8,900	—
Petroleum spirit, Baku . . . . .	—	80·6	15·1	4·3	11,086	—
Residue from petroleum distillation (Masut) . . . . .	0·93	87·1	11·7	1·2	10,700	—

*Stale Oil*, with a calorific power of about 8,830 cals., and *Tar Oil* or *Creosote Oil*, having about the same calorific power, are both used as fuels. The oxygen in petroleum is due to water dissolved in the oil, and the oxygen in coal tar and coal-tar oil is partly due to water and partly to the presence of substances like phenol  $C_6H_5OH$ .

The employment of liquid fuels necessitates suitable means of conveying a continuous supply of the oil to the furnace, and a thorough mixing of the oil with the air required for complete combustion. The methods by which this is effected are different for thick and thin liquids. When thick liquids such as heavy petroleum residues and tar are employed, the fuel is allowed to fall on to the bottom of the furnace, the supply being regulated by a suitable tap. Air is admitted through openings and doors and a certain amount of a hard compact coke collects on the furnace bottom, which can be removed from time to time by a rake. This method of burning a liquid fuel is open to the



objection that it is difficult to obtain a sufficient air supply so as to ensure complete combustion. A deficiency of air results in a smoky flame which deposits soot in large quantities. Another method is to employ the Nobel "dish burner," which is suitable for either steam boilers or for metallurgical smelting furnaces. This burner consists of a number of shallow dishes which are placed one above the other. Each "dish" is provided with a tube which serves to keep the liquid in it at constant level, the overflow passing into the "dish" immediately beneath. The fuel is supplied from a reservoir into the uppermost dish and thence, *via* the overflow pipes, into those below. The air supply passes between the "dishes" into the furnace and a certain amount of secondary air is admitted through an opening in the furnace walls or front. The oil becomes strongly heated and ignites, the very hot flame so produced plays along the heating flues. The Nobel burner avoids the difficulty above referred to, namely the difficulty of a proper air supply. A boiler fired with "Masut," the residue from the distillation of petroleum, evaporated 14.5 lbs. of water per lb. of fuel, when the burning was effected by means of a Nobel dish burner.

*Masut* has a specific gravity of about 0.90 and a calorific power of 11,000 calories. When heated it decomposes and evolves a combustible gas at about 150° C., and at 300° C. it takes fire spontaneously. It is found that 62 lbs. of *Masut* will replace 100 lbs. of coal.

A very important method of employing liquid fuels is to atomise them in a suitable burner. The fuel is atomised by either a jet of steam or a blast of air. The oil is thereby intimately mixed with the air, complete combustion takes place, and a freedom from smoke is ensured. A burner of this type is shown in Fig. 61. The oil is supplied under a slight pressure, and the supply is regulated by the valves *a, a*; the air, under considerable pressure, is supplied through the pipe *b* and regulated by the nozzle *c*. The supply of oil and air are so adjusted that the finely divided oil is intimately mixed with air, and a rotary action imparted to the mixture which aids the complete smokeless combustion of the oil. An annealing furnace, fitted with the above type of burners and fired with coal-tar oil having a calorific power of

256 AN INTRODUCTION TO THE STUDY OF FUEL

about 8,500 calories and costing 6*d.* per gallon, cost almost exactly the same for fuel as a similar furnace fired with coal gas and air blast, the gas costing 2*s.* 3*d.* per 1,000 cub. ft. Tar is atomised by means of a steam jet, the tar being kept hot in a reservoir by a steam coil. The burner consists of two concentric tubes with the steam jet in the centre; the tar is

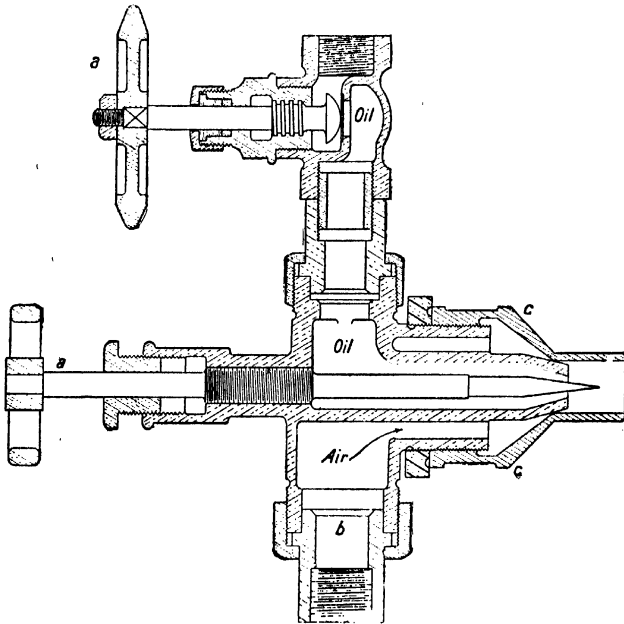
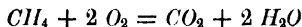

FIG. 61.—Allday's Empire Oil Burner.

supplied to the annular space surrounding it. The air necessary for the combustion is drawn in by the action of the jet, sufficient space being left round the outer tube for air to pass into the furnace. In all methods of burning liquid fuels it is of the highest importance that the fuel shall be intimately mixed with air. In the limiting case, where the liquid fuel is very finely atomised, the mixture with air is so intimate that the combustion is similar to the combustion of gas in a blowpipe.

The oil fuel flame, however, has the air outside, the oil being delivered at the centre; this is of course the reverse of a blowpipe working with gas. When the mixture of fuel and air is less perfect, the combustion is rendered incomplete, and a separation of solid carbon in the form of soot ensues and a smoky flame is obtained. Easily volatile fuels, such as petrol, benzoline, etc., are vaporised or atomised in suitable carburetters, and their combustion takes place, as a rule, by explosion, hence these fuels find extensive application for driving explosive motors. The combustion of hydrocarbons takes place with the formation of carbon dioxide and water, but when the combustion of complex hydrocarbons takes place, a number of intermediate decompositions may occur before combustion, especially when the fuel passes through strongly heated tubes. It has been shown by Bone that the combustion of even a simple hydrocarbon like marsh gas,  $CH_4$ , takes place *via* the formation of certain intermediate compounds, and that the equation



only represents the final stage of the reaction.

In the case of more complex hydrocarbons, a decomposition into simpler hydrocarbons and into solid carbon takes place. The type of reaction is the decomposition of ethylene into marsh gas and carbon by the action of heat.

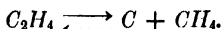

Such reactions lead to the formation of two or more stable bodies from the decomposition of an unstable substance. The deposit of carbon which results from such decompositions frequently chokes up the oil supply pipes and the burners, thereby preventing continuous working, as already referred to above.

Oil fuel has been successfully tried for locomotive firing in this country on the Great Eastern Railway, but, owing to the high cost of oil, the coal-fired locomotive still holds the field. Oil fuel is used considerably in Russia and Texas, where the supply is abundant, and the cost consequently low. The difficulties of transport prevent its general employment at any considerable distances from its source, however desirable a fuel it may be. For example, oil can be obtained at Baku for about \$1 per ton, but when

258 AN INTRODUCTION TO THE STUDY OF FUEL

delivered at an English port, the cost would be £3 16s. per ton. Even considering that the oil has twice the calorific power of coal, the cost is more than twice as great for the same number of heat units. As the output of oil increases, the discrepancy in cost will decrease, and probably in the future oil will be one of the most important and generally used fuels.

A comparison of the steam-raising value of fuels, both solid and liquid, is given below.

The calculated evaporation is that calculated from its composition, and is given in the first column. In the second column the evaporation actually found is given, and in the third, the percentage of the available heat which is utilised (Wright).

	Lbs. Water Evaporated. Calculated.	Per lb. Fuel Found.	Percentage of Heat Utilised.
Creosote oil . . . . .	16·78	13·35	79·56
Tar . . . . .	15·06	12·71	84·40
Gas coal . . . . .	14·24	10·01	70·30
Gas coke . . . . .	13·83	11·15	80·62
Cannel coal, Nottingham . . . . .	12·27	8·78	71·56
Cannel coal . . . . .	12·23	9·91	81·03

The comparison is qualitative rather than strictly quantitative, since the results obtained depend upon the method of burning, design of grate, etc., and hence general deductions cannot be made from these figures.

## APPENDIX I

For a more complete treatment of the subject than is given in the preceding pages, the reader is referred to the following books, most of which are found in almost every University library and in many public libraries.

### *General Chemical Principles.*

- Alexander Smith, "Inorganic Chemistry."  
James Walker, "Introduction to Physical Chemistry."  
Nernst's "Theoretical Chemistry."  
Nernst's "Applications of Thermodynamics to Chemistry."  
Haber, "Thermodynamics of Technical Gas Reactions."  
Van't Hoff, "Lectures in Theoretical and Physical Chemistry."

### *Calorimetry and Pyrometry, Fuel Analysis.*

- Pattinson Muir, "Elements of Thermal Chemistry."  
Le Chatelier and Boudouard, "High Temperature Measurements."  
Lunge and Berl, "Chemische Technische Untersuchungs Methoden," translated by C. A. Keane, Vols. I. and II.

### *Fuel.*

- Percy, "Metallurgy," Vol. I.  
Sexton, "Fuel."  
Roberts-Austen, "Introduction to the Study of Metallurgy."  
H. von Jüptner, "Lehrbuch der Chemischen Technologie der Energie," Vols. I. and II.  
F. Fischer, "Kraftgas."  
Muspratt, "Chemistry."  
Thorpe, "Dictionary of Applied Chemistry."  
J. B. C. Kershaw, "Fuel."  
Mills and Rowan, "Fuel and its Applications."  
J. W. Richards, "Metallurgical Calculations."

In addition to these treatises, articles are to be found in the—

“Iron and Steel Magazine.”

“Journal of the Iron and Steel Institute.”

“Engineer.”

“Engineering.”

“Proceedings of the Institution of Mechanical Engineers.”

“Ahrens, Sammlung Chemische Technische Vorträge.”

The above list does not aim at being complete or exhaustive, but only indicates the sources of additional information, and thus serves as a starting point for systematic study.

# APPENDIX II

## Comparison of the Different Forms of Energy.

	Absolute Units. Ergs.	Electrical Units. Watt Seconds.	Heat Units. Gram Calories.	Volume Energy Units. Litres Atmospheres.	Kilogram Metre.	Horse-power Seconds.
1 Erg . . . . .	1	$10^{-7}$	$0.239 \times 10^{-7}$ ( $0.23872 \times 10^{-7}$ )	$9.87 \times 10^{-10}$ ( $9.8692 \times 10^{-10}$ )	$1.02 \times 10^{-8}$ ( $1.0198 \times 10^{-8}$ )	$1.36 \times 10^{-9}$
1 Watt second . . . . .	107	1	0.239 (0.23872)	$9.87 \times 10^{-9}$ ( $9.8692 \times 10^{-9}$ )	0.102 (0.10198)	0.00136
1 Gram calorie . . . . .	$4.19 \times 10^7$ ( $4.189 \times 10^7$ )	4.19 (4.189)	—	$4.184 \times 10^{-2}$ ( $4.1842 \times 10^{-2}$ )	0.427 (0.4272)	0.0057
1 Litre atmosphere . . . . .	$1.0133 \times 10$ ( $1.01325 \times 10^9$ )	$1.0133 \times 10^9$ ( $1.01325 \times 10^9$ )	24.19 (24.188)	1	10.333	0.1378
1 Kilogram metre . . . . .	$9.806 \times 10^7$	9.806	2.3410	0.0968 (0.09678)	1	0.01333
1 Horse-power . . . . .	$7.355 \times 10^9$	735.5	175.6	7.26	75	1
Gas constant, R. T. . . . .	$0.832 \times 10^8 T$ ( $0.83155 \times 10^8 T$ )	$0.832 T$ ( $0.83155 T$ )	1.985 T (1.98507 T)	$0.0821 T$ ( $0.08207 T$ )	$0.848 T$ ( $0.84803 T$ )	—

The calorie here used is the quantity of heat required to raise 1 gram of water from 14.5—15.5° C., 1 watt second = 1 joule, and the absolute zero 273.09° C. below the freezing point.

## APPENDIX III

### *True and Mean Specific Heats.*

THE specific heat is in reality the ratio of the quantity of heat  $q$  to the rise of temperature which it causes, compared with the similar value of a standard substance. \* Since the standard substance is one gram of water raised one degree (from 15° to 16° C.) the second value is unity, and then, the ratio and the quantity itself are identical. The two expressions—heat capacity and specific heat are used interchangeably.

Let the true specific heat be denoted by  $\sigma_1$ , then

$$\frac{dq}{dT} = \sigma_1,$$

but since it is only a transfer of heat from one substance to another, Centigrade degrees can be substituted for degrees absolute, so the equation can be written

$$dq = \sigma_1 dt,$$

and this expression can be integrated between 0° to  $t^\circ$  C., or between 0° and  $T^\circ$  absolute,

$$q = \int_0^T \sigma_1 dt = \sigma_{m_1} T \quad (1)$$

$$q = \int_0^t \sigma_1 dt = \sigma_{m_2} t \quad (2)$$

where  $\sigma_{m_1}$  is the *mean* specific heat between 0° and  $T^\circ$  absolute, and  $\sigma_{m_2}$  the *mean* specific heat between 0° and  $t^\circ$  C., and these two are not necessarily identical.

The simplest relationship between the true specific heats and the temperature is given by the equation

$$\sigma_1 = a + \beta t.$$

Now substituting  $(T - 273)$  for  $t$ , the equation becomes

$$\sigma_1 = a + \beta (T - 273).$$



and setting

$$(a - 273) = a_1 \\ \sigma_1 = a_1 + \beta T$$

is obtained.

Putting this value for  $\sigma_1$  in equation (1).

$$\int_0^T \sigma_1 dT = \int_0^T (a_1 + \beta T) dT = a_1 T + \frac{\beta}{2} T^2 \quad (3)$$

and from (2) by substituting  $\sigma_1 = a + \beta t$

$$\int_0^t \sigma_1 dt = \int_0^t (a + \beta t) dt = at + \frac{\beta}{2} t^2 \quad (4)$$

are obtained.

Then by comparing the results obtained it is evident that

$$\sigma_{m_1} = a + \frac{\beta}{2} T \\ \sigma_1 = a + \beta T$$

and also that

$$\sigma_{m_2} = a + \frac{\beta}{2} t,$$

and

$$\sigma_1 = a_1 + \beta t.$$

If the true specific heat is a linear function of the temperature it differs from the mean specific heat between  $0^\circ$  and the temperature in question, simply by the fact that the second term is twice as great.

This method is frequently used, and it is often necessary to convert Centigrade degrees into absolute or *vice versa*, in the calculations. The calculation is simple, and is as follows:—The specific heat at constant volume between  $0^\circ$  and  $t^\circ$  C. has been given by Langen as

$$C_v = 6.7 + 0.0026t.$$

The true specific heat at  $t^\circ$  C. will be

$$C_t = 6.7 + 0.0052t,$$

and at  $T$  where

$$t = (T - 273)$$

$$C_T = 6.7 + 0.0052(T - 273) \\ = 5.28 + 0.0052T,$$

then the mean specific heat between  $0^\circ$  and  $T$  will be

$$C_m = 5.28 + 0.0026T.$$



# ALPHABETICAL INDEX

*The references are to the pages.*

- ACETYLENE**, 160  
**Adiabatic**, 188  
**Air**, excess of, 26, 222  
   " supply, 215 & f.  
   " theoretical quantity of, 26  
   " weight of, 19, 21, 24  
   " volume of, 20, 21, 24  
**Anemometer**, Fletcher's, 226  
**Anthracite**, 134  
**Anthracitic coals**, 134  
**Artificial draught**, 220  
   " " advantages of, &c., 220  
   " solid fuel, 139  
**Ash**, determination of, 31  
   " in fuel, 236  
**Aspirator**, 38  
**Atomiser**, 255  
**Avogadro's law**, 5  
  
**BABCOCK AND WILCOX boiler**, 241  
**Bagasse**, 248  
**Beehive coke oven**, 146, 147, 148  
**Bituminous coals**, 132 & f.  
**Blast furnace**, 241  
   " " gas, 176, 177, 178  
   " " reactions in, 178  
**Boiler**, Lancashire, 216  
**Boudouard**, 165, 166, 192  
**Boyle's law**, 4  
**Briquettes**, 156  
  
**CALENDAR recorder**, 93  
**Calories**, 51  
**Caloric intensity**, 51  
   " power, 51  
   " " calculation of, 52 & f.  
   " " determination of, 55 & f.  
**Calorimeter**, bomb, 64 & f.  
   " Boys', gas, 77  
   " Fischer's, 62  
   " Junker, gas, 74  
   " Parr, S. W., 70  
   " Rosenhain's, 60  
   " Thompson, Lewis, 56  
   " Thomson, W., 58  
**Calorimeters**, 55  
**Carbon**, combustion of, 3, 19, 28, 160 & f., 164, 173, 216 & f.  
   " determination of, 32  
   " dioxide, 164 & f.  
   " " determination of, 40  
   " monoxide, 160 & f.  
   " " determination of, 42  
**Carbureting**, 205  
**Catalyser, catalyst**, 12, 13  
**Catalysis**, 10  
**Charcoal burning**, 140 & f.  
**Chimney, draught of**, 218  
   " gases carried by, 219  
   " height of, 218  
**Choice of fuel**, 247  
**Classification of coals**, 130, 135  
   " " fuels, 127  
**Coal**, bituminous, 132 & f.  
   " formation from wood, 129  
   " furnace, 133  
**Coke**, determination of, 31  
   " beehive oven, 146, 147, 148  
   " Hoesener oven, 149 & f.  
   " manufacture of, 144 & f.  
**Combustion**, 1  
   " by explosion, 211  
   " change of heat of, 124  
   " in explosion engine, 20  
   " Lancashire boiler, 9  
   " locomotive firebox, 9  
   " losses, 229

- Combustion in producer, 160 & f.  
     " of carbon, 3, 13, 28, 160 & f.,  
         164, 173, 216 & f.  
     " temperatures 13, 118 & f.  
 Concentrations, 9  
 Cuprous, chloride, 42  
  
 DALTON'S law, 10  
 Dellwick-Fleischer, 182  
 Density, 16  
 Differential manometer, 224  
 Dissociation, 14, 15, 208, 209  
     " pressure, 15  
 Distillation of coal, 144 & f.  
 Dowson gas, 176  
 Draught, artificial, 220  
     " chimney, 218  
     " measurement of, 221  
 Dust in gas, 206  
  
 ECONOMICAL combustion, 28, 228 & f.  
 Economiser, 245  
 Efficiency, 207  
     " of boilers, 240 & f.  
     " furnaces, 228 & f., 240 & f.  
     " producer, 174  
 Entropy, 246  
 Evaporation, equivalent, 237, 240  
 Evaporative power, 52  
 Excess of air, 26, 222  
 Explosion, 1, 201  
     " combustion by, 211  
     " pipette, 45  
     " pressure, 203  
     " temperature, 203 & f.  
     " wave, 214  
  
 FÉRY, absorption pyrometer, 102  
     " radiation pyrometer, 95  
 Firebox, locomotive, 217  
 Fletcher's anemometer, 226  
 Fuel, analysis of, 30 & f.  
     " artificial solid, 139  
     " choice of, 247  
     " classification of, 127, 130, 185  
     " gaseous, 159 & f.  
     " liquid, 252 & f.  
     " solid natural, 128  
     " testing plant, 157  
     " furnaces, 18, 19, 127 & f., 242  
 Furnace, control, APP. IV.  
     " efficiency, 228 & f., 240 & f.  
  
 GAS, analysis of, 36  
     " natural, 159  
     " producer, 160  
     " sampling, 37  
     " suction, 185  
     " thermometer, 83 & f.  
 Gaseous, fuel, 159 & f.  
 Gay-Lussac's law, 4  
 Glasgow (Humphrey and), 185  
 Gram, molecule, 2, 9  
  
 HAHN, 197 & f.  
 Heat balance, 29, 167 & f., 240 & f.  
     " losses, as carbon monoxide, 229  
     " " smoke, 230  
     " " by radiation, 231  
     " " in explosion motor, 216  
     " " products, 233  
     " of combustion, 52 & f., 78 & f.  
     " reaction, 50  
     " production and loss, 167  
 Holborn and Kurlbaum's pyrometer, 1  
 Hopper, 180  
 Huessener coke oven, 149 & f.  
 Humphrey and Glasgow, 182  
 Hydrocarbons, 43, 257  
 Hydrogen, estimation of, 33, 44  
 Hypsometer, Regnault, 112  
  
 ICE point, 111  
 Ignition pressures, 203  
     " temperatures, 201  
  
 JAHODE (Strache and), 173  
 Jüptner, 67, 155, 164, 172, 188  
  
 K, EQUILIBRIUM constant, 8, 161, 1  
     190 & f., 197, 199  
 Kirchoff's law, 125, 191  
  
 LE CHÂTELIER, 86  
 Le Chatelier and Mallard, 118  
 Le Chatelier's theorem, 8, 162  
 Lignites, 181  
 Liquid fuels, 252 & f.  
 Locomotive firebox, 217  
     " testing plant, 157  
 Losses, combustion, 228  
     " of heat, 228 & f.  
     " radiation, 231 & f.  
 Lange, 74, 233, APP. IV.

- MANOMETERS**, Seger's differential, 224  
 Mequl, 254, 255  
 Maximum combustion temperature, 114  
 Megacals, 248  
 Melting points, 110 & f.  
     "    " of metals, 114  
 Methane, estimation of, 4f.  
 Meyer, E., 210,  
 Mixtures, 176  
 Moisture, determination of, 30  
 Molecules, gram, 2, 9  
  
**NATURAL** draught, 218  
 Nernst, 206, 212  
 Nitrogen, estimation of, 33  
 Nobel's dish burner, 255  
  
**OIL** burner, 255  
     " creosote, 254  
     " fuel, 252 & ff.  
     " shale, 254  
 Orsat, 48  
 Ostwald, 13  
  
**PARR**, S. W., 70  
 Partial pressures, 10  
 Peat, 130  
 Petroleum, 253  
 Phosphorus, 41  
 Potassium, hydrate, 40  
 Pressures, explosion, 203 & f.  
 Princeps' alloys, 109  
 Producer gas, 160, 193 & f.  
     " theory of, 188 & f.  
     " Siemens', 179  
     " suction gas, 186  
     " water gas, 184  
     " Wilson, 181  
 Products of combustion, 20, 21, 24, 25,  
     242 & f.  
 Pyrogallic acid, 41  
 Pyrometers, 82  
     " absorption, 102  
     " calorimetric, 107  
     " optical, 9f.  
     " protection of, 114, 115  
     " recording, 89, 93  
  
 Pyrometers, resistance, 92  
  
**R**, Gas constant, 5  
 Reaction velocity, 10, 11, 12, 13  
 Reduction of iron oxide, 6  
 Refuse, destruction of, 248  
 Regnault hypsometer, 112  
 Regnault-Stohmann-Pfaundler for-  
     mula, 67  
 Reversible reactions, 6, 161  
  
**SEGER** cones, 109  
 Seger's manometer, 224  
 Siemens' producer, 179  
 Specific heats, 117, APP. III.  
     "    " change with temperature,  
         118  
 Stead's gas sampler, 39  
 Stefan-Boltzmann radiation law, 99, 232  
 Strache and Jahode, 173  
 Sulphur, boiling point, 113  
     " estimation of, 33  
     " in fuel, 136, 153, 248  
  
 Temperature, absolute, APP. II.  
     " combustion, 13, 118 & f.  
     " indicator, Whipple, 92  
 Thermo-chemical changes in coking, 155  
 Thermo-electric pyrometers, 86  
 Thread recorder, 89 & f.  
  
**VELOCITY**, reaction, 10, 11, 12, 13  
 Volatile matter, determination of, 31  
 Volume of air for combustion, 20, 243  
     "    " products, 21, 25, 243  
  
**WANNER** pyrometer, 108  
 Waste heat, utilisation of, 238  
 Water, boiling point of, 112  
     " gas, 169 & ff., 182 & f.  
     " producer, 184  
     " theory of, 197  
 Whipple, temperature indicator, 92  
 Wilson producer, 181  
 Wood, 137  
 Work, maximum, 208

